

i.52.9752

## ViewMate-i Dual Monitor Wing

The Dual Monitor Wing combines strength and practicality with great functionality at an excellent price/quality ratio. Installing monitors and adjusting the height of the wing is a piece of cake. Any cables can be routed through the cable management at the back. Having a durable construction, this monitor arm offers solid support for any monitor up to 15kg.

- Suitable for all frames in the ViewMate Combo product range
- Multi-pivot arm
- Mounts two monitors side by side
- Adjustable in height using the quick lock & release bracket
- Max. weight capacity of 15kg/monitor (up to 24"/24"W)
- Rotate 360°, tilt +90°/-90°, swivel +90°/-90°
- Compatible with VESA patterns 75x75/100x100mm MIS-D







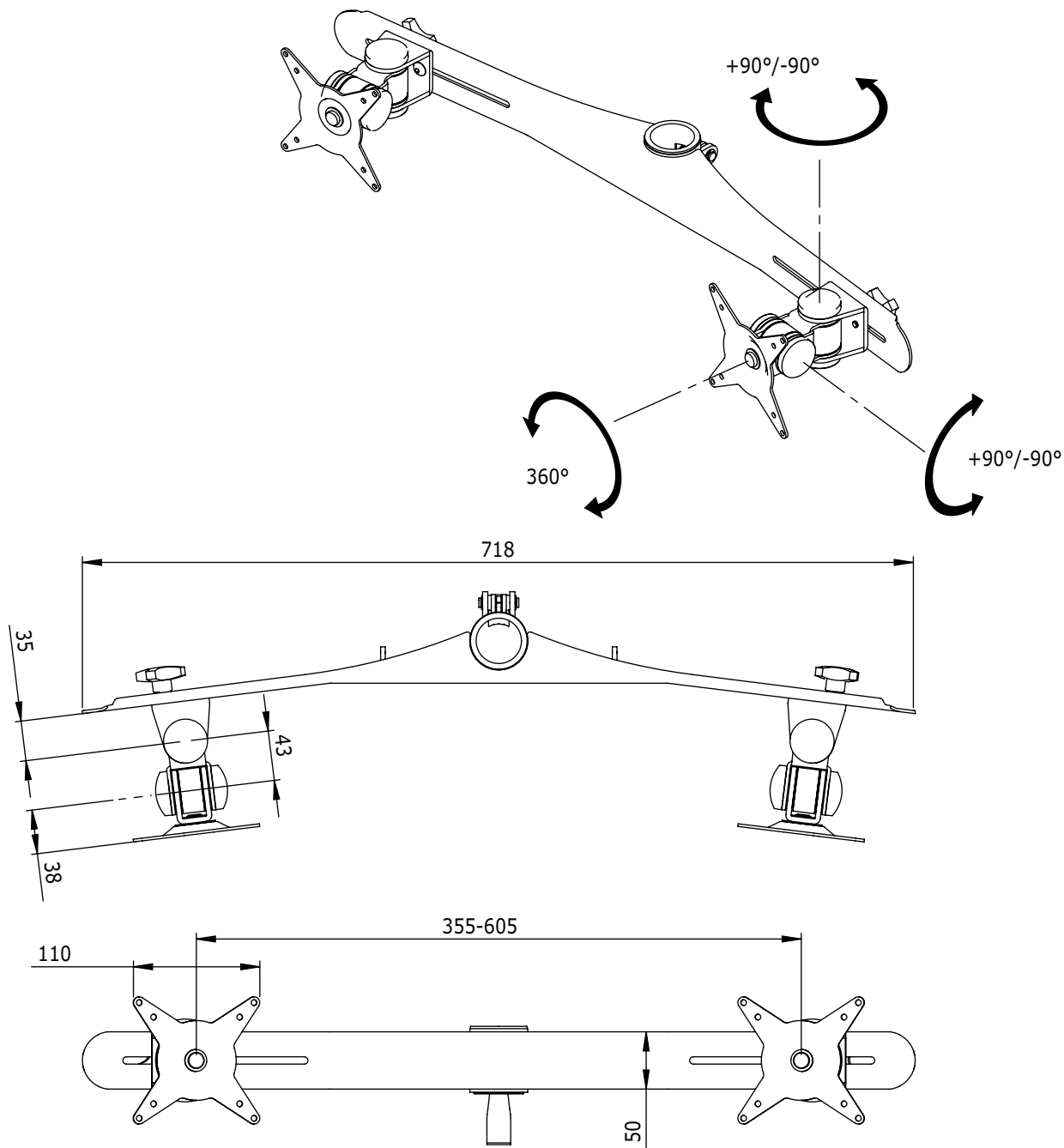







 viewmate





viewmate

	<b>DFX.#</b> i.52.9752		i.52.8002		590mm		(2x) 15kg		180°		180°		360°		75/100mm
	silver														
	520x250x90mm														
	3,92kg														
	805410996109														

Dealer

©2014 Dataflex International BV  
 Creation date: 01 July 2014  
 No rights can be derived from this publication.

