

KHX7200D2K2/512

**512MB (256MB 32M x 64-Bit x 2 pcs.)
PC2-7200 CL5 240-Pin DIMM Kit**

DESCRIPTION:

Kingston's KHX7200D2/512 is a kit of two 32M x 64-bit (256MB) DDR2-900 CL5 SDRAM (Synchronous DRAM) memory modules, based on eight 32M x 8-bit DDR2 FBGA components per module. Total kit capacity is 512MB. Each module pair has been tested to run at DDR2 900MHz at low latency timing of 5-5-5-15 at 2.00V. The SPD is programmed to JEDEC standard latency 667Mhz timing of 5-5-5-15 at 1.8V. Each 240-pin DIMM uses gold contact fingers and requires +1.8V. The electrical and mechanical specifications are as follows:

FEATURES:

- ✓ Power supply : Vdd: 1.8V ± 0.1V, Vddq: 1.8V ± 0.1V
- ✓ Double-data-rate architecture; two data transfers per clock cycle
- ✓ Bidirectional data strobe(DQS)
- ✓ Differential clock inputs(CK and CK)
- ✓ DLL aligns DQ and DQS transition with CK transition
- ✓ Programmable Read latency 5 (clock)
- ✓ Burst Length: 4, 8 (Interleave/nibble sequential)
- ✓ Programmable Burst type (sequential & interleave)
- ✓ Timing Reference: 5-5-5-15 at +1.8V / 5-5-5-15 at +2.00V
- ✓ Edge aligned data output, center aligned data input
- ✓ Auto & Self refresh, 7.8us refresh interval (8K/64ms refresh)
- ✓ Serial presence detect with EEPROM
- ✓ High Performance Heat Spreader
- ✓ PCB : Height 1.180" (30.00mm), single sided component

PERFORMANCE:

- | | |
|---|--------------------------------|
| ✓ Clock Cycle Time (tCK) CL=5 | 3ns (min.) / 8ns (max.) |
| ✓ Row Cycle Time (tRC) | 54ns (min.) |
| ✓ Refresh to Active/Refresh Command Time (tRFC) | 75ns |
| ✓ Row Active Time (tRAS) | 39ns (min.) / 70,000ns (max.) |
| ✓ Single Power Supply of | +1.8V (+/- .1V) |
| ✓ Power | 1.585 W (operating per module) |
| ✓ UL Rating | 94 V - 0 |
| ✓ Operating Temperature | 0° C to 55° C |
| ✓ Storage Temperature | -55° C to +125° C |

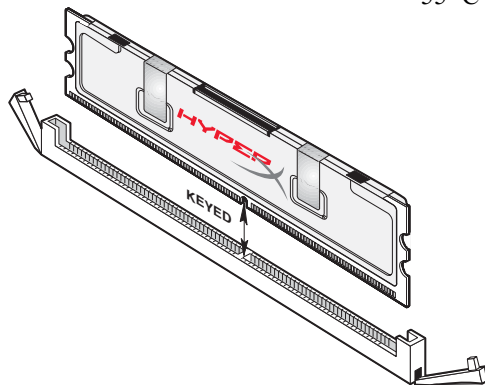

MODULE DIMENSIONS:

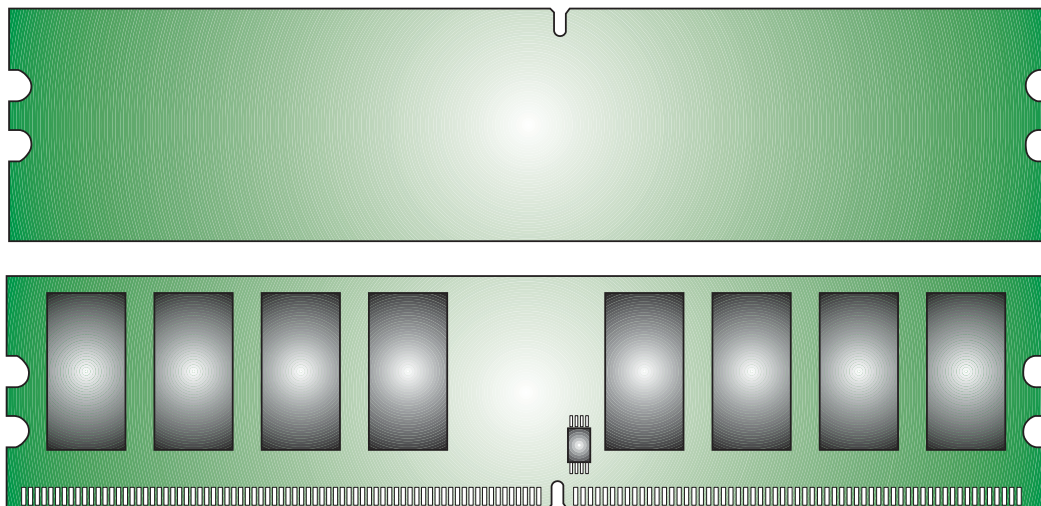

Units: millimeters

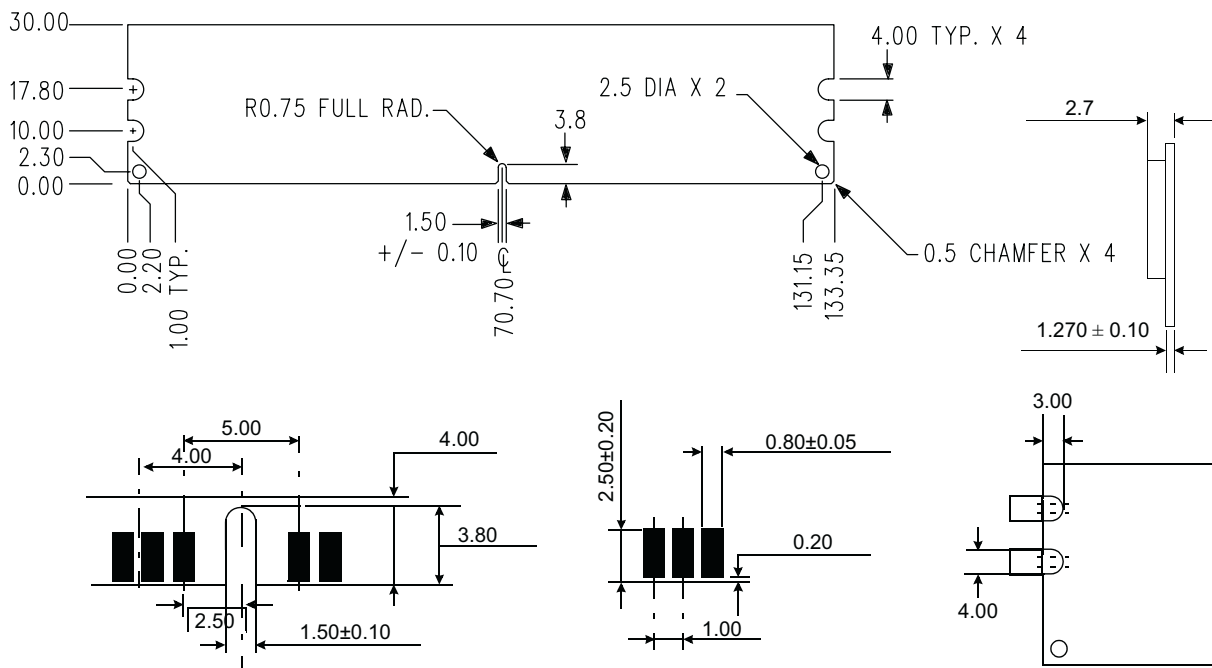

For more information, go to www.kingston.com

All Kingston products are tested to meet our published specifications. Some motherboards or system configurations may not operate at the published HyperX memory speeds and timing settings. Kingston does not recommend that any user attempt to run their computers faster than the published speed. Overclocking or modifying your system timing may result in damage to computer components.