

## KHX9600D2/512

512MB 64M x 64-Bit PC2-9600

CL5 240-Pin DIMM

### DESCRIPTION:

This document describes Kingston's 64M x 64-bit (512MB) DDR2-1200 CL5 SDRAM (Synchronous DRAM) memory module, based on eight 64M x 8-bit DDR2 FBGA components. This module has been tested to run at DDR2 1200MHz at a latency timing of 5-5-5-15 at 2.3 - 2.35V. The SPD is programmed to JEDEC standard latency 800Mhz timing of 5-5-5-15 at 1.8V. This 240-pin DIMM uses gold contact fingers and requires +1.8V. The electrical and mechanical specifications are as follows:

### FEATURES:

- ✓ Power supply : Vdd: 1.8V ± 0.1V, Vddq: 1.8V ± 0.1V
- ✓ Double-data-rate architecture; two data transfers per clock cycle
- ✓ Bidirectional data strobe(DQS)
- ✓ Differential clock inputs(CK and CK)
- ✓ DLL aligns DQ and DQS transition with CK transition
- ✓ Programmable Read latency 5 (clock)
- ✓ Burst Length: 4, 8 (Interleave/nibble sequential)
- ✓ Programmable Burst type (sequential & interleave)
- ✓ Timing Reference: 5-5-5-15 at 1.8V / 5-5-5-15 at 2.3 - 2.35V
- ✓ Edge aligned data output, center aligned data input
- ✓ Auto & Self refresh, 7.8us refresh interval (8K/64ms refresh)
- ✓ Serial presence detect with EEPROM
- ✓ High Performance Heat Spreader
- ✓ PCB : Height 1.180" (30.00mm), single sided component

### PERFORMANCE:

- |   |                               |
|---|-------------------------------|
| ✓ Clock Cycle Time (tCK) CL=5                   | 2.5ns (min.) / 8ns (max.)     |
| ✓ Row Cycle Time (tRC)                          | 51.5ns (min.)                 |
| ✓ Refresh to Active/Refresh Command Time (tRFC) | 105ns                         |
| ✓ Row Active Time (tRAS)                        | 39ns (min.) / 70,000ns (max.) |
| ✓ Single Power Supply of                        | +1.8V (+/- .1V)               |
| ✓ Power   | 1.350 W (operating)           |
| ✓ UL Rating                                     | 94 V - 0                      |
| ✓ Operating Temperature                         | 0° C to 55° C                 |
| ✓ Storage Temperature                           | -55° C to +125° C             |

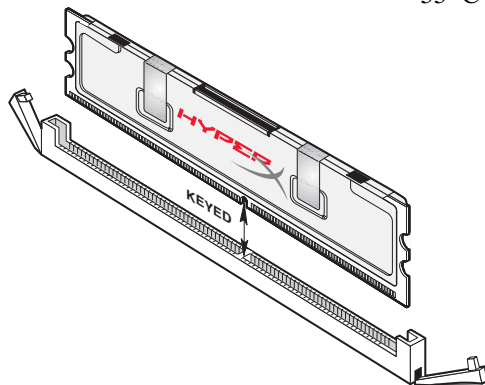

**MODULE DIMENSIONS:**

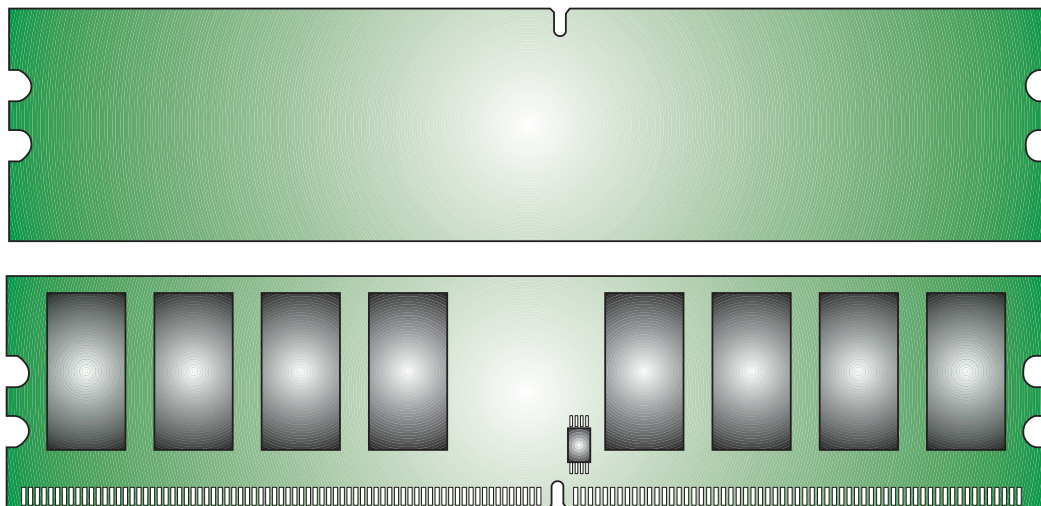

Units: millimeters

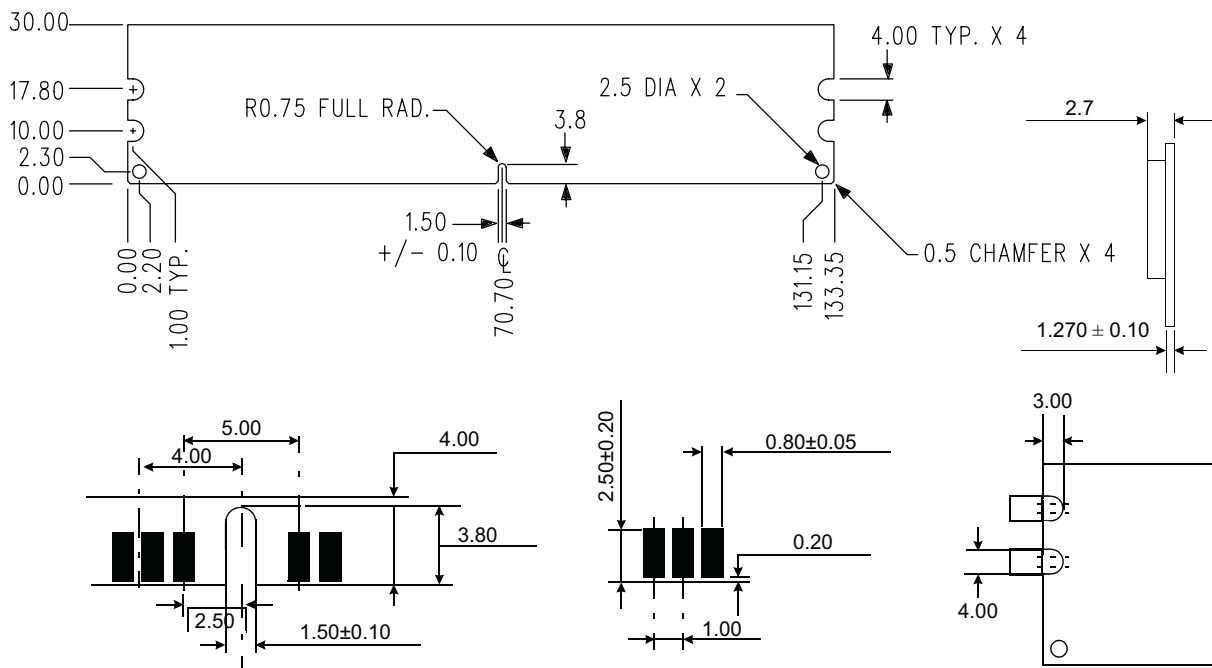

**For more information, go to [www.kingston.com](http://www.kingston.com)**

All Kingston products are tested to meet our published specifications. Some motherboards or system configurations may not operate at the published HyperX memory speeds and timing settings. Kingston does not recommend that any user attempt to run their computers faster than the published speed. Overclocking or modifying your system timing may result in damage to computer components.