

Technical Datasheet

FTLC1154SDPL-C

Finisar Coherent® Compatible 100GBase-LR4 QSFP28 Transceiver

Hot Pluggable, +3.3V, Duplex LC, 1310nm, 10km, Commercial Temperature

FEATURES

- 4 lanes MUX/DEMUX design
- Integrated LAN WDM TOSA / ROSA for 10km reach over SMF28
- Support 100GBASE-LR4 for line rate of 103.125Gbps and OTU4 for line rate of 111.81Gbps
- Aggregate bandwidth of > 100Gbps
- Duplex LC connector
- Compliant with IEEE 802.3-2012 Clause 88 standard IEEE 802.3bm CAUI-4 chip to module electrical standard ITU-T G.959.1-2012-02 standard
- Single +3.3V power supply operating
- Built-in digital diagnostic functions
- Commercial Operating Temperature Range: 0 to 70°C
- RoHS Compliant Part

APPLICATIONS

- Local Area Network (LAN)
- Wide Area Network (WAN)
- Ethernet switches and router applications

DESCRIPTION

ATGBICS® FTLC1154SDPL-C Transceiver is designed for 10km optical communication applications. The design is compliant to 100GbASE-LR4 of the IEEE 802.3-2012 Clause 88 standard IEEE 802.3bm CAUI-4 chip to module electrical standard ITU-T G.959.1-2012-02 standard. The module converts 4 inputs channels (ch) of 25.78 Gbps to 27.95Gbps electrical data to 4 lanes optical signals and multiplexes them into a single channel for 100Gb/s optical transmission. Reversely, on the receiver side, the module optically de-multiplexes a 100Gb/s input into 4 lanes signals and converts them to 4 lanes output electrical data.

The central wavelengths of the 4 lanes are 1296 nm, 1300 nm, 1305 nm and 1309 nm. It contains a duplex LC connector for the optical interface and a 38-pin connector for the electrical interface. To minimize the optical dispersion in the long-haul system, single-mode fiber (SMF) must be applied in this module.

The product is designed with form factor, optical/electrical connection and digital diagnostic interface according to the QSFP28 Multi-Source Agreement (MSA). It has been designed to meet the harshest external operating conditions including temperature, humidity and EMI interference.

Technical Datasheet

The module operates from a single +3.3V power supply and LVCMOS/LVTTL global control signals such as Module Present, Reset, Interrupt and Low Power Mode are available with the modules. A 2-wire serial interface is available to send and receive more complex control signals and to obtain digital diagnostic information. Individual channels can be addressed and unused channels can be shut down for maximum design flexibility.

The FTLC1154SDPL-C is designed with form factor, optical/electrical connection and digital diagnostic interface according to the QSFP28 Multi-Source Agreement (MSA). It has been designed to meet the harshest external operating conditions including temperature, humidity and EMI interference. The module offers very high functionality and feature integration, accessible via a two-wire serial interface.

ABSOLUTE MAXIMUM RATINGS

The operation of more than any absolute maximum ratings might cause permanent damage to this module.

Parameter	Symbol	Min	Max	Unit	Note
Storage Temperature	T _o	-40	85	°C	
Relative Humidity(non-condensing)	RH	0	85	%	
Operating Case Temperature	T _o	0	70	°C	
Supply Voltage	V _{cc}	-0.3	3.6	V	
Input Voltage	V _{in}	-0.3	V _{cc} +0.3	V	

RECOMMENDED OPERATING CONDITIONS AND SUPPLY REQUIREMENTS

Parameter	Symbol	Min	Typical	Max	Unit
Operating Case Temperature	T _o	0		70	°C
Power Supply Voltage	V _{cc}	3.13	3.3	3.47	V
Power Dissipation	PD			35	W
Supply Current	ICC		1100	1500	mA

Technical Datasheet

Electrical Characteristics (TOP = 0 to 70 °C, VCC = 3.13 to 3.47 Volts)

Parameter	Symbol	Min	Typ	Max	Unit	Note
Data Rate per Channel		-	25.78125		Gbps	
			27.9525			
Power Consumption		-	3.6	5	W	
Supply Current	Icc		1.1	1.5	A	
Control I/O Voltage-High	VIH	2.0		Vcc	V	
Control I/O Voltage-Low	VIL	0		0.7	V	
Inter-Channel Skew	TSK			35	Ps	
RESETL Duration			10		Us	
RESETL De-assert time				100	ms	
Power On Time				100	ms	
Transmitter						
Single Ended Output Voltage Tolerance		0.3		Vcc	V	1
Common mode Voltage Tolerance		15			mV	
Transmit Input Diff Voltage	VI	150		1200	mV	
Transmit Input Diff Impedance	ZIN	85	100	115		
Data Dependent Input Jitter	DDJ		0.3		UI	
Receiver						
Single Ended Output Voltage Tolerance		0.3		4	V	
Rx Output Diff Voltage	Vo	370	600	950	mV	
Rx Output Rise and Fall Voltage	Tr/Tf			35	ps	1
Total Jitter	TJ		0.3		UI	

Note: 20 ~ 80%

Technical Datasheet

Optical Parameters (TOP = 0 to 70 °C, VCC = 3.0 to 3.6 Volts)

Parameter	Symbol	Min	Typ	Max	Unit	Ref.
Transmitter						
Wavelength Assignment	L0	1294.53	1295.56	1296.59	nm	
	L1	1299.02	1300.05	1301.09	nm	
	L2	1303.54	1304.58	1305.63	nm	
	L3	1308.09	1309.14	1310.19	nm	
Side-mode Suppression Ratio	SMSR	30	-	-	dB	
Total Average Launch Power	PT	-4	-	8.3	dBm	
Average Launch Power, each Lane		-4	-	4.5	dBm	
Difference in Launch Power between any two Lanes (OMA)		-	-	6.5	dB	
Optical Modulation Amplitude, each Lane	OMA	-4		4.5	dBm	
Launch Power in OMA minus Transmitter and Dispersion Penalty (TDP), each Lane		-4.8	-		dBm	
TDP, each Lane	TDP			2.2	dB	
Extinction Ratio	ER	4	-	-	dB	
Transmitter Eye Mask Definition {X1, X2, X3, Y1, Y2, Y3}		{0.25, 0.4, 0.45, 0.25, 0.28, 0.4}				
Optical Return Loss Tolerance		-	-	20	dB	
Average Launch Power OFF Transmitter, each Lane	Poff			-30	dBm	
Relative Intensity Noise	Rin			-128	dB/HZ	1
Optical Return Loss Tolerance		-	-	12	dB	
Receiver						
Damage Threshold	THd	3.3			dBm	1
Average Power at Receiver Input, each Lane	R	-10.6		0	dBm	
RSSI Accuracy		-2		2	dB	
Receiver Reflectance	Rrx			-26	dB	
Receiver Power (OMA), each Lane		-	-	3.5	dBm	
LOS De-Assert	LOSD			-15	dBm	
LOS Assert	LOSA	-25			dBm	
LOS Hysteresis	LOSH	0.5			dB	

Note: 12dB Reflection

Technical Datasheet

Diagnostic Monitoring Interface

Digital diagnostics monitoring function is available on all QSFP28 LR4. A 2-wire serial interface provides user to contact with module. The structure of the memory is shown in flowing. The memory space is arranged into a lower, single page, address space of 128 bytes and multiple upper address space pages. This structure permits timely access to addresses on the lower page, such as Interrupt Flags and Monitors. Less time critical time entries, such as serial ID information and threshold settings, are available with the Page Select function. The interface address used is A0xh and is mainly used for time critical data like interrupt handling to enable a one-time-read for all data related to an interrupt situation. After an interruption, IntL has been asserted, the host can read out the flag field to determine the affected channel and type of flag.

Byte Address	Description	Type
0	Identifier (1 Byte)	Read Only
1-2	Status (2 Bytes)	Read Only
3-21	Interrupt Flags (31 Bytes)	Read Only
22-33	Module Monitors (12 Bytes)	Read Only
34-81	Channel Monitors (48 Bytes)	Read Only
82-85	Reserved (4 Bytes)	Read Only
86-97	Control (12 Bytes)	Read/Write
98-99	Reserved (2 Bytes)	Read/Write
100-106	Module and Channel Masks (7 Bytes)	Read/Write
107-118	Reserved (12 Bytes)	Read/Write
119-122	Reserved (4 Bytes)	Read/Write
123-126	Reserved (4 Bytes)	Read/Write
127	Page Select Byte	Read/Write

Byte Address	Description	Type
128-175	Module Thresholds (48 Bytes)	Read Only
176-223	Reserved (48 Bytes)	Read Only
224-225	Reserved (2 Bytes)	Read Only
226-239	Reserved (14 Bytes)	Read/Write
240-241	Channel Controls (2 Bytes)	Read/Write
242-253	Reserved (12 Bytes)	Read/Write
254-255	Reserved (2 Bytes)	Read/Write

Technical Datasheet

2-wire serial address, 1010000x (A0h)*

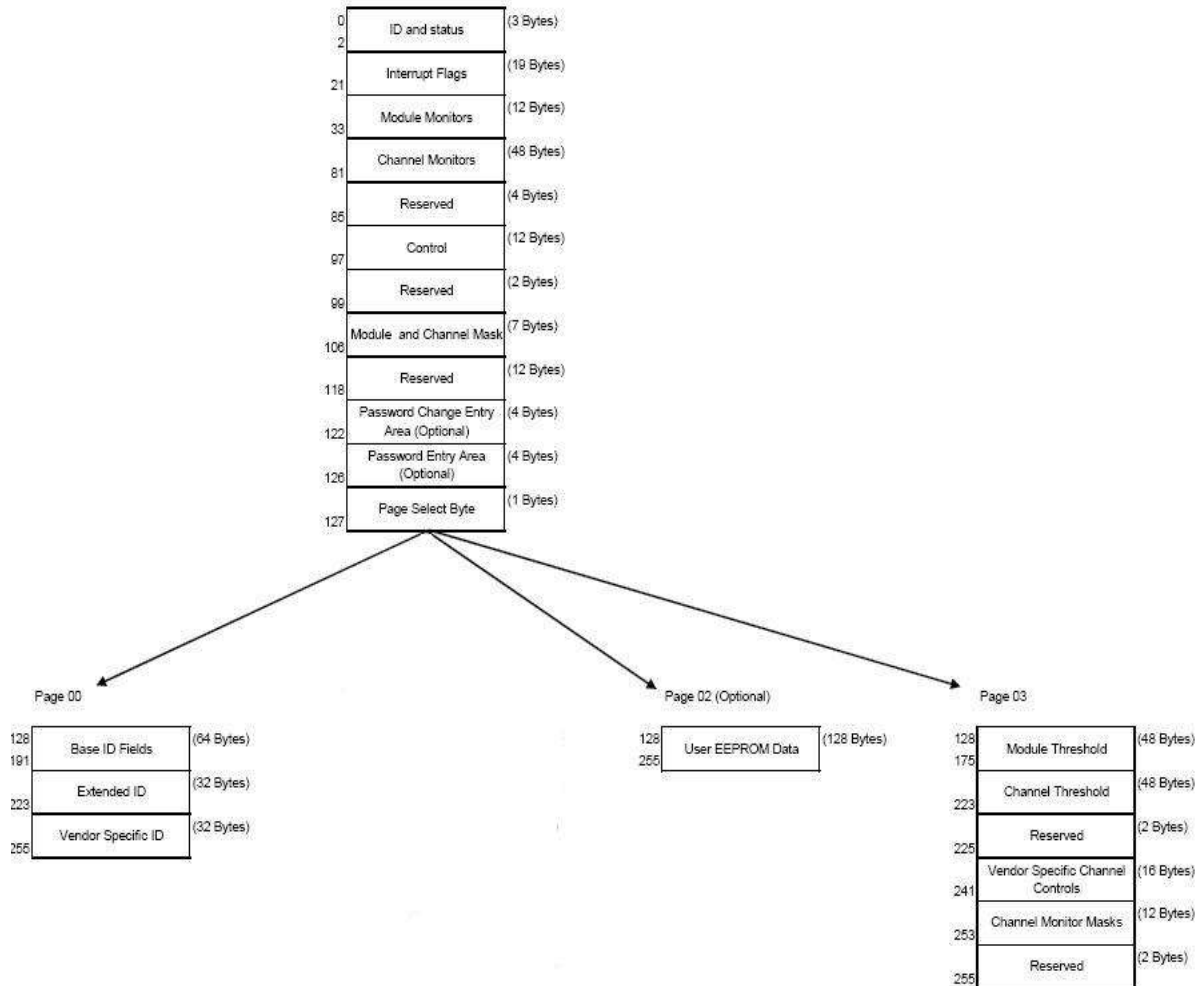

Technical Datasheet

Address	Name	Description
128	Identifier (1 Byte)	Identifier Type of serial transceiver
129	Ext. Identifier (1 Byte)	Extended identifier of serial transceiver
130	Connector (1 Byte)	Code for connector type
131-138	Transceiver (8 Bytes)	Code for electronic compatibility or optical compatibility
139	Encoding (1 Byte)	Code for serial encoding algorithm
140	BR, nominal (1 Byte)	Nominal bit rate, units of 100 Mbits/s
141	Extended RateSelect Compliance (1 Byte)	Tags for Extended RateSelect compliance
142	Length SMF (1 Byte)	Link length supported for SM fiber in km
143	Length E-50 μm (1 Byte)	Link length supported for EBW 50/125 μm fiber, units of 2 m
144	Length 50 μm (1 Byte)	Link length supported for 50/125 μm fiber, units of 1 m
145	Length 62.5 μm (1 Byte)	Link length supported for 62.5/125μm fiber, units of 1 m
146	Length copper (1 Byte)	Link length supported for copper, units of 1 m
147	Device Tech (1 Byte)	Device technology
148-163	Vendor name (16 Bytes)	QSFP vendor name (ASCII)
164	Extended Transceiver (1 Byte)	Extended Transceiver Codes for InfiniBand [†]
165-167	Vendor OUI (3 Bytes)	QSFP vendor IEEE vendor company ID
168-183	Vendor PN (16 Bytes)	Part number provided by QSFP vendor (ASCII)
184-185	Vendor rev (2 Bytes)	Revision level for part number provided by vendor (ASCII)
186-187	Wavelength (2 Bytes)	Nominal laser wavelength (Wavelength = value / 20 in nm)
188-189	Wavelength Tolerance (2 Bytes)	Guaranteed range of laser wavelength (+/- value) from Nominal wavelength (Wavelength Tol. = value / 200 in nm)
190	Max Case Temp (1 Byte)	Maximum Case Temperature in Degrees C
191	CC_BASE (1 Byte)	Check code for Base ID fields (addresses 128-190)
192-195	Options (4 Bytes)	Rate Select, TX Disable, TX Fault, LOS
196-211	Vendor SN (16 Bytes)	Serial number provided by vendor (ASCII)
212-219	Date code (8 Bytes)	Vendor's manufacturing date code
220	Diagnostic Monitoring Type (1 Byte)	Indicates which type of diagnostic monitoring is implemented
221	Enhanced Options (1 Byte)	Indicates which optional enhanced features are implemented
222	Reserved (1 Byte)	Reserved
223	CC_EXT	Check code for the Extended ID Fields (addresses 192-222)
224-255	Vendor Specific (32 Bytes)	Vendor Specific EEPROM

Page02 is User EEPROM and its format is decided by user.

The detail description of low memory and page00.page03 upper memory please see SFF-8436 document.

Technical Datasheet

Timing for Soft Control and Status Functions

Parameter	Symbol	Max	Unit	Conditions
Initialization Time	t_init	2000	ms	Time from power on ¹ , hot plug or rising edge of Reset until the module is fully functional ²
Reset Init Assert Time	t_reset_init	2	µs	A Reset is generated by a low level longer than the minimum reset pulse time present on the ResetL pin.
Serial Bus Hardware Ready Time	t_serial	2000	ms	Time from power on ¹ until module responds to data transmission over the 2-wire serial bus
Monitor Data Ready Time	t_data	2000	ms	Time from power on ¹ to data not ready, bit 0 of Byte 2, deasserted and IntL asserted
Reset Assert Time	t_reset	2000	ms	Time from rising edge on the ResetL pin until the module is fully functional ²
LPMODE Assert Time	ton_LPMODE	100	µs	Time from assertion of LPMODE (Vin:LPMODE =Vih) until module power consumption enters lower Power Level
IntL Assert Time	ton_IntL	200	ms	Time from occurrence of condition triggering IntL until Vout:IntL = Vol
IntL Deassert Time	toff_IntL	500	µs	toff_IntL 500 µs Time from clear on read ³ operation of associated flag until Vout:IntL = Voh. This includes deassert times for Rx LOS, Tx Fault and other flag bits.
Rx LOS Assert Time	ton_los	100	ms	Time from Rx LOS state to Rx LOS bit set and IntL asserted
Flag Assert Time	ton_flag	200	ms	Time from occurrence of condition triggering flag to associated flag bit set and IntL asserted
Mask Assert Time	ton_mask	100	ms	Time from mask bit set ⁴ until associated IntL assertion is inhibited
Mask De-assert Time	toff_mask	100	ms	Time from mask bit cleared ⁴ until associated IntL operation resumes
ModSelL Assert Time	ton_ModSelL	100	µs	Time from assertion of ModSelL until module responds to data transmission over the 2-wire serial bus
ModSelL Deassert Time	toff_ModSelL	100	µs	Time from deassertion of ModSelL until the module does not respond to data transmission over the 2-wire serial bus
Power_over-ride or Power-set Assert Time	ton_Pdown	100	ms	Time from P_Down bit set ⁴ until module power consumption enters lower Power Level
Power_over-ride or Power-set De-assert Time	toff_Pdown	300	ms	Time from P_Down bit cleared ⁴ until the module is fully functional ³

Technical Datasheet

Note:

1. Power on is defined as the instant when supply voltages reach and remain at or above the minimum specified value.
2. Fully functional is defined as IntL asserted due to data not ready bit, bit 0 byte 2 de-asserted.
3. Measured from falling clock edge after stop bit of read transaction.
4. Measured from falling clock edge after stop bit of write transaction.

Transceiver Block Diagram

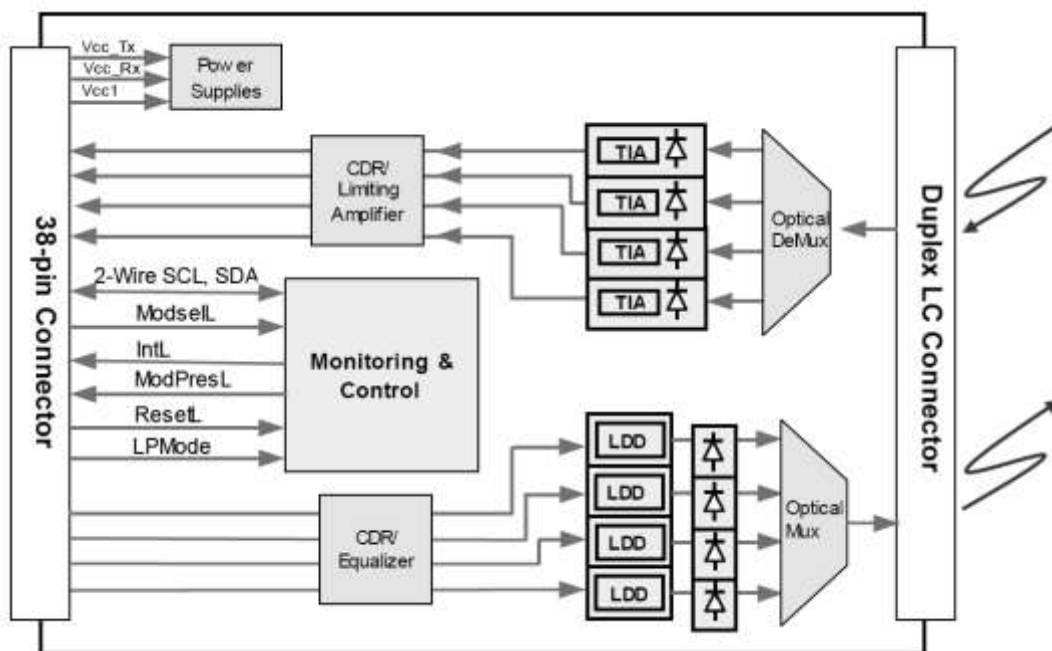

Technical Datasheet

Pin Assignment

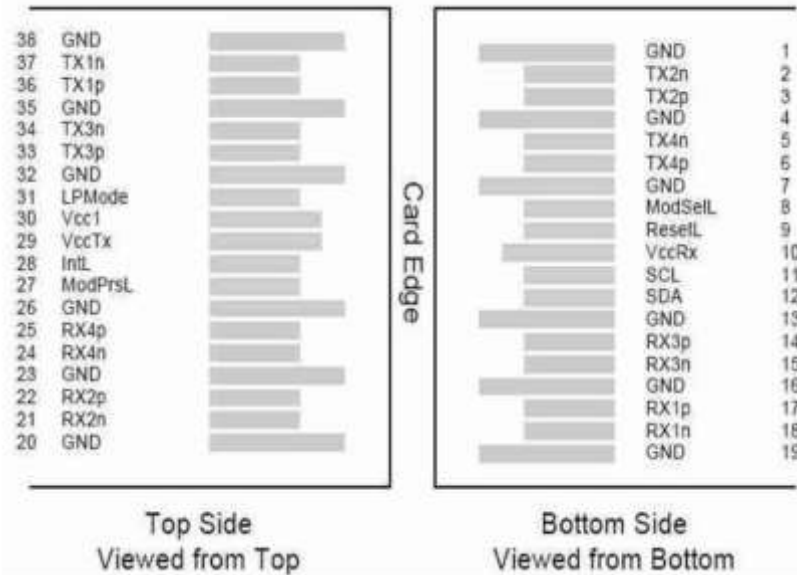

Diagram of Host Board Connector Block Pin Numbers and Name

Pin Description

Pin	Logic	Symbol	Name/Description	Ref.
1		GND	Ground	1
2	CML-I	Tx2n	Transmitter Inverted Data Input	
3	CML-I	Tx2p	Transmitter Non-Inverted Data output	
4		GND	Ground	1
5	CML-I	Tx4n	Transmitter Inverted Data Output	
6	CML-I	Tx4p	Transmitter Non-Inverted Data Output	
7		GND	Ground	1
8	LVTTL-I	ModSelL	Module Select	
9	LVTTL-I	ResetL	Module Reset	
10		VccRx	+3.3V Power Supply Receiver	2
11	LVC MOS-I/O	SCL	2-Wire Serial Interface Clock	
12	LVC MOS-I/O	SDA	2-Wire Serial Interface Data	
13		GND	Ground	1
14	CML-O	Rx3p	Receiver Inverted Data Output	
15	CML-O	Rx3n	Receiver Non-Inverted Data Output	
16		GND	Ground	1

Technical Datasheet

17	CML-O	Rx1p	Receiver Inverted Data Output	
18	CML-O	Rx1n	Receiver Non-Inverted Data Output	
19		GND	Ground	1
20		GND	Ground	1
21	CML-O	Rx2n	Receiver Inverted Data Output	
22	CML-O	Rx2p	Receiver Non-Inverted Data Output	
23		GND	Ground	1
24	CML-O	Rx4n	Receiver Inverted Data Output	
25	CML-O	Rx4p	Receiver Non-Inverted Data Output	
26		GND	Ground	1
27	LVTTL-O	ModPrsL	Module Present	
28	LVTTL-O	IntL	Interrupt	
29		VccTx	+3.3V Power Supply Transmitter	2
30		Vcc1	+3.3V Power Supply	2
31	LVTTL-I	LPMode	Low Power Mode	
32		GND	Ground	1
33	CML-I	Tx3p	Transmitter Inverted Data Output	
34	CML-I	Tx3n	Transmitter Non-Inverted Data Output	
35		GND	Ground	1
36	CML-I	Tx1p	Transmitter Inverted Data Output	
37	CML-I	Tx1n	Transmitter Non-Inverted Data Output	
38		GND	Ground	1

Notes:

GND is the symbol for single and supply(power) common for QSFP28 modules, all are common within the QSFP28 module, and all module voltages are referenced to this potential otherwise noted. Connect these directly to the host board signal common ground plane. Laser output disabled on TDIS >2.0V or open, enabled on TDIS <0.8V.

VccRx, Vcc1 and VccTx are the receiver and transmitter power suppliers and shall be applied concurrently. Recommended host board power supply filtering is shown below. VccRx, Vcc1 and VccTx may be internally connected within the QSFP28 transceiver module in any combination. The connector pins are each rated for maximum current of 500mA.

Technical Datasheet

Recommended Circuit

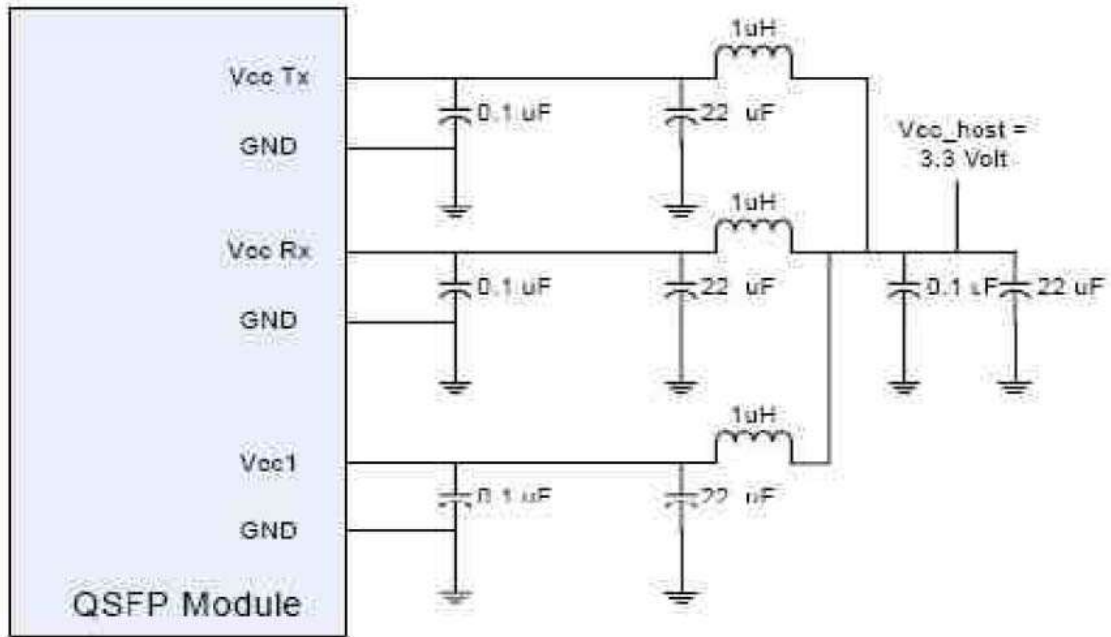

Mechanical Dimensions (Units: mm)

