

Technical Datasheet

FTLC9554REPM-C

Finisar® Compatible 100GBase-SR4 QSFP28 Transceiver

Hot Pluggable, +3.3V, MPO, DOM, 850nm, 70m, Commercial Temperature

FEATURES

- Four-channel full-duplex transceiver modules
- Transmission data rate up to 26Gbit/s per channel
- Up to 70m on OM3 Multimode Fibre (MMF) and 70m on OM4 MMF
- Low power consumption <3.5W
- Commercial Operating Temperature Range: 0 to 70°C
- 3.3V power supply voltage
- RoHS 6 compliant
- Hot Pluggable QSFP form factor
- MPO connector receptacle
- Built-in digital diagnostic function

APPLICATIONS

- IEEE 802.3bm 100GBASE-SR4 and 40GBASE-SR4
- Proprietary High-Speed Interconnections
- Data centre

DESCRIPTION

ATGBICS® FTLC9554REPM-C Transceiver is a Four-Channel, Pluggable, Parallel, Fibre-Optic QSFP28 Transceiver for IEEE 802.3bm, 100GBASE-SR4 Applications, or 40 Gigabit Ethernet and InfiniBand FDR/EDR Applications. The QSFP28 full-duplex optical module offers 4 independent transmit and receive channels, each capable of 26Gbps operation for an aggregate data rate of 104Gbps 70m using OM3 Fibre. These modules are designed to operate over multimode Fibre systems using 850nm VCSEL laser array. An optical Fibre ribbon cable with an MPO/MTPTM connector can be plugged into the QSFP module receptacle. QSFP28 SR4 is one kind of parallel transceiver which provides increased port density and total system cost savings.

Technical Datasheet

ABSOLUTE MAXIMUM RATINGS

The operation in excess of any absolute maximum ratings might cause permanent damage to this module.

Parameter	Symbol	Min	Max	Unit	Note
Storage Temperature	T _o	-40	85	°C	
Relative Humidity(non-condensing)	RH	0	85	%	
Operating Case Temperature	T _o	0	70	degC	
Supply Voltage	V _{cc}	-0.3	3.6	V	
Input Voltage	V _{in}	-0.3	V _{cc} +0.3	V	

RECOMMENDED OPERATING CONDITIONS AND SUPPLY REQUIREMENTS

Parameter	Symbol	Min	Typical	Max	Unit
Operating Case Temperature	T _o	0		70	°C
Power Supply Voltage	V _{cc}	3.13	3.3	3.47	V
Power Consumption		-		3.5	W
Data Rate	DR		25.78125		Gbps
Data Speed Tolerance	ΔDR	-100		+100	ppm
Link Distance with OM3 Fibre	D	0		70	m

Technical Datasheet

OPTICAL CHARACTERISTICS

All parameters are specified under the recommended operating conditions with PRBS31 data pattern unless otherwise specified.

Parameter	Symbol	Min	Typical	Max	Unit	Notes
Transmitter						
Center Wavelength	λ_C	840	850	860	nm	1
RMS Spectral Width	λ_{rms}	-		0.65	nm	1
Average Launch Power, each lane	PAVG	-7	-2.5	0	dBm	
Optical Modulation Amplitude (OMA)	POMA	-5	-2.5	0	dBm	1
Difference in Launch Power between any two lanes	Ptx,diff			4.0	dB	
Launch Power in OMA minus Transmitter and Dispersion Penalty (TDP), each Lane	OMA-TDP			3.5	dB	1
Extinction Ratio	ER	3.5			dB	
Transmitter Eye Mask Margin	EMM	10			%	2
Average Launch Power OFF Transmitter, each Lane	Poff			-30	dBm	
Transmitter Eye Mask Definition {X1, X2, X3, Y1, Y2, Y3}	{0.3, 0.38, 0.45, 0.35, 0.41, 0.5}					

Technical Datasheet

Parameter	Symbol	Min	Typical	Max	Unit	Notes
Receiver						
Center Wavelength	λ_C	840	850	860	nm	
Damage Threshold	THd	+3			dBm	
Overload, each lane	OVL	+2.4			dBm	
Receiver Sensitivity in OMA, each Lane	SEN			-10.3	dBm	
Signal Loss Assert Threshold	LOSA	-30			dBm	
Signal Loss Deassert Threshold	LOSD			-9	dBm	
LOS Hysteresis	LOSH	0.5		6	dB	
Optical Return Loss	ORL			-12	dBm	

Notes:

1. Transmitter wavelength, RMS spectral width and power need to meet the OMA minus TDP specs to guarantee link performance.
2. The eye diagram is tested with 1000 waveform.

ELECTRICAL SPECIFICATIONS

Parameter	Symbol	Min	Typical	Max	Unit
Differential input impedance	Zin	90	100	110	ohm
Differential Output impedance	Zout	90	100	110	ohm
Differential input voltage amplitude	ΔV_{in}	300		1100	mVp-p
Differential output voltage amplitude	ΔV_{out}	500		800	mVp-p
Bit Error Rate	BR				E-12
Input Logic Level High	V _{IH}	2.0		V _{CC}	V
Input Logic Level Low	V _{IL}	0		0.8	V
Output Logic Level High	V _{OH}	V _{CC} -0.5		V _{CC}	V
Output Logic Level Low	V _{OL}	0		0.4	V

Technical Datasheet

PIN ASSIGNMENT

PIN	Logic	Symbol	Name/Description	Note
1		GND	Ground	1
2	CML-I	Tx2n	Transmitter Inverted Data Input	
3	CML-I	Tx2p	Transmitter Non-Inverted Data output	
4		GND	Ground	1
5	CML-I	Tx4n	Transmitter Inverted Data Input	
6	CML-I	Tx4p	Transmitter Non-Inverted Data output	
7		GND	Ground	1
8	LVTLL-I	ModSelL	Module Select	
9	LVTLL-I	ResetL	Module Reset	
10		VccRx	+ 3.3V Power Supply Receiver	2
11	LVC MOS-I/O	SCL	2-Wire Serial Interface Clock	
12	LVC MOS-I/O	SDA	2-Wire Serial Interface Data	
13		GND	Ground	
14	CML-O	Rx3p	Receiver Non-Inverted Data Output	
15	CML-O	Rx3n	Receiver Inverted Data Output	
16		GND	Ground	1
17	CML-O	Rx1p	Receiver Non-Inverted Data Output	
18	CML-O	Rx1n	Receiver Inverted Data Output	
19		GND	Ground	1
20		GND	Ground	1
21	CML-O	Rx2n	Receiver Inverted Data Output	
22	CML-O	Rx2p	Receiver Non-Inverted Data Output	
23		GND	Ground	1
24	CML-O	Rx4n	Receiver Inverted Data Output	1
25	CML-O	Rx4p	Receiver Non-Inverted Data Output	
26		GND	Ground	1
27	LVTTL-O	ModPrsL	Module Present	

Technical Datasheet

PIN	Logic	Symbol	Name/Description	Note
28	LVTTL-O	IntL	Interrupt	
29		VccTx	+3.3 V Power Supply transmitter	2
30		Vcc1	+3.3 V Power Supply	2
31	LVTTL-I	LPMoDe	Low Power Mode	
32		GND	Ground	1
33	CML-I	Tx3p	Transmitter Non-Inverted Data Input	
34	CML-I	Tx3n	Transmitter Inverted Data Output	
35		GND	Ground	1
36	CML-I	Tx1p	Transmitter Non-Inverted Data Input	
37	CML-I	Tx1n	Transmitter Inverted Data Output	
38		GND	Ground	1

Notes:

1. Module circuit ground is isolated from module chassis ground within the module. GND is the symbol for signal and supply (power) common for QSFP modules.
2. The connector pins are each rated for a maximum current of 500mA.



Technical Datasheet

MODSELL PIN

The ModSelL is an input pin. When held low by the host, the module responds to 2-wire serial communication commands. The ModSelL allows the use of multiple QSFP modules on a single 2-wire interface bus. When the ModSelL is “High”, the module will not respond to any 2-wire interface communication from the host. ModSelL has an internal pull-up in the module.

RESETL PIN

Reset. LPMode_Reset has an internal pull-up in the module. A low level on the ResetL pin for longer than the minimum pulse length ($t_{\text{Reset_init}}$) initiates a complete module reset, returning all user module settings to their default state. Module Reset Assert Time (t_{init}) starts on the rising edge after the low level on the ResetL pin is released. During the execution of a reset (t_{init}) the host shall disregard all status bits until the module indicates a completion of the reset interrupt. The module indicates this by posting an IntL signal with the Data_Not_Ready bit negated. Note that on power up (including hot insertion) the module will post this completion of reset interrupt without requiring a reset.

LP MODE PIN

ATGBICS QSFP28 SR4 operate in the low power mode (less than 1.5 W power consumption) This pin active high will decrease power consumption to less than 1W.

MODPRSL PIN

ModPrsL is pulled up to Vcc on the host board and grounded in the module. The ModPrsL is asserted “Low” when the module is inserted and deasserted “High” when the module is physically absent from the host connector.

INTL PIN

IntL is an output pin. When “Low”, it indicates a possible module operational fault or a status critical to the host system. The host identifies the source of the interrupt by using the 2-wire serial interface. The IntL pin is an open collector output and must be pulled up to Vcc on the host board.

Technical Datasheet

POWER SUPPLY FILTERING

The host board should use the power supply filtering shown in Figure 1.

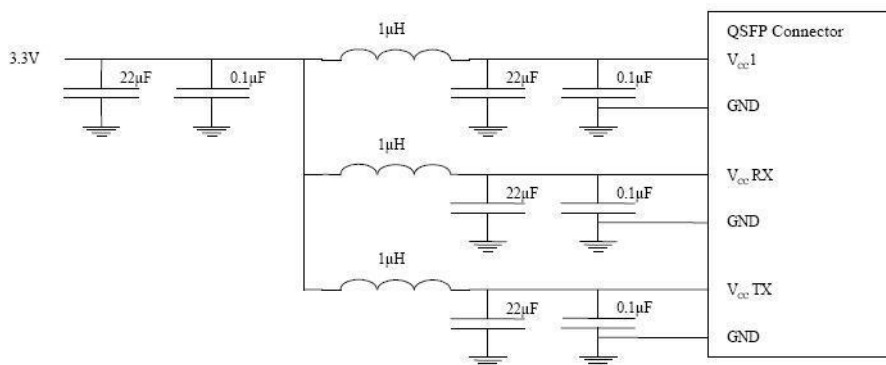
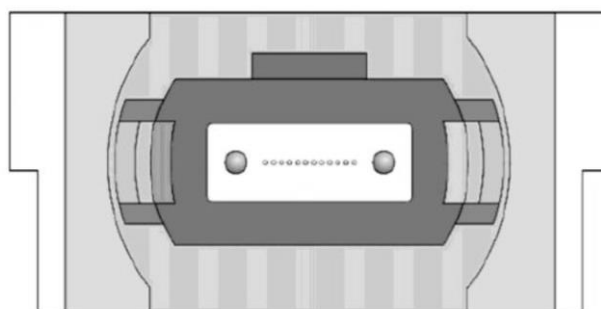

Figure1. Host Board Power Supply Filtering

OPTICAL INTERFACE LANES AND ASSIGNMENT

The optical interface port is a male MPO connector. The four Fibre positions on the left as shown in Figure 2, with the key up, are used for the optical transmit signals (Channel 1 through4). The Fibre positions on the right are used for the optical receive signals (Channel 4 through 1). The central four Fibres are physically present.



Transmit Channels: 1 2 3 4
 Unused positions: x x x x
 Receive Channels: 4 3 2 1

Figure 2. Optical Receptacle and Channel Orientation

Technical Datasheet

DIAGNOSTIC MONITORING INTERFACE

Digital diagnostics monitoring function is available on all ATGBICS QSFP28 SR4. A 2-wire serial interface provides user to contact with module. The structure of the memory is shown in Figure 3. The memory space is arranged into a lower, single page, address space of 128 bytes and multiple upper address space pages. This structure permits timely access to addresses in the lower page, such as Interrupt Flags and Monitors. Less time critical time entries, such as serial ID information and threshold settings, are available with the Page Select function. The interface address used is A0xh and is mainly used for time critical data like interrupt handling in order to enable a one-time-read for all data related to an interrupt situation. After an interrupt, IntL, has been asserted, the host can read out the flag field to determine the affected channel and type of flag.

Parameter	Symbol	Min.	Max	Unit	Notes
Temperature monitor absolute error	DMI_Temp	-3	+3	degC	Over operating temp
Supply voltage monitor absolute error	DMI_VCC	-0.1	0.1	V	Full operating range
Channel RX power monitor absolute error	DMI_RX	-3	3	dB	Per channel
Channel Bias current monitor	DMI_Ibias	-10%	10%	mA	Per channel

Figure 3

EEPROM SERIAL ID MEMORY CONTENTS

Serial ID: Data Fields (Page 00)

Address	Size (Bytes)	Name	Description of Base ID Field	Optical Module
128	1	Identifier	Identifier Type of serial Module	R
129	1	Ext. Identifier	Extended Identifier of Serial Module	R
130	1	Connector	Code for connector type	R
131-138	8	Specification compliance	Code for electronic compatibility or optical compatibility	R
139	1	Encoding	Code for serial encoding algorithm	R

Technical Datasheet

Address	Size (Bytes)	Name	Description of Base ID Field	Optical Module
140	1	BR, nominal	Nominal bit rate, units of 100 Mbits/s	R
141	1	Extended rate select	Tags for extended rate select compliance	R
142	1	Length (SMF)	Link length supported for SMF Fibre in km (note 1)	R
143	1	Length (OM3 50um)	Link length supported for EBW 50/125 um Fibre (OM3), units of 2m (note 1)	R
144	1	Length (OM2 50um)	Link length supported for 50/125 um Fibre (OM2), units of 1m (note 1)	R
145	1	Length (OM1 62.5um)	Link length supported for 62.5/125 um Fibre (OM1), units of 1m (note 1)	R
146	1	Length (Copper)	Link length of copper or active cable, units of 1 m (note 1) Link length supported for 50/125 um Fibre (OM4), units of 2 m) when Byte 147 declares 850 nm VCSEL as defined in Table 37	R
147	1	Device tech	Device technology	R
148-163	16	Vendor name	QSFP28 vendor name: ATGBICS	R
164	1	Extended Module	Extended Module codes for InfiniBand	R
165-167	3	Vendor OUI	QSFP28 vendor IEEE company ID	R
168-183	16	Vendor PN	Part Number: QSF-100G-SR4-C	R
184-185	2	Vendor rev	Revision level for part number provided by vendor (ASCII)	R
186-187	2	Wavelength or Copper cable Attenuation	Nominal laser wavelength (wavelength=value/20 in nm) or copper cable attenuation in dB at 2.5GHz (Adrs 186) and 5.0GHz (Adrs 187)	R
188-189	2	Wavelength tolerance	Guaranteed range of laser wavelength (+/- value) from nominal wavelength. (wavelength Tol.=value/200 in nm)	R
190	1	Max case temp.	Maximum case temperature in degrees C	R

Technical Datasheet

Address	Size (Bytes)	Name	Description of Base ID Field	Optical Module	
191	1	CC_BASE	Check code for base ID fields (addresses 128-190)	R	
192-195	4	Options	Rate Select, TX Disable, TX Fault, LOS, Warning indicators for: Temperature, VCC, RX power, TX Bias	R	
196-211	16	Vendor SN	Serial number provided by vendor (ASCII)	R	
212-219	8	Date Code	Vendor's manufacturing date code	R	
220	1	Diagnostic Monitoring Type	Indicates which types of diagnostic monitoring are implemented (if any) in the Module. Bit 1,0 Reserved	R	
221	1	Enhanced Options	Indicates which optional enhanced features are implemented in the Module.	R	
222	1	Reserved			
223	1	CC_EXT	Check code for the Extended ID Fields (addresses 192-222)	R	
Vendor Specific ID Fields					
224-255	32	Vendor Specific EEPROM			R

Technical Datasheet

MECHANICAL DIMENSIONS (units: mm)



ESD

This transceiver is specified as ESD threshold 1KV for high-speed data pins and 2KV for all others electrical input pins, tested per MIL-STD-883, Method 3015.4 /JESD22-A114-A (HBM). However, normal ESD precautions are still required during the handling of this module. This transceiver is shipped in ESD protective packaging. It should be removed from the packaging and handled only in an ESD protected environment.

Laser Safety

This is a Class 1 Laser Product according to IEC 60825-1:2007. This product complies with 21 CFR 1040.10 and 1040.11 except for deviations pursuant to Laser Notice No. 50, dated (June 24, 2007)