

# BT7879

## MOUNTING PLATE FOR UC / VC VIDEO BARS

The BT7879 is a versatile mounting plate that allows the users to fit a videobar / UC equipment (including Biamp's Parlé VBC 2500/2500A, ABC 2500/2500A SBC 2 & Lenovo ThinkSmart One) to a range of B-Tech products, such as stands and trolleys. BT7879 is also compatible with a range of B-Tech component products, such as Accessory Collars for pole-mounted solutions or any of our Adjustable Arm mounts for mounting above or below System X Rails, Media Storage and Flat Screen Wall Mounts.



### SPECIFICATIONS





Steel thickness	<b>5mm</b>
Max load	<b>5kg</b>
Colour	<b>Black</b>

### FEATURES

- 1 Designed to mount a variety of video bars onto B-Tech stands and trolleys
- 2 Compatible with BT7052 / BT7841 collars for use with Ø50mm poles
- 3 Slide to position up / down on the column / poles
- 4 Can use BT8390-SA to mount above or below any screen on a System X Rail
  - Uses BT7034 for mounting above / below B-Tech Media Storage Mounts
  - Use with BT7031 to mount above / below B-Tech Flat Screen Wall Mounts
  - Ideal for low profile installations
  - Simple Installation

Suitable for a variety of major brands, including:

**biamp.** **Lenovo**

MAX LOAD  5kg	COLOUR 	COLLAR COMPATIBLE 	
--	---	--	---

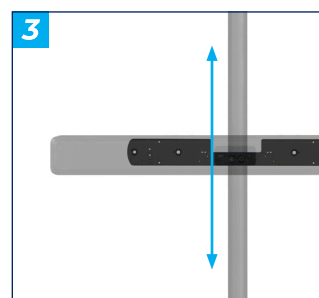
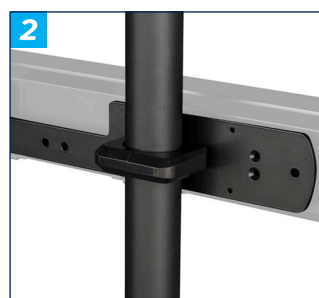

# BT7879

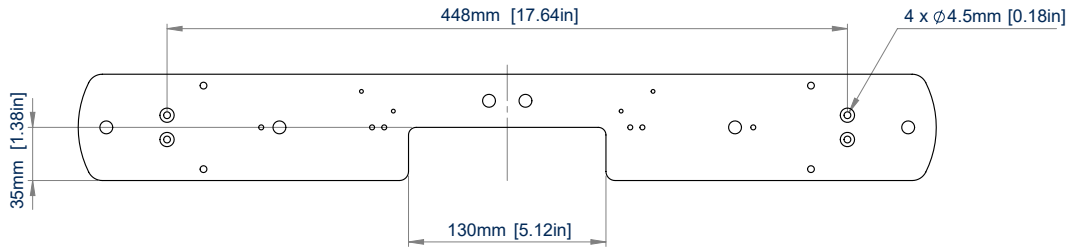

**FRONT VIEW**



**TOP VIEW**

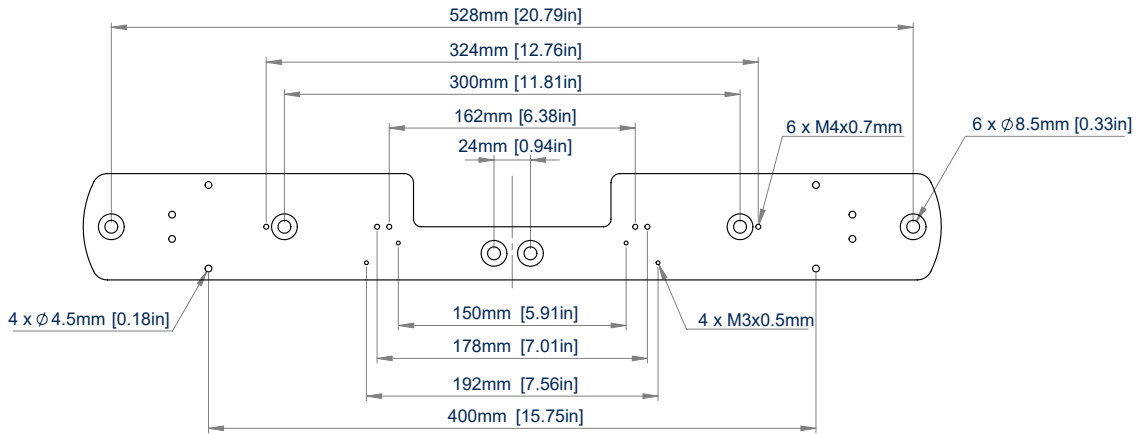

**REAR VIEW**

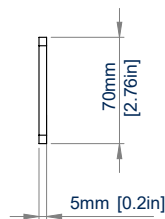

**SIDE VIEW**

## ORDERING INFORMATION

COLOUR	ORDER REF	EAN
Black	BT7879/B	5019318308338

## RELATED PRODUCTS

PRODUCT CODE	NAME	DESCRIPTION
BT7871	Mounting Plate	For Jabra Panacast 50, Poly Studio / X50 / X70
BT7873	Mounting Plate	For Logitech Rally Bars
BT7876	Mounting Plate	For Lenovo Google Series One Room Kits
BT7877	Mounting Plate	For Bose Videobar VBI/VB-S, Logitech Rally Plus Speakers, Neat.bar, Neat.bar Pro & More

© 2024 B.Tech. All Rights Reserved. The information in this specification sheet reflects the current technical specifications at the time of printing. We reserve the right to change the technical or physical specifications without prior notice. B.Tech. AV Mounts Co. Ltd. is not responsible for any damage caused by improper installation or mounting on unstable structures. Any reproduction or reuse of this specification sheet is strictly prohibited without prior written permission from B.Tech. AV Mounts Co. Ltd.

SS-V7-BT7879-160124