

DS-1272ZJ-120B

Wall Mounting Bracket for Mini Dome Camera
(with Junction Box)

Features:

- Aluminum alloy material with surface spray treatment
- The outlet hole makes the feature looks better
- Better water proof design
- The matched junction box has the waterproof pad

Dimension:

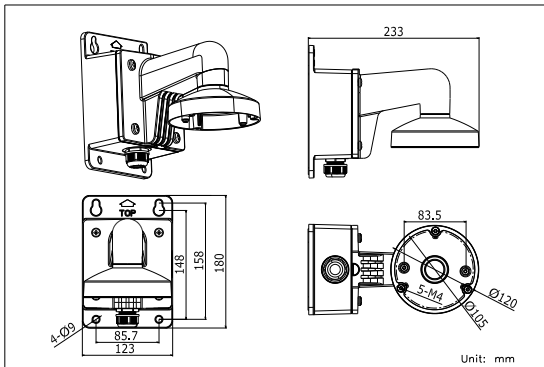

Order Model:

DS-1272ZJ-120B

Parameter:

Model	DS-1272ZJ-120B
Parameters	Wall Mounting Bracket for Mini Dome Camera (with Junction Box)
Appearance	Hikvision White
Range of Application	Suitable for dome camera wall mounting
Material	Aluminum Alloy
Dimension	123×180×233mm
Weight	1225g

Notice:

- Pay attention to the color matching when select bracket
- The bracket should be installed on flat wall
- The waterproof pad has to be kept when installing
- The wall must be capable of supporting over 3 times as much as the total weight of the camera and the mount.
- The maximum load capacity of the bracket is 4.5KG

Model Suitable:

DS-2CS58A1P-IRS, DS-2CS54A1P-IR, DS-2CD2512F-I(W), DS-2CD2532F-I(W), DS-2CD7133-E, DS-2CD7153-E, DS-2CD7164-E

Installation Step:

- ① Choose the appropriate wall and thread the wire through the waterproof stopper
- ② Fix the bracket to junction box, thread the wire and screw up
- ③ Install the bowl to the bracket and fix with fastening screw
- ④ Get off the transparent cover and check the hole site of adapter plate

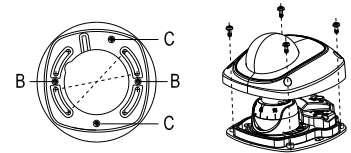
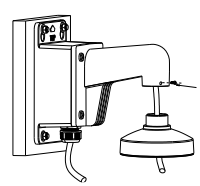
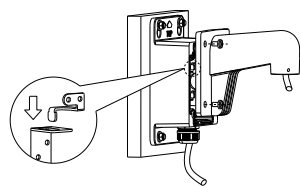
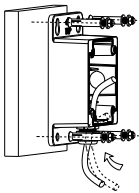

B: DS-2CS58A1XX, DS-2GD25XX
C: DS-2CD71XX

- ⑤ Install the combination to the bracket and complete the installation
- ⑥ Connect the camera wire and fix the camera onto the adapter plate
- ⑦ Modify the angle of monitoring, install the transparent cover and screw up
- ⑧ Bracket Installation complete.

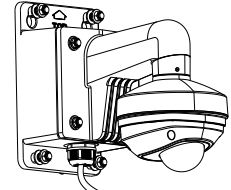
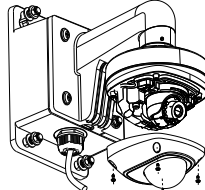
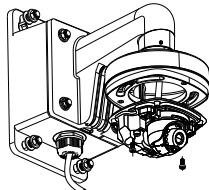
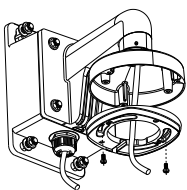

Note: The actual bracket may vary from the picture above.