

Smart Insight + Smart Resolution



- Makes the entire screen more visible to the human eye
- Reduces noise and blurring, ensuring a sharper display



- Increases visibility in dark areas
- Maintains visibility across the entire screen, including bright areas



Full-HD Monitor with Visibility-Enhancing Technology for Security and Surveillance

Equipped with 2 HDMI Inputs

The DuraVision FDF2305W is equipped with DVI-D 24 pin and D-Sub mini 15 pin inputs for digital and analog signal support respectively. It also has two HDMI inputs which support both PC and AV signals and can be connected to video cameras, recorders, and other AV devices.

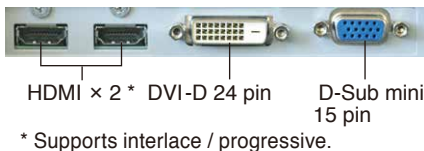
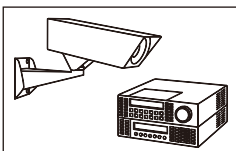

Full HD (1920 x 1080) LCD Panel

Images are displayed pixel-by-pixel in full high definition that fills the entire screen. Images taken with full HD cameras are reproduced in detail.

■ Displaying HD contents



19-inch monitor (1280x1024)
Black bars are visible and the screen is blurry



FDF2305W (1920x1080)
Displays pixel-by-pixel full HD content that fills the screen

Visibility in Dark Areas with Smart Insight

Automatically detects areas that are difficult to see and adjusts the brightness of each pixel, reproducing images with a realistic sense of depth. Figures that used to be difficult to see are now made visible.

Smart Insight off



Smart Insight on

Easy to see the dark areas!



Smart Resolution for Sharper Images

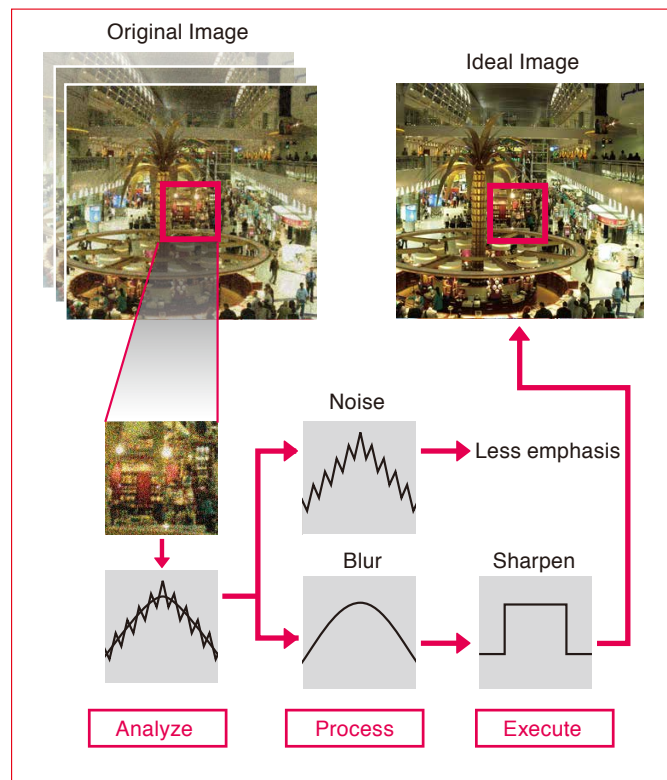

EIZO-patented super-resolution technology called Smart Resolution analyzes the displayed content for noise and blur. It ensures that noise is not accentuated while correcting the blur to the extent needed to sharpen the image. For images with a lot of depth, it sharpens the foreground more strongly to reproduce the depth that simulates a real world sense of focus.

Day and Night Preset Modes

3 preset modes are included: sRGB, Day, and Night. The latter two presets are optimized to match Day mode and Night mode (monochrome) used in digital cameras. You can easily switch between modes using a single button on the included remote control.

Reduce Reflective Light

A non-glare panel dissipates reflective light that would normally make the screen difficult to view and strain the eyes.

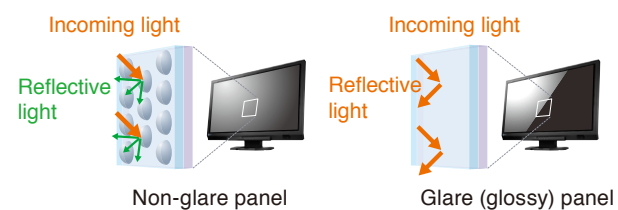

Display Moving Images Clearly

An overdrive circuit accelerates gray-to-gray response time which minimizes ghosting and blurring during high motion scenes for clear video reproduction.

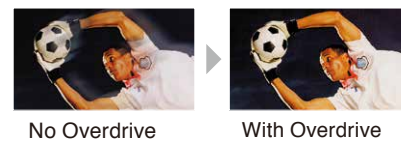

Equipped with ContrastEnhancer

ContrastEnhancer controls the LED backlight during videos. It has a 5000:1 contrast ratio that produces dark, realistic blacks and presents a clear display when contrast is increased.



Supports HDCP

The monitor is equipped with a DVI-D 24 pin and HDMI input with HDCP copyright protection technology. By connecting to an HDCP enabled computer, you can display digital copyright protected contents from digital streams and blue-ray.

Smooth Gradations

The input signal from a PC with 8 bits per RGB (Red, Green, Blue) color is converted to 14 bits within the monitor. Using gamma correction with a 14-bit LUT, the monitor chooses the best colors and returns the data to 8-bits to produce smooth display of gradations.

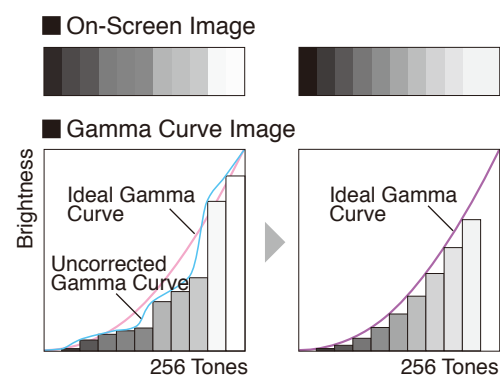

Automatic Brightness Adjustment

An Auto EcoView sensor on the front of the monitor detects ambient light and automatically optimizes the screen's brightness. Since the screen is never too bright or too dark, eye strain is reduced while power consumption is also cut.

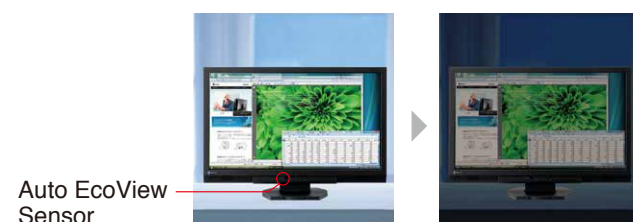

LED Backlight

The LED backlight has a wide dimming range, adjustable to as low as 3 cd/m². This makes it possible to use the monitor in dark places or environments where the illumination can change dramatically.

Compact Remote Control

Change inputs, sound, screen size, color mode, etc. directly using the included compact remote control.



Versatile Positioning

Adjust the monitor to the most comfortable position for working with height adjustment, tilt, and swivel capability.

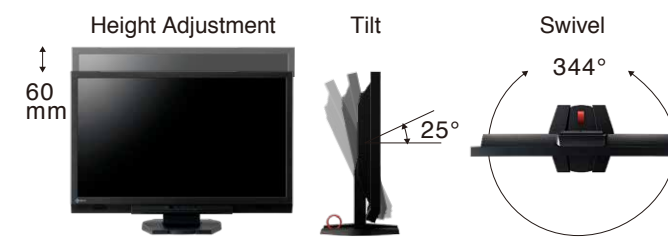

Built-In Speakers and Headphone Jack

The monitor is equipped with 0.5W + 0.5W stereo speakers. Users can connect external speakers using the line out port.



Built-in Power Supply

The AC power supply is built-in so you can connect easily with only one power cord.

Safety Lock

The monitor is equipped with a safety lock that can lock it in place on a desk or other surfaces, preventing the monitor from being knocked over or removed.

Protection Panel

An optional panel with reversible glossy and non-glare sides fits between the LCD screen and bezel to protect against dust and scratches.



Standless Mount Option

The stand can be easily removed to allow for wall mounting using the VESA mount screw-holes.

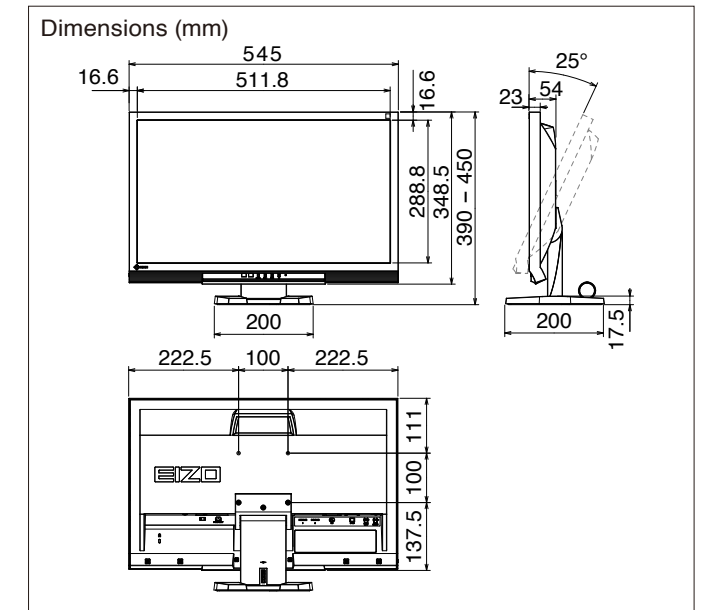

Accessory

LA-011-W

Wall Mount Arm (1-Axis Arm)

Mount your LCD monitor on a wall and change the screen position as necessary with tilt and swivel capability.

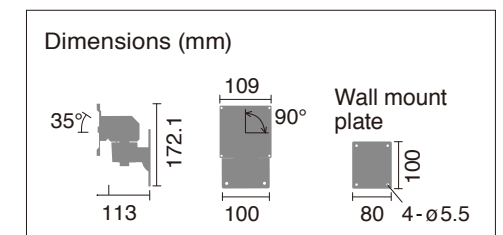

SPECIFICATIONS

Cabinet Color	Black
Panel Type	TN
Backlight	LED
Panel Size	23" / 58 cm (584 mm diagonal)
Native Resolution	1920 x 1080
Display Size (H x V)	509.76 x 286.74 mm
Pixel Pitch	0.2655 x 0.2655 mm
Grayscale Tones	256 tones
Display Colors	16.7 million
Viewing Angles (H / V, typical)	170°, 160°
Brightness (typical)	250 cd/m ²
Contrast Ratio (typical)	1000:1 (5000:1 with ContrastEnhancer)
Response Time (typical)	10 ms (Black to White to Black)
Input Terminals	PC: DVI-D 24 pin (with HDCP), D-Sub mini 15 pin PC / AV: HDMI x 2
Digital Scanning Frequency (H / V)	HDMI: 15 - 68 kHz / 49 - 61 Hz (VGA Text: 69 - 71 Hz), DVI: 31 - 68 kHz, 59 - 61 Hz (VGA Text: 69 - 71 Hz)
Analog Scanning Frequency (H / V)	PC: 31 - 81 kHz, 55 - 76 Hz AV: -
Sync Formats	PC: Separate AV: -
Speakers	0.5 W + 0.5 W (stereo)
Audio Input Terminals	PC: 3.5 mm stereo jack x 1 PC / AV: HDMI x 2
Audio Output Terminals	3.5 mm stereo jack, 3.5 mm headphone jack
Sound Adjustment	Volume, Mute, Sound Level, source (HDMI)
Power Requirements	AC 100 - 120 V/ AC 200 - 240 V, 50 / 60 Hz
Maximum Power Consumption	37 W
Typical Power Consumption	18 W
Power Save Mode	Less than 0.4 W
Standby Mode	Less than 0.3 W
Power Management	DVI DMPM, VESA DPM
Auto EcoView	Yes (Default: Disabled)
Dimensions (Landscape, W x H x D)	545 x 390 - 450 x 200 mm
Dimensions (Without Stand, W x H x D)	545 x 348.5 x 54 mm
Net Weight	5.2 kg
Net Weight (Without Stand)	3.9 kg
Height Adjustment Range	60 mm
Tilt	25° Up, 0° Down
Swivel	172° Right, 172° Left
Hole Spacing (VESA Standard)	100 x 100 mm
Temperature	5 - 35 °C
Humidity (R.H., non condensing)	20 - 80 %
Certifications & Standards	CB, CE, cTUVus, FCC-B, Canadian ICES-003-B, TUV/S, VCCI-B, CCC, RCM, RoHS, WEEE, China RoHS
Supplied Accessories	Power cord, Signal cable (DVI-D - DVI-D, HDMI - HDMI), remote control with battery, Screws for mount option, Setup manual, CD-ROM (PDF user's manual)
Warranty	Two Years

EIZO Corporation

153 Shimokashiwano, Hakusan, Ishikawa 924-8566 Japan

Phone +81-76-277-6792 Fax +81-76-277-6793

www.eizo.com

All product names are trademarks or registered trademarks of their respective companies.
DuraVision and EIZO are registered trademarks of EIZO Corporation.
Specifications are subject to change without notice.

Copyright©2014 EIZO Corporation. All rights reserved.