



**THE DISPLAY CHOICE  
OF PROFESSIONALS™**

**PN-55D & PN-55H LED-Backlit Display**

# **User Manual**

[www.agneovo.com](http://www.agneovo.com)

# TABLE OF CONTENTS

<b>SAFETY INFORMATION .....</b>	<b>1</b>
Federal Communications Commission (FCC) Notice (U.S. Only).....	1
CE Declaration of Conformity.....	2
Polish Center for Testing and Certification Notice.....	3
Electric, Magnetic and Electromagnetic Fields (“EMF”).....	3
Information for U.K. only.....	4
North Europe (Nordic Countries) Information.....	5
End-of-Life Disposal.....	6
Waste Electrical and Electronic Equipment-WEEE.....	6
Turkey RoHS.....	7
Ukraine RoHS.....	7
<b>PRECAUTIONS .....</b>	<b>8</b>
Cautions When Setting Up.....	8
Cautions When Using.....	9
Cleaning and Maintenance.....	9
Notice for the LCD Display.....	10
<b>CHAPTER 1: PRODUCT DESCRIPTION.....</b>	<b>11</b>
1.1 Package Contents.....	11
1.2 Preparing for the Installation.....	12
1.3 Installing and Removing Table Stands (optional).....	12
1.4 Wall Mounting Installation.....	13
1.4.1 VESA Grid.....	13
1.4.2 Ventilation Requirements for Enclosure Locating.....	14
1.5 Mounting in Portrait Position.....	14
1.6 LCD Display Overview.....	15
1.6.1 Control Panel.....	15
1.6.2 Input/Output Terminals.....	16
1.7 Remote Control.....	18
1.7.1 General Functions.....	18
1.7.2 ID Remote Control.....	19
1.7.3 Inserting the Batteries in the Remote Control.....	20
1.7.4 Handling the Remote Control.....	20
1.7.5 Operating Range of the Remote Control.....	20
<b>CHAPTER 2: MAKING CONNECTIONS.....</b>	<b>21</b>
2.1 Connecting the Power.....	21
2.2 Connecting a Computer.....	22
2.2.1 Using VGA Input.....	22
2.2.2 Using DVI Input.....	22
2.2.3 Using HDMI Input.....	23
2.2.4 Using DisplayPort Input.....	23

# TABLE OF CONTENTS

2.3 Connecting External Equipment (DVD/VCR/VCD).....	24
2.3.1 Using COMPONENT Video Input .....	24
2.3.2 Using Video Source Input.....	24
2.3.3 Using HDMI Video Input .....	25
2.4 Connecting Audio Equipment.....	25
2.4.1 Connecting External Speakers .....	25
2.4.2 Connecting an External Audio Device .....	26
2.5 Connecting Multiple Displays in a Daisy-chain Configuration .....	27
2.5.1 Display Control Connection.....	27
2.5.2 Digital Video Connection .....	27
2.5.3 Analog Video Connection .....	28
2.6 IR Connection.....	29
2.7 IR Pass-Through Connection .....	29
2.8 Connecting to Wired Network.....	30
<b>CHAPTER 3: USING THE LCD DISPLAY .....</b>	<b>31</b>
3.1 Turning on the Power .....	31
3.2 Selecting the Input Source Signal .....	31
3.3 Adjusting the Volume.....	32
3.4 Changing the Picture Format .....	32
3.5 Choosing Your Preferred Picture Settings.....	33
3.6 Choosing Your Preferred Sound Settings.....	33
3.7 Playing Multimedia Files via Local Area Network.....	34
3.7.1 Set Up the Network .....	34
3.7.2 How to Use DLNA-DMP .....	35
3.7.3 How to Use DLNA-DMR from PC.....	36
3.8 Playing Multimedia Files from USB Device .....	37
3.9 Play Options .....	38
3.9.1 Playing Music Files.....	38
3.9.2 Playing Movie Files .....	39
3.9.3 Playing Photo Files.....	40
<b>CHAPTER 4: ON SCREEN DISPLAY MENU.....</b>	<b>41</b>
4.1 Using the OSD Menu .....	41
4.2 OSD Menu Tree .....	43
<b>CHAPTER 5: ADJUSTING THE LCD DISPLAY .....</b>	<b>45</b>
5.1 Picture Settings .....	45
5.2 Sound Settings .....	48
5.3 Tiling Settings .....	50
5.4 General Settings.....	52
5.5 Network Settings .....	60

# TABLE OF CONTENTS

<b>CHAPTER 6: APPENDIX.....</b>	<b>62</b>
6.1 Warning Messages.....	62
6.2 USB Device Compatibility .....	63
6.3 Supported Resolution.....	66
6.4 Cleaning .....	67
6.5 Troubleshooting.....	68
6.6 Transporting the LCD Display .....	69
<b>CHAPTER 7: SPECIFICATIONS .....</b>	<b>70</b>
7.1 Display Specifications .....	70
7.2 Display Dimensions.....	72
7.2.1 PN-55D / PN-55H Dimensions .....	72

# SAFETY INFORMATION

## Federal Communications Commission (FCC) Notice (U.S. Only)



This equipment has been tested and found to comply with the limits for a Class B digital device, pursuant to part 15 of the FCC Rules. These limits are designed to provide reasonable protection against harmful interference in a residential installation. This equipment generates, uses and can radiate radio frequency energy and, if not installed and used in accordance with the instructions, may cause harmful interference to radio communications. However, there is no guarantee that interference will not occur in a particular installation. If this equipment does cause harmful interference to radio or television reception, which can be determined by turning the equipment off and on, the user is encouraged to try to correct the interference by one or more of the following measures:

- Reorient or relocate the receiving antenna.
- Increase the separation between the equipment and receiver.
- Connect the equipment into an outlet on a circuit different from that to which the receiver is connected.
- Consult the dealer or an experienced radio/TV technician for help.



Changes or modifications not expressly approved by the party responsible for compliance could void the user's authority to operate the equipment.

Use only an RF shielded cable that was supplied with the display when connecting this display to a computer device.

To prevent damage which may result in fire or shock hazard, do not expose this appliance to rain or excessive moisture.

THIS CLASS B DIGITAL APPARATUS MEETS ALL REQUIREMENTS OF THE CANADIAN INTERFERENCE-CAUSING EQUIPMENT REGULATIONS.



This device complies with Part 15 of the FCC Rules. Operation is subject to the following two conditions: (1) this device may not cause harmful interference, and (2) this device must accept any interference received, including interference that may cause undesired operation.

# SAFETY INFORMATION

## CE Declaration of Conformity

We declare under our responsibility that the product is in conformity with the following standards:

- EN60950-1:2006+A11:2009+A1:2010+A12:2011+A2:2013 (Safety requirement of Information Technology Equipment).
- EN55022:2010 (Radio Disturbance requirement of Information Technology Equipment).
- EN55024:2010 (Immunity requirement of Information Technology Equipment).
- EN61000-3-2:2006 +A1:2009+A2:2009 (Limits for Harmonic Current Emission).
- EN61000-3-3:2013 (Limitation of Voltage Fluctuation and Flicker)
- EN 50581:2012 (Technical documentation for the assessment of electrical and electronic products with respect to the restriction of hazardous substances)
- EN 50564:2011 (Electrical and electronic household and office equipment — Measurement of low power consumption) following provisions of directives applicable.
- 2006/95/EC (Low Voltage Directive).
- 2004/108/EC (EMC Directive).
- 2009/125/EC (ErP, Energy-related Product Directive, EC No. 1275/2008 and 642/2009 Implementing)
- 2011/65/EU (RoHS Directive) and is produced by a manufacturing organization on ISO9000 level.

# SAFETY INFORMATION

## Polish Center for Testing and Certification Notice

The equipment should draw power from a socket with an attached protection circuit (a three-prong socket). All equipment that works together (computer, display, printer, and so on) should have the same power supply source.

The phasing conductor of the room's electrical installation should have a reserve short-circuit protection device in the form of a fuse with a nominal value no larger than 16 amperes (A).

To completely switch off the equipment, the power supply cable must be removed from the power supply socket, which should be located near the equipment and easily accessible.

A protection mark "B" confirms that the equipment is in compliance with the protection usage requirements of standards PN-93/T-42107 and PN-89/E-06251.

### ***Wymagania Polskiego Centrum Badań i Certyfikacji***

Urządzenie powinno być zasilane z gniazda z przyłączonym obwodem ochronnym (gniazdo z kolkiem). Współpracujące ze sobą urządzenia (komputer, monitor, drukarka) powinny być zasilane z tego samego źródła.

Instalacja elektryczna pomieszczenia powinna zawierać w przewodzie fazowym rezerwową ochronę przed zwarciami, w postaci bezpiecznika o wartości znamionowej nie większej niż 16A (amperów).

W celu całkowitego wyłączenia urządzenia z sieci zasilania, należy wyjąć wtyczkę kabla zasilającego z gniazdko, które powinno znajdować się w pobliżu urządzenia i być łatwo dostępne.

Znak bezpieczeństwa "B" potwierdza zgodność urządzenia z wymaganiami bezpieczeństwa użytkowania zawartymi w PN-93/T-42107 i PN-89/E-06251.

### ***Pozostałe instrukcje bezpieczeństwa***

- Nie należy używać wtyczek adapterowych lub usuwać kolka obwodu ochronnego z wtyczki. Jeżeli konieczne jest użycie przedłużacza to należy użyć przedłużacza 3-żyłowego z prawidłowo połączonym przewodem ochronnym.
- System komputerowy należy zabezpieczyć przed nagłymi, chwilowymi wzrostami lub spadkami napięcia, używając eliminatora przepięć, urządzenia dopasowującego lub bezzakłóceniewego źródła zasilania.
- Należy upewnić się, aby nic nie leżało na kablach systemu komputerowego, oraz aby kable nie były umieszczone w miejscu, gdzie można byłoby na nie nadeptywać lub potykać się o nie.
- Nie należy rozlewać napojów ani innych płynów na system komputerowy.
- Nie należy wpychać żadnych przedmiotów do otworów systemu komputerowego, gdyż może to spowodować pożar lub porażenie prądem, poprzez zwarcie elementów wewnętrznych.
- System komputerowy powinien znajdować się z dala od grzejników i źródeł ciepła. Ponadto, nie należy blokować otworów wentylacyjnych. Należy unikać kładzenia luźnych papierów pod komputer oraz umieszczania komputera w ciasnym miejscu bez możliwości cyrkulacji powietrza wokół niego.

## Electric, Magnetic and Electromagnetic Fields ("EMF")

- We manufacture and sell many products targeted at consumers, which, like any electronic apparatus, in general have the ability to emit and receive electromagnetic signals.
- One of our leading Business Principles is to take all necessary health and safety measures for our products, to comply with all applicable legal requirements and to stay well within the EMF standards applicable at the time of producing the products.
- We are committed to develop, produce and market products that cause no adverse health effects.
- We confirm that if its products are handled properly for their intended use, they are safe to use according to scientific evidence available today.
- We play an active role in the development of international EMF and safety standards, enabling us to anticipate further developments in standardization for early integration in its products.

# SAFETY INFORMATION

## Information for U.K. only

WARNING - THIS APPLIANCE MUST BE EARTHED.

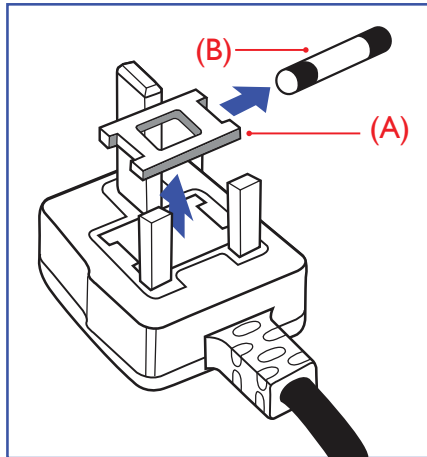

Important:

This apparatus is supplied with an approved moulded 13A plug. To change a fuse in this type of plug proceed as follows:

- 1 Remove fuse cover and fuse.
- 2 Fit new fuse which should be a BS 1362 5A, A.S.T.A. or BSI approved type.
- 3 Refit the fuse cover.

If the fitted plug is not suitable for your socket outlets, it should be cut off and an appropriate 3-pin plug fitted in its place.

If the mains plug contains a fuse, this should have a value of 5A. If a plug without a fuse is used, the fuse at the distribution board should not be greater than 5A.



Note:

The severed plug must be destroyed to avoid a possible shock hazard should it be inserted into a 13A socket elsewhere.



# SAFETY INFORMATION

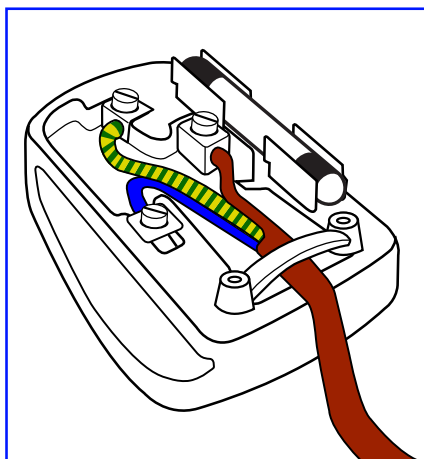

## How to connect a plug

The wires in the mains lead are coloured in accordance with the following code:

BLUE - "NEUTRAL" ("N")

BROWN - "LIVE" ("L")

GREEN & YELLOW - "EARTH" ("E")

- The GREEN & YELLOW wire must be connected to the terminal in the plug which is marked with the letter "E" or by the Earth symbol or coloured GREEN or GREEN & YELLOW.
- The BLUE wire must be connected to the terminal which is marked with the letter "N" or coloured BLACK.
- The BROWN wire must be connected to the terminal which marked with the letter "L" or coloured RED.

Before replacing the plug cover, make certain that the cord grip is clamped over the sheath of the lead - not simply over the three wires.

## North Europe (Nordic Countries) Information

Placering/Ventilation

**WARNING:** FÖRSÄKRA DIG OM ATT HUVUDBRYTARE OCH UTTAG ÄR LÄTÅTKOMLIGA, NÄR DU STÄLLER DIN UTRUSTNING PÅPLATS.

Placering/Ventilation

**ADVARSEL:** SØRG VED PLACERINGEN FOR, AT NETLEDNINGENS STIK OG STIKKONTAKT ER NEMT TILGÆNGLIGE.

Paikka/Ilmankierto

**VAROITUS:** SIJOITA LAITE SITEN, ETTÄ VERKKOJOHTO VOIDAAN TARVITTAESSA HELPOSTI IRROTTAA PISTORASIESTA.

Plassering/Ventilasjon

**ADVARSEL:** NÅR DETTE UTSTYRET PLASSERES, MÅ DU PASSE PÅ AT KONTAKTENE FOR STØMTILFØRSEL ER LETTE Å NÅ.

# SAFETY INFORMATION

## End-of-Life Disposal

Your new Public Information Display contains materials that can be recycled and reused. Specialized companies can recycle your product to increase the amount of reusable materials and to minimize the amount to be disposed of.

Please find out about the local regulations on how to dispose of your old display from your local dealer.

### (For customers in Canada and U.S.A.)

This product may contain lead and/or mercury. Dispose of in accordance to local-state and federal regulations. For additional information on recycling contact [www.eia.org](http://www.eia.org) (Consumer Education Initiative).

## Waste Electrical and Electronic Equipment-WEEE

### Attention users in European Union private households



This marking on the product or on its packaging illustrates that, under European Directive 2012/19/EU governing used electrical and electronic appliances, this product may not be disposed of with normal household waste. You are responsible for disposal of this equipment through a designated waste electrical and electronic equipment collection. To determine the locations for dropping off such waste electrical and electronic, contact your local government office, the waste disposal organization that serves your household or the store at which you purchased the product.

### Attention users in United States:

Please dispose of according to all Local, State and Federal Laws. For the disposal or recycling information, contact: [www.mygreenelectronics.com](http://www.mygreenelectronics.com) or [www.eiae.org](http://www.eiae.org).

## End of Life Directives-Recycling



Your new Public Information Display contains several materials that can be recycled for new users.

Please dispose of according to all Local, State, and Federal laws.

## Restriction on Hazardous Substances statement (India)

This product complies with the "India E-waste Rule 2011" and prohibits use of lead, mercury, hexavalent chromium, polybrominated biphenyls or polybrominated diphenyl ethers in concentrations exceeding 0.1 weight % and 0.01 weight % for cadmium, except for the exemptions set in Schedule 2 of the Rule.

## E-Waste Declaration for India



This symbol on the product or on its packaging indicates that this product must not be disposed of with your other household waste. Instead it is your responsibility to dispose of your waste equipment by handing it over to a designated collection point for the recycling of waste electrical and electronic equipment. The separate collection and recycling of your waste equipment at the time of disposal will help to conserve natural resources and ensure that it is recycled in a manner that protects human health and the environment.

# SAFETY INFORMATION

## Batteries



For EU: The crossed-out wheeled bin implies that used batteries should not be put to the general household waste! There is a separate collection system for used batteries, to allow proper treatment and recycling in accordance with legislation.

Please contact your local authority for details on the collection and recycling schemes.

For Switzerland: The used battery is to be returned to the selling point.

For other non-EU countries: Please contact your local authority for correct method of disposal of the used battery.

According to EU directive 2006/66/EC, the battery can't be disposed improperly. The battery shall be separated to collect by local service.

## Turkey RoHS

Türkiye Cumhuriyeti: EEE Yönetmeliğine Uygundur.

## Ukraine RoHS

Обладнання відповідає вимогам Технічного регламенту щодо обмеження використання деяких небезпечних речовин в електричному та електронному обладнанні, затвердженого постановою Кабінету Міністрів України від 3 грудня 2008 № 1057.

# PRECAUTIONS

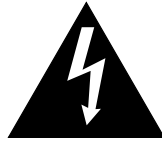

## Symbols used in this manual

	This icon indicates the existence of a potential hazard that could result in personal injury or damage to the product.
	This icon indicates important operating and servicing information.

## Notice

- Read this User Manual carefully before using the LCD display and keep it for future reference.
- The product specifications and other information provided in this User Manual are for reference only. All information is subject to change without notice. Updated content can be downloaded from our web site at <http://www.agneovo.com>.
- To register online, go to <http://www.agneovo.com>.
- To protect your rights as a consumer, do not remove any stickers from the LCD display. Doing so may affect the determination of the warranty period.

## Cautions When Setting Up

- Do not place the LCD display near heat sources, such as a heater, exhaust vent, or in direct sunlight.
- Do not cover or block the ventilation holes in the housing.
- Place the LCD display on a stable area. Do not place the LCD display where it may subject to vibration or shock.
- Place the LCD display in a well-ventilated area.
- Do not place the LCD display outdoors.
- To avoid the risk of shock or permanent damage to the set, do not expose the display to dust, rain, water or an excessively moist environment.
- Do not spill liquid or insert sharp objects into the LCD display through the ventilation holes. Doing so may cause accidental fire, electric shock or damage the LCD display.

# PRECAUTIONS

## Cautions When Using

- Use only the power cord supplied with the LCD display.
- The power outlet should be installed near the LCD display and be easily accessible.
- If an extension cord is used with the LCD display, ensure that the total current consumption plugged into the power outlet does not exceed the ampere rating.
- Do not allow anything to rest on the power cord. Do not place the LCD display where the power cord may be stepped on.
- If the LCD display will not be used for an indefinite period of time, unplug the power cord from the power outlet.
- To disconnect the power cord, grasp and pull by the plug head. Do not tug on the cord; doing so may cause fire or electric shock.
- Do not unplug or touch the power cord with wet hands.
- When turning off the display by detaching the power cord, wait 6 seconds before re-attaching the power cord for normal operation.
- Do not knock or drop the display during operation or transportation.

## Cleaning and Maintenance

- To protect your display from possible damage, do not put excessive pressure on the LCD panel. When moving your display, grasp the frame to lift; do not lift the display by placing your hand or fingers on the LCD panel.
- Unplug the display if you need to clean it with a slightly damp cloth. The screen may be wiped with a dry cloth when the power is off. However, never use organic solvent, such as, alcohol, or ammonia-based liquids to clean your display.
- If your display becomes wet, wipe it with dry cloth as soon as possible.
- If a foreign substance or water gets in your display, turn the power off immediately and disconnect the power cord. Then remove the foreign substance or water, and send the unit to the maintenance center.
- In order to maintain the best performance of your display and ensure a longer lifetime, we strongly recommend using the display in a location that falls within the following temperature and humidity ranges.
  - ◆ Temperature: 0-40°C (32-104°F)
  - ◆ Humidity: 20-80% RH



### Warning:



Unplug the power cord from the power outlet and refer to qualified service

personnel under the following conditions:

- ◆ When the power cord is damaged.
- ◆ If the LCD display has been dropped or the housing has been damaged.
- ◆ If the LCD display emits smoke or a distinct odor.

# PRECAUTIONS

## Notice for the LCD Display

- In order to maintain the stable luminous performance, it is recommended to use low brightness setting.
- Due to the lifespan of the lamp, it is normal that the brightness quality of the LCD display may decrease with time.
- When static images are displayed for long periods of time, the image may cause an imprint on the LCD display. This is called image retention or burn-in.
  - ◆ To prevent image retention, do any of the following:
    - Set the LCD display to turn off after a few minutes of being idle.
    - Use a screen saver that has moving graphics or a blank white image.
    - Execute the ANTI-BURN-IN function of the LCD display. See “General Settings, ANTI-BURN-IN” section.
    - Switch desktop backgrounds regularly.
    - Adjust the LCD display to low brightness settings.
    - Turn off the LCD display when the system is not in use.
  - ◆ Things to do when the LCD display shows image retention:
    - Turn off the LCD display for extended periods of time. It can be several hours or several days.
    - Use a screen saver and run it for extended periods of time.
    - Use a black and white image and run it for extended periods of time.
- There are millions of micro transistors inside the LCD display. It is normal for a few transistors to be damaged and to produce spots. This is acceptable and is not considered a failure.
- **IMPORTANT:** Always activate a moving screen saver program when you leave your display unattended. Always activate a periodic screen refresh application if the unit will display unchanging static content. Uninterrupted display of still or static images over an extended period may cause “burn in”, also known as “after-imaging” or “ghost imaging”, on your screen. This is a well-known phenomenon in LCD panel technology. In most cases, the “burned in” or “after-imaging” or “ghost imaging” will disappear gradually over a period of time after the power has been switched off.
- **WARNING:** Severe “burn-in” or “after-image” or “ghost image” symptoms will not disappear and cannot be repaired. This is also not covered under the terms of your warranty.

# CHAPTER 1: PRODUCT DESCRIPTION

## 1.1 Package Contents

When unpacking, check if the following items are included in the package. If any of them is missing or damaged, contact your dealer.

LCD Display

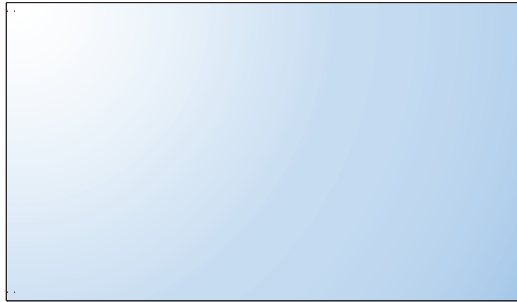

User Manual

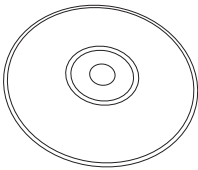

Remote control

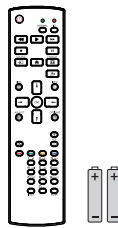

Power cord

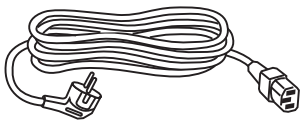

RS232 daisy-chain cable

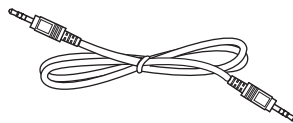

RS232 cable

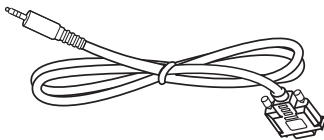

Video signal cable  
(D-SUB to D-SUB cable)

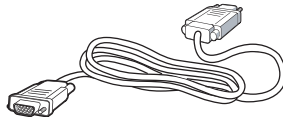

IR sensor cable



### Note:

- ◆ Remote control is shipped with the supplied AAA batteries.
- ◆ For all other regions, apply a power cord that conforms to the AC voltage of the power socket and has been approved by and complies with the safety regulations of the particular country.
- ◆ You might like to save the package box and packing material for shipping the display.

### Note:

- ◆ The pictures are for reference only. Actual items may vary upon shipment.

# PRODUCT DESCRIPTION

## 1.2 Preparing for the Installation

- Due to the high power consumption, always use the plug exclusively designed for this product. If an extended line is required, please consult your service agent.
- The product should be installed on a flat surface to avoid tipping. The distance between the back of the product and the wall should be maintained for proper ventilation. Avoid installing the product in the kitchen, bathroom or any other places with high humidity so as not to shorten the service life of the electronic components.
- The product can normally operate only under 5000m in altitude. In installations at altitudes above 3000m, some abnormalities may be experienced.

## 1.3 Installing and Removing Table Stands (optional)

To install table stands:

- 1 Ensure your display is powered off.
- 2 Spread a protective sheet on a flat surface.
- 3 Grab the carrying handles and place the display face-down on the protective sheet.
- 4 After inserting the stand in the guide block, tighten the screws on both sides of the display.

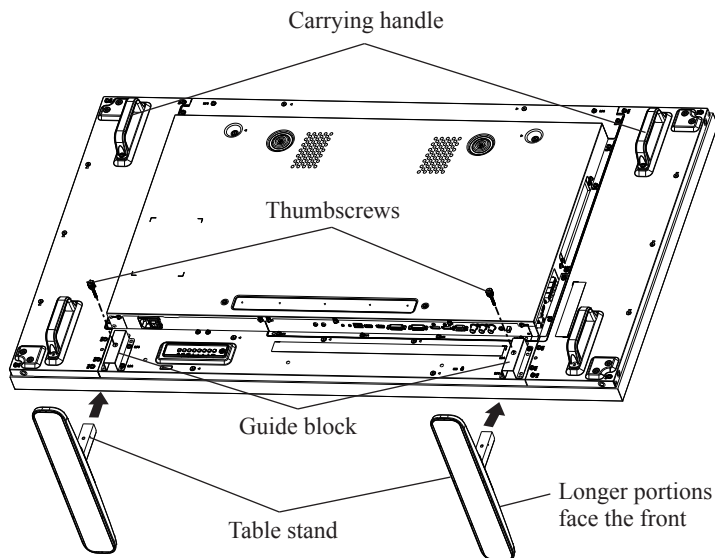

To remove table stands:

- 1 Power off the display.
- 2 Spread a protective sheet on a flat surface.
- 3 Grab the carrying handles and place the display face-down on the protective sheet.
- 4 Remove screws using a screwdriver and place them in a safe place for reuse.



### Warning:

- ◆ Do not press too hard on the LCD panel or edge of the frame, as this may cause the device to malfunction.
- ◆ During unpacking, make sure to hold the carrying handles to remove the device from its packaging.

### Note:

- ◆ The longer side of the stand should face the front of the display.



# PRODUCT DESCRIPTION

## 1.4 Wall Mounting Installation

To mount this display to a wall, you will have to obtain a standard wall-mounting kit (commercially available). We recommend using a mounting interface that complies with TUV-GS and/or UL1678 standard in North America.

To wall-mount the LCD display, screw the mounting bracket to the VESA holes at the rear of the LCD display.

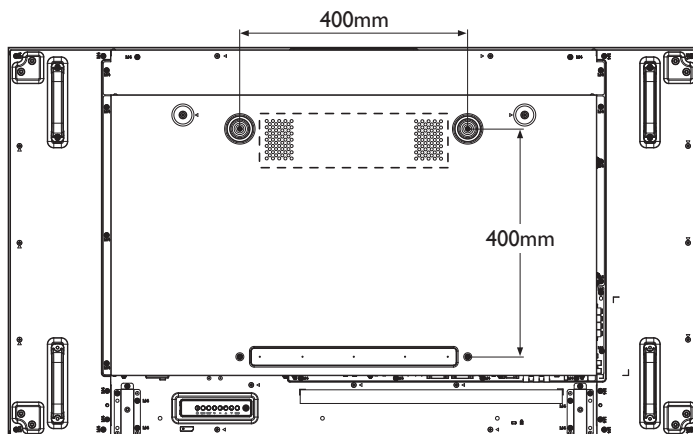

### 1.4.1 VESA Grid

Model Name	VESA Grid
PN-55D / PN-55H	400(H) x 400(V) mm

#### Caution:

To prevent the display from falling:

- ◆ For wall or ceiling installation, we recommend installing the display with metal brackets which are commercially available. For detailed installation instructions, refer to the guide received with the respective bracket.
- ◆ To lessen the probability of injury and damage resulting from fall of the display in case of earthquake or other natural disaster, be sure to consult the bracket manufacturer for installation location.

#### Note:

- ◆ Avoid the wall-mounting kit to block the ventilation holes on the back of the display.
- ◆ Secure the LCD display on a solid wall strong enough to bear its weight.
- ◆ Lay a protective sheet on a table, which was wrapped around the display when it was packaged, beneath the screen surface so as not to scratch the screen face.
- ◆ Ensure you have all accessories for mounting this display (wall mount, ceiling mount, table stand, etc).
- ◆ Follow the instructions that come with the base mounting kit. Failure to follow correct mounting procedures could result in damage to the equipment or injury to the user or installer. Product warranty does not cover damage caused by improper installation.
- ◆ For the wall-mounting kit, use M6 mounting screws (having a length 10 mm longer than the thickness of the mounting bracket) and tighten them securely.
- ◆ Unit without base weight= 29.2 kg. The equipment and its associated mounting means still remain secure during the test. For use only with UL Listed Wall Mount Bracket with minimum weight/load: 87.6 kg.

# PRODUCT DESCRIPTION

## 1.4.2 Ventilation Requirements for Enclosure Locating

To allow heat to disperse, leave space between surrounding objects as shown in the diagram below.

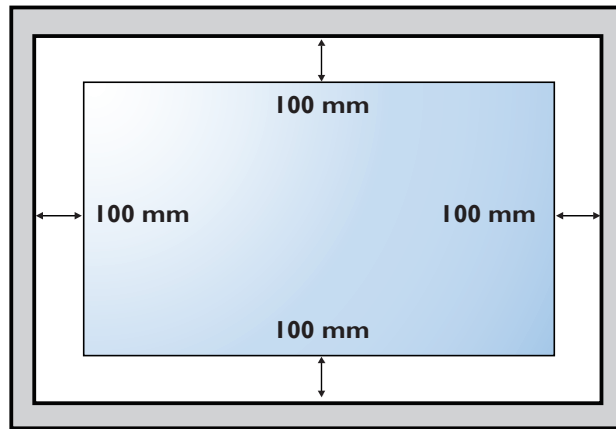

## 1.5 Mounting in Portrait Position

This display can be installed in portrait position.

- 1 Remove the table stand, if attached.
- 2 Rotate 90 degrees counter-clockwise.

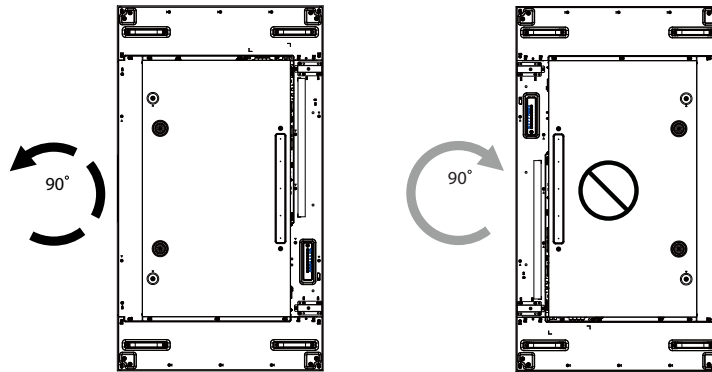

# PRODUCT DESCRIPTION

## 1.6 LCD Display Overview

### 1.6.1 Control Panel

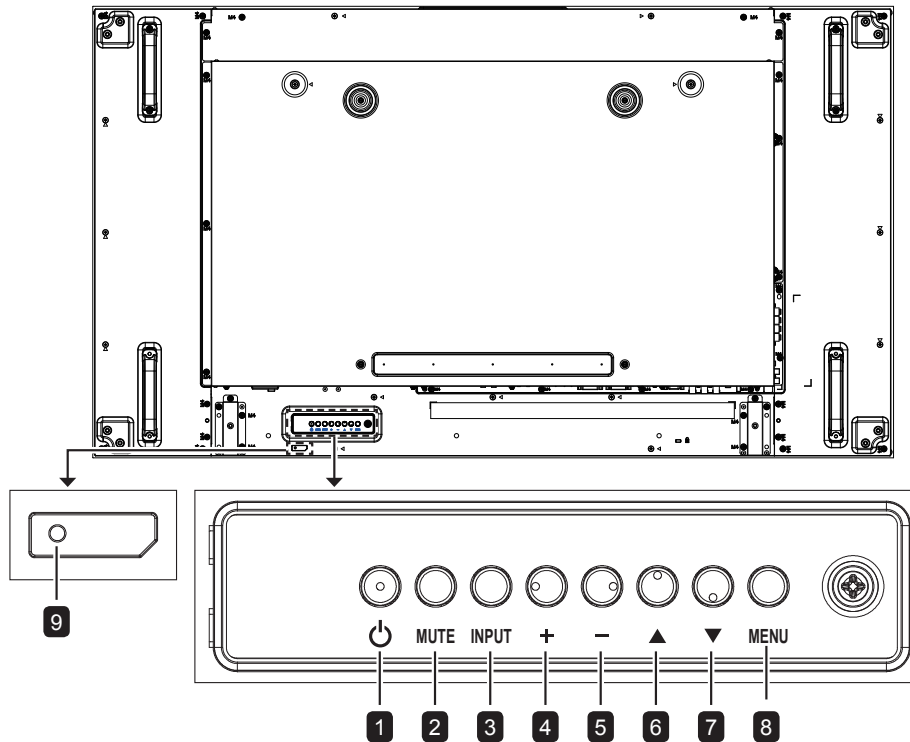

#### 1 [⏻] Power

Turn the display on or put the display to standby.

#### 2 MUTE

Switch the audio mute ON/OFF.

#### 3 INPUT

- Choose the input source.
- Used as the OK button while OSD menu is on.

#### 4 [+] Increase

- Increase the adjustment while OSD menu is on.
- Increase the audio output level while OSD menu is off.

#### 5 [-] Decrease

- Decrease the adjustment while OSD menu is on.
- Decrease the audio output level while OSD menu is off.

#### 6 [▲] Up

Move the highlight bar up to adjust the selected item while OSD menu is on.

#### 7 [▼] Down

Move the highlight bar down to adjust the selected item while OSD menu is on.

#### 8 MENU

- Return to the previous menu while OSD menu is on.
- Activate the OSD menu when OSD menu is off.

#### 9 Remote control sensor and power status indicator

- Receive command signals from the remote control.
- Indicate the operating status of the display without OPS:
  - Lights green when the display is turned on
  - Lights red when the display is in standby mode
  - Lights amber when the display enters APM mode
  - When **SCHEDULE** is enabled, the light blinks green and red
  - If the light blinks red, it indicates that a failure has been detected
  - Lights off when the main power of the display is turned off

# PRODUCT DESCRIPTION

## 1.6.2 Input/Output Terminals

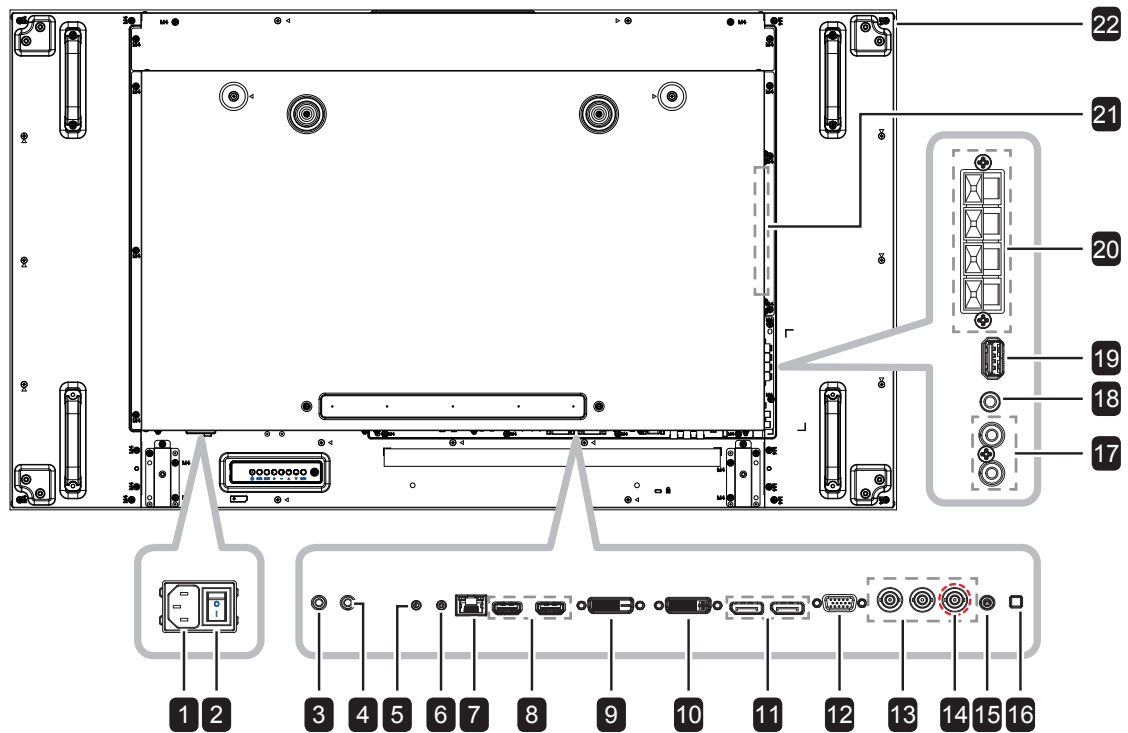

- |   |   |
|---|---|
| <p><b>1 AC IN</b><br/>AC power input from the wall outlet.</p> <p><b>2 Main power switch</b><br/>Switch the main power on/off.</p> <p><b>3/4 IR IN/ IR OUT</b><br/>IR signal input / output for the loop-through function.</p> <p><b>Note:</b></p> <ul style="list-style-type: none"> <li>◆ This display's remote control sensor will stop working if the [IR IN] jack is connected.</li> <li>◆ To remotely control your A/V device via this display, refer to page 29 for IR Pass-Through connection.</li> </ul> <p><b>5/6 RS232C IN/ RS232C OUT</b><br/>RS232C network output / input for the loop-through function.</p> <p><b>7 RJ-45</b><br/>LAN control function for the use of remote control signal from the control center.</p> | <p><b>8 HDMI1 IN/ HDMI2 IN</b><br/>HDMI video/audio input.</p> <p><b>9 DVI IN</b><br/>DVI-D video input.</p> <p><b>10 DVI OUT / VGA OUT</b><br/>DVI or VGA video output.</p> <p><b>11 DisplayPort IN/ DisplayPort OUT</b><br/>DisplayPort video input / output.</p> <p><b>12 VGA IN (D-Sub)</b><br/>VGA video input.</p> <p><b>13 COMPONENT IN (BNC)</b><br/>Component YPbPr video source input.</p> <p><b>14 Y/CVBS</b><br/>Video source input.</p> <p><b>15 PC LINE IN</b><br/>Audio input for PC source (3.5mm stereo phone).</p> <p><b>16 SPEAKER SWITCH</b><br/>Select the internal or external speaker.</p> |
|---|---|

# PRODUCT DESCRIPTION

**17 AUDIO IN**

Audio input from external AV device (RCA).

**18 AUDIO OUT**

Audio output to external AV device.

**19 USB PORT**

Connect your USB storage device.

**20 EXT. SPEAKER TERMINAL**

Audio output to external speakers.

**21 OPS SLOT**

Slot for installing the optional OPS module.

**22 SECURITY LOCK**

Used for security and theft prevention.

# PRODUCT DESCRIPTION

## 1.7 Remote Control

### 1.7.1 General Functions

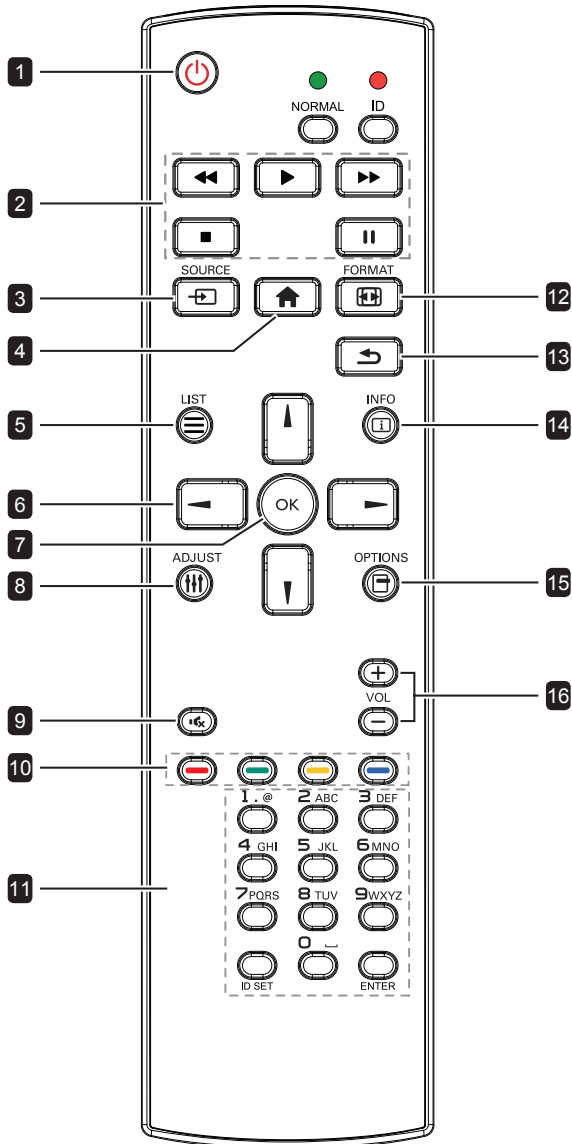

#### 1 [POWER] POWER

Turn the display on or to put the display into standby mode.

#### 2 [PLAY] PLAY

Control playback in multimedia mode.

#### 3 [SOURCE] SOURCE

Choose input source. Press the  $\uparrow$  or  $\downarrow$  button to choose from USB, Network, HDMI 1, HDMI 2, DisplayPort, Card OPS, DVI-D, YPbPr, AV, or VGA. Press the OK button to confirm and exit.

#### 4 [HOME] HOME

Access the OSD menu.

#### 5 [LIST] LIST

No function.

#### 6 [NAVIGATION] NAVIGATION buttons

Navigate through menus and choose items.

#### 7 [OK] OK

Confirm an entry or selection.

#### 8 [ADJUST] ADJUST

Access currently available picture and sound menus.

#### 9 [MUTE] MUTE

Turn the mute function on/off.

#### 10 [COLOR] COLOR

- Red: Press to play all songs in the playlist.
- Green: Press to sort the playlist.
- Yellow: Press to view the USB device.
- Blue: No function

#### 11 [Number/ ID SET/ ENTER] [Number/ ID SET/ ENTER]

- Enter text for network setting.
- Set the display ID. Refer to 1.7.2 ID Remote Control for more detail.

#### 12 [FORMAT] FORMAT

Change the aspect ratio.

#### 13 [BACK] BACK

Return to the previous menu or exit from the previous function.

#### 14 [INFO] INFO

View the information about the display.

#### 15 [OPTIONS] OPTIONS

Set Playback options.

#### 16 [VOLUME] VOLUME

Adjust the volume level.

# PRODUCT DESCRIPTION

## 1.7.2 ID Remote Control

You can set the remote control ID when you want to use this remote control on one of several different displays.

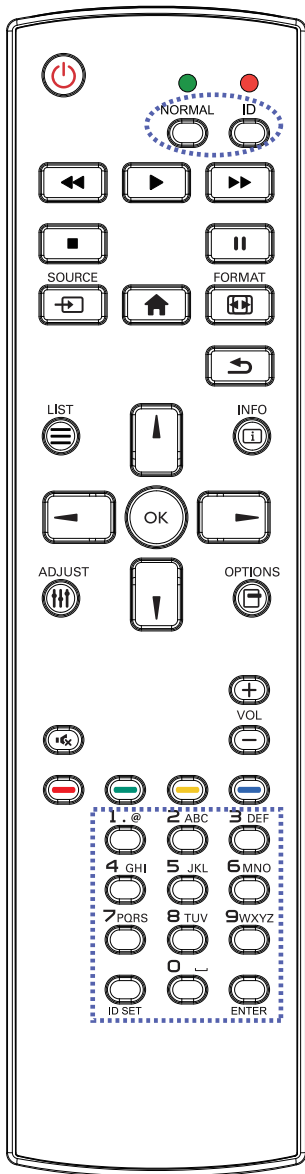

To set the remote control ID:

- 1 Press the **ID** button. The red LED blinks twice.
- 2 Press the **ID SET** button for 3 seconds to enter the ID mode. The red LED lights up.  
Press the **ID SET** button again will exit the ID mode. The red LED lights off.
- 3 Press the digit numbers [0] ~ [9] to select the display you want to control.  
For example:
  - Display ID #1: press [0], [0], [1]
  - Display ID #11: press [0], [1], [1]The numbers available are from [001] ~ [255].
  - Not pressing any button within 10 seconds will exit the ID mode.
  - If an error pressing of buttons other than the digits occurred, wait 1 second after the red LED lights off and then lights up again, then press the correct digits again.
- 4 Press the **ENTER** button to confirm. The red LED blinks twice and then lights off.

### Note:

- ◆ Press the **NORMAL** button. The green LED blinks twice, indicating the remote control returns to normal operation.
- ◆ It is necessary to set up the ID number for each display before selecting its ID number.

# PRODUCT DESCRIPTION

## 1.7.3 Inserting the Batteries in the Remote Control

The remote control is powered by two 1.5V AAA batteries.

To install or replace batteries:

- 1 Press and then slide the cover to open it.
- 2 Align the batteries according to the (+) and (-) indications inside the battery compartment.
- 3 Replace the cover.

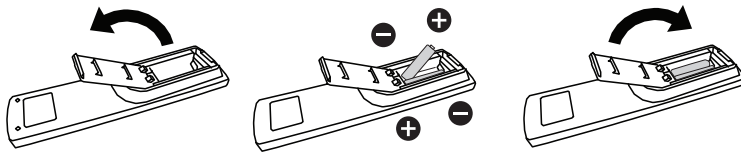

## 1.7.4 Handling the Remote Control

- Do not subject to strong shock.
- Do not allow water or other liquid to splash the remote control. If the remote control gets wet, wipe it dry immediately.
- Avoid exposure to heat and steam.
- Other than to install the batteries, do not open the remote control.

## 1.7.5 Operating Range of the Remote Control

Point the top of the remote control toward the display's remote control sensor(back side) when pressing a button.

Use the remote control within the range which is shown in the following table.

Operation Angle	RC operational distance
$\theta = 0^\circ$ (for H & V)	$\geq 8\text{m}$
$\theta = 20^\circ$ (for H & V)	$\geq 5\text{m}$
$\theta = 45^\circ$ (for H only)	$\geq 2\text{m}$

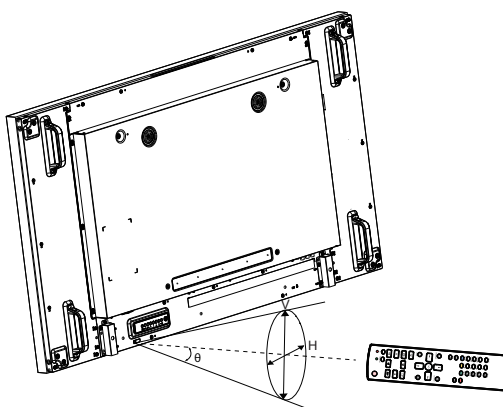

### Caution:

The incorrect use of batteries can result in leaks or bursting. Be sure to follow these instructions:

- ◆ Place "AAA" batteries matching the (+) and (-) signs on each battery to the (+) and (-) signs of the battery compartment.
- ◆ Do not mix battery types.
- ◆ Do not combine new batteries with used ones. It causes shorter life or leakage of batteries.
- ◆ Remove the dead batteries immediately to prevent them from liquid leaking in the battery compartment. Don't touch exposed battery acid, as it can damage your skin.

### Note:

- ◆ If you do not intend to use the remote control for a long period, remove the batteries.
- ◆ The remote control may not function properly when the remote control sensor on this display is under direct sunlight or strong illumination, or when there is an obstacle in the path of signal transmission.



# CHAPTER 2: MAKING CONNECTIONS

## 2.1 Connecting the Power

- 1 Connect one end of the power cord to the AC IN connector at the rear of the LCD display.
- 2 Connect the other end of the power cord to a power outlet or a power supply.
- 3 Set the **Main Power** switch to ON.

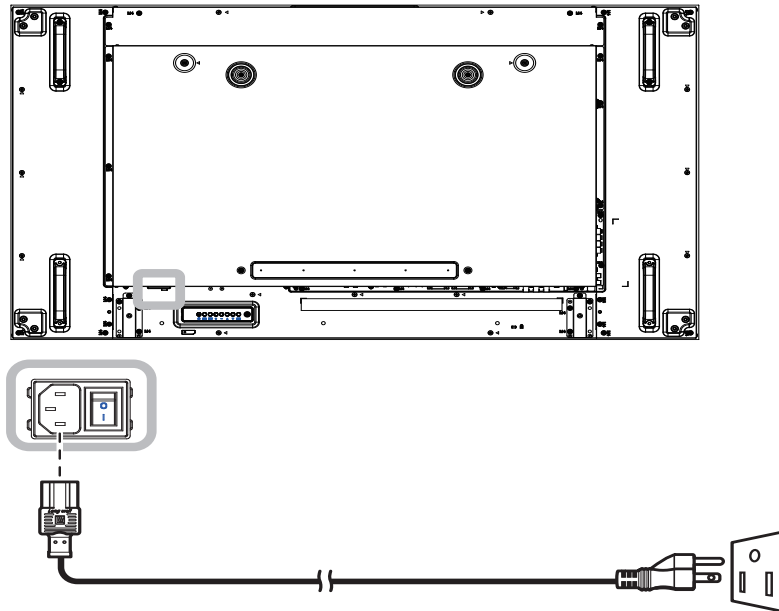

### Caution:

- ◆ Make sure that the LCD display is not connected to the power outlet before making any connections. Connecting cables while the power is ON may cause electric shock or personal injury.
- ◆ When unplugging the power cord, hold the power cord by the plug head. Never pull by the cord.

# MAKING CONNECTIONS

## 2.2 Connecting a Computer

### 2.2.1 Using VGA Input

Connect one end of a D-sub cable to the VGA IN connector of the LCD display and the other end of a D-sub cable to the VGA OUT (D-Sub) connector of the computer.

For audio input, connect one end of an audio cable to the AUDIO IN connector of the LCD display and the other end of an audio cable to the AUDIO OUT connector of the computer.

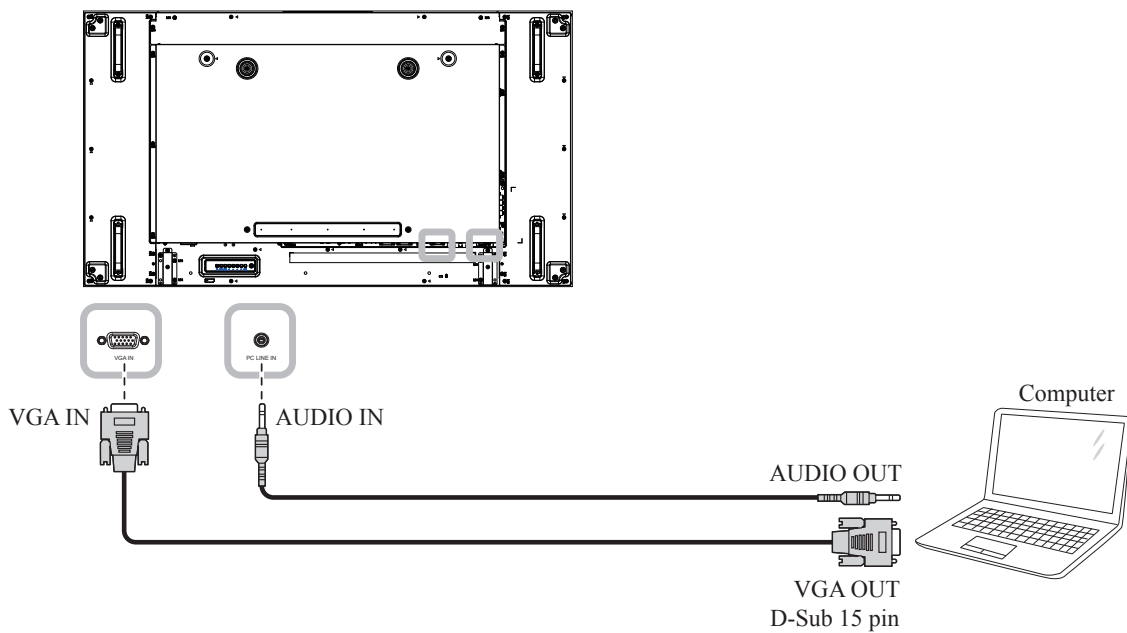

### 2.2.2 Using DVI Input

Connect one end of a DVI cable to the DVI IN connector of the LCD display and the other end of a DVI cable to the DVI connector of the computer.

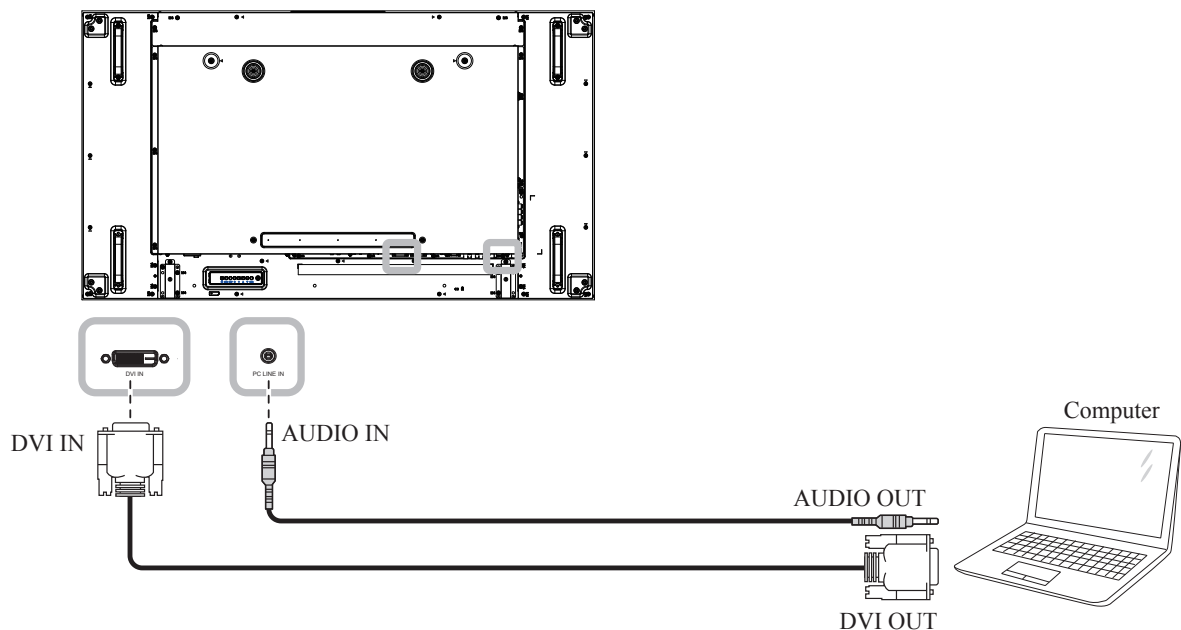

# MAKING CONNECTIONS

## 2.2.3 Using HDMI Input

Connect one end of an HDMI cable to the HDMI1 IN/ HDMI2 IN connector of the LCD display and the other end of an HDMI cable to the HDMI OUT connector of the computer.

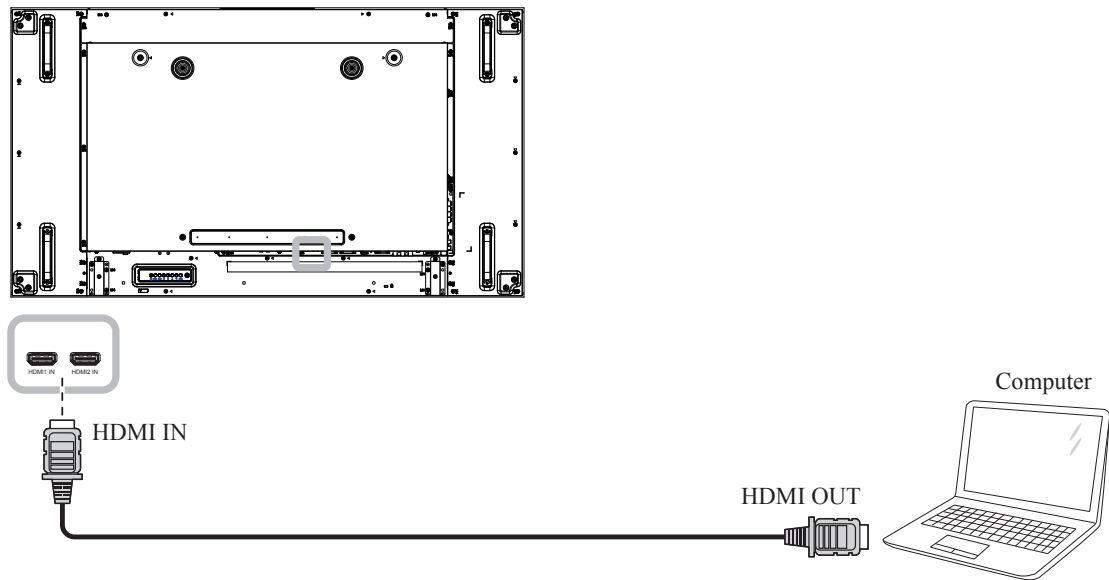

## 2.2.4 Using DisplayPort Input

Connect one end of a DisplayPort cable to the DisplayPort IN connector of the LCD display and the other end of a DisplayPort cable to the DisplayPort OUT connector of the computer.

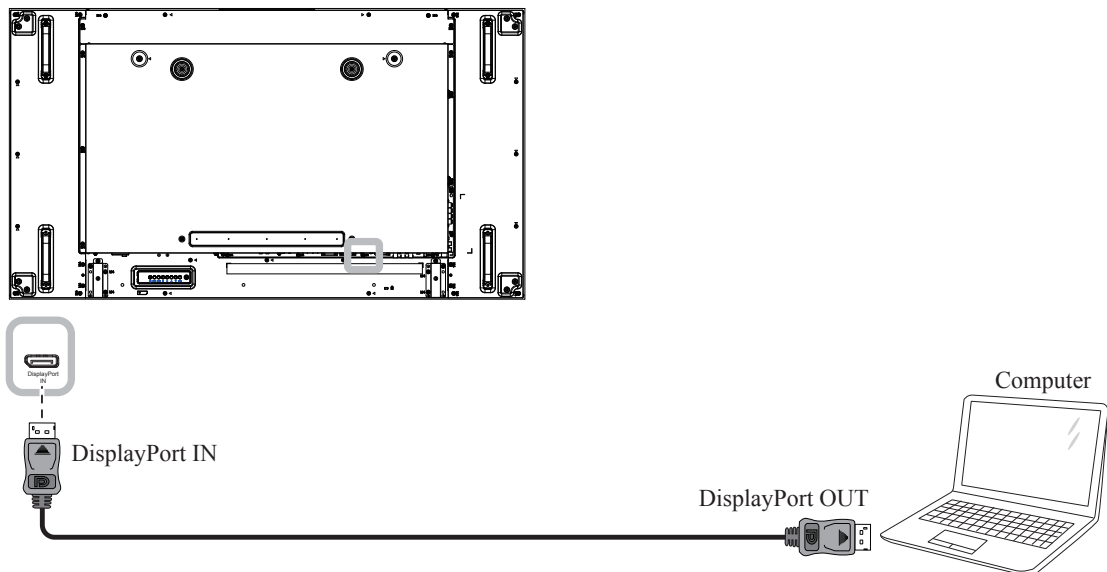

# MAKING CONNECTIONS

## 2.3 Connecting External Equipment (DVD/VCR/VCD)

### 2.3.1 Using COMPONENT Video Input

Connect one end of a component cable to the COMPONENT IN connector of the LCD display and the other end of a component cable to the COMPONENT OUT connectors of the video player (DVR/VCR/VCD).

For audio input, connect one end of an audio cable to the AUDIO IN connectors of the LCD display and the other end of an audio cable to the AUDIO OUT connectors of the video player (DVR/VCR/VCD).

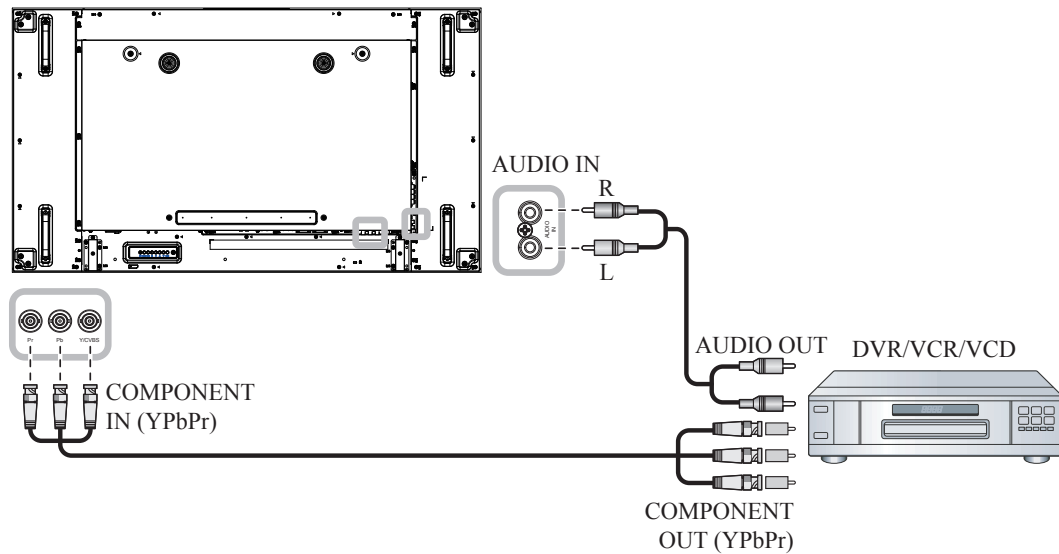

### 2.3.2 Using Video Source Input

Connect one end of a video cable to the Y/CVBS in port of the LCD display and the other end of a video cable to the Y/CVBS out port of the the video player (DVR/VCR/VCD).

For audio input, connect one end of an audio cable to the AUDIO IN connectors of the LCD display and the other end of an audio cable to the AUDIO OUT connectors of the video player (DVR/VCR/VCD).

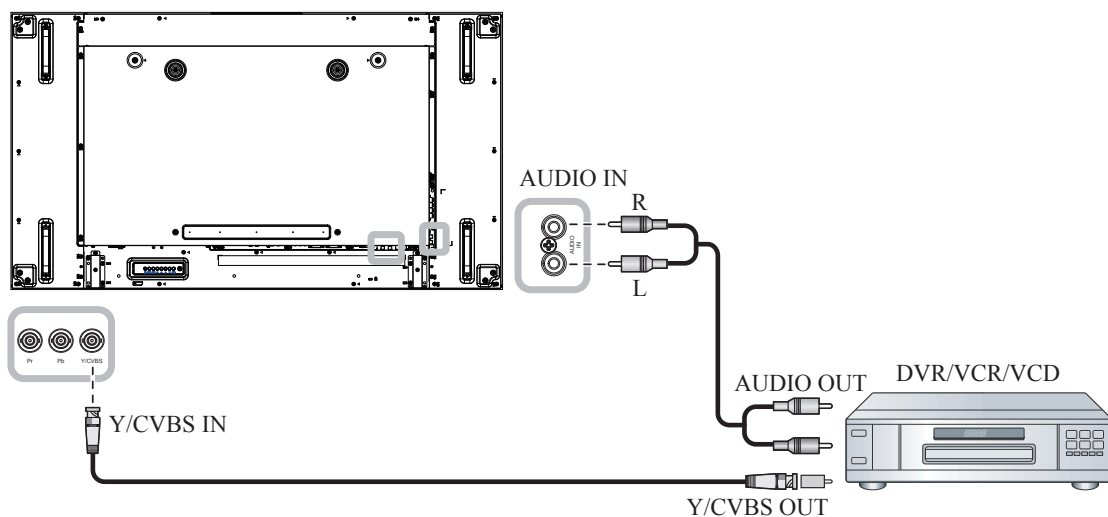

# MAKING CONNECTIONS

## 2.3.3 Using HDMI Video Input

Connect one end of an HDMI cable to the HDMI1 IN/ HDMI2 IN connector of the LCD display and the other end of an HDMI cable to the HDMI out connector of the video player (DVR/VCR/VCD).

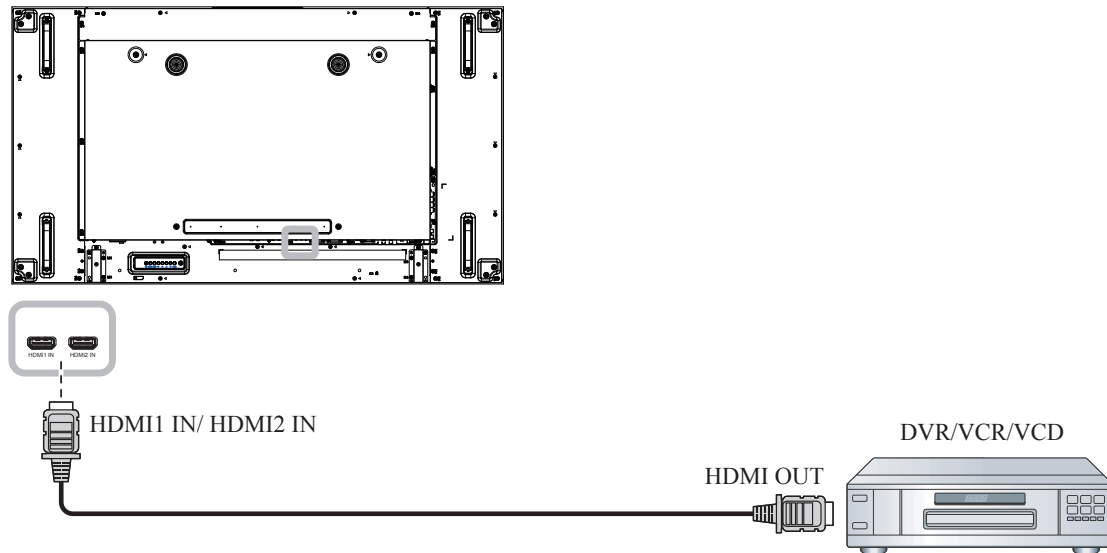

## 2.4 Connecting Audio Equipment

### 2.4.1 Connecting External Speakers

Press the Speaker Switch and connect the speakers cables to the EXT. Speaker Terminal of the LCD display.

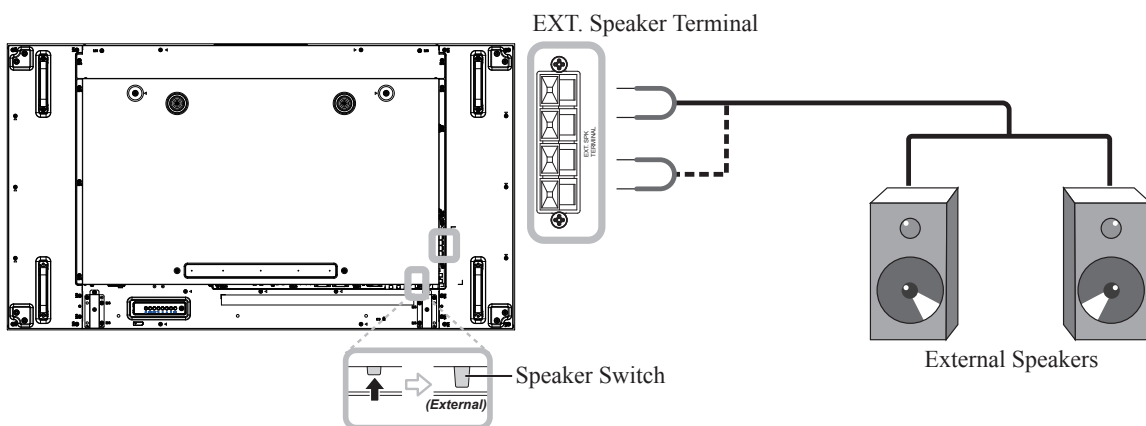

# MAKING CONNECTIONS

## 2.4.2 Connecting an External Audio Device

Connect one end of an audio cable to the AUDIO OUT connector of the LCD display and the other end of an audio cable to the AUDIO IN connector of the audio device.

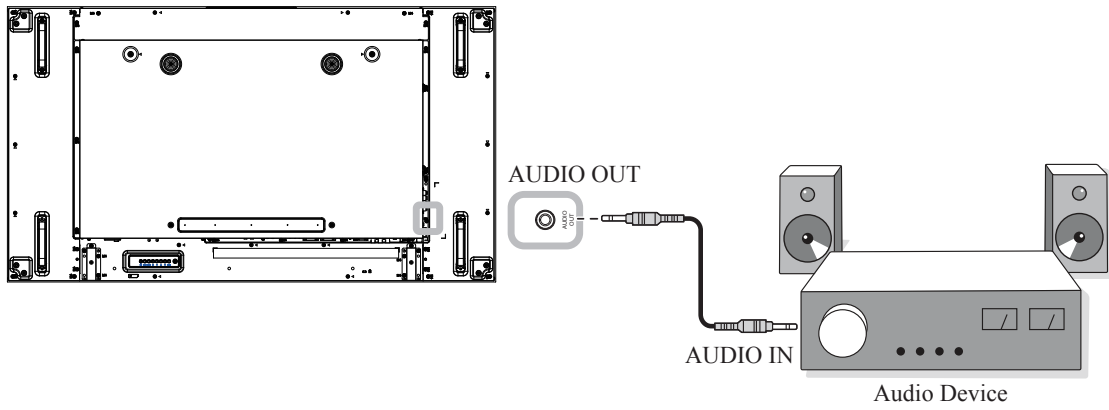

# MAKING CONNECTIONS

## 2.5 Connecting Multiple Displays in a Daisy-chain Configuration

You can interconnect multiple displays to create a daisy-chain configuration for applications such as a video wall.

### Caution:

To avoid unnecessary strain on the bezel, it is highly recommended to keep a minimum space of 0.5mm in which a business card is able to slip between all displays on all sides.

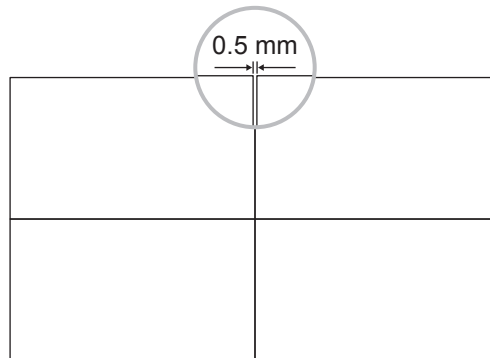

### 2.5.1 Display Control Connection

Connect the RS232C OUT connector of DISPLAY 1 to the RS232C IN connector of DISPLAY 2.

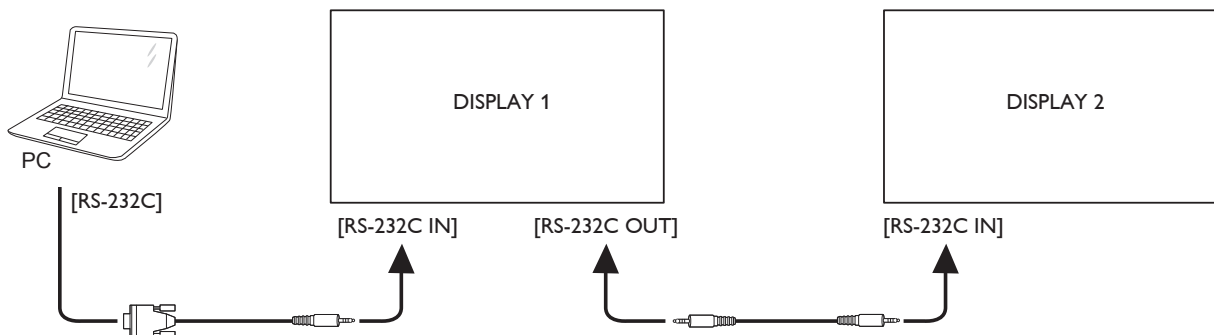

### 2.5.2 Digital Video Connection

Connect the DVI OUT / VGA OUT connector of DISPLAY 1 to the DVI IN connector of DISPLAY 2.

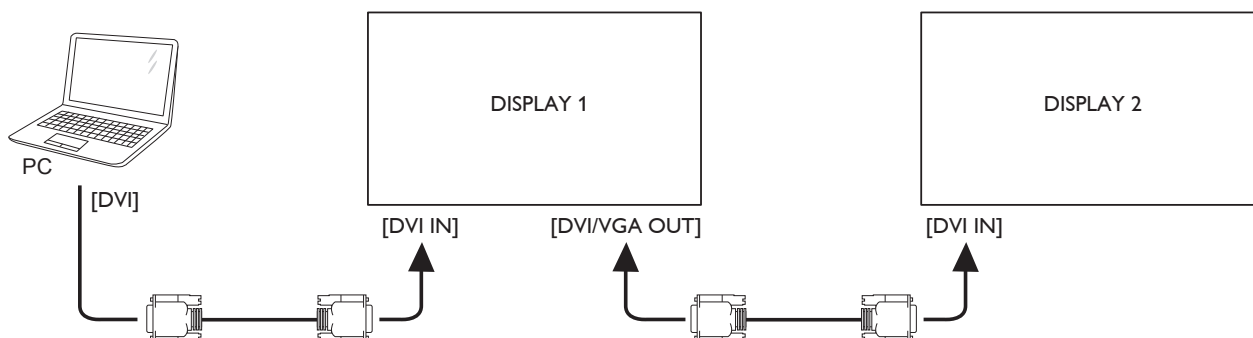

# MAKING CONNECTIONS

Connect the DisplayPort OUT connector of DISPLAY 1 to the DisplayPort IN connector of DISPLAY 2.

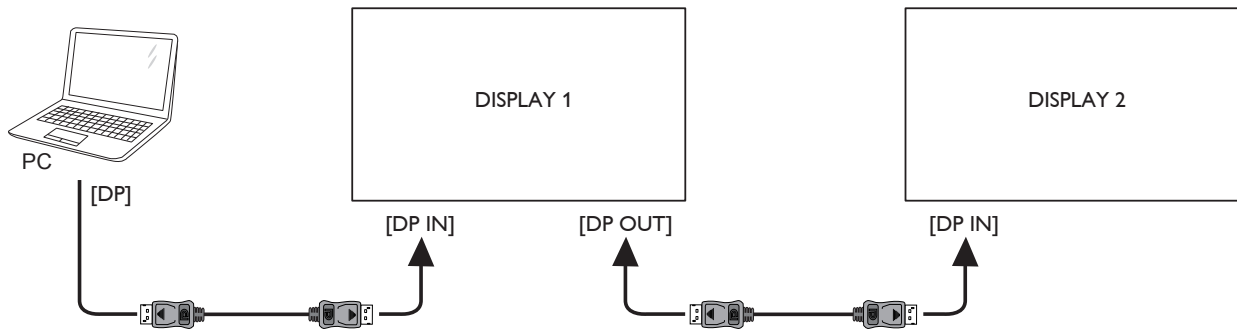

## Note:

- ◆ Before selecting the DisplayPort 1.1a (DP 1.1a) version, make sure the **Tiling > Enable** setting is set to **Off**.
- ◆ When using DP 1.1a, each display will clone the same content as the source.
- ◆ DP 1.2 supports MST up to 4 displays.

Connect the DVI OUT connector of DISPLAY 1 to the DVI IN connector of DISPLAY 2.

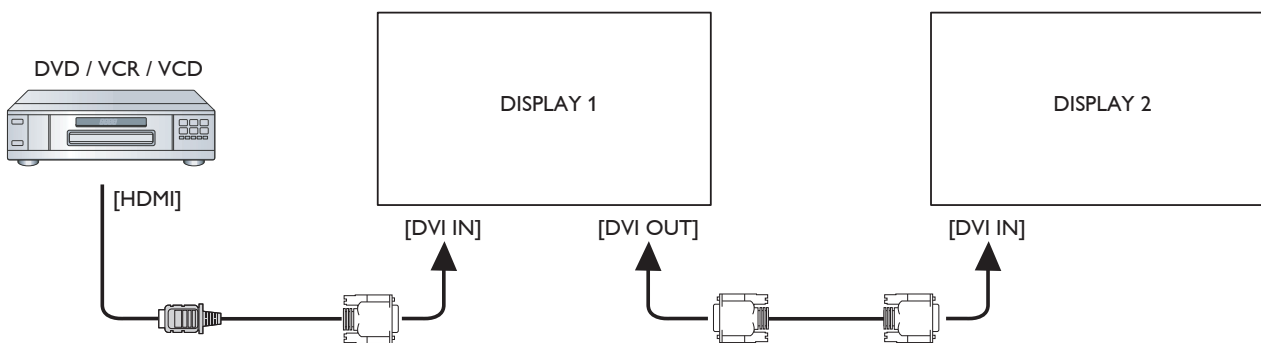

## 2.5.3 Analog Video Connection

Connect the DVI OUT / VGA OUT connector of DISPLAY 1 to the VGA IN connector of DISPLAY 2.

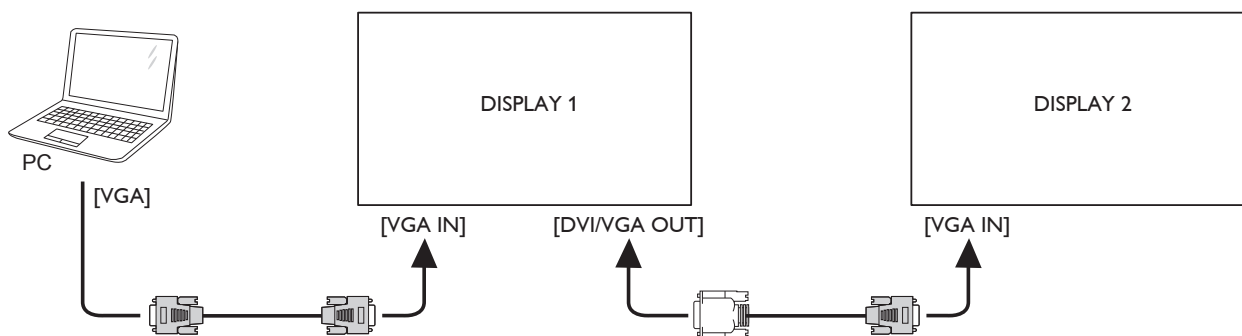



# MAKING CONNECTIONS

## 2.6 IR Connection

Connect the IR sensor cable to the IR IN connector of the LCD display.

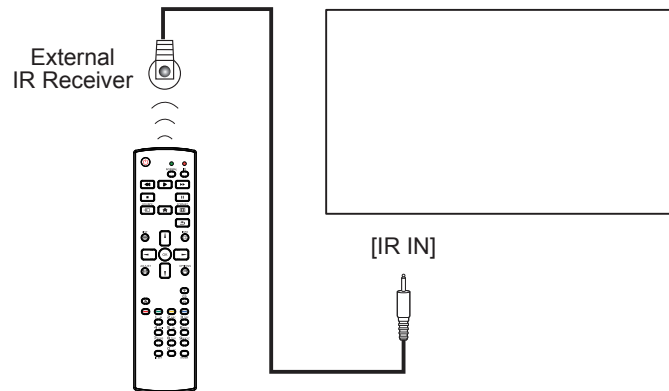

### Note:

- ◆ This display's remote control sensor will stop working if the [IR IN] is connected.

## 2.7 IR Pass-Through Connection

Connect one end of an IR extender cable to the IR OUT connector of the LCD display and the other end of an IR extender cable to the IR IN connector of the video player (DVR/VCR/VCD).

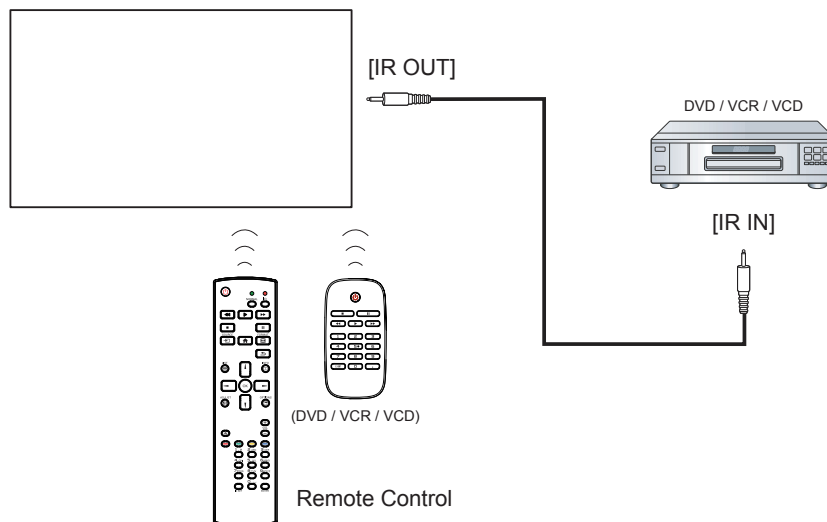

# MAKING CONNECTIONS

## 2.8 Connecting to Wired Network

If you connect this LCD display to a home network, you can play photos, music, and videos from your computer.

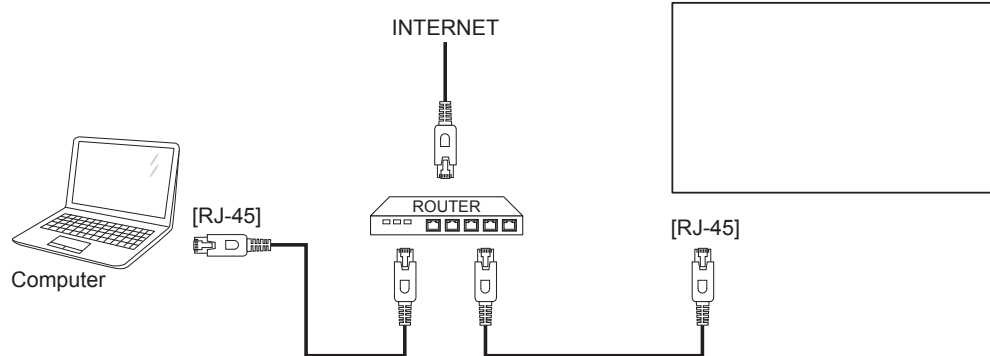

### To setup the network:

- 1 Switch on the router and switch on its DHCP setting.
- 2 Connect the router to the LCD display with an Ethernet cable.
- 3 Press the **Home** button to display the OSD menu.
- 4 Press the **Up** or **Down** button to select **Network settings**. Press the **OK** button to enter its submenu.
- 5 Press the **Up** or **Down** button to select **Network configuration**. Press the **OK** to enter its submenu.
- 6 Press the **Up** or **Down** button to select **DHCP & Auto IP**. Press the **OK** button to confirm.

### Note:

- ◆ Connecting with a shielded CAT-5 Ethernet cable to comply with the EMC directive.
- ◆ To manually configure the network parameters, set the **Network configuration** setting to **Static IP**.

# CHAPTER 3: USING THE LCD DISPLAY

## 3.1 Turning on the Power

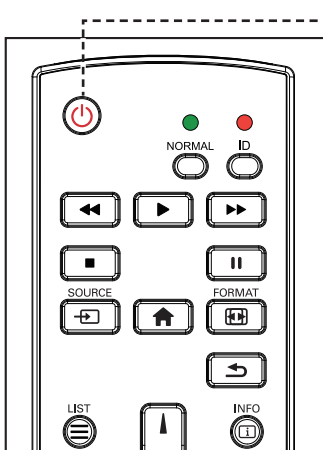

1 Plug the power cord to a power outlet or power supply.

2 Press the  button to turn the LCD display on.

When the LCD display is turned on, press the  button to turn off the LCD display.



### Note:

- ◆ The LCD display still consumes power as long as the power cord is connected to the power outlet. Disconnect the power cord to completely cut off power.

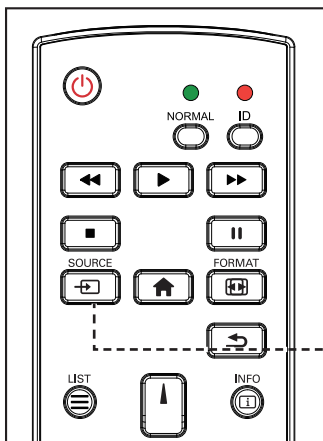
## 3.2 Selecting the Input Source Signal



1 Press the  button.

2 Press the  or  button to choose a device, then press the OK button.

### Note:

- ◆ After pressing the  button, a menu with available input sources will be displayed on the screen.

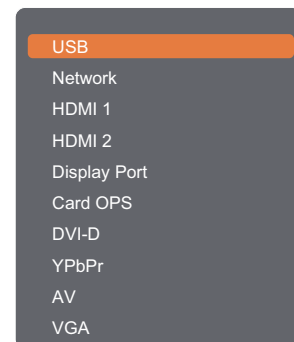

- ◆ If the selected input source signal is not connected to the LCD display or is turned off, the no signal message is displayed on the screen.

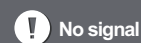

# USING THE LCD DISPLAY

## 3.3 Adjusting the Volume

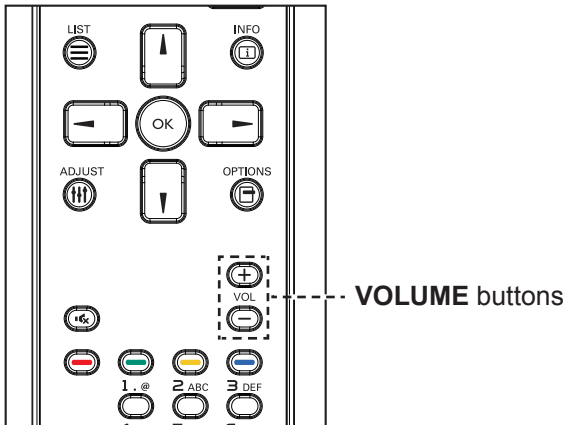

Press the **−** or **+** button to adjust the volume.

### Note:

- ◆ After pressing the **−** or **+** button, the volume icon is displayed on the screen automatically.



- ◆ Press the **MUTE** button to mute the audio.

## 3.4 Changing the Picture Format

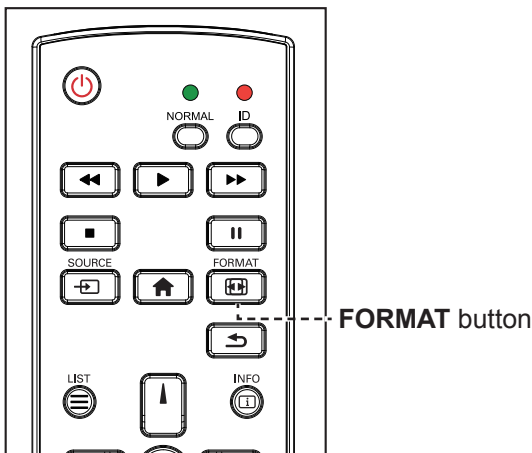

1 Press the **FORMAT** button.

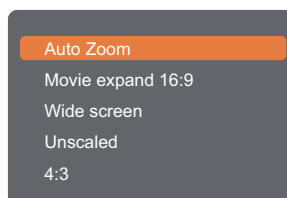

2 Press the **▲** or **▼** button to choose a picture format, then press the **OK** button.

### Note:

The available picture formats include:

- ◆ **Auto zoom:** Enlarge the picture to fill the screen. Recommended for minimal screen distortion but not for HD or PC.
- ◆ **Movie expand 16:9:** Scale 4:3 format to 16:9. Not recommended for HD or PC.
- ◆ **Wide screen:** Shows wide screen format content unstretched. Not recommended for HD or PC.
- ◆ **Unscaled:** Provide maximum detail for PC. Only available when PC mode is selected in the Picture menu.
- ◆ **4:3:** Display the classic 4:3 format.

# USING THE LCD DISPLAY

## 3.5 Choosing Your Preferred Picture Settings

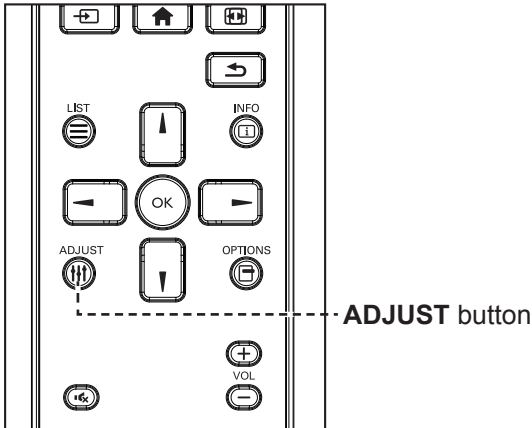

- 1 While this display is playing video source, press the button.
- 2 Press the or button to choose **Picture style**, then press the **OK** button.
- 3 Press the or button to choose an option, then press the **OK** button.

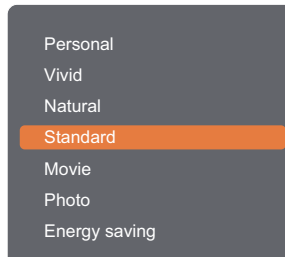

### Note:

The available picture styles include:

- ◆ **Personal:** Apply your personalised picture settings.
- ◆ **Vivid:** Rich and dynamic settings, ideal for daytime viewing.
- ◆ **Natural:** Natural picture settings.
- ◆ **Standard:** Default settings that suit most environments and types of video.
- ◆ **Movie:** Ideal settings for movies.
- ◆ **Photo:** Ideal settings for photos.
- ◆ **Energy saving:** Settings that conserve the most energy.

## 3.6 Choosing Your Preferred Sound Settings

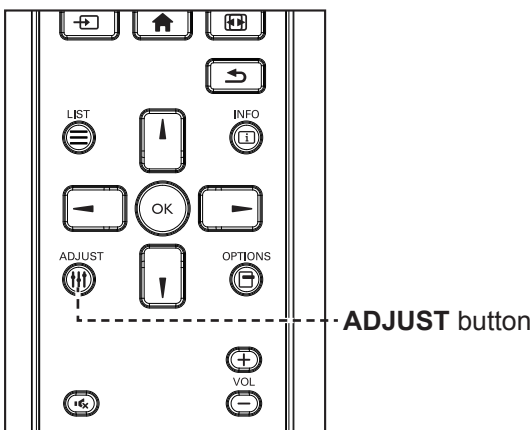

- 1 While this display is playing video source, press the button.
- 2 Press the or button to choose **Sound style**, then press the **OK** button.
- 3 Press the or button to choose an option, then press the **OK** button.

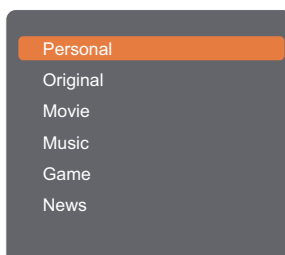

### Note:

The available sound settings include:

- ◆ **Personal:** Apply your personalised sound settings.
- ◆ **Original:** Settings that suit most environments and types of audio.
- ◆ **Movie:** Ideal settings for movies.
- ◆ **Music:** Ideal settings for listening to music.
- ◆ **Game:** Ideal settings for games.
- ◆ **News:** Ideal settings for spoken audio, such as the news.

# USING THE LCD DISPLAY

## 3.7 Playing Multimedia Files via Local Area Network

To play files via Local Area Network, you will need:

- A wired home network, connected with a Universal Plug and Play (uPnP) router.
- Optional: A LAN cable that connects your display to your home network.
- A media server running on your computer.
- Appropriate settings on your computer firewall to allow you to run the media server.

### 3.7.1 Set Up the Network

- 1 Connect your display and the computer to the same home network. See illustration below to connect your display to a network.
- 2 Switch on your computer and the router.
  - Single display setup:

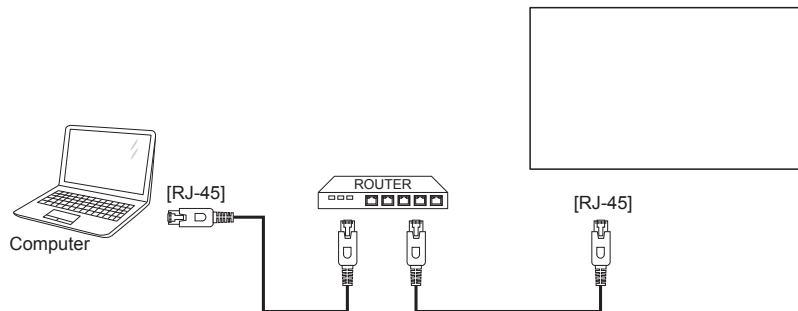

- Multiple display setup:

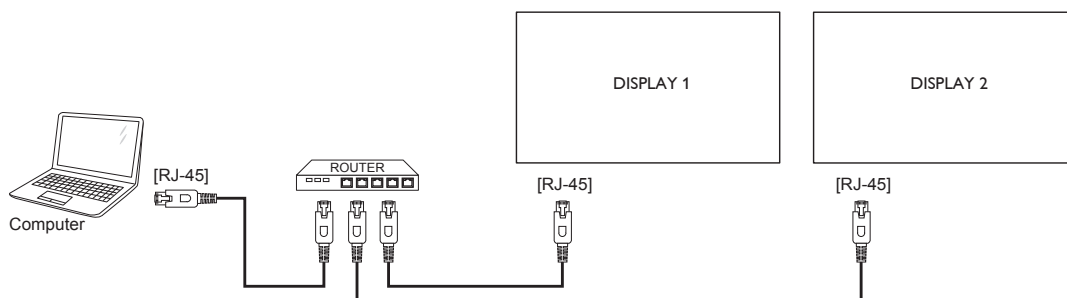

#### Note:

- ◆ If the apparatus does not return to DLNA mode due to external electrical disturbances (e.g. electrostatic discharge), user intervention is required.

# USING THE LCD DISPLAY

## Set Up Media Sharing

- 1 Install a media server on your computer to share media files. These are some media servers:
  - For PC: Windows Media Player 11 (or higher) or TVersity
  - For Mac: Twonky
- 2 Switch on media sharing on your computer using the media server. For more information on how to set up the media server, refer to the website of the media server.



## 3.7.2 How to Use DLNA-DMP

- 1 Please connect display and your PC to the same router via RJ-45.
- 2 Run windows media player. Set stream handling as public sharing.

## Play Files from Display

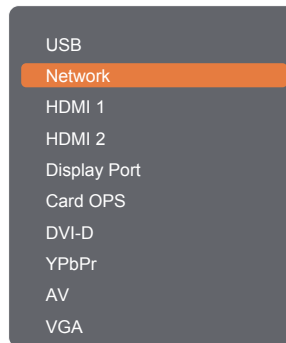
- 1 Press the  button, choose network and press the **OK** button.



- 2 Now, you can see all the PC's connected to the same router on the screen. Choose the right one.
- 3 Press the  or  button to choose the directory and files to play.
- 4 You can connect up to 4 displays to the same PC and play same media stream.

We suggest to use DLNA-DMP function via wired network for the sake of higher security and sufficient network bandwidth.

# USING THE LCD DISPLAY

## 3.7.3 How to Use DLNA-DMR from PC

- 1 Press the  button. Then choose **Network settings** and press the OK button.

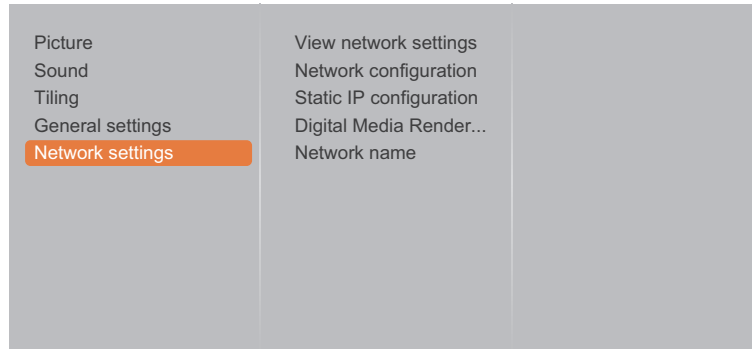

- 2 Set the **Digital Media Renderer -DMR** setting to **On**.

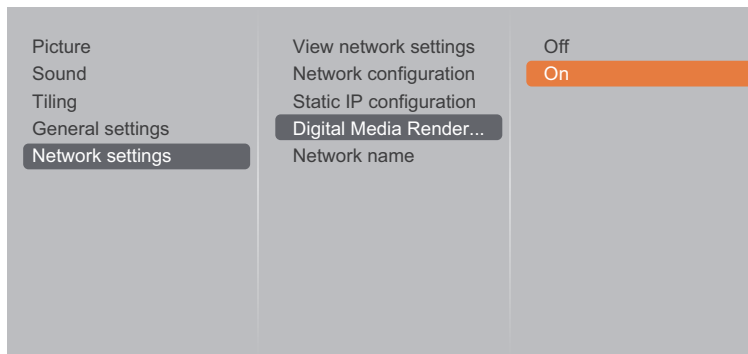

- 3 Set the name of your display.

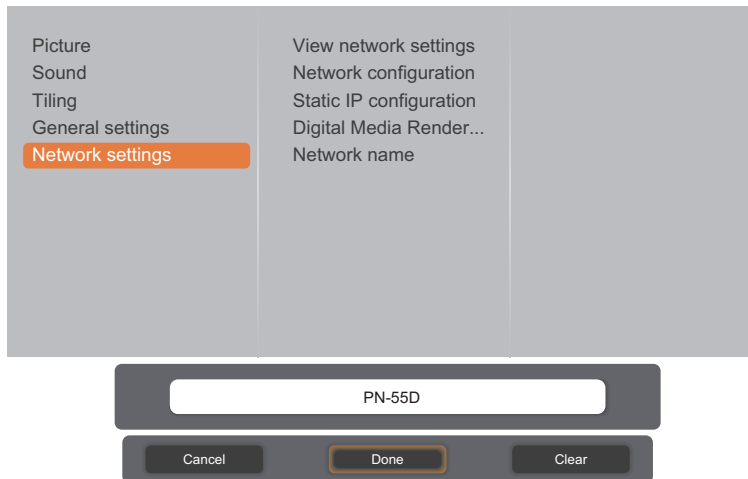







- 4 Press the  button, choose **Network** and press the OK button.
- 5 On your PC, go to **Network and Sharing Center**, and click **Choose homegroup and sharing options**.
- 6 Check the media formats. Then, click **Choose media streaming options.....**
- 7 Go to **Advanced sharing settings**, and check **Turn on network discovery**.



# USING THE LCD DISPLAY

- 8 Now, go to the directory of your media files. Choose the media file by right click. On the submenu from **Play To**, You can find all displays connected to your network. Choose the display, and click the media file to play.

## Play Files

- 1 Press the  button. Then choose **Network** and press the **OK** button.
- 2 Choose a file from the content browser, and press the **OK** button to start playing.
- 3 Press the **PLAY** buttons ( , , , ,  ) on the remote control to control the media playback.

## Tips:

- Choose the top bar to filter your files by type.
- Choose **Sort** to arrange the files by album name, artist, or other fields.
- To clear the list of offline media servers, press the  button. Then, choose **Clear offline servers** and press the **OK** button.





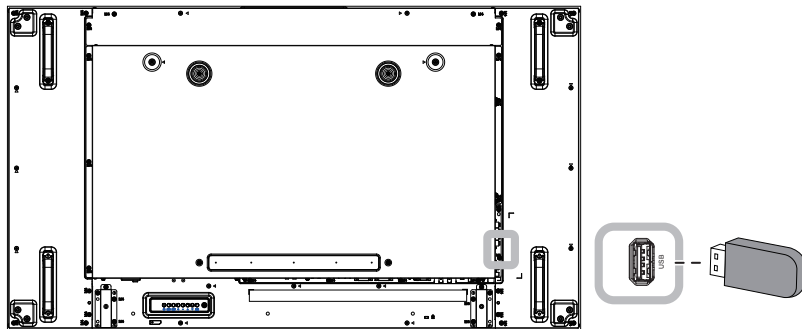

## 3.8 Playing Multimedia Files from USB Device

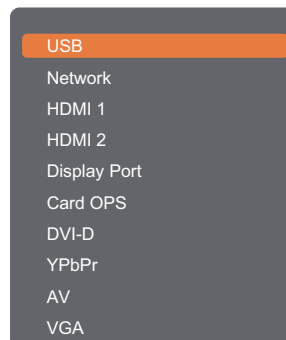
- 1 Connect your USB device to the USB connector on the LCD display.



- 2 Press the  button. Then choose **USB**, and press the **OK** button.



- 3 The connected USB device is detected automatically for all its playable files, which will be automatically sorted into 3 types:  Music,  Movie, and  Photo.
- 4 Press the  button to go up to the top layer in the screen. Press the  or  button to choose the file type. Press the **OK** button to enter its play list.

# USING THE LCD DISPLAY



- 5 Choose the file you want. Press the **OK** button to start playing.
- 6 Follow the on-screen instructions to control the play option.
- 7 Press the **PLAY** buttons ( ◀▶ , ▶▶ , ▶▶▶ , ■ , || ) on the remote control to control the media playback.

## 3.9 Play Options

### 3.9.1 Playing Music Files

- 1 Choose  **Music** in the top bar.





- 2 Choose one music track, and press the **OK** button.
  - To play all the tracks in a folder, choose one music file. Then, press the  button to **Play All**.
  - To view USB device, press the  button.
  - To skip to the next or previous track, press the ▲ or ▼ button.
  - To pause the track, press the **OK** or || button. Press the **OK** or || button again to resume playback.
  - To skip backward or forward 10 seconds, press the ◀ or ▶ button.
  - To search backward or forward, press the ◀◀ or ▶▶ button, press repeatedly to toggle between different speeds.
  - To stop the music, press the ■ button.

### Music options

While you play music, press the  button, then use the ▲, ▼, ◀, or ▶ to choose an option. Then press the **OK** button to select an option:

- **Shuffle**: Enable or disable random play of tracks.
- **Repeat**: Choose **Repeat** to play a track or an album repeatedly, or choose **Play Once** to play a track once.

#### Note:

- ◆ To view information about a song (for example, title, artist or duration), choose the song, then press the  button. To hide the information, press the  button again.









# USING THE LCD DISPLAY

## 3.9.2 Playing Movie Files





- 1 Choose  **Movie** in the top bar.



- 2 Choose a video, and press the OK button.

- To play all the videos in a folder, choose one video file. Then, press the  button to **Play All**.
- To view USB device, the  button.
- To pause the video, press the OK or  button. Press the OK or  button again to resume playback.
- To skip backward or forward 10 seconds, press the  or  button.
- To search backward or forward, press the  or  button, press repeatedly to toggle between different speeds.
- To stop the video, press the  button.

### Movie options

While playing video, press the  button, then use , , , or  to choose an option. Then press the OK button to select an option:

- **Subtitles:** Choose the available subtitle settings.
- **Subtitle language:** Choose the language for subtitles if available.
- **Shuffle:** Enable or disable random play of video files.
- **Repeat:** Choose **Repeat** to play the video file repeatedly or **Play Once** to play the video file once.
- **Status:** To view information about a video (for example, title, size, date, or sound mode).

# USING THE LCD DISPLAY

## 3.9.3 Playing Photo Files



- 1 Choose  **Photo** in the top bar.



- 2 Choose a photo thumbnail, then press the **OK** button.

### Start a Slideshow

If there are multiple photos in a folder, choose a photo. Then, press the  button to **Play All**.

- To skip to the previous or next photo, press the  or  button, and then press the **OK** button.
- To stop the slideshow, press the  button.

### Slideshow options

While you play a slideshow, press the  button, then press the **OK** button to choose an option:



- **Shuffle**: Enable or disable random display of pictures in the slideshow.
- **Repeat**: Choose **Repeat** to watch a slideshow repeatedly or **Play Once** to watch once.
- **Slideshow Time**: Choose the displaying time for each photo in the slideshow.
- **Slideshow Transitions**: Choose the transition from one photo to the next.

# CHAPTER 4: ON SCREEN DISPLAY MENU

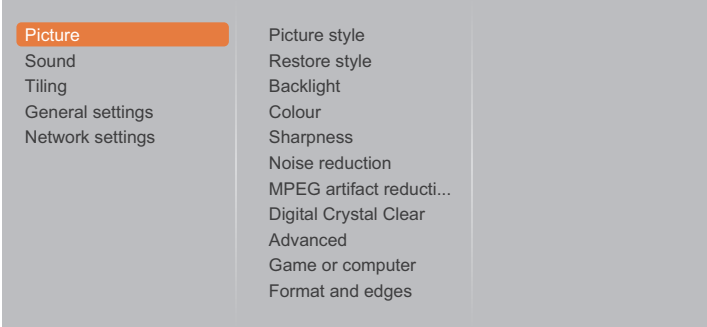
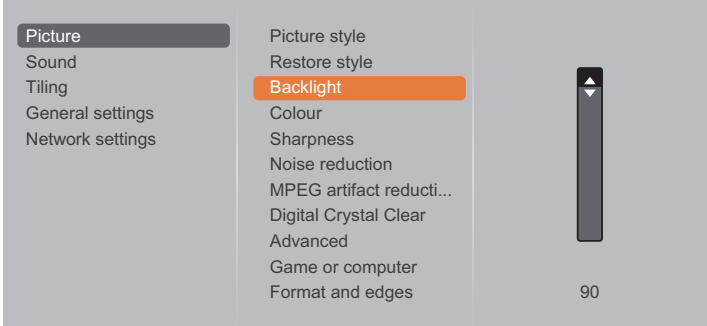
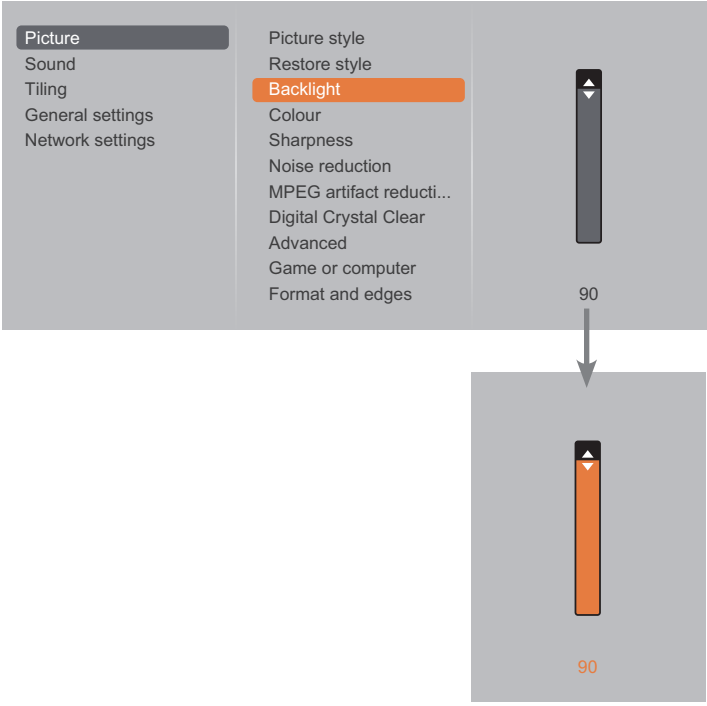
## 4.1 Using the OSD Menu

#	Menu Navigation	Operation	
		Control Panel	Remote Control
1	<p>Display the main menu screen.</p> 	<p>Press the <b>MENU</b> button.</p>	<p>Press the <b>HOME</b> button.</p>
2	<p>Enter the submenu.</p>  <p>The highlighted item (orange) indicates the active submenu.</p>	<ol style="list-style-type: none"> <li>1 Press the <b>▲</b> or <b>▼</b> button to select the menu item.</li> <li>2 Press the <b>INPUT</b> button to enter the submenu.</li> </ol>	<ol style="list-style-type: none"> <li>1 Press the <b>↓</b> or <b>↑</b> button to select the menu item.</li> <li>2 Press the <b>OK</b> or <b>▶</b> button to enter the submenu.</li> </ol>
3	<p>Adjust the settings.</p> <p>The highlighted item indicates the active submenu.</p> <p>For example:</p> 	<ol style="list-style-type: none"> <li>1 Press the <b>▲</b>, <b>▼</b>, <b>+</b>, or <b>-</b> button to adjust the value of the menu item.</li> <li>2 Press the <b>INPUT</b> button to confirm.</li> </ol>	<ol style="list-style-type: none"> <li>1 Press the <b>↓</b>, <b>↑</b>, <b>←</b>, or <b>→</b> button to adjust the value of the menu item.</li> <li>2 Press the <b>OK</b> button to confirm.</li> </ol>

# ON SCREEN DISPLAY MENU

#	Menu Navigation	Operation	
		Control Panel	Remote Control
<b>4</b>	Exit the submenu.	Press the <b>INPUT</b> button to return to the previous menu.	Press the  or  button to return to the previous menu.
<b>5</b>	Close the OSD window.	Press the <b>MENU</b> button again.	Press the  button again.

When settings are modified, all changes are saved when the user does the following:

- Proceeds to the another menu.
- Exits the OSD menu.
- Waits for the OSD menu to disappear.

## Note:

- ◆ Availability of some menu items depend on the input source signal. If the menu is not available, it is disabled and grayed out.

# ON SCREEN DISPLAY MENU

## 4.2 OSD Menu Tree

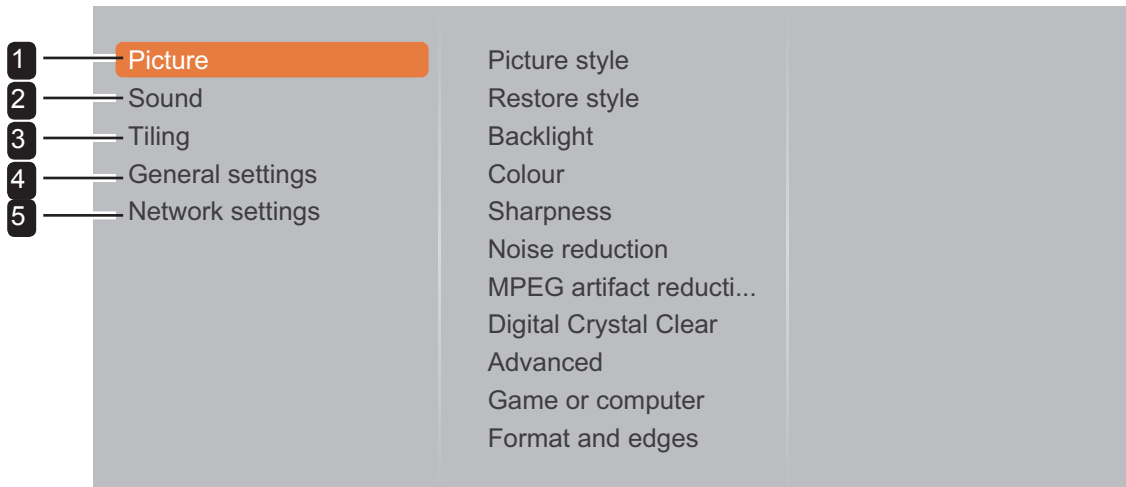

Main Menu	Submenu	Remarks
1. Picture	<ul style="list-style-type: none"> <li>• Picture style</li> <li>• Restore style</li> <li>• Backlight</li> <li>• Colour</li> <li>• Sharpness</li> <li>• Noise reduction</li> <li>• MPEG artifact reduction</li> <li>• Digital Crystal Clear</li> <li>• Advanced</li> <li>• Game or computer</li> <li>• Format and edges</li> </ul>	See page 45.
2. Sound	<ul style="list-style-type: none"> <li>• Sound style</li> <li>• Restore style</li> <li>• Bass</li> <li>• Treble</li> <li>• Balance</li> <li>• Surround mode</li> <li>• Audio out</li> <li>• Advanced</li> </ul>	See page 48.

# ON SCREEN DISPLAY MENU

Main Menu	Submenu	Remarks
3. Tiling	<ul style="list-style-type: none"> <li>• Enable</li> <li>• H monitors</li> <li>• V monitors</li> <li>• Position</li> <li>• Frame comp.</li> </ul>	See page 50.
4. General settings	<ul style="list-style-type: none"> <li>• Menu language</li> <li>• Monitor ID</li> <li>• Eco mode</li> <li>• Auto search</li> <li>• Clock</li> <li>• Scheduling</li> <li>• Sleep timer</li> <li>• EasyLink</li> <li>• Auto Adjust</li> <li>• Local KB lock</li> <li>• RC lock</li> </ul>	See page 52.
5. Network settings	<ul style="list-style-type: none"> <li>• View network settings</li> <li>• Network configuration</li> <li>• Static IP configuration</li> <li>• Digital Media Renderer - DMR</li> <li>• Network name</li> </ul>	See page 60.



# CHAPTER 5: ADJUSTING THE LCD DISPLAY



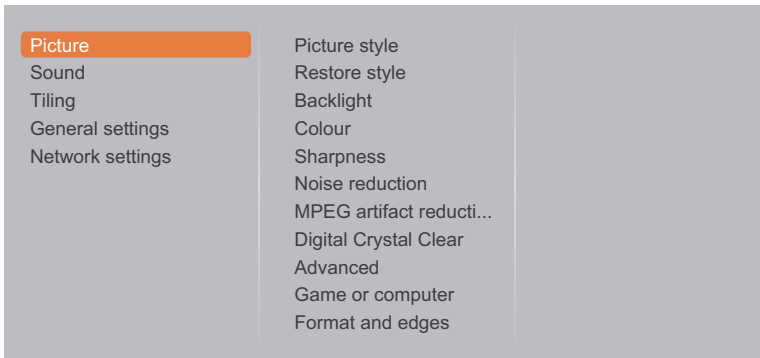



## 5.1 Picture Settings













- 1 Press the **MENU** button on the control panel or the **HOME** button on the remote control to call out the OSD window.
- 2 Select **Picture**, then press the **INPUT** button on the control panel or the **OK** button on the remote control.
- 3 Press the **▲/▼** button on the control panel or the **▲/▼** button on the remote control to select an option.

Item	Function	Operation	Range
Picture style	Choose a predefined picture setting. <b>Note:</b> The default value is <b>Standard</b> .	Press the <b>▲/▼</b> button on the control panel or the <b>▲/▼</b> button on the remote control to select the setting.	Personal Vivid Natural Standard Movie Photo Energy saving
Restore style	Restore the last-selected predefined picture setting.	Press the <b>+/-</b> button on the control panel or the <b>←/→</b> button on the remote control to select the setting.	Yes No
Backlight	Adjust the brightness of this display's backlight. <b>Note:</b> The default value is 90.	Press the <b>▲/▼</b> button on the control panel or the <b>▲/▼</b> button on the remote control to adjust the value.	0 to 100
Colour	Adjust the colour saturation of the picture. <b>Note:</b> The default value is 50.	Press the <b>▲/▼</b> button on the control panel or the <b>▲/▼</b> button on the remote control to adjust the value.	0 to 100
Sharpness	Adjust the clarity and focus of the screen image. <b>Note:</b> The default value is 0.	Press the <b>▲/▼</b> button on the control panel or the <b>▲/▼</b> button on the remote control to adjust the value.	0 to 20
Noise reduction	Adjust the noise reduction to help remove noise from images. This helps produce clearer and crisper images. <b>Note:</b> The default value is <b>Medium</b> .	Press the <b>▲/▼</b> button on the control panel or the <b>▲/▼</b> button on the remote control to select the setting.	Off Minimum Medium Maximum

# ADJUSTING THE LCD DISPLAY

Item	Function	Operation	Range
	<i>Noise Reduction Off</i>	<i>Noise Reduction On</i>	
			
MPEG artifact reduction	<p>Smoothen transitions and haziness in the digital picture.</p> <p><b>Note:</b> The default value is <b>Off</b>.</p>	Press the ▲/▼ button on the control panel or the  button on the remote control to select the setting.	Off On
Digital Crystal Clear	<p>Fine-tune each pixel to match surrounding pixels and produce a brilliant, high-definition image.</p> <ul style="list-style-type: none"> <li>• <b>Advanced sharpness:</b> Enable superior sharpness, especially on lines and contours in the picture. <b>Note:</b> The default value is <b>Off</b>.</li> </ul>	Press the ▲/▼ button on the control panel or the  button on the remote control to select the setting.	Off On
	<ul style="list-style-type: none"> <li>• <b>Dynamic contrast:</b> Enable superior sharpness, especially on lines and contours in the picture. <b>Note:</b> The default value is <b>Off</b>.</li> </ul>	Press the ▲/▼ button on the control panel or the  button on the remote control to select the setting.	Off Minimum Medium Maximum
	<ul style="list-style-type: none"> <li>• <b>Color enhancement:</b> Dynamically enhance the vividness and details of colours. <b>Note:</b> The default value is <b>Medium</b>.</li> </ul>	Press the ▲/▼ button on the control panel or the  button on the remote control to select the setting.	Off Minimum Medium Maximum
Advanced	<p>Access advanced settings such as gamma, color temp., video contrast, brightness, and hue.</p>		
	<ul style="list-style-type: none"> <li>• <b>Gamma:</b> Adjust the non-linear setting for picture luminance and contrast. <b>Note:</b> The default value is 0.</li> </ul>	Press the ▲/▼ button on the control panel or the  button on the remote control to adjust the value.	0 to 4

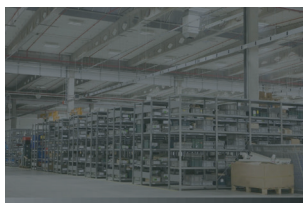
# ADJUSTING THE LCD DISPLAY

Item	Function	Operation	Range
Advanced (continued)	<ul style="list-style-type: none"> <li>• <b>Color temp.:</b> Change the colour balance.                             <ul style="list-style-type: none"> <li>- <u>Cool</u>: Applies a bluish tint for cooler colours.</li> <li>- <u>Normal</u>: commonly used for normal lighting conditions.</li> <li>- <u>Warm</u>: Applies a reddish tint for warmer colours.</li> <li>- <u>Custom</u>: When selected, the user can adjust manually the values of Cool, Normal, and Warm in Custom tint menu.</li> </ul> </li> </ul> <p><b>Note:</b> The default value is <b>Cool</b>.</p>	Press the ▲/▼ button on the control panel or the  button on the remote control to select the setting.	Cool Normal Warm Custom
	<ul style="list-style-type: none"> <li>• <b>Custom tint:</b> Customise colour balance setting. Only available if <b>Color temp.</b> setting is set to <b>Custom</b>.</li> </ul> <p><b>Note:</b> The default value of <b>Cool</b>, <b>Normal</b>, and <b>Warm</b> setting is 128.</p>	Press the ▲/▼ button on the control panel or the  button on the remote control to adjust the value.	0 to 255
	<ul style="list-style-type: none"> <li>• <b>Video contrast:</b> Adjust video black level and white level.</li> </ul> <p><b>Note:</b> The default value is 100.</p>	Press the ▲/▼ button on the control panel or the  button on the remote control to adjust the value.	0 to 100
	<div style="display: flex; justify-content: space-around;"> <div style="text-align: center;"> <p><b>Original Setting</b></p>  </div> <div style="text-align: center;"> <p><b>High Setting</b></p>  </div> <div style="text-align: center;"> <p><b>Low Setting</b></p>  </div> </div>		
	<ul style="list-style-type: none"> <li>• <b>Brightness:</b> Adjust the luminance of the screen image.</li> </ul> <p><b>Note:</b> The default value is 50.</p>	Press the ▲/▼ button on the control panel or the  button on the remote control to adjust the value.	0 to 100
	<div style="display: flex; justify-content: space-around;"> <div style="text-align: center;"> <p><b>Original Setting</b></p>  </div> <div style="text-align: center;"> <p><b>High Setting</b></p>  </div> <div style="text-align: center;"> <p><b>Low Setting</b></p>  </div> </div>		
	<ul style="list-style-type: none"> <li>• <b>Hue:</b> Adjust the color balance of red and green.</li> </ul> <p><b>Note:</b> The default value is 0.</p>	Press the ▲/▼ button on the control panel or the  button on the remote control to adjust the value.	-50 to 50

# ADJUSTING THE LCD DISPLAY

Item	Function	Operation	Range
Game or computer	<ul style="list-style-type: none"> <li>• <b>Game:</b> Choose when viewing content from a connected game console.</li> <li>• <b>Computer:</b> Choose when a computer is connected through HDMI.</li> </ul> <p>Make sure that <b>Format and edges &gt; Picture format &gt; Unscaled</b> is selected so as to view maximum detail.</p> <p><b>Note:</b> The default value is <b>Off</b>.</p>	Press the ▲/▼ button on the control panel or the <b>M/</b> button on the remote control to select the setting.	Off Game Computer
Format and edges	<ul style="list-style-type: none"> <li>• <b>Picture format:</b> Choose the picture format depending on the displayed content.</li> </ul> <p><b>Note:</b> The default value is <b>Auto zoom</b>.</p>	Press the ▲/▼ button on the control panel or the <b>M/</b> button on the remote control to select the setting.	Auto zoom Movie expand 16:9 Wide screen Unscaled 4:3



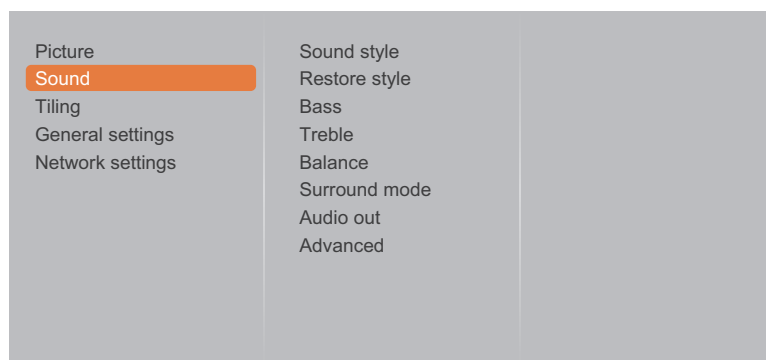





## 5.2 Sound Settings



- 1 Press the **MENU** button on the control panel or the **HOME** button on the remote control to call out the OSD window.
- 2 Select **Sound**, then press the **INPUT** button on the control panel or the **OK** button on the remote control.
- 3 Press the ▲/▼ button on the control panel or the **M/** button on the remote control to select an option.

Item	Function	Operation	Range
Sound style	Choose the sound style for the audio content. <b>Note:</b> The default value is <b>Personal</b> .	Press the ▲/▼ button on the control panel or the <b>M/</b> button on the remote control to select the setting.	Personal Original Movie Music Game News
Restore style	Restore the last-selected predefined sound setting.	Press the <b>+/-</b> button on the control panel or the <b>←/→</b> button on the remote control to select the setting.	Yes No

# ADJUSTING THE LCD DISPLAY

Item	Function	Operation	Range
Bass	Adjust to increase or decrease lower-pitched sounds. <b>Note:</b> The default value is 0.	Press the ▲/▼ button on the control panel or the  button on the remote control to adjust the value.	-8 to +8
Treble	Adjust to increase or decrease higher-pitched sounds. <b>Note:</b> The default value is 0.	Press the ▲/▼ button on the control panel or the  button on the remote control to adjust the value.	-8 to +8
Balance	Adjust to emphasize left or right audio output balance. <b>Note:</b> The default value is 0.	Press the ▲/▼ button on the control panel or the  button on the remote control to adjust the value.	-8 to +8
Surround mode	Enhance your audio experience. <b>Note:</b> The default value is <b>Off</b> .	Press the ▲/▼ button on the control panel or the  button on the remote control to select the setting.	Off On
Audio out	Adjust audio output volume. <b>Note:</b> The default value is 25.	Press the ▲/▼ button on the control panel or the  button on the remote control to adjust the value.	0 to 60
Advanced	<ul style="list-style-type: none"> <li>• <b>Auto volume leveling:</b> Enable the reduction of sudden volume changes. <b>Note:</b> The default value is <b>On</b>.</li> </ul>	Press the ▲/▼ button on the control panel or the  button on the remote control to select the setting.	On Off
	<ul style="list-style-type: none"> <li>• <b>Speaker settings:</b> Turn on or off the internal speakers. <b>Note:</b> The default value is <b>On</b>.</li> </ul>	Press the ▲/▼ button on the control panel or the  button on the remote control to select the setting.	On Off
	<ul style="list-style-type: none"> <li>• <b>Clear sound:</b> Enhance sound quality. <b>Note:</b> The default value is <b>Off</b>.</li> </ul>	Press the ▲/▼ button on the control panel or the  button on the remote control to select the setting.	On Off

# ADJUSTING THE LCD DISPLAY

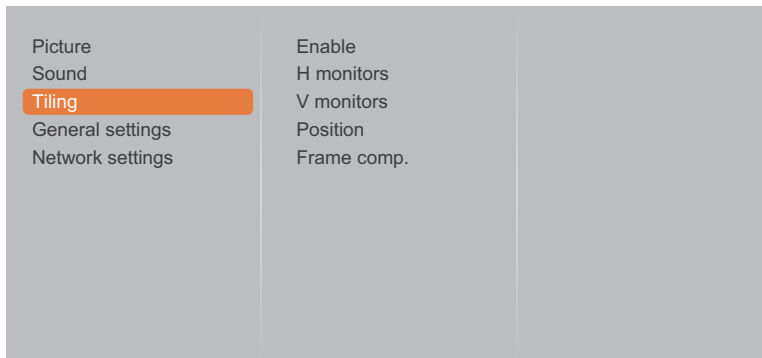

## 5.3 Tiling Settings



- 1 Press the **MENU** button on the control panel or the **⬆** button on the remote control to call out the OSD window.
- 2 Select **Tiling**, then press the **INPUT** button on the control panel or the **OK** button on the remote control.
- 3 Press the **▲/▼** button on the control panel or the **⬆/⬇** button on the remote control to select an option.

Item	Function	Operation	Range
Enable	<p>With this function, you can create a single large-screen matrix (video wall) that consists of up to 100 sets of this display (up to 10-sets on the vertical and 10-sets on the horizontal sides).</p> <p>If tiling is enabled, you can configure the following display settings:</p> <ul style="list-style-type: none"> <li>• <b>H monitors</b></li> <li>• <b>V monitors</b></li> <li>• <b>Position</b></li> <li>• <b>Frame comp.</b></li> </ul> <p><b>Note:</b> The default value is <b>Off</b>.</p>	Press the <b>▲/▼</b> button on the control panel or the <b>⬆/⬇</b> button on the remote control to select the setting.	Off On
H monitors	<p>Adjust displays on the horizontal side.</p> <p><b>Note:</b> The default value is 1.</p>	Press the <b>▲/▼</b> button on the control panel or the <b>⬆/⬇</b> button on the remote control to adjust the value.	0 to 10
V monitors	<p>Adjust displays on the vertical side.</p> <p><b>Note:</b> The default value is 1.</p>	Press the <b>▲/▼</b> button on the control panel or the <b>⬆/⬇</b> button on the remote control to adjust the value.	0 to 10

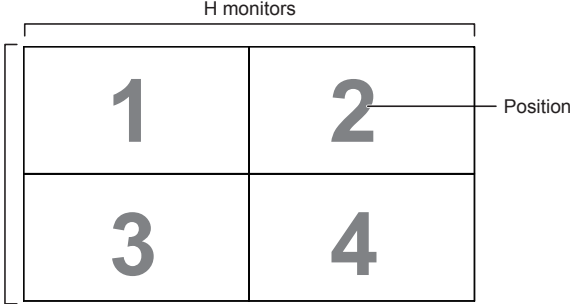

# ADJUSTING THE LCD DISPLAY







Item	Function	Operation	Range
Position	<p>Adjust the position of this display in the screen matrix. Please see the Example1 and Example2 for reference.</p> <p><b>Note:</b> The default value is 1.</p>	<p>Press the ▲/▼ button on the control panel or the ⏪ button on the remote control to adjust the value.</p>	<p>0 to 10</p>
	<p><u>Example1:</u> 2 x 2 screen matrix (4 displays)</p> <ul style="list-style-type: none"> <li>• H monitors = 2 displays</li> <li>• V monitors = 2 displays</li> </ul>  <p><u>Example2:</u> 5 x 5 screen matrix (25 displays)</p> <ul style="list-style-type: none"> <li>• H monitors = 5 displays</li> <li>• V monitors = 5 displays</li> </ul> 		
Frame comp.	<p>If frame compensation is enabled, then the display will adjust the image to compensate for the width of the display bezels in order to accurately display the image.</p> <p><b>Note:</b> The default value is <b>Off</b>.</p>	<p>Press the ▲/▼ button on the control panel or the ⏪ button on the remote control to select the setting.</p>	<p>Off On</p>

# ADJUSTING THE LCD DISPLAY

## 5.4 General Settings

Picture	Menu language
Sound	Monitor ID
Tiling	Eco mode
<b>General settings</b>	Auto search
Network settings	Clock
	Scheduling
	Sleep timer
	EasyLink
	Auto Adjust
	Local KB lock
	RC lock

- 1 Press the **MENU** button on the control panel or the  button on the remote control to call out the OSD window.
- 2 Select **General settings**, then press the **INPUT** button on the control panel or the **OK** button on the remote control.
- 3 Press the  button on the control panel or the  button on the remote control to select an option.

Item	Function	Operation	Range
Menu language	Choose the language used for OSD menus.	Press the  button on the control panel or the  button on the remote control to select the setting.	English German Traditional Chinese French Italian Spanish Russian Polish Turkish Simplified Chinese Portuguese Arabic Japanese
Monitor ID	Adjust the ID number for controlling the display via the RS232C connection. Each display must have a unique ID number when multiple sets of this display are connected. <b>Note:</b> The default value is 1.	Press the  button on the control panel or the  button on the remote control to adjust the value.	1 to 255
Eco mode	Set the LCD display to reduce the power consumption automatically. <b>Note:</b> Factory default setting is <b>Low power standby</b> , but user could not reset it to default after setting Eco mode to <b>Normal</b> by <b>Factory reset</b> in the menu. However, user can still change the ECO mode back to <b>low power standby</b> manually.	Press the  button on the control panel or the  button on the remote control to select the setting.	Normal Low power standby







# ADJUSTING THE LCD DISPLAY

Item	Function	Operation	Range
Auto search	Choose to let this display detect and display available signal sources automatically. <b>Note:</b> The default value is <b>Off</b> .	Press the ▲/▼ button on the control panel or the M button on the remote control to select the setting.	Off On Failover
Clock	Set the current date and time for the display's internal clock.		
	<ul style="list-style-type: none"> <li>• <b>Daylight saving:</b> Choose the daylight saving time.</li> </ul> <b>Note:</b> The default value is <b>Daylight saving</b> .	Press the ▲/▼ button on the control panel or the M button on the remote control to select the setting.	Daylight saving time Standard time
	<ul style="list-style-type: none"> <li>• <b>Date:</b> Set current date.</li> </ul>	<ul style="list-style-type: none"> <li>• Press the ▲/▼ button on the control panel or the M button on the remote control to set month, day, and year.</li> <li>• Press the +/- button on the control panel or the ←/→ button on the remote control to navigate between month, day, and year fields.</li> </ul>	Cancel Done
<ul style="list-style-type: none"> <li>• <b>Time:</b> Set current time.</li> </ul>	<ul style="list-style-type: none"> <li>• Press the ▲/▼ button on the control panel or the M button on the remote control to set hours and minutes.</li> <li>• Press the +/- button on the control panel or the ←/→ button on the remote control to navigate between hours and minutes fields.</li> </ul>	Cancel Done	
Scheduling	<p>This function allows you to program up to 7 different scheduled time intervals for this display to activate.</p> <p>You can set:</p> <ul style="list-style-type: none"> <li>• Which input source the display will use for each scheduled activation period.</li> <li>• The time for the display to turn on and turn off.</li> <li>• The days in a week for the display to activate.</li> </ul> <p><b>Note:</b></p> <ul style="list-style-type: none"> <li>◆ We recommend you to set up current date and time in the <b>Clock</b> menu before using this function.</li> <li>◆ After changing the <b>Clock</b> option in the <b>General settings</b> menu, you need to set this Scheduling again.</li> </ul>		

# ADJUSTING THE LCD DISPLAY

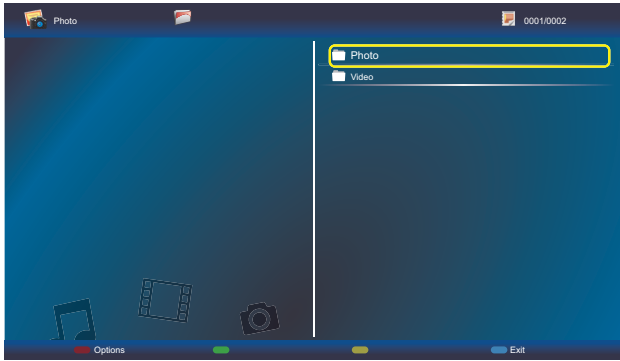
Item	Function	Operation	Range
Scheduling (continued)	<ul style="list-style-type: none"> <li>• <b>Status:</b> Enable or disable the schedule.</li> </ul> <p><b>Note:</b> The default value is <b>Off</b>.</p>	Press the ▲/▼ button on the control panel or the M button on the remote control to select the setting.	Off On
	<ul style="list-style-type: none"> <li>• <b>Source:</b> Choose the source for the schedule.</li> </ul> <p><b>Note:</b> The default value is <b>USB</b>.</p>	Press the ▲/▼ button on the control panel or the M button on the remote control to select the setting.	USB HDMI 1 HDMI 2 Display port Card OPS DVI-D YPbPr AV VGA
	<ul style="list-style-type: none"> <li>• <b>On time:</b> Set time when the schedule is turned on.</li> </ul>	<ul style="list-style-type: none"> <li>• Press the ▲/▼ button on the control panel or the M button on the remote control to set hours and minutes.</li> <li>• Press the +/- button on the control panel or the ←/→ button on the remote control to navigate between hours and minutes fields.</li> </ul>	Cancel Done
	<ul style="list-style-type: none"> <li>• <b>Off time:</b> Set time when the schedule is turned off.</li> </ul>	<ul style="list-style-type: none"> <li>• Press the ▲/▼ button on the control panel or the M button on the remote control to set hours and minutes.</li> <li>• Press the +/- button on the control panel or the ←/→ button on the remote control to navigate between hours and minutes fields.</li> </ul>	Cancel Done
	<ul style="list-style-type: none"> <li>• <b>Repeat modes:</b> Choose the days in a week when the schedule is activated.</li> </ul> <p><b>Note:</b> The default value is <b>No repeat</b>.</p>	<ul style="list-style-type: none"> <li>• Press the ▲/▼ button on the control panel or the M button on the remote control to select the item.</li> <li>• Press the <b>INPUT</b> button on the control panel or the <b>OK</b> button on the remote control to confirm the selection.</li> </ul>	No repeat Every Sunday Every Monday Every Tuesday Every Wednesday Every Thursday Every Friday Every Saturday

# ADJUSTING THE LCD DISPLAY

Item	Function	Operation	Range
Scheduling (continued)	<ul style="list-style-type: none"> <li>• <b>Play setting:</b> Choose the file to be included in the playlist.</li> </ul> <p><b>Note:</b></p> <ul style="list-style-type: none"> <li>◆ Each playlist supports up to 30 files.</li> <li>◆ Playlist will not be cleared after <b>Factory settings</b>. You have to manually remove the files or delete <i>usb_schedulinglist.txt</i> on the USB disk drive.</li> </ul>	<ul style="list-style-type: none"> <li>• Press the ▲/▼ button on the control panel or the ⏮/⏭ button on the remote control to choose the file.</li> <li>• Press the <b>INPUT</b> button on the control panel or the <b>OK</b> button on the remote control to set or clear the playlist.</li> </ul>	
		<p style="text-align: center;"><b>Playlist View</b></p>  <ul style="list-style-type: none"> <li>• Press the  button on the remote control, then select <b>Save list</b> to save the playlist.</li> <li>• Press the  button on the remote control to exit Playlist and return to the OSD menu.</li> </ul> <p style="text-align: center;"><b>Save List</b></p> 	
Sleep timer	Switch off the display after a specified time. <b>Note:</b> The default value is <b>Off</b> .	Press the ▲/▼ button on the control panel or the ⏮/⏭ button on the remote control to select the setting.	Off 5 mins 10 mins 15 mins ... 240 mins
EasyLink	Connect and control your HDMI-CEC compliant devices through HDMI port to this display with the same remote control. <b>Note:</b> The default value is <b>Off</b> .	Press the ▲/▼ button on the control panel or the ⏮/⏭ button on the remote control to select the setting.	Off On

# ADJUSTING THE LCD DISPLAY

Item	Function	Operation	Range
Auto adjust	<p>Use this function to automatically optimize the display of VGA input image.</p> <p><b>Note:</b> This option is available only if the input source is VGA.</p>	Press the <b>+/-</b> button on the control panel or the <b>←/→</b> button on the remote control to select the setting.	Cancel Start
Local KB lock	<p>Choose to enable or disable the keyboard (control panel buttons) function of the LCD display.</p> <ul style="list-style-type: none"> <li>• <b>Unlock:</b> Enable the keyboard function.</li> <li>• <b>Lock all:</b> Lock all keyboard function.</li> <li>• <b>Lock but volume:</b> Disable all the keyboard function except the <b>+</b> or <b>-</b> button.</li> <li>• <b>Lock but power:</b> Disable all the keyboard function except the <b>⏻</b> button.</li> <li>• <b>Lock all except volume and power:</b> Disable all the keyboard function except the <b>+</b>, <b>-</b>, or <b>⏻</b> button.</li> </ul> <p><b>Note:</b></p> <ul style="list-style-type: none"> <li>◆ To disable the Local KB lock function, press the <b>⬆</b> button and buttons <b>1 9 9 8</b> on the remote control.</li> <li>◆ The default value is <b>Unlock</b>.</li> </ul>	Press the <b>▲/▼</b> button on the control panel or the <b>⬆/⬇</b> button on the remote control to select the setting.	Unlock Lock all Lock but volume Lock but power Lock all except volume and power

# ADJUSTING THE LCD DISPLAY

Item	Function	Operation	Range
RC lock	<p>Choose to enable or disable the button function of the remote control.</p> <ul style="list-style-type: none"> <li>• <b>Unlock:</b> Enable the button function of the remote control.</li> <li>• <b>Lock all:</b> Lock all button functions of the remote control.</li> <li>• <b>Lock but volume:</b> Disable all the button functions except the <b>—</b> or <b>+</b> button.</li> <li>• <b>Lock but power:</b> Disable all the button functions except the <b>⏻</b> button.</li> <li>• <b>Lock all except volume and power:</b> Disable all the button functions of the remote control except the <b>—</b>, <b>+</b>, or <b>⏻</b> button.</li> </ul> <p><b>Note:</b></p> <ul style="list-style-type: none"> <li>◆ To disable the RC lock function, press the <b>⬆</b> button and buttons <b>1 9 9 8</b> on the remote control.</li> <li>◆ The default value is <b>Unlock</b>.</li> </ul>	<p>Press the <b>▲/▼</b> button on the control panel or the <b>⏻</b> button on the remote control to select the setting.</p>	<p>Unlock Lock all Lock but volume Lock but power Lock all except volume and power</p>
ANTI-BURN-IN	<p>For video input sources, enable ANTI-BURN-IN function to protect the display from “burn-in” or “after-image” symptoms when the display is not being in use for 30 seconds.</p> <p><b>Note:</b> The default value is <b>Off</b>.</p>	<p>Press the <b>▲/▼</b> button on the control panel or the <b>⏻</b> button on the remote control to select the setting.</p>	<p>Off On</p>
Smart power	<p>Choose a backlight level to optimise dynamic power consumption and picture contrast.</p> <p><b>Note:</b> The default value is <b>Off</b>.</p>	<p>Press the <b>▲/▼</b> button on the control panel or the <b>⏻</b> button on the remote control to select the setting.</p>	<p>Off Standard Best Power Best Picture</p>
Wake on lan	<p>Enable this feature to allow the display to be switched on over the network.</p> <p><b>Note:</b> The default value is <b>Off</b>.</p>	<p>Press the <b>▲/▼</b> button on the control panel or the <b>⏻</b> button on the remote control to select the setting.</p>	<p>Off On</p>
Switch on state	<p>Choose the display status used for the next time you connect the power cord.</p> <p><b>Note:</b> The default value is <b>Last status</b>.</p>	<p>Press the <b>▲/▼</b> button on the control panel or the <b>⏻</b> button on the remote control to select the setting.</p>	<p>On Standby Last status</p>

# ADJUSTING THE LCD DISPLAY

Item	Function	Operation	Range
LED	Set the display LED indicator on or off. <b>Note:</b> The default value is <b>On</b> .	Press the ▲/▼ button on the control panel or the M button on the remote control to select the setting.	Off On
Switch on delay	Adjust the power-on delaying time (in seconds) allows a sequential powering-on for each display by their ID number when multiple displays are connected. <b>Note:</b> The default value is 0.	Press the ▲/▼ button on the control panel or the M button on the remote control to adjust the value.	0 to 60
Logo	When enabled, the AG Neovo logo will be shown on the startup screen. <b>Note:</b> The default value is <b>On</b> .	Press the ▲/▼ button on the control panel or the M button on the remote control to select the setting.	Off On
APM	If APM function is enabled and no signal is detected, the LCD display will automatically turn off. <b>Note:</b> The default value is <b>On</b> .	Press the ▲/▼ button on the control panel or the M button on the remote control to select the setting.	Off On
Information OSD	When this function is enabled and the display is turned on while in standby mode, an information OSD is displayed on the upper left corner of the screen. <b>Note:</b> The default value is <b>On</b> .	Press the ▲/▼ button on the control panel or the M button on the remote control to select the setting.	Off On
DisplayPort Ver.	Set the DisplayPort version to 1.1a or 1.2. This setting is only valid on DisplayPort input and output as follows. <ul style="list-style-type: none"> <li>• <b>1.1a:</b> Switch DisplayPort Ver. to 1.1a(default), then the DisplayPort output is the clone of the DisplayPort input.</li> <li>• <b>1.2:</b> Switch DisplayPort Ver. to 1.2 to support MST(Multi-Stream Transport).</li> </ul> <b>Note:</b> <ul style="list-style-type: none"> <li>◆ If the display is black screen or abnormal under DisplayPort source, please switch to 1.1a and turn AC off and on.</li> <li>◆ The default value is 1.1a.</li> </ul>	Press the ▲/▼ button on the control panel or the M button on the remote control to select the setting.	1.1a 1.2

# ADJUSTING THE LCD DISPLAY

Item	Function	Operation	Range
Cooling fan	<p>Set the cooling fan operation.</p> <ul style="list-style-type: none"> <li>• <b>Off</b>: Cooling fan is turned off.</li> <li>• <b>On</b>: Cooling fan is turned on all the time during the LCD display is in operation.</li> <li>• <b>Auto</b>: Cooling fan turns on when the LCD display temperature reaches 60°C (140°F).</li> </ul> <p><b>Note:</b></p> <ul style="list-style-type: none"> <li>◆ A temperature warning message will appear on the screen when the temperature reaches 70°C (158°F).</li> <li>◆ Regardless the cooling fan status off or on, the cooling fan is turned on automatically if the temperature reaches 70°C (158°F), for three successive minutes and a temperature-waning message is shown on the screen for 10 seconds. In this situation, the LCD display is shut down and the Power LED indicator will be blinking red and green.</li> <li>◆ The default value is <b>Auto</b>.</li> </ul>	<p>Press the ▲/▼ button on the control panel or the M button on the remote control to select the setting.</p>	<p>Off On Auto</p>
Network control port	<p>Choose the RS232 control from the Card OPS or embedded RS232 in the display.</p> <p><b>Note:</b> The default value is <b>RS232</b>.</p>	<p>Press the ▲/▼ button on the control panel or the M button on the remote control to select the setting.</p>	<p>RS232 Card OPS RS232</p>
Factory settings	<p>Reset all your customized settings to the factory defaults.</p>	<p>Press the +/- button on the control panel or the ←/→ button on the remote control to select the setting.</p>	<p>OK Cancel</p>

# ADJUSTING THE LCD DISPLAY

## 5.5 Network Settings

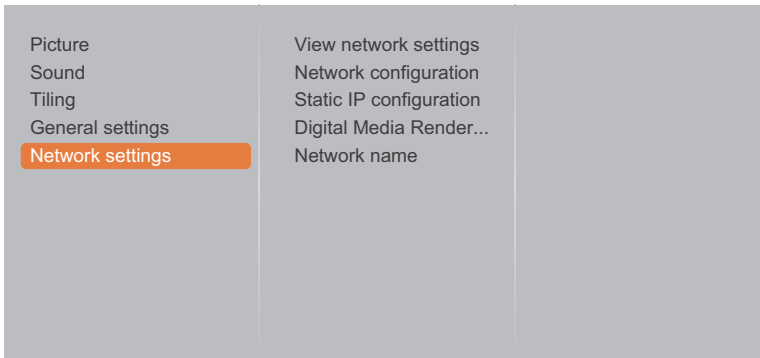

- 1 Press the **MENU** button on the control panel or the **⬆** button on the remote control to call out the OSD window.
- 2 Select **Network settings**, then press the **INPUT** button on the control panel or the **OK** button on the remote control.
- 3 Press the **▲/▼** button on the control panel or the **⬆/⬆** button on the remote control to select an option.

Item	Function	Operation	Range
View network settings	View connected network status.	Press the <b>INPUT</b> button on the control panel or the <b>OK</b> button on the remote control.	Cancel
Network configuration	Choose how the LCD display should assign addresses to the network resources.	Press the <b>▲/▼</b> button on the control panel or the <b>⬆/⬆</b> button on the remote control to select the setting.	DHCP & Auto IP Static IP
Static IP configuration	Configure the network parameters, such as IP address, netmask, gateway, DNS 1, and DNS 2. <b>Note:</b> This function can be only configured when the <b>Network configuration</b> setting is set to <b>Static IP</b> .	<ul style="list-style-type: none"> <li>• Press the <b>▲/▼</b> button on the control panel or the <b>⬆/⬆</b> button on the remote control to select the item. Then press the <b>INPUT</b> button on the control panel or the <b>OK</b> button on the remote control to confirm the selection.</li> <li>• Use the digit numbers [0] ~ [9] on the remote control to configure the network parameters.</li> <li>• When the setting is complete, press the <b>+/-</b> button on the control panel or the <b>⬅/➡</b> button on the remote control to select <b>Done</b>. Then press the <b>INPUT</b> button on the control panel or the <b>OK</b> button on the remote control to save the setting.</li> </ul>	N/A
Digital Media Renderer - DMR	Enable this function to allow the display to receive multimedia files from the connected device from the network. <b>Note:</b> The default value is <b>Off</b> .	Press the <b>▲/▼</b> button on the control panel or the <b>⬆/⬆</b> button on the remote control to select the setting.	Off On







# ADJUSTING THE LCD DISPLAY

Item	Function	Operation	Range
Network name	In the multiple-display connection, you can rename each display for easy identification.	<ul style="list-style-type: none"> <li>• Press the <b>INPUT</b> button on the control panel or the <b>OK</b> button on the remote control on the network name field to open the on-screen keyboard.</li> <li>• Use the on-screen keyboard to enter the name. When done, select <b>Done</b> and press the <b>INPUT</b> button on the control panel or the <b>OK</b> button on the remote control.</li> <li>• When the setting is complete, press the <b>+/-</b> button on the control panel or the <b>←/→</b> button on the remote control to select <b>Done</b>. Then press the <b>INPUT</b> button on the control panel or the <b>OK</b> button on the remote control to save the setting.</li> </ul>	N/A

# CHAPTER 6: APPENDIX

## 6.1 Warning Messages

Warning Messages	Cause	Solution
 Cannot display this video mode	The resolution or the refresh rate of the graphics card of the computer is set too high.	<ul style="list-style-type: none"><li>• Change the resolution or the refresh rate of the graphics card.</li></ul>
 No signal	The LCD display cannot detect the input source signal.	<ul style="list-style-type: none"><li>• Check if the input source is turned ON.</li><li>• Check if the signal cable is properly connected.</li><li>• Check if any pin inside the cable connector is twisted or broken.</li></ul>
 Local KB lock	The operation using the control panel buttons has been locked by the user.	<ul style="list-style-type: none"><li>• Disable the Local KB lock function. Refer to page 56.</li></ul>
 RC lock	The operation using the remote control buttons has been locked by the user.	<ul style="list-style-type: none"><li>• Disable the RC lock function. Refer to page 57.</li></ul>

# APPENDIX

## 6.2 USB Device Compatibility

USB Video Subtitle Formats (for language subtitles, etc.).

File Extensions	Container	Video codec	Maximum resolution	Max. Frame Rate (fps)	Max. Bit Rate (Mbps)	Audio codec
.mpg mpeg .vob	PS	MPEG-1	1920x1080	25p,30p,50i,60i	30	MPEG-1(L1&L2), MPEG-1,2,2.5 L3, AAC/HE-AAC(v1&v2), DVD-PCM,AC3
		MPEG-2	1920x1080	25p,30p,50i,60i	30	
		MPEG-4 ASP	1920x1080	25p,30p,50i,60i	30	
		H.264	1920x1080	25p,30p,50p,60p,60i	30	
.ts	TS	MPEG-2	1920x1080	25p,30p,50i,60i	30	MPEG-1(L1&L2), MPEG-1,2,2.5 L3, AAC/HE-AAC (v1&v2), AC3,E-AC3, Dolby Pulse
		MPEG-4 ASP	1920x1080	25p,30p,50i,60i	30	
		H.264	1920x1080	25p,30p,50p,60p,60i	30	
		MVC	1920x1080i@field rate=50, 60Hz 1920x1080p@frame rate=24, 25,30Hz 1280x720p@frame rate=50, 60Hz	-	30	
.ts .m2ts .mts .mt2	MaTS TTS	MPEG-2	1920x1080	25p,30p,50i,60i	30	MPEG-1(L1&L2), MPEG-1,2,2.5 L3, AAC/HE-AAC (v1&v2), AC3,E-AC3, Dolby Pulse
		MPEG-4 ASP	1920x1080	25p,30p,50i,60i	30	
		H.264	1920x1080	25p,30p,50p,60p,60i	30	
		MVC	1920x1080i @ field rate=50, 60Hz 1920x1080p @ frame rate=24, 25,30Hz 1280x720p @ frame rate=50, 60Hz	-	30	
.ts .m2ts .mts	AVCHD	MPEG-2	1920x1080	25p,30p,50i,60i	30	MPEG-1(L1&L2), MPEG-1,2,2.5 L3, AAC/HE-AAC (v1&v2), AC3,E-AC3, Dolby Pulse
		MPEG-4 ASP	1920x1080	25p,30p,50i,60i	30	
		H.264	1920x1080	25p,30p,50p,60p,60i	30	

# APPENDIX

File Extensions	Container	Video codec	Maximum resolution	Max. Frame Rate (fps)	Max. Bit Rate (Mbps)	Audio codec
.ts .m2ts .mts	AVCHD	MVC	1920x1080i@field rate=50, 60Hz 1920x1080p@frame rate=24, 25,30Hz 1280x720p @ frame rate=50, 60Hz	-	30	MPEG-1(L1&L2), MPEG-1,2,2.5 L3, AAC/HE-AAC (v1&v2), AC3,E-AC3, Dolby Pulse
.m4v	M4V	H.264	1920x1080	25p,30p,50p,60p,60i	30	AAC
.ism/ Manifest .mpd	frag MP4	H.264	1920x1080	25p,30p,50p,60p,60i	30	AAC/HE- AAC(v1&v2), AC3,E- AC3,WMA, WMA-PRO
		MVC	1920x1080i@field rate=50, 60Hz 1920x1080p@frame rate=24, 25,30Hz 1280x720p @ frame rate=50, 60Hz	-	30	
.mp4	MP4	MPEG-4 ASP	1920x1080	25p,30p,50i,60i	30	AAC/HE- AAC(v1&v2), AC3,E- AC3,WMA, WMA-PRO
		H.264	1920x1080		30	
		MVC	1920x1080i@field rate=50, 60Hz 1920x1080p@frame rate=24, 25,30Hz 1280x720p @ frame rate=50, 60Hz	-	30	
		WMV9/ VC1	1920x1080	30p,60i	30	
.mkv .mk3d	MKV	MPEG-4 ASP	1920x1080	25p,30p,50i,60i	30	MPEG-1(L1&L2), MPEG-1,2,2.5 L3, AAC/HE-AAC (v1&v2), AC3,E-AC3, WMA, WMA-PRO
		H.264	1920x1080		30	

# APPENDIX

## USB Multimedia Formats

File Extensions	Container	Video codec	Maximum resolution	Frequency (kHz)	Max. Bit Rate (Mbps)	Audio codec
.mp3	MP3	-	-	48	384	MPEG-1,2,2.5 L3
.wma .asf	WMA (V2 up to V9.2)	-	-	48	192	WMA
.wma	WMA Pro	-	-	96	768	WMA,WMA Pro
.wav(PC)	LPCM	-	-	192	768	LPCM
.aif(mac) .aiff(mac)	LPCM	-	-	192	768	LPCM
.aac .mp4 .m4a	AAC	-	-	48	1024	AAC,HE-AAC(v1&v2)
.pls .m3u	Playlists	-	-	-	-	-
.m4a	M4A	-	-	48	1024	AAC,HE-AAC(v1&v2)

### Note:

- ◆ Sound or video may not work if the contents have a standard bit rate/frame rate above the compatible Frame/sec listed in the table above.
- ◆ Video content with a Bit rate or Frame rate larger than the rate specified in the table above can cause choppy video during playback.

# APPENDIX

## 6.3 Supported Resolution

### VGA Resolution:

Standard Resolution	Active Resolution		Refresh Rate	Pixel Rate	Aspect Ratio	Stand for Mode
	H Pixels	V Lines				
VGA	640	480	60 Hz	25.175 MHz	4:3	Video Graphic Array
			72 Hz	31.5 MHz		
			75 Hz	31.5 MHz		
WVGA	720	400	70 Hz	33.75 MHz	16:9	Wide Video Graphic Array
SVGA	800	600	60 Hz	40 MHz	4:3	Super VGA
			75 Hz	49.5 MHz		
XGA	1024	768	60 Hz	65 MHz	4:3	Extended Graphic Array
			75 Hz	78.75 MHz		
WXGA	1280	768	60 Hz	79.5 MHz	5:3	Wide XGA
WXGA	1280	800	60 Hz	79.5 MHz	16:10	Wide XGA
SXGA	1280	960	60 Hz	108 MHz	4:3	Super XGA
SXGA	1280	1024	60 Hz	108 MHz	5:4	Super XGA
WXGA	1360	768	60 Hz	85.5 MHz	16:9	Wide XGA
WXGA	1366	768	60 Hz	85.5 MHz	16:9	Wide XGA
UXGA	1600	1200	60 Hz	162 MHz	4:3	Ultra XGA
HD1080	1920	1080	60 Hz	148.5 MHz	16:9	HD1080

### SDTV Resolution:

Standard Resolution	Active Resolution		Refresh Rate	Pixel Rate	Aspect Ratio	Stand for Mode
	H Pixels	V Lines				
480i	720	480	29.97 Hz	13.5 MHz	4:3	Modified NTSC Standard
480p			59.94 Hz	27 MHz		
576i	720	576	25 Hz	13.5 MHz	4:3	Modified PAL Standard
576p			50 Hz	27 MHz		

### HDTV Resolution:

Standard Resolution	Active Resolution		Refresh Rate	Pixel Rate	Aspect Ratio	Stand for Mode
	H Pixels	V Lines				
720p	1280	720	50 Hz	74.25 MHz	16:9	Normally DVB Mode
			60 Hz			
1080i	1920	1080	25 Hz	74.25 MHz	16:9	Normally ATSC Mode
			30 Hz			
1080p	1920	1080	50 Hz	148.5 MHz	16:9	Normally ATSC Mode
			60 Hz			

### General guidelines:

- The PC text quality is optimum in HD 1080 mode (1920 x 1080, 60Hz).
- Your PC display screen might appear different depending on the manufacturer (and your particular version of Windows).
- Check your PC instruction book for information about connecting your PC to a display.

# APPENDIX

- If a vertical and horizontal frequency-select mode exists, select 60Hz (vertical) and 31.5KHz (horizontal). In some cases, abnormal signals (such as stripes) might appear on the screen when the PC power is turned off (or if the PC is disconnected). If so, press the [INPUT] button to enter the video mode. Also, make sure that the PC is connected.
- When horizontal synchronous signals seem irregular in RGB mode, check PC power saving mode or cable connections.
- The display settings table complies to the IBM/VESA standards, and based on the analog input.
- The DVI support mode is regarded as same to the PC support mode.
- The best timing for the vertical frequency to each mode is 60Hz.

## 6.4 Cleaning

### Caution When Using the Display

- Do not bring your hands, face or objects close to the ventilation holes of the display. The top of the display is usually very hot due to the high temperature of exhaust air being released through the ventilation holes. Burns or personal injuries may occur if any body parts are brought too close. Placing any object near the top of the display could also result in heat related damage to the object as well as the display itself.
- Be sure to disconnect all cables before moving the display. Moving the display with its cables attached may damage the cables and thus cause fire or electric shock.
- Disconnect the power plug from the wall outlet as a safety precaution before carrying out any type of cleaning or maintenance procedure.

### Front Panel Cleaning Instructions



- The front of the display has been specially treated. Wipe the surface gently using only a cleaning cloth or a soft, lint-free cloth.
- If the surface becomes dirty, soak a soft, lint-free cloth in a mild detergent solution. Wring the cloth to remove excess liquid. Wipe the surface of the display to remove dirt. Then use a dry cloth of the same type to dry.
- Do not scratch or hit the surface of the panel with fingers or hard objects of any kind.
- Do not use volatile substances such as insect sprays, solvents and thinners.

### Cabinet Cleaning Instructions

- If the cabinet becomes dirty, wipe the cabinet with a soft, dry cloth.
- If the cabinet is extremely dirty, soak a lint-free cloth in a mild detergent solution. Wring the cloth to remove as much moisture as possible. Wipe the cabinet. Use another dry cloth to wipe over until the surface is dry.
- Do not allow any water or detergent to come into contact with the surface of the display. If water or moisture gets inside the unit, operating problems, electrical and shock hazards may result.
- Do not scratch or hit the cabinet with fingers or hard objects of any kind.
- Do not use volatile substances such as insect sprays, solvents and thinners on the cabinet.
- Do not place anything made from rubber or PVC near the cabinet for any extended periods of time.

# APPENDIX

## 6.5 Troubleshooting

Symptom	Possible Cause	Remedy
No picture is displayed	<ul style="list-style-type: none"> <li>The main power switch on the back of the display is not switched on.</li> <li>The selected input has no connection.</li> <li>The display is in standby mode.</li> </ul>	<ol style="list-style-type: none"> <li>1 Plug in the power cord.</li> <li>2 Make sure the power switch is switched on.</li> <li>3 Connect a signal connection to the display.</li> </ol>
Interference displayed on the display or audible noise is heard	Caused by surrounding electrical appliances or fluorescent lights.	Move the display to another location to see if the interference is reduced.
Color is abnormal	The signal cable is not connected properly.	Make sure that the signal cable is attached firmly to the back of the display.
Picture is distorted with abnormal patterns	<ul style="list-style-type: none"> <li>The signal cable is not connected properly.</li> <li>The input signal is beyond the capabilities of the display.</li> </ul>	<ul style="list-style-type: none"> <li>Make sure that the signal cable is attached firmly.</li> <li>Check the video signal source to see if it is beyond the range of the display. Please verify its specifications with this display's specification section.</li> </ul>
Display image doesn't fill up the full size of the screen	The picture format is not set correctly.	Press the  button and select <b>Auto zoom</b> .
Can hear sound, but no picture	Improperly connected source signal cable.	Make sure that both video inputs and sound inputs are correctly connected.
Can see picture but no sound is heard	<ul style="list-style-type: none"> <li>Improperly connected source signal cable.</li> <li>Volume is turned all the way down.</li> <li><b>MUTE</b> function is turned on.</li> <li>No external speaker connected.</li> </ul>	<ul style="list-style-type: none"> <li>Make sure that both video and sound inputs are correctly connected.</li> <li>Press the <b>+</b> or <b>-</b> button to hear the sound.</li> <li>Switch the <b>MUTE</b> function off by using the  button.</li> <li>Connect the external speakers and adjust the volume to a suitable level.</li> </ul>
Some picture elements do not light up	Some pixels of the display may not turn on.	This display is manufactured using an extremely high level of precision technology: however, sometimes some pixels of the display may not display. This is not a malfunction.
After-Images can still be seen on the display after the display is powered off. (Examples of still pictures include logos, video games, computer images, and images displayed in 4:3 normal mode)	A still picture is displayed for an over extended period of time.	Do not allow a still image to be displayed for an extended period of time as this can cause a permanent after-image to remain on the display.



# APPENDIX

## 6.6 Transporting the LCD Display

To transport the LCD display for repair or shipment, place the display in its original packaging carton.

- 1 Put all the accessories in the box (if necessary).
- 2 Place the lower foam cushion inside the lower box (a).
- 3 Place the LCD display down in the lower box (a).
- 4 Place the upper foam cushion on top of the LCD display.
- 5 Place the accessories box on the designated area (if necessary).
- 6 Place the upper box (b) on LCD display.
- 7 Secure the upper box to the lower box with the supplied locks (c).

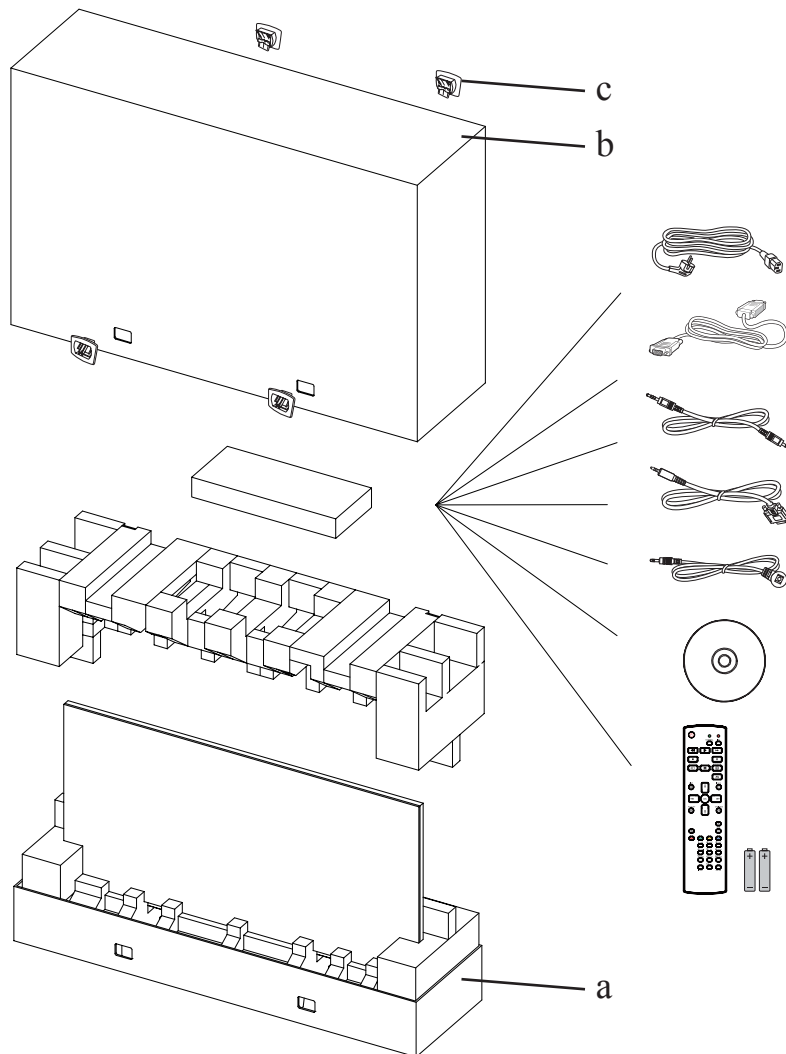

# CHAPTER 7: SPECIFICATIONS

## 7.1 Display Specifications

Display	PN-55D	PN-55H
Screen Size (Active Area)	54,6" (138.7 cm) LCD	
Aspect Ratio	16:9	
Number of Pixels	1920 (H) x 1080 (V)	
Pixel Pitch	0.630 (H) x 0.630 (V) [mm]	
Displayable Colors	1.06B colors	
Brightness (Typical)	500 cd/m <sup>2</sup>	700 cd/m <sup>2</sup>
Contrast Ratio (Typical)	1400:1	
Viewing Angle	178 degrees	

In/Out Terminals		PN-55D	PN-55H
Speaker Output	Internal Speakers	10W (L) + 10W (R) [RMS]/8Ω	
	External Speakers	1 Way 1 Speaker System 82 dB/W/M/160 Hz ~ 13 KHz	
Audio Output	3.5mm phone jack x 1	0.5V [rms] (Normal) / 2 Channel (L+R)	
Audio Input	RCA Jack x 2	0.5V [rms] (Normal) / 2 Channel (L+R)	
	3.5mm phone jack x 1		
RS232C	2.5mm Phone jack x 2	RS232C in/RS232C out	
RJ-45	RJ-45 Jack x 1 (8 pin)	10/100 LAN Port	
HDMI Input	HDMI Jack x 2 (Type A) (19 pin)	Digital RGB: TMDS (Video + Audio)	
		MAX: Video - 720p, 1080p, 1920 x 1080/60 Hz (WUXGA) Audio - 48 KHz/ 2 Channel (L+R) Supports LPCM only	
DVI-D Input	DVI-D jack	Digital RGB: TMDS (Video)	
VGA Input	D-Sub Jack x 1 (15 pin)	Analog RGB: 0.7V [p-p] (75Ω), H/CS/V: TTL (2.2kΩ), SOG: 1V [p-p] (75Ω)	
		MAX: 720p, 1080p, 1920 x 1080/60 Hz (WUXGA)	
DVI-I (DVI-D & VGA) Output	DVI-I Jack x 1 (29 pin)	Digital RGB: TMDS (Video)	
		Analog RGB: 0.7V [p-p] (75Ω), H/CS/V: TTL (2.2kΩ), SOG: 1V [p-p] (75Ω) MAX: 720p, 1080p, 1920 x 1080/60 Hz (WUXGA)	
Component Input	BNC Jack x 3	Y: 1V [p-p] (75Ω), Pb: 0.7V [p-p] (75Ω), Pr: 0.7V [p-p] (75Ω)	
		MAX: 480i, 576i, 480p, 576p, 720p, 1080i, 1080p	
Video Input	BNC x 1 (Share with Component_Y)	Composite 1V [p-p] (75Ω)	
Displayport in/out	Displayport Jack x 2 (20 pin)	Digital RGB: TMDS (Video + Audio)	
		MAX: Video - 720p, 1080p, 1920 x 1080/60 Hz (WUXGA) Audio - 48 KHz/ 2 Channel (L+R) Supports LPCM only	
IR Input	3.5mm stereo x 1	External IR input	
IR Output	3.5mm stereo x 1	External IR output	

# SPECIFICATIONS

General	PN-55D	PN-55H
Power Supply	AC 100 - 240V, 50 - 60Hz, 3.5A	
Power Consumption (Max) (With OPS)	320 W	420 W
Power Consumption (Without OPS)	185 W	275 W
Power Consumption (Standby & Off)	<0.5 W (RS232 in active)	
Dimensions (With Stand) [W x H x D] (mm)	1213.4 x 726.2 x 400.0	
Dimensions (Without Stand) [W x H x D] (mm)	1213.4 x 684.2 x 95.0 (@Wall Mount) / 103.4 (@Handle)	
Weight (With Stand)	31.5 Kg	
Weight (Without Stand)	29.2 Kg	
Gross Weight (Without Stand)	43.5 Kg	

Environmental Condition	PN-55D	PN-55H
Temperature	Operational	0 ~ 40°C
	Storage	-20 ~ 60°C
Humidity	Operational	20 ~ 80% RH (No condensation)
	Storage	5 ~ 95% RH (No condensation)
Altitude	Operational	0 ~ 3,000 m
	Storage / Shipment	0 ~ 9,000 m

Internal Speaker	PN-55D	PN-55H
Type	1 Way 1 Speaker	
Input	10 W (RMS)	
Impedance	8Ω	
Output Sound Pressure	82 dB/W/M	
Frequency Response	160 Hz ~ 13 KHz	

## Note:

- ◆ All specifications are subject to change without prior notice.

# SPECIFICATIONS

## 7.2 Display Dimensions

### 7.2.1 PN-55D / PN-55H Dimensions

