



## Quick Installation Guide

### 5 megapixel H.265 Outdoor Network Camera

This document will guide you through the basic installation process for your new D-Link Network Camera.

**DCS-7517**

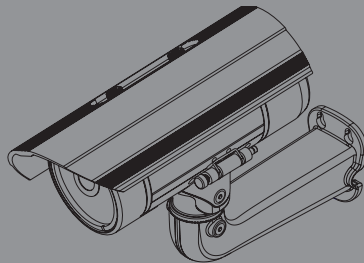

Quick Installation Guide  
Installationsanleitung  
Guide d'installation  
Guía de instalación  
Guida di Installazione  
Краткое руководство по установке  
Guia de Instalação Rápida  
快速安裝指南  
Petunjuk Pemasangan Cepat

Documentation also available on  
CD and via the D-Link Website

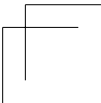
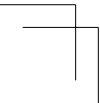
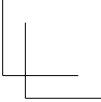
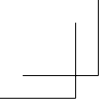

---

# Quick Installation Guide

This installation guide provides basic instructions for installing the DCS-7517. For additional information about how to use the camera, please see the User Manual which is available on the CD included in this package or from the D-Link support website.

## Package Contents

- DCS-7517 5 megapixel H.265 Outdoor Network Camera
- Ethernet Cable
- Extension Adapter
- Mounting Bracket and Screws
- Manual and Software on CD-ROM
- Quick Installation Guide

If any of the above items are missing, please contact your reseller.

### **Safety Notice:**

Installation and servicing should be done by certified technicians so as to conform to all local codes and prevent voiding your warranty.

## Hardware Overview

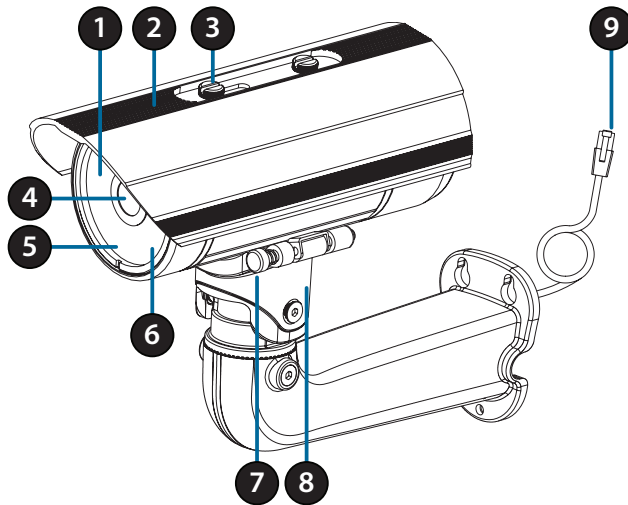

1	<b>IR LEDs</b>	Provide illumination for low-light environments.
2	<b>Adjustable Top Shield</b>	Shields the camera lens from direct sunlight.
3	<b>Adjustment Screw</b>	Allows for positioning of the top shield.
4	<b>Camera Lens</b>	Varifocal lens to record video of the surrounding area.
5	<b>Power/Status LED</b>	Indicates the camera's current status.
6	<b>Light Sensor</b>	Measures lighting conditions and switches between day and night mode accordingly.
7	<b>Quick Release Pin</b>	Allows the camera to be swiveled into position for easy maintenance.
8	<b>Camera Shoe</b>	Adjustable mounting seat for the camera.
9	<b>Ethernet Jack</b>	Connects to an RJ45 Ethernet port. Can be used with PoE to provide power to the camera.

## Optional Cable Harness (not included)

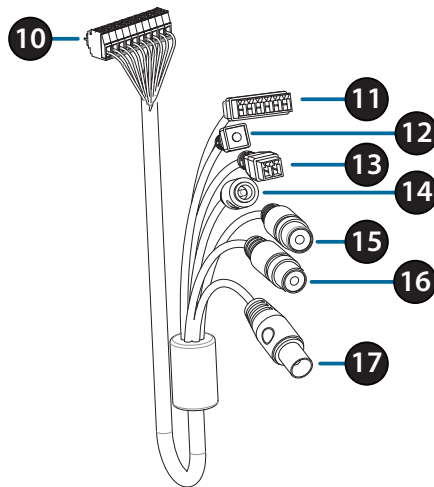

10	<b>Camera Connector</b>	Connects to the DCS-7517. For more details on connecting the A/V cable, refer to the User Manual.
11	<b>DI/DO Connector</b>	I/O connectors for external devices.
12	<b>Reset Button</b>	Press and hold the button for 10 seconds to reset the camera back to the factory default settings.
13	<b>24 V Power Connector</b>	Not supported for the DCS-7517.
14	<b>Power Connector</b>	Power connector for a 12 V DC power adapter (not included).
15	<b>Audio Out (Green)</b>	Connects to a speaker.
16	<b>Audio In (Red)</b>	Connects to a microphone.
17	<b>BNC Connector</b>	Not supported for the DCS-7517.

## Internal

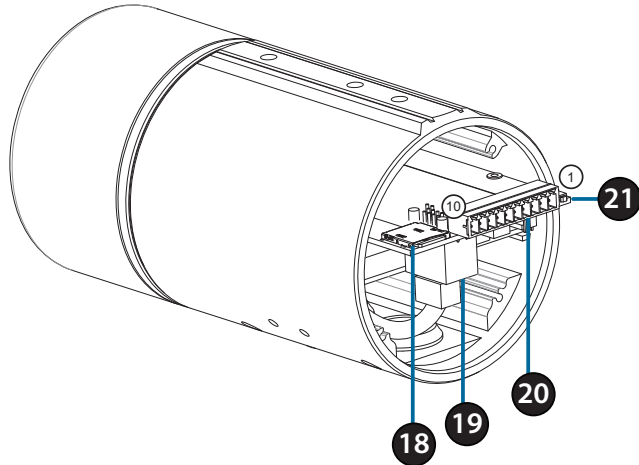

18	<b>SD Card Slot</b>	Insert a microSD card for local storage for storing recorded images and video.	
19	<b>Ethernet Port</b>	Connects to Ethernet cable.	
20	<b>Harness Connector</b>	Connects to the optional cable harness (not included).	
		1. 12V IN 2. GND 3. AUD IN 4. AUD GND 5. AUD OUT	6. 12V OUT 7. GND 8. RESET 9. DI 10. DO
21	<b>Reset Button</b>	Press and hold the button for 10 seconds to reset the camera back to the factory default settings.	

## Connecting the Optional Cable Harness

Remove the back camera cover by turning it counter-clockwise.

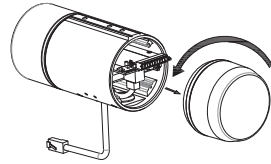

Remove the back waterproofing plug from the camera.

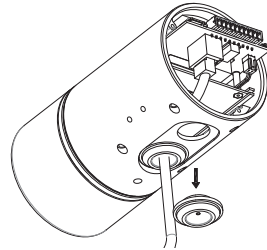

Push the camera connector and cable through the hole, and insert the cable's waterproofing plug.

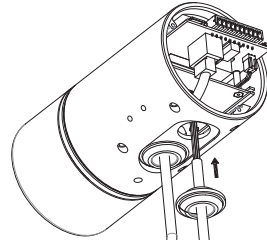

Make sure the plug is inserted properly to ensure a good seal.

Connect the camera connector to the camera.

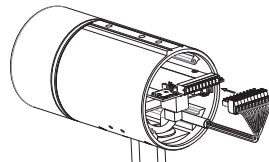

Reattach the back camera cover by turning it clockwise.

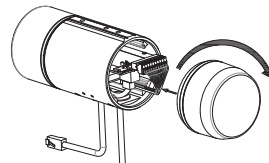

## SD Card Installation

Remove the back camera cover by turning it counter-clockwise.

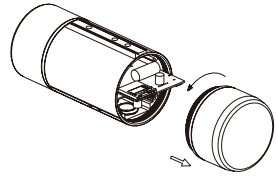

Insert the microSD card with the contacts facing down, then reattach the back cover. Make sure that the weatherproof seals are secured firmly in place.

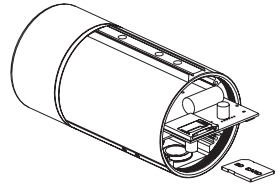

## Mounting Instructions

Please refer to the User Manual for detailed instructions on how to install and mount the camera.

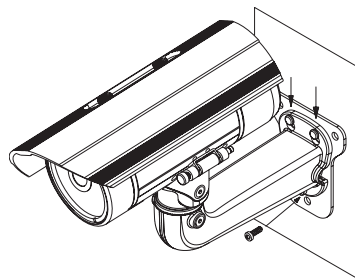
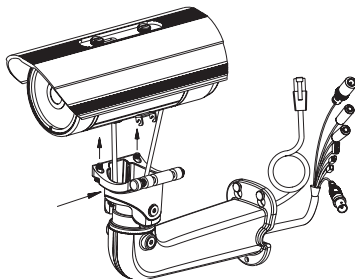
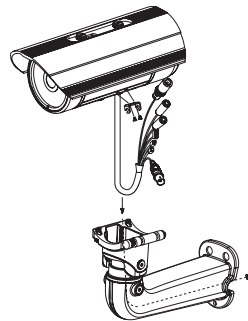
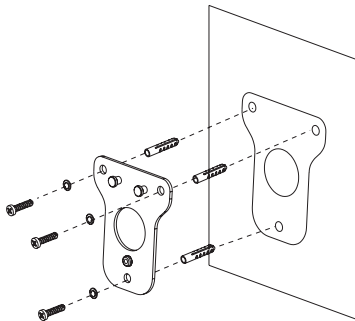



## Connecting the Camera

### Connection with a PoE Switch

- Connect the Ethernet cable to your PoE switch or injector. The Ethernet cable will provide the camera with both power and a network connection.

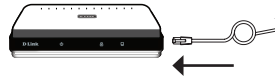

If you have the optional cable harness, you can also use the following connection method:

### General Connection Using 12 V DC Power Adapter (not included)

- Connect the Ethernet cable to your network.
- Connect your power adapter to the camera's power connector, then plug in the power adapter.

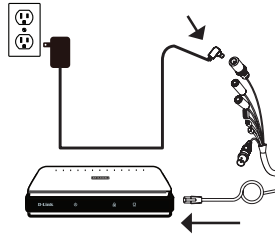

## Configuring the Camera

Insert the DCS-7517 CD into your computer's CD-ROM drive to begin the installation. If Autorun is disabled, or if the D-Link Launcher fails to start automatically, click the Start button and type **D:\autorun.exe** (where D: represents the drive letter of your CD-ROM drive) and press Enter.

Click **Setup Wizard** and follow the instructions to install the Setup Wizard.



Click on the **D-Link Setup Wizard SE** icon that was created in your Windows Start menu (**Start > D-Link > Setup Wizard SE**).

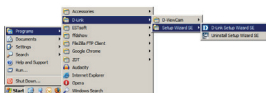

The Setup Wizard will appear and display the MAC address and IP address of your camera(s). If you have a DHCP server on your network, a valid IP Address will be displayed. Otherwise, the network camera's default static IP **192.168.0.20** will be displayed. Select your camera, then click the **Wizard** button to continue.



Enter the Admin ID and password. When logging in for the first time, the default Admin ID is **admin** with the password left blank.

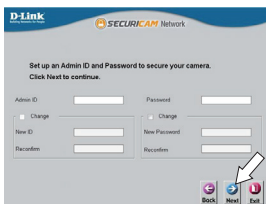

Click the checkboxes if you wish to change the admin ID and password for the camera, and enter the new ID and password you wish to use.

Click **Next** to continue.

Select **DHCP** if your camera obtains an IP address automatically from a DHCP server such as a router. Select **Static IP** if you want to manually enter the IP settings for the camera.

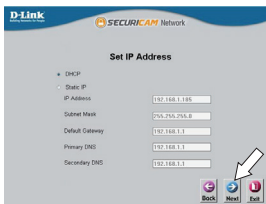

Click **Next** to continue.

Take a moment to confirm your settings and click **Restart**.

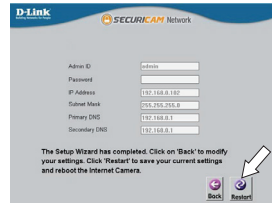

## Viewing Your Camera via Web Browser

Click on the **D-Link Setup Wizard SE** icon that was created in your Windows Start menu (**Start > D-Link > Setup Wizard SE**).

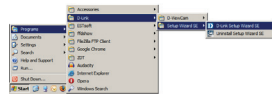

Select the camera and click **Link** to access the web configuration.

The Setup Wizard will automatically open your web browser to the IP address of the camera.



The first time you connect to the camera, you will be asked to set a password for the administrator account. After entering a password, click **Save**.

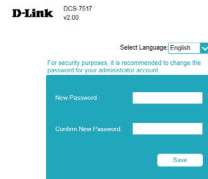

The camera's live video page will open, and you can now control and configure your camera. For additional information about web configuration, please refer to the user manual, which is available on the D-Link website.



## Additional Information

Additional help and product information is available online at <http://www.dlink.com>.

## Warranty Information

Please visit <http://warranty.dlink.com/> for warranty information for your region.

---

# Installationsanleitung

Diese Installationsanleitung bietet Ihnen grundlegende Anleitungen zur Installation der DCS-7517 in Ihrem Netzwerk. Zusätzliche Informationen zur Verwendung der Kamera finden Sie im Benutzerhandbuch, das Ihnen auf der CD, die diesem Paket beiliegt, oder über die D-Link Support-Website zur Verfügung steht.

## Packungsinhalt

- DCS-7517 5 Megapixel H.265 Outdoor-Netzwerkamera
- Ethernet-Kabel
- Adapter für Erweiterung
- Montageplatte und Schrauben
- CD-ROM mit Software und Handbuch
- Installationsanleitung

Sollte einer der oben aufgeführten Artikel fehlen, so wenden Sie sich bitte an Ihren Fachhändler.

### Sicherheitshinweis:

Installation und Wartungsarbeiten sollten nur von zertifizierten Technikern vorgenommen werden, zu jeder Zeit allen örtlich geltenden Richtlinien und Anforderungen entsprechen sowie verhindern, dass Ihr Garantieanspruch erlischt.

## Hardware-Überblick

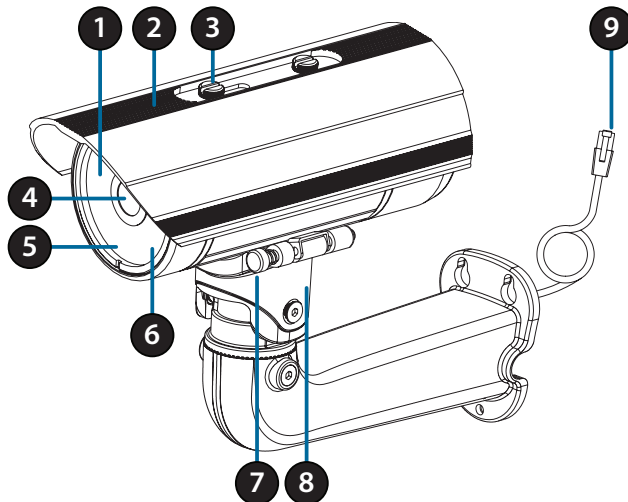

DEUTSCH

1	<b>IR-LEDs</b>	Beleuchtung für schwach ausgeleuchtete Umgebungen
2	<b>Einstellbare obere Abdeckung</b>	Schirmt die Kamera vor direktem Sonnenlicht ab.
3	<b>Stellschraube</b>	Ermöglicht die Positionierung der oberen Abdeckung.
4	<b>Kameraobjektiv</b>	Aufnahme von Videobildern der Umgebung mit variabler Brennweite.
5	<b>Betriebsanzeige/Status-LED</b>	Zeigt den aktuellen Status der Kamera.
6	<b>Lichtsensoren</b>	Misst die vorherrschenden Lichtverhältnisse und wechselt entsprechend zwischen Tag- und Nachsichtmodus.
7	<b>Schnellentriegelungsstift</b>	Ermöglicht das Schwenken der Kamera in die richtige Position zur einfachen Wartung.
8	<b>Kameraschuh</b>	Einstellbare Montagehalterung für die Kamera.
9	<b>Ethernet-Anschluss</b>	Wird mit einem RJ45 Ethernet-Anschluss verbunden. Kann mit PoE für die Stromversorgung der Kamera verwendet werden.

## Optionaler Kabelbaum (nicht im Lieferumfang)

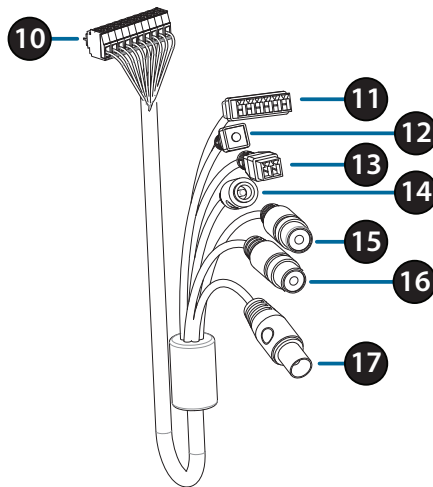

10	<b>Kameraanschluss</b>	Wird mit dem Modell DCS-7517 verbunden. Weitere Informationen zum Anschluss des A/V-Kabels finden Sie im Benutzerhandbuch.
11	<b>Steckverbinder für digitalen Ein- und Ausgang</b>	E/A-Anschlüsse für externe Geräte.
12	<b>Rücksetzknopf</b>	Drücken und halten Sie den Knopf 10 Sekunden lang, um die Kameraeinstellungen auf die werkseitigen Standardeinstellungen zurückzusetzen.
13	<b>24 V Stromanschluss</b>	Nicht unterstützt für die DCS-7517.
14	<b>Netzteilanschluss</b>	Stromanschluss für ein 12 V DC-Netzteil (nicht im Lieferumfang)
15	<b>Audio Ausgang (Grün)</b>	Anschluss für einen Lautsprecher
16	<b>Audio Eingang (Rot)</b>	Für den Anschluss eines Mikrofons
17	<b>BNC-Stecker</b>	Nicht unterstützt für die DCS-7517.

## Intern

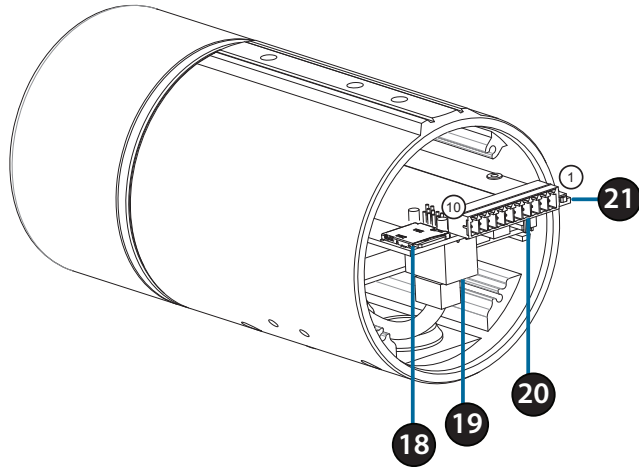

18	<b>SD-Karteneinschub</b>	Setzen Sie zum lokalen Speichern von aufgenommenen Bildern und Videos eine microSD-Karte ein	
19	<b>Ethernet-Port</b>	Zum Anschließen eines Ethernet-Kabels.	
20	<b>Kabelbaumanschluss</b>	Wird mit dem optionalen Kabelbaum (nicht enthalten) verbunden.	
		1. 12V IN 2. GND (Masse) 3. AUD IN 4. AUD GND 5. AUD OUT	6. 12V OUT 7. GND (Masse) 8. RESET (RÜCKSETZEN) 9. DI 10. DO
21	<b>Rücksetztaste</b>	Drücken und halten Sie den Knopf 10 Sekunden lang, um die Kameraeinstellungen auf die werkseitigen Standardeinstellungen zurückzusetzen.	

## Für den Anschluss eines optionalen Kabelbaums

Entfernen Sie die rückseitige Abdeckung der Kamera, indem Sie diese gegen den Uhrzeigersinn drehen.

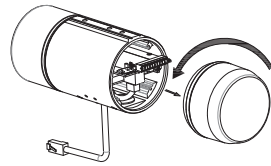

Entfernen Sie den hinteren wasserdichten Stopfen aus der Kamera.

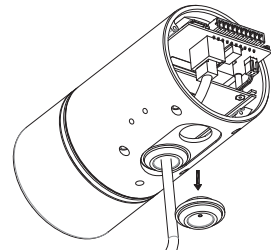

Schieben Sie Kameranschluss und Kabel durch die Öffnung und setzen Sie den wasserdichten Stopfen des Kabels ein.

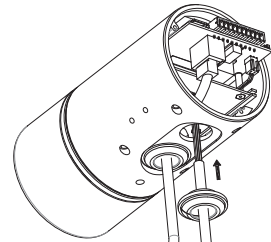

Achten Sie darauf, dass der Stopfen fest sitzt und die Öffnung gut abdichtet.

Schließen Sie den Kamerastecker an der Kamera an.

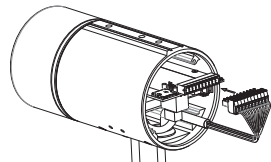

Bringen Sie die hintere Abdeckung der Kamera wieder an, indem Sie sie im Uhrzeigersinn drehen.

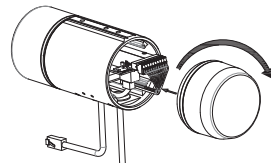



## SD-Karteninstallation

Entfernen Sie die rückseitige Abdeckung der Kamera, indem Sie diese gegen den Uhrzeigersinn drehen.

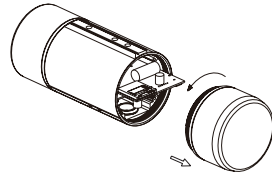

Setzen Sie die microSD-Karte mit den Kontakten nach unten ein und bringen Sie die hintere Abdeckung wieder an. Achten Sie darauf, dass die wetterfesten Gummidichtungen ordnungsgemäß und sicher angebracht sind.

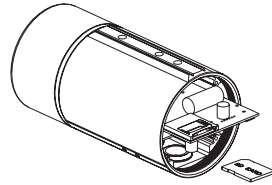

DEUTSCH

## Montageanleitung

Im Benutzerhandbuch finden Sie detaillierte Anweisungen zur Installation und Befestigung der Kamera.

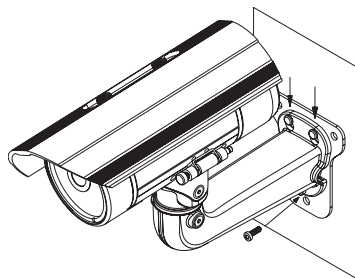
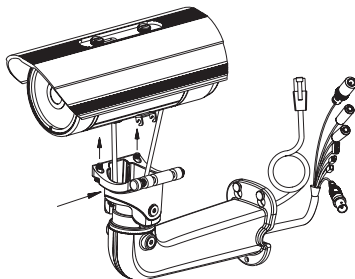
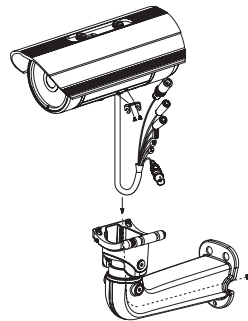
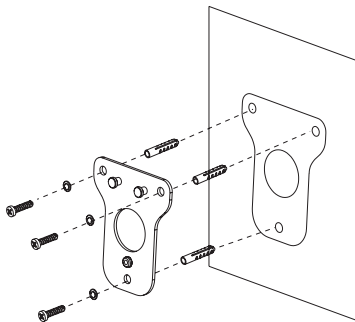

## Anschluss der Kamera

### Anschluss mit einem PoE Switch

- Schließen Sie das Ethernet-Kabel an Ihren PoE-Switch oder einen Injektor an. Das Ethernet-Kabel versorgt die Kamera mit Strom und einer Netzwerkverbindung.



Wenn Sie den optionalen Kabelbaum erworben haben, können Sie die folgende Anschlussmethode verwenden:

### Allgemeiner Anschluss mit 12 V DC-Netzteil (nicht im Lieferumfang)

- Verbinden Sie das Ethernet-Kabel mit Ihrem Netzwerk.
- Verbinden Sie Ihr Netzteil mit dem Stromanschluss der Kamera, dann stecken Sie das Netzteil ein.

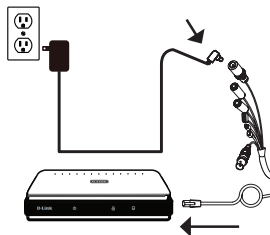

## Konfiguration der Kamera

Legen Sie die DCS-7517 CD in das CD-ROM-Laufwerk Ihres Computers, um die Installation zu beginnen. Sollte die CD auf Ihrem Computer nicht automatisch ausgeführt werden oder der D-Link Launcher nicht automatisch starten, klicken Sie auf die Startschaltfläche und geben Sie D:\autorun.exe ein (wobei D: für den Laufwerkbuchstaben Ihres CD-ROM-Laufwerks steht) und drücken Sie die Eingabetaste.

Klicken Sie auf **Setup Wizard** (Einrichtungsassistent) und folgen Sie den Anweisungen zu dessen Installation.



Klicken Sie auf das Symbol für den **D-Link Setup-Wizard SE**, der in Ihrem Windows-Startmenü (**Start > D-Link > Setup Wizard SE**) erstellt wurde.

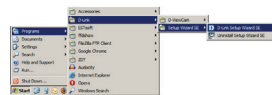

Der Einrichtungsassistent wird aufgerufen und zeigt die MAC- und IP-Adresse Ihrer Kamera(s) an. Wenn in Ihrem Netzwerk ein DHCP-Server vorhanden ist, wird eine gültige IP-Adresse angezeigt. Ansonsten wird die statische Standard-IP der Netzwerkkamera angezeigt: **192.168.0.20**. Wählen Sie Ihre Kamera aus und klicken Sie dann auf **Wizard** (Assistent), um fortzufahren.

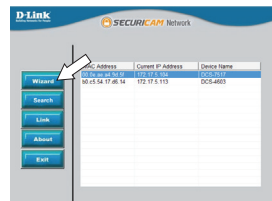

Geben Sie die Administratorkennung und das Kennwort ein. Bei Erstanmeldung ist die standardmäßige Administratorkennung **admin**. Das Feld Kennwort bleibt leer.

Klicken Sie auf die Kontrollkästchen, wenn Sie die Administratorkennung und das Kennwort für die Kamera ändern möchten. Geben Sie die neue Kennung und das Kennwort ein, das Sie verwenden möchten.



Klicken Sie auf **Weiter** um fortzufahren.

Wählen Sie **DHCP**, wenn Ihrer Kamera automatisch eine IP-Adresse von einem DHCP-Server (wie z. B. einem Router) zugewiesen wird.

Wählen Sie **Static IP** (Statische IP-Adresse), wenn Sie die IP-Einstellungen für die Kamera manuell eingeben möchten.



Klicken Sie auf **Weiter** um fortzufahren.

Prüfen Sie Ihre Einstellungen und klicken Sie dann auf **Restart** (Neustart).

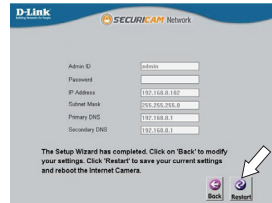

## Anzeige Ihrer Kamera über einen Webbrowser

Klicken Sie auf das Symbol für den **D-Link Setup-Wizard SE**, der in Ihrem Windows-Startmenü (**Start > D-Link > Setup Wizard SE**) erstellt wurde.

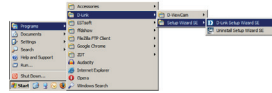

Wählen Sie die Kamera aus und klicken Sie auf **Link**, um auf die Web-Konfiguration zuzugreifen.

Der Einrichtungsassistent öffnet automatisch Ihren Webbrowser mit der IP-Adresse der Kamera.



Wenn Sie sich zum ersten Mal mit der Kamera verbinden, werden Sie aufgefordert, ein Kennwort für das Administratorkonto zu erstellen. Klicken Sie nach Eingabe Ihres Kennwortes auf **Save** (Speichern).

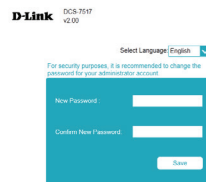

Die Live-Videoseite der Kamera wird geöffnet, und Sie können jetzt Ihre Kamera steuern und konfigurieren. Weitere Informationen zur Web-Konfiguration finden Sie in dem Benutzerhandbuch auf der D-Link-Website.



## Weitere Informationen

Zusätzliche Hilfe und Produktinformationen stehen Ihnen online unter <http://www.dlink.com> zur Verfügung.

## Garantiebestimmungen

Landesspezifische Informationen zu Gewährleistungen finden Sie unter <http://warranty.dlink.com/>.

---

# Guide d'installation rapide

Ce guide d'installation fournit des instructions élémentaires qui vous aideront à installer la DCS-7517. Pour obtenir des informations complémentaires sur l'utilisation de la caméra, consultez le Manuel d'utilisation, disponible sur le CD joint à ce coffret, ou sur le site Web d'assistance D-Link.

## Contenu de la boîte

- DCS-7517 Caméra réseau extérieure H.265 5 mégapixels
- Câble Ethernet
- Adaptateur de rallonge
- Patte et vis de montage
- Manuel et logiciel sur CD-ROM
- Guide d'installation rapide

Contactez votre revendeur s'il manque l'un des éléments ci-dessus.

### Remarque de sécurité :

L'installation et l'entretien doivent être réalisés par des techniciens qualifiés afin d'être conformes à tous les codes locaux et d'éviter d'annuler votre garantie.

## Description du matériel

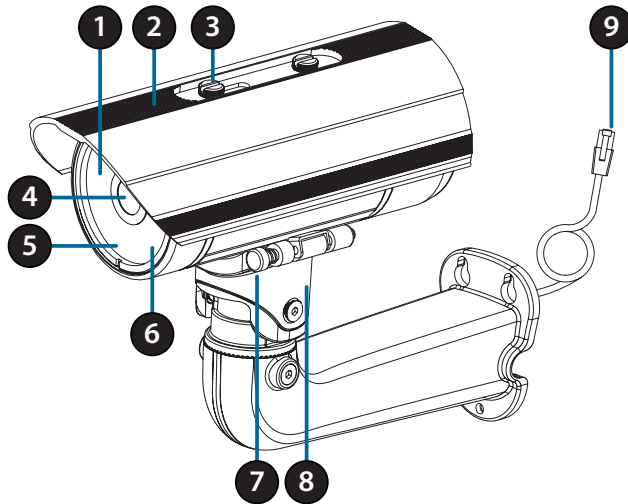

1	<b>Diodes IR</b>	Fournissent un éclairage pour les environnements sombres.
2	<b>Écran supérieur réglable</b>	Protège l'objectif de la caméra de la lumière directe du soleil.
3	<b>Vis de réglage</b>	Permet le positionnement de l'écran supérieur.
4	<b>Objectif de la caméra</b>	Objectif à focale variable pour enregistrer la vidéo de la zone autour de la caméra.
5	<b>Voyant d'alimentation/état</b>	Indique l'état actuel de la caméra.
6	<b>Capteur de lumière</b>	Mesure les conditions d'éclairage et alterne entre le mode de jour ou nuit de manière appropriée.
7	<b>Broche de dégagement rapide</b>	Permet de faire pivoter la caméra en position de maintenance aisée.
8	<b>Sabot de caméra</b>	Support de montage réglable pour la caméra.
9	<b>Connecteur Ethernet</b>	Permet la connexion à un port Ethernet RJ45. Peut être utilisé avec du PoE pour alimenter la caméra.

## Faisceau de câbles optionnel (non fourni)

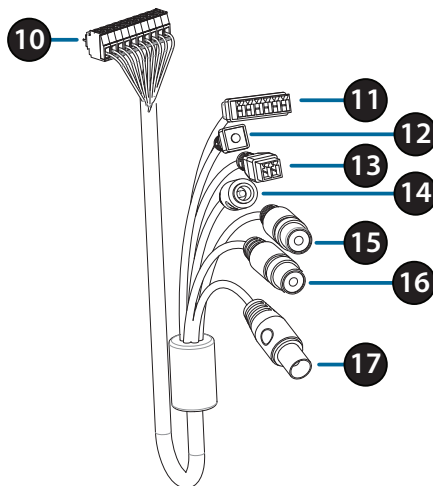

FRANÇAIS

10	<b>Connecteur de caméra</b>	Permet la connexion à la DCS-7517. Pour plus de détails sur le raccordement du câble A/V, reportez-vous au manuel de l'utilisateur.
11	<b>Connecteur DI/DO</b>	Connecteurs E/S pour périphériques externes
12	<b>Bouton de réinitialisation</b>	Appuyez dessus et maintenez-le enfoncé pendant 10 secondes pour réinitialiser la caméra à ses paramètres d'usine
13	<b>Connecteur d'alimentation 24V</b>	Non pris en charge pour la DCS-7517.
14	<b>Connecteur d'alimentation</b>	Connecteur d'alimentation pour un adaptateur secteur 12 V cc (non fourni).
15	<b>Sortie audio (vert)</b>	Raccordement à un haut-parleur.
16	<b>Entrée audio</b>	Raccordement à un microphone.
17	<b>Connecteur BNC</b>	Non pris en charge pour la DCS-7517.

## Internal

FRANÇAIS

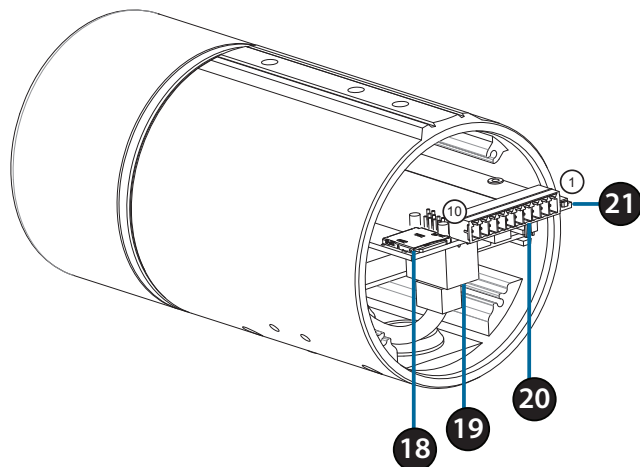

18	<b>Port de carte SD</b>	insérez une carte microSD de stockage local pour stocker des images et des vidéos enregistrées.	
19	<b>Port Ethernet</b>	Permet de connecter un câble Ethernet.	
20	<b>Connecteur de faisceau</b>	Permet de connecter le faisceau de câbles optionnel (non inclus)	
		1. 12V IN 2. GND 3. AUD IN 4. AUD GND 5. AUD OUT	6. 12V OUT 7. GND 8. astre tête RESET 9. DI 10. DO
21	<b>Bouton de réinitialisation</b>	Appuyez dessus et maintenez-le enfoncé pendant 10 secondes pour réinitialiser la caméra à ses paramètres d'usine	



## Raccordement au faisceau de câbles optionnel

Retirez le capot arrière de la caméra en le tournant dans le sens inverse des aiguilles d'une montre.

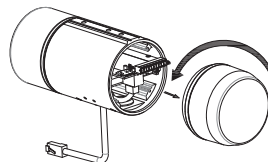

Retirez la fiche arrière étanche de la caméra.

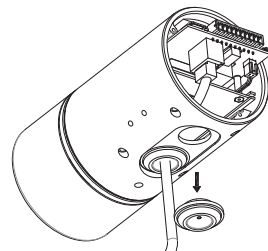

Poussez le connecteur de la caméra et le câble dans l'orifice et insérez la fiche étanche du câble.

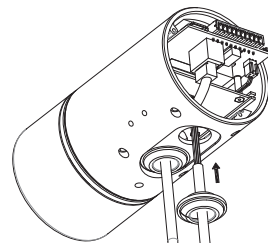

Assurez-vous que la fiche est correctement insérée pour assurer une bonne étanchéité.

Raccordez le connecteur de la caméra sur celle-ci.

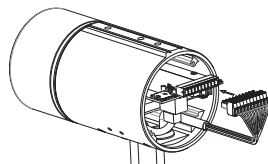

Rebranchez le capot arrière de la caméra en le tournant dans le sens des aiguilles d'une montre.

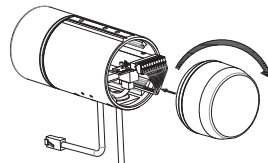

## Installation de la carte SD

Retirez le capot arrière de la caméra en le tournant dans le sens inverse des aiguilles d'une montre.

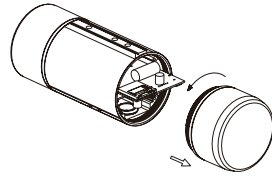

Insérez la carte microSD avec les contacts dirigés vers le bas, puis remettez le capot arrière en place. Assurez-vous que les joints étanches sont fermement en place.

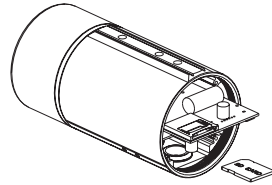

FRANÇAIS

## Instructions de montage

Reportez-vous au manuel d'utilisation pour des instructions détaillées sur la méthode d'installation et de montage de la caméra.

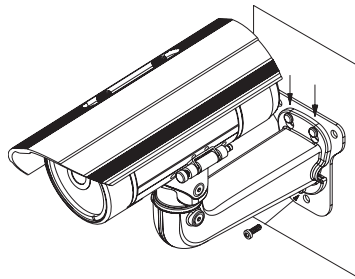
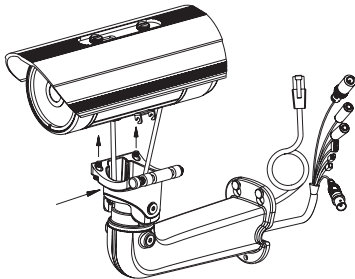
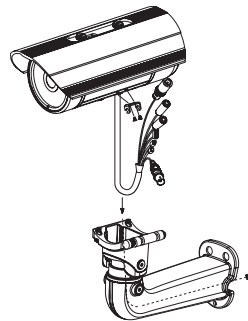
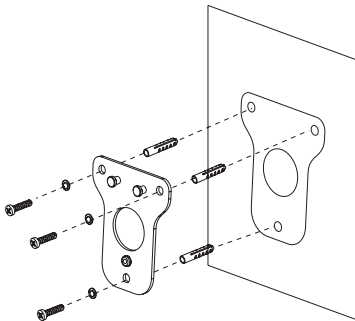

---

## Connexion de la caméra

### Connexion à l'aide d'un commutateur PoE

- Connectez le câble Ethernet à votre commutateur ou injecteur PoE. Le câble Ethernet fournit l'alimentation et une connexion réseau à la caméra.

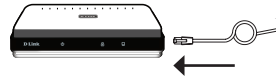

Si vous disposez du faisceau de câbles optionnel, vous pouvez également utiliser la méthode de connexion suivante :

### Connexion générale utilisant un adaptateur électrique 12 V cc (non fourni)

- Connectez le câble Ethernet à votre réseau.
- Connectez une extrémité de l'adaptateur secteur sur le connecteur d'alimentation situé sur votre caméra et l'autre sur une prise murale.

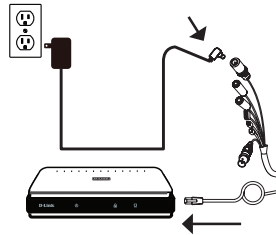

FRANÇAIS

# Configuration de la caméra

Insérez le CD de la DCS-7517 dans le lecteur de CD-ROM de l'ordinateur pour lancer l'installation. Si l'exécution automatique est désactivée ou si le dispositif de lancement D-Link ne parvient pas à démarrer automatiquement, cliquez sur le bouton Démarrer et saisissez **D:\autorun.exe** (où D: représente la lettre de votre lecteur de CD-ROM), puis appuyez sur Entrée.

Cliquez sur **Assistant de configuration** et suivez les instructions pour installer l'assistant de configuration.



Cliquez sur l'icône **Assistant de configuration D-Link SE** créée dans votre menu Démarrer de Windows (**Démarrer > D-Link > Assistant de configuration SE**).

L'Assistant de configuration s'ouvre et affiche les adresses MAC et IP de votre ou de vos caméras. Si un serveur DHCP se trouve sur votre réseau, une adresse IP valide s'affiche. Sinon, l'adresse IP statique par défaut de la caméra réseau **192.168.0.20** s'affiche. Sélectionnez votre caméra, puis cliquez sur **Assistant** pour continuer.

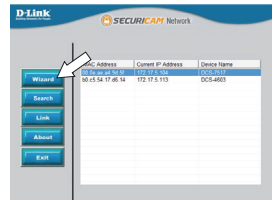

Saisissez l'ID admin et le mot de passe. Lorsque vous vous connectez pour la première fois, l'ID Admin par défaut est **admin** et le mot de passe est vierge.

Cliquez sur les cases si vous souhaitez changer l'ID admin et le mot de passe de la caméra, puis saisissez le nouvel ID et le nouveau mot de passe que vous souhaitez utiliser.



Cliquez sur **Suivant** pour continuer.

Sélectionnez **DHCP** si la caméra obtient une adresse IP automatiquement d'un serveur DHCP (par exemple, un routeur).

Sélectionnez **Adresse IP statique** si vous voulez saisir les paramètres IP de la caméra manuellement.

Cliquez sur **Suivant** pour continuer.



Prenez le temps de vérifier vos paramètres, puis cliquez sur **Redémarrer**.

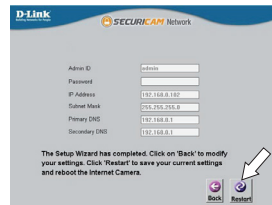

## Affichage de votre caméra via un navigateur Web

Cliquez sur l'icône **Assistant de configuration D-Link SE** créée dans votre menu Démarrer de Windows (**Démarrer > D-Link > Assistant de configuration SE**).

Sélectionnez la caméra, puis cliquez sur **Connexion** pour accéder à la configuration Web.

L'Assistant de configuration ouvre automatiquement votre navigateur Web à l'adresse IP de la caméra.

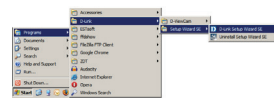

La première fois que vous vous connectez à la caméra, vous êtes invité à configurer un mot de passe pour le compte administrateur. Après avoir saisi un mot de passe, cliquez sur **Enregistrer**.

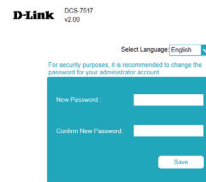

La page vidéo en direct de la caméra s'ouvre et vous pouvez maintenant commander et configurer votre caméra. Pour obtenir des informations complémentaires sur la configuration Web, reportez-vous au manuel d'utilisation qui est disponible sur le site Web de D-Link.



## Informations complémentaires

Vous trouverez une aide supplémentaire et des informations sur le produit en ligne à l'adresse <http://www.dlink.com>.

## Informations sur la garantie

Consultez le site <http://warranty.dlink.com/> pour prendre connaissance de la garantie appliquée dans votre région.

---

# Guía de instalación rápida

Esta guía de instalación proporciona instrucciones básicas para la instalación de la cámara DCS-7517. Para obtener información adicional acerca de cómo utilizar la cámara, consulte el Manual del usuario disponible en el CD incluido en el paquete o en el sitio web de asistencia de D-Link.

## ¿Qué contiene la caja?

- Cámara de red para exteriores de 5 megapíxeles H.265 DCS-7517
- Cable Ethernet
- Adaptador de extensión
- Soporte de montaje y tornillos
- Manual y software en CD-ROM
- Guía de instalación rápida

ESPAÑOL

Si falta cualquiera de los componentes anteriores, póngase en contacto con el proveedor.

### **Aviso de seguridad:**

La instalación y el mantenimiento deben realizarlo técnicos cualificados con el fin de cumplir con todos los códigos locales y evitar la anulación de la garantía.

## Descripción general del hardware

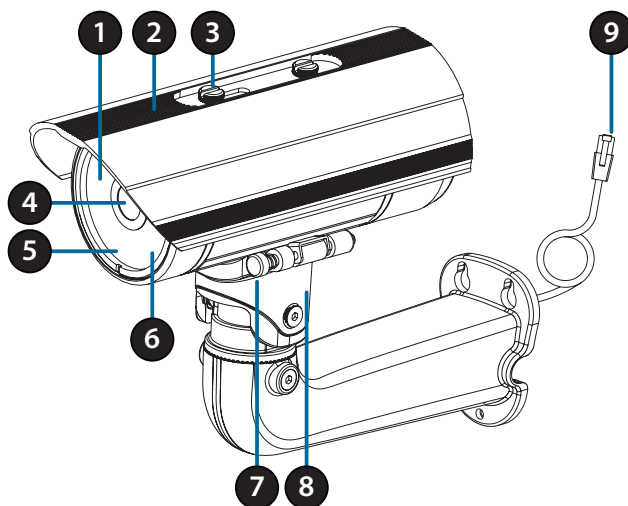

ESPAÑOL

1	<b>LED IR</b>	Proporcionan iluminación para entornos con poca luz.
2	<b>Protector superior ajustable</b>	Protege el sensor de la cámara de la luz solar directa.
3	<b>Tornillo de ajuste</b>	Permite la colocación del protector superior.
4	<b>Lente de la cámara</b>	Lente varifocal para grabar vídeo de la zona circundante.
5	<b>LED de alimentación/ estado</b>	Indica el estado actual de la cámara.
6	<b>Sensor de luz</b>	Mide las condiciones de iluminación y alterna entre los modos de día y de noche en consecuencia.
7	<b>Clavija de liberación rápida</b>	Permite girar la cámara para facilitar su mantenimiento.
8	<b>Zapata de la cámara</b>	Asiento de montura ajustable para la cámara.
9	<b>Clavija Ethernet</b>	Se conecta a un puerto Ethernet RJ45. Se puede usar con PoE para proporcionar alimentación a la cámara.

## Arnés para cables opcional (no incluido)

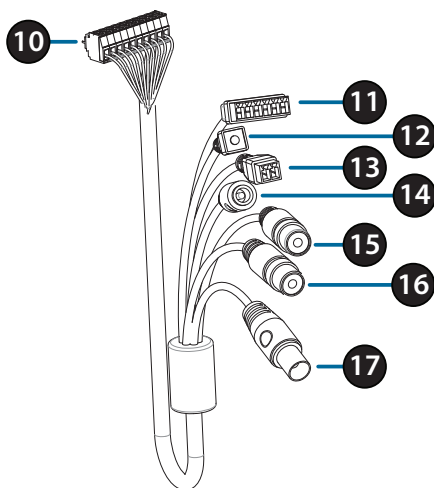

ESPAÑOL

10	<b>Conector de cámara</b>	Se conecta a la cámara DCS-7517. Para obtener más información sobre la conexión del cable A/V, consulte el Manual del usuario.
11	<b>Conector de DI/DO</b>	Conectores de E/S para dispositivos externos.
12	<b>Botón de reinicio</b>	Mantenga pulsado el botón durante 10 segundos para restablecer la cámara en los parámetros predeterminados de fábrica.
13	<b>Conector de alimentación de 24 V</b>	No admitido para la cámara DCS-7517.
14	<b>Conector de alimentación</b>	Conector de alimentación para un adaptador de corriente de 12 V CC (no incluido).
15	<b>Salida de audio (verde)</b>	Se conecta a un altavoz.
16	<b>Entrada de audio (rojo)</b>	Se conecta a un micrófono.
17	<b>Conector BNC</b>	No admitido para la cámara DCS-7517.



## Interno

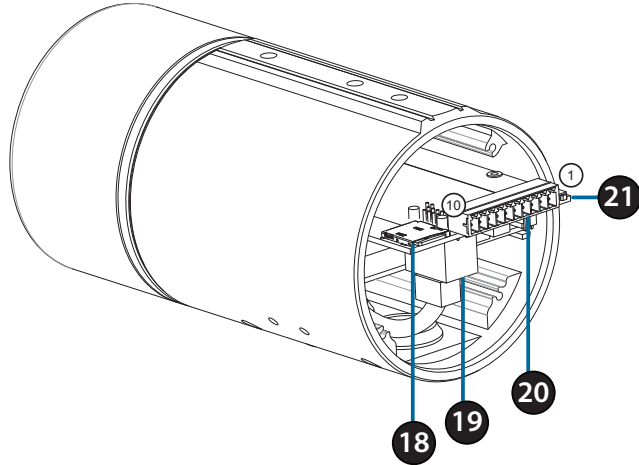

ESPAÑOL

18	<b>Bahía para tarjeta SD</b>	Introduzca una tarjeta microSD de almacenamiento local para guardar las imágenes y vídeos grabados.	
19	<b>Puerto Ethernet</b>	Se conecta a un cable Ethernet.	
20	<b>Conector de arnés</b>	Se conecta al arnés para el cable óptico (no incluido).	
		<ul style="list-style-type: none"> <li>1. ENTRADA 12V</li> <li>2. Toma de tierra</li> <li>3. ENTRADA AUD</li> <li>4. TIERRA AUD</li> <li>5. SALIDA AUD</li> </ul>	<ul style="list-style-type: none"> <li>6. SALIDA 12V</li> <li>7. Toma de tierra</li> <li>8. REINICIO</li> <li>9. DI</li> <li>10. DO</li> </ul>
21	<b>Botón de reinicio</b>	Pulse y mantenga pulsado el botón durante 10 segundos para reiniciar la cámara en los parámetros predeterminados de fábrica	

## Conexión del arnés para cables opcional

Retire la cubierta trasera de la cámara girándola hacia la izquierda.

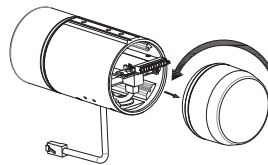

Retire tapón de estanqueidad trasero de la cámara.

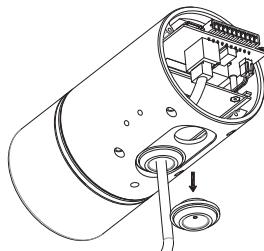

Pase el conector de la cámara y el cable por el agujero e inserte el tapón de estanqueidad del cable.

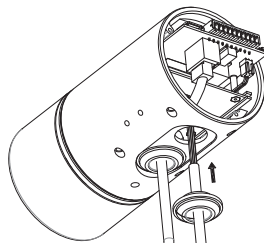

Asegúrese de que el tapón está correctamente insertado para que el cierre quede hermético.

Conecte el conector de la cámara a esta.

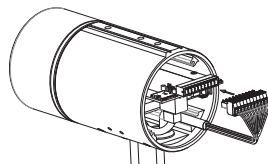

Vuelva a colocar la cubierta trasera de la cámara girándola hacia la derecha.

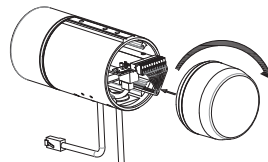

## Instalación de tarjeta SD

Retire la cubierta trasera de la cámara girándola hacia la izquierda.

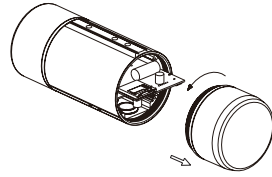

Inserte la tarjeta microSD con los contactos hacia abajo; a continuación, vuelva a colocar la cubierta trasera. Asegúrese de que los cierres herméticos quedan fijados firmemente.

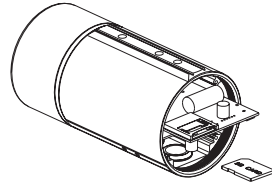

ESPAÑOL

## Instrucciones de montaje

Consulte el Manual del usuario para obtener instrucciones detalladas sobre el modo de instalar y montar la cámara.

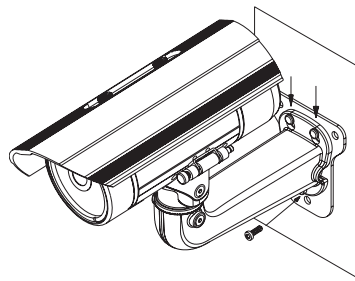
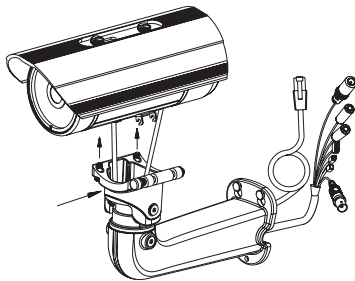
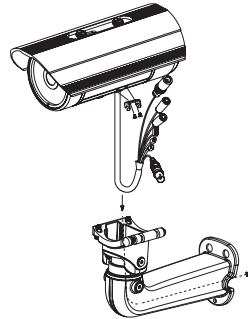
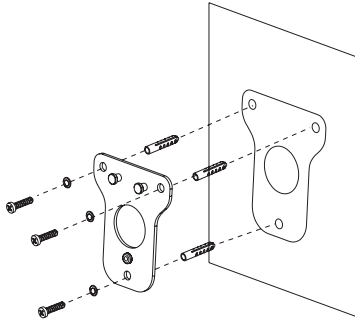

---

## Conexión de la cámara

### Conexión con un conmutador PoE

- Conecte el cable Ethernet al conmutador o inyector PoE. El cable Ethernet proporcionará a la cámara tanto alimentación como una conexión de red.



Si tiene el **arnés de cables opcional**, también puede seguir el siguiente método de conexión:

### Conexión general mediante adaptador de alimentación de 12 V CC (no incluido)

- Conecte el cable Ethernet a su red.
- Conecte el adaptador de alimentación al conector de la cámara y, a continuación, enchufe el adaptador de alimentación.

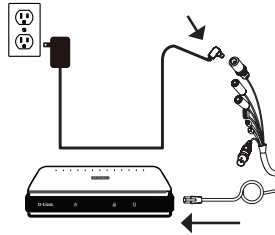

## Configuración de la cámara

Inserte el CD de la DCS-7517 en la unidad de CD-ROM del ordenador para comenzar la instalación. Si la ejecución automática está desactivada o si el iniciador de D-Link no se inicia automáticamente, haga clic en el botón Start (Inicio) y escriba **D:\autorun.exe** (donde D: representa la letra de unidad de la unidad de CD-ROM) y pulse Enter (Intro).

Haga clic en **Setup Wizard** (Asistente de configuración) y siga las instrucciones para instalar el asistente de configuración.

Haga clic en el icono **Asistente de configuración SE D-Link** que se creó en el menú de inicio de Windows (**Inicio > D-Link > Asistente de configuración SE**).

Aparecerá el asistente de configuración y se mostrará la dirección MAC y la dirección IP de la cámara. Si tiene un servidor DHCP en la red, se mostrará una dirección IP válida. En caso contrario se mostrará la dirección IP estática predeterminada de la cámara, **192.168.0.20**. Seleccione la cámara y, a continuación, haga clic en el botón **Wizard** (Asistente) para continuar.

Introduzca el ID de administrador y la contraseña. Al iniciar sesión por primera vez, el ID de administrador predeterminado es **admin**, con la contraseña en blanco.

Haga clic en las casillas de verificación si desea cambiar el ID de administrador y la contraseña para la cámara e introduzca el nuevo ID y contraseña que desee utilizar.

Haga clic en **Next** (Siguiente) para continuar.

Seleccione **DHCP** si la cámara consigue una dirección IP automáticamente de un servidor DHCP como, por ejemplo, un router.

Seleccione **Static IP** (IP estática) si desea introducir manualmente los parámetros IP de la cámara.

Haga clic en **Next** (Siguiente) para continuar.

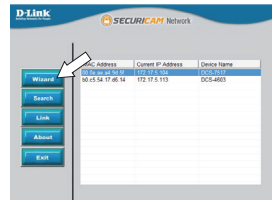
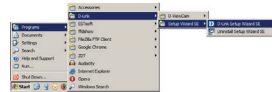

Tómese un tiempo para confirmar la configuración y haga clic en **Restart** (Reiniciar).

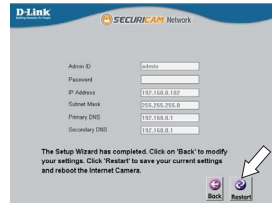

## Visualización de su cámara a través del explorador de web

Haga clic en el icono **Asistente de configuración SE D-Link** que se creó en el menú de inicio de Windows (**Inicio > D-Link > Asistente de configuración SE**).

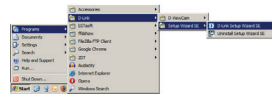

Seleccione la cámara y haga clic en **Link** (Vincular) para acceder a la configuración web.

El asistente de configuración abrirá automáticamente el explorador de web en la dirección IP de la cámara.



La primera vez que se conecte a la cámara, se le pedirá que introduzca una contraseña para la cuenta del administrador. Después de introducir una contraseña, haga clic en **Save** (Guardar).

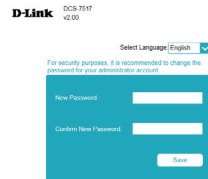

Se abrirá la página de vídeo en directo, desde donde podrá controlar y configurar la cámara. Para obtener información adicional acerca de la configuración web, consulte el manual de usuario, disponible en el sitio web de D-Link.



## Información adicional

Existe ayuda e información del producto adicional en línea en <http://www.dlink.com>.

## Información acerca de la garantía

Visite <http://warranty.dlink.com/> para obtener información sobre la garantía en su región.

---

# Guida di installazione rapida

In questa guida di installazione sono riportate le istruzioni di base per installare il dispositivo DNS-7517. Per ulteriori informazioni sull'utilizzo della videocamera, consultare il manuale utente disponibile sul CD incluso nella confezione o scaricabile dal sito Web di supporto di D-Link.

## Contenuto della confezione

- DCS-7517 Videocamera di rete da esterni H.265 da 5 Megapixel
- Cavo Ethernet
- Adattatore prolunga
- Staffa di montaggio e viti
- Manuale e software su CD-ROM
- Guida di installazione rapida

Se uno o più degli articoli sopra elencati risultano mancanti, rivolgersi al rivenditore.

### **Nota relativa alla sicurezza:**

Per evitare di invalidare la garanzia, l'installazione e le riparazioni devono essere effettuate da tecnici qualificati in conformità alle normative locali.

## Panoramica hardware

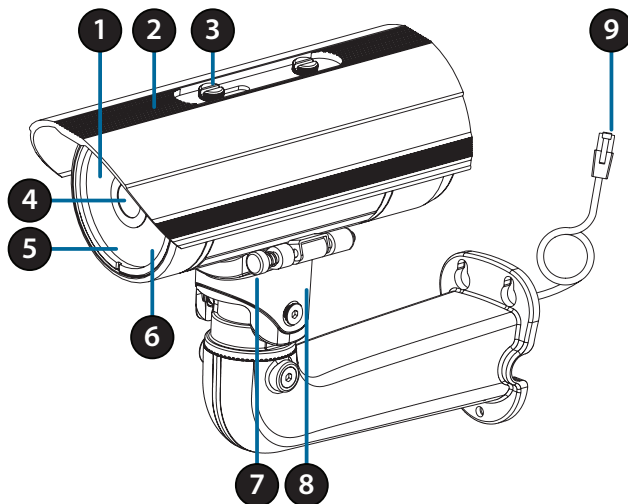

ITALIANO

1	<b>LED IR</b>	Forniscono illuminazione in ambienti scarsamente illuminati.
2	<b>Schermo superiore regolabile</b>	Protegge l'obiettivo della videocamera dalla luce diretta del sole.
3	<b>Vite di regolazione</b>	Consente di posizionare lo schermo superiore.
4	<b>Obiettivo della videocamera</b>	Obiettivo varifocale per registrare i video dell'area circostante.
5	<b>LED di alimentazione/stato</b>	Indica lo stato corrente della telecamera.
6	<b>Sensore di luce</b>	Misura le condizioni di illuminazione e passa dalla modalità notturna alla diurna e viceversa, a seconda delle esigenze.
7	<b>Pin di rilascio rapido</b>	Consente alla videocamera di essere posizionata in modo ottimale per la manutenzione.
8	<b>Slitta videocamera</b>	Sede di montaggio regolabile per la videocamera.
9	<b>Spinotto Ethernet</b>	Si connette a una porta Ethernet RJ45. Può essere usato con PoE per fornire alimentazione alla videocamera.



## Cablaggio opzionale (non incluso)

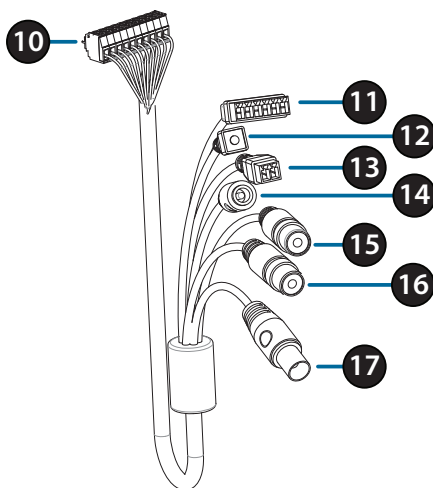

10	<b>Connettore videocamera</b>	Si connette a DCS-7517. Per maggiori dettagli sulla connessione con il cavo A/V, consultare il Manuale utente.
11	<b>Connettore DI/DO</b>	Connettori I/O per dispositivi esterni.
12	<b>Pulsante di reset</b>	Tenere premuto il pulsante per 10 secondi per ripristinare le impostazioni predefinite della telecamera
13	<b>Connettore di alimentazione 24 V</b>	Non supportato per DCS-7517.
14	<b>Connettore di alimentazione</b>	Connettore di alimentazione per un adattatore di potenza da 12 V CC (non incluso).
15	<b>Uscita audio (verde)</b>	Per il collegamento a un altoparlante.
16	<b>Ingresso audio (rosso)</b>	Per il collegamento a un microfono.
17	<b>Connettore BNC</b>	Non supportato per DCS-7517.

## Interna

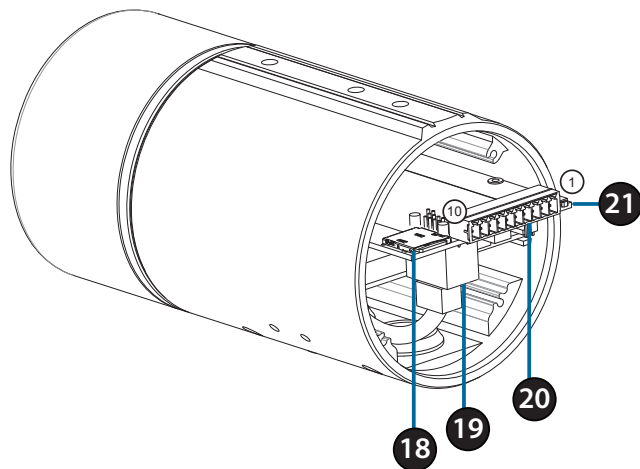

ITALIANO

18	<b>Slot per schede SD</b>	Inserire una scheda microSD per l'archiviazione locale di immagini e video registrati.	
19	<b>Porta Ethernet</b>	Collegamento di un cavo Ethernet.	
20	<b>Harness connettore</b>	Si collega all'harness cavo opzionale (non incluso).	
		1. IN 12V 2. GND 3. IN AUD 4. GND AUD 5. USC AUD	6. USC 12V 7. GND 8. REIMPOSTA 9. DI 10. DO
21	<b>Pulsante di reset</b>	Tenerlo premuto il pulsante per 10 secondi per ripristinare le impostazioni predefinite della telecamera	

## Connessione al cablaggio opzionale

Rimuovere la copertura della videocamera posteriore ruotandola in senso anti-orario.

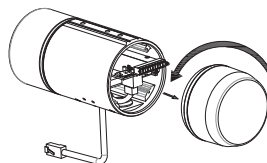

Rimuovere la presa impermeabile posteriore dalla videocamera.

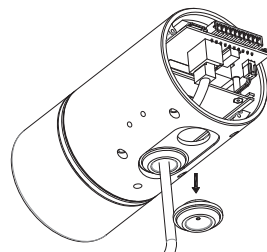

Premere il connettore della videocamera e il cavo attraverso il foro, quindi inserire la presa impermeabile del cavo.

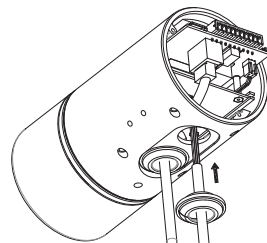

Verificare che la presa sia inserita correttamente per garantire un corretto isolamento.

Collegare il connettore della videocamera alla videocamera.

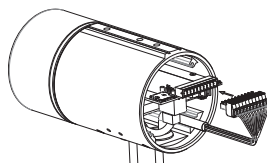

Ricollegare la copertura della videocamera posteriore ruotandola in senso orario.

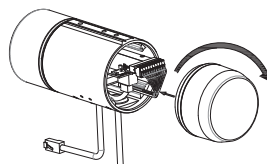

ITALIANO

## Installazione della scheda SD

Rimuovere la copertura della videocamera posteriore ruotandola in senso anti-orario.

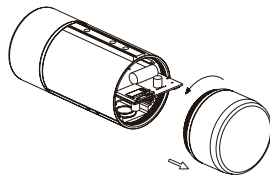

Inserire la scheda microSD con i contatti rivolti in basso, quindi ricollegare la copertura posteriore. Verificare che le guarnizioni impermeabili siano fissate fermamente in posizione.

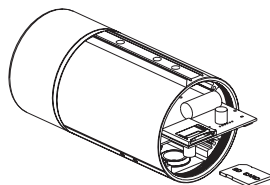

ITALIANO

## Istruzioni per il montaggio

Per istruzioni dettagliate sull'installazione e il montaggio della videocamera, consultare il Manuale utente.

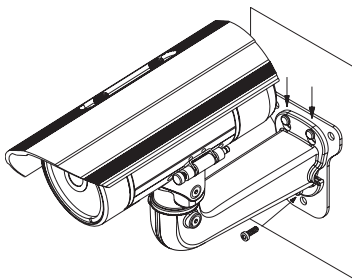
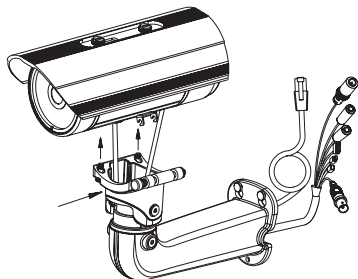
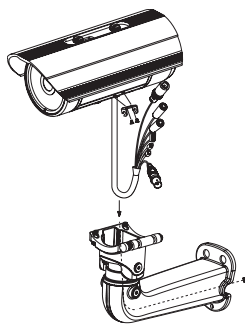
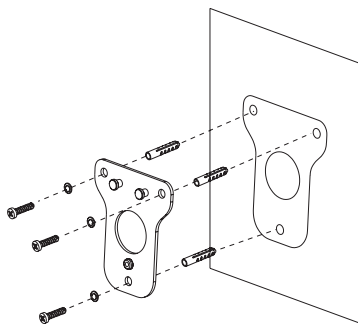

---

## Collegamento della videocamera

### Collegamento con uno switch PoE

- Collegare il cavo Ethernet allo switch PoE o all'iniettore. Il cavo Ethernet fornirà alla videocamera l'alimentazione e una connessione di rete.



**Se si dispone del cablaggio opzione, è possibile adottare anche il seguente metodo di collegamento:**

### Collegamento generale tramite adattatore di alimentazione da 12 V CC (non incluso)

- Collegare il cavo Ethernet alla rete.
- Collegare l'adattatore di alimentazione al connettore di alimentazione della videocamera, quindi collegarlo all'adattatore di alimentazione.

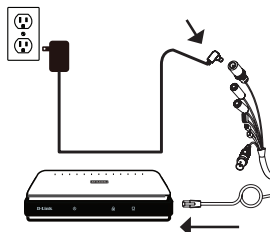

ITALIANO

## Configurazione della videocamera

Inserire il CD DCS-7517 CD nell'unità CD-ROM del computer per avviare l'installazione. Se Autorun è disabilitato oppure se il D-Link Launcher non si avvia automaticamente, fare clic sul pulsante Start e digitare **D:\autorun.exe** (dove D: rappresenta la lettera dell'unità CD-ROM), quindi premere Invio.

Fare clic su **Configurazione guidata** e attenersi alle istruzioni per installare la Configurazione guidata.



Fare clic sull'icona **Configurazione guidata SE D-Link** creata nel menu Start di Windows (**Start > D-Link > Configurazione guidata SE**).

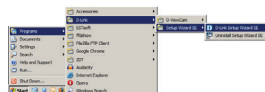

Viene visualizzata la pagina dell'installazione guidata che riporta l'indirizzo MAC e l'indirizzo IP della telecamera. Se la rete dispone di un server DHCP, viene visualizzato un indirizzo IP valido. In alternativa, sarà visualizzato l'IP statico predefinito della videocamera di rete **192.168.0.20**. Selezionare la videocamera, quindi fare clic sul pulsante **Wizard** (Procedura guidata) per continuare.

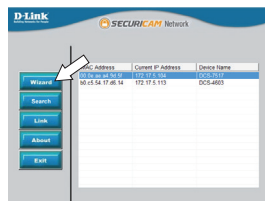

Immettere l'ID dell'amministratore e la password. Quando si effettua l'accesso per la prima volta, l'ID predefinito dell'amministratore è **admin**, mentre la password viene lasciata vuota.



Selezionare le caselle di controllo se si desidera cambiare l'ID e la password dell'amministratore della telecamera e immettere quelli nuovi da utilizzare.

Fare clic su **Avanti** per continuare.

Selezionare **DHCP** se la telecamera ottiene un indirizzo IP automaticamente da un server DHCP, ad esempio un router.

Selezionare **IP statico** se si desidera immettere manualmente le impostazioni IP della telecamera.

Fare clic su **Avanti** per continuare.



Verificare le impostazioni, quindi fare clic su **Riavvia**.

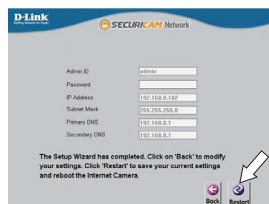

## Visualizzazione della telecamera tramite il browser Web

Fare clic sull'icona **D-Link Setup Wizard SE** creata nel menu Start di Windows (**Start > D-Link > Setup Wizard SE**).

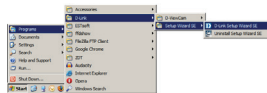

Selezionare la telecamera e fare clic su **Collegamento** per accedere alla configurazione Web.



La procedura guidata di configurazione apre automaticamente il browser Web all'indirizzo IP della telecamera.

La prima volta che ci si connette alla videocamera, verrà chiesto di impostare una password per l'account amministratore. Dopo avere inserito una password, fare clic su **Salva**.



La pagina video live della videocamera verrà aperta e sarà possibile controllare e configurare la videocamera. Per ulteriori informazioni sulla configurazione Web, fare riferimento al manuale utente, disponibile sul sito Web di D-Link.



## Ulteriori informazioni

Per maggiori informazioni e dettagli sul prodotto, visitare il sito Web all'indirizzo <http://www.dlink.com>.

## Termini di garanzia

Per informazioni sulla garanzia nel proprio paese, visitare il sito <http://warranty.dlink.com/>.

---

# Краткое руководство по установке

Данное руководство содержит основные инструкции по установке камеры DCS-7517. Для получения дополнительной информации по настройке камеры, пожалуйста, обратитесь к руководству пользователя на CD-диске из комплекта поставки или через Web-сайт D-Link.

## Комплект поставки

- 5 Мп внешняя сетевая камера с поддержкой PoE DCS-7517
- Ethernet-кабель
- Соединитель Ethernet-кабеля
- Комплект для монтажа
- CD-диск с руководством пользователя и программным обеспечением
- Краткое руководство по установке

Если что-либо из перечисленного отсутствует, пожалуйста, обратитесь к поставщику.

### Меры безопасности:

Во избежание прекращения гарантии, установку и обслуживание должны проводить сертифицированные специалисты в соответствии с региональными нормами и правилами.



## Обзор аппаратной части

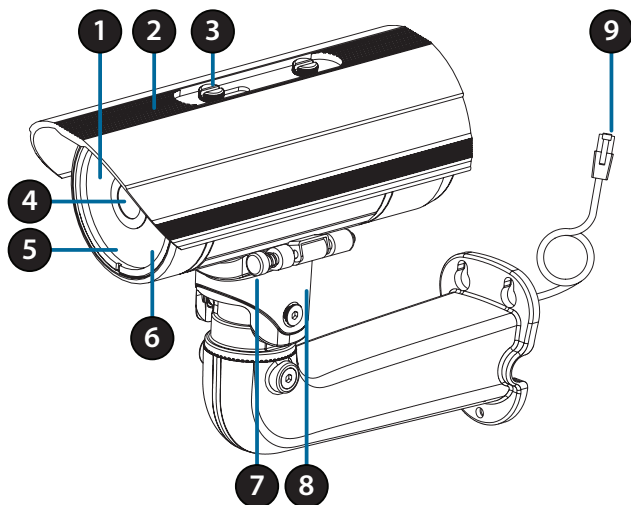

1	Инфракрасные диоды	Используются для работы камеры в ночное время.
2	Солнцезащитный козырек	Регулируемый солнцезащитный козырек защищает объектив камеры от прямого солнечного света.
3	Крепежный винт	Винт для крепления солнцезащитного козырька.
4	Объектив камеры	Вариофокальный объектив.
5	Индикатор питания/состояния (Power/Status)	Показывает текущий статус подключения камеры.
6	Светочувствительный датчик	Используется для определения условий освещения.
7	Регулировочный винт	Используется для быстрой регулировки положения камеры.
8	Кронштейн	Регулируемый кронштейн для крепления камеры.
9	Ethernet-разъем	Разъем RJ-45 для подключения Ethernet-кабеля, а также для подачи питания по технологии Power over Ethernet (PoE).

## Дополнительный жгут проводов (не входит в комплект поставки)

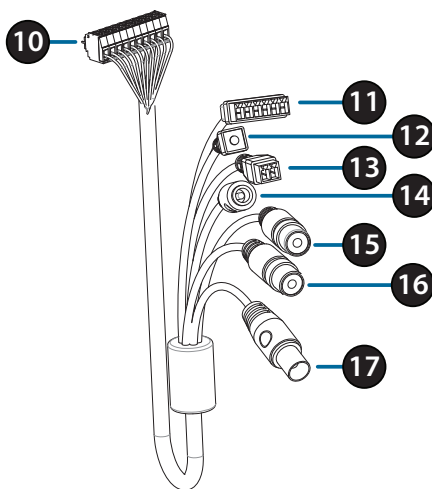

10	Коннектор для подключения к камере	Используется для подключения к DCS-7517. Для получения дополнительной информации о подключении кабеля A/V обратитесь к руководству пользователя.
11	Разъемы DI/DO	Разъемы для подключения внешних устройств.
12	Кнопка Reset	Нажмите и удерживайте эту кнопку в течение 10 секунд для сброса настроек камеры к заводским установкам
13	Разъем питания 24 В	Не поддерживается для DCS-7517
14	Разъем питания	Используется для подключения адаптера питания постоянного тока 12 В (не входит в комплект поставки)
15	Аудиовыход (зеленый)	Используется для подключения динамиков
16	Аудиовход (красный)	Используется для подключения микрофона
17	BNC	Не поддерживается для DCS-7517

## Обзор аппаратной части

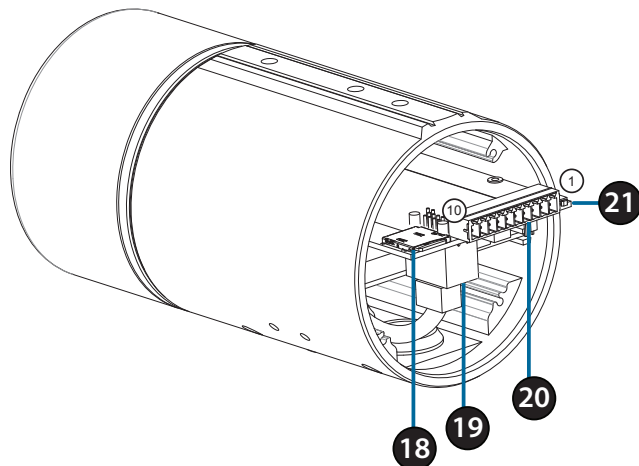

18	Слот для SD-карты	Вставьте microSD-карту для хранения записанных видео и снимотов на устройстве.	
19	Ethernet-порт	Разъем для подключения Ethernet-кабеля.	
20	Разъем для дополнительного жгута проводов	Подключение дополнительного жгута проводов (не входит в комплект поставки).	
		1. 12V IN 2. GND 3. AUD IN 4. AUD GND 5. AUD OUT	6. 12V OUT 7. GND 8. RESET 9. DI 10. DO
21	Кнопка Reset	Нажмите и удерживайте эту кнопку в течение 10 секунд для сброса настроек камеры к заводским установкам.	

## Подключение дополнительного жгута проводов

Снимите заднюю панель камеры, повернув ее против часовой стрелки.

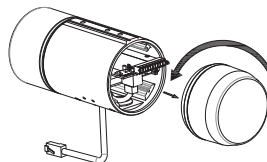

Снимите с камеры водонепроницаемую заглушку.

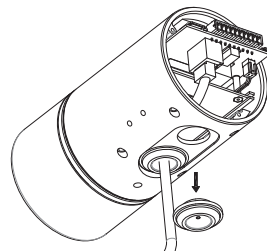

Протяните коннектор для подключения к камере через отверстие, затем установите водонепроницаемую заглушку.

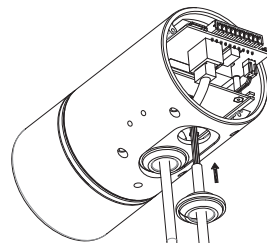

Убедитесь, что водонепроницаемая заглушка надежно зафиксирована.

Подключите коннектор к камере.

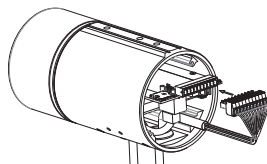

Соедините заднюю панель с камерой, повернув ее по часовой стрелке.

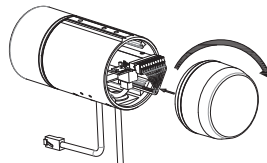

## Установка SD-карты

Снимите заднюю панель камеры, повернув ее против часовой стрелки.

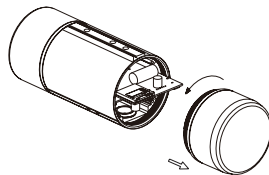

Установите microSD-карту в слот для карты контактами вниз, затем установите заднюю панель камеры. Убедитесь, что элементы, защищающие камеру, надежно зафиксированы.

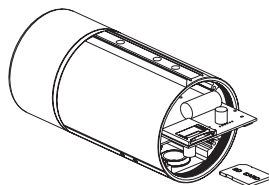

## Инструкции по установке

За подробной информацией относительно установки и монтажа камеры, пожалуйста, обратитесь к руководству пользователя.

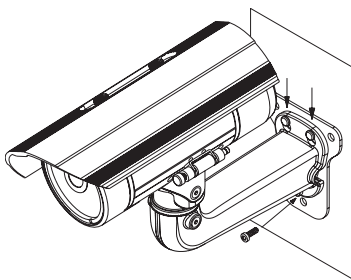
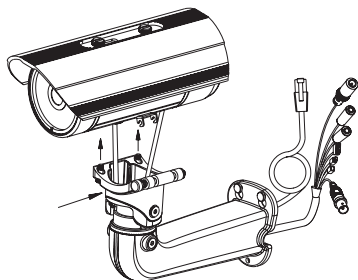
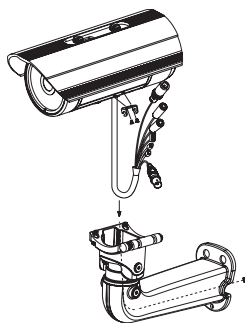
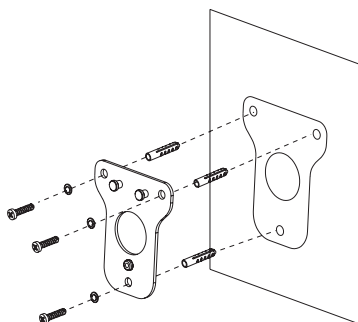

РУССКИЙ

## Подключение камеры

### Подключение с помощью PoE-коммутатора

- Подключите сетевую камеру к PoE-коммутатору или инжектору с помощью Ethernet-кабеля. Данные и питание будут передаваться по одному кабелю.



При наличии дополнительного жгута проводов, Вы можете воспользоваться следующим способом подключения:

### Основное подключение с помощью адаптера питания 12 В постоянного тока (не входит в комплект поставки)

- Подключите камеру к коммутатору или маршрутизатору через Ethernet-кабель.
- Подключите кабель питания от камеры к адаптеру питания, затем подключите адаптер питания к розетке.

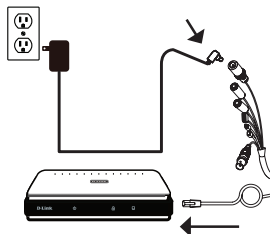

## Настройка камеры

Вставьте диск с программным обеспечением для DCS-7517 в привод CD-ROM для начала установки. Если на компьютере отключена функция автоматического запуска, или D-Link Launcher не запускается автоматически, нажмите **Пуск > Выполнить**. Введите **D:\autorun.exe**, где D: – имя привода CD-ROM, и нажмите Enter.

Нажмите **Setup Wizard (Мастер Установки)** и следуйте инструкциям для установки.



Выберите ярлык **D-Link Setup Wizard SE** в стартовом меню Windows (**Пуск > D-Link > Setup Wizard SE**).

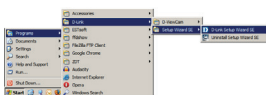

Открывается окно Мастера Установки, где будет отображен MAC-адрес и IP-адрес Вашей камеры. Если в сети используется DHCP-сервер, то будет отображен IP-адрес, назначенный этим сервером. Если в сети не используется DHCP-сервер, то отобразится статический IP-адрес камеры по умолчанию: **192.168.0.20**. Выберите камеру и нажмите кнопку **Wizard** для продолжения.

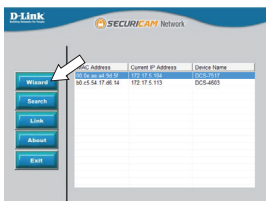

Введите имя пользователя (Admin ID) и пароль (Password). Имя пользователя по умолчанию – **admin**, поле для пароля оставьте пустым.

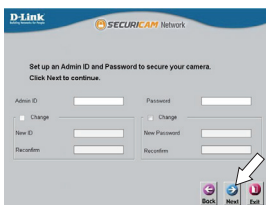

Установите галочку, если Вы хотите поменять имя пользователя и пароль камеры, и введите новое имя пользователя и пароль.

Нажмите **Next (Далее)**, чтобы перейти на следующую страницу.

Выберите **DHCP**, если хотите, чтобы камера автоматически получала IP-адрес, назначенный DHCP-сервером. Выберите **Static IP (Статический IP-адрес)**, если хотите, чтобы камера использовала постоянный IP-адрес.

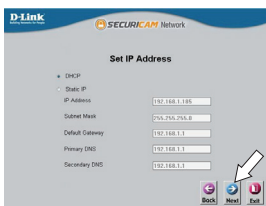

Нажмите **Next (Далее)**, чтобы перейти на следующую страницу.

РУССКИЙ

Проверьте настройки и нажмите **Restart** (Перезапустить).

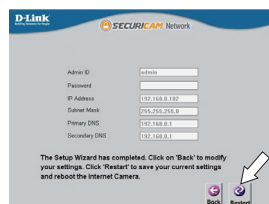

## Просмотр изображения камеры через Web браузер

Выберите ярлык **D-Link Setup Wizard SE** в стартовом меню Windows (Пуск > D-Link > Setup Wizard SE).

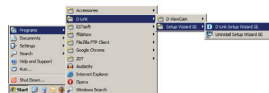

Выберите камеру и нажмите кнопку **Link** для доступа к настройкам сети.



Мастер установки автоматически откроет Web-браузер по IP-адресу камеры.

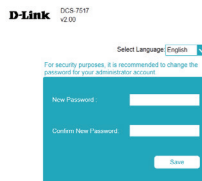

При первом подключении камеры необходимо задать пароль для учетной записи администратора. Введите пароль, затем нажмите **Save (Сохранить)**.

В данном разделе доступен просмотр видео с камеры в реальном времени. Для получения дополнительной информации о настройке камеры обратитесь к руководству пользователя, доступному на Web-сайте D-Link.



## Дополнительная информация

Дополнительная помощь и информация об устройстве доступна на Web-сайте <http://www.dlink.com>.

## Информация о гарантии

Информация о гарантии для Вашего региона доступна на Web-сайте <http://warranty.dlink.com>.



## Технические характеристики

Технические характеристики		
Аппаратное обеспечение		
Интерфейсы	<ul style="list-style-type: none"> <li>Порт 10/100 Base-TX с поддержкой PoE</li> <li>DI/DO</li> </ul>	<ul style="list-style-type: none"> <li>Слот для карты microSD</li> <li>Аудио вход/выход</li> </ul>
Индикаторы	<ul style="list-style-type: none"> <li>Питания/состояния</li> </ul>	
Корпус	<ul style="list-style-type: none"> <li>Всепогодный корпус (стандарт IP68)</li> </ul>	<ul style="list-style-type: none"> <li>Кронштейн для кабелей</li> </ul>
Параметры камеры		
Основные характеристики	<ul style="list-style-type: none"> <li>1/2,9-дюймовый двухмегапиксельный CMOS-сенсор с технологией прогрессивного сканирования</li> <li>Моторизованный вариофокальный объектив с фокусным расстоянием 2,8 ~ 12 мм</li> <li>Апертура: F1.4</li> <li>Минимальное расстояние до объекта: 500 мм (ширина 3 мм)</li> <li>Углы обзора (16:9):                             <ul style="list-style-type: none"> <li>- 75°~24° (по горизонтали)</li> <li>- 55°~18° (по вертикали)</li> <li>- 96°~30° (по диагонали)</li> </ul> </li> <li>10-кратное цифровое увеличение</li> </ul>	<ul style="list-style-type: none"> <li>Минимальное освещение:                             <ul style="list-style-type: none"> <li>- Цветной режим: 0,01 люкс / F1.4</li> <li>- Черно-белый режим: 0,008 люкс / F1.4</li> </ul> </li> <li>Черно-белый режим с инфракрасной подсветкой: 0 люкс / F1.4</li> <li>Расстояние инфракрасной подсветки: 30 м</li> <li>Встроенный ICR-фильтр</li> </ul>
Характеристики изображения	<ul style="list-style-type: none"> <li>Настройка качества и размера изображения, скорости передачи кадров и скорости передачи данных</li> <li>Метки времени и вставки текста</li> <li>Настраиваемые окна для обнаружения движения</li> </ul>	<ul style="list-style-type: none"> <li>Настраиваемые зоны приватных масок</li> <li>Настройка скорости затвора, яркости, насыщенности цвета, контраста, резкости, увеличения, фокуса и апертуры</li> </ul>
Сжатие видео	<ul style="list-style-type: none"> <li>Сжатие видео в формате H.265/H.264/MJPEG</li> <li>H.265/H.264 multicast-вещание</li> </ul>	<ul style="list-style-type: none"> <li>Сжатие в формате JPEG для стоп-кадров</li> </ul>
Разрешение видео	<ul style="list-style-type: none"> <li>16:9 – 1920 x 1080, 1280 x 720, 960 x 560, 640 x 360, 320 x 176 до 30 кадров/с</li> </ul>	<ul style="list-style-type: none"> <li>4:3 – 2592 x 1944, 1280 x 960, 1024 x 768, 800 x 600, 640 x 480, 480 x 360, 320 x 240 до 30 кадров/с</li> </ul>
Аудио	<ul style="list-style-type: none"> <li>G.711</li> </ul>	<ul style="list-style-type: none"> <li>AAC</li> </ul>
Сеть		
Сетевые протоколы	<ul style="list-style-type: none"> <li>IPv6</li> <li>IPv4</li> <li>TCP/IP</li> <li>UDP</li> <li>ICMP</li> <li>DHCP-клиент</li> <li>NTP-клиент (D-Link)</li> <li>DNS-клиент</li> <li>DDNS-клиент (D-Link)</li> <li>SMTP-клиент</li> <li>FTP-клиент</li> <li>HTTP/HTTPS</li> </ul>	<ul style="list-style-type: none"> <li>Samba-клиент</li> <li>PPPoE</li> <li>UPnP port forwarding</li> <li>RTP/RTSP/RTCP</li> <li>Фильтрация IP-адресов</li> <li>QoS</li> <li>CoS</li> <li>Multicast</li> <li>Bonjour</li> <li>802.1x</li> <li>SNMP</li> <li>Соответствие ONVIF</li> </ul>
Безопасность	<ul style="list-style-type: none"> <li>Защита учетной записи администратора и группы пользователей</li> <li>Аутентификация по паролю</li> </ul>	<ul style="list-style-type: none"> <li>Аутентификация HTTP и RTSP</li> </ul>

Управление		
Управление событиями	<ul style="list-style-type: none"> <li>• Обнаружение движения</li> <li>• Уведомление о событии и загрузка стоп-кадров/видеоклипов на электронную почту или FTP-сервер</li> </ul>	<ul style="list-style-type: none"> <li>• Поддержка нескольких серверов SMTP и FTP</li> <li>• Несколько уведомлений о событии</li> <li>• Несколько способов записи для создания резервных копий</li> </ul>
Удаленное управление	<ul style="list-style-type: none"> <li>• Создание стоп-кадров/видеоклипов и сохранение на локальный жесткий диск</li> </ul>	<ul style="list-style-type: none"> <li>• Интерфейс настройки, доступный через Web-браузер</li> </ul>
Дополнительное ПО D-ViewCam™	<ul style="list-style-type: none"> <li>• Удаленное управление/контроль: до 32 камер</li> <li>• Просмотр изображений на одном экране: до 32 камер</li> </ul>	<ul style="list-style-type: none"> <li>• Поддержка всех функций управления, доступных через Web-интерфейс</li> <li>• Опции записи по срабатыванию датчика, по расписанию или вручную</li> </ul>
Системные требования		
Системные требования для Web-интерфейса	<ul style="list-style-type: none"> <li>• Операционная система: Microsoft Windows 10/8/7, Mac OS 10.XX</li> <li>• Web-браузер: Internet Explorer, Firefox или, Safari (Mac OS)</li> </ul>	
Системные требования для ПО D-ViewCam™	<ul style="list-style-type: none"> <li>• Операционная система: Microsoft Windows 8/7/Vista/XP</li> <li>• Web-браузер: Internet Explorer 7 или выше</li> <li>• Протокол: Стандартный TCP/IP</li> </ul>	
Физические параметры		
Вес	<ul style="list-style-type: none"> <li>• 1,54 кг с кронштейном и солнцезащитным козырьком</li> </ul>	
Размеры (Д x Ш x В)	<ul style="list-style-type: none"> <li>• 312,37 x 100 x 243,75 мм (с кронштейном)</li> <li>• 222,1 x 98,33 x 86,7 мм (без кронштейна)</li> </ul>	
Условия эксплуатации		
Питание	<ul style="list-style-type: none"> <li>• Внешний адаптер питания: Вход: от 100 до 240 В переменного тока, 50/60 Гц Выход: 12 В, 1,5 А</li> <li>• Питание по кабелю Ethernet (PoE) 802.3af (Класс 3)</li> </ul>	
Потребляемая мощность	<ul style="list-style-type: none"> <li>• 10 Вт ± 5%</li> </ul>	
Температура	<ul style="list-style-type: none"> <li>• Рабочая: от -40 до 50 °C</li> <li>• Хранения: от -20 до 70 °C</li> </ul>	
Влажность	<ul style="list-style-type: none"> <li>• При эксплуатации: от 20% до 80% (без конденсата)</li> <li>• При хранении: от 5% до 95% (без конденсата)</li> </ul>	
Прочее		
Сертификаты	<ul style="list-style-type: none"> <li>• CE</li> <li>• CE LVD</li> </ul>	<ul style="list-style-type: none"> <li>• FCC</li> <li>• C-Tick</li> </ul>

## ТЕХНИЧЕСКАЯ ПОДДЕРЖКА

Обновления программного обеспечения и документация доступны на Интернет-сайте D-Link. D-Link предоставляет бесплатную поддержку для клиентов в течение гарантийного срока. Клиенты могут обратиться в группу технической поддержки D-Link по телефону или через Интернет.

Техническая поддержка компании D-Link работает в круглосуточном режиме ежедневно, кроме официальных праздничных дней. Звонок бесплатный по всей России.

### Техническая поддержка D-Link:

8-800-700-5465

### Техническая поддержка через Интернет:

<http://www.dlink.ru>

e-mail: [support@dlink.ru](mailto:support@dlink.ru)

### Изготовитель:

Д-Линк Корпорейшн, 114, Тайвань, Тайпей, Нэйху Дистрикт, Шинху 3-Роуд, № 289

### Уполномоченный представитель, импортер:

ООО "Д-Линк Трейд"

390043, г. Рязань, пр. Шабулина, д.16

Тел.: +7 (4912) 503-505

## ОФИСЫ

Россия  
Москва, Графский переулок, 14  
Тел.: +7 (495) 744-00-99  
E-mail: [mail@dlink.ru](mailto:mail@dlink.ru)

Україна  
Київ, вул. Межигірська, 87-А  
Тел.: +38 (044) 545-64-40  
E-mail: [ua@dlink.ua](mailto:ua@dlink.ua)

Moldova  
Chisinau; str.C.Negruzzi-8  
Tel: +373 (22) 80-81-07  
E-mail: [info@dlink.md](mailto:info@dlink.md)

Беларусь  
Мінск, пр-т Незалежнасці, 169  
Тэл.: +375 (17) 218-13-65  
E-mail: [support@dlink.by](mailto:support@dlink.by)

Қазақстан  
Алматы, Құрманғазы к-сі, 143 үй  
Тел.: +7 (727) 378-55-90  
E-mail: [almaty@dlink.ru](mailto:almaty@dlink.ru)

Հայաստան  
Երևան, Դավթթաշեն 3-րդ  
թաղամաս, 23/5  
Հեռ. +374 (10) 39-86-67  
Էլ. փոստ՝ [info@dlink.am](mailto:info@dlink.am)

Latvija  
Rīga, Lielirbes iela 27  
Tel.: +371 (6) 761-87-03  
E-mail: [info@dlink.lv](mailto:info@dlink.lv)

Lietuva  
Vilnius, Žirmūnų 139-303  
Tel.: +370 (5) 236-36-29  
E-mail: [info@dlink.lt](mailto:info@dlink.lt)

Eesti  
E-mail: [info@dlink.ee](mailto:info@dlink.ee)

Türkiye  
Uphill Towers Residence A/99  
Ataşehir /ISTANBUL  
Tel: +90 (216) 492-99-99  
Email: [info.tr@dlink.com.tr](mailto:info.tr@dlink.com.tr)

ישראל  
רח' המגשימים 20  
קרית מטלון  
פתח תקווה  
972 (3) 921-28-86  
[support@dlink.co.il](mailto:support@dlink.co.il)

РУССКИЙ



## Правила и условия безопасной эксплуатации

Перед установкой и подключением устройства ознакомьтесь с кратким руководством по установке. Убедитесь, что устройство, адаптер питания\* и кабели не имеют механических повреждений. Устройство должно быть использовано только по

назначению, в соответствии с кратким руководством по установке.

Не устанавливайте устройство в зонах с влажностью и уровнем загрязнения воздуха свыше 80%; а также в области повышенного испарения и парообразования или усиленной вибрации.

Не используйте устройство с поврежденным корпусом. Температура окружающей среды в непосредственной близости от устройства и внутри его корпуса должна соответствовать указанной в технических характеристиках устройства.

Во избежание повреждения матрицы не направляйте объектив видеокamеры на очень яркие объекты и солнце.

Не включайте адаптер питания\*, если его корпус или кабель повреждены.

Подключайте адаптер питания\* только к исправным розеткам с параметрами, указанными на адаптере питания\*.

Не вскрывайте корпус устройства! Перед очисткой камеры от загрязнений и пыли отключите питание устройства. Удаляйте пыль с помощью влажной салфетки. Не используйте жидкие/аэрозольные очистители или магнитные/статические устройства для очистки. Избегайте попадания влаги в устройство и адаптер питания\*.

Срок службы устройства – 2 года.

Гарантийный период исчисляется с момента приобретения устройства у официального дилера на территории России и стран СНГ и составляет один год.

Вне зависимости от даты продажи гарантийный срок не может превышать 2 года с даты производства изделия, которая определяется по 6 (год) и 7 (месяц) цифрам серийного номера, указанного на наклейке с техническими данными.

Год: 9 - 2009, А - 2010, В - 2011, С - 2012, D - 2013, E - 2014, F - 2015, G - 2016, H - 2017.

Месяц: 1 - январь, 2 - февраль, ..., 9 - сентябрь, А - октябрь, В - ноябрь, С - декабрь.

\* Комплект поставки может отличаться в зависимости от региона.

---

# Guia de Instalação Rápida

Este guia de instalação irá fornecer instruções básicas para instalar o DCS-7517. Para informações adicionais sobre como utilizar a câmera, por favor, verifique o Manual de Usuário que está disponível no CD incluído com o pacote ou no site de suporte D-Link.

## Conteúdo do Pacote

- DCS-7517 Câmera de Segurança IP 5 Megapixel H.265 Externa
- Cabo Ethernet
- Adaptador de Extensão
- Suporte de Montagem e Parafusos
- Manual e CD-ROM com o Software
- Guia de Instalação Rápida

Se algum destes itens estiver faltando, por favor, contate o seu revendedor.

### **Aviso de Segurança:**

Instalação e serviços devem ser feitos por técnicos específicos de modo a estar em conformidade com todas as normas locais e evitar anulação da sua garantia.

## Visão do Hardware

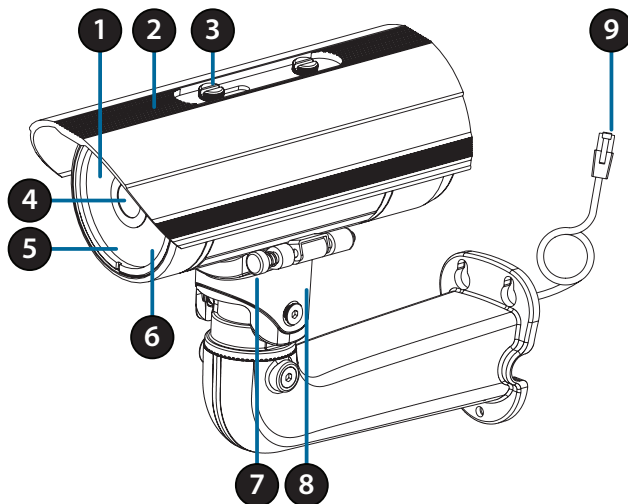

1	<b>IR LEDs</b>	Fornece iluminação para locais com baixa iluminação.
2	<b>Escudo Ajustável</b>	Protege a lente da câmera a exposição direta a raios solares.
3	<b>Parafuso de Ajuste</b>	Permite o posicionamento do escudo ajustável.
4	<b>Lentes da Câmera</b>	Lente Varifocal para gravar vídeos da área ao redor.
5	<b>Power/Status LED</b>	Indica o status atual da câmera.
6	<b>Sensor de Luz</b>	Mede as condições de luz e muda entre modo diurno e noturno.
7	<b>Pino de Retirada Rápida</b>	Permite que a câmera seja desacoplada facilmente em posição para fácil manutenção.
8	<b>Suporte da Câmera</b>	Suporte ajustável para a câmera.
9	<b>Porta Ethernet</b>	Conecte a uma porta Ethernet RJ45. Pode ser utilizada com PoE para fornecer energia à câmera.

## Cabos Opcionais (não inclusos)

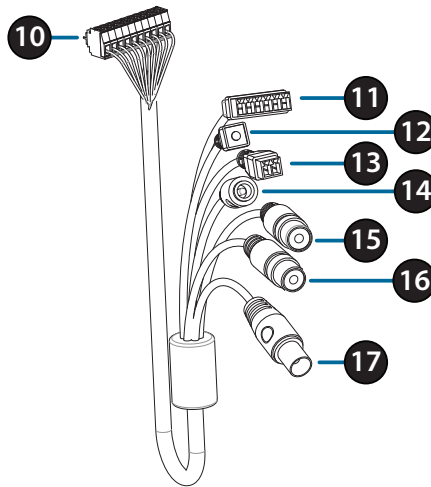

10	<b>Conector da Câmera</b>	Conecta o DCS—7517. Para mais detalhes para conectar o cabo AVV, verifique o Manual de Usuário.
11	<b>Conector DI/DO</b>	Conector I/O para dispositivos externos.
12	<b>Botão de Reset</b>	Pressione e segure o botão por 10 segundos para apagar a câmera e voltar às configurações de fábrica.
13	<b>Conector de Energia 24 V</b>	Não suportado pelo DCS-7517.
14	<b>Conector de Energia</b>	Conector de energia para adaptador de 12 V DC (não incluso).
15	<b>Audio Out (Verde)</b>	Conecta a um alto falante.
16	<b>Audio In (Vermelho)</b>	Conecta a um microfone.
17	<b>Conector BNC</b>	Não suportada pelo DCS-7517.

## Parte interna

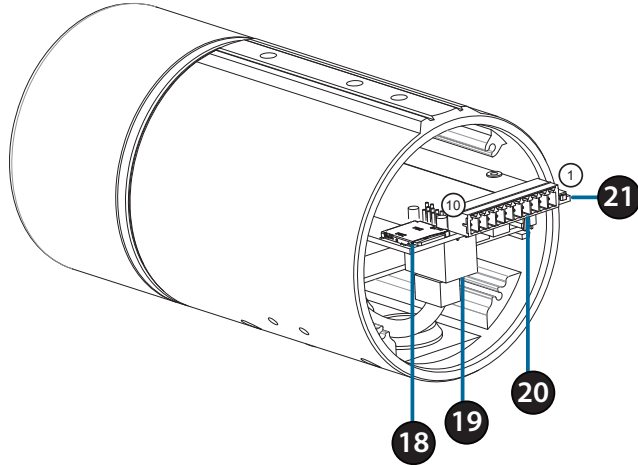

18	<b>Slot para cartão SD</b>	Insira um cartão microSD para armazenamento local para guardar imagens e vídeos gravados	
19	<b>Porta Ethernet</b>	Conecta a um cabo de rede Ethernet	
20	<b>Conector do chicote</b>	Conecta em um conector do chicote opcional (não incluído)	
		1. 12V IN 2. GND 3. AUD IN 4. AUD GND 5. AUD OUT	6. 12V OUT 7. GND 8. RESET 9. DI 10. DO
21	<b>Botão Reset</b>	Pressione e segure o botão por 10 segundos para redefinir a câmera de volta às configurações do padrão de fábrica	



## Conectando um Cabo Opcional

Remova a cobertura de trás da câmera girando-a em sentido anti-horário.

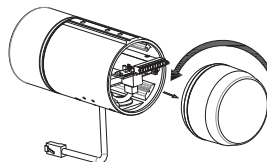

Remova a parte de trás a prova d'água da câmera.

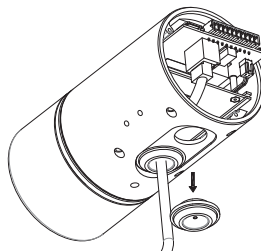

Empurre o conector da câmera e o cabo através do buraco e insira o plugue do cabo a prova d'água.

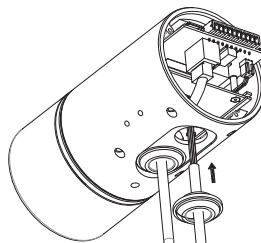

Verifique se o plugue foi inserido corretamente para garantir um bom lacre.

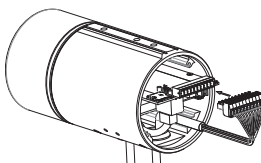

Conecte o conector da câmera com a câmera.

Coloque novamente a proteção de trás da câmera e gire no sentido horário.

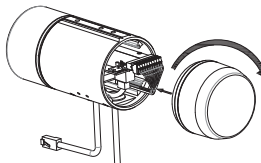

## Instalação do Cartão SD

Remova a parte de trás da câmera girando no sentido anti-horário.

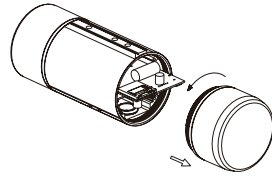

Insira o cartão microSD com a parte de contato virada para baixo e então coloque novamente a parte de trás da câmera. Verifique se as vedações impermeáveis estão seguras e no lugar certo.

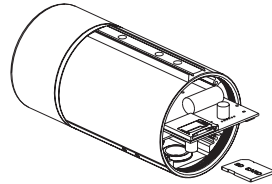

## Instruções de Montagem

Por favor, verifique o Manual de Usuário para instruções detalhadas em como instalar e montar a câmera.

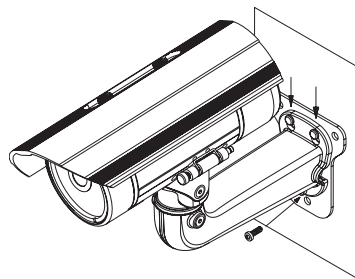
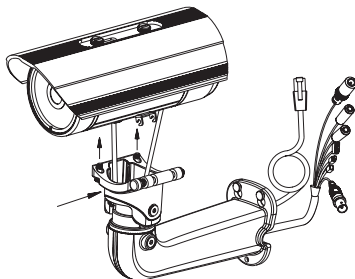
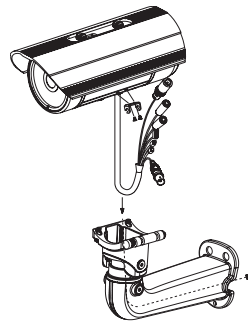
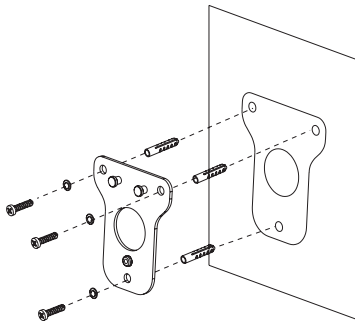

---

## Conectando a Câmera

### Conexão com um Switch PoE

- Conecte o cabo Ethernet no seu Switch PoE ou injetor. O cabo Ethernet irá fornecer à câmera com conexão à internet assim como energia.

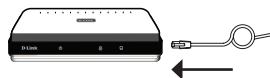

**Se você possui o suporte para cabo adicional,** você também poderá usar os seguintes métodos de conexão:

### Conexão Geral utilizando um Adaptador de Energia 12 V DC (não incluso)

- Conecte o cabo Ethernet a sua conexão
- Conecte o seu adaptador de energia ao conector de energia na câmera e então plugue no adaptador de energia.

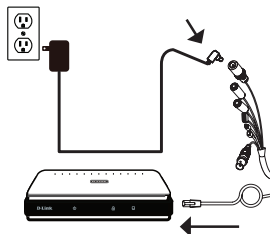

## Configurando a Câmera

Insira o CD do DCS-7517 na porta de CD-ROM no seu computador e comece com a instalação. Se o Autorun está desligado ou o Launcher da D-Link falhar para começar automaticamente, clique no botão de Start e escreva **D:\autorun.exe** (onde D: representa a letra do seu drive de CD-ROM) e pressione Enter.

Clique em **Assistente de Configuração** e siga as instruções para instalar o Assistente de Configuração.



Clique no ícone **D-Link Assistente de Configuração SE** que foi criado no menu de início no seu Windows (**Start > D-Link > Assistente de Configuração SE**).

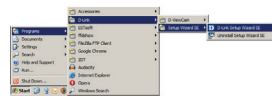

Este Assistente de Configuração irá aparecer e mostrar o endereço MAC e endereço IP da sua câmera(s). Se você possuir um servidor DHCP na sua conexão, um IP válido irá aparecer. Caso o contrário, irá aparecer o endereço IP **192.168.0.20**, padrão da câmera. Selecione a sua câmera e então clique no botão **Assistente** para continuar.

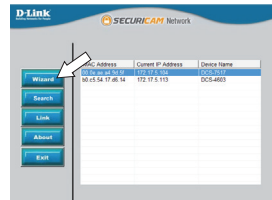

Entre com o ID e senha do Admin. Quando entrar pela primeira vez, o ID Admin padrão é **admin** e a caixa da senha será deixada em branco.



Clique na caixa se você deseja alterar o ID admin e senha para a câmera e entre o novo ID e senha que você deseja utilizar.

Clique em **Próximo** para continuar.

Selecione **DHCP** se a sua câmera obtiver um endereço IP automaticamente do servidor DHCP tal como um roteador.

Selecione **Static IP** se você deseja inserir manualmente as configurações do IP para a câmera.



Clique em **Próximo** para continuar.

Tome um momento para confirmar as configurações e clique em **Reiniciar**.

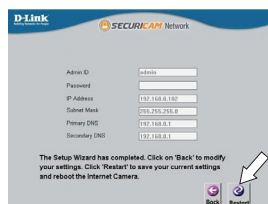

## Visualizando a Sua Câmera via Navegador Web

Clique no ícone **Assistente de Configuração SE** que foi criado no menu de início do Windows (**Start > D-Link > Assistente de Configuração SE**).

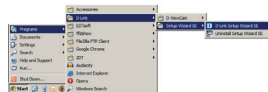

Selecione a câmera e clique em **Link** para acessar as configurações web.

O Assistente de Configuração irá automaticamente abrir o seu navegador web com o endereço IP da câmera.



A primeira vez que você conectar a câmera, você será perguntado para configurar uma nova senha para a conta de administrador. Depois que configurar a senha, clique em **Salvar**.

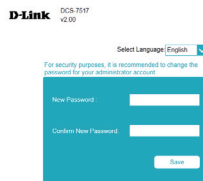

A página ao vivo da câmera irá abrir e você poderá controlar e configurar a sua câmera. Para informações adicionais sobre a configuração web, por favor, verifique o manual de usuário que está disponível no website da D-Link.



PORTUGUÊS

## Informações Adicionais

Informações adicionais sobre o produto e ajuda estão disponíveis em <http://www.dlink.com>.

## Informações de Garantia

Por favor, visite <http://warranty.dlink.com/> para informações de garantia na sua região.

---

# 快速安裝手冊

此安裝指南提供安裝DCS-7517網路攝影機的基本操作。若要取得更多關於使用此攝影機的方式，請參考光碟內附的使用手冊，或至D-Link技術支援網站下載產品使用手冊。

## 包裝內容

- DCS-7517 5百萬H.265 戶外型網路攝影機
- 乙太網路線
- 延伸器
- 安裝支架及螺絲
- 光碟(內涵使用手冊及安裝程式)
- 快速安裝手冊

若包裝內缺少以上任何項目，請聯絡您的經銷商。

安全須知：

此產品應該由具備相關證照的技術人員安裝，以符合當地的法規及避免產品保固失效。

## 硬體概觀

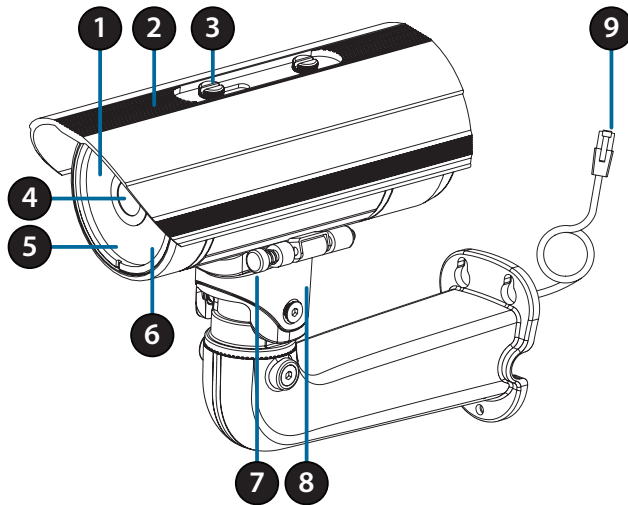

1	紅外線LED燈	在低光源的環境下提供照明。
2	可調式上罩	避免鏡頭直接照射陽光。
3	調整螺絲	旋轉鬆緊以調整上罩位置。
4	攝影機鏡頭	可變焦鏡頭。
5	電源/狀態指示燈	指示攝影機當前狀態。
6	感光元件	依據環境光源自動切換日夜模式。
7	快速拆卸鈕	可快速將攝影機從支架上拆下以方便維修。
8	調整螺絲	旋轉鬆緊以調整攝影機底座角度。
9	乙太網路線接頭	可連接RJ-45乙太網路線提供攝影機網路，或是透過PoE方式供電至攝影機。

## 配線組(請另購)

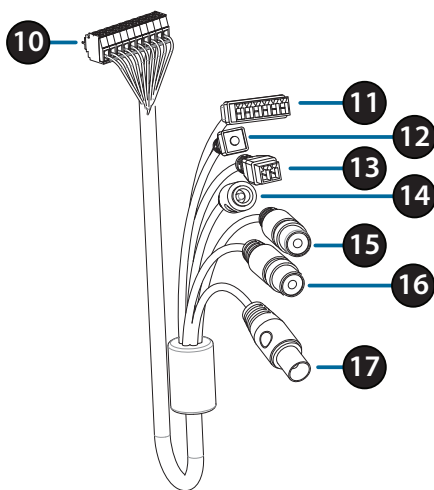

10	攝影機接頭	連接至DCS-7517，請參考使用手冊以取得更多關於連接A/V 纜線的詳細。
11	DI/DO 接頭	I/O 接點，連接至裝置。
12	重置按鈕	按壓約10秒不放，將攝影機回復至出廠預設值。
13	24 V 電源接頭	不支援提供攝影機電源 DCS-7517。
14	電源接頭	連接12V DC 電源變壓器。(請另購)
15	聲音輸出 (綠)	連接喇叭。
16	聲音輸入 (紅)	連接麥克風。
17	BNC 接頭	DCS-7517並不支援。



## Internal

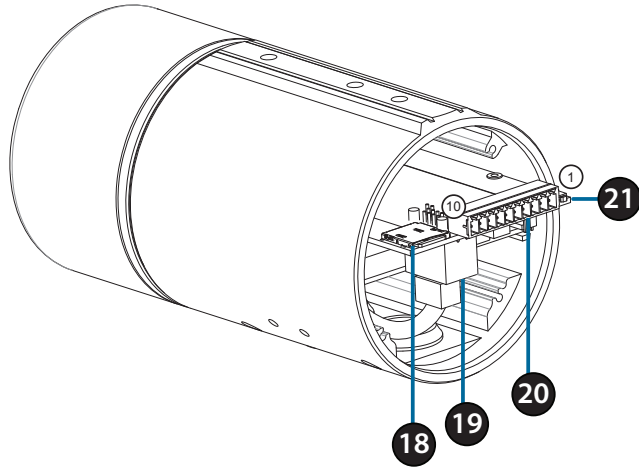

18	<b>SD卡插槽</b>	插入microSD記憶卡用於儲存螢幕快照或是紀錄影像。	
19	<b>乙太網路埠</b>	連接至乙太網路線。	
20	<b>配線連接埠</b>	連接至額外配線(標準包裝內不包含)。	
		1. 12V IN 2. GND 3. AUD IN 4. AUD GND 5. AUD OUT	6. 12V OUT 7. GND 8. RESET 9. DI 10. DO
21	<b>Reset按鈕</b>	按壓約10秒不放，將攝影機回復至出廠預設值。	

## 連接配線組

逆時針方向旋轉取下攝影機後方外殼。

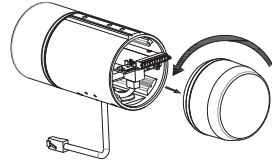

取下攝影機下方防水栓。

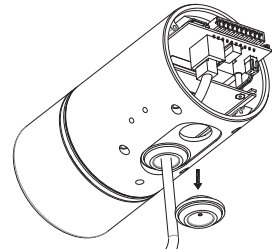

將攝影機接頭及配線穿過孔洞，接著固定防水栓。

請務必確保防水栓有正確安裝，以確保攝影機的防水功能正常運作。

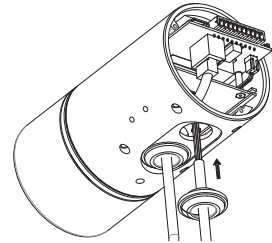

將攝影機接頭連接至攝影機。

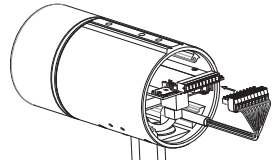

順時針方向旋轉鎖回攝影機後方外殼。

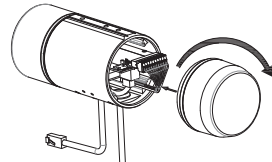

## SD卡安裝

逆時針方向旋轉取下攝影機外殼。

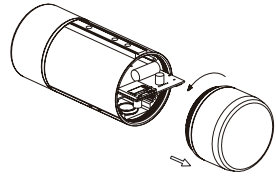

插入microSD記憶卡，將攝影機外殼鎖回。請務必確保防水密封零件有固定在正確位置。

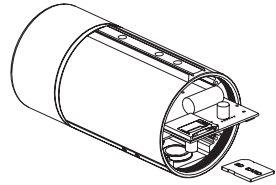

## 壁掛安裝

壁掛安裝設定，請參考包裝內附的光碟或D-Link網站上的使用手冊。

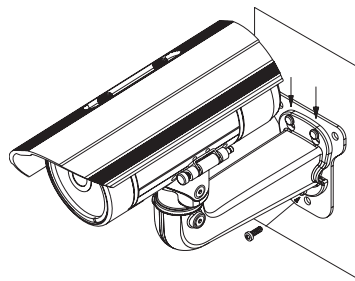
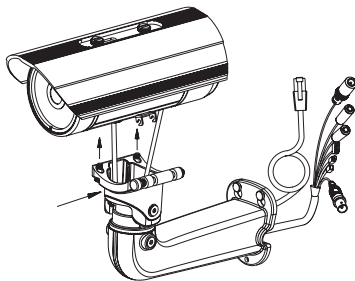
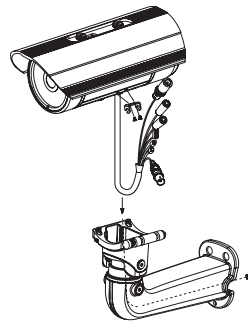
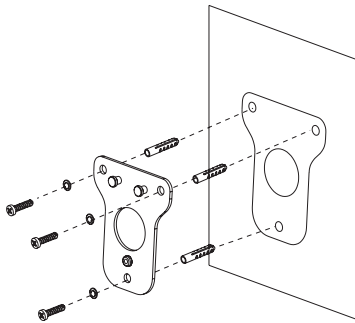

---

## 連接攝影機

### 連接至PoE交換器

- 將乙太網路線連接至PoE交換器或電源供應器。此時乙太網路線可以同時提供電源及網路連線。



若您有「連接配線組」，請依下方引導完成連線。

### 連接12V DC 電源變壓器(請另購)

- 將乙太網路線連接至您的網路。
- 將電源變壓器連接至攝影機電源接頭，接著將電源變壓器接上電源。

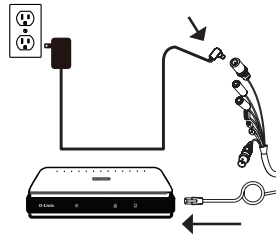

## 攝影機設定

請將包裝內附的光碟放入您電腦的光碟機並開始執行安裝。若您電腦的自動執行功能已被停用，或D-Link Launcher無法自動執行時，請點選開始>執行後輸入「D:\autorun.exe」(D代表您光碟機的代號)。

請點選Setup Wizard開始安裝。



請點選Windows開始選單中的D-Link Setup Wizard SE圖示(開始> D-Link > Setup Wizard SE)。

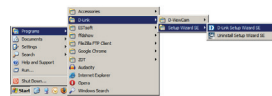

設定精靈中將會顯示您攝影機的MAC位址及IP位址。若您的網路中有DHCP伺服器時，將會顯示由DHCP派發的有效IP位址。若您的網路中沒有DHCP伺服器，則將會顯示攝影機的預設IP位址192.168.0.20。請選擇您的攝影機，再點選「Wizard」的按鈕來繼續。

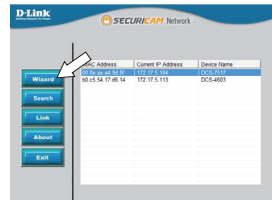

請輸入管理者(Admin)的名稱和密碼。在首次登入時，預設的管理者名稱為「admin」無密碼。



若您要更改攝影機的管理者(admin)名稱和密碼時請勾選核取方塊，並輸入您要設定的新名稱及密碼。

請點選「Next」來繼續。

若您要讓攝影機在開機後自動由DHCP伺服器(例如路由器)取得IP位址時請選擇「DHCP」。若您要讓攝影機每次皆使用相同的IP時請選擇「Static IP」並輸入您要使用的IP位址。



請點選「Next」來繼續。

請確認您的設定是否正確並點選「Restart」來重新啟動攝影機。



## 透過網頁瀏覽器檢視您的攝影機

點擊開始選單中的「D-Link Setup Wizard SE」圖示。(開始 > D-Link > Setup Wizard SE)。

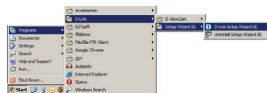

請選擇攝影機並點選「Link」的按鈕來連結網頁設定介面。

設定精靈將會自動以攝影機的IP位址來開啟設定網頁。



當您第一次連接至攝影機時，系統將會要求您設置管理者帳號及密碼。輸入帳號及密碼後請點選「Save」。

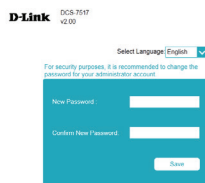

畫面中會顯示您攝影機的即時影像，您可以選擇影像設定檔來觀看或調整設定。若要取得更多關於設定網頁的資訊，請參考包裝內附的光碟或D-Link網站上的使用手冊。



## 其他資訊

請造訪官方網站<http://www.dlink.com>來取得更多產品的相關資訊與協助。

## 保固資訊

請造訪網站<http://warranty.dlink.com/>來查看在您地區的保固資訊。

---

# Panduan Instalasi Cepat

Panduan instalasi ini memberikan petunjuk dasar untuk meng-Install DCS-7517. Untuk informasi tambahan tentang cara menggunakan kamera, silakan lihat Panduan Pengguna yang tersedia di CD yang disertakan dalam paket ini atau dari situs web dukungan D-Link.

## Isi Dalam Kemasan

- DCS-7517 5 megapixel H.265 Outdoor Network Camera
- Kabel ethernet
- Ekstensi Adpater
- Dudukan Kamera dan Skrup
- Buku Manual dan Software di dalam CD.
- Panduan Instalasi Cepat.

Jika salah satu item di atas yang hilang, harap hubungi penjual.

### **Pemberitahuan Keamanan:**

Instalasi dan servis harus dilakukan oleh teknisi bersertifikat untuk mencegah batalnya garansi Anda.

## Tampilan Perangkat

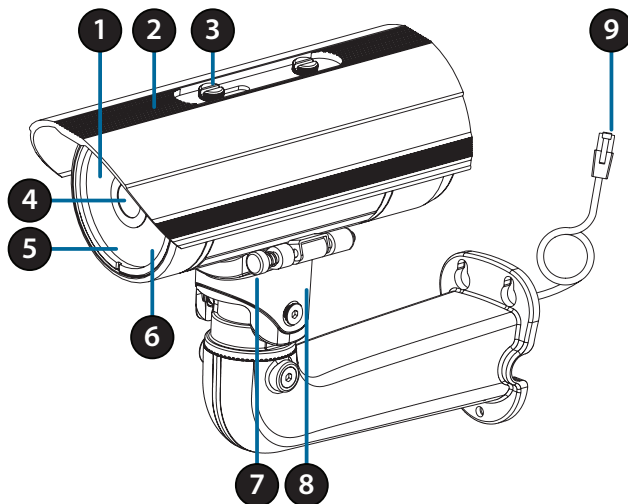

1	<b>IR LEDs</b>	Memberikan pencahayaan di lingkungan cahaya rendah.
2	<b>Pelindung kamera yang dapat disesuaikan</b>	Pelindung lensa kamera dari sinar matahari langsung.
3	<b>Sekrup</b>	Memungkinkan untuk penentuan posisi dari pelindung kamera atas.
4	<b>Lensa Kamera</b>	Lensa varifocal untuk merekam video di daerah sekitarnya.
5	<b>Power/Status LED</b>	Menunjukkan status kamera saat ini.
6	<b>Sensor Cahaya</b>	Mengukur kondisi pencahayaan dan beralih antara modus siang dan malam.
7	<b>Pin Pelepas Cepat</b>	Memungkinkan kamera untuk diputar ke posisi tertentu untuk memudahkan perawatan.
8	<b>Kaki Kamera</b>	Pemasangan kaki kamera yang dapat di sesuaikan
9	<b>Ethernet Jack</b>	Hubungkan dengan port Ethernet RJ45. Dapat digunakan PoE untuk memberikan power pada kamera.



## Opsional Kabel Harness (tidak termasuk)

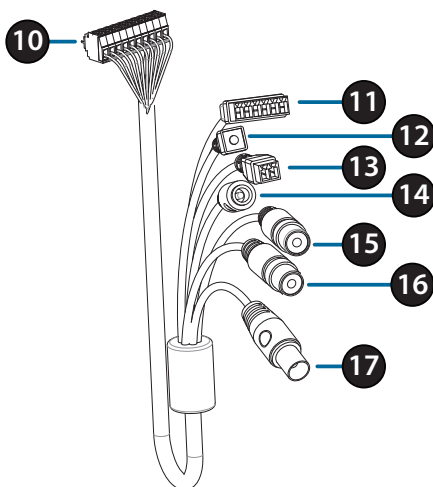

10	<b>Konektor Kamera</b>	Hubungkan ke DCS-7517. Untuk rincian lebih lanjut tentang menghubungkan kabel A / V, silahkan lihat pada User Manual.
11	<b>Konektor DI/DO</b>	Konektor I/O untuk menghubungkan ke perangkat eksternal.
12	<b>Tombol Reset</b>	Tekan dan tahan tombol selama 10 detik untuk me-reset kamera kembali ke pengaturan asal pabrik.
13	<b>Konektor power 24 V</b>	Tidak didukung oleh DCS-7517.
14	<b>Konektor Power</b>	konektor daya untuk adaptor 12V DC (tidak termasuk).
15	<b>Audio Out (Hijau)</b>	Hubungkan ke sebuah speaker
16	<b>Audio In (Merah)</b>	Hubungkan ke sebuah mikrofon.
17	<b>Konektor BNC</b>	Tidak didukung oleh DCS-7517.

## Internal

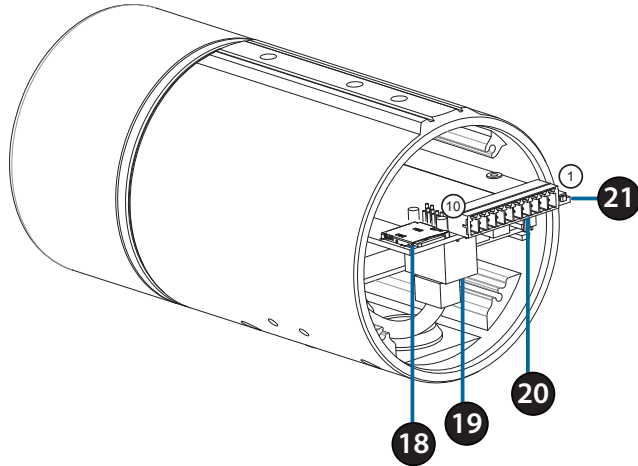

18	<b>Tempat SD Card</b>	Masukan sebuah microSD card untuk penyimpanan lokal perekaman gambar dan video.								
19	<b>Port Ethernet</b>	Koneksi untuk kabel ethernet								
20	<b>Konektor Harness</b>	Penghubung ke kabel harness (tidak termasuk).								
		<table border="1"> <tr> <td>1. 12V IN</td> <td>6. 12V OUT</td> </tr> <tr> <td>2. GND</td> <td>7. GND</td> </tr> <tr> <td>3. AUD IN</td> <td>8. RESET</td> </tr> <tr> <td>4. AUD GND</td> <td>9. DI</td> </tr> <tr> <td>5. AUD OUT</td> <td>10. DO</td> </tr> </table>	1. 12V IN	6. 12V OUT	2. GND	7. GND	3. AUD IN	8. RESET	4. AUD GND	9. DI
1. 12V IN	6. 12V OUT									
2. GND	7. GND									
3. AUD IN	8. RESET									
4. AUD GND	9. DI									
5. AUD OUT	10. DO									
21	<b>Tombol Reset</b>	Tekan dan tahan tombol reset selama 10 detik untuk mengembalikan kamera ke settingan awal/pabrik.								

## Menghubungkan Opsional Kabel Harness

Lepaskan penutup kamera belakang dengan memutarinya berlawanan arah jarum jam.

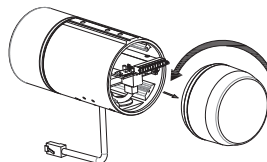

Lepaskan penutup anti air di bagian bawah kamera.

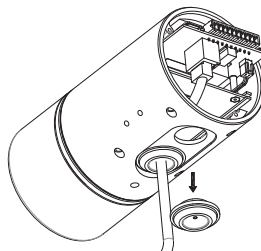

Dorong konektor kamera dan kabel melalui lubang, dan masukkan pembungkus anti air pada kabel..

Pastikan pembungkus kabel anti air dimasukkan dengan benar dan tersegel dengan baik.

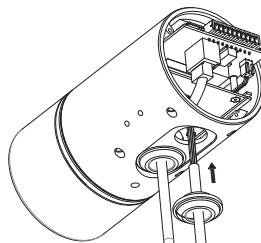

Hubungkan konektor kamera ke kamera.

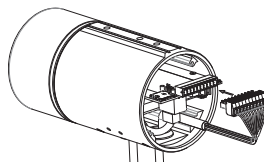

Pasang kembali penutup kamera belakang dengan memutar searah jarum jam.

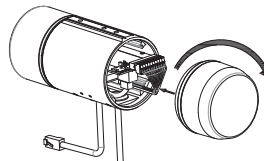

## Instalasi Kartu SD

Lepaskan penutup kamera belakang dengan memutarnya berlawanan arah jarum jam.

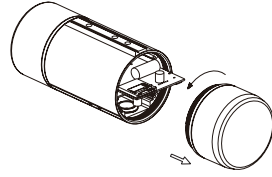

Masukkan kartu microSD dengan kontak menghadap ke bawah, kemudian pasang kembali penutup belakang. Pastikan bahwa segel tahan air terpasang dengan benar ditempatnya.

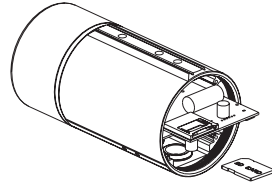

## Petunjuk Pemasangan

Silakan merujuk ke user manual untuk petunjuk rinci tentang cara menginstal dan memasang kamera.

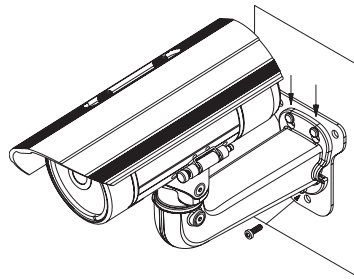
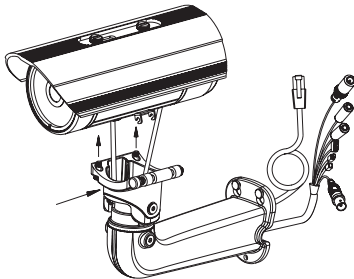
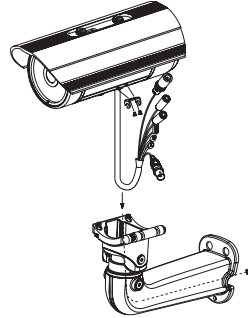
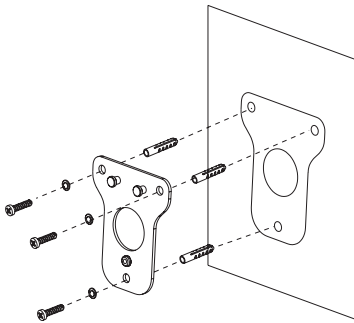

---

## Menghubungkan Kamera

### Koneksi dengan Switch PoE

- Hubungkan kabel Ethernet ke switch PoE atau injector. Kabel Ethernet akan memberikan daya pada kamera dan konektifitas jaringan.

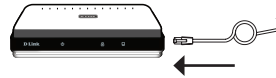

**Jika Anda memiliki opsional kabel harness,** Anda juga dapat menggunakan metode koneksi berikut:

### Koneksi dengan Menggunakan Power Adapter 12V DC (tidak termasuk dalam kemasan)

- Hubungkan kabel Ethernet ke jaringan Anda.
- Hubungkan adaptor daya ke konektor daya pada kamera, kemudian pasang power adapter ke terminal listrik.

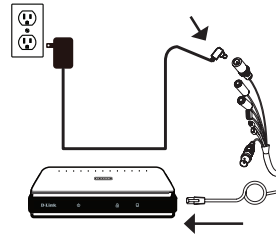

## Konfigurasi pada Kamera

Masukkan CD DCS-7517 ke dalam CD-ROM komputer Anda untuk memulai instalasi. Jika Autorun tidak aktif, atau jika D-Link Launcher gagal untuk memulai secara otomatis, klik tombol Start dan ketik **D: \ autorun.exe** (di mana D: mewakili huruf drive dari CD-ROM drive) dan tekan Enter.

Klik **Setup Wizard** dan ikuti petunjuk untuk menginstal Setup Wizard.



Klik pada ikon **D-Link Setup Wizard SE** yang ada pada menu Start Windows Anda (**Start > D-Link > Setup Wizard SE**).

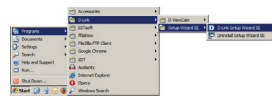

Setup Wizard akan muncul dan menampilkan alamat MAC dan alamat IP dari kamera Anda. Jika Anda memiliki sebuah DHCP server pada jaringan Anda, sebuah IP Address yang valid akan ditampilkan. Jika tidak, bawaan statis IP kamera **192.168.0.20** akan ditampilkan. Pilih kamera Anda, kemudian klik tombol **Wizard** untuk melanjutkan.

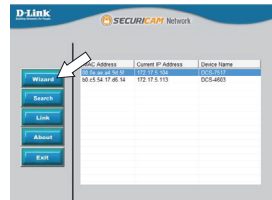

Masukkan ID Admin dan password. Ketika masuk untuk pertama kalinya, ID **Admin** default admin dengan password dibiarkan kosong.



Klik kotak centang jika Anda ingin mengubah ID dan password admin pada kamera, dan masukkan ID dan password baru yang ingin Anda gunakan.

Klik **Next** untuk melanjutkan.

Pilih **DHCP** jika kamera Anda memperoleh alamat IP secara otomatis dari server DHCP seperti router. Pilih **Static IP** jika Anda ingin secara manual memasukkan pengaturan IP untuk kamera.



Klik **Next** untuk melanjutkan.

Luangkan waktu sejenak untuk mengkonfirmasi pengaturan Anda dan klik **Restart**.

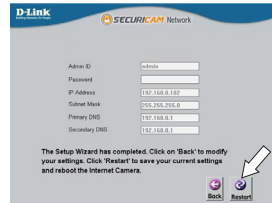

## Melihat Camera Anda melalui Web Browser

Klik pada **D-Link Setup Wizard SE** ikon yang diciptakan pada menu Start Windows Anda (**Start> D-Link> Setup Wizard SE**).

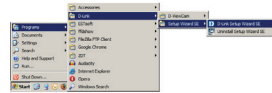

Pilih kamera dan klik **Link** untuk mengakses konfigurasi web.



Setup Wizard secara otomatis akan membuka browser web Anda ke alamat IP kamera.

Pertama kali Anda terhubung ke kamera, Anda akan diminta untuk menetapkan password untuk account administrator. Setelah memasukkan password, klik **Save**.

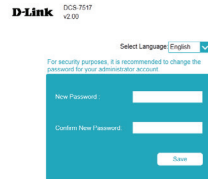

Halaman video kamera akan terbuka, dan Anda sekarang dapat mengontrol dan mengkonfigurasi kamera Anda. Untuk informasi tambahan tentang konfigurasi web, silakan lihat user manual, yang tersedia di situs D-Link.



## Informasi tambahan

bantuan tambahan dan informasi produk tersedia secara online di <http://www.dlink.com>.

## Informasi garansi

Silahkan kunjungi <http://warranty.dlink.com/> untuk informasi garansi untuk wilayah Anda.

---

## Regulatory Statements (Only for Class A product)

### Federal Communication Commission Interference Statement

This equipment has been tested and found to comply with the limits for a Class A digital device, pursuant to part 15 of the FCC Rules. These limits are designed to provide reasonable protection against harmful interference when the equipment is operated in a commercial environment. This equipment generates, uses, and can radiate radio frequency energy and, if not installed and used in accordance with the instruction manual, may cause harmful interference to radio communications. Operation of this equipment in a residential area is likely to cause harmful interference in which case the user will be required to correct the interference at his own expense.

### Non-modification Statement

Any changes or modifications not expressly approved by the party responsible for compliance could void the user's authority to operate the equipment.

### Caution

This device complies with Part 15 of the FCC Rules. Operation is subject to the following two conditions:

(1) This device may not cause harmful interference, and (2) this device must accept any interference received, including interference that may cause undesired operation.

### Innovation, Science and Economic Development Canada (ISED) Statement:

This Class A digital apparatus complies with Canadian ICES-003.

Cet appareil numérique de la classe A est conforme à la norme NMB-003 du Canada.

### 警告使用者:

此為甲類的資訊技術設備，在居住環境中使用時，可能會造成射頻擾動，在這種情況下，使用者會被要求採取某些適當的對策。

### CE EMI Class A Warning

This equipment is compliant with Class A of CISPR 32. In a residential environment this equipment may cause radio interference.



---

## Regulatory Statements (Only for Class B product)

### **Federal Communication Commission Interference Statement**

This equipment has been tested and found to comply with the limits for a Class B digital device, pursuant to Part 15 of the FCC Rules. These limits are designed to provide reasonable protection against harmful interference in a residential installation. This equipment generates, uses and can radiate radio frequency energy and, if not installed and used in accordance with the instructions, may cause harmful interference to radio communications. However, there is no guarantee that interference will not occur in a particular installation. If this equipment does cause harmful interference to radio or television reception, which can be determined by turning the equipment off and on, the user is encouraged to try to correct the interference by one of the following measures:

- Reorient or relocate the receiving antenna.
- Increase the separation between the equipment and receiver.
- Connect the equipment into an outlet on a circuit different from that to which the receiver is connected.
- Consult the dealer or an experienced radio/TV technician for help.

### **Non-modification Statement**

Any changes or modifications not expressly approved by the party responsible for compliance could void the user's authority to operate the equipment.

### **Caution**

This device complies with Part 15 of the FCC Rules. Operation is subject to the following two conditions: (1) This device may not cause harmful interference, and (2) this device must accept any interference received, including interference that may cause undesired operation.

### **Innovation, Science and Economic Development Canada (ISED) Statement:**

This Class B digital apparatus complies with Canadian ICES-003.

Cet appareil numérique de la classe B est conforme à la norme NMB-003 du Canada.

---

# SAFETY INSTRUCTIONS

The following general safety guidelines are provided to help ensure your own personal safety and protect your product from potential damage. Remember to consult the product user instructions for more details.

- Static electricity can be harmful to electronic components. Discharge static electricity from your body (i.e. touching grounded bare metal) before touching the product.
- Do not attempt to service the product and never disassemble the product. For some products with a user replaceable battery, please read and follow the instructions in the user manual.
- Do not spill food or liquid on your product and never push any objects into the openings of your product.
- Do not use this product near water, areas with high humidity, or condensation unless the product is specifically rated for outdoor application.
- Keep the product away from radiators and other heat sources.
- Always unplug the product from mains power before cleaning and use a dry lint free cloth only.

# SICHERHEITSINSTRUKTION

Die folgenden allgemeinen Sicherheitsinstruktionen dienen als Hilfe zur Gewährleistung Ihrer eigenen Sicherheit und zum Schutz Ihres Produkts. Weitere Details finden Sie in den Benutzeranleitungen zum Produkt.

- Statische Elektrizität kann elektronischen Komponenten schaden. Um Schäden durch statische Aufladung zu vermeiden, leiten Sie elektrostatische Ladungen von Ihrem Körper ab, (z. B. durch Berühren eines geerdeten blanken Metallteils), bevor Sie das Produkt berühren.
- Unterlassen Sie jeden Versuch, das Produkt zu warten, und versuchen Sie nicht, es in seine Bestandteile zu zerlegen. Für einige Produkte mit austauschbaren Akkus lesen Sie bitte das Benutzerhandbuch und befolgen Sie die dort beschriebenen Anleitungen.
- Vermeiden Sie, dass Speisen oder Flüssigkeiten auf Ihr Produkt gelangen, und stecken Sie keine Gegenstände in die Gehäuseschlitze oder -öffnungen Ihres Produkts.
- Verwenden Sie dieses Produkt nicht in unmittelbarer Nähe von Wasser und nicht in Bereichen mit hoher Luftfeuchtigkeit oder Kondensation, es sei denn, es ist speziell zur Nutzung in Außenbereichen vorgesehen und eingestuft.
- Halten Sie das Produkt von Wärmequellen entfernt wie z.B. Heizkörper.
- Trennen Sie das Produkt immer von der Stromzufuhr, bevor Sie es reinigen und verwenden Sie dazu ausschließlich ein trockenes fusselfreies Tuch.

# CONSIGNES DE SÉCURITÉ

Les consignes générales de sécurité ci-après sont fournies afin d'assurer votre sécurité personnelle et de protéger le produit d'éventuels dommages. Veuillez consulter les consignes d'utilisation du produit pour plus de détails.

- L'électricité statique peut endommager les composants électroniques. Déchargez l'électricité statique de votre corps (en touchant un objet en métal relié à la terre par exemple) avant de toucher le produit.
- N'essayez pas d'intervenir sur le produit et ne le démontez jamais. Pour certains produits contenant une batterie remplaçable par l'utilisateur, veuillez lire et suivre les consignes contenues dans le manuel d'utilisation.
- Ne renversez pas d'aliments ou de liquide sur le produit et n'insérez jamais d'objets dans les orifices.
- N'utilisez pas ce produit à proximité d'un point d'eau, de zones très humides ou de condensation sauf si le produit a été spécifiquement conçu pour une application extérieure.
- Éloignez le produit des radiateurs et autres sources de chaleur.
- Débranchez toujours le produit de l'alimentation avant de le nettoyer et utilisez uniquement un chiffon sec non pelucheux.

---

# INSTRUCCIONES DE SEGURIDAD

Las siguientes directrices de seguridad general se facilitan para ayudarle a garantizar su propia seguridad personal y para proteger el producto frente a posibles daños. No olvide consultar las instrucciones del usuario del producto para obtener más información.

- La electricidad estática puede resultar nociva para los componentes electrónicos. Descargue la electricidad estática de su cuerpo (p. ej., tocando algún metal sin revestimiento conectado a tierra) antes de tocar el producto.
- No intente realizar el mantenimiento del producto ni lo desmonte nunca. Para algunos productos con batería reemplazable por el usuario, lea y siga las instrucciones del manual de usuario.
- No derrame comida o líquidos sobre el producto y nunca deje que caigan objetos en las aberturas del mismo.
- No utilice este producto cerca del agua, en zonas con humedad o condensación elevadas a menos que el producto esté clasificado específicamente para aplicación en exteriores.
- Mantenga el producto alejado de los radiadores y de otras fuentes de calor.
- Desenchufe siempre el producto de la alimentación de red antes de limpiarlo y utilice solo un paño seco sin pelusa

# ISTRUZIONI PER LA SICUREZZA

Le seguenti linee guida sulla sicurezza sono fornite per contribuire a garantire la sicurezza personale degli utenti e a proteggere il prodotto da potenziali danni. Per maggiori dettagli, consultare le istruzioni per l'utente del prodotto.

- L'elettricità statica può essere pericolosa per i componenti elettronici. Scaricare l'elettricità statica dal corpo (ad esempio toccando una parte metallica collegata a terra) prima di toccare il prodotto.
- Non cercare di riparare il prodotto e non smontarlo mai. Per alcuni prodotti dotati di batteria sostituibile dall'utente, leggere e seguire le istruzioni riportate nel manuale dell'utente.
- Non versare cibi o liquidi sul prodotto e non spingere mai alcun oggetto nelle aperture del prodotto.
- Non usare questo prodotto vicino all'acqua, in aree con elevato grado di umidità o soggette a condensa a meno che il prodotto non sia specificatamente approvato per uso in ambienti esterni.
- Tenere il prodotto lontano da caloriferi e altre fonti di calore.
- Scollegare sempre il prodotto dalla presa elettrica prima di pulirlo e usare solo un panno asciutto che non lasci filacce.

# VEILIGHEIDSINFORMATIE

De volgende algemene veiligheidsinformatie werd verstrekt om uw eigen persoonlijke veiligheid te waarborgen en uw product te beschermen tegen mogelijke schade. Denk eraan om de gebruikersinstructies van het product te raadplegen voor meer informatie.

- Statische elektriciteit kan schadelijk zijn voor elektronische componenten. Ontlaad de statische elektriciteit van uw lichaam (d.w.z. het aanraken van geaard bloot metaal) voordat u het product aanraakt.
- U mag nooit proberen het product te onderhouden en u mag het product nooit demonteren. Voor sommige producten met door de gebruiker te vervangen batterij, dient u de instructies in de gebruikershandleiding te lezen en te volgen.
- Mors geen voedsel of vloeistof op uw product en u mag nooit voorwerpen in de openingen van uw product duwen.
- Gebruik dit product niet in de buurt van water, gebieden met hoge vochtigheid of condensatie, tenzij het product specifiek geclassificeerd is voor gebruik buitenshuis.
- Houd het product uit de buurt van radiators en andere warmtebronnen.
- U dient het product steeds los te koppelen van de stroom voordat u het reinigt en gebruik uitsluitend een droge pluisvrije doek

# DISPOSING AND RECYCLING YOUR PRODUCT



ENGLISH

EN



This symbol on the product or packaging means that according to local laws and regulations this product should be not be disposed of in the household waste but sent for recycling. Please take it to a collection point designated by your local authorities once it has reached the end of its life, some will accept products for free. By recycling the product and its packaging in this manner you help to conserve the environment and protect human health.

## D-Link and the environment

At D-Link, we understand and are committed to reducing any impact our operations and products may have on the environment. To minimise this impact D-Link designs and builds its products to be as environmentally friendly as possible, by using recyclable, low toxic materials in both products and packaging.

D-Link recommends that you always switch off or unplug your D-Link products when they are not in use. By doing so you will help to save energy and reduce CO2 emissions.

To learn more about our environmentally responsible products and packaging please visit [www.dlinkgreen.com](http://www.dlinkgreen.com)

DEUTSCH

DE



Dieses Symbol auf dem Produkt oder der Verpackung weist darauf hin, dass dieses Produkt gemäß bestehender örtlicher Gesetze und Vorschriften nicht über den normalen Hausmüll entsorgt werden sollte, sondern einer Wiederverwertung zuzuführen ist. Bringen Sie es bitte zu einer von Ihrer Kommunalbehörde entsprechend amtlich ausgewiesenen Sammelstelle, sobald das Produkt das Ende seiner Nutzungsdauer erreicht hat. Für die Annahme solcher Produkte erheben einige dieser Stellen keine Gebühren. Durch ein auf diese Weise durchgeführtes Recycling des Produkts und seiner Verpackung helfen Sie, die Umwelt zu schonen und die menschliche Gesundheit zu schützen.

## D-Link und die Umwelt

D-Link ist sich den möglichen Auswirkungen seiner Geschäftstätigkeiten und seiner Produkte auf die Umwelt bewusst und fühlt sich verpflichtet, diese entsprechend zu mindern. Zu diesem Zweck entwickelt und stellt D-Link seine Produkte mit dem Ziel größtmöglicher Umweltfreundlichkeit her und verwendet wiederverwertbare, schadstoffarme Materialien bei Produktherstellung und Verpackung.

D-Link empfiehlt, Ihre Produkte von D-Link, wenn nicht in Gebrauch, immer auszuschalten oder vom Netz zu nehmen. Auf diese Weise helfen Sie, Energie zu sparen und CO2-Emissionen zu reduzieren. Wenn Sie mehr über unsere umweltgerechten Produkte und Verpackungen wissen möchten, finden Sie entsprechende Informationen im Internet unter [www.dlinkgreen.com](http://www.dlinkgreen.com).

FRANÇAIS

FR



Ce symbole apposé sur le produit ou son emballage signifie que, conformément aux lois et réglementations locales, ce produit ne doit pas être éliminé avec les déchets domestiques mais recyclé. Veuillez le rapporter à un point de collecte prévu à cet effet par les autorités locales; certains accepteront vos produits gratuitement. En recyclant le produit et son emballage de cette manière, vous aidez à préserver l'environnement et à protéger la santé de l'homme.

## D-Link et l'environnement

Chez D-Link, nous sommes conscients de l'impact de nos opérations et produits sur l'environnement et nous engageons à le réduire. Pour limiter cet impact, D-Link conçoit et fabrique ses produits de manière aussi écologique que possible, en utilisant des matériaux recyclables et faiblement toxiques, tant dans ses produits que ses emballages.

D-Link recommande de toujours éteindre ou débrancher vos produits D-Link lorsque vous ne les utilisez pas. Vous réaliserez ainsi des économies d'énergie et réduirez vos émissions de CO2.

Pour en savoir plus sur les produits et emballages respectueux de l'environnement, veuillez consulter le [www.dlinkgreen.com](http://www.dlinkgreen.com)

## ESPAÑOL

ES



Este símbolo en el producto o el embalaje significa que, de acuerdo con la legislación y la normativa local, este producto no se debe desechar en la basura doméstica sino que se debe reciclar. Llévelo a un punto de recogida designado por las autoridades locales una vez que ha llegado al fin de su vida útil; algunos de ellos aceptan recogerlos de forma gratuita. Al reciclar el producto y su embalaje de esta forma, contribuye a preservar el medio ambiente y a proteger la salud de los seres humanos.

### D-Link y el medio ambiente

En D-Link, comprendemos y estamos comprometidos con la reducción del impacto que puedan tener nuestras actividades y nuestros productos en el medio ambiente. Para reducir este impacto, D-Link diseña y fabrica sus productos para que sean lo más ecológicos posible, utilizando materiales reciclables y de baja toxicidad tanto en los productos como en el embalaje. D-Link recomienda apagar o desenchufar los productos D-Link cuando no se estén utilizando. Al hacerlo, contribuirá a ahorrar energía y a reducir las emisiones de CO<sub>2</sub>. Para obtener más información acerca de nuestros productos y embalajes ecológicos, visite el sitio [www.dlinkgreen.com](http://www.dlinkgreen.com)

## ITALIANO

IT



La presenza di questo simbolo sul prodotto o sulla confezione del prodotto indica che, in conformità alle leggi e alle normative locali, questo prodotto non deve essere smaltito nei rifiuti domestici, ma avviato al riciclo. Una volta terminato il ciclo di vita utile, portare il prodotto presso un punto di raccolta indicato dalle autorità locali. Alcuni questi punti di raccolta accettano gratuitamente i prodotti da riciclare. Scegliendo di riciclare il prodotto e il relativo imballaggio, si contribuirà a preservare l'ambiente e a salvaguardare la salute umana.

### D-Link e l'ambiente

D-Link cerca da sempre di ridurre l'impatto ambientale dei propri stabilimenti e dei propri prodotti. Allo scopo di ridurre al minimo tale impatto, D-Link progetta e realizza i propri prodotti in modo che rispettino il più possibile l'ambiente, utilizzando materiali riciclabili a basso tasso di tossicità sia per i prodotti che per gli imballaggi. D-Link raccomanda di spegnere sempre i prodotti D-Link o di scollegarne la spina quando non vengono utilizzati. In questo modo si contribuirà a risparmiare energia e a ridurre le emissioni di anidride carbonica. Per ulteriori informazioni sui prodotti e sugli imballaggi D-Link a ridotto impatto ambientale, visitate il sito all'indirizzo [www.dlinkgreen.com](http://www.dlinkgreen.com)

## NEDERLANDS

NL



Dit symbool op het product of de verpakking betekent dat dit product volgens de plaatselijke wetgeving niet mag worden weggegooid met het huishoudelijk afval, maar voor recyclage moeten worden ingeleverd. Zodra het product het einde van de levensduur heeft bereikt, dient u het naar een inzamelpunt te brengen dat hiertoe werd aangeduid door uw plaatselijke autoriteiten, sommige autoriteiten accepteren producten zonder dat u hiervoor dient te betalen. Door het product en de verpakking op deze manier te recyclen helpt u het milieu en de gezondheid van de mens te beschermen.

### D-Link en het milieu

Bij D-Link spannen we ons in om de impact van onze handelingen en producten op het milieu te beperken. Om deze impact te beperken, ontwerpt en bouwt D-Link zijn producten zo milieuvriendelijk mogelijk, door het gebruik van recycleerbare producten met lage toxiciteit in product en verpakking. D-Link raadt aan om steeds uw D-Link producten uit te schakelen of uit de stekker te halen wanneer u ze niet gebruikt. Door dit te doen bespaart u energie en beperkt u de CO<sub>2</sub>-emissies. Breng een bezoek aan [www.dlinkgreen.com](http://www.dlinkgreen.com) voor meer informatie over onze milieuverantwoorde producten en verpakkingen

## POLSKI

PL



Ten symbol umieszczony na produkcie lub opakowaniu oznacza, że zgodnie z miejscowym prawem i lokalnymi przepisami niniejszego produktu nie wolno wyrzucać jak odpady czy śmieci z gospodarstwa domowego, lecz należy go poddać procesowi recyklingu. Po zakończeniu użytkowania produktu, niektóre odpowiednie do tego celu podmioty przyjmą takie produkty nieodpłatnie, dlatego prosimy dostarczyć go do punktu zbiórki wskazanego przez lokalne władze. Poprzez proces recyklingu i dzięki takiemu postępowaniu z produktem oraz jego opakowaniem, pomogą Państwo chronić środowisko naturalne i dbać o ludzkie zdrowie.

### D-Link i środowisko

W D-Link podchodzimy w sposób świadomy do ochrony otoczenia oraz jesteśmy zaangażowani w zmniejszanie wpływu naszych działań i produktów na środowisko naturalne. W celu zminimalizowania takiego wpływu firma D-Link konstruuje i wytwarza swoje produkty w taki sposób, aby były one jak najbardziej przyjazne środowisku, stosując do tych celów materiały nadające się do powtórnego wykorzystania, charakteryzujące się małą toksycznością zarówno w przypadku samych produktów jak i opakowań.

Firma D-Link zaleca, aby Państwo zawsze prawidłowo wyłączyli z użytku swoje produkty D-Link, gdy nie są one wykorzystywane. Postępując w ten sposób pozwalają Państwo oszczędzać energię i zmniejszać emisje CO<sub>2</sub>.

Aby dowiedzieć się więcej na temat produktów i opakowań mających wpływ na środowisko prosimy zapoznać się ze stroną internetową [www.dlinkgreen.com](http://www.dlinkgreen.com).

## ČESKY

CZ



Tento symbol na výrobku nebo jeho obalu znamená, že podle místně platných předpisů se výrobek nesmí vyhazovat do komunálního odpadu, ale odeslat k recyklaci. Až výrobek doslouží, odneste jej prosím na sběrné místo určené místními úřady k tomuto účelu. Některá sběrná místa přijímají výrobky zdarma. Recyklací výrobku i obalu pomáháte chránit životní prostředí i lidské zdraví.

### D-Link a životní prostředí

Ve společnosti D-Link jsme si vědomi vlivu našich provozů a výrobků na životní prostředí a snažíme se o minimalizaci těchto vlivů. Proto své výrobky navrhujeme a vyrábíme tak, aby byly co nejekologičtější, a ve výrobcích i obalech používáme recyklovatelné a nízkotoxické materiály. Společnost D-Link doporučuje, abyste své výrobky značky D-Link vypnuli nebo vytáhli ze zásuvky vždy, když je nepoužíváte. Pomůžete tak šetřit energii a snížit emise CO<sub>2</sub>.

Více informací o našich ekologických výrobcích a obalech najdete na adrese [www.dlinkgreen.com](http://www.dlinkgreen.com).

## MAGYAR

HU



Ez a szimbólum a terméken vagy a csomagoláson azt jelenti, hogy a helyi törvényeknek és szabályoknak megfelelően ez a termék nem semmisíthető meg a háztartási hulladékkal együtt, hanem újrahasznosításra kell küldeni. Kérjük, hogy a termék élettartamának elteltét követően vigye azt a helyi hatóság által kijelölt gyűjtőhelyre. A termékek egyes helyeken ingyen elhelyezhetők. A termék és a csomagolás újrahasznosításával segíti védeni a környezetet és az emberek egészségét.

### A D-Link és a környezet

A D-Linknél megértjük és elköteleztettek vagyunk a műveleteink és termékeink környezetre gyakorolt hatásainak csökkentésére. Az ezen hatás csökkentése érdekében a D-Link a lehető leginkább környezetbarát termékeket tervez és gyárt azáltal, hogy újrahasznosítható, alacsony károsanyag-tartalmú termékeket gyárt és csomagolásokat alkalmaz.

A D-Link azt javasolja, hogy mindig kapcsolja ki vagy húzza ki a D-Link termékeket a tápforrásból, ha nem használja azokat. Ezzel segít az energia megtakarításában és a szén-dioxid kibocsátásának csökkentésében.

Környezetbarát termékeinkről és csomagolásainkról további információkat a [www.dlinkgreen.com](http://www.dlinkgreen.com) weboldalon tudhat meg.

## NORSK

NO



Dette symbolet på produktet eller forpakningen betyr at dette produktet ifølge lokale lover og forskrifter ikke skal kastes sammen med husholdningsavfall, men leveres inn til gjenvinning. Vennligst ta det til et innsamlingssted anvist av lokale myndigheter når det er kommet til slutten av levetiden. Noen steder aksepteres produkter uten avgift. Ved på denne måten å gjenvinne produktet og forpakningen hjelper du å verne miljøet og beskytte folks helse.

### D-Link og miljøet

Hos D-Link forstår vi oss på og er forpliktet til å minske innvirkningen som vår drift og våre produkter kan ha på miljøet. For å minimalisere denne innvirkningen designer og lager D-Link produkter som er så miljøvennlig som mulig, ved å bruke resirkulerbare, lav-toksiske materialer både i produktene og forpakningen.

D-Link anbefaler at du alltid slår av eller frakobler D-Link-produkter når de ikke er i bruk. Ved å gjøre dette hjelper du å spare energi og å redusere CO2-utslipp.

For mer informasjon angående våre miljøansvarlige produkter og forpakninger kan du gå til [www.dlinkgreen.com](http://www.dlinkgreen.com)

## DANSK

DK



Dette symbol på produktet eller emballagen betyder, at dette produkt i henhold til lokale lover og regler ikke må bortskaffes som husholdningsaffald, mens skal sendes til genbrug. Indlever produktet til et indsamlingssted som angivet af de lokale myndigheder, når det er nået til slutningen af dets levetid. I nogle tilfælde vil produktet blive modtaget gratis. Ved at indlevere produktet og dets emballage til genbrug på denne måde bidrager du til at beskytte miljøet og den menneskelige sundhed.

### D-Link og miljøet

Hos D-Link forstår vi og bestræber os på at reducere enhver indvirkning, som vores aktiviteter og produkter kan have på miljøet. For at minimere denne indvirkning designer og producerer D-Link sine produkter, så de er så miljøvenlige som muligt, ved at bruge genanvendelige materialer med lavt giftighedsniveau i både produkter og emballage.

D-Link anbefaler, at du altid slukker eller frakobler dine D-Link-produkter, når de ikke er i brug. Ved at gøre det bidrager du til at spare energi og reducere CO2-udledningerne.

Du kan finde flere oplysninger om vores miljømæssigt ansvarlige produkter og emballage på [www.dlinkgreen.com](http://www.dlinkgreen.com)

## SUOMI

FI



Tämä symboli tuotteen pakkauksessa tarkoittaa, että paikallisten lakien ja säännösten mukaisesti tätä tuotetta ei pidä hävittää yleisen kotitalousjätteen seassa vaan se tulee toimittaa kierrätettäväksi. Kun tuote on elinkaarensa päässä, toimita se lähimpään viranomaisten hyväksymään kierrätyspisteeseen. Kierrättämällä käytetyn tuotteen ja sen pakkauksen autat tukemaan sekä ympäristön että ihmisten terveyttä ja hyvinvointia.

### D-Link ja ympäristö

D-Link ymmärtää ympäristönsuojelun tärkeyden ja on sitoutunut vähentämään tuotteistaan ja niiden valmistuksesta ympäristölle mahdollisesti aiheutuvia haittavaikutuksia. Nämä negatiiviset vaikutukset minimoidakseen D-Link suunnittelee ja valmistaa tuotteensa mahdollisimman ympäristöystävällisiksi käyttämällä kierrätettäviä, alhaisia pitoisuuksia haitallisia aineita sisältäviä materiaaleja sekä tuotteissaan että niiden pakkauksissa.

Suosittelemme, että irrotat D-Link-tuotteesi virtalähteestä tai sammutat ne aina, kun ne eivät ole käytössä. Toimimalla näin autat säästämään energiaa ja vähentämään hiilidioksidipäästöjä.

Lue lisää ympäristöystävällisistä D-Link-tuotteista ja pakkauksistamme osoitteesta [www.dlinkgreen.com](http://www.dlinkgreen.com)

## SVENSKA

SE



Den här symbolen på produkten eller förpackningen betyder att produkten enligt lokala lagar och föreskrifter inte skall kastas i hushållsoporna utan i stället återvinnas. Ta den vid slutet av dess livslängd till en av din lokala myndighet utsedd uppsamlingsplats, vissa accepterar produkter utan kostnad. Genom att på detta sätt återvinna produkten och förpackningen hjälper du till att bevara miljön och skydda människors hälsa.

### D-Link och miljön

På D-Link förstår vi och är fast beslutna att minska den påverkan våra verksamheter och produkter kan ha på miljön. För att minska denna påverkan utformar och bygger D-Link sina produkter för att de ska vara så miljövänliga som möjligt, genom att använda återvinningsbara material med låg gifthalt i både produkter och förpackningar.

D-Link rekommenderar att du alltid stänger av eller kopplar ur dina D-Link produkter när du inte använder dem. Genom att göra detta hjälper du till att spara energi och minska utsläpp av koldioxid.

För mer information om våra miljöansvariga produkter och förpackningar [www.dlinkgreen.com](http://www.dlinkgreen.com)

## PORTUGUÊS

PT



Este símbolo no produto ou embalagem significa que, de acordo com as leis e regulamentações locais, este produto não deverá ser eliminado juntamente com o lixo doméstico mas enviado para a reciclagem. Transporte-o para um ponto de recolha designado pelas suas autoridades locais quando este tiver atingido o fim da sua vida útil, alguns destes pontos aceitam produtos gratuitamente. Ao reciclar o produto e respectiva embalagem desta forma, ajuda a preservar o ambiente e protege a saúde humana.

### A D-Link e o ambiente

Na D-Link compreendemos e comprometemo-nos com a redução do impacto que as nossas operações e produtos possam ter no ambiente. Para minimizar este impacto a D-Link concebe e constrói os seus produtos para que estes sejam o mais inofensivos para o ambiente possível, utilizando materiais recicláveis e não tóxicos tanto nos produtos como nas embalagens.

A D-Link recomenda que desligue os seus produtos D-Link quando estes não se encontrarem em utilização. Com esta acção ajudará a poupar energia e reduzir as emissões de CO2.

Para saber mais sobre os nossos produtos e embalagens responsáveis a nível ambiental visite [www.dlinkgreen.com](http://www.dlinkgreen.com)

## РУССКИЙ

RU



Этот символ на продукте или упаковке означает, что в соответствии с нормами местного законодательства данный продукт в случае выхода из строя подлежит утилизации, и от него нельзя избавиться как от обычного бытового мусора. Отнесите устройство в ближайшую службу утилизации и переработки. При утилизации продукта и его упаковки таким образом обеспечивается защита окружающей среды и не наносится вред здоровью людей.

### Забота D-Link об окружающей среде

Компания D-Link стремится максимально сократить негативное влияние своей деятельности на окружающую среду. Поэтому D-Link разрабатывает максимально экологичные продукты, используя легкоперерабатываемые и низкотоксичные материалы как для изготовления самих продуктов, так и их упаковки.

Кроме того, D-Link рекомендует отключать устройства, если они не используются. Это обеспечит энергосбережение и сократит выброс в атмосферу углекислого газа.

Более подробная информация об экологичной продукции D-Link доступна на сайте [www.dlinkgreen.com](http://www.dlinkgreen.com)



---

# D-LINK GPL CODE STATEMENT

This D-Link product includes software code developed by third parties, including software code subject to the GNU General Public License ("GPL") or GNU Lesser General Public License ("LGPL"). As applicable, the terms of the GPL and LGPL, and information on obtaining access to the GPL code and LGPL code used in this product, are available to you at:

<http://tsd.dlink.com.tw/GPL.asp>

The GPL code and LGPL code used in this product are distributed WITHOUT ANY WARRANTY and is subject to the copyrights of one or more authors. For details, see the GPL code and the LGPL code for this product and the terms of the GPL and LGPL.

## WRITTEN OFFER FOR GPL AND LGPL SOURCE CODE

Where such specific license terms entitle you to the source code of such software, D-Link will provide upon written request via email and/or traditional paper mail the applicable GPL and LGPL source code files via CD-ROM for a nominal cost to cover shipping and media charges as allowed under the GPL and LGPL.

Technical Support: For product support, please visit <http://support.dlink.com> for further assistance.

General Public License ("GPL") Inquiries: Please direct all GPL inquiries to the following email/address. Note that technical support inquiries will not be supported at the below address.

Email:  
[GPLCODE@DLink.com](mailto:GPLCODE@DLink.com)

Snail Mail:  
Attn: GPLSOURCE REQUEST  
D-Link Systems, Inc.  
17595 Mt. Herrmann Street  
Fountain Valley, CA 92708

---

## GNU GENERAL PUBLIC LICENSE

Version 2, June 1991

Copyright (C) 1989, 1991 Free Software Foundation, Inc.  
51 Franklin Street, Fifth Floor, Boston, MA 02110-1301, USA

Everyone is permitted to copy and distribute verbatim copies of this license document, but changing it is not allowed.

### PREAMBLE

The licenses for most software are designed to take away your freedom to share and change it. By contrast, the GNU General Public License is intended to guarantee your freedom to share and change free software—to make sure the software is free for all its users. This General Public License applies to most of the Free Software Foundation's software and to any other program whose authors commit to using it. (Some other Free Software Foundation software is covered by the GNU Library General Public License instead.) You can apply it to your programs, too.

When we speak of free software, we are referring to freedom, not price. Our General Public Licenses are designed to make sure that you have the freedom to distribute copies of free software (and charge for this service if you wish), that you receive source code or can get it if you want it, that you can change the software or use pieces of it in new free programs; and that you know you can do these things.

To protect your rights, we need to make restrictions that forbid anyone to deny you these rights or to ask you to surrender the rights. These restrictions translate to certain responsibilities for you if you distribute copies of the software, or if you modify it. For example, if you distribute copies of such a program, whether gratis or for a fee, you must give the recipients all the rights that you have. You must make sure that they, too, receive or can get the source code. And you must show them these terms so they know their rights.

We protect your rights with two steps: (1) copyright the software, and (2) offer you this license which gives you legal permission to copy, distribute and/or modify the software.

Also, for each author's protection and ours, we want to make certain that everyone understands that there is no warranty for this free software. If the software is modified by someone else and passed on, we want its recipients to know that what they have is not the original, so that any problems introduced by others will not reflect on the original authors' reputations.

Finally, any free program is threatened constantly by software patents. We wish to avoid the danger that redistributors of a free program will individually obtain patent licenses, in effect making the program proprietary. To prevent this, we have made it clear that any patent must be licensed for everyone's free use or not licensed at all.

The precise terms and conditions for copying, distribution and modification follow.

---

## GNU GENERAL PUBLIC LICENSE TERMS AND CONDITIONS FOR COPYING, DISTRIBUTION AND MODIFICATION

0. This License applies to any program or other work which contains a notice placed by the copyright holder saying it may be distributed under the terms of this General Public License. The "Program", below, refers to any such program or work, and a "work based on the Program" means either the Program or any derivative work under copyright law: that is to say, a work containing the Program or a portion of it, either verbatim or with modifications and/or translated into another language. (Hereinafter, translation is included without limitation in the term "modification".) Each licensee is addressed as "you".

Activities other than copying, distribution and modification are not covered by this License; they are outside its scope. The act of running the Program is not restricted, and the output from the Program is covered only if its contents constitute a work based on the Program (independent of having been made by running the Program). Whether that is true depends on what the Program does.

1. You may copy and distribute verbatim copies of the Program's source code as you receive it, in any medium, provided that you conspicuously and appropriately publish on each copy an appropriate copyright notice and disclaimer of warranty; keep intact all the notices that refer to this License and to the absence of any warranty; and give any other recipients of the Program a copy of this License along with the Program.

You may charge a fee for the physical act of transferring a copy, and you may at your option offer warranty protection in exchange for a fee.

2. You may modify your copy or copies of the Program or any portion of it, thus forming a work based on the Program, and copy and distribute such modifications or work under the terms of Section 1 above, provided that you also meet all of these conditions:

- a) You must cause the modified files to carry prominent notices stating that you changed the files and the date of any change.
- b) You must cause any work that you distribute or publish, that in whole or in part contains or is derived from the Program or any part thereof, to be licensed as a whole at no charge to all third parties under the terms of this License.
- c) If the modified program normally reads commands interactively when run, you must cause it, when started running for such interactive use in the most ordinary way, to print or display an announcement including an appropriate copyright notice and a notice that there is no warranty (or else, saying that you provide a warranty) and that users may redistribute the program under these conditions, and telling the user how to view a copy of this License. (Exception: if the Program itself is interactive but does not normally print such an announcement, your work based on the Program is not required to print an announcement.)

---

These requirements apply to the modified work as a whole. If identifiable sections of that work are not derived from the Program, and can be reasonably considered independent and separate works in themselves, then this License, and its terms, do not apply to those sections when you distribute them as separate works. But when you distribute the same sections as part of a whole which is a work based on the Program, the distribution of the whole must be on the terms of this License, whose permissions for other licensees extend to the entire whole, and thus to each and every part regardless of who wrote it.

Thus, it is not the intent of this section to claim rights or contest your rights to work written entirely by you; rather, the intent is to exercise the right to control the distribution of derivative or collective works based on the Program.

In addition, mere aggregation of another work not based on the Program with the Program (or with a work based on the Program) on a volume of a storage or distribution medium does not bring the other work under the scope of this License.

3. You may copy and distribute the Program (or a work based on it, under Section 2) in object code or executable form under the terms of Sections 1 and 2 above provided that you also do one of the following:

- a) Accompany it with the complete corresponding machine-readable source code, which must be distributed under the terms of Sections 1 and 2 above on a medium customarily used for software interchange; or,
- b) Accompany it with a written offer, valid for at least three years, to give any third party, for a charge no more than your cost of physically performing source distribution, a complete machine-readable copy of the corresponding source code, to be distributed under the terms of Sections 1 and 2 above on a medium customarily used for software interchange; or,
- c) Accompany it with the information you received as to the offer to distribute corresponding source code. (This alternative is allowed only for noncommercial distribution and only if you received the program in object code or executable form with such an offer, in accord with Subsection b above.)

The source code for a work means the preferred form of the work for making modifications to it. For an executable work, complete source code means all the source code for all modules it contains, plus any associated interface definition files, plus the scripts used to control compilation and installation of the executable. However, as a special exception, the source code distributed need not include anything that is normally distributed (in either source or binary form) with the major components (compiler, kernel, and so on) of the operating system on which the executable runs, unless that component itself accompanies the executable.

If distribution of executable or object code is made by offering access to copy from a designated place, then offering equivalent access to copy the source code from the same place counts as distribution of the source code, even though third parties are not compelled to copy the source along with the object code.

4. You may not copy, modify, sublicense, or distribute the Program except as expressly provided under this License. Any attempt otherwise to copy, modify, sublicense or distribute the Program is void, and will automatically terminate your rights under this License. However, parties who have received copies, or rights, from you under this License will not have their licenses terminated so long as such parties remain in full compliance.

5. You are not required to accept this License, since you have not signed it. However, nothing else grants you permission to modify or distribute the Program or its derivative works. These actions are prohibited by law if you do not accept this License. Therefore, by modifying or distributing the Program (or any work based on the Program), you indicate your acceptance of this License to do so, and all its terms and conditions for copying, distributing or modifying the Program or works based on it.

6. Each time you redistribute the Program (or any work based on the Program), the recipient automatically receives a license from the original licensor to copy, distribute or modify the Program subject to these terms and conditions. You may not impose any further restrictions on the recipients' exercise of the rights granted herein. You are not responsible for enforcing compliance by third parties to this License.

7. If, as a consequence of a court judgment or allegation of patent infringement or for any other reason (not limited to patent issues), conditions are imposed on you (whether by court order, agreement or otherwise) that contradict the conditions of this License, they do not excuse you from the conditions of this License. If you cannot distribute so as to satisfy simultaneously your obligations under this License and any other pertinent obligations, then as a consequence you may not distribute the Program at all. For example, if a patent license would not permit royalty-free redistribution of the Program by all those who receive copies directly or indirectly through you, then the only way you could satisfy both it and this License would be to refrain entirely from distribution of the Program.

If any portion of this section is held invalid or unenforceable under any particular circumstance, the balance of the section is intended to apply and the section as a whole is intended to apply in other circumstances.

It is not the purpose of this section to induce you to infringe any patents or other property right claims or to contest validity of any such claims; this section has the sole purpose of protecting the integrity of the free software distribution system, which is implemented by public license practices. Many people have made generous contributions to the wide range of software distributed through that system in reliance on consistent application of that system; it is up to the author/donor to decide if he or she is willing to distribute software through any other system and a licensee cannot impose that choice.

This section is intended to make thoroughly clear what is believed to be a consequence of the rest of this License.

8. If the distribution and/or use of the Program is restricted in certain countries either by patents or by copyrighted interfaces, the original copyright holder who places the Program under this License may add an explicit geographical distribution limitation excluding those countries, so that distribution is permitted only in or among countries not thus excluded. In such case, this License incorporates the limitation as if written in the body of this License.

9. The Free Software Foundation may publish revised and/or new versions of the General Public License from time to time. Such new versions will be similar in spirit to the present version, but may differ in detail to address new problems or concerns. Each version is given a distinguishing version number. If the Program specifies a version number of this License which applies to it and "any later version", you have the option of following the terms and conditions either of that version or of any later version published by the Free Software Foundation. If the Program does not specify a version number of this License, you may choose any version ever published by the Free Software Foundation.

10. If you wish to incorporate parts of the Program into other free programs whose distribution conditions are different, write to the author to ask for permission. For software which is copyrighted by the Free Software Foundation, write to the Free Software Foundation; we sometimes make exceptions for this. Our decision will be guided by the two goals of preserving the free status of all derivatives of our free software and of promoting the sharing and reuse of software generally.

---

## NO WARRANTY

11. BECAUSE THE PROGRAM IS LICENSED FREE OF CHARGE, THERE IS NO WARRANTY FOR THE PROGRAM, TO THE EXTENT PERMITTED BY APPLICABLE LAW. EXCEPT WHEN OTHERWISE STATED IN WRITING THE COPYRIGHT HOLDERS AND/OR OTHER PARTIES PROVIDE THE PROGRAM "AS IS" WITHOUT WARRANTY OF ANY KIND, EITHER EXPRESSED OR IMPLIED, INCLUDING, BUT NOT LIMITED TO, THE IMPLIED WARRANTIES OF MERCHANTABILITY AND FITNESS FOR A PARTICULAR PURPOSE. THE ENTIRE RISK AS TO THE QUALITY AND PERFORMANCE OF THE PROGRAM IS WITH YOU. SHOULD THE PROGRAM PROVE DEFECTIVE, YOU ASSUME THE COST OF ALL NECESSARY SERVICING, REPAIR OR CORRECTION.

12. IN NO EVENT UNLESS REQUIRED BY APPLICABLE LAW OR AGREED TO IN WRITING WILL ANY COPYRIGHT HOLDER, OR ANY OTHER PARTY WHO MAY MODIFY AND/OR REDISTRIBUTE THE PROGRAM AS PERMITTED ABOVE, BE LIABLE TO YOU FOR DAMAGES, INCLUDING ANY GENERAL, SPECIAL, INCIDENTAL OR CONSEQUENTIAL DAMAGES ARISING OUT OF THE USE OR INABILITY TO USE THE PROGRAM (INCLUDING BUT NOT LIMITED TO LOSS OF DATA OR DATA BEING RENDERED INACCURATE OR LOSSES SUSTAINED BY YOU OR THIRD PARTIES OR A FAILURE OF THE PROGRAM TO OPERATE WITH ANY OTHER PROGRAMS), EVEN IF SUCH HOLDER OR OTHER PARTY HAS BEEN ADVISED OF THE POSSIBILITY OF SUCH DAMAGES.

END OF TERMS AND CONDITIONS

## HOW TO APPLY THESE TERMS TO YOUR NEW PROGRAMS

If you develop a new program, and you want it to be of the greatest possible use to the public, the best way to achieve this is to make it free software which everyone can redistribute and change under these terms.

To do so, attach the following notices to the program. It is safest to attach them to the start of each source file to most effectively convey the exclusion of warranty; and each file should have at least the "copyright" line and a pointer to where the full notice is found.

<one line to give the program's name and a brief idea of what it does.>

Copyright (C) <year> <name of author>

This program is free software; you can redistribute it and/or modify it under the terms of the GNU General Public License as published by the Free Software Foundation; either version 2 of the License, or (at your option) any later version.

This program is distributed in the hope that it will be useful, but WITHOUT ANY WARRANTY; without even the implied warranty of MERCHANTABILITY or FITNESS FOR A PARTICULAR PURPOSE. See the GNU General Public License for more details.

You should have received a copy of the GNU General Public License along with this program; if not, write to the Free Software Foundation, Inc., 51 Franklin Street, Fifth Floor, Boston, MA 02110-1301, USA.

Also add information on how to contact you by electronic and paper mail.

If the program is interactive, make it output a short notice like this when it starts in an interactive mode:

Gnomovision version 69, Copyright (C) year name of author Gnomovision comes with ABSOLUTELY NO WARRANTY; for details type `show w'.

This is free software, and you are welcome to redistribute it under certain conditions; type `show c' for details.

The hypothetical commands `show w' and `show c' should show the appropriate parts of the General Public License. Of course, the commands you use may be called something other than `show w' and `show c'; they could even be mouse-clicks or menu items--whatever suits your program.

You should also get your employer (if you work as a programmer) or your school, if any, to sign a "copyright disclaimer" for the program, if necessary. Here is a sample; alter the names:

Yoyodyne, Inc., hereby disclaims all copyright interest in the program 'Gnomovision' (which makes passes at compilers) written by James Hacker.

<signature of Ty Coon>, 1 April 1989  
Ty Coon, President of Vice

This General Public License does not permit incorporating your program into proprietary programs. If your program is a subroutine library, you may consider it more useful to permit linking proprietary applications with the library. If this is what you want to do, use the GNU Library General Public License instead of this License.

---

# Notes

---

# Notes

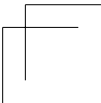
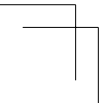
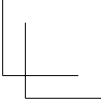
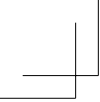

**D-Link®**



Ver. 2.00(WW)\_130x183  
2017/06/13  
0420122-DL