



**THE DISPLAY CHOICE
OF PROFESSIONALS™**

www.agneovo.com

X-15P LED-Backlit Display
User Manual

TABLE OF CONTENTS

Safety Information	4
FCC Disclaimers	4
WEEE	5
Precautions	6
Notice	6
Cautions When Setting Up	6
Cautions When Using.....	7
Cleaning and Maintenance.....	7
Notice for the LCD Display	8
Chapter 1: Product Description	9
1.1 Package Contents	9
1.2 Wall Mounting Installation Preparation	10
1.2.2 Removing the Base Stand.....	10
1.2.1 Wall Mounting.....	10
1.3 LCD Display Overview	11
1.3.1 Front View and Keypad Buttons.....	11
1.3.2 Rear View.....	12
Chapter 2: Making Connections	13
2.1 Connecting the Power	13
2.2 Connecting Input Source Signals	14
2.2.1 Connecting a Computer	14
Using VGA Cables	14
Using DVI Cables.....	14
Connecting an Audio Device	15
2.2.2 Connecting a Camera or Video Device	15
Using CVBS Cables	15
Using S-Video Cables	16
Chapter 3: Using the LCD Display	17
3.1 Turning on the Power	17
3.2 Selecting the Input Source Signal	17
3.3 Adjusting the Volume.....	18
3.4 Locking the OSD Menu	18
3.5 Using Picture-in-Picture (PIP)	19
3.5.1 PIP Options	19
3.5.2 PIP Swap.....	20
3.6 Using ROTATE Function	20
3.7 Using Auto Adjustment Function	21
Chapter 4: On Screen Display Menu	22
4.1 Using the OSD Menu	22
4.2 OSD Menu Tree	24

TABLE OF CONTENTS

Chapter 5: Adjusting the Settings	27
5.1 Brightness Setting	27
5.2 Colour Setting	28
5.3 Image Setting (VGA only).....	29
5.4 Image Setting (Video signals)	30
5.5 PIP Setting	32
5.6 OSD Setting	34
5.7 Audio Setting	35
5.8 Other Setting	36
5.9 Auto Brightness	38
5.9.1 EcoSmart Sensor	38
5.10 Input Select	39
Chapter 6: Appendix	40
6.1 Warning Messages.....	40
6.2 Troubleshooting	41
6.3 Transporting the LCD Display	42
Chapter 7: Specifications	43
7.1 Display Specifications	43
7.2 Display Dimensions.....	44
7.2.1 X-15P Dimensions.....	44

SAFETY INFORMATION



This FCC Class-B compliant digital device complies with the Interference-Causing Equipment Regulations of Canada.

FCC Disclaimers

This device complies with Section 15 of the FCC listing. The operation procedures must meet the following conditions: (1) the device must not cause any damaging interference; and (2) this device must accept any received interference, including any unpredictable interference that may possibly occur.

Dear users,

This device has passed the Class B digital service regulations and complies with Section 15 of the FCC listing; these are intended to provide reasonable warranty against damaging interference for home use. This device will produce, use, and emit radio frequency energy; therefore, installation or use without following the instructions given may cause damaging interference to radio communication. Nonetheless, it is not possible to state with certainty that interference will occur from specific installations. If this device has caused damaging interference to radio or TV signals (simply turn the device on and off to check if such interference is caused by the device), we recommend that you fix the interference using the following methods:

- Readjust the direction or location of the antenna.
- Increase the distance between this device and the receiver.
- Consult your local dealer or an experienced radio/TV technician.



Warning:

Making changes or modifications to the device without the permission from an authorized dealer may void the warranty of this device.

SAFETY INFORMATION

WEEE

Information for users applicable in European Union countries.

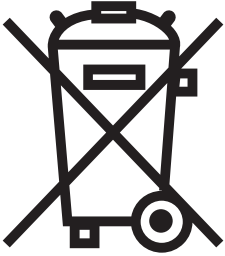

The symbol on the product or its packaging signifies that this product has to be disposed separately from ordinary household wastes at its end of life. Please kindly be aware that this is your responsibility to dispose electronic equipment at recycling centers so as to help conserve natural resources. Each country in the European Union should have its collection centers for electrical and electronic equipment recycling. For information about your recycling drop off area, please contact your local related electrical and electronic equipment waste management authority or the retailer where you bought the product.

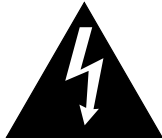

PRECAUTIONS



CAUTION
RISK OF ELECTRIC SHOCK
DO NOT OPEN



Symbols used in this manual

	This icon indicates the existence of a potential hazard that could result in personal injury or damage to the product.
	This icon indicates important operating and servicing information.

Notice

- Read this User Manual carefully before using the LCD display and keep it for future reference.
- The product specifications and other information provided in this User Manual are for reference only. All information is subject to change without notice. Updated content can be downloaded from our web site at <http://www.agneovo.com>.
- To register online, go to <http://www.agneovo.com>.
- To protect your rights as a consumer, do not remove any stickers from the LCD display. Doing so may affect the determination of the warranty period.

Cautions When Setting Up



Do not place the LCD display near heat sources, such as a heater, exhaust vent, or in direct sunlight.



Do not cover or block the ventilation holes in the housing.



Place the LCD display on a stable area. Do not place the LCD display where it may be subject to vibration or shock.



Place the LCD display in a well-ventilated area.



Do not place the LCD display outdoors.



Do not place the LCD display in a dusty or humid environment.



Do not spill liquid or insert sharp objects into the LCD display through the ventilation holes. Doing so may cause accidental fire, electric shock or damage the LCD display.

PRECAUTIONS

Cautions When Using



Use only the power cord supplied with the LCD display.



The power outlet should be installed near the LCD display and be easily accessible.



If an extension cord is used with the LCD display, ensure that the total current consumption plugged into the power outlet does not exceed the ampere rating.



Do not allow anything to rest on the power cord. Do not place the LCD display where the power cord may be stepped on.



If the LCD display will not be used for an indefinite period of time, unplug the power cord from the power outlet.



To disconnect the power cord, grasp and pull by the plug head. Do not tug on the cord; doing so may cause fire or electric shock.



Do not unplug or touch the power cord with wet hands.

Cleaning and Maintenance



The LCD display comes with NeoV™ Optical Glass. Use a soft cloth lightly moistened with a mild detergent solution to clean the glass surface and the housing.



Do not rub or tap the surface of the glass with sharp or abrasive items such as a pen or screwdriver. This may result in scratching the surface of the glass.



Do not attempt to service the LCD display yourself, refer to qualified service personnel. Opening or removing the covers may expose you to dangerous voltage or other risks.



Warning:



Unplug the power cord from the power outlet and refer to qualified service personnel under the following conditions:

- ◆ When the power cord is damaged.
- ◆ If the LCD display has been dropped or the housing has been damaged.
- ◆ If the LCD display emits smoke or a distinct odor.



Warning:



Ceiling mount or mount on any other horizontal surface overhead are not advisable.

Installation in contravention of the instructions may result in undesirable consequences, particularly hurting people and damaging property. Users who have already mounted the display on the ceiling or any other horizontal surface overhead are strongly advised to contact AG Neovo for consultations and solutions to help ensure a most pleasurable and fulfilling display experience.

PRECAUTIONS

Notice for the LCD Display

In order to maintain the stable luminous performance, it is recommended to use low brightness setting.

Due to the lifespan of the lamp, it is normal that the brightness quality of the LCD display may decrease with time.

When static images are displayed for long periods of time, the image may cause an imprint on the LCD display. This is called image retention or burn-in.

To prevent image retention, do any of the following:

- Set the LCD display to turn off after a few minutes of being idle.
- Use a screen saver that has moving graphics or a blank white image.
- Switch desktop backgrounds regularly.
- Adjust the LCD display to low brightness settings.
- Turn off the LCD display when the system is not in use.

Things to do when the LCD display shows image retention:

- Turn off the LCD display for extended periods of time. It can be several hours or several days.
- Use a screen saver and run it for extended periods of time.
- Use a black and white image and run it for extended periods of time.

When the LCD display is moved from one room to another or there is a sudden change from low to high ambient temperature, dew condensation may form on or inside the glass surface. When this happens, do not turn on the LCD display until the dew disappears.

Due to humid weather conditions, it is normal for mist to form inside the glass surface of the LCD display. The mist will disappear after a few days or as soon as the weather stabilizes.

There are millions of micro transistors inside the LCD display. It is normal for a few transistors to be damaged and to produce spots. This is acceptable and is not considered a failure.

CHAPTER 1: PRODUCT DESCRIPTION

1.1 Package Contents

When unpacking, check if the following items are included in the package. If any of them is missing or damaged, contact your dealer.

LCD Display

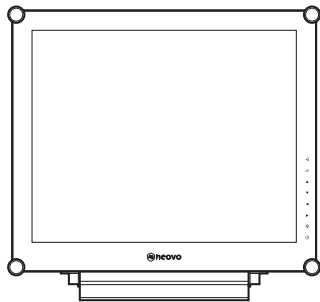

User manual

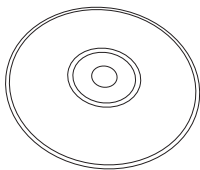

Warranty card

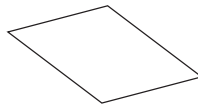

Power cord

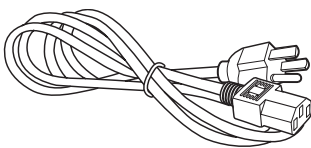

VGA cable

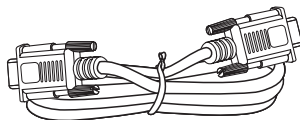

Power adapter

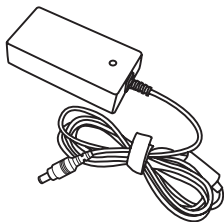

Audio cable

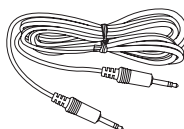

Note:

Must use only the supplied power adapter:

- ◆ Lite-on Technology Corporation
Model no.: PA-1051-0
Rating: 12V/4.16A
- ◆ Lite-on Technology Co., Ltd
Model no.: P/N: PA-1041-81
Rating: 12V/3.33A

Note:

- ◆ The pictures are for reference only. Actual items may vary upon shipment.

PRODUCT DESCRIPTION

1.2 Wall Mounting Installation Preparation

1.2.1 Wall Mounting

1 Remove the base stand.

See procedures below.

2 Wall mount the LCD display.

Screw the mounting bracket to the VESA holes at the rear of the LCD display.

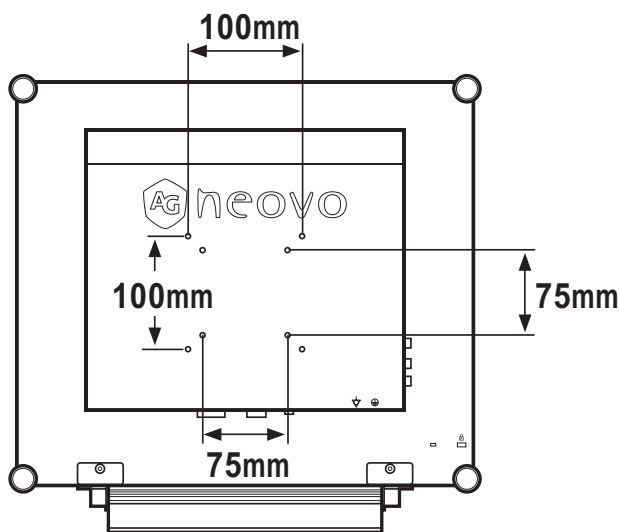

1.2.2 Removing the Base Stand

- 1 Lay the LCD display face down on a flat even surface.
- 2 Remove the four screws securing the base stand from the LCD display.
- 3 Detach the base stand.
- 4 Put 2 screws back to the rear of the LCD display.

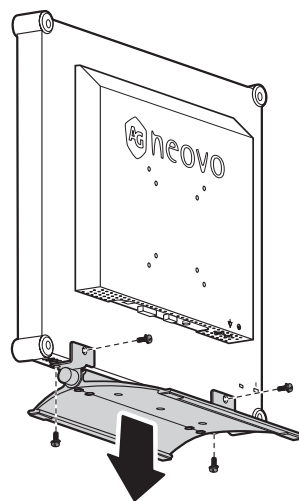

Note:

To protect the glass panel, place a towel or soft cloth before laying the LCD display down.

Note:

Take measures to prevent the LCD display from falling down and lessen possible injury and damage to the display in case of earthquakes or other disasters.

- ◆ Use only the 75 x 75 mm and 100 x 100 mm wall mount kit recommended by AG Neovo.
- ◆ Secure the LCD display on a solid wall strong enough to bear its weight.
- ◆ Use M4 x 10 mm screws to connect the monitor to the wall-mounting kit.

PRODUCT DESCRIPTION

1.3 LCD Display Overview

1.3.1 Front View and Keypad Buttons

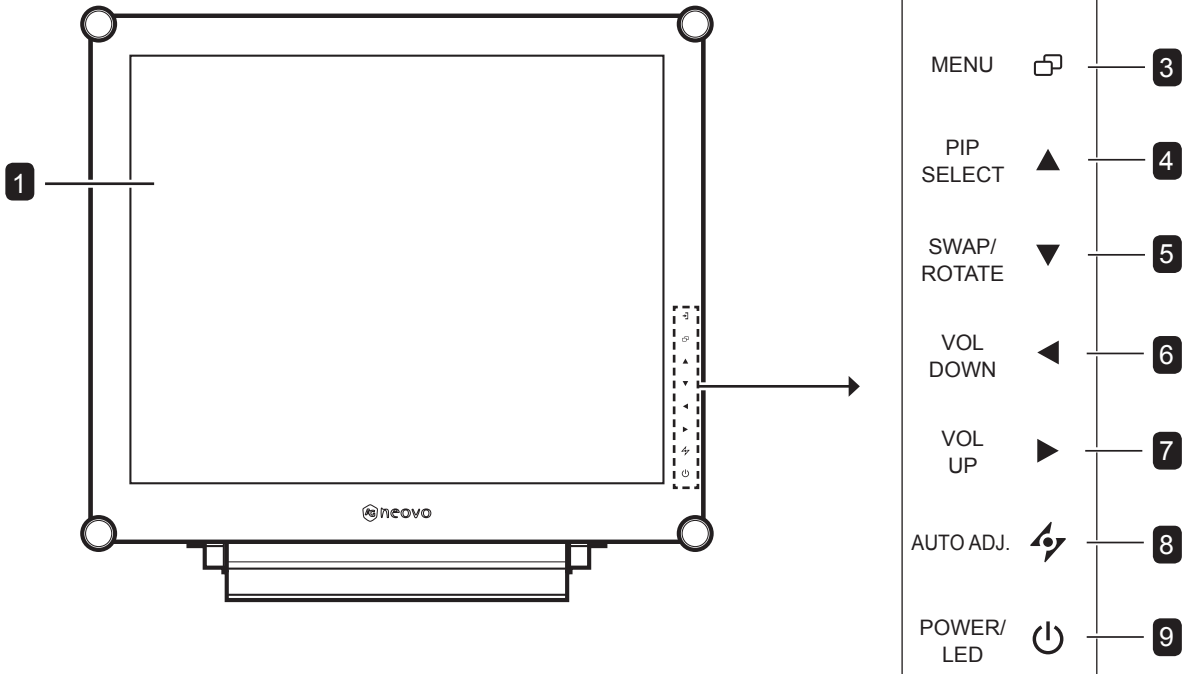

1 Display screen

The LCD display screen is protected by NeoV™ Optical Glass.

2 SOURCE

- Press repeatedly to select the input signal source.

3 MENU

- Press to display the OSD menu.
- Press again to hide the OSD menu.

4 UP

- Press repeatedly to select PIP option.
- During OSD menu selection, press to move up a menu or submenu.

5 DOWN

- Press to swap the PIP main and sub picture.
- When PIP is off, press to rotate the image 180°.
- During OSD menu selection, press to move up a menu or submenu.

6 LEFT

- Press to decrease the volume.
- During OSD menu selection, press to adjust the settings.

7 RIGHT

- Press to increase the volume.
- During OSD menu selection, press to select an option and adjust the settings.

8 AUTO

- For VGA input signal source, press to perform auto adjustment.
- During OSD menu selection, press to close the OSD menu or exit a submenu.

9 POWER / LED indicator

- Press to turn the power on or off.
Green - Power on
Amber - Standby mode
Off - Power off

PRODUCT DESCRIPTION

1.3.2 Rear View

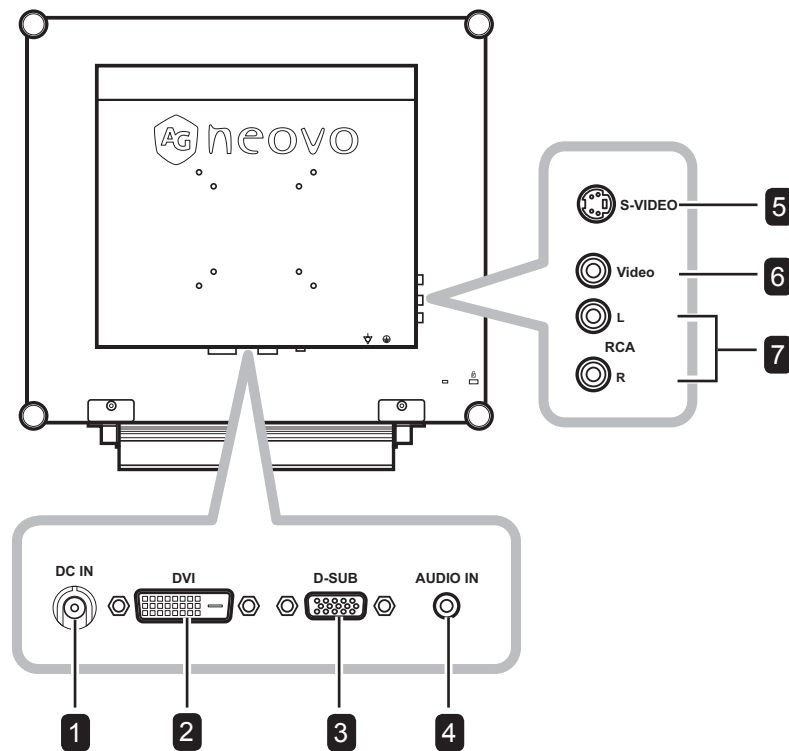

1 DC power input

Use to connect the power cord.

2 DVI connector

Use to connect a PC using DVI cable for digital input signal.

3 VGA connector

Use to connect a PC using a VGA cable for analogue input signal.

4 Audio port

Use to connect an audio cable for the PC's audio input.

5 S-Video connector

Use to connect AV cables for the S-Video signal.

6 COMPOSITE Video input connector

Use to connect a composite cable for CVBS input signal.

7 COMPOSITE Audio input connectors

Use to connect RCA cables for CVBS / S-Video audio signal.

CHAPTER 2: MAKING CONNECTIONS

2.1 Connecting the Power

- 1 Connect the power cord to the power adapter.
- 2 Connect the power adapter to the DC power input at the rear of the LCD display.
- 3 Connect the power cord plug to a power outlet or a power supply.

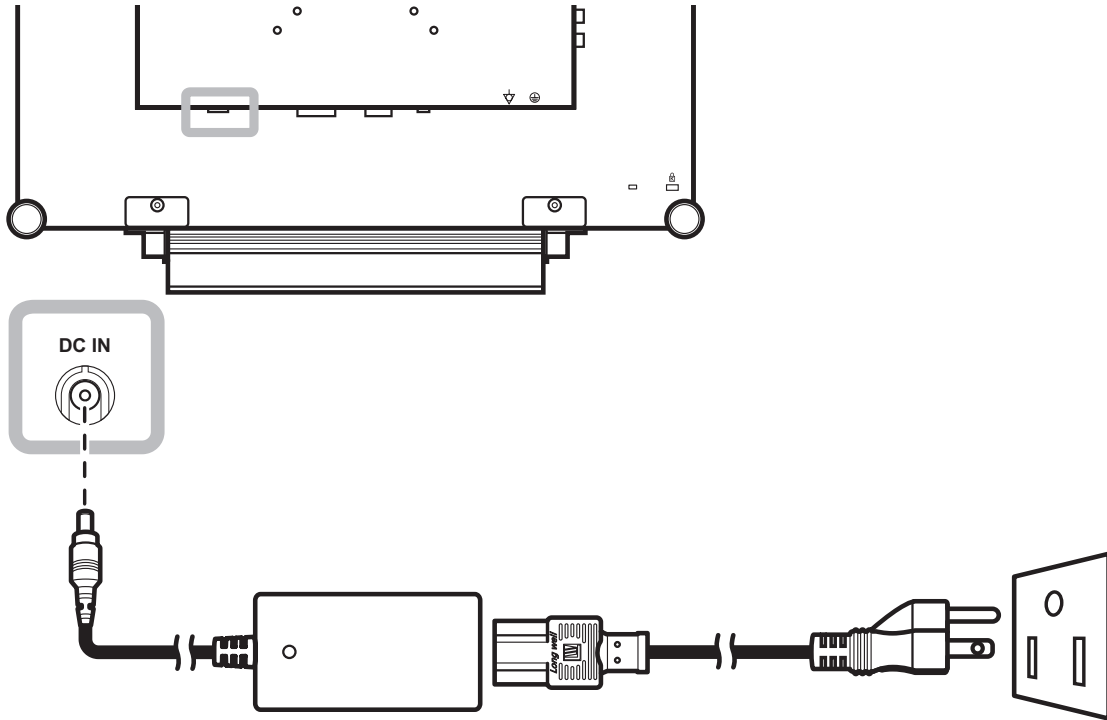

Caution:

- ◆ Make sure that the LCD display is not connected to the power outlet before making any connections. Connecting cables while the power is ON may cause electric shock or personal injury.



Caution:

- ◆ When unplugging the power cord, hold the power cord by the plug head. Never pull by the cord.

MAKING CONNECTIONS

2.2 Connecting Input Source Signals

2.2.1 Connecting a Computer

Using VGA Cables

Connect one end of a D-sub cable to the VGA connector of the LCD display and the other end to the D-sub connector of the computer.

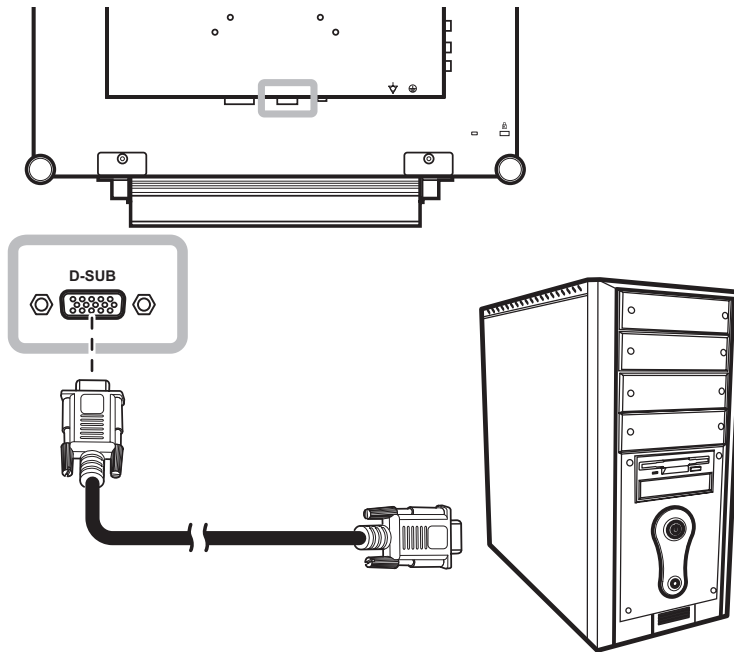

Using DVI Cables

Connect one end of a DVI cable to the DVI connector of the LCD display and the other end to the DVI connector of the computer.

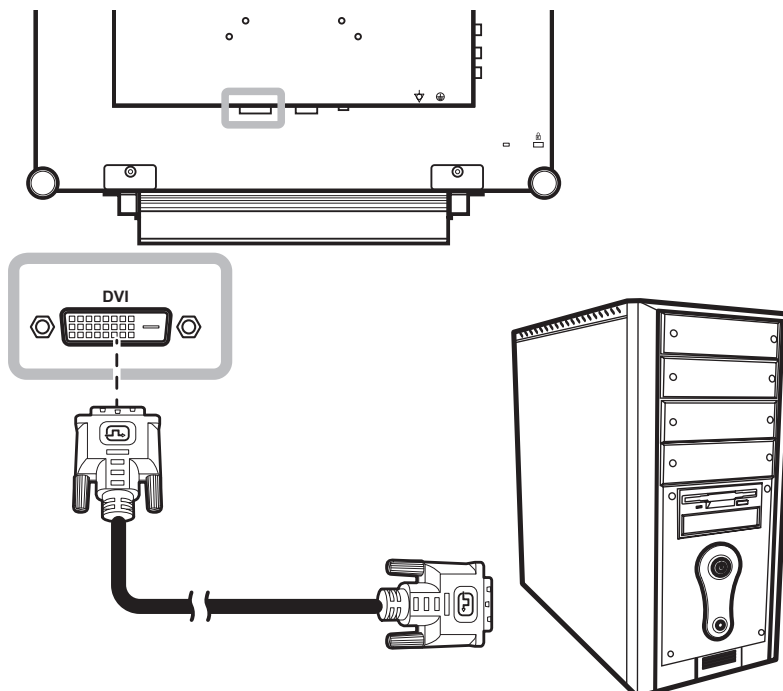

MAKING CONNECTIONS

Connecting an Audio Device

Connect one end of an audio cable to the audio port at the rear of the LCD display and the other end to the audio out port of the computer.

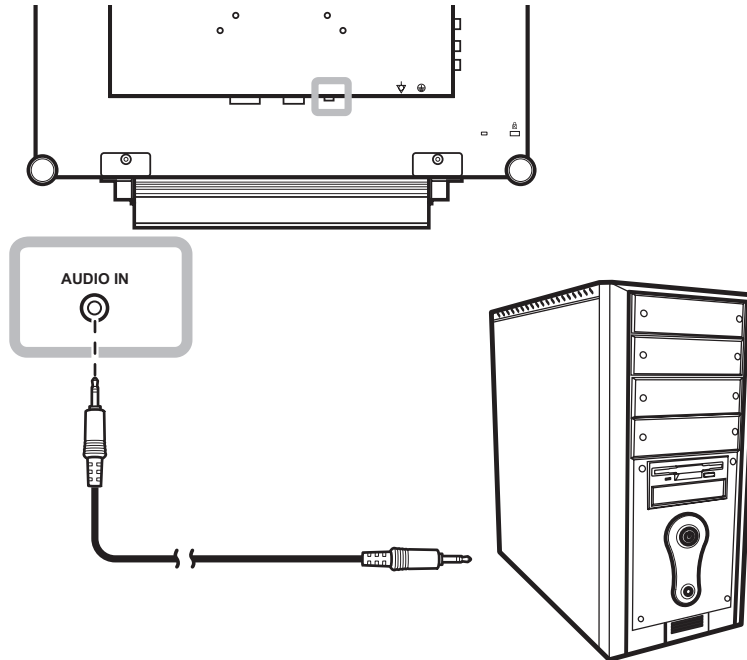

2.2.2 Connecting a Camera or Video Device

Using CVBS Cables

Connect one end of a CVBS cable to the COMPOSITE connector of the LCD display and the other end to the COMPOSITE connector of your device.

For audio input, connect the RCA cables to the audio in connectors of the LCD display and the audio out connectors of your device.

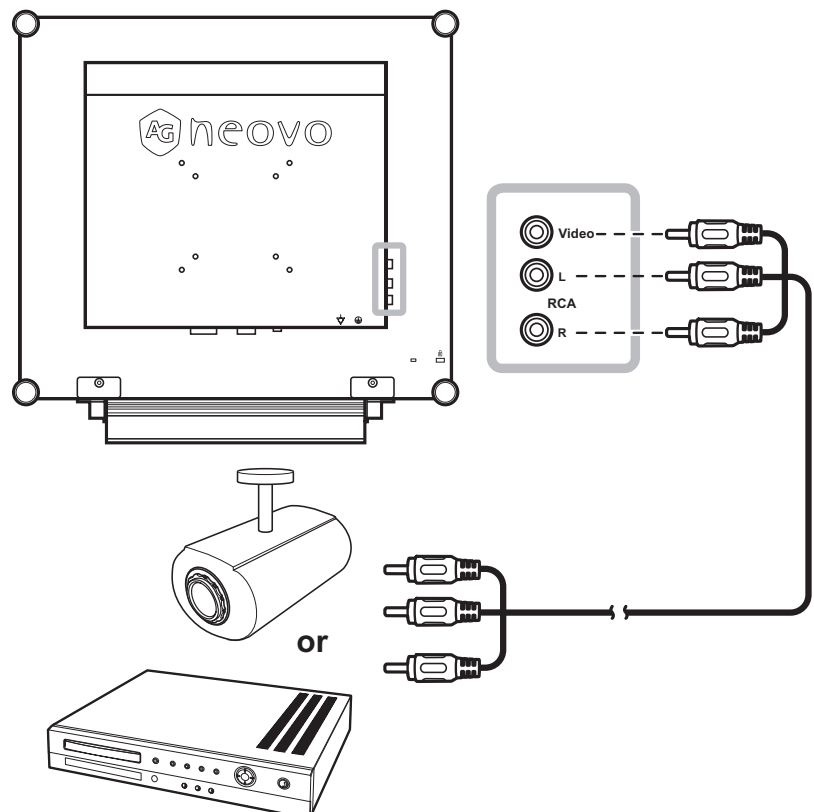

MAKING CONNECTIONS

Using S-Video Cables

Connect one end of an S-Video cable to the S-VIDEO connector of the LCD display and the other end to the S-VIDEO connector of your device.

For audio input, connect an RCA cable to the audio in connector of the LCD display and the audio out connector of your device.

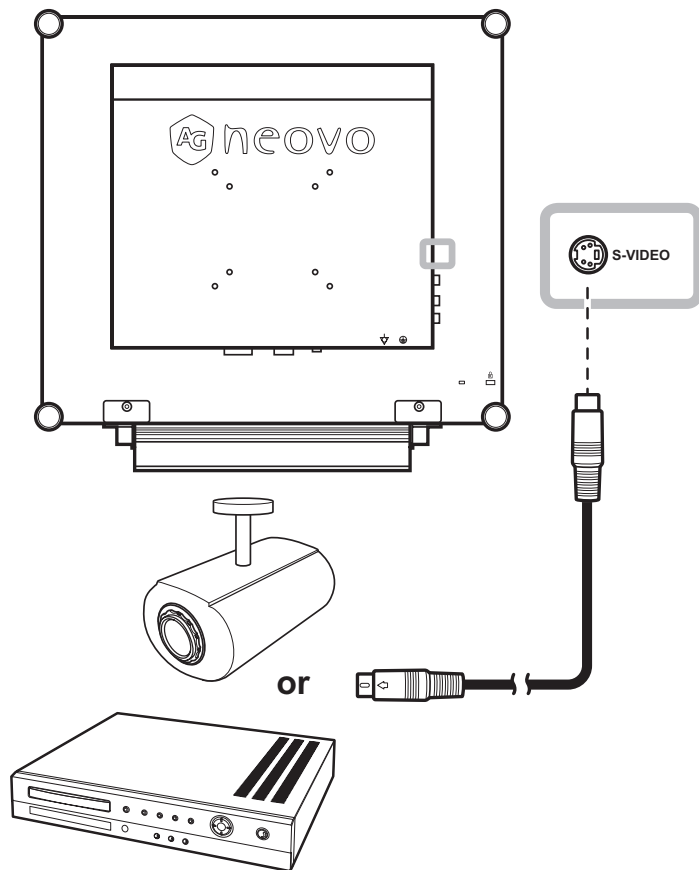

CHAPTER 3: USING THE LCD DISPLAY

3.1 Turning on the Power

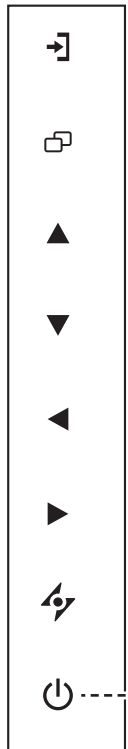

1 Plug the power cord to a power outlet or power supply.

2 Touch the **POWER** button to turn the LCD display on.
The LED indicator turns GREEN.

When the LCD display is turned on, touch the POWER button to turn off the LCD display.
The LED indicator turns off.

POWER button /
LED indicator

Note:

- ◆ The LCD display still consumes power as long as the power cord is connected to the power outlet. Disconnect the power cord to completely cut off power.

Notes:

- ◆ After selecting an input source signal, the input source signal message appears on the screen briefly.

For example, CVBS is selected the following message is displayed.



- ◆ If the selected input source signal is not connected to the LCD display or is turned off, the no signal message is displayed on the screen.



- ◆ If the resolution or the graphics card of the connected computer is set too high, the input out of range message is displayed.



3.2 Selecting the Input Source Signal

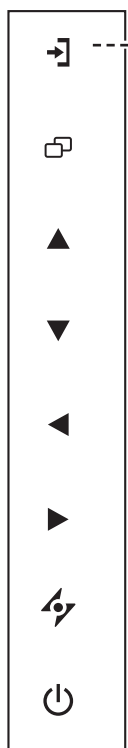

SOURCE button

1 Touch the **→** button to select the input source signal.

USING THE LCD DISPLAY

3.3 Adjusting the Volume

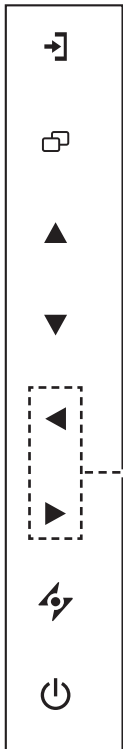

1 Touch either the ◀ or ▶ buttons to call out the volume bar.



2 Touch the ▶ button to increase volume.
Touch the ◀ button to decrease volume.
To mute the audio, set the volume to 0.

VOLUME buttons

3.4 Locking the OSD Menu

Lock the OSD menu to protect the LCD display from unauthorised users or from accidentally pressing the keypad.

To lock the OSD, press and hold the keypad buttons listed below for at least 5 seconds or until the



message appears.

When the OSD is locked, all keypad buttons are inactivated.

Type of OSD Lock	Lock Operation	Unlock Operation
Lock all buttons	Touch and hold the ▶, ▲, and the ▼ buttons for 5 seconds.	Touch and hold the ▶, ▲, and the ▼ buttons for 5 seconds or until the OSD menu appears.
Lock all buttons except the POWER button.	Touch and hold the ◀, ▲, and the ▼ buttons for 5 seconds.	Touch and hold the ◀, ▲, and the ▼ buttons for 5 seconds or until the OSD menu appears.

USING THE LCD DISPLAY

3.5 Using Picture-in-Picture (PIP)

The Picture-in-Picture (PIP) feature allows viewing of more than one input source signal on the LCD display.

3.5.1 PIP Options

Touch the ▲ button repeatedly to enable and scroll among the PIP options. Options are as follows:

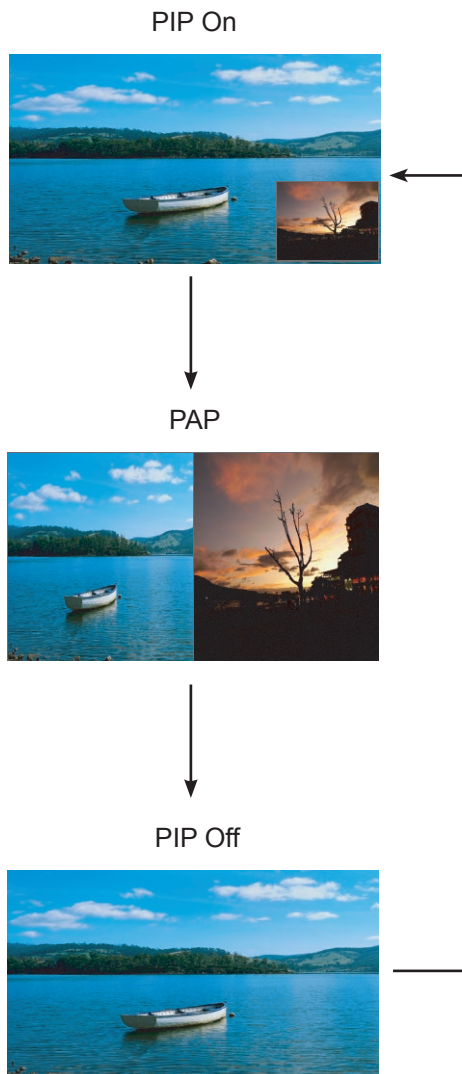

Info:

- ◆ PIP On: The sub source signal is displayed within the main source signal.
- ◆ PAP (Picture-and-Picture): The main source and the sub source signals are displayed side by side with equal display size.
- ◆ PIP Off: PIP function is disabled, only the main source signal is displayed.

Note:

- ◆ The main source and sub source signals can be set in PIP Settings, see page 33.

USING THE LCD DISPLAY

3.5.2 PIP Swap

The main and the sub source signals set in PIP Setting can be easily swapped using the keypad.

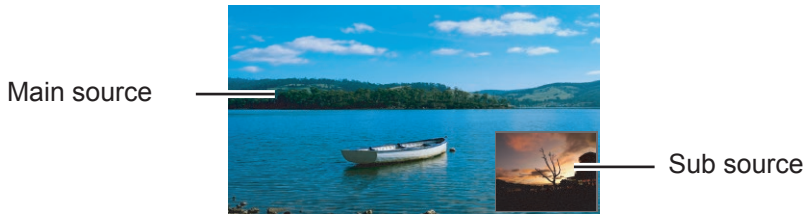

Touch the ▼ button to swap the main source and the sub source signals. See illustration below.

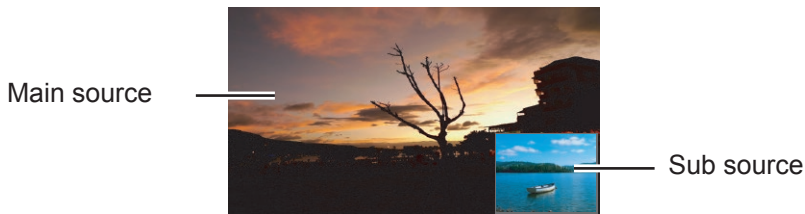

3.6 Using ROTATE Function

The ROTATE function allows you to rotate the screen image at 180°.



Touch the ▼ button to rotate the picture 180°. See illustration below.



After executing ROTATE, touch the ▼ button again to rotate the picture back to its normal state.

Note:

- ◆ PIP Swap can only be executed if PIP is enabled, see page 32.

Note:

- ◆ ROTATE function can only be executed if PIP is off, see page 32.

USING THE LCD DISPLAY

3.7 Using Auto Adjustment Function

Auto Adjustment function automatically tunes the LCD display to its optimal setting, including horizontal position, vertical position, clock, and phase.

Touch the  button to perform auto adjustment.

The message auto adjusting is displayed on the screen.



During auto adjustment, the screen will slightly shake for a few seconds.



When the message disappears, auto adjustment is completed.

Note:

- ◆ Auto Adjustment function is available only during VGA input signals.
- ◆ It is recommended to use the auto adjustment function when using the LCD display for the first time or after a resolution or frequency change.

CHAPTER 4: ON SCREEN DISPLAY MENU

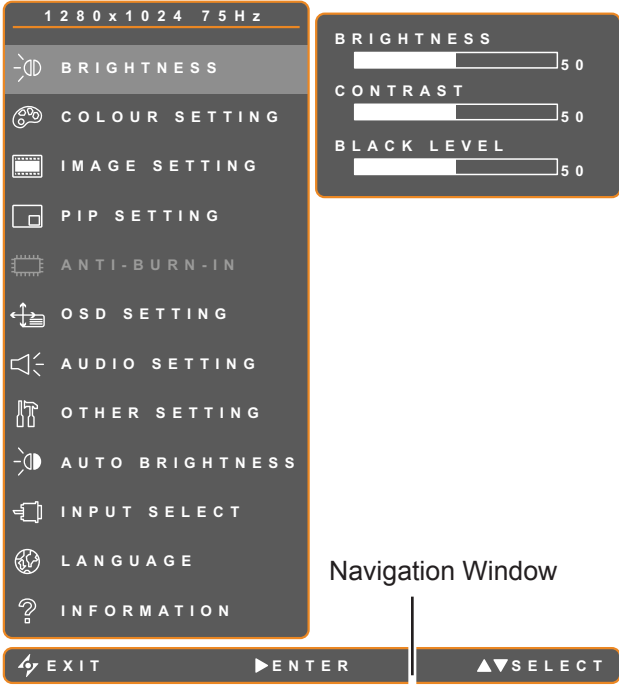
4.1 Using the OSD Menu

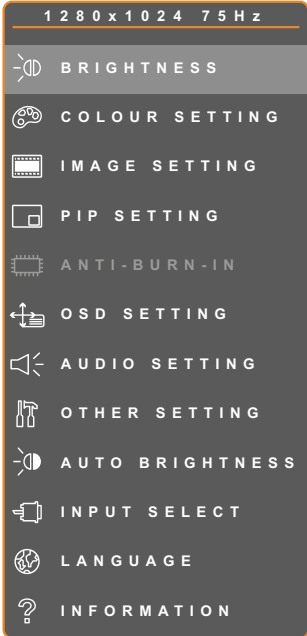
		Operation
1	<p>Display the main menu screen.</p> 	<p>Touch .</p>
2	<p>Select the menu.</p> 	<ol style="list-style-type: none">1 Touch the ▲ or ▼ buttons.2 Touch the ► button to enter the submenu.

ON SCREEN DISPLAY MENU

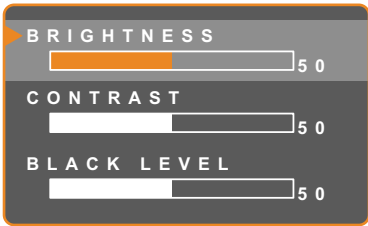
		Operation
<p>3 Select the submenu item.</p>  <p>The highlighted item with an orange arrow indicates the active submenu.</p>	<p>Touch the ▲ or ▼ buttons.</p>	
<p>4 Adjust the settings.</p>	<p>Touch the ◀ or ▶ buttons.</p>	
<p>5 Exit the submenu.</p>	<p>Touch ↶ or ↷ to return to the previous menu.</p>	
<p>6 Close the OSD window.</p>	<p>Touch ↶ or ↷ again.</p>	

When settings are modified, all changes are saved when the user does the following:

- Proceeds to the another menu.
- Exits the OSD menu.
- Waits for the OSD menu to disappear.

Note: Availability of some menu items depend on the input source signal. If the menu is not available, it is disabled and grayed out.

ON SCREEN DISPLAY MENU

4.2 OSD Menu Tree

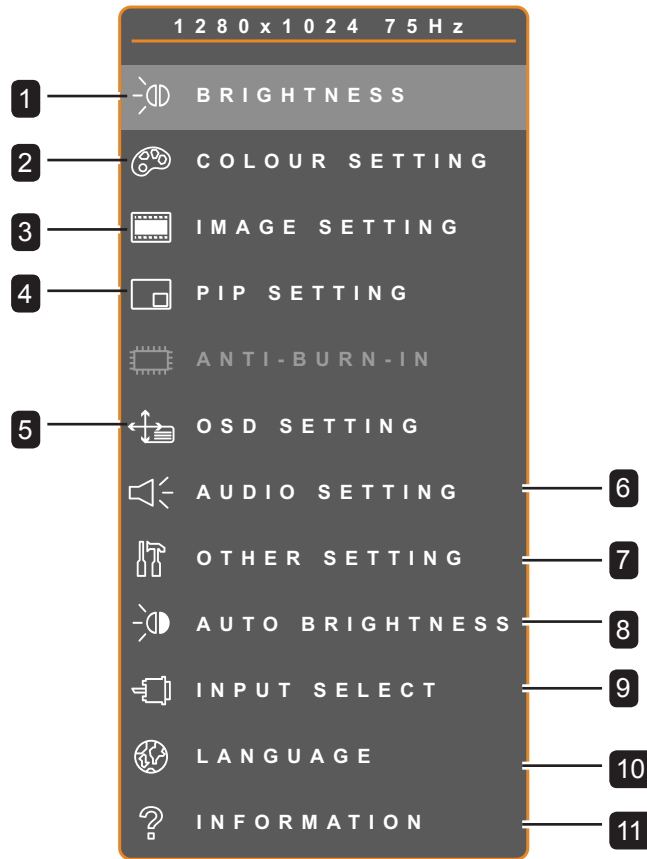

Main Menu	Submenu	Remarks
1. Brightness	<ul style="list-style-type: none"> Brightness Contrast Black Level (for video only) 	See page 27.
2. Colour Setting	<ul style="list-style-type: none"> Colour Temperature Auto Colour (for VGA only) 	See page 28.
3. Image Setting	During PC input signal (for VGA only): <ul style="list-style-type: none"> Sharpness Phase Clock H. Position V. Position 	See page 29.

ON SCREEN DISPLAY MENU

Main Menu	Submenu	Remarks
Image Setting	During Video input signal: <ul style="list-style-type: none"> • Sharpness • Saturation • Tint • 3D Comb Filter • Noise Reduction • Aspect Ratio • H. Zoom • V. Zoom • H. Position • V. Position 	See page 30.
4. PIP Setting	<ul style="list-style-type: none"> • PIP • Main Source • Sub Source • Sub Picture Size • Sub Pic. Pos. • Swap 	See page 32.
5. OSD Setting	<ul style="list-style-type: none"> • Transparency • H. Position • V. Position • OSD Timer 	See page 34.
6. Audio Setting	<ul style="list-style-type: none"> • Volume • Audio • DVI Source 	See page 35.
7. Other Setting	<ul style="list-style-type: none"> • Power Saving • Mode • DDC/CI • DCR • Recall 	See page 36.
8. Auto Brightness	<ul style="list-style-type: none"> • Enable • Mode • Level 	See page 38.
9. Input Select	<ul style="list-style-type: none"> • VGA • DVI • CVBS • S-Video 	See page 39.





ON SCREEN DISPLAY MENU

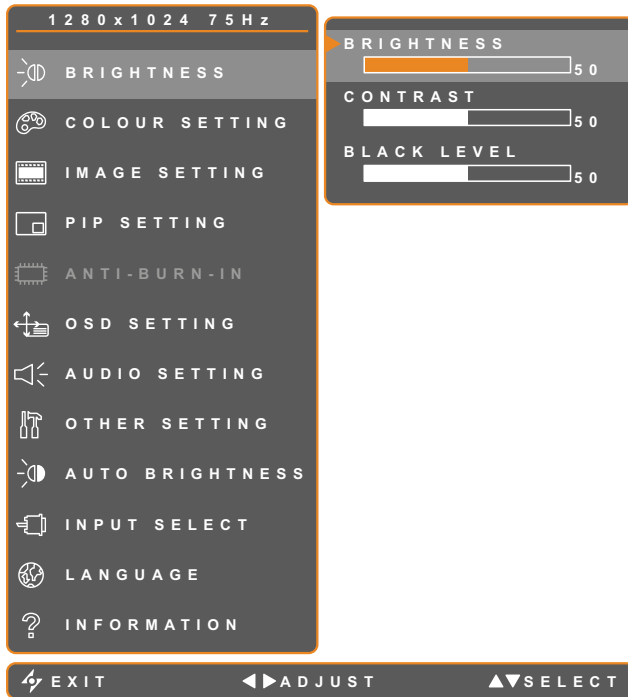

Main Menu	Submenu	Remarks
10. Language	Select the OSD language: EN / FR / DE / ES / IT / PY / RO / PL / CS / NL / TC / SC	
11. Information	Displays settings information such as Input, Resolution, Horizontal and Vertical Frequency, Time mode, and Firmware version.	

CHAPTER 5: ADJUSTING THE SETTINGS

5.1 Brightness Setting







1. Touch  to call out the OSD window.
2. Select BRIGHTNESS menu, then touch the  button.
3. Touch the  or  buttons to select an option.



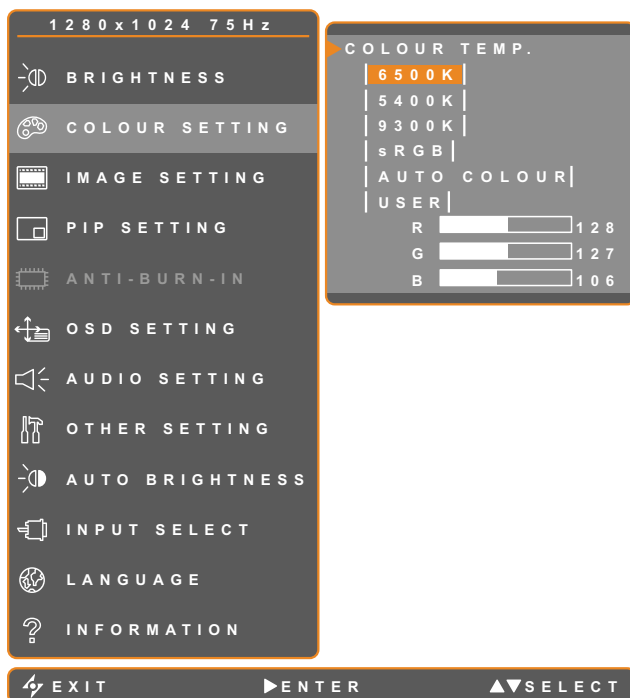





Item	Function	Operation	Range
Brightness	Adjusts the luminance of the screen image. Note: Brightness setting is disabled if Auto Brightness is On.		
Contrast	Adjusts the difference between the black level and the white level.	Touch the  or  buttons to adjust the value.	0 to 100
Black Level	Adjust the black level of the screen image. Low setting makes black colour darker (for video only).		

ADJUSTING THE SETTINGS

5.2 Colour Setting



1. Touch  to call out the OSD window.
2. Select COLOUR SETTING menu, then touch the  button.
3. Touch the  or  buttons to select an option.





Item	Function	Operation	Value
Colour Temperature	Provides several colour adjustment settings.	Touch the  or  buttons to select the setting.	6500K, 5400K, 9300K, sRGB, USER
	<p>Colour temperature can be set to:</p> <ul style="list-style-type: none"> • 6500K - This is the default colour temperature commonly used for normal lighting conditions. • 5400K - Applies a reddish tint for warmer colours. • 9300K - Applies a bluish tint for cooler colours. • sRGB - This is the Red, Green, Blue (RGB) colour standard which is used for colour management in most industries. This setting displays accurate colours and suitable for viewing images on the Internet. • AUTO COLOUR - Operates the white balance and automatically adjusts the colour settings. Available only during VGA input source signal <ol style="list-style-type: none"> 1 Select AUTO COLOUR. 2 Touch the  button to activate auto colour. • USER - This allows users to set the colour temperature by adjusting the R, G, B settings according to one's preference. <ol style="list-style-type: none"> 1 Select USER, then touch the  button 2 Touch the  or  buttons to select among R, G, B option. 3 Touch the  or  buttons to adjust the values between 0 ~ 255. <p>Note: Activate Recall to return the colour to its default setting.</p>		

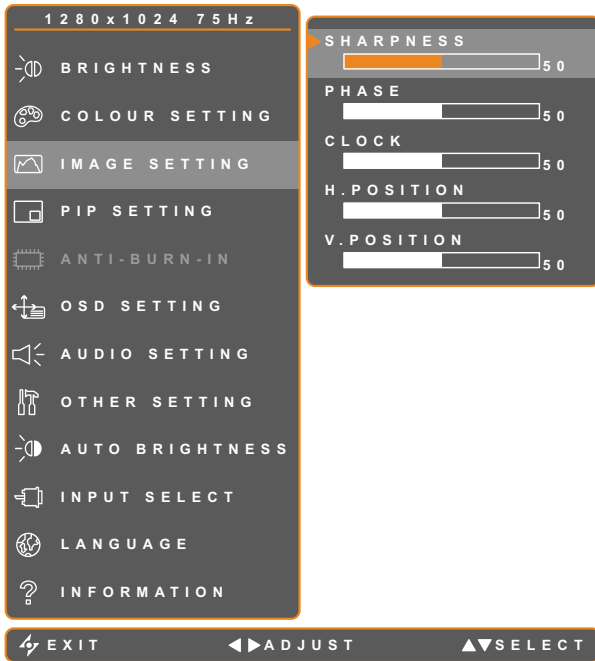

ADJUSTING THE SETTINGS

5.3 Image Setting (VGA only)

Note: During DVI input source signal, Image Setting is disabled and grayed out.







1. Touch  to call out the OSD window.
2. Select IMAGE SETTING menu, then touch the  button.
3. Touch the  or  buttons to select an option.

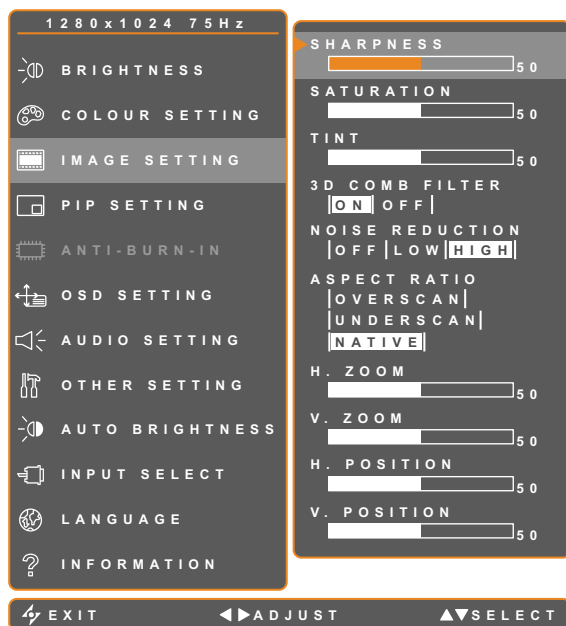

Item	Function	Operation	Range
Sharpness	Adjusts the clarity and focus of the screen image.	Touch the  or  buttons to adjust the value.	0 to 100
Phase	Adjusts the phase timing to synchronise with the video signal.		
Clock	Adjusts the frequency timing to synchronise with the video signal.		
H. Position (Horizontal Position)	Moves the screen image to the left or right.		
V. Position (Vertical Position)	Moves the screen image up or down.		

ADJUSTING THE SETTINGS

5.4 Image Setting (Video signals)



1. Touch  to call out the OSD window.
2. Select IMAGE SETTING menu, then touch the  button.
3. Touch the  or  buttons to select an option.

Item	Function	Operation	Range / Value
Sharpness	Adjusts the clarity and focus of the screen image.	Touch the  or  buttons to adjust or select the value.	
Saturation	Adjusts the colour saturation.		0 to 100
Tint	Adjusts the colour tint. Available only during NTSC system under S-Video or CVBS signals.		
3D Comb Filter	Enables the 3D Comb Filter function to provide the best possible image quality. Available only during CVBS signal.		On Off
Noise Reduction	Adjusts the noise reduction to help remove noise from images. This helps produce clearer and crisper images.		Off Low High





ADJUSTING THE SETTINGS



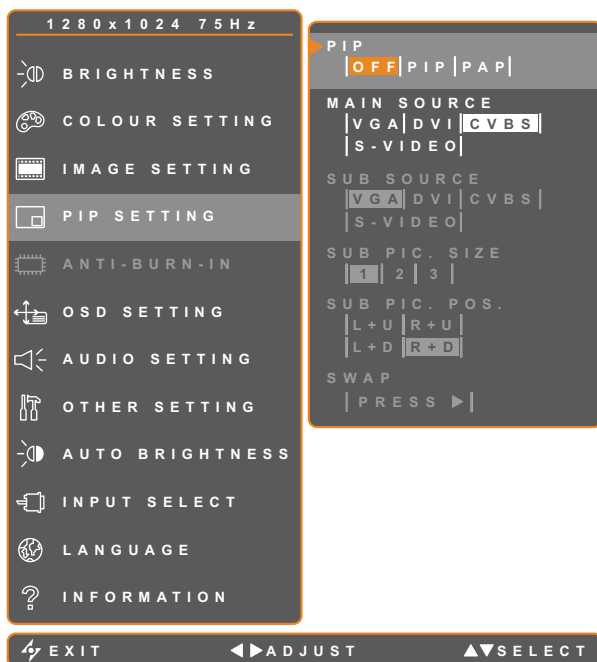



Item	Function	Operation	Range / Value
Aspect Ratio	Adjusts the aspect ratio of the screen image.	Touch the ◀ or ▶ buttons to select the value.	Overscan Underscan Native
	Aspect Ratio can be set to: <ul style="list-style-type: none"> • OVERSCAN - The aspect ratio increases by 5%. • UNDERSCAN - The aspect ratio decreases by 5%. • NATIVE - The aspect ratio returns to its default size. 		
H. Zoom (Horizontal Zoom)	Adjusts the horizontal zoom.	Touch the ◀ or ▶ buttons to adjust the value.	0 to 100
V. Zoom (Vertical Zoom)	Adjusts the vertical zoom.		
H. Position (Horizontal Position)	Moves the screen image to the left or right.		
V. Position (Vertical Position)	Moves the screen image up or down.		

ADJUSTING THE SETTINGS

5.5 PIP Setting



1. Touch  to call out the OSD window.
2. Select PIP SETTING menu, then touch the  button.
3. Touch the  or  buttons to select an option.

Item	Function	Operation	Range / Value
PIP	Allows you to select the PIP setting or disable PIP.	Touch the  or  buttons to select the value.	Off PIP PAP
	PIP can be set to: <ul style="list-style-type: none"> • Off - Disables PIP. • PIP - The sub source image is within the main source image. • PAP - The main source and sub source images are displayed side by side. 		
Main Source	Allows you to select the main source signal.	Touch the  or  buttons to select the value.	VGA / DVI / CVBS / S-VIDEO
Sub Source	Allows you to select the sub source signal.	Touch the  or  buttons to select the value.	VGA / DVI / CVBS / S-VIDEO

ADJUSTING THE SETTINGS

Note: Any input signal may be set as the main or the sub source signal. However, some input signals are not supported to be paired together as the main and the sub source signals.

Refer to the following table for compatibility options:





Main / Sub	VGA	DVI	CVBS	S-VIDEO
VGA	not supported	not supported	Y	Y
DVI	not supported	not supported	Y	Y
CVBS	Y	Y	not supported	not supported
S-VIDEO	Y	Y	not supported	not supported

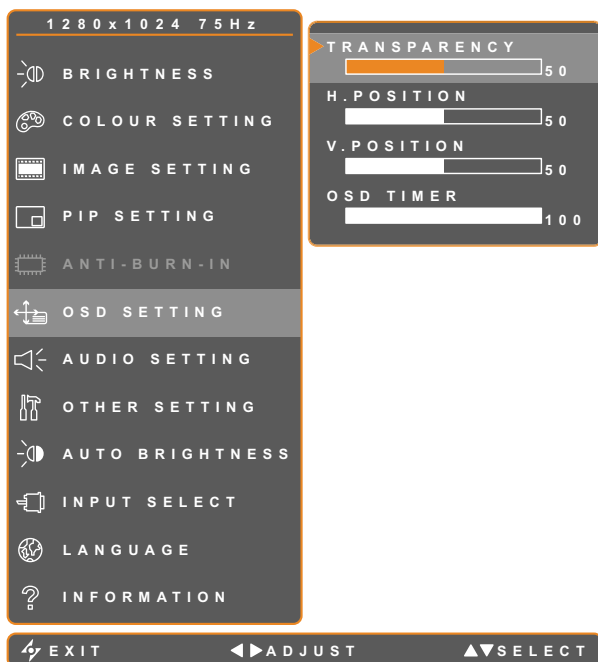

Item	Function	Operation	Range / Value
Sub Pic. Size (Sub Picture Size)	<p>Allows you to select the size of the sub source image. Available only in PIP mode.</p> <ul style="list-style-type: none"> • 1 - Small image size. • 2 - Medium image size. • 3 - Large image size. 	Touch the ◀ or ▶ buttons to select the value.	1 2 3
Sub Pic. Pos. (Sub Picture Position)	<p>Allows you to select the position of the sub source image. Available only in PIP mode.</p> <ul style="list-style-type: none"> • L+U - Sets the image on the upper left corner of the screen. • R+U - Sets the image on the upper right corner of the screen. • L+D - Sets the image on the lower left corner of the screen. • R+D - Sets the image on the lower right corner of the screen. 	Touch the ◀ or ▶ buttons to adjust the value.	L+U R+U L+D R+D
Swap	Swaps the main source and sub source signals.	Touch the ▶ button to swap the image sources.	

ADJUSTING THE SETTINGS

5.6 OSD Setting







1. Touch  to call out the OSD window.
2. Select OSD SETTING menu, then touch the  button.
3. Touch the  or  buttons to select an option.



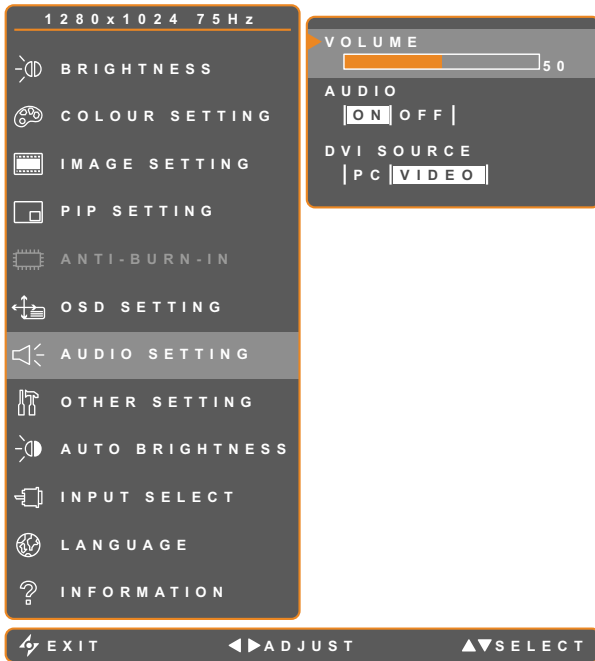



Item	Function	Operation	Range
Transparency	Adjusts the transparency level of the OSD screen.		
H. Position (Horizontal Position)	Moves the OSD window to the left or right of the screen.	Touch the  or  buttons to adjust the value.	0 to 100
V. Position (Vertical Position)	Moves the OSD window up or down the screen.		
OSD Timer	Sets the length of time (in seconds) the OSD screen is displayed. When the time elapses, the OSD screen is automatically inactivated.		5 to 100

ADJUSTING THE SETTINGS

5.7 Audio Setting







1. Touch  to call out the OSD window.
2. Select AUDIO SETTING menu, then touch the  button.
3. Touch the  or  buttons to select an option.



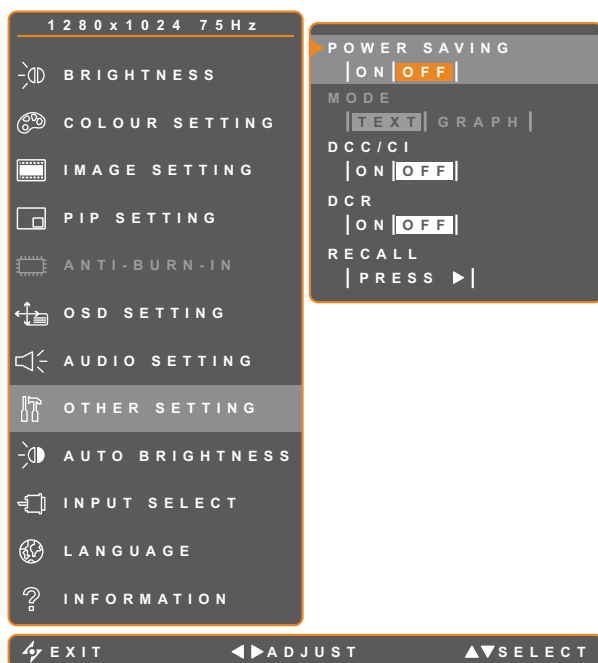



Item	Function	Operation	Range / Value
Volume	Adjusts the volume level of the built-in speaker.	Touch the  or  buttons to adjust the value.	0 to 100
Audio	Turns the audio speaker ON or OFF. Note: Even when Audio is set to "Off", Audio is automatically turned on when volume is adjusted.	Touch the  or  buttons to select the value.	On Off
DVI Source	Available only during DVI input signal.	Touch the  or  buttons to select the value.	PC VIDEO
	Select the type of DVI source: <ul style="list-style-type: none"> • PC - Select this option when a computer is connected to the DVI connector (audio connection is required). • VIDEO - Select this option when a video player, such as a DVD or HD player, is connected to the DVI connector via an HDMI to DVI converter. 		

ADJUSTING THE SETTINGS

5.8 Other Setting



1. Touch  to call out the OSD window.
2. Select OTHER SETTING menu, then touch the  button.
3. Touch the  or  buttons to select an option.

Item	Function	Operation	Range / Value
Power Saving	Enables or disables power saving mode. When the LCD display turns into power saving mode, the screen turns black and the LED indicator lights AMBER.	Touch the  or  buttons to select the value.	On Off
Mode	Sets the current mode for better image display. Available only during computer input signal, when the resolution is either of the following: 640 x 350, 640 x 400, 720 x 350, or 720 x 400. For optimal performance, select: <ul style="list-style-type: none"> • Text - This mode is suitable for viewing text documents when the resolution is 720 x 400 or 720 x 350. • Graphic - Graphics mode is suitable for viewing images when the resolution is 640 x 350 or 640 x 400. 	Touch the  or  buttons to select the value.	Text Graphic
DDC/CI	Activates the DDC/CI protocol to allow users to configure the monitor by a software using two wires on the VGA or DVI cables.	Touch the  or  buttons to select the value.	On Off

ADJUSTING THE SETTINGS

Item	Function	Operation	Range / Value
DCR (Dynamic Contrast Ratio)	Activates DCR. This feature provides automatic adjustment of picture brightness and contrast at high speed and dynamic contrast range, such as when watching movies. DCR is suitable for indoor viewing.	Touch the ◀ or ▶ buttons to select the value.	On Off
Recall	Use to recall all to default settings, except Language, PIP, and the input source.	Touch the ▶ button.	-





ADJUSTING THE SETTINGS







5.9 Auto Brightness

5.9.1 EcoSmart Sensor

With the built-in EcoSmart sensor, users can enable the Auto Brightness feature to automatically adjust the LCD screen brightness according to the ambient light. This feature comforts the eyes and helps optimise energy efficiency.







1. Touch  to call out the OSD window.
2. Select AUTO BRIGHTNESS menu, then touch the  button.
3. Touch the  or  buttons to select an option.

Item	Function	Operation	Value
Enable	Enables or disables auto brightness.	Touch the  or  buttons to select the value.	On Off
Mode	Sets the auto brightness mode.	Touch the  or  buttons to select the value.	Auto User
	The mode can be set to: <ul style="list-style-type: none"> • Auto - This mode is the default mode. The LCD brightness automatically adjusts to the ambient brightness. • User - Allows you to manually adjust the LCD brightness. 		
Level	Allows you to set the level of LCD brightness. Available only in USER mode.	Touch the  or  buttons to adjust the value.	0 to 100

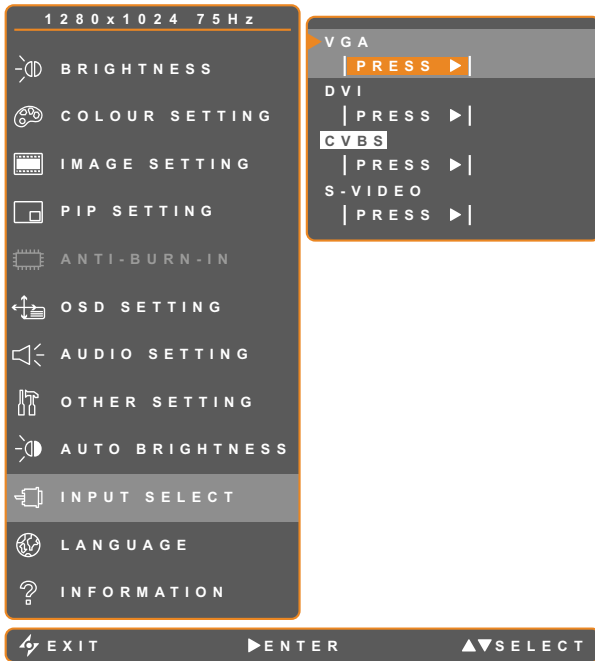
ADJUSTING THE SETTINGS

5.10 Input Select





1. Touch  to call out the OSD window.
2. Select INPUT SELECT menu, then touch the  button.
3. Touch the  or  buttons to select an option.

Item	Function	Operation	Value
VGA	Sets VGA as the input source signal.	Touch the  button to select.	-
DVI	Sets DVI as the input source signal.		
CVBS	Sets CVBS1 as the input source signal.		
S-VIDEO	Sets S-Video as the input source signal.		

CHAPTER 6: APPENDIX

6.1 Warning Messages

Warning Messages	Cause	Solution
	The resolution or the refresh rate of the graphics card of the computer is set too high.	<ul style="list-style-type: none">• Change the resolution or the refresh rate of the graphics card.
	The LCD display cannot detect the input source signal.	<ul style="list-style-type: none">• Check if the input source is turned ON.• Check if the signal cable is properly connected.• Check if any pin inside the cable connector is twisted or broken.
	The OSD has been locked by the user.	<ul style="list-style-type: none">• Unlock the OSD. Refer to page 18.

APPENDIX

6.2 Troubleshooting

Problem	Possible Cause and Solution
No picture. <ul style="list-style-type: none"> LED indicator is OFF. 	<ul style="list-style-type: none"> Check if the LCD display is turned ON. Check if the power cord is properly connected to the LCD display. Check if the power cord is plugged into the power outlet.
<ul style="list-style-type: none"> LED indicator is AMBER. 	<ul style="list-style-type: none"> Check if the computer is turned ON. Check if the computer is in standby mode, move the mouse or press any key to wake up the computer.
Image position is incorrect.	<ul style="list-style-type: none"> Adjust the H. POSITION and V. POSITION values. See IMAGE SETTING on page 29 (for VGA source) or page 30 (for video signals).
The displayed texts are blurry.	<ul style="list-style-type: none"> For VGA input, touch  on the keypad to auto-adjust the display. Adjust the IMAGE SETTING (see page 29).
The OSD menu can't be called out.	<ul style="list-style-type: none"> The OSD is locked; unlock the OSD (see page 18).
Red, blue, green, white dots appear on screen.	<ul style="list-style-type: none"> There are millions of micro transistors inside the LCD display. It is normal for a few transistors to be damaged and to produce spots. This is acceptable and is not considered a failure.
No audio output.	<ul style="list-style-type: none"> Check if the volume is set to 0 (see page 18 or 35). Check if AUDIO is set to OFF (see page 35). For VGA or DVI input, check the audio setting of the computer.
Dew formed on or inside the LCD display.	<ul style="list-style-type: none"> This normally happens when the LCD display is moved a cold room to a hot room temperature. Do not turn ON the LCD display, wait for the dew condensation to disappear.
Mist formed inside the glass surface.	<ul style="list-style-type: none"> This happens due to humid weather conditions. This is a normal occurrence. The mist will disappear after a few days or as soon as the weather stabilizes.
Faint shadows from a static image appear on the screen.	<ul style="list-style-type: none"> Turn off the LCD display for extended periods of time. Use a screen saver or a black and white image and run it for extended periods of time.

APPENDIX

6.3 Transporting the LCD Display

To transport the LCD display for repair or shipment, place the display in its original packaging carton.

- 1 Place the two foam cushions on each side of the LCD display for protection.**
- 2 Place the LCD display down in the box.**
- 3 Place the accessories in the designated area (if necessary).**
- 4 Put all other contents on the designated area (if necessary).**
- 5 Close and tape the box.**

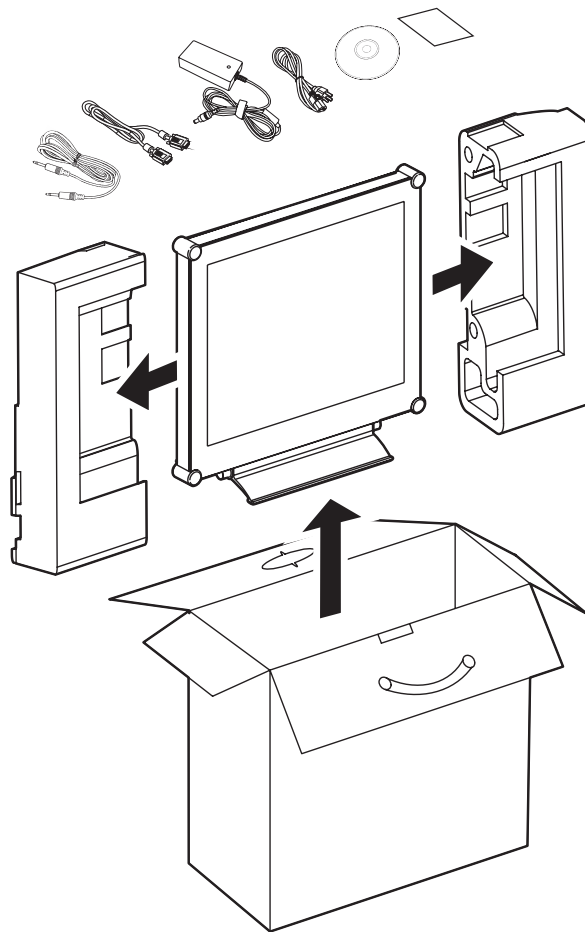

CHAPTER 7: SPECIFICATIONS

7.1 Display Specifications

X-15P		
Panel	Panel Size	15"
	Max. Resolution	XGA 1024 x 768
Frequency (H/V)		H: 24 kHz - 81 kHz V: 50 Hz - 75 Hz @ 1024 x 768 / 75Hz
Power	Power Type	External DC 12V
	Consumption	Active mode \leq 17W Power saving \leq 0.5W Power off mode \leq 0.5W
Video Input	VGA	15-Pin Mini D-Sub
	DVI-D	24-Pin DVI-D
	CVBS	RCA
	S-Video	4-Pin mini DIN
Audio	Audio In	1 x stereo audio in for PC (audio jack, 3.5 Ø)
		1 x stereo audio in for CVBS or S-Video (RCA)
	Speaker	1.5W x 2
Operating Conditions	Temperature	0 °C ~ 40 °C (32 °F ~ 104 °F)
	Humidity	10% ~ 90% (Non-condensing)
Storage Conditions	Temperature	-20 °C ~ 60 °C (-4 °F ~ 140 °F)
	Humidity	5% ~ 95%
Weight	Without Base	4.3 kg (9.5 lbs)
	With Base	4.7 kg (10.4 lbs)

Note: All specifications are subject to change without prior notice.

SPECIFICATIONS

7.2 Display Dimensions

7.2.1 X-15P Dimensions

