

## OWNER'S MANUAL

# Safety and Reference

LED TV\*

\* LG LED TVs are LCD TVs with LED backlighting.

Please read this manual carefully before operating your TV and retain it for future reference.

43UH610A	49UH610A	43UH6100	43UH6500	43UH7500	49UH7700	65UH9500
43UH6030	55UH615A	49UH6100	49UH6500	49UH7500	55UH7700	86UH9500
49UH6030	60UH615A	49UH6090	55UH6550	55UH7500	60UH7700	
55UH6030	65UH615A	55UH6090	60UH6550	60UH7500	65UH7700	
60UH6030	55UH6150	60UH6090	65UH6550	65UH7500	55UH8500	
65UH6030	60UH6150	50UH6300	75UH6550	55UH7650	60UH8500	
70UH6330	65UH6150	58UH6300	60UH6035	60UH7650	65UH8500	
		70UH6350		65UH7650	75UH8500	



\* M F L 6 9 2 7 2 4 0 2 \*

[www.lg.com](http://www.lg.com)

P/No : MFL69272402 (1607-REV07)

# Important Safety Instructions

Always comply with the following precautions to avoid dangerous situations and ensure peak performance of your product.



TO REDUCE THE RISK OF ELECTRIC SHOCK DO NOT REMOVE COVER (OR BACK). NO USER SERVICEABLE PARTS INSIDE. REFER TO QUALIFIED SERVICE PERSONNEL.

 The lightning flash with arrowhead symbol, within an equilateral triangle, is intended to alert the user to the presence of uninsulated dangerous voltage within the product's enclosure that may be of sufficient magnitude to constitute a risk of electric shock to persons.

 The exclamation point within an equilateral triangle is intended to alert the user to the presence of important operating and maintenance (servicing) instructions in the literature accompanying the device.

## WARNING/CAUTION

- TO REDUCE THE RISK OF FIRE AND ELECTRIC SHOCK, DO NOT EXPOSE THIS PRODUCT TO RAIN OR MOISTURE.

## WARNING

If you ignore the warning message, you may be seriously injured or there is a possibility of accident or death.

## CAUTION

If you ignore the caution message, you may be slightly injured or the product may be damaged.

## NOTE

The note helps you understand and use the product safely. Please read the note carefully before using the product.

**WARNING:** This product contains chemicals known to the State of California to cause cancer and birth defects or other reproductive harm. ***Wash hands after handling.***

Read these instructions.  
Keep these instructions.  
Heed all warnings.  
Follow all instructions.



- Do not use this apparatus near water.



- Clean only with dry cloth.



- Do not block any ventilation openings. Install in accordance with the manufacturer's instructions.



- Do not install near any heat sources such as radiators, heat registers, stoves, or other apparatus (including amplifiers) that produce heat.



- Do not defeat the safety purpose of the polarized or grounding-type plug. A polarized plug has two blades with one wider than the other. A grounding type plug has two blades and a third grounding prong. The wide blade or the third prong are provided for your safety. If the provided plug does not fit into your outlet, consult an electrician for replacement of the obsolete outlet.



- Protect the power cord from being walked on or pinched particularly at plugs, convenience receptacles, and the point where they exit from the apparatus.



- Only use attachments/accessories specified by the manufacturer.



- Use only with the cart, stand, tripod, bracket, or table specified by the manufacturer, or sold with

the apparatus. When a cart is used, use caution when moving the cart/apparatus combination to avoid injury from tip-over.



- Unplug this apparatus during lightning storms or when unused for long periods of time.



- Refer all servicing to qualified service personnel. Servicing is required when the apparatus has been damaged in any way, such as power-supply cord or plug is damaged, liquid has been spilled or objects have fallen into the apparatus, the apparatus has been exposed to rain or moisture, does not operate normally, or has been dropped.



- Do not press strongly upon the panel with a hand or a sharp object such as a nail, pencil, or pen, or make a scratch on it.



- Do not stick metal objects or any other conductive material into the power cord. Do not touch the end of the power cord while it is plugged in.
- Keep the packing anti-moisture material or vinyl packing out of the reach of children. Anti-moisture material is harmful if swallowed. If swallowed, induce vomiting and go to the nearest hospital. Additionally, vinyl packing can cause suffocation. Keep it out of the reach of children.

- CAUTION concerning the Power Cord (Can differ by country): Check the specification page of this owner's manual to be certain concerning current requirements. Do not connect too many devices to the same AC power outlet as this could result in fire or electric shock. Do not overload wall outlets. Overloaded wall outlets, loose or damaged wall outlets, extension cords, frayed power cords, or damaged or cracked wire insulation are dangerous. Any of these conditions could result in electric shock or fire. Periodically examine the cord of your device, and if its appearance indicates damage or deterioration, unplug it, discontinue use of the device, and have the cord replaced with an exact replacement part by an authorized servicer. Protect the power cord from physical or mechanical abuse, such as being twisted, kinked, pinched, closed in a door, or walked upon. Pay particular attention to plugs, wall outlets, and the point where the cord exits the device. Do not move the TV with the power cord plugged in. Do not use a damaged or loose power cord. Be sure do grasp the plug when unplugging the power cord. Do not pull on the power cord to unplug the TV.



- **Warning** - To reduce the risk of fire or electrical shock, do not expose this product to rain, moisture or other liquids. Do not touch the TV with wet hands. Do not install this product near flammable objects such as gasoline or candles, or expose the TV to direct air conditioning.



- Do not expose to dripping or splashing and do not place objects filled with liquids, such as vases, cups, etc. on or over the apparatus (e.g., on shelves above the unit).



## • Grounding

- (Except for devices which are not grounded.) Ensure that you connect the earth ground wire to prevent possible electric shock (i.e., a TV with a three-prong grounded AC plug must be connected to a three-prong grounded AC outlet).

If grounding methods are not possible, have a qualified electrician install a separate circuit breaker. Do not try to ground the unit by connecting it to telephone wires, lightning rods, or gas pipes.

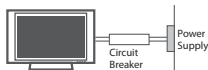

- As long as this unit is connected to the AC wall outlet, it is not disconnected from the AC power source even if the unit is turned off.

- Do not attempt to modify this product in any way without written authorization from LG Electronics. Unauthorized modification could void the user's authority to operate this product.

## • Outdoor Antenna Grounding

- (Can differ by country):

If an outdoor antenna is installed, follow the precautions below. An outdoor antenna system should not be located in the vicinity of overhead power lines or other electric light or power circuits, or where it can come in contact with such power lines or circuits as death or serious injury can occur. Be sure the antenna system is grounded to provide some protection against voltage surges and built-up static charges. Section 810 of the National Electrical Code (NEC) in the U.S.A. provides information with respect to proper grounding of the mast and supporting structure, grounding of the lead-in wire to an antenna discharge unit, size of grounding conductors, location of antenna discharge unit, connection to grounding electrodes, and requirements for the grounding electrode.

## Antenna grounding according to the National Electrical Code, ANSI/NFPA 70

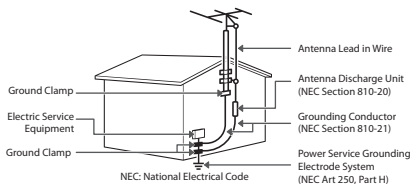

## • Cleaning

- When cleaning, unplug the power cord and wipe gently with a soft cloth to prevent scratching. Do not spray water or other liquids directly on the TV as electric shock may occur. Do not clean with chemicals such as alcohol, thinners, or benzene.

## • Moving

- Make sure the product is turned off, unplugged, and all cables have been removed. It may take 2 or more people to carry larger TVs. Do not press or put stress on the front panel of the TV.

## • Ventilation

- Install your TV where there is proper ventilation. Do not install in a confined space such as a bookcase. Do not cover the product with cloth or other materials while plugged in. Do not install in excessively dusty places.

- If you smell smoke or other odors coming from the TV, unplug the power cord and contact an authorized service center.

- Keep the product away from direct sunlight.

- Never touch this apparatus or antenna during a lightning storm.

- When mounting a TV on the wall, make sure not to install the TV by hanging the power and signal cables on the back of the TV.

- Do not allow an impact shock or any objects to fall into the product, and do not drop anything onto the screen.

## • DISCONNECTING THE DEVICE FROM THE MAIN POWER

The power plug is the disconnecting device.

In case of an emergency, the power plug must remain readily accessible.

- Make sure the power cord is connected securely to the power plug on the TV.

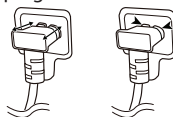

## • Batteries

- Store the accessories (battery, etc.) in a safe location out of the reach of children.

- This apparatus uses batteries. In your community there might be regulations that require you to dispose of these batteries properly due to environmental considerations. Please contact your local authorities for disposal or recycling information.

- Do not dispose of batteries in a fire.

- Do not short circuit, disassemble, or allow the batteries to overheat.

- Do not use high voltage electrical equipment near the TV, (e.g., a bug zapper). This may result in product malfunction.
- **Dot Defect**
  - This panel is an advanced product that contains millions of pixels. In a very few cases, you could see fine dots on the screen while you're viewing the TV. Those dots are deactivated pixels and do not affect the performance and reliability of the TV.
- **Generated Sound**
  - **Cracking noise** A cracking noise that occurs when watching or turning off the TV is generated by plastic thermal contraction due to temperature and humidity. This noise is common for products where thermal deformation is required.
  - **Electrical circuit humming/panel buzzing** A low level noise is generated from a high-speed switching circuit, which supplies a large amount of current to operate a product. It varies depending upon the product. This generated sound does not affect the performance and reliability of the product.
- Take care not to touch the ventilation openings. When watching the TV for a long period, the ventilation openings may become hot. This does not affect the performance of the product or cause defects in the product.
- Do not install this product on a wall if it could be exposed to oil or oil mist. This may damage the product and cause it to fall.
- If the TV feels cold to the touch, there may be a small flicker when it is turned on. This is normal; there is nothing wrong with TV. Some minute dot defects may be visible on the screen, appearing as tiny red, green, or blue spots. However, they have no adverse effect on the TV's performance. Avoid touching the LCD screen or holding your finger(s) against it for long periods of time. Doing so may produce some temporary distortion effects on the screen.
- Displaying a still image for a prolonged time may cause image sticking. Avoid displaying a fixed image on the TV screen for a long period of time.

## Viewing 3D Imaging

(For 3D models)

### CAUTION

- Guardians should not leave children unsupervised who are watching a 3D video. Guardians should make children stop watching the video and take a rest if they experience eye fatigue, headache, or dizziness.
- When viewing a 3D video, some may experience discomfort such as a headache, dizziness, fatigue, or blurred vision. In this case, stop watching the 3D video and take a rest.
- If you watch a 3D video for a long time, you may experience eye fatigue. In this case, stop watching the 3D video and take a rest.
- Only use LG 3D glasses. Otherwise, you may not be able to view 3D videos properly.
- Do not use 3D glasses instead of your normal glasses, sunglasses, or protective goggles. Place the 3D glasses over your normal eye ware.
- Do not keep your 3D glasses in extremely high or low temperatures. It will cause deformation.
- Do not use the 3D glasses while walking or moving around. It may cause an accident or injury.
- Be careful not to poke your eye with the frames of the 3D glasses.
- Do not watch 3D content if you have photosensitive seizures, epilepsy, or heart disease.

# Preparing

## ! NOTE

- When the TV is turned on for the first time after being shipped from the factory, initialization of the TV may take approximately one minute.
- Image shown may differ from your TV.
- Your TV's OSD (On Screen Display) may differ slightly from that shown in this manual.
- The available menus and options may differ from the input source or product model that you are using.
- New features may be added to this TV in the future.
- The items supplied with your product may vary depending upon the model.
- Product specifications or contents of this manual may be changed without prior notice due to upgrade of product functions.
- For an optimal connection, HDMI cables and USB devices should have bezels less than 10 mm (0.39 inches) thick and 18 mm (0.7 inches) width.
- Use an extension cable that supports USB 2.0 if the USB cable or USB flash drive does not fit into your TV's USB port.
- Use a certified cable with the HDMI logo attached. If you do not use a certified HDMI cable, the screen may not display or a connection error may occur.
- Recommended HDMI cable types (3 m or less)
  - High-Speed HDMI<sup>®</sup>/TM cable
  - High-Speed HDMI<sup>®</sup>/TM cable with Ethernet

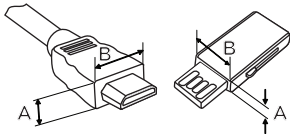

\*A ≤ 10 mm (0.39 inches)

\*B ≤ 18 mm (0.7 inches)

- How to use the ferrite core (Depending upon model)
  - Use the ferrite core to reduce the electromagnetic interference in the power cable. Wind the power cable on the ferrite core once.

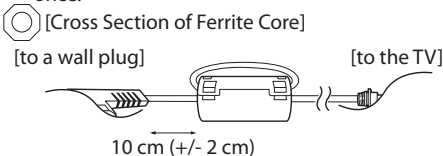

- Antenna Isolator Installation Guide (Depending upon model)
  - Use this to install TV in a place where there is a voltage difference between TV Set and GND of antenna signal. If there is a voltage difference between TV Set and GND of antenna signal, the antenna contact might be heated and excessive heat might cause an accident.
  - You can improve the safety when watching TV by efficiently removing power voltage from TV antenna. It is recommended to mount the isolator to the wall. If it cannot be mounted to the wall, mount it on the TV. Avoid disconnecting the antenna Isolator after installation.
  - Before starting, be sure that the TV antenna is connected.

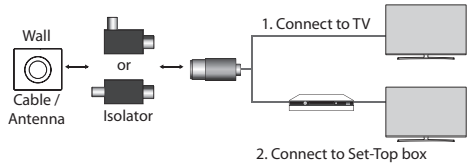

Connect one end of the isolator to cable/antenna jack and the other to TV set or set-top box.

"Equipment connected to the protective earthing of the building installation through the mains connection or through other equipment with a connection to protective earthing - and to a cable distribution system using coaxial cable, may in some circumstances create a fire hazard. Connection to a cable distribution system has therefore to be provided through a device providing electrical isolation below a certain frequency range (galvanic isolator, see EN 60728-11)"

When applying the RF Isolator, a slight loss of signal sensitivity can occur.

## ⚠ CAUTION

- Do not use any unapproved items to ensure the safety and product's lifespan.
- Any damages or injuries by using unapproved items are not covered by the warranty.
- Some models appear to have a thin film on the screen. It is actually part of the screen; do not remove it.
- When attaching the stand to the TV set, place the screen facing down on a cushioned table or flat surface to protect the screen from scratches.
- Make sure that the screws are fastened tightly. (If they are not fastened securely enough, the TV may tilt forward after being installed.)
- Do not fasten the screws with excessive force; otherwise, they may be worn out and become loose.
- Make sure to wring any excess water or cleaner from the cloth.
- Do not spray water or cleaner directly onto the TV screen.
- Make sure to spray just enough of water or cleaner onto a dry cloth to wipe the screen.
- When cleaning the product, be careful not to allow any liquid or foreign objects to enter the gap between the upper, left or right side of the panel and the guide panel. (For UH8500 series)



## Optional Extras

Optional extras can be changed or modified for quality improvement without any notification. Contact your dealer for buying these items. These devices work only with certain models. The model name or design may be changed due to the manufacturer's circumstances or policies.

(Depending upon model)

AG-F***	AG-F***DP	AN-VC550
Cinema 3D Glasses	Dual Play Glasses	Smart Camera
AN-MR650 Magic Remote		

## Lifting and Moving the TV

When moving or lifting the TV, read the following to prevent the TV from being scratched or damaged and for safe transportation regardless of its type and size.

- It is recommended to move the TV in the box or packing material that the TV originally came in.
- Before moving or lifting the TV, disconnect the power cord and all cables.



- When holding the TV, the screen should face away from you to avoid damage.
- Hold the top and bottom of the TV frame firmly. Make sure not to hold the transparent part, speaker, or speaker grille area.

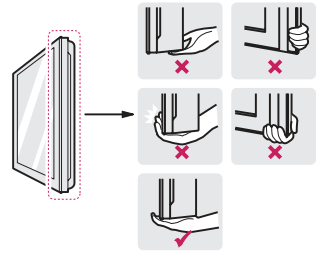

- Use at least two people to move a large TV.
- When transporting the TV by hand, hold the TV as shown in the following illustration.

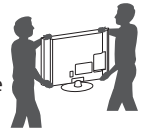

- When transporting the TV, do not expose the TV to jolts or excessive vibration.
- When transporting the TV, keep the TV upright; never turn the TV on its side or tilt towards the left or right.
- When handling the TV, be careful not to damage the protruding buttons.

## ⚠ CAUTION

- Avoid touching the screen at all times, as this may result in damage to the screen.
- Do not place the product on the floor with its front facing down without padding. Failure to do so may result in damage to the screen.
- Do not move the TV by holding the cable holders, as the cable holders may break, and injuries and damage to the TV may occur. (Depending upon model)

## Using the Button

(Depending upon model)

You can simply operate the TV functions, pressing or moving the button.

### ! NOTE

- 43/49UH6030, 43/49UH6100, 49UH6090, and 43/49UH610A does not have a Joystick button but has only a power On/Off button.

(A Type)

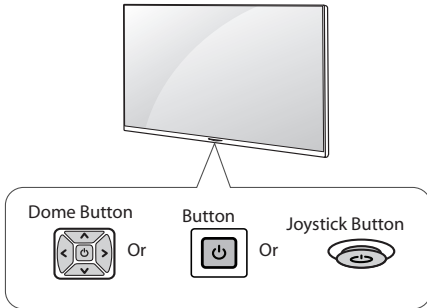

(B Type)

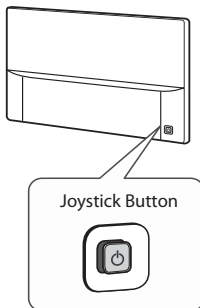

## Basic Functions

			Power On (Press) Power Off (Press and Hold) <sup>1</sup>
			Volume Control
			Channels Control

1 All running apps will close.

## Adjusting the Menu

When the TV is turned on, press button one time. You can adjust the Menu items pressing or moving the buttons.

	Turns the power off.
	Accesses the setting menu.
	Clears on-screen displays and returns to TV viewing.
	Changes the input source.

## Mounting on a Table

- 1 Lift and tilt the TV into its upright position on a table.
  - Leave a 10 cm (4 inches) (minimum) space from the wall for proper ventilation.

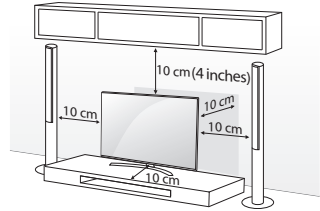

- 2 Connect the power cord to a wall outlet.



## ⚠ CAUTION

- Do not place the TV near or on sources of heat, as this may result in fire or other damage.

## Securing the TV to a Wall (optional)

(Depending upon model)

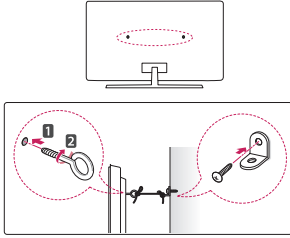

- 1 Insert and tighten the eye-bolts, or TV brackets and bolts on the back of the TV.
  - If there are bolts inserted at the eye-bolts position, remove the bolts first.
- 2 Mount the wall brackets with the bolts to the wall. Match the location of the wall bracket and the eye-bolts on the rear of the TV.
- 3 Connect the eye-bolts and wall brackets tightly with a sturdy rope or cable. Make sure to keep the rope parallel to the flat surface.

## ⚠ CAUTION

- Make sure that children do not climb on or hang on the TV.

## ! NOTE

- Use a platform or cabinet that is strong and large enough to support the TV securely.
- Brackets, bolts, and ropes are optional. You can obtain additional accessories from your local dealer.

## Mounting on a Wall

An optional wall mount can be used with your LG Television. Consult with your local dealer for a wall mount that supports the VESA standard used by your TV model. Carefully attach the wall mount bracket at the rear of the TV. Install the wall mount bracket on a solid wall perpendicular to the floor. If you are attaching the TV to other building materials, please contact qualified personnel to install the wall mount. Detailed instructions will be included with the wall mount. We recommend that you use an LG brand wall mount. The LG wall mount is easy to adjust or to connect the cables. When you do not use LG's wall mount bracket, use a wall mount bracket where the device is adequately secured to the wall with enough space to allow connectivity to external devices. If you are using a non-adjustable mount, attach the mount to the wall. Attach the cables to the TV first, then attach the TV to the mount.

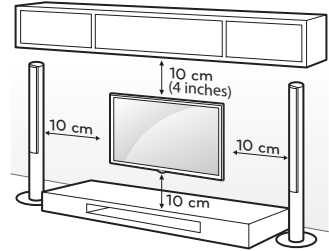

Make sure to use screws and wall mounts that meet the VESA standard. Standard dimensions for the wall mount kits are described in the following table.

<b>Model</b>	50UH6300	58UH6300
	49UH610A	60/65UH615A
	55UH615A	60/65UH6150
	49UH6100	60/65UH6550
	49UH6090	60/65UH7500
	55UH6090	60/65UH7700
	55UH6150	60/65UH8500
	49UH6500	60/65UH7650
	55UH6550	60UH6090
	49/55UH7500	60/65UH6030
	49/55UH7700	60UH6035
	55UH8500	
	55UH7650	
	49/55UH6030	

<b>VESA (A x B)</b>	300 x 300	300 x 300
---------------------	-----------	-----------

<b>Standard screw</b>	M6	M6
-----------------------	----	----

<b>Number of screws</b>	4	4
-------------------------	---	---

<b>Wall mount bracket (optional)</b>	LSW350B MSW240	LSW350B
--------------------------------------	-------------------	---------

<b>Model</b>	43UH6100	75UH6550
	43UH6500	75UH8500
	43UH7500	86UH9500
	43UH610A	70UH6350
	43UH6030	70UH6330

<b>VESA (A x B)</b>	200 x 200	600 x 400
---------------------	-----------	-----------

<b>Standard screw</b>	M6	M8
-----------------------	----	----

<b>Number of screws</b>	4	4
-------------------------	---	---

<b>Wall mount bracket (optional)</b>	LSW240B MSW240	LSW640B
--------------------------------------	-------------------	---------

<b>Model</b>	65UH9500	
--------------	----------	--

<b>VESA (A x B)</b>	300 x 200	
---------------------	-----------	--

<b>Standard screw</b>	M6	
-----------------------	----	--

<b>Number of screws</b>	4	
-------------------------	---	--

<b>Wall mount bracket (optional)</b>	OTW420B	
--------------------------------------	---------	--

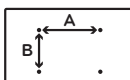

**CAUTION**

- Remove the stand before installing the TV on a wall mount by performing the stand attachment in reverse.

**NOTE**

- When using the wall mount, it is recommended that you apply a piece of tape over the 2 Pole Stand holes to prevent dust and bugs from entering the holes. (Depending upon model)

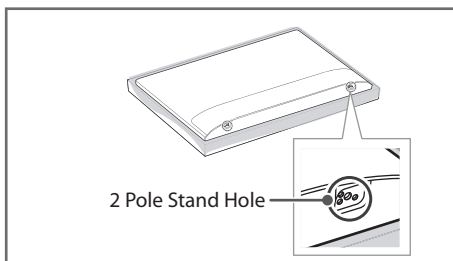

- When using the wall mounting bracket, apply the adhesive protective label or protective cover to cover the unused stand openings. This will prevent the accumulation of dust and dirt. (Use only when provided with your particular model.)

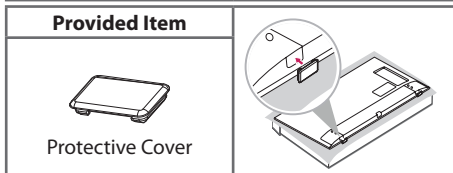
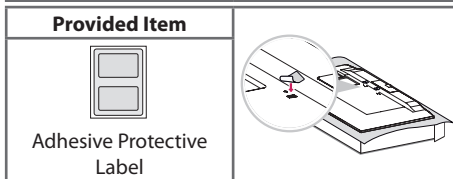
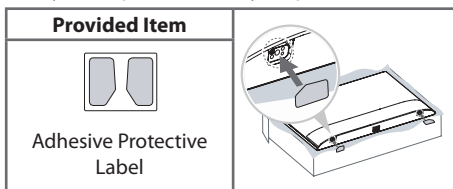

- Depending upon the shape of the stand, use a flat tool to remove the stand cover as illustrated below. (e.g., a flat screwdriver)

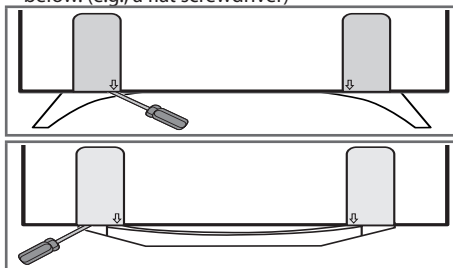

## Connections (Notifications)

You can connect various external devices to the TV. Supported external devices are: HD receivers, DVD players, VCRs, audio systems, USB storage devices, PC, gaming devices, and other external devices. For more information on an external device's connection, refer to the manual provided with each device.

### ! NOTE

- If you record a TV program on a DVD recorder or VCR, make sure to connect the TV signal input cable to the TV through a DVD recorder or VCR. For more information about recording, refer to the manual provided with the connected device.
- The external device connections shown may differ slightly from illustrations in a manual.
- Connect external devices to the TV regardless about the order of the TV port.
- If you connect a gaming device to the TV, use the cable supplied with the gaming device.
- Refer to the external equipment's manual for operating instructions.
- In PC mode, there may be noise associated with the resolution, vertical pattern, contrast, or brightness. If noise is present, change the PC output to another resolution, change the refresh rate to another rate, or adjust the brightness and contrast on the **PICTURE** menu until the picture is clear.
- Depending upon the graphics card, some resolution settings may not allow the image to be positioned on the screen properly.
- Some USB Hubs may not work. If a USB device connected through a USB Hub is not detected, connect it directly to the USB port on the TV.
- The TV may be capable of operating without a set-top from a multichannel video programming distributor (MVPD).

## Connecting to an Antenna or Cable

Connect an antenna, cable, or cable box to watch TV. The illustrations may differ from the actual items and an RF cable is optional.

### ! CAUTION

- Make sure not to bend the copper wire of the RF cable.

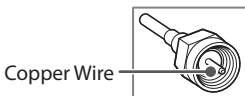

- Complete all connections between devices, and then connect the power cord to the power outlet to prevent damage to your TV.



### ! NOTE

- Use a signal splitter to use 2 TVs or more.
- DTV Audio Supported Codec: MPEG, Dolby Digital.
- Direct ULTRA HD broadcast is unavailable in areas without an ULTRA HD signal.
- This TV cannot receive ULTRA HD (3840 x 2160 pixels) broadcasts directly because the related standards have not been confirmed. (Depending upon model)

## Other Connections

Connect your TV to external devices. For the best picture and audio quality, connect the external device and the TV with the HDMI cable. Depending upon the model, a cable may not be provided.

### ! NOTE

-  >  >  > **General > HDMI ULTRA HD Deep Color:**
  - **On** : Support 4K @ 60 Hz (4:4:4, 4:2:2, 4:2:0)
  - **Off** : Support 4K @ 60 Hz 8bit (4:2:0)
- If the device connected to Input Port also supports ULTRA HD Deep Color, your picture may be clearer. However, if the device doesn't support it, it may not work properly. In that case, connect the device to a different HDMI port or change the TV's **HDMI ULTRA HD Deep Color** setting to **Off**.
  - This feature is available only on certain models which support HDMI ULTRA HD Deep Color.
- HDMI Audio Supported Format:
  - DTS (44.1 kHz / 48 kHz),
  - AC3 (32 kHz / 44.1 kHz / 48 kHz),
  - PCM (32 kHz / 44.1 kHz / 48 kHz / 96 kHz / 192 kHz)(Depending upon model)

# Remote Control

(Depending upon model)

The descriptions in this manual are based on the buttons on the remote control. Please read this manual carefully and use the TV correctly. To install batteries, open the battery cover, replace batteries (1.5 V AAA) matching the ⊕ and ⊖ ends to the label inside the compartment, and close the battery cover. Failure to match the correct polarities of the battery may cause the battery to burst or leak, resulting in fire, personal injury, or ambient pollution. To remove the batteries, perform the installation actions in reverse. This remote uses infrared light. When in use, it should be pointed in the direction of the TV's remote sensor.

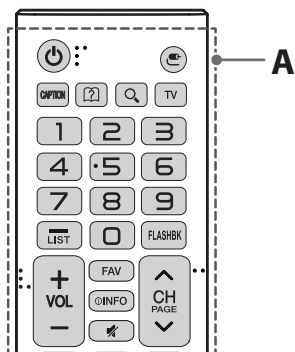

**A**

**⏻ (POWER)** Turns the TV on or off.

**📺 (INPUT)** Changes the input source.

**CAPTION** Activates or deactivates the subtitles.

**📖 (User Guide)** Sees user-guide.

**🔍 (Search)** Shows the search mode.

**TV** Returns to the last TV channel.

**Number button** Enters numbers.

**- (Dash)** Inserts a dash between numbers such as 2-1 and 2-2.

**LIST** Accesses the saved channel list.

**FLASHBK** Alternates between the two last channels selected (pressing repeatedly).

**+ VOL -** Adjusts the volume level.

**FAV** Accesses your favorite channel list.

**ⓘ (INFO)** Shows information on the current program.

**🔇** Mutes all sounds.

**⏪ ⏩** Scrolls through the saved channels.

**⏪ ⏩** Moves to the previous or next screen.

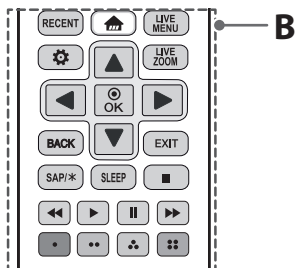

**B**

**RECENT** Shows the previous history.

**🏠 (Home)** Accesses the Home menu.

**LIVE MENU** Shows the list of Channels.

**⚙️ (Settings)** Accesses the settings.

**LIVE ZOOM** By zooming in on the selected area, you can view it in full screen.

**Navigation buttons** Scrolls through menus or options. (up/down/left/right)

**OK** Selects menus or options and confirms your input.

**BACK** Returns to the previous screen.

**EXIT** Clears all on-screen displays and returns to TV viewing.

**SAP/\*** Enables SAP (Secondary Audio Program) Feature.

**SLEEP** Sets the length of time until the TV turns off.

**▶️, ⏸️, ⏪, ⏩** Control buttons for media contents

**Color buttons** These access special functions in some menus. (🟡, 🟢, 🟠, 🟣)

ENGLISH

# Magic Remote Functions

(Depending upon model)

When the message *Magic remote battery is low. Change the battery.* is displayed, replace the batteries. To install batteries, open the battery cover, replace batteries (1.5 V AA) matching  $\oplus$  and  $\ominus$  ends to the label inside the compartment, and close the battery cover. Failure to match the correct polarities of the battery may cause the battery to burst or leak, resulting in fire, personal injury, or ambient pollution. Be sure to point the remote control at the remote control sensor on the TV. To remove the batteries, perform the installation actions in reverse.

This remote uses infrared light and Bluetooth technology. When in use, it should be pointed in the direction of the TV's remote sensor.

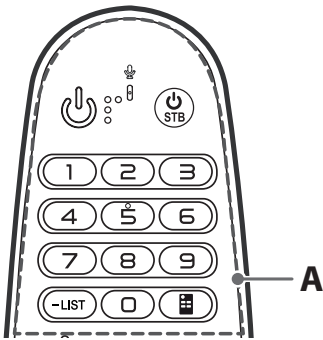

**A**

**(POWER)** Turns the TV on or off.

**STB (STB POWER)** You can turn your set-top box on or off by adding the set-top box to the universal remote control for your TV.

**Number button** Enters numbers.

**- (Dash)** Inserts a dash between numbers such as 2-1 and 2-2.

**LIST** Accesses the saved channel list.

**(Screen Remote)** Displays the Screen Remote.

- Accesses the Universal Control Menu in some regions.

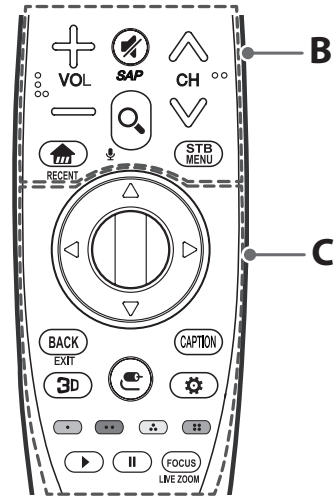

**B**

**+ VOL** Adjusts the volume level.

**(MUTE)** Mutes all sounds.

**\* Video descriptions function will be enabled.**

- SAP (Secondary Audio Program) Feature can also be enabled by pressing the **SAP** key.

**CH** Scrolls through the saved channels.

**(Home)** Accesses the Home menu.

**RECENT** \* Shows the previous history.

**(Search)** Search for content such as channels, movies and other videos, or perform a web search by entering your search terms in the search box.

**(Voice recognition)** Network connection is required to use the voice recognition function.

1 Press and hold the **(Search)** button.

2 Speak when the voice display window appears on the TV screen.

**STB MENU** Displays the set-top box Home menu. (When you are not watching with a set-top box: the set-top box screen is displayed.)

## C

**△▽◀▶** (up/down/left/right) Press the up, down, left or right button to scroll the menu. If you press **△▽◀▶** buttons while the pointer is in use, the pointer will disappear from the screen and Magic Remote will operate like a general remote control. To display the pointer on the screen again, shake Magic Remote to the left and right.

**⦿ Wheel (OK)** Press the center of the Wheel button to select a menu. You can change channels by using the Wheel button.

**BACK** Returns to the previous screen.

**EXIT** \* Clears all on-screen displays and returns to TV viewing.

**3D** Used for viewing 3D video. (For 3D models)

**☺ (INPUT)** Changes the input source.

- Pressing and holding the **☺ (INPUT)** button displays all the lists of external inputs.

**⌨ CAPTION** Activates or deactivates the subtitles.

**⚙ (Q. Settings)** Accesses the quick settings.

- Pressing and holding the **⚙ (Q. Settings)** button displays the **All Settings** menu.

**Color buttons** These access special functions in some menus.

**Ⓜ** Red, **Ⓝ** Green, **Ⓚ** Yellow, **Ⓛ** Blue)

**▶, ||** Control buttons for media contents

**FOCUS** You can zoom in on the area where the remote control is pointed.

**LIVE ZOOM** \* By zooming in on the selected area, you can view it in full screen.

\* : To use the button, press and hold for more than 3 seconds.

## Registering Magic Remote

### How to Register the Magic Remote

To use the Magic Remote, first pair it with your TV.

1 Put batteries into the Magic Remote and turn the TV on.

2 Point the Magic Remote at your TV and press the **⦿ Wheel (OK)** on the remote control.

- If the TV fails to register the Magic Remote, try again after turning the TV off and back on.

### How to Deregister the Magic Remote

Press the **BACK(EXIT)** and **🏠 (Home)** buttons at the same time, for five seconds, to unpair the Magic Remote with your TV.

- Pressing and holding the **CAPTION** button will let you cancel and re-register Magic Remote at once.

## Licenses

Supported licenses may differ by model.

For more information about licenses, visit [www.lg.com](http://www.lg.com).



(For UH7650, UH7700, UH8500, UH9500 series)



## Open Source Software Notice Information

To obtain the source code under GPL, LGPL, MPL, and other open source licenses, that is contained in this product, please visit <http://opensource.lge.com>.

In addition to the source code, all referred license terms, warranty disclaimers and copyright notices are available for download.

LG Electronics will also provide open source code to you on CD-ROM for a charge covering the cost of performing such distribution (such as the cost of media, shipping, and handling) upon email request to [opensource@lge.com](mailto:opensource@lge.com). This offer is valid for three (3) years from the date on which you purchased the product.

## Troubleshooting

- Cannot control the TV with the remote control.
  - Check if anything such as tape has been placed over the receiver.
  - Check if there is any obstacle between the product and the remote control.
  - Replace the batteries with new ones.
- No image display and no sound is produced.
  - Check if the product is turned on.
  - Check if the power cord is connected to a wall outlet.
  - Check if there is a problem in the wall outlet by connecting other products.
- The TV turns off suddenly.
  - Check the power control settings. The power supply may be interrupted.
  - Check if the **Sleep Timer / Timer Power Off** feature is activated in the **Timers** settings.
  - If there is no signal while the TV is on, the TV will turn off automatically after 15 minutes of inactivity.

## Specifications

Product specifications may be changed without prior notice due to upgrade of product functions.

Estimated yearly energy consumption indicated on the FTC label is measured in accordance with the Test Procedures for Television Sets (USA only).

The actual energy consumption depends on the usage environment (the content watched, TV settings, etc.).

### Television System

ATSC, NTSC-M, 64 & 256 QAM

### Program Coverage

VHF 2-13, UHF 14-69, DTV 2-69, CATV 1-135, CADTV 1-135

### External Antenna Impedance

75 Ω

## Environment Condition

- Operating Temperature  
0 °C to 40 °C (32 °F to 104 °F)
- Operating Humidity  
Less than 80 %
- Storage Temperature  
- 20 °C to 60 °C (-4 °F to 140 °F)
- Storage Humidity  
Less than 85 %

## Wireless Module Specifications

(For UH6330, UH6300, UH6350, UH6500, UH6550, UH7500, UH7650, UH7700, UH8500, UH9500, series)

Wireless Module(LGSBWAC61)Specifications	
Wireless LAN (IEEE 802.11a/b/g/n/ac)	
Frequency Range	Output Power(Max.)
2400 to 2483.5 MHz	15 dBm
5150 to 5725 MHz	16 dBm
5725 to 5850 MHz	12.5 dBm
Bluetooth	
Frequency Range	Output Power(Max.)
2400 to 2483.5 MHz	10 dBm

As band channels can vary per country, the user cannot change or adjust the operating frequency. This product is configured for the regional frequency table.

For consideration of the user, this device should be installed and operated with a minimum distance of 20 cm (7.8 inches) between the device and the body.

FCC ID: BEJLGSBWAC61  
IC: 2703H-LGSBWAC61

(For UH6035, UH6030, UH610A, UH6100, UH6150, UH615A, UH6090 series)

Wireless LAN Module(WN8122E1) Specification	
Standard	IEEE802.11a/b/g/n
Frequency Range	2400 to 2483.5 MHz 5150 to 5250 MHz 5725 to 5850 MHz
Output Power (Max.)	802.11a : 16.5 dBm 802.11b : 16 dBm 802.11g : 15.5 dBm 802.11n - 2.4GHz : 15.5 dBm 802.11n - 5GHz : 16.5 dBm
<p>As band channels can vary per country, the user cannot change or adjust the operating frequency. This product is configured for the regional frequency table.</p> <p>For consideration of the user, this device should be installed and operated with a minimum distance of 20 cm (7.8 inches) between the device and the body.</p> <p>Contains FCC ID: BEJWN8122E1 Contains IC: 2703H-WN8122E1</p>	

## External Control Device Setup

To obtain the external control device setup information, please visit [www.lg.com](http://www.lg.com).



# Regulatory

## FCC Notice

(For USA)

This equipment has been tested and found to comply with the limits for a Class B digital device, pursuant to Part 15 of the FCC Rules. These limits are designed to provide reasonable protection against harmful interference in a residential installation. This equipment generates, uses, and can radiate radio frequency energy and, if not installed and used in accordance with the instructions, may cause harmful interference to radio communications. However, there is no guarantee that interference will not occur in a particular installation. If this equipment does cause harmful interference to radio or television reception, which can be determined by turning the equipment off and on, the user is encouraged to try to correct the interference by one or more of the following measures:

- Reorient or relocate the receiving antenna.
- Increase the separation between the equipment and the receiver.
- Connect the equipment to an outlet on a circuit different from that to which the receiver is connected.
- Consult the dealer or an experienced radio/TV technician for help.

This device complies with part 15 of the FCC Rules. Operation is subject to the following two conditions: (1) this device may not cause harmful interference and (2) this device must accept any interference received, including interference that may cause undesired operation of the device. Any changes or modifications in construction of this device which are not expressly approved by the party responsible for compliance could void the user's authority to operate the equipment.

## FCC Radio Frequency Interference Requirements (for UNII devices)

High power radars are allocated as primary users of the 5.25 to 5.35 GHz and 5.65 to 5.85 GHz bands. These radar stations can cause interference with and/or damage this device. This device cannot be co-located with any other transmitter.

## FCC RF Radiation Exposure Statement

[For having wireless function (WLAN, Bluetooth,...)]

This equipment complies with FCC radiation exposure limits set forth for an uncontrolled environment. This transmitter must not be co-located or operating in conjunction with any other antenna or transmitter.

This equipment should be installed and operated with minimum distance 20 cm (7.8 inches) between the antenna and your body. Users must follow the specific operating instructions for satisfying RF exposure compliance.

## Industry Canada Statement

(For Canada)

[For having wireless function (WLAN, Bluetooth,...)]

This device complies with Industry Canada's licence-exempt RSSs. Operation is subject to the following two conditions:

- 1 This device may not cause interference; and
- 2 This device must accept any interference, including interference that may cause undesired operation of the device.

## IC Radiation Exposure Statement

(For Canada)

[For having wireless function (WLAN, Bluetooth,...)]

This equipment complies with IC radiation exposure limits set forth for an uncontrolled environment. This equipment should be installed and operated with minimum distance 20 cm (7.8 inches) between the antenna & your body.

NOTE: THE MANUFACTURER IS NOT RESPONSIBLE FOR ANY RADIO OR TV INTERFERENCE CAUSED BY UNAUTHORIZED MODIFICATIONS TO THIS EQUIPMENT. SUCH MODIFICATIONS COULD VOID THE USER'S AUTHORITY TO OPERATE THE EQUIPMENT.

## WARNING

(For Canada)

[For product having the wireless function using 5 GHz frequency bands]

- 1 The device for operation in the band 5150–5250 MHz is only for indoor use to reduce the potential for harmful interference to co-channel mobile satellite systems;
- 2 For devices with detachable antenna(s), the maximum antenna gain permitted for devices in the bands 5250–5350 MHz and 5470–5725 MHz shall be such that the equipment still complies with the e.i.r.p. limit;
- 3 For devices with detachable antenna(s), the maximum antenna gain permitted for devices in the band 5725–5850 MHz shall be such that the equipment still complies with the e.i.r.p. limits specified for point-to-point and non-point-to-point operation as appropriate; and

- 4 The worst-case tilt angle(s) necessary to remain compliant with the e.i.r.p. elevation mask requirement set forth in Section 6.2.2(3) shall be clearly indicated.(devices operating in the band 5250-5350 MHz with a maximum e.i.r.p. greater than 200 mW)
- 5 High-power radars are allocated as primary users (i.e. priority users) of the bands 5250-5350 MHz and 5650-5850 MHz and that these radars could cause interference and/or damage to LE-LAN devices.

## Note to Cable/TV Installer

(For USA and Canada)

This reminder is provided to call the CATV system installer's attention to Article 820-40 of the National Electric Code (U.S.A.). The code provides guidelines for proper grounding and, in particular, specifies that the cable ground shall be connected to the grounding system of the building, as close to the point of the cable entry as practical.







## WARNING!

Never place a television set in an unstable location. A television set may fall, causing serious personal injury or death. Many injuries, particularly to children, can be avoided by taking simple precautions such as:

- Using cabinets or stands recommended by the manufacturer of the television set.
- Only using furniture that can safely support the television set.
- Ensuring the television set is not overhanging the edge of the supporting furniture.
- Not placing the television set on tall furniture (for example, cupboards or bookcases) without anchoring both the furniture and the television set to a suitable support.
- Not placing the television set on cloth or other materials that may be located between the television set and supporting furniture.
- Educating children about the dangers of climbing on furniture to reach the television set or its controls.

If your existing television set is being retained and relocated, the same considerations as above should be applied.

## Symbols

	Refers to alternating current(AC).
	Refers to direct current(DC).
	Refers to class II equipment.
	Refers to stand-by.
	Refers to "ON" (power).
	Refers to dangerous voltage.

## LG Recycling Policy

(For USA)

LG Electronics offers a customized e-waste take-back and recycling service that meets local needs and requirements in the countries where e-waste regulations are in place, and also provides product and packaging take-back and recycling service voluntarily in some countries. LG Electronics evaluates products' recyclability at the design step using LG's recyclability evaluation tool, with the goal of improving recyclability where practicable. Through these activities, LG seeks to contribute to conserving natural resources and protecting the environment.

For more information about the LG Recycling Policy, please visit our global site at <http://www.lg.com/global/sustainability/environment/take-back-recycling>

# CHILD SAFETY:

## PROPER TELEVISION PLACEMENT MATTERS



### THE CONSUMER ELECTRONICS INDUSTRY CARES

- Manufacturers, retailers and the rest of the consumer electronics industry are committed to making home entertainment safe and enjoyable.
- As you enjoy your television, please note that all televisions – new and old- must be supported on proper stands or installed according to the manufacturer's recommendations. Televisions that are inappropriately situated on dressers, bookcases, shelves, desks, speakers, chests, carts, etc., may fall over, resulting in injury.



### TUNE IN TO SAFETY

- **ALWAYS** follow the manufacturer's recommendations for the safe installation of your television.
- **ALWAYS** read and follow all instructions for proper use of your television.
- **NEVER** allow children to climb on or play on the television or the furniture on which the television is placed.
- **NEVER** place the television on furniture that can easily be used as steps, such as a chest of drawers.
- **ALWAYS** install the television where it cannot be pushed, pulled over or knocked down.
- **ALWAYS** route cords and cables connected to the television so that they cannot be tripped over, pulled or grabbed.



### WALL OR CEILING MOUNT YOUR TELEVISION

- **ALWAYS** contact your retailer about professional installation if you have any doubts about your ability to safely mount your television.
- **ALWAYS** use a mount that has been recommended by the television manufacturer and has a safety certification by an independent laboratory (such as UL, CSA, ETL).
- **ALWAYS** follow all instructions supplied by the television and mount manufacturers.
- **ALWAYS** make sure that the wall or ceiling where you are mounting the television is appropriate. Some mounts are not designed to be mounted to walls and ceilings with steel studs or cinder block construction. If you are unsure, contact a professional installer.
- Televisions can be heavy. A minimum of two people is required for a wall or ceiling mount installation.



### MOVING AN OLDER TELEVISION TO A NEW PLACE IN YOUR HOME

- Many new television buyers move their older CRT televisions into a secondary room after the purchase of a flat-panel television. Special care should be made in the placement of older CRT televisions.
- **ALWAYS** place your older CRT television on furniture that is sturdy and appropriate for its size and weight.
- **NEVER** place your older CRT television on a dresser where children may be tempted to use the drawers to climb.
- **ALWAYS** make sure your older CRT television does not hang over the edge of your furniture.



**Declaration of Conformity**

Trade Name: LG

Model: 43UH610A-UJ, 43UH6030-UB, 49UH6030-UB, 55UH6030-UC, 60UH6030-UC, 65UH6030-UC, 70UH6330-UB, 49UH610A-UJ, 55UH615A-UC, 60UH615A-UC, 65UH615A-UC, 43UH6100-UH, 49UH6100-UH, 49UH6090-UJ, 55UH6090-UF, 60UH6090-UF, 55UH6150-UB, 60UH6150-UB, 65UH6150-UB, 43UH6500-UB, 49UH6500-UB, 55UH6550-UB, 60UH6550-UB, 65UH6550-UB, 75UH6550-UB, 50UH6300-UA, 58UH6300-UA, 43UH7500-UA, 49UH7500-UA, 55UH7500-UA, 60UH7500-UA, 65UH7500-UA, 55UH7650-UA, 60UH7650-UA, 65UH7650-UA, 49UH7700-UB, 55UH7700-UB, 60UH7700-UB, 65UH7700-UB, 70UH6350-UB, 55UH8500-UA, 60UH8500-UA, 65UH8500-UA, 75UH8500-UD, 65UH9500-UA, 86UH9500-UA, 43UH6030-UD, 49UH6030-UD, 60UH6035-UC

Responsible Party: LG Electronics Inc.

Address: 1000 Sylvan Ave. Englewood Cliffs NJ 07632  
U.S.A

TEL: 201-266-2534

The model and serial numbers of the TV are located on the back and on one side of the TV. Record them below should you ever need service.

MODEL \_\_\_\_\_

SERIAL \_\_\_\_\_

**LG Customer Information Center**

For inquires or comments, visit [www.lg.com](http://www.lg.com) or call;

- 1-800-243-0000 USA, Consumer User
- 1-888-865-3026 USA, Commercial User
- 1-888-542-2623 CANADA

**Register your product Online!**

[www.lg.com](http://www.lg.com)



OWNER'S MANUAL

# EXTERNAL CONTROL DEVICE SETUP

Please read this manual carefully before operating the set and retain it for future reference.

# KEY CODES

- This feature is not available for all models.

Code (Hexa)	Function	Note	Code (Hexa)	Function	Note
00	CH +, PR +	R/C Button	53	List	R/C Button
01	CH -, PR -	R/C Button	5B	Exit	R/C Button
02	Volume +	R/C Button	60	PIP(AD)	R/C Button
03	Volume -	R/C Button	61	Blue	R/C Button
06	> (Arrow Key / Right Key)	R/C Button	63	Yellow	R/C Button
07	< (Arrow Key / Left Key)	R/C Button	71	Green	R/C Button
08	Power	R/C Button	72	Red	R/C Button
09	Mute	R/C Button	79	Ratio / Aspect Ratio	R/C Button
0B	Input	R/C Button	91	AD (Audio Description)	R/C Button
0E	SLEEP	R/C Button	9E	LIVE MENU	R/C Button
0F	TV, TV/RAD	R/C Button	7A	User Guide	R/C Button
10 - 19	* Number Key 0 - 9	R/C Button	7C	Smart / Home	R/C Button
1A	Q.View / Flashback	R/C Button	7E	SIMPLINK	R/C Button
1E	FAV (Favorite Channel)	R/C Button	8E	▶▶ (Forward)	R/C Button
20	Text (Teletext)	R/C Button	8F	◀◀ (Rewind)	R/C Button
21	T. Opt (Teletext Option)	R/C Button	AA	Info	R/C Button
28	Return (BACK)	R/C Button	AB	Program Guide	R/C Button
30	AV (Audio / Video) Mode	R/C Button	B0	▶ (Play)	R/C Button
39	Caption/Subtitle	R/C Button	B1	■ (Stop / File List)	R/C Button
40	∧ (Arrow Key / Cursor Up)	R/C Button	B5	RECENT	R/C Button
41	∨ (Arrow Key / Cursor Down)	R/C Button	BA	(Freeze / Slow Play / Pause)	R/C Button
42	My Apps	R/C Button	BB	Soccer	R/C Button
43	Menu / Settings	R/C Button	BD	● (REC)	R/C Button
44	OK / Enter	R/C Button	DC	3D	R/C Button
45	Q.Menu	R/C Button	99	AutoConfig	R/C Button
4C	List, - (ATSC Only)	R/C Button	9F	App / *	R/C Button
4D	PICTURE	R/C Button	9B	TV / PC	R/C Button
52	SOUND	R/C Button			

\* Key code 4C (0x4C) is available on ATSC/ISDB models which use major/minor channel.  
(For South Korea, Japan, North America, Latin America except Colombia models)

# EXTERNAL CONTROL DEVICE SETUP

- Image shown may differ from your TV.

Connect the USB to Serial converter/RS-232C input jack to an external control device (such as a computer or an A/V control system) to control the product's functions externally.

Note: The type of control port on the TV can be different between model series.

- \* Please be advised that not all models support this type of connectivity.
- \* Cable is not provided.

## USB to Serial converter with USB Cable

USB Type

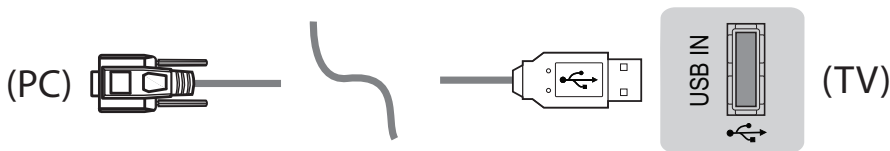

- LGTV supports PL2303 chip-based (Vendor ID : 0x0557, Product ID : 0x2008) USB to serial converter which is not made nor provided by LG.
- It can be purchased from computer stores that carry accessories for IT support professionals.

## RS-232C With RS232C Cable

DE9 (D-Sub 9pin) Type

- You need to purchase the RS-232C (DE9, D-Sub 9pin female-to-female type) to RS-232C cable required for the connection between the PC and the TV, which is specified in the manual.



The connection interface may differ from your TV.

Phone jack Type

- You need to purchase the phone-jack to RS-232 cable required for the connection between the PC and the TV, which is specified in the manual.
- \* For other models, connect to the USB port.
- \* The connection interface may differ from your TV.

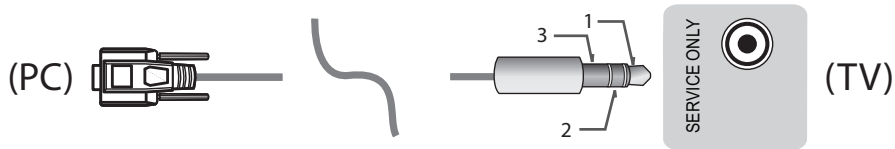

- or -

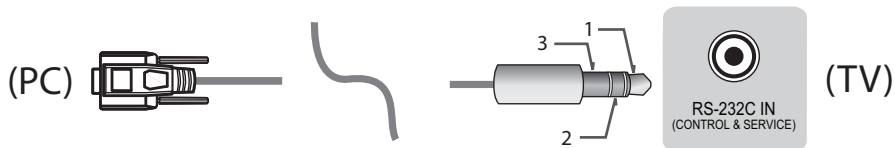

Customer Computer

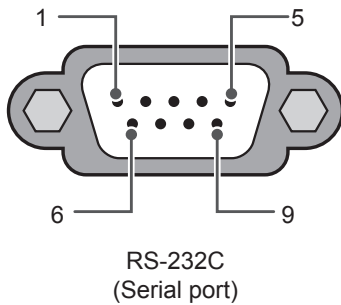

RS-232C configurations

3-Wire Configurations(Not standard)

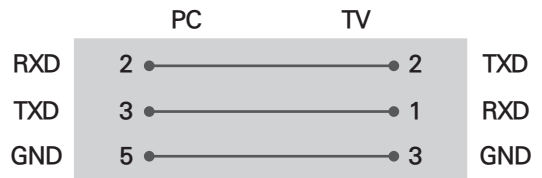

OR

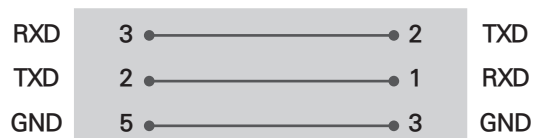

D-Sub 9

Phone

Set ID

For Set ID number, see "Real Data Mapping" on p.6

1. Press **SETTINGS** to access the main menus.
2. Press the Navigation buttons to scroll to (**\*General** → **About this TV or OPTION**) and press **OK**.
3. Press the Navigation buttons to scroll to **SET ID** and press **OK**.
4. Scroll left or right to select a set ID number and select **CLOSE**. The adjustment range is 1-99.
5. When you are finished, press **EXIT**.  
\* (Depending on model)



## Communication Parameters

- Baud rate : 9600 bps (UART)
- Data length : 8 bits
- Parity : None
- Stop bit : 1 bit
- Communication code : ASCII code
- Use a crossed (reverse) cable.

## Command reference list

(Depending on model)

	COMMAND1	COMMAND2	DATA (Hexadecimal)		COMMAND1	COMMAND2	DATA (Hexadecimal)
01. Power*	k	a	00 to 01	15. Balance	k	t	00 to 64
02. Aspect Ratio	k	c	(p.7)	16. Color (Colour) Temperature	x	u	00 to 64
03. Screen Mute	k	d	(p.7)	17. ISM Method (Only Plasma TV)	j	p	(p.8)
04. Volume Mute	k	e	00 to 01	18. Equalizer	j	v	(p.8)
05. Volume Control	k	f	00 to 64	19. Energy Saving	j	q	00 to 05
06. Contrast	k	g	00 to 64	20. Tune Command	m	a	(p.9)
07. Brightness	k	h	00 to 64	21. Channel (Programme) Add/Del(Skip)	m	b	00 to 01
08. Color/ Colour	k	i	00 to 64	22. Key	m	c	Key Codes
09. Tint	k	j	00 to 64	23. Control Backlight, Control Panel Light	m	g	00 to 64
10. Sharpness	k	k	00 to 32	24. Input select (Main)	x	b	(p.11)
11. OSD Select	k	l	00 to 01	25. 3D (Only 3D models)	x	t	(p.11)
12. Remote Control Lock Mode	k	m	00 to 01	26. Extended 3D (Only 3D models)	x	v	(p.12)
13. Treble	k	r	00 to 64	27. Auto Configure	j	u	(p.12)
14. Bass	k	s	00 to 64				

\* Note: During playing or recording media, all commands except Power (ka) and Key (mc) are not executed and treated as NG.

With RS232C cable, TV can communicate "ka command" in power-on or power-off status. but with USB-to-Serial converter cable, the command works only if TV is on.

## Transmission / Receiving Protocol

### Transmission

[Command1][Command2][ ][Set ID][ ][Data][Cr]

[Command 1] : First command to control the TV. (j, k, m or x)

[Command 2] : Second command to control the TV.

[Set ID] : You can adjust the [Set ID] to choose desired monitor ID number in option menu. Adjustment range in TV is 1 to 99. If [Set ID] value is selected to '0', every connected set can be controlled.  
 \* [Set ID] is indicated as decimal (1 to 99) on menu and as Hexadecimal (0x00 to 0x63) on transmission/receiving protocol.

[DATA] : To transmit command data (hexadecimal). Transmit 'FF' data to read status of command.

[Cr] : Carriage Return - ASCII code '0x0D'

[ ] : Space - ASCII code '0x20'

### OK Acknowledgement

[Command2][ ][Set ID][ ][OK][Data][x]

\* The set transmits ACK (acknowledgement) based on this format when receiving normal data. At this time, if the data is data read mode, it indicates present status data. If the data is data write mode, it returns the data of the PC computer.

### Error Acknowledgement

[Command2][ ][Set ID][ ][NG][Data][x]

\* The set transmits ACK (acknowledgement) based on this format when receiving abnormal data from non-viable functions or communication errors.

Data 00: Illegal Code

### Real data mapping (Hexadecimal to Decimal)

\* When you enter the [data] in hexadecimal, refer to following conversion table.

\* Channel Tune (ma) Command uses two-byte hexadecimal value([data]) to select channel number.

00 : Step 0	32 : Step 50 (Set ID 50)	FE : Step 254
01 : Step 1 (Set ID 1)	33 : Step 51 (Set ID 51)	FF : Step 255
...	...	...
0A : Step 10 (Set ID 10)	63 : Step 99 (Set ID 99)	01 00 : Step 256
...	...	...
0F : Step 15 (Set ID 15)	C7 : Step 199	27 0E : Step 9998
10 : Step 16 (Set ID 16)	C8 : Step 200	27 0F : Step 9999
...	...	...

\* Commands may work differently depending on model and signal.

### 01. Power (Command: k a)

- ▶ To control Power \*On or Off of the set.

Transmission [k][a][ ][Set ID][ ][Data][Cr]

Data 00 : Power Off      01 : \*Power On

Ack [a][ ][Set ID][ ][OK/NG][Data][x]

- ▶ To Show TV is Power On or \*Off

Transmission [k][a][ ][Set ID][ ][FF][Cr]

Ack [a][ ][Set ID][ ][OK][Data][x]

\* Similarly, if other functions transmit 'FF' data based on this format, Acknowledgement feedback presents status about each function.

### 02. Aspect Ratio (Command: k c)

(Main Picture Size)

- ▶ To adjust the screen format. (Main picture format)  
You can also adjust the screen format using the Aspect Ratio in the Q.MENU. or PICTURE menu.

Transmission [k][c][ ][Set ID][ ][Data][Cr]

Data 01 : Normal screen (4:3)	07 : 14:9 (Europe, Colombia, Mid-East, Asia except South Korea and Japan)
02 : Wide screen (16:9)	09 : * Just Scan
04 : Zoom	0B : Full Wide
05 : Zoom 2 (Latin America except Colombia Only)	0E : Full Wide (Europe, Colombia, Mid-East, Asia except South Korea and Japan)
06 : Set by Program/ Original	10 to 1F : Cinema Zoom 1 to 16 (Depending on model)

Ack [c][ ][Set ID][ ][OK/NG][Data][x]

- \* Using the PC input, you select either 16:9 or 4:3 screen aspect ratio.
- \* In DTV/HDMI/Component mode (high-definition), Just Scan is available.
- \* Full wide mode may work differently based on model and is supported for DTV fully, and ATV, AV partially.

### 03. Screen Mute (Command: k d)

- ▶ To select screen mute on/off.

Transmission [k][d][ ][Set ID][ ][Data][Cr]

Data 00 : Screen mute off (Picture on)  
Video mute off  
01 : Screen mute on (Picture off)  
10 : Video mute on

Ack [d][ ][Set ID][ ][OK/NG][Data][x]

\* In case of video mute on only, TV will display On Screen Display(OSD). But, in case of Screen mute on, TV will not display OSD.

### 04. Volume Mute (Command: k e)

- ▶ To control volume mute on/off.  
You can also adjust mute using the MUTE button on remote control.

Transmission [k][e][ ][Set ID][ ][Data][Cr]

Data 00 : Volume mute on (Volume off)  
01 : Volume mute off (Volume on)

Ack [e][ ][Set ID][ ][OK/NG][Data][x]

### 05. Volume Control (Command: k f)

- ▶ To adjust volume.  
You can also adjust volume with the volume buttons on remote control.

Transmission [k][f][ ][Set ID][ ][Data][Cr]

Data Min : 00 to Max : 64

Ack [f][ ][Set ID][ ][OK/NG][Data][x]

### 06. Contrast (Command: k g)

- ▶ To adjust screen contrast.  
You can also adjust contrast in the PICTURE menu.

Transmission [k][g][ ][Set ID][ ][Data][Cr]

Data Min : 00 to Max : 64

Ack [g][ ][Set ID][ ][OK/NG][Data][x]

### 07. Brightness (Command: k h)

- ▶ To adjust screen brightness.  
You can also adjust brightness in the PICTURE menu.

Transmission [k][h][ ][Set ID][ ][Data][Cr]

Data Min : 00 to Max : 64

Ack [h][ ][Set ID][ ][OK/NG][Data][x]

### 08. Color/Colour (Command: k i)

- ▶ To adjust the screen Color(Colour).  
You can also adjust colour in the PICTURE menu.

Transmission [k][i][ ][Set ID][ ][Data][Cr]

Data Min : 00 to Max : 64

Ack [i][ ][Set ID][ ][OK/NG][Data][x]

09. Tint (Command: k j)

- ▶ To adjust the screen tint.  
You can also adjust tint in the PICTURE menu.

Transmission [k][j][ ][Set ID][ ][Data][Cr]

Data Red : 00 to Green : 64

Ack [j][ ][Set ID][ ][OK/NG][Data][x]

10. Sharpness (Command: k k)

- ▶ To adjust the screen sharpness.  
You can also adjust sharpness in the PICTURE menu.

Transmission [k][k][ ][Set ID][ ][Data][Cr]

Data Min : 00 to Max : 32

Ack [k][ ][Set ID][ ][OK/NG][Data][x]

11. OSD Select (Command: k l)

- ▶ To select OSD (On Screen Display) on/off when controlling remotely.

Transmission [k][l][ ][Set ID][ ][Data][Cr]

Data 00 : OSD off          01 : OSD on

Ack [l][ ][Set ID][ ][OK/NG][Data][x]

12. Remote control lock mode (Command: k m)

- ▶ To lock the front panel controls on the monitor and remote control.

Transmission [k][m][ ][Set ID][ ][Data][Cr]

Data 00 : Lock off          01 : Lock on

Ack [m][ ][Set ID][ ][OK/NG][Data][x]

- \* If you are not using the remote control, use this mode.  
When main power is off & on (plug-off and plug-in, after 20 - 30 seconds), external control lock is released.

- \* In the standby mode (DC off by off timer or 'ka', 'mc' command), and if key lock is on, TV will not turn on by power on key of IR & Local Key.

13. Treble (Command: k r)

- ▶ To adjust treble.  
You can also adjust in the AUDIO menu.

Transmission [k][r][ ][Set ID][ ][Data][Cr]

Data Min : 00 to Max : 64

Ack [r][ ][Set ID][ ][OK/NG][Data][x]

\* (Depending on model)

14. Bass (Command: k s)

- ▶ To adjust Bass.  
You can also adjust in the AUDIO menu.

Transmission [k][s][ ][Set ID][ ][Data][Cr]

Data Min : 00 to Max : 64

Ack [s][ ][Set ID][ ][OK/NG][Data][x]

\* (Depending on model)

15. Balance (Command: k t)

- ▶ To adjust balance.  
You can also adjust balance in the AUDIO menu.

Transmission [k][t][ ][Set ID][ ][Data][Cr]

Data Min : 00 to Max : 64

Ack [t][ ][Set ID][ ][OK/NG][Data][x]

16. Color(Colour) Temperature (Command: x u)

- ▶ To adjust colour temperature. You can also adjust Color(Colour) Temperature in the PICTURE menu.

Transmission [x][u][ ][Set ID][ ][Data][Cr]

Data Min : 00 to Max : 64

Ack [u][ ][Set ID][ ][OK/NG][Data][x]

17. ISM Method (Command: j p) (Only Plasma TV)

- ▶ To control the ISM method. You can also adjust ISM Method in OPTION menu.

Transmission [j][p][ ][Set ID][ ][Data][Cr]

Data Min : 02: Orbiter  
08: Normal  
20: Color(Colour) Wash

Ack [p][ ][Set ID][ ][OK/NG][Data][x]

18. Equalizer (Command : j v)

- ▶ Adjust EQ of the set.

Transmission [j][v][ ][Set ID][ ][Data][Cr]

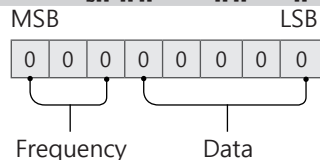

7	6	5	Frequency	4	3	2	1	0	Step
0	0	0	1st Band	0	0	0	0	0	0(decimal)
0	0	1	2nd Band	0	0	0	0	1	1(decimal)
0	1	0	3rd Band	...	...	...	...	...	...
0	1	1	4th Band	1	0	0	1	1	19(decimal)
1	0	0	5th Band	1	0	1	0	1	20(decimal)

Acknowledgement [v][ ][Set ID][ ][OK/NG][Data][x]

\* It depends on model, and can adjust when sound mode is EQ adjustable value.

### 19. Energy Saving (Command: j q)

► To reduce the power consumption of the TV. You can also adjust Energy Saving in PICTURE menu.

Transmission [j][q][ ][Set ID][ ][Data][Cr]

#### Data

- 00 : Off
- 01 : Minimum
- 02 : Medium
- 03 : Maximum
- 04 : Auto (For LCD TV / LED TV) / Intelligent sensor (For PDP TV)
- 05 : Screen off

\* (Depending on model)

Ack [q][ ][Set ID][ ][OK/NG][Data][x]

### 20. Tune Command (Command: m a)

\* This command may work differently depending on model and signal.

• For Europe, Mid-East, Colombia, Asia except South Korea and Japan Model

► Select channel to following physical number.

Transmission [m][a][ ][Set ID][ ][Data 00][ ][Data 01][ ][Data 02][Cr]

\* Analog Antenna/Cable

[Data 00][Data 01] Channel Data

Data 00 : High byte channel data

Data 01 : Low byte channel data

- 00 00 ~ 00 C7 (Decimal : 0 ~ 199)

Data 02 : Input Source (Analog)

- 00 : Antenna TV (ATV)

- 80 : Cable TV (CATV)

\* Digital Antenna/Cable/Satellite

[Data 00][Data 01]: Channel Data

Data 00 : High Channel data

Data 01 : Low Channel data

- 00 00 ~ 27 0F (Decimal: 0 ~ 9999)

Data 02 : Input Source (Digital)

- 10 : Antenna TV (DTV)

- 20 : Antenna Radio (Radio)

- 40 : Satellite TV (SDTV)

- 50 : Satellite Radio (S-Radio)

- 90 : Cable TV (CADTV)

- a0 : Cable Radio (CA-Radio)

\* Tune Command Examples:

1. Tune to the Analog antenna (PAL) Channel 10.

Set ID = All = 00

Data 00 & 01 = Channel Data is 10 = 00 0a

Data 02 = Analog Antenna TV = 00

Result = **ma 00 00 0a 00**

2. Tune to the digital antenna (DVB-T) Channel 01.

Set ID = All = 00

Data 00 & 01 = Channel Data is 1 = 00 01

Data 02 = Digital Antenna TV = 10

Result = **ma 00 00 01 10**

3. Tune to the satellite (DVB-S) Channel 1000.

Set ID = All = 00

Data 00 & 01 = Channel Data is 1000 = 03 E8

Data 02 = Digital Satellite TV = 40

Result = **ma 00 03 E8 40**

Ack [a][ ][Set ID][ ][OK][Data 00][Data 01]

[Data 02][x][a][ ][Set ID][ ][NG][Data 00][x]

• For South Korea, North/Latin America except Colombia Model

► To tune channel to following physical/major/minor number.

Transmission [m][a][ ][0][ ][Data00][ ][Data01][ ][Data02][ ][Data03][ ][Data04][ ][Data05][Cr]

Digital channels have a Physical, Major, and Minor channel number. The Physical number is the actual digital channel number, the Major is the number that the channel should be mapped to, and the Minor is the sub-channel. Since the ATSC tuner automatically maps the channel from the Major / Minor number, the Physical number is not required when sending a command in Digital.

\* Analog Antenna/Cable

Data 00 : Physical Channel Number

- Antenna (ATV) : 02~45 (Decimal: 2 ~ 69)

- Cable (CATV) : 01, 0E~7D (Decimal : 1, 14~125)

[Data 01 ~ 04]: Major/Minor Channel Number

Data 01 & 02: xx (Don't care)

Data 03 & 04: xx (Don't care)

Data 05: Input Source (Analog)

- 00 : Antenna TV (ATV)

- 01 : Cable TV (CATV)

## \* Digital Antenna/Cable

Data 00 : xx (Don't care)

[Data 01][Data 02]: Major Channel Number

Data 01 : High byte Channel Data

Data 02 : Low byte Channel Data

- 00 01 ~ 27 0F (Decimal: 1 ~ 9999)

[Data 03][Data 04]: Minor Channel Number

Data 03 : High byte Channel Data

Data 04 : Low byte Channel Data

Data 05 : Input Source (Digital)

- 02 : Antenna TV (DTV) – Use Physical Channel Number

- 06 : Cable TV (CADTV) – Use Physical Channel Number

- 22 : Antenna TV (DTV) – Don't Use Physical Channel Number

- 26 : Cable TV (CADTV) - Don't Use Physical Channel Number

- 46 : Cable TV (CADTV) – Use Physical/Major Channel Number Only (One Part Channel)

- 66 : Cable TV (CADTV) – Use Major Channel Number Only (One Part Channel)

Two bytes are available for each major and minor channel data, but usually the low byte is used alone (high byte is 0).

## \* Tune Command Examples:

## 1. Tune to the Analog cable (NTSC) channel 35.

Set ID = All = 00

Data 00 = Channel Data is 35 = 23

Data 01 &amp; 02 = No Major = 00 00

Data 03 &amp; 04 = No Minor = 00 00

Data 05 = Analog Cable TV = 01

Total = **ma 00 23 00 00 00 01**

## 2. Tune to the digital antenna (ATSC) channel 30-3.

Set ID = All = 00

Data 00 = Don't know Physical = 00

Data 01 &amp; 02 = Major is 30 = 00 1E

Data 03 &amp; 04 = Minor is 3 = 00 03

Data 05 = Digital Antenna TV = 22

Total = **ma 00 00 00 1E 00 03 22**

Ack [a][ ][Set ID][ ][OK][Data 00][Data 01]

[Data 02][Data 03][Data 04][Data 05]

[x][a][ ][Set ID][ ][NG][Data 00][x]

## • For Japan Model

- ▶ To tune channel to following physical/major/minor number.

Transmission [m][a][ ][0][ ][Data00][ ][Data01]

[ ][Data02][ ][Data03][ ][Data04][ ][Data05][Cr]

## \* Digital Antenna/Satellite

Data 00 : xx (Don't care)

[Data 01][Data 02]: Major Channel Number

Data 01 : High byte Channel Data

Data 02 : Low byte Channel Data

- 00 01 ~ 27 0F (Decimal: 1 ~ 9999)

[Data 03][Data 04]: Minor/Branch Channel Number  
(Don't care in Satellite)

Data 03 : High byte Channel Data

Data 04 : Low byte Channel Data

Data 05 : Input Source (Digital/Satellite for Japan)

- 02 : Antenna TV (DTV)

- 07 : BS (Broadcasting Satellite)

- 08 : CS1 (Communication Satellite 1)

- 09 : CS2 (Communication Satellite 2)

## \* Tune Command Examples:

## 1. Tune to the digital antenna (ISDB-T) channel 17-1.

Set ID = All = 00

Data 00 = Don't know Physical = 00

Data 01 &amp; 02 = Major is 17 = 00 11

Data 03 &amp; 04 = Minor/Branch is 1 = 00 01

Data 05 = Digital Antenna TV = 02

Total = **ma 00 00 00 11 00 01 02**

## 2. Tune to the BS (ISDB-BS) channel 30.

Set ID = All = 00

Data 00 = Don't know Physical = 00

Data 01 &amp; 02 = Major is 30 = 00 1E

Data 03 &amp; 04 = Don't Care = 00 00

Data 05 = Digital BS TV = 07

Total = **ma 00 00 00 1E 00 00 07**

## \* This feature is varied based on the model.

Ack [a][ ][Set ID][ ][OK][Data 00][Data 01]

[Data 02][Data 03][Data 04][Data 05]

[x][a][ ][Set ID][ ][NG][Data 00][x]

21. Channel(Programme) Add/Del(Skip)  
(Command: m b)

- ▶ To skip current channel(programme) for next time.

Transmission [m][b][ ][Set ID][ ][Data][Cr]

Data 00 : Del(ATSC,ISDB)/Skip(DVB) 01 : Add

Ack [b][ ][Set ID][ ][OK/NG][Data][x]

- \* Set the saved channel status to del(ATSC, ISDB)/skip(DVB) or add.

## 22. Key (Command: m c)

- ▶ To send IR remote key code.

Transmission [m][c][ ][Set ID][ ][Data][Cr]

Data Key code - p.2.

Ack [c][ ][Set ID][ ][OK/NG][Data][x]

## 23. Control Backlight (Command: m g)

- For LCD TV / LED TV
- ▶ To control the backlight.

Transmission [m][g][ ][Set ID][ ][Data][Cr]

Data Min : 00 to Max : 64

Ack [g][ ][Set ID][ ][OK/NG][Data][x]

Control Panel Light (Command: m g)

- For Plasma TV
- ▶ To control the panel light.

Transmission [m][g][ ][Set ID][ ][Data][Cr]

Data Min : 00 to Max : 64

Ack [g][ ][Set ID][ ][OK/NG][Data][x]

24. Input select (Command: x b)  
(Main Picture Input)

- ▶ To select input source for main picture.

Transmission [x][b][ ][Set ID][ ][Data][Cr]

Data

00 : DTV	01 : CADTV
02 : Satellite DTV	10 : ATV
	ISDB-BS (Japan)
03 : ISDB-CS1 (Japan)	
04 : ISDB-CS2 (Japan)	
11 : CATV	
20 : AV or AV1	21 : AV2
40 : Component1	41 : Component2
60 : RGB	
90 : HDMI1	91 : HDMI2
92 : HDMI3	93 : HDMI4

Ack [b][ ][Set ID][ ][OK/NG][Data][x]

- \* This function depends on model and signal.

25. 3D(Command: x t) (only 3D models)  
(Depending on model)

- ▶ To change 3D mode for TV.

Transmission [x][t][ ][Set ID][ ][Data 00][ ][Data 01][ ][Data 02][ ][Data 03][Cr]

\* (Depending on model)

Data Structure

[Data 00] 00 : 3D On  
01 : 3D Off  
02 : 3D to 2D  
03 : 2D to 3D

[Data 01] 00 : Top and Bottom  
01 : Side by Side  
02 : Check Board  
03 : Frame Sequential  
04 : Column interleaving  
05 : Row interleaving

[Data 02] 00 : Right to Left  
01 : Left to Right

[Data 03] 3D Effect(3D Depth): Min : 00 - Max : 14  
(\*transmit by Hexadecimal code)

\* [Data 02], [Data 03] functions depend on model and signal.

\* If [Data 00] is 00 (3D On), [Data 03] has no meaning.

\* If [Data 00] is 01 (3D off) or 02 (3D to 2D), [Data 01], [Data 02] and [Data 03] have no meaning.

\* If [Data 00] is 03 (2D to 3D), [Data 01] and [Data 02] have no meaning.

\* If [Data 00] is 00 (3D On) or 03 (2D to 3D), [Data 03] works when 3D Mode (Genre) is manual only.

\* All 3D pattern options ([Data 01]) may not be available according to broadcasting/video signal.

[Data 00]	[Data 01]	[Data 02]	[Data 03]
00	O	O	O
01	X	X	X
02	X	X	X
03	X	O	O

X : don't care

Ack [t][ ][Set ID][ ][OK][Data00][Data01][Data02][Data03][x]

[t][ ][Set ID][ ][NG][Data00][x]

26. Extended 3D(Command: x v) (only 3D models)  
(Depending on model)

- ▶ To change 3D option for TV.

```
Transmission [x][v][ ][Set ID][ ][Data 00][ ]
[Data 01][Cr]
```

[Data 00] 3D option

- 00 : 3D Picture Correction
- 01 : 3D Depth (3D Mode is Manual Only)
- 02 : 3D Viewpoint
- 06 : 3D Color Correction
- 07 : 3D Sound Zooming
- 08 : Normal Image View
- 09 : 3D Mode (Genre)

[Data 01] It has own range for each 3D option determined by [Data 00].

1) When [Data 00] is 00

- 00 : Right to Left
- 01 : Left to Right

2) When [Data 00] is 01, 02

Data Min: 0 - Max: 14 (\*transmit by Hexadecimal code)

Data value range(0 - 20) converts Viewpoint range (-10 - +10) automatically (Depending on model)

\* This option works when 3D Mode (Genre) is manual only.

3) When [Data 00] is 06, 07

- 00 : Off
- 01 : On

4) When [Data 00] is 08

- 00 : Revert to 3D video from 3D-to-2D converted 2D video
- 01 : Change 3D video to 2D video, except 2D-to-3D video

\* If conversion condition doesn't meet, command is treated as NG.

5) When [Data 00] is 09

- |               |              |
|---------------|--------------|
| 00 : Standard | 01 : Sport   |
| 02 : Cinema   | 03 : Extreme |
| 04 : Manual   | 05 : Auto    |

```
Ack [v][ ][Set ID][ ][OK][Data00][Data01][x]
[v][ ][Set ID][ ][NG][Data00][x]
```

27. Auto Configure (Command: j u)  
(Depending on model)

- ▶ To adjust picture position and minimize image shaking automatically. It works only in RGB (PC) mode.

```
Transmission [j][u][ ][Set ID][ ][Data][Cr]
```

Data 01 : To set Auto Configure

```
Ack [u][ ][Set ID][ ][OK/NG][Data][x]
```



## Network IP Control

(For USA only)

### How to connect

1. Connect your TV to a wired or wireless network.
2. Press and hold the  (Settings) button on the remote control for at least 5 seconds on the Live TV screen. Once the Live TV channel banner appears at the top of the screen, enter 828 and press the OK button to enter the 'IP Control Setup' menu.  
\* The 3-digit password (default password: 828) can be changed using Password Change.
3. After entering the 'IP Control Setup' menu, set the 'Network IP Control' submenu to 'On'. The reboot popup window will appear. Select 'Yes' to reboot your TV.  
\* Set to 'Off' when the feature is not in use.

4. Open a terminal program (e.g. putty, teraterm) on a computer and connect to your TV with your TV's IP address through telnet service and the port number 9761 as shown below.

```
ex) username : ~$ telnet 10.186.119.107 9761
```

5. If the connection is successful, the following message will appear. Or if 'NG' appears when you press Enter, the connection has been established.

```
Trying 10.186.119.107...
```

```
Connected to 10.186.119.107.
```

```
Escape character is '^ ]'.
```

6. Enter a command like the example shown below and press Enter.

```
VOLUME_MUTE on
```

7. If the command has been successfully entered, 'OK' will appear. If not, 'NG' will appear.

8. To exit the program, enter 'quit' and press Enter. Then, the following message will appear.

```
quit
```

```
Connection closed by foreign host
```

- \* Power ON through WOL(Wake On Lan)

You can turn on the TV, after setting the 'Mobile TV On' submenu(Setting > General > Mobile TV On) to 'On' and installing the app related with WOL(Wake On Lan) through iOS or Google Play on your mobile phone.

**Command reference list**

	COMMAND	NOTE
01. Power	POWER off	ex) POWER off
02. Aspect Ratio	ASPECT_RATIO [4by3 / 16by9 / setbyoriginal]	ex) ASPECT_RATIO 4by3
03. Screen Mute	SCREEN_MUTE [screenmuteon / videomuteon / allmuteoff]	ex) SCREEN_MUTE screenmuteon
04. Volume Mute	VOLUME_MUTE [on / off]	ex) VOLUME_MUTE on
05. Volume Control	VOLUME_CONTROL [0 to 100]	0 to 100 (Decimal) ex) VOLUME_CONTROL 15
06. Contrast	PICTURE_CONTRAST [0 to 100]	0 to 100 (Decimal) ex) PICTURE_CONTRAST 50
07. Brightness	PICTURE_BRIGHTNESS [0 to 100]	0 to 100 (Decimal) ex) PICTURE_BRIGHTNESS 50
08. Color/Colour	PICTURE_COLOUR [0 to 100]	0 to 100 (Decimal) ex) PICTURE_COLOUR 50
09. Tint	PICTURE_TINT [0 to 100]	0 to 100 (Decimal) ex) PICTURE_TINT 50
10. Sharpness	PICTURE_SHARPNESS [0 to 50]	0 to 50 (Decimal) ex) PICTURE_SHARPNESS 25
11. OSD Select	OSD_SELECT [on / off]	ex) OSD_SELECT on
12. Remote Control Lock Mode	REMOTECONTROLER_LOCK [on / off]	ex) REMOTECONTROLER_LOCK on
13. Balance	AUDIO_BALANCE [0 to 100]	0 to 100 (Decimal) ex) AUDIO_BALANCE 50
14. Color(Colour) Temperature	PICTURE_COLOUR_TEMPERATURE [0 to 100]	0 to 100 (Decimal) ex) PICTURE_COLOUR_TEMPERATURE 50
15. Equalizer	AUDIO_EQUALIZER [1 to 5] [0 to 20]	1 to 5(Frequency band) 0 to 20(Step decimal) * Precondition : All settings > sound > sound mode settings > Equalizer on ex) AUDIO_EQUALIZER 2 10
16. Energy Saving	ENERGY_SAVING [screenoff / maximum / medium / minimum / off]	ex) ENERGY_SAVING screenoff
17. Tune Command	CHANNEL_SETTING_ATSC_ATV [Channel Number] antenna CHANNEL_SETTING_ATSC_ATV [Channel Number] cable CHANNEL_SETTING_ATSC_DTV [Channel Number] cablemaj	ex) CHANNEL_SETTING_ATSC_ATV 11 antenna
	CHANNEL_SETTING_ATSC_DTV [Maj. Channel Number] [Min.Channel Number] antennanotphy CHANNEL_SETTING_ATSC_DTV [Maj. Channel Number] [Min.Channel Number] cablenotphy	ex) CHANNEL_SETTING_ATSC_DTV 10 2 antennanotphy
18. Channel(Programme) Add/Del	CHANNEL_ADD_DELETE [add / delete]	ex) CHANNEL_ADD_DELETE add

	COMMAND	NOTE
19. Key	KEY_ACTION [exit / channelup / channeldown / volumeup / volumedown / arrowright / arrowleft / volumemute / deviceinput / sleepreserve / livetv / previouschannel / favoritechannel / teletext / teletextoption / returnback / avmode / captionsubtitle / arrowup / arrowdown / myapp / settingmenu / ok / quickmenu / videomode / audiomode / channellist / bluebutton / yellowbutton / greenbutton / redbutton / aspectratio / audiodescription / programmorder / userguide / smarhome / simplelink / fastforward / rewind / programminfo / programguide / play / slowplay / soccerscreen / record / 3d / autoconfig / app / screenbright / number0 / number1 / number2 / number3 / number4 / number5 / number6 / number7 / number8 / number9]	ex) KEY_ACTION ok
20. Control Backlight	PICTURE_BACKLIGHT [0 to 100]	0 to 100 (Decimal) * Precondition : All settings > picture > Energy Saving off ex) PICTURE_BACKLIGHT 50
21. Input select	INPUT_SELECT [dtv / atv / cadtv / catv / avav1 / component1 / hdmi1 / hdmi2 / hdmi3]	ex) INPUT_SELECT dtv
22. 3D (only 3D models)	PICTURE_3D [off / 3dto2d]	ex) PICTURE_3D off
	PICTURE_3D 2dto3d [righttoleft / lefttoright] [0 to 20]	ex) PICTURE_3D 2dto3d righttoleft 10
	PICTURE_3D on [topandbottom / sidebyside / checkboard / framesequential / columninterleaving / rowinterleaving] [righttoleft / lefttoright] [0 to 20]	ex) PICTURE_3D on topandbottom righttoleft 0

	COMMAND	NOTE
23. Extended 3D (only 3D models)	PICTURE_3D_EXTENSION picturecorrection [0 / 1]	0 : Right to Left 1 : Left to Right * Precondition : 1) PICTURE_3D on X X X ex) PICTURE_3D_EXTENSION picturecorrection 0
	PICTURE_3D_EXTENSION [colorcorrection / sound] [0 / 1]	0 : off 1 : on * Colorcorrection, Sound Precondition : 1) PICTURE_3D on X X X Colorcorrection ex) PICTURE_3D on topandbottom righttoleft 0 PICTURE_3D_EXTENSION colorcorrection 1 Sound ex) PICTURE_3D on topandbottom righttoleft 0 PICTURE_3D_EXTENSION sound 1
	PICTURE_3D_EXTENSION normal [0 / 1]	0 : off 1 : on * Precondition : 1) PICTURE_3D on X X X ex) PICTURE_3D_EXTENSION normal 0
	PICTURE_3D_EXTENSION [depth / viewpoint] [0 to 20]	0 to 20 : Viewpoint range * Depth precondition : 1) PICTURE_3D 2dto3d X X 2) PICTURE_3D_EXTENSION genre 4 * Viewpoint precondition : 1) PICTURE_3D 2dto3d X X Depth ex) PICTURE_3D 2dto3d righttoleft 0 PICTURE_3D_EXTENSION genre 4 PICTURE_3D_EXTENSION depth 0 Viewpoint ex) PICTURE_3D 2dto3d righttoleft 0 PICTURE_3D_EXTENSION viewpoint 0
	PICTURE_3D_EXTENSION genre [0 to 5]	0 : Standard / 1 : Sport / 2 : Cinema / 3 : Extreme / 4 : Manual / 5 : Auto * Precondition : 1) PICTURE_3D 2dto3d X X ex) PICTURE_3D_EXTENSION genre 2

\* This feature is varied based on the model.

\* During playing or recording media, all commands except Power and Key commands are not executed and treated as NG.



### ENGLISH

#### Easy Setup Guide

Please read this manual carefully before operating your set and retain it for future reference.

### ESPAÑOL

#### Guía Rápida de Configuración

Lea atentamente este manual antes de poner en marcha el equipo y consérvelo para futuras consultas.

### FRANÇAIS

#### Guide de configuration rapide

Avant d'utiliser l'appareil, veuillez lire attentivement ce guide et conservez-le pour pouvoir vous y reporter ultérieurement.

### LED TV

43UH610A	49UH610A	43UH6100
43UH6030	55UH615A	49UH6100
49UH6030	60UH615A	55UH6150
55UH6030	65UH615A	60UH6150
60UH6030	49UH6090	65UH6150
65UH6030	55UH6090	
60UH6035	60UH6090	

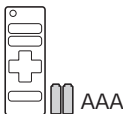
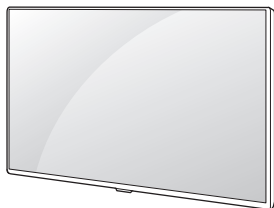

60UH6035  
55/60/65UH6030  
55/60/65UH615A  
55/60/65UH6150



43/49UH610A,  
49UH6090, 43/49UH6030  
43/49UH6100

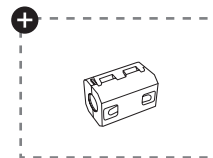
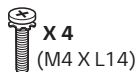
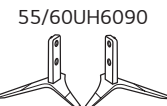

[www.lg.com](http://www.lg.com)

+ **ENGLISH** Depending upon model  
**ESPAÑOL** Según el modelo  
**FRANÇAIS** Selon le modèle

P/No: MFL69289458 (1607-REV05)



**ENGLISH** Read Safety and Reference.

**ESPAÑOL** Leer Seguridad y Consultas.

**FRANÇAIS** Lisez Sécurité et références.

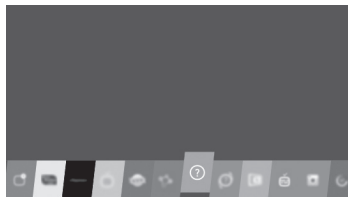
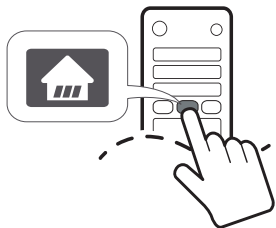

43/49UH6100, 43/49UH610A, 49UH6090, 43/49UH6030

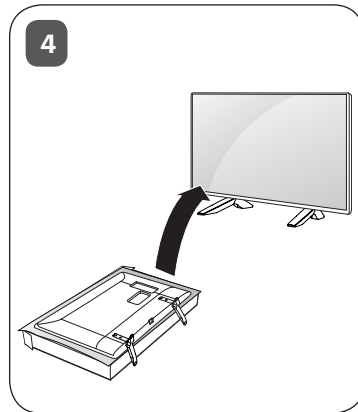
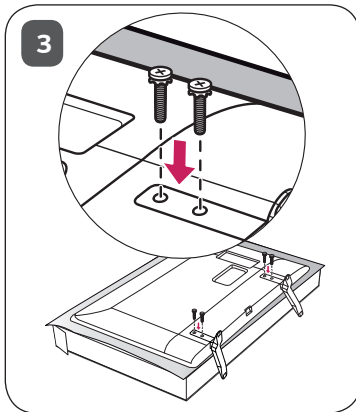
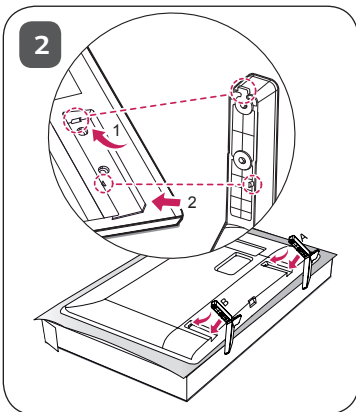
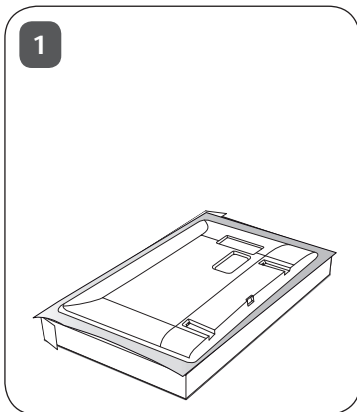

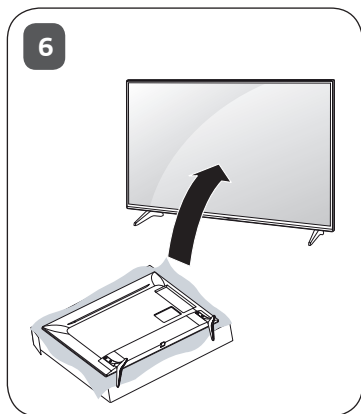
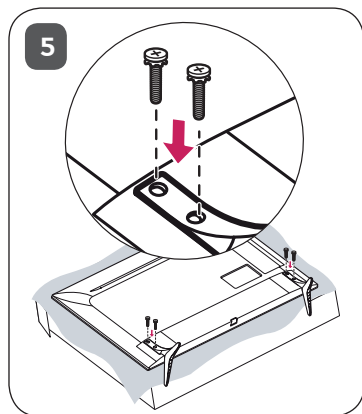
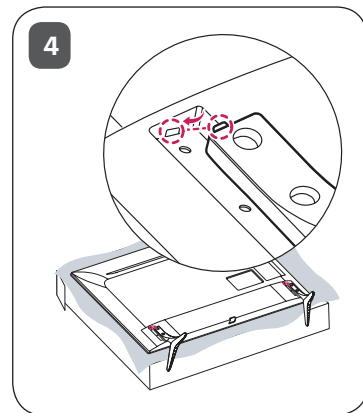
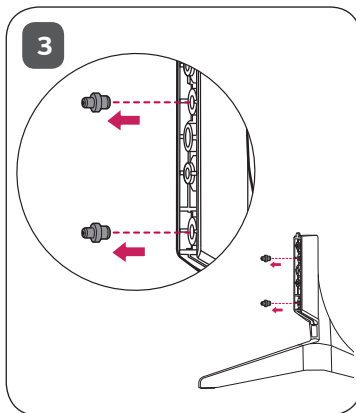
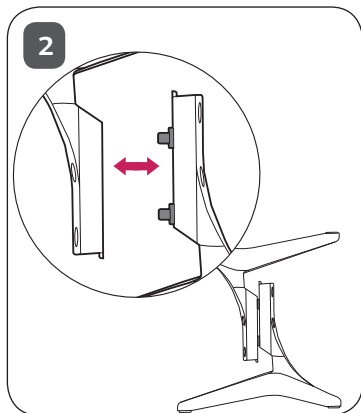
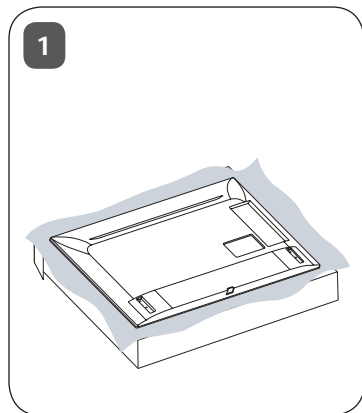



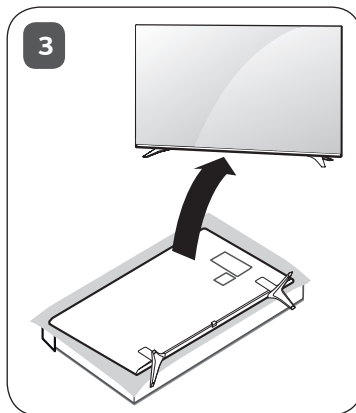
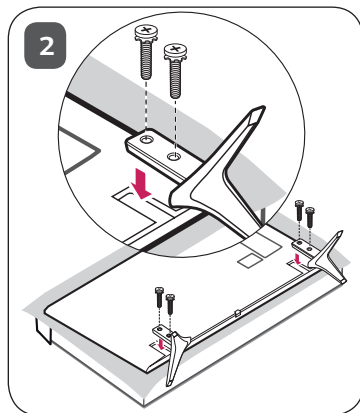
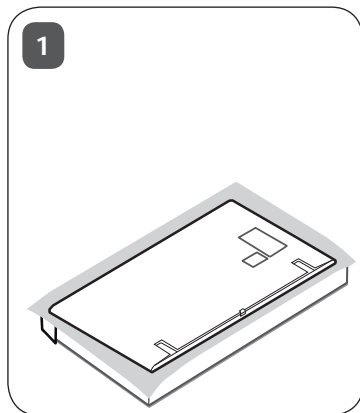



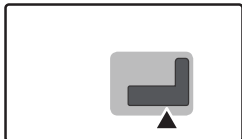









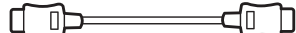

55/60UH6090



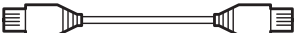
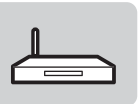



<p>ANTENNA / CABLE IN</p> 	 
<p>HDMI IN</p> 	 
<p>HDMI IN / ARC</p> 	 
<p>USB IN</p> 	 
<p>LAN</p> 	 
<p>OPTICAL DIGITAL AUDIO OUT</p> 	 

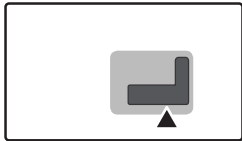

## COMPONENT IN

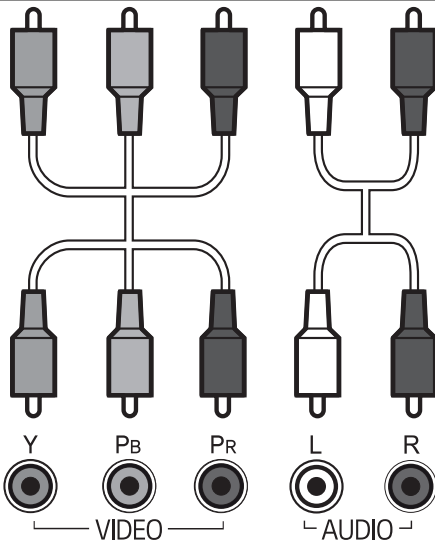
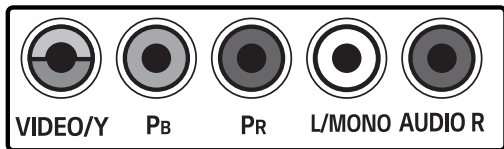

## AV IN

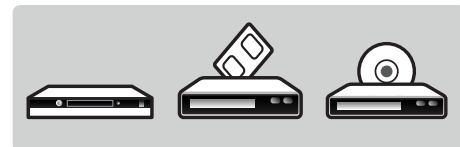
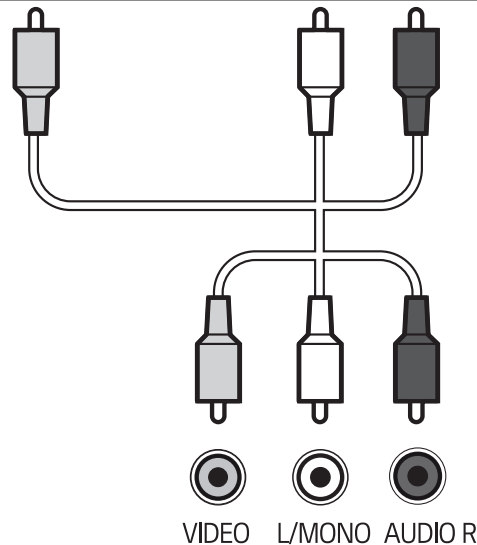
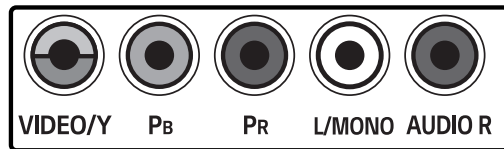

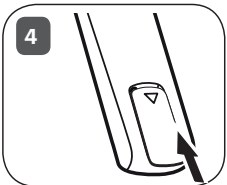
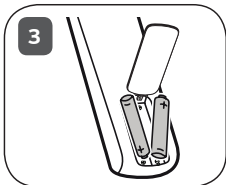
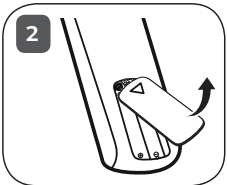
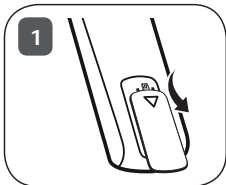
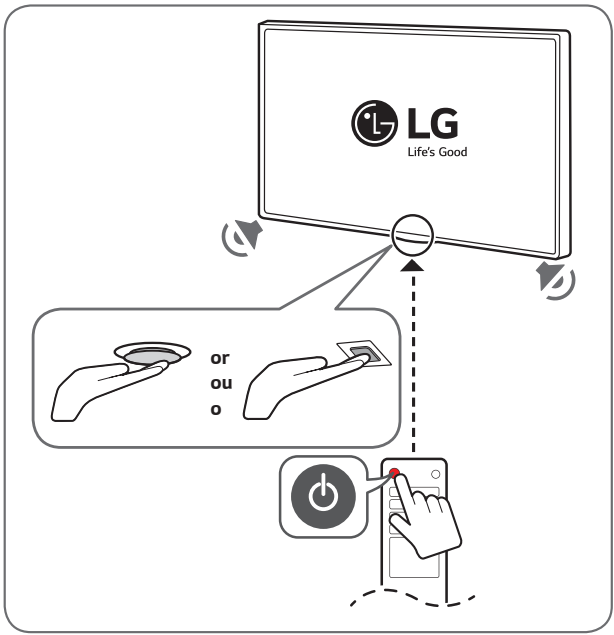
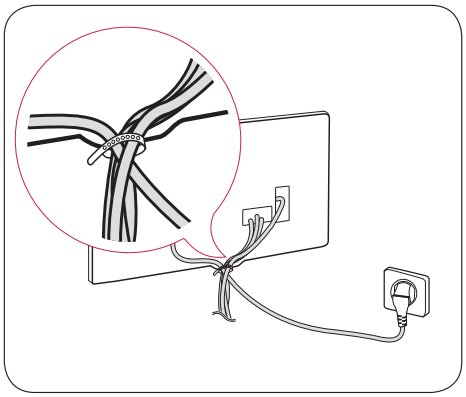



**ENGLISH**

MODELS		43UH6100 (43UH6100-UH)	49UH6100 (49UH6100-UH)	55UH6150 (55UH6150-UB)
		43UH610A (43UH610A-UJ)	49UH610A (49UH610A-UJ)	55UH615A (55UH615A-UC)
		43UH6030 (43UH6030-UB)	49UH6090 (49UH6090-UJ)	55UH6030 (55UH6030-UC)
		43UH6030 (43UH6030-UD)	49UH6030 (49UH6030-UD)	
Dimensions (W x H x D)	With stand	976 x 633 x 217.9 (mm) 38.4 x 24.9 x 8.5 (inches)	1,108 x 707 x 217.9 (mm) 43.6 x 27.8 x 8.5 (inches)	1,240 x 778 x 237 (mm) 48.8 x 30.6 x 9.3 (inches)
	Without stand	976 x 583 x 81.5 (mm) 38.4 x 22.9 x 3.2 (inches)	1,108 x 657 x 81.5 (mm) 43.6 x 25.8 x 3.2 (inches)	1,240 x 722 x 56.7 (mm) 48.8 x 28.4 x 2.2 (inches)
Weight	With stand	9.0 kg (19.8 lbs)	12.0 kg (26.4 lbs)	18.1 kg (39.9 lbs)
	Without stand	8.7 kg (19.1 lbs)	11.7 kg (25.7 lbs)	17.8 kg (39.2 lbs)
Power requirement		AC 100 - 240 V ~ 50 / 60 Hz		
Current value / Power consumption		1.0 A / 100 W	1.1 A / 110 W	1.3 A / 130 W



**ENGLISH**

MODELS		60UH6150 (60UH6150-UB)	65UH6150 (65UH6150-UB)	55UH6090 (55UH6090-UF)	60UH6090 (60UH6090-UF)
		60UH615A (60UH615A-UC)	65UH615A (65UH615A-UC)		
		60UH6030 (60UH6030-UC)	65UH6030 (65UH6030-UC)		
		60UH6035 (60UH6035-UC)			
Dimensions (W x H x D)	With stand	1,348 x 839 x 263 (mm) 53.0 x 33.0 x 10.3 (inches)	1,460 x 902 x 263 (mm) 57.4 x 35.5 x 10.3 (inches)	1,240 x 785 x 231 (mm) 48.8 x 30.9 x 9.0 (inches)	1,348 x 844 x 258 (mm) 53.0 x 33.2 x 10.1 (inches)
	Without stand	1,348 x 782 x 58.5 (mm) 53.0 x 30.7 x 2.3 (inches)	1,460 x 846 x 58.5 (mm) 57.4 x 33.3 x 2.3 (inches)	1,240 x 722 x 56.7 (mm) 48.8 x 28.4 x 2.2 (inches)	1,348 x 782 x 58.5 (mm) 53.0 x 30.7 x 2.3 (inches)
Weight	With stand	23.7 kg (52.2 lbs)	27.4 kg (60.4 lbs)	18.2 kg (40.1 lbs)	23.8 kg (52.4 lbs)
	Without stand	23.3 kg (51.3 lbs)	27.0 kg (59.5 lbs)	17.8 kg (39.2 lbs)	23.3 kg (51.3 lbs)
Power requirement		AC 100 - 240 V ~ 50 / 60 Hz			
Current value / Power consumption		1.4 A / 140 W	1.5 A / 150 W	1.3 A / 130 W	1.4 A / 140 W



**ESPAÑOL**  
**FRANÇAIS**

MODELOS		43UH6100 (43UH6100-UH)	49UH6100 (49UH6100-UH)	55UH6150 (55UH6150-UB)
		43UH610A (43UH610A-UJ)	49UH610A (49UH610A-UJ)	55UH615A (55UH615A-UC)
MODÈLES		43UH6030 (43UH6030-UB)	49UH6090 (49UH6090-UJ)	55UH6030 (55UH6030-UC)
		43UH6030 (43UH6030-UD)	49UH6030 (49UH6030-UB)	
Dimensiones (Ancho x altura x profundidad)	Con base	976 x 633 x 217,9 (mm)	1 108 x 707 x 217,9 (mm)	1 240 x 778 x 237 (mm)
	Avec support	38,4 x 24,9 x 8,5 (pulgadas / pouces)	43,6 x 27,8 x 8,5 (pulgadas / pouces)	48,8 x 30,6 x 9,3 (pulgadas / pouces)
Dimensions (L x H x P)	Sin base	976 x 583 x 81,5 (mm)	1 108 x 657 x 81,5 (mm)	1 240 x 722 x 56,7 (mm)
	Sans support	38,4 x 22,9 x 3,2 (pulgadas / pouces)	43,6 x 25,8 x 3,2 (pulgadas / pouces)	48,8 x 28,4 x 2,2 (pulgadas / pouces)
Peso	Con base	9,0 kg (19,8 libras / lb)	12,0 kg (26,4 libras / lb)	18,1 kg (39,9 libras / lb)
	Avec support			
Poids	Sin base	8,7 kg (19,1 libras / lb)	11,7 kg (25,7 libras / lb)	17,8 kg (39,2 libras / lb)
	Sans support			
Alimentación requerida		AC 100 - 240 V ~ 50 / 60 Hz		
Alimentation				
Corriente de consumo / Consumo de potencia		1,0 A / 100 W	1,1 A / 110 W	1,3 A / 130 W
Valeur courante / Consommation électrique				



**ESPAÑOL**  
**FRAÇAIS**

MODELOS MODÈLES		60UH6150 (60UH6150-UB)	65UH6150 (65UH6150-UB)	55UH6090 (55UH6090-UF)	60UH6090 (60UH6090-UF)
		60UH615A (60UH615A-UC)	65UH615A (65UH615A-UC)		
		60UH6030 (60UH6030-UC)	65UH6030 (65UH6030-UC)		
		60UH6035 (60UH6035-UC)	65UH6030 (65UH6030-UC)		
Dimensiones (Ancho x altura x profundidad)	Con base	1 348 x 839 x 263 (mm) 53,0 x 33,0 x 10,3 (pulgadas / pouces)	1 460 x 902 x 263 (mm) 57,4 x 35,5 x 10,3 (pulgadas / pouces)	1 240 x 785 x 231 (mm) 48,8 x 30,9 x 9,0 (pulgadas / pouces)	1 348 x 844 x 258 (mm) 53,0 x 33,2 x 10,1 (pulgadas / pouces)
	Avec support				
Dimensions (L x H x P)	Sin base	1 348 x 782 x 58,5 (mm) 53,0 x 30,7 x 2,3 (pulgadas / pouces)	1 460 x 846 x 58,5 (mm) 57,4 x 33,3 x 2,3 (pulgadas / pouces)	1 240 x 722 x 56,7 (mm) 48,8 x 28,4 x 2,2 (pulgadas / pouces)	1 348 x 782 x 58,5 (mm) 53,0 x 30,7 x 2,3 (pulgadas / pouces)
	Sans support				
Peso	Con base Avec support	23,7 kg (52,2 libras / lb)	27,4 kg (60,4 libras / lb)	18,2 kg (40,1 libras / lb)	23,8 kg (52,4 libras / lb)
Poids	Sin base Sans support	23,3 kg (51,3 libras / lb)	27,0 kg (59,5 libras / lb)	17,8 kg (39,2 libras / lb)	23,3 kg (51,3 libras / lb)
Alimentación requerida Alimentation	AC 100 - 240 V ~ 50 / 60 Hz				
Corriente de consumo / Consumo de potencia Valeur courante / Consommation électrique	1,4 A / 140 W		1,5 A / 150 W	1,3 A / 130 W	1,4 A / 140 W



(For USA and Canada only)

(Para Estados Unidos y Canadá)

(Except for 43UH610A-UJ, 60UH6035-UC)

This product qualifies for ENERGY STAR®

in the factory default (Home configuration)

setting. Changing the factory default settings or enabling other features may increase power consumption that could exceed the limits necessary to qualify for ENERGY STAR®. Refer to [ENERGYSTAR.gov](http://ENERGYSTAR.gov) for more information on the ENERGY STAR® program.

(Pour les États-Unis et le Canada seulement)



(À l'exception du 43UH610A-UJ,

60UH6035-UC)

Ce produit est conforme aux normes ENERGY

STAR® lorsque le réglage d'usine par défaut

(Résidentiel) est sélectionné. Modifier les réglages

d'usine par défaut ou activer d'autres fonctionnalités

augmente la consommation d'énergie, qui pourrait alors

dépasser les limites de la qualification ENERGY STAR®.

Consultez le site [ENERGYSTAR.gov](http://ENERGYSTAR.gov) pour en savoir plus au

sujet du programme ENERGY STAR®.