



LCD Monitor User Manual

C4008VU8 LED backlight



| | |
|---|----|
| Safety..... | 4 |
| National Conventions..... | 4 |
| Power | 5 |
| Installation..... | 6 |
| Cleaning..... | 7 |
| Other..... | 8 |
| Setup | 9 |
| Contents in Box | 9 |
| Setup Base | 10 |
| Wall Mounting | 11 |
| Adjusting Viewing Angle..... | 12 |
| Connecting the Monitor..... | 13 |
| Adjusting | 14 |
| Setting Optimal Resolution | 14 |
| Windows 10 | 14 |
| Windows 8 | 16 |
| Windows 7 | 18 |
| Hotkeys..... | 20 |
| Using "MHL(Mobile High-Definition Link)"..... | 22 |
| OSD Setting..... | 23 |
| Luminance | 24 |
| Image Setup | 25 |
| Color Setup..... | 26 |
| Picture Boost | 27 |
| OSD Setup | 28 |
| PIP Setting..... | 29 |
| Extra | 30 |
| Exit..... | 31 |
| LED Indicator..... | 32 |
| Driver | 33 |
| Monitor Driver | 33 |
| Windows 10 | 33 |
| Windows 8 | 37 |
| Windows 7 | 41 |
| i-Menu..... | 45 |
| e-Saver | 46 |
| Screen+ | 47 |
| Troubleshoot..... | 48 |
| Specification..... | 50 |
| General Specification | 50 |
| Preset Display Modes..... | 51 |
| Pin Assignments | 52 |
| Plug and Play..... | 54 |
| Regulation..... | 55 |
| FCC Notice | 55 |
| WEEE Declaration | 56 |

| | |
|---|----|
| WEEE Declaration for India | 56 |
| EPA Energy Star | 57 |
| EPEAT Declaration | 57 |
| Service | 58 |
| Warranty Statement for Europe..... | 58 |
| Warranty Statement for Middle East and Africa (MEA) | 60 |
| AOC International (Europe) B.V. | 62 |
| Warranty Statement for North & South America (excluding Brazil) | 63 |
| EASE PROGRAMME | 65 |

Safety

National Conventions

The following subsections describe notational conventions used in this document.

Notes, Cautions, and Warnings

Throughout this guide, blocks of text may be accompanied by an icon and printed in bold type or in italic type. These blocks are notes, cautions, and warnings, and they are used as follows:



NOTE: A NOTE indicates important information that helps you make better use of your computer system.





CAUTION: A CAUTION indicates either potential damage to hardware or loss of data and tells you how to avoid the problem.





WARNING: A WARNING indicates the potential for bodily harm and tells you how to avoid the problem. Some warnings may appear in alternate formats and may be unaccompanied by an icon. In such cases, the specific presentation of the warning is mandated by regulatory authority.

Power

 The monitor should be operated only from the type of power source indicated on the label. If you are not sure of the type of power supplied to your home, consult your dealer or local power company.

 The monitor is equipped with a three-pronged grounded plug, a plug with a third (grounding) pin. This plug will fit only into a grounded power outlet as a safety feature. If your outlet does not accommodate the three-wire plug, have an electrician install the correct outlet, or use an adapter to ground the appliance safely. Do not defeat the safety purpose of the grounded plug.

 Unplug the unit during a lightning storm or when it will not be used for long periods of time. This will protect the monitor from damage due to power surges.

 Do not overload power strips and extension cords. Overloading can result in fire or electric shock.

 The wall socket shall be installed near the equipment and shall be easily accessible.

Installation

! Do not place the monitor on an unstable cart, stand, tripod, bracket, or table. If the monitor falls, it can injure a person and cause serious damage to this product. Use only a cart, stand, tripod, bracket, or table recommended by the manufacturer or sold with this product. Follow the manufacturer's instructions when installing the product and use mounting accessories recommended by the manufacturer. A product and cart combination should be moved with care.

! Never push any object into the slot on the monitor cabinet. It could damage circuit parts causing a fire or electric shock. Never spill liquids on the monitor.

! Do not place the front of the product on the floor.

! If you mount the monitor on a wall or shelf, use a mounting kit approved by the manufacturer and follow the kit instructions.

! Leave some space around the monitor as shown below. Otherwise, air-circulation may be inadequate hence overheating may cause a fire or damage to the monitor.

See below the recommended ventilation areas around the monitor when the monitor is installed on the wall or with the stand:

Installed on the wall

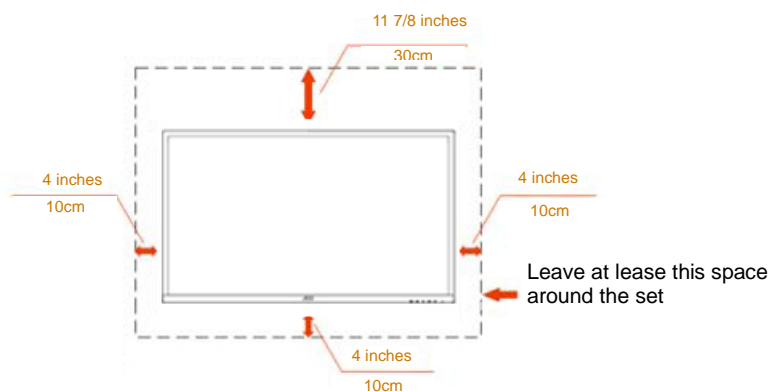

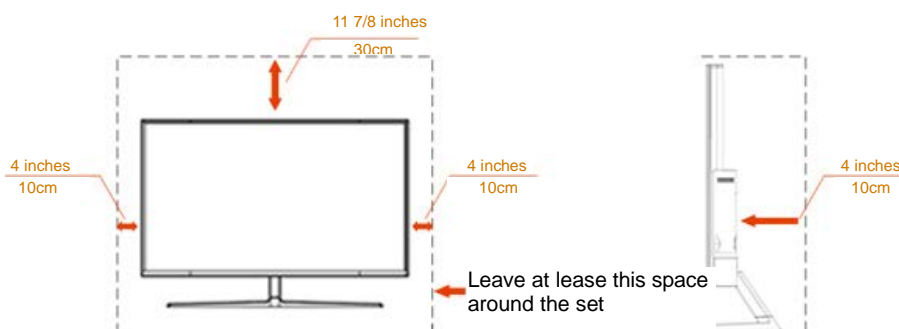

Installed with stand



Cleaning

 Clean the cabinet regularly with cloth. You can use soft-detergent to wipe out the stain, instead of strong-detergent which will cauterize the product cabinet.

 When cleaning, make sure no detergent is leaked into the product. The cleaning cloth should not be too rough as it will scratch the screen surface.

 Please disconnect the power cord before cleaning the product.



Other

 If the product is emitting a strange smell, sound or smoke, disconnect the power plug IMMEDIATELY and contact a Service Center.

 Make sure that the ventilating openings are not blocked by a table or curtain.

 Do not engage the LCD monitor in severe vibration or high impact conditions during operation.

 Do not knock or drop the monitor during operation or transportation.

 For display with glossy bezel the user should consider the placement of the display as the bezel may cause disturbing reflections from surrounding light and bright surfaces.

Setup

Contents in Box



Monitor



CD Manual



Base



Power Cable

*



Audio

*



Analog Cable

*



DP

*



HDMI

*



USB

*



MHL

* Not all signal cables (Audio, Analog, DP, HDMI, MHL and USB cables) will be provided for all countries and regions. Please check with the local dealer or AOC branch office for confirmation.

Setup Base

Please setup or remove the base following the steps as below.

Please place the monitor on a soft and flat surface to prevent the scratch.

Setup:

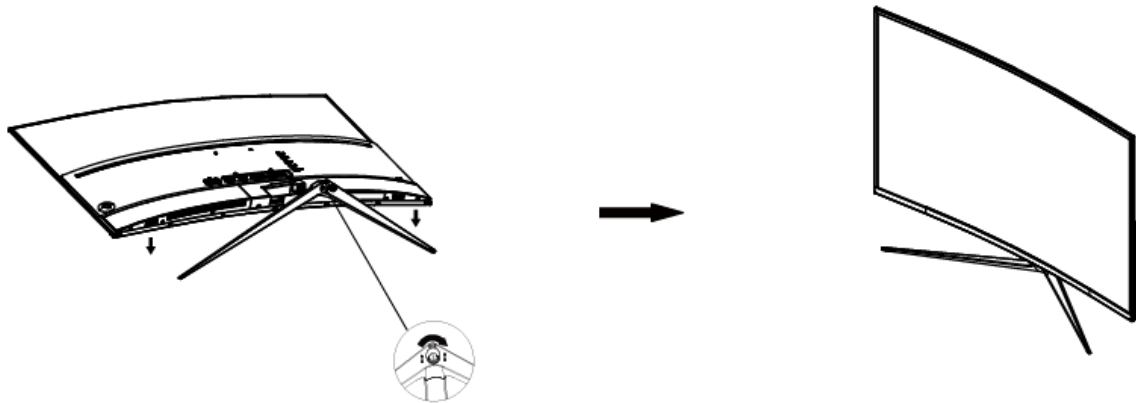

Remove:

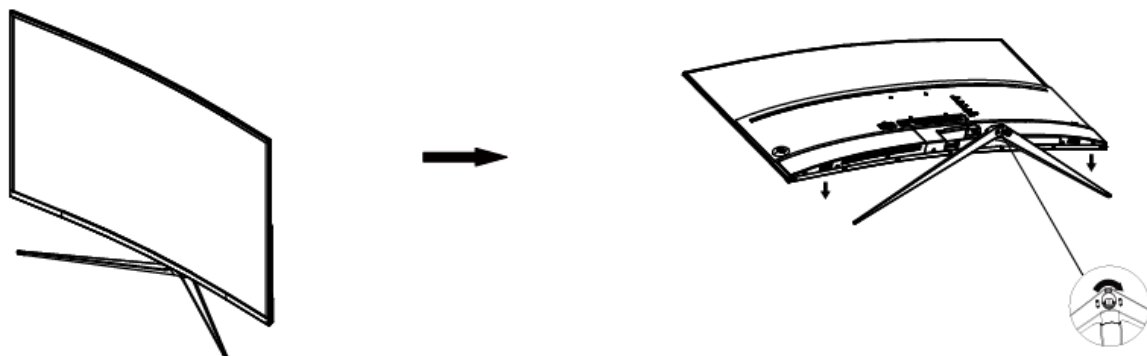

Wall Mounting

Preparing to install an optional wall mount arm.

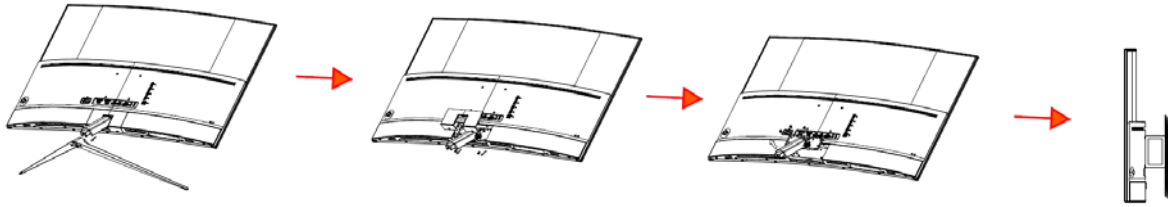

This monitor can be attached to a wall mounting arm you purchase separately. Disconnect power before this procedure. Follow these steps:

1. Remove the base.
2. Follow the manufacturer's instructions to assemble the wall mounting arm.
3. Place the wall mounting arm onto the back of the monitor. Line up the holes of the arm with the holes in the back of the monitor.
4. Insert the 4 screws into the holes and tighten.
5. Reconnect the cables. Refer to the user's manual that came with the optional wall mounting arm for instructions on attaching it to the wall.

Noted: VESA mounting screw holes are not available for all models, please check with the dealer or official department of AOC.

Adjusting Viewing Angle

For optimal viewing, it is recommended to look at the full face of the monitor, and then adjust the monitor's angle to your own preference.

Hold the stand so you will not topple the monitor when you change the monitor's angle.

You are able to adjust the monitor's angle from -6.5° to 15° .

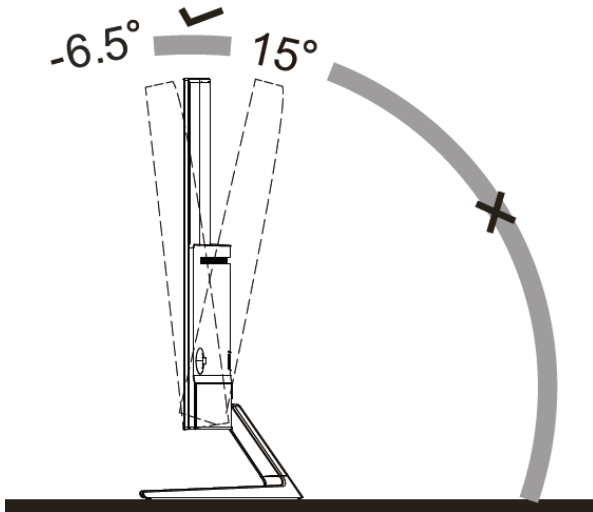

NOTE:

Do not adjust the viewing angle over 15 degrees in order to avoid damage.

Connecting the Monitor

Cable Connections In Back of Monitor and Computer:

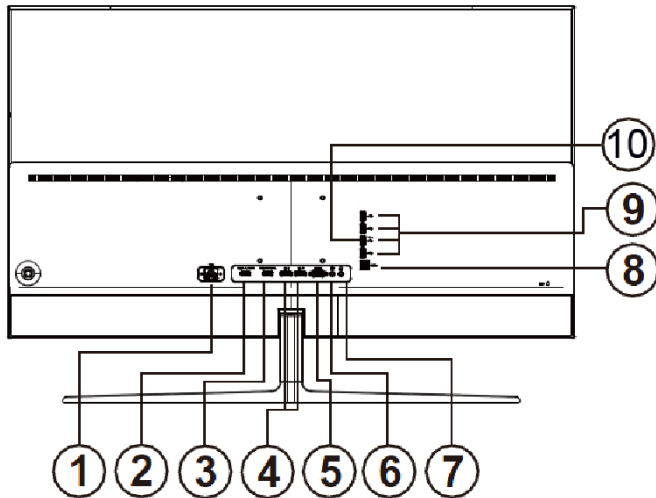

- 1 Power
- 2 HDMI1.4b/MHL
- 3 HDMI2.0/MHL
- 4 DisplayPortx2
- 5 D-SUB
- 6 AUDIO IN
- 7 Earphone out
- 8 USB-PC(USB3.0 upstream)
- 9 USB 3.0x4
- 10 USB3.0+ charger function

To protect equipment, always turn off the PC and LCD monitor before connecting.

- 1 Connect the power cable to the AC port on the back of the monitor.
- 2 Connect one end of the 15-pin D-Sub cable to the back of the monitor and connect the other end to the computer's D-Sub port.
- 3 Optional – (Requires a video card with HDMI port) – Connect one end of the HDMI cable to the back of the monitor and connect the other end to the computer's HDMI port.
- 4 Optional – (Requires a video card with DP port) – Connect one end of the DP cable to the back of the monitor and connect the other end to the computer's DP port.
- 5 Turn on your monitor and computer.
- 6 Video content supporting resolution (Maximum):
 - (1) VGA/MHL: 1920 x 1080/60Hz
 - (2) HDMI1.4: 3840 x 2160/30Hz; HDMI2.0: 3840 x 2160/60Hz
 - (3) DP1.1: 3840 x 2160/30Hz; DP1.2: 3840 x 2160/60Hz

If your monitor displays an image, installation is complete. If it does not display an image, please refer Troubleshooting.

Adjusting

Setting Optimal Resolution

Windows 10

For Windows 10:

- Right click **START**.
- Click "**CONTROL PANEL**".

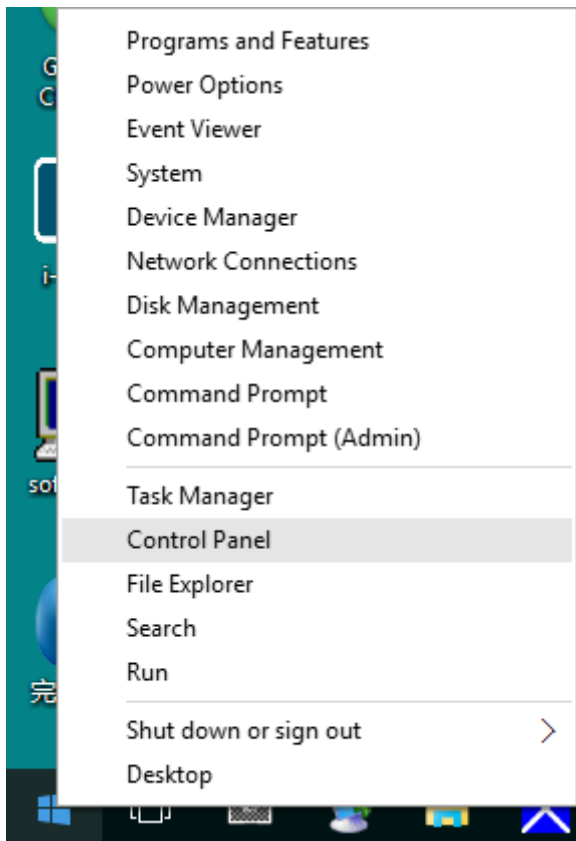

- Click "**DISPLAY**".

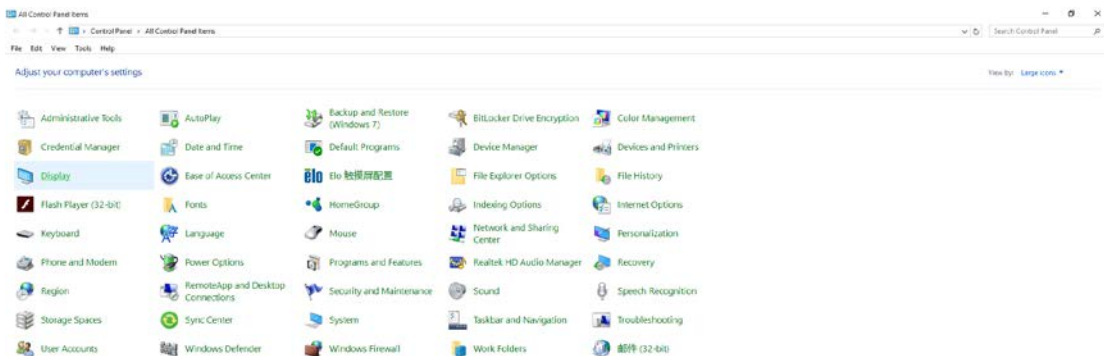

- Click on the "Change display settings" button.

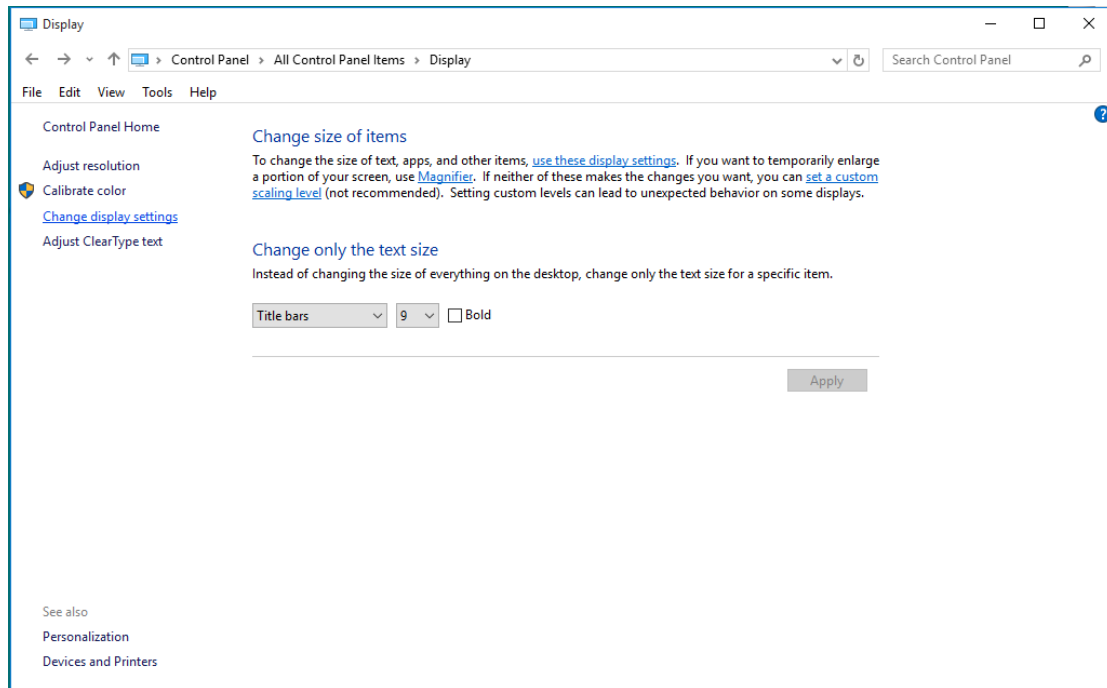

- Set the resolution **SLIDE-BAR** to Optimal preset resolution.

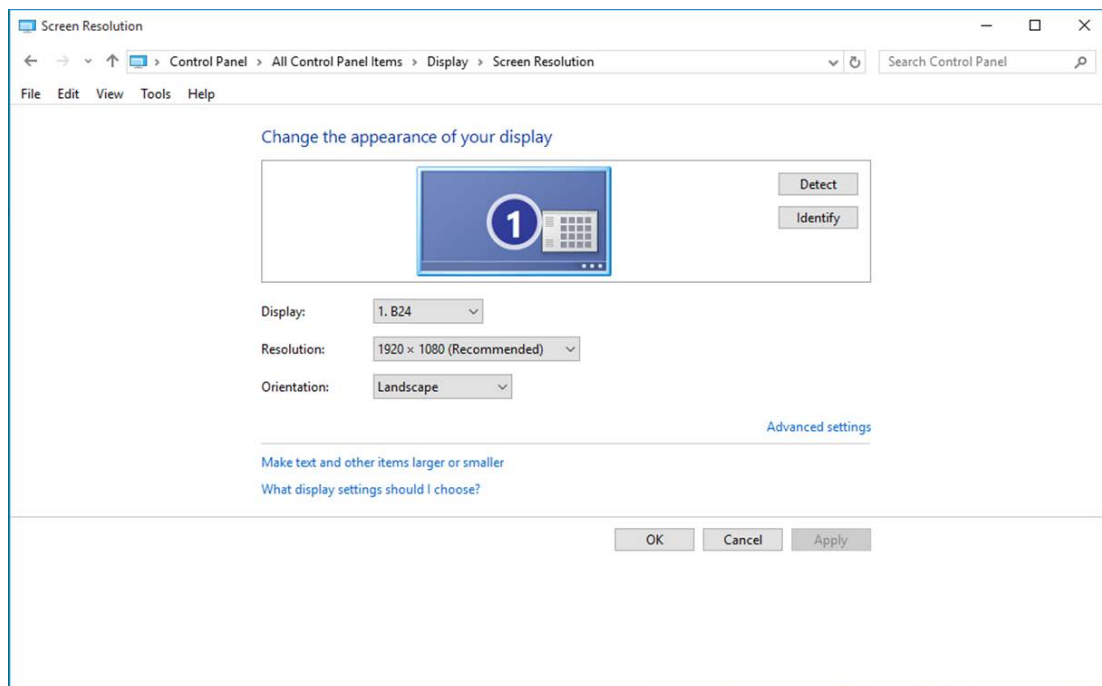

Windows 8

For Windows 8:

- Right click and click **All apps** at the bottom-right of the screen.

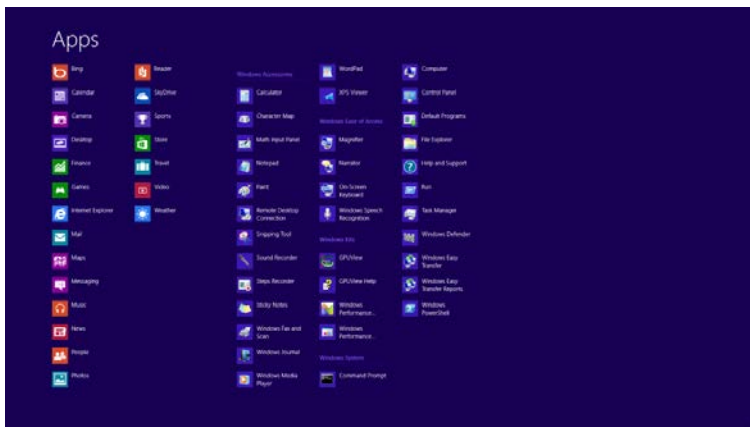
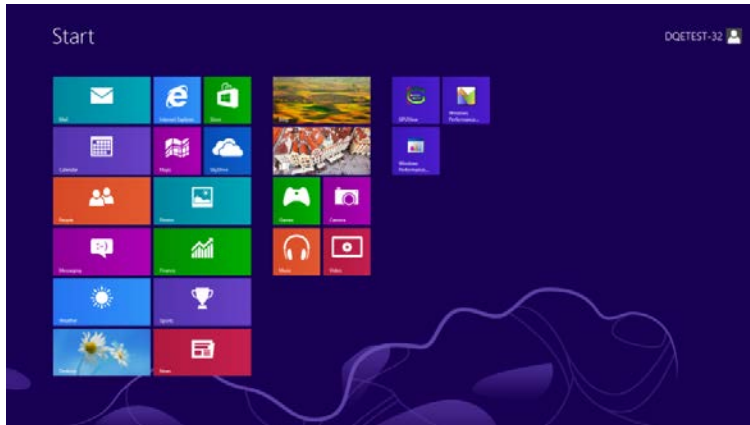

- Set the "View by" to "Category".
- Click "Appearance and Personalization".

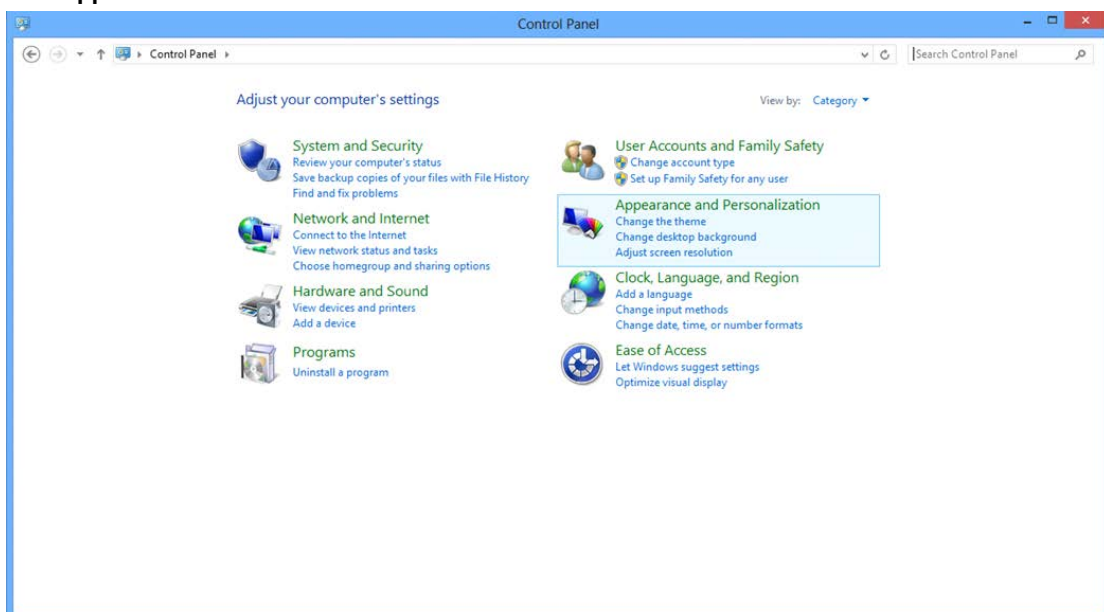

- Click "**DISPLAY**".

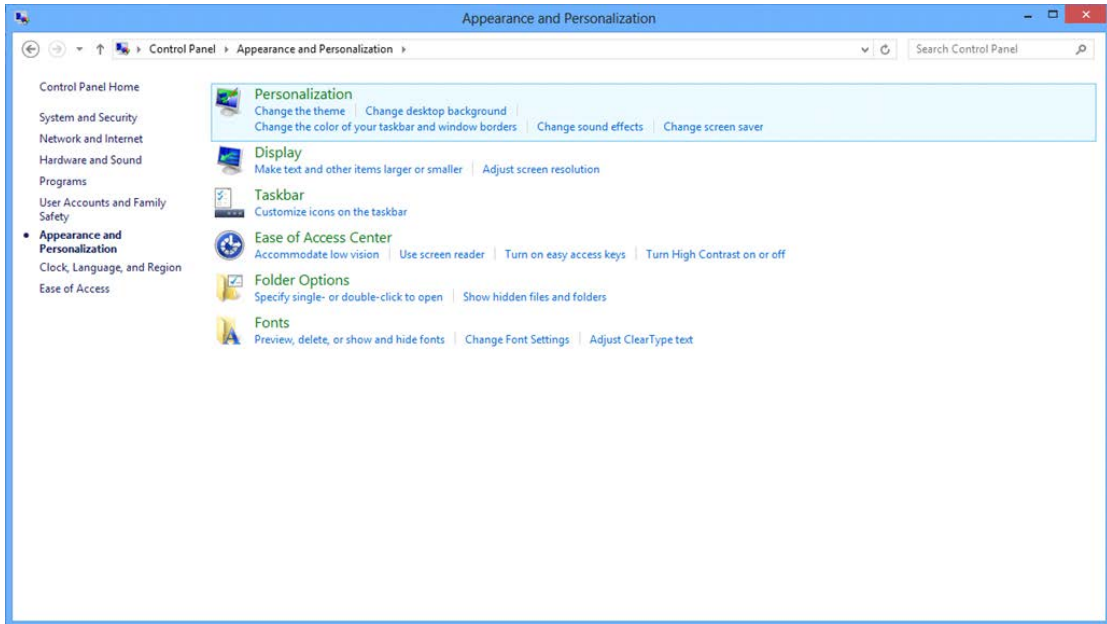

- Set the resolution **SLIDE-BAR** to Optimal preset resolution

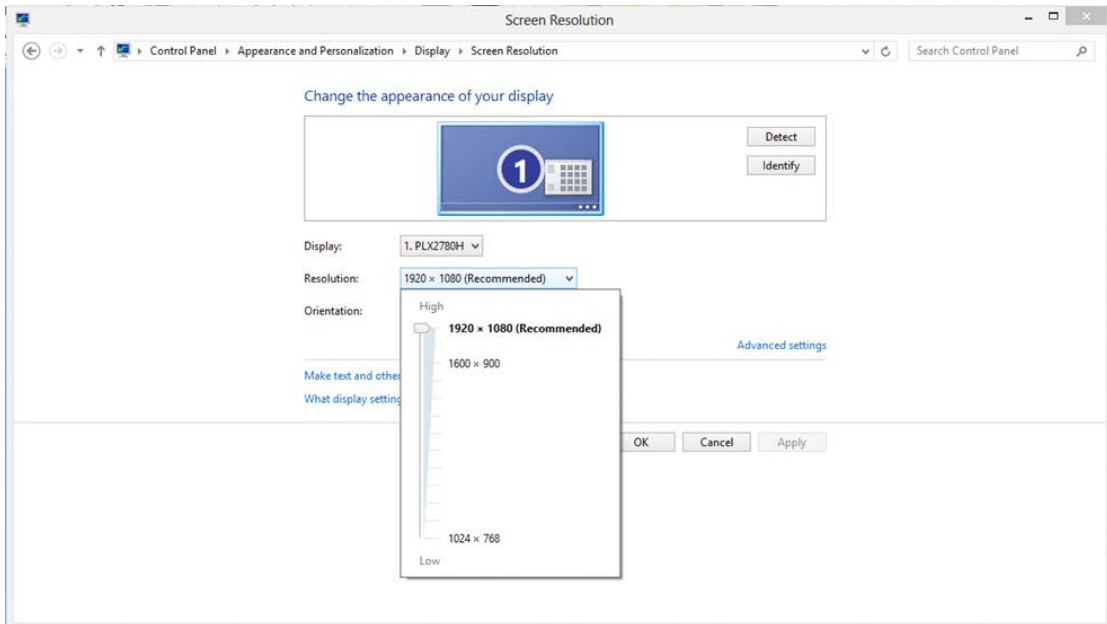

Windows 7

For Windows 7:

- Click **START**.
- Click **"CONTROL PANEL"**.

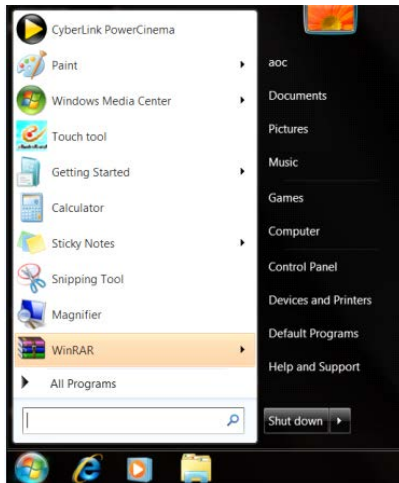

- Click **"Appearance"**.

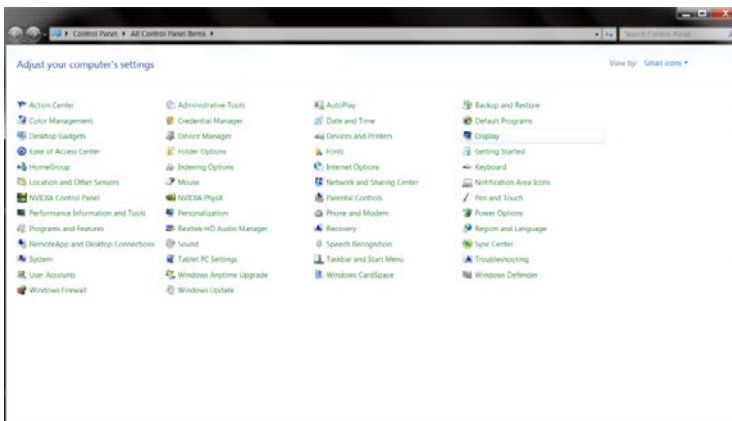

- Click **"DISPLAY"**.

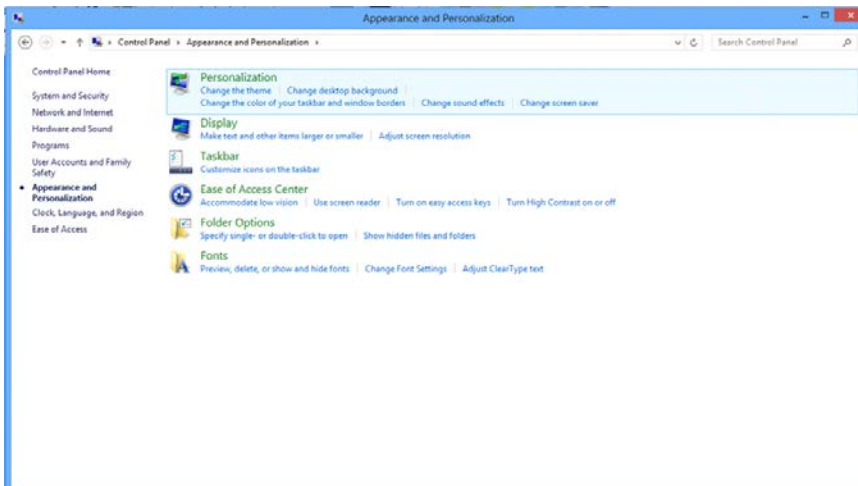

- Click on the "**Change display settings**" button.

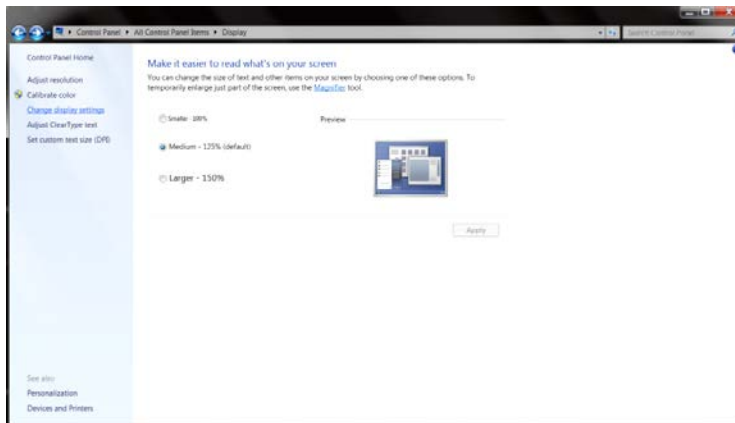

- Set the resolution **SLIDE-BAR** to Optimal preset resolution

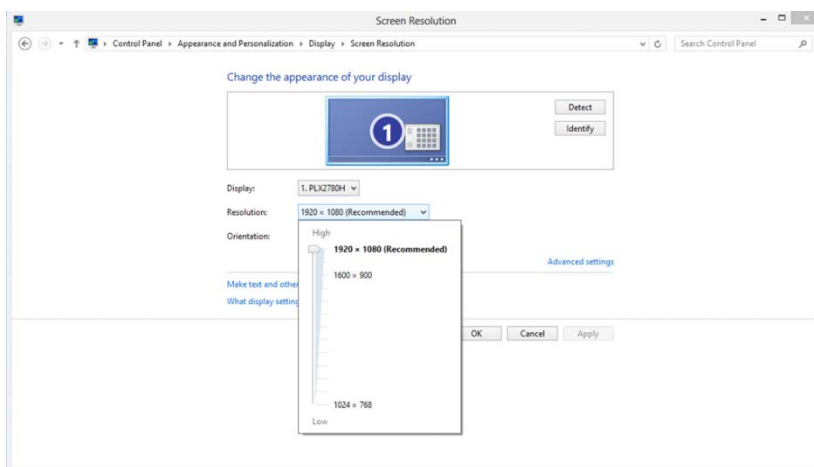

Hotkeys

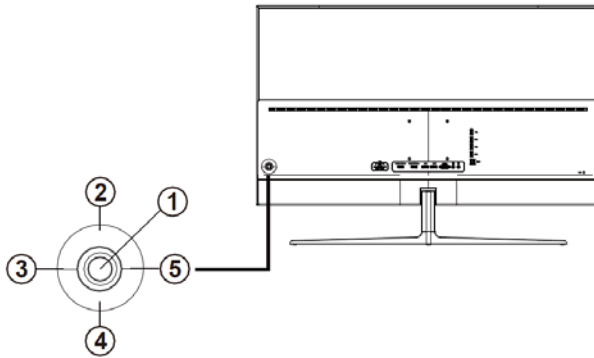

| | |
|---|---------------------|
| 1 | Power/MENU/Enter |
| 2 | Source/Auto/Exit/Up |
| 3 | Volume/Right |
| 4 | ECO Mode/DCR/Down |
| 5 | Clear Vision/Left |

Power/MENU/Enter

when monitor is off mode, press the Power button to turn on the monitor.

when monitor is on mode, press to display the OSD or confirm the selection.

when there is no OSD,press the Power button continuously about 2 seconds to turn off the monitor.

Source hotkey/Auto/Exit/Up

When there is no OSD in D-SUB input, press Up continuously about 2 seconds to do auto configure.

When there is no OSD,press Up will be source hot key function. Press Source button continuously to select the input source showed in the message bar, press Menu/Enter button to change to the source selected.

When there is OSD, press UP button to exit OSD.

Volume/Right

When there is no OSD, press Right to adjust volume.

ECO Mode/DCR/Down

When there is no OSD, press Down to adjust ECO mode/DCR.

Clear Vision

1. When there is no OSD, Press the “Left” button to activate Clear Vision.
2. Use the “Left” or “Right” buttons to select between weak, medium, strong, or off settings. Default setting is always “off”.

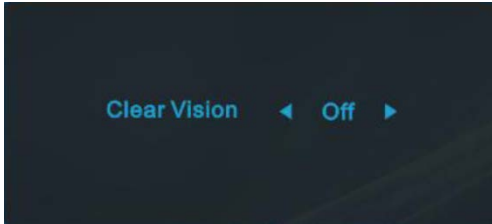

3. Press and hold “Left” button for 5 seconds to activate the Clear Vision Demo, and a message of “Clear Vision Demo: on” will be display on the screen for a duration of 5 seconds. Press Menu or Exit button, the message will disappear. Press and hold “Left” button for 5 seconds again, Clear Vision Demo will be off.

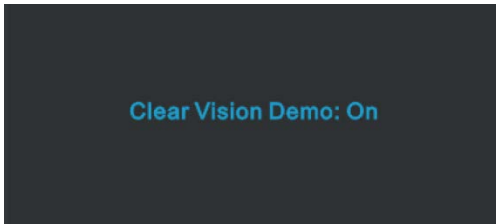

Clear Vision function provides the best image viewing experience by converting low resolution and blurry images into clear and vivid images.

Using "MHL(Mobile High-Definition Link)"

1."MHL" (Mobile High-Definition Link)

This feature allows you to enjoy videos and photos (imported from a connected mobile device that supports MHL) on the screen of the product.

- To use the MHL function, you need an MHL-certified mobile device. You can check if your mobile device is MHL certified on the device manufacturer's website. To find a list of MHL-certified devices, visit the official MHL website (<http://www.mhlconsortium.org>).
- To use the MHL function, the latest version of software must be installed on the mobile device.
- On some mobile devices, the MHL function may not be available depending on the device's performance or functionality.
- Since the display size of the product is larger than those of mobile devices, the picture quality may degrade.
- This product is officially MHL-certified. If you encounter any problem when using the MHL function, please contact the manufacturer of the mobile device.
- The picture quality may degrade when content (imported from the mobile device) with a low Resolution is played on the product.

Using "MHL"

1. Connect the micro USB port on the mobile device to the [HDMI / MHL] port on the product using the MHL cable.

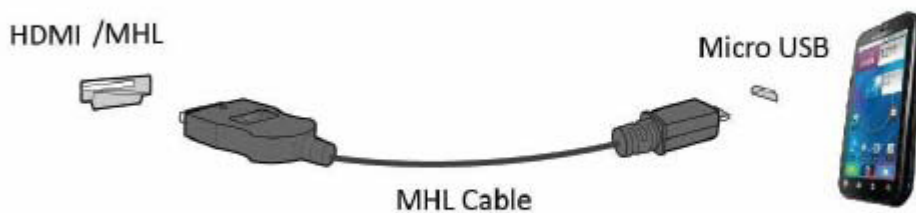

- When the MHL cable is used, [HDMI / MHL] is the only port on this monitor that supports the MHL function.
 - Mobile device must be purchased separately.
2. Connect the AC power cord to the product and a power outlet.
 3. Press the source button  and switch to HDMI /MHL to activate MHL mode.
 4. After about 3 seconds, the MHL screen will be displayed if MHL mode is active.

Remark: The indicated time "3 sec later" may vary depending on the mobile device.

When the mobile device is not connected or does not support MHL

- If MHL mode is not activated even though the mobile device supports MHL, check if mobile device MHL port is MHL standard port otherwise an additional MHL-enabled adapter is required.

OSD Setting

Basic and simple instruction on the control keys.



1. Press the **MENU-button** to activate the OSD window.
2. Press **Left or Right** to navigate through the functions. Once the desired function is highlighted, press the **MENU-button** to activate it. If there is a sub-menu, press **Left or Right** to navigate through the sub-menu functions.
3. Press **Left or Right** to change the settings of the selected function. Press **AUTO** to exit. If you want to adjust any other function, repeat steps 2-3.
4. OSD Lock Function: To lock and un-lock the OSD, press and hold the Down button continuously 10seconds.

Notes:

1. If the product has only one signal input, the item of "Input Select" is disabled.
2. If the product screen size is 4:3 or input signal resolution is native resolution, the item of "Image Ratio" is disabled.
3. One of Clear vision, DCR, Color Boost, and Picture Boost functions is activated; the other three functions are turned off accordingly.

Luminance



1 Press **MENU** (Menu) to display menu.

2 Press **Left** or **Right** to select  (Luminance), and press **MENU** to enter.

3 Press **Left** or **Right** to select submenu.

4 Press **Left** or **Right** to adjust.

5 Press **AUTO** to exit.







| | | | | |
|---|------------|------------|---|---------------------------------|
|  | Contrast | 0-100 | | Contrast from Digital-register. |
| | Brightness | 0-100 | | Backlight Adjustment |
| | Eco mode | Standard | <input checked="" type="checkbox"/> | Standard Mode |
| | | Text |  | Text Mode |
| | | Internet |  | Internet Mode |
| | | Game |  | Game Mode |
| | | Movie |  | Movie Mode |
| | | Sports |  | Sports Mode |
| | | Uniformity | | Uniformity Mode |
| | Gamma | Gamma1 | Adjust to Gamma 1 | |
| | | Gamma2 | Adjust to Gamma 2 | |
| | | Gamma3 | Adjust to Gamma 3 | |
| | DCR | Off | | Disable dynamic contrast ratio |
| | | On |  | Enable dynamic contrast ratio |
| | Over Drive | Weak | Adjust the response time. | |
| Medium | | | | |
| Strong | | | | |
| Off | | | | |

Image Setup



1 Press **MENU** (Menu) to display menu.

2 Press **Left** or **Right** to select  (Image Setup), and press **MENU** to enter.

3 Press **Left** or **Right** to select submenu.

4 Press **Left** or **Right** to adjust.

5 Press **AUTO** to exit.

| | | | |
|--|------------|-------|---|
|  | Clock | 0-100 | Adjust picture Clock to reduce Vertical-Line noise. |
| | Phase | 0-100 | Adjust Picture Phase to reduce Horizontal-Line noise. |
| | Sharpness | 0-100 | Adjust picture sharpness. |
| | H.Position | 0-100 | Adjust the horizontal position of the picture. |
| | V.Position | 0-100 | Adjust the vertical position of the picture. |

Color Setup



1 Press **MENU** (Menu) to display menu.

2 Press **Left** or **Right** to select  (Color Setup), and press **MENU** to enter.

3 Press **Left** or **Right** to select submenu.

4 Press **Left** or **Right** to adjust.

5 Press **AUTO** to exit.

| | | | | |
|---|-------------|----------------------------|--|--|
|  | Color Temp. | Warm | | Recall Warm Color Temperature from EEPROM. |
| | | Normal | | Recall Normal Color Temperature from EEPROM. |
| | | Cool | | Recall Cool Color Temperature from EEPROM. |
| | | sRGB | | Recall SRGB Color Temperature from EEPROM. |
| | | User | | Recall User Color Temperature from EEPROM |
| | DCB Mode | Full Enhance | ON/OFF | Disable or Enable Full Enhance Mode. |
| | | Nature Skin | ON/OFF | Disable or Enable Nature Skin Mode. |
| | | Green Field | ON/OFF | Disable or Enable Green Field Mode. |
| | | Sky-blue | ON/OFF | Disable or Enable Sky-blue Mode. |
| | | AutoDetect | ON/OFF | Disable or Enable AutoDetect Mode. |
| | DCB Demo | | ON/OFF | Disable or Enable Demo. |
| | Red | | 0-100 | Red gain from Digital-register. |
| | Green | | 0-100 | Green gain from Digital-register. |
| | Blue | | 0-100 | Blue gain from Digital-register. |
| Low Blue Light | | Off/Weak/ Medium/Strong | Decrease blue light wave by controlling color temperature. | |

Picture Boost

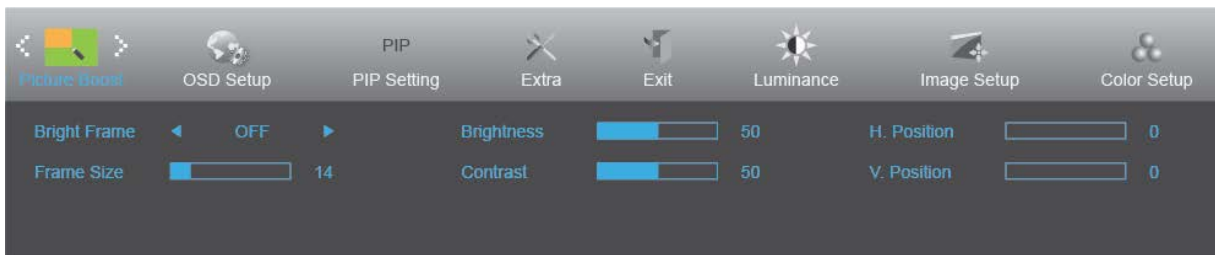

1 Press **MENU** (Menu) to display menu.

2 Press **Left** or **Right** to select  (Picture Boost), and press **MENU** to enter.

3 Press **Left** or **Right** to select submenu.

4 Press **Left** or **Right** to adjust.

5 Press **AUTO** to exit.

| | | | |
|--|--------------|--------|---|
|  | Bright Frame | ON/OFF | Enable/Disable Bright Frame |
| | Frame Size | 14-100 | Adjust the Size of the Frame |
| | Brightness | 0-100 | Brightness Adjustment for Enhance Area |
| | Contrast | 0-100 | Contrast Adjustment for Enhance Area |
| | H. position | 0-100 | Adjust the horizontal position of the Frame |
| | V. position | 0-100 | Adjust the vertical position of the Frame |

Note:

Adjust the brightness, contrast, and position of the Bright Frame for better viewing experience.

OSD Setup

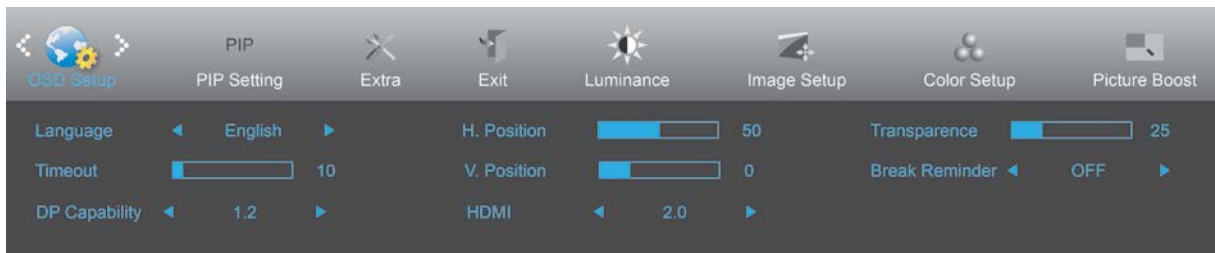

1 Press **MENU** (Menu) to display menu.

2 Press **Left** or **Right** to select  (OSD Setup), and press **MENU** to enter.

3 Press **Left** or **Right** to select submenu.

4 Press **Left** or **Right** to adjust.

5 Press **AUTO** to exit.

| | | | |
|---|----------------|--|--|
|  | Language | English, France , Spanish, Portugues,German, Italian,Dutch,Swedish, Finnish, Polish ,Czech, Russia,Korea, TChina, SChina,Japanese. | Select the OSD language |
| | Timeout | 5-120 | Adjust the OSD timeout. |
| | H. Position | 0-100 | Adjust the horizontal position of the OSD. |
| | V. Position | 0-100 | Adjust the vertical position of the OSD. |
| | Transparence | 0-100 | Adjust the OSD |
| | Break Reminder | ON/OFF | Break Reminder if the user continually work for mare than 1 hurs |
| | DP Capability | 1.1/1.2 | If the DP video content supports DP1.2, please select DP1.2 for DP Capability; otherwise, please select DP1.1. |
| | HDMI | 1.4/2.0 | The factory default setting is at HDMI 2.0.But HDMI 1.4 supports most Blu-Ray/DVD players on the market. |

PIP Setting



- 1 Press **MENU** (Menu) to display menu.
- 2 Press **Left** or **Right** to select **PIP**, and press **MENU** to enter.
- 3 Press **Left** or **Right** to select submenu.
- 4 Press **Left** or **Right** to adjust.
- 5 Press **AUTO** to exit.

| | | | |
|------------|-----------------|---------------------------|--------------------------------|
| PIP | PIP | OFF / PIP / PBP | Disable or Enable PIP or PBP. |
| | Main Source | D-SUB/DVI/HDMI/MHL/D P | Select main screen source. |
| | Sub Source | D-SUB/DVI/HDMI/MHL/D P | Select sub screen source. |
| | Size | Small / Middle / Large | Select screen size. |
| | Position | Right-up | Set the screen location. |
| | | Right-down | |
| | | Left-up | |
| | | Left-down | |
| | Audio | On: PIP Audio | Disable or Enable Audio Setup. |
| | | Off: Main Audio | |
| Swap | On: Swap | Swap the screen source. | |
| | Off: non action | | |

Please refer below table for compatibility of main/sub input source.

| PIP | | Main Source | | | |
|------------|----------|-------------|-----|----------|----|
| | | D-sub | DVI | HDMI/MHL | DP |
| SUB Source | D-sub | ∨ | ∨ | ∨ | ∨ |
| | DVI | ∨ | ∨ | ∨ | ∨ |
| | HDMI/MHL | ∨ | ∨ | ∨ | ∨ |
| | DP | ∨ | ∨ | ∨ | ∨ |

| PBP | | Main Source | | | |
|------------|----------|-------------|-----|----------|----|
| | | D-sub | DVI | HDMI/MHL | DP |
| SUB Source | D-sub | ∨ | ∨ | ∨ | ∨ |
| | DVI | ∨ | ∨ | ∨ | ∨ |
| | HDMI/MHL | ∨ | ∨ | ∨ | ∨ |
| | DP | ∨ | ∨ | ∨ | ∨ |

Extra

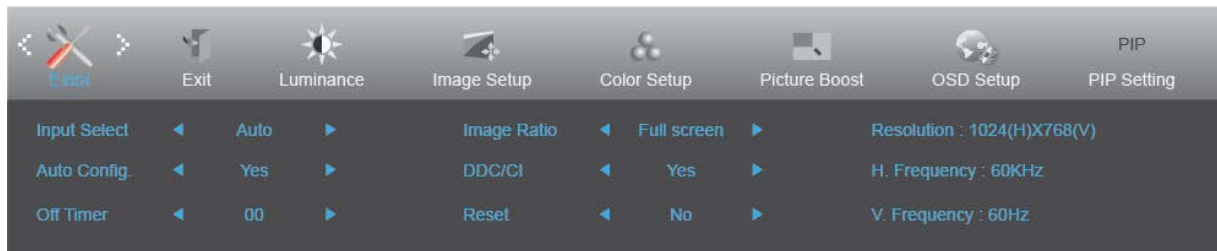

1 Press **MENU** (Menu) to display menu.

2 Press **Left** or **Right** to select  (Extra), and press **MENU** to enter.

3 Press **Left** or **Right** to select submenu.

4 Press **Left** or **Right** to adjust.

5 Press **AUTO** to exit.

| | | | |
|---|--------------|--------------------------------|--|
|  | Input Select | Auto | Auto Detect input signal |
| | | D-SUB | Select D-SUB signal source as input |
| | | DVI | Select DVI signal source as input |
| | | HDMI/MHL | Select HDMI/MHL signal Source as input |
| | | DP | Select DP signal Source as input |
| | Auto Config. | Yes / No | Auto adjust the picture to default. |
| | Off Timer | 0-24 hrs | Select DC off time. |
| | Image Ratio | Wide | 16:9 or 16:10 |
| | | 4:3 | 4:3 or 5:4 |
| | | Movie 1 | over scan: Top 9% ; Down 9% |
| | Movie 2 | over scan: Top 9% ; Down 17%. | |
| | 1:1 | Native resolution | |
| DDC/CI | Yes / No | Turn on or off DDC/CI Support. | |
| Reset | Yes / No | Reset the menu to default. | |

Notes:

1. If the DP video content supports DP1.2, please select DP1.2 for DP Capability; otherwise, please select DP1.1.
2. movie1 and movie2 only support digital source.
3. Image Ratio and PIP/PBP can be only one.
4. movie1 and movie2 only support Video Timing(example:480I,480P,576I,576P,720P,1080i,1080P)

Exit

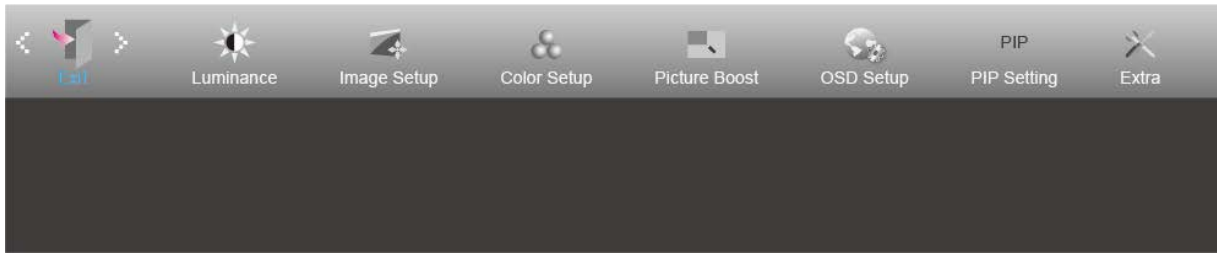

1 Press **MENU** (Menu) to display menu.

2 Press **Left** or **Right** to select  (Exit), and press **MENU** to enter.

3 Press **AUTO** to exit.

LED Indicator

| Status | LED Color |
|-----------------|-----------|
| Full Power Mode | White |
| Power Saving | Yellow |

Driver

Monitor Driver

Windows 10

- Start Windows® 10
- Right click **START**.
- Click "**Control Panel**".

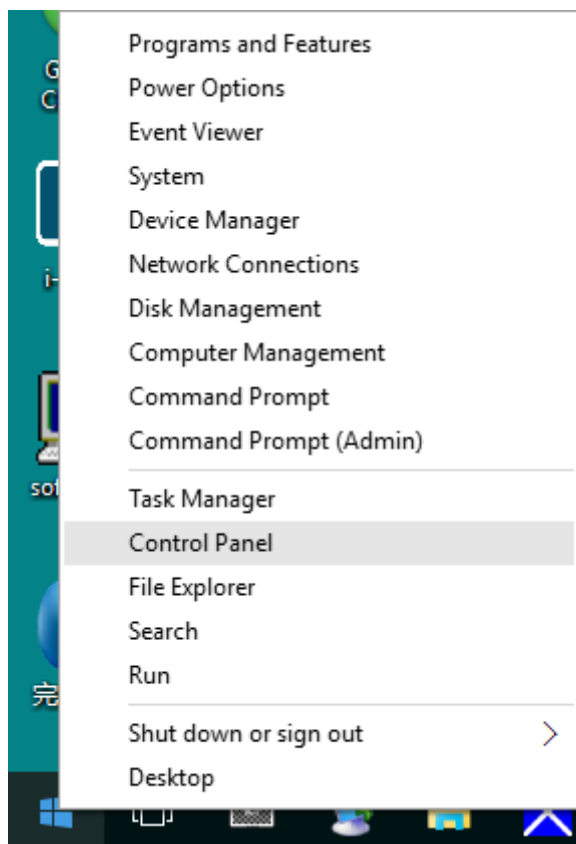

- Click on the "Display" icon.

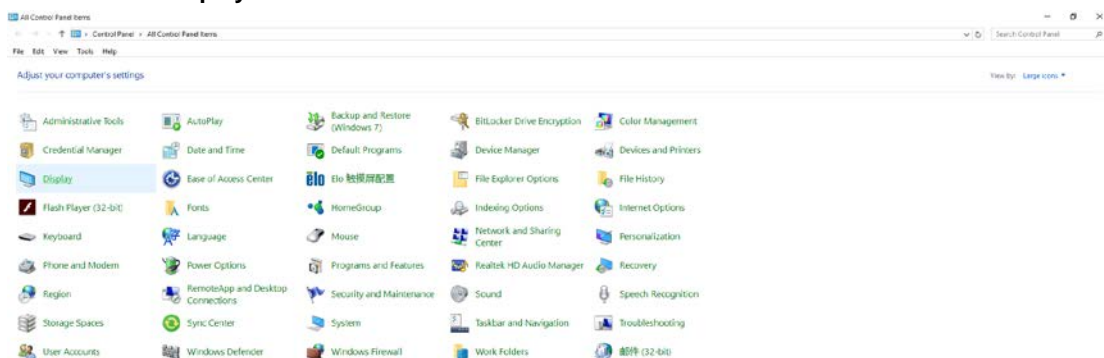

- Click on the **"Change display settings"** button

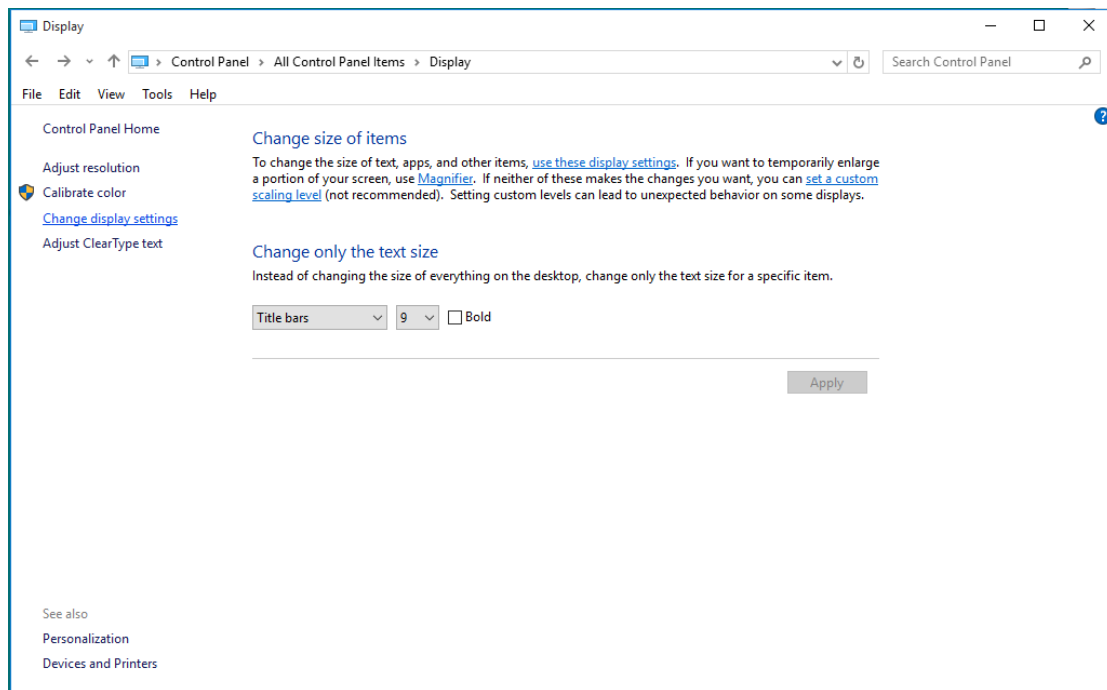

- Click the **"Advanced Settings"** button.

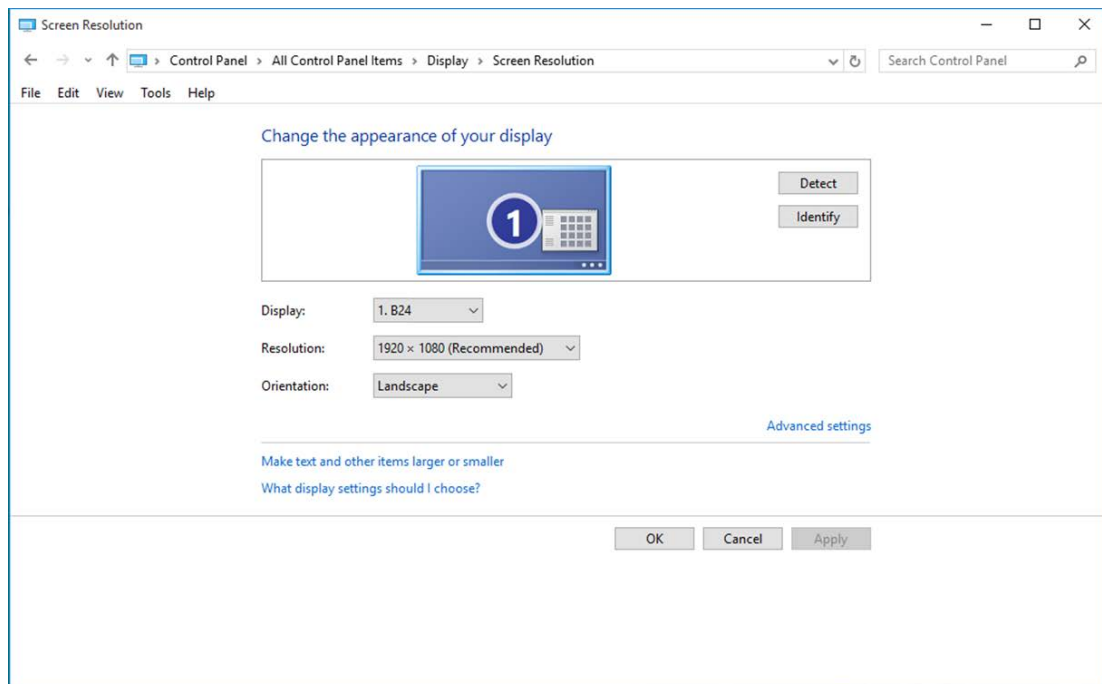

- Click the **"Monitor"** tab and then click the **"Properties"** button.

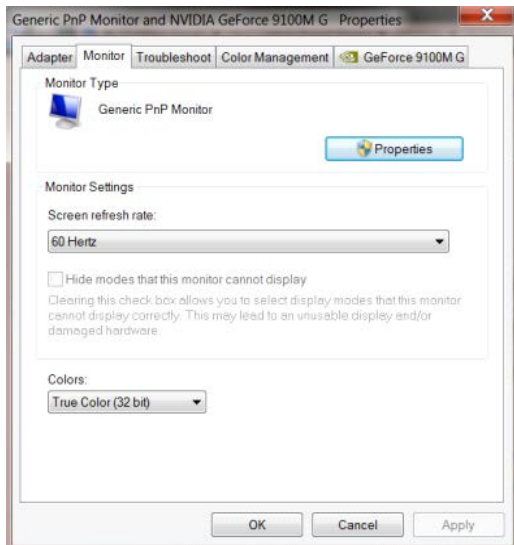

- Click the **"Driver"** tab.

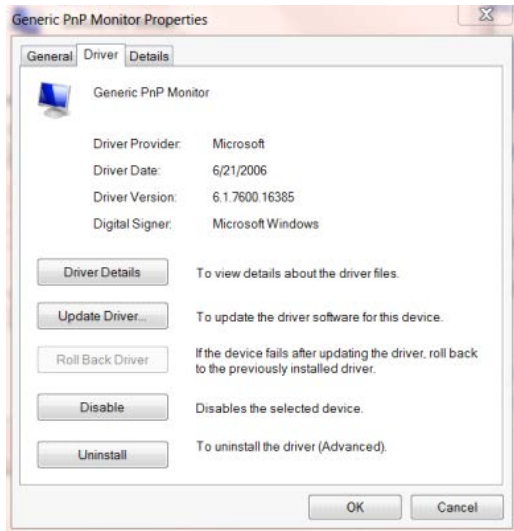

- Open the "Update Driver Software-Generic PnP Monitor" window by clicking on **"Update Driver..."** "and then click the **"Browse my computer for driver software"** button.

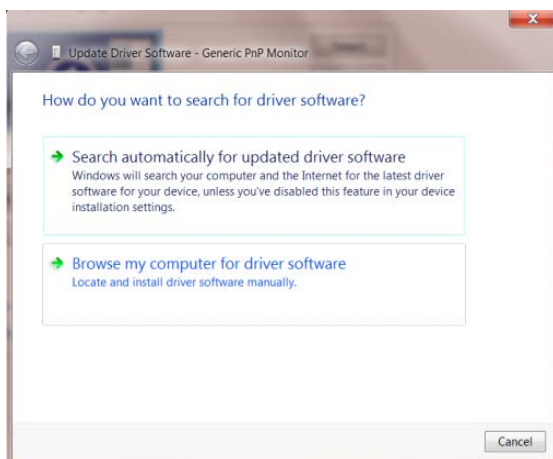

- Select **"Let me pick from a list of device drivers on my computer"**.

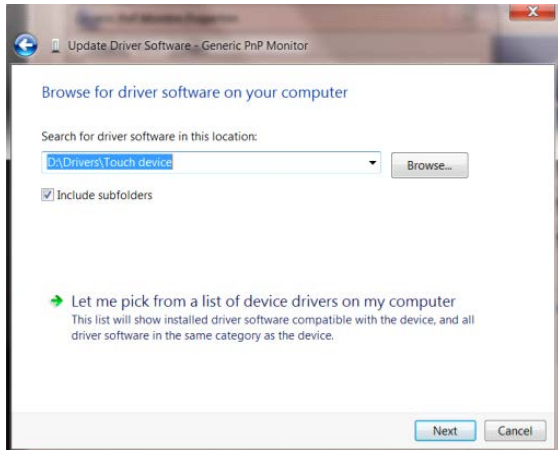

- Click the **"Have Disk"** button. Click on the **"Browse"** button and navigate to the following directory:
X:\Driver\module name(where X is the drive letter designator for the CD-ROM drive).

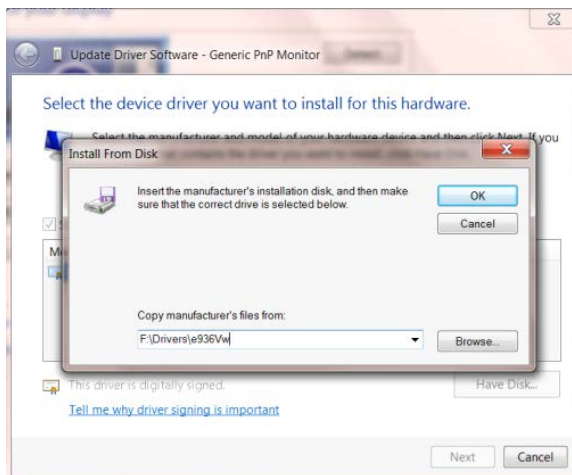

- Select the **"xxx.inf"** file and click the **"Open"** button. Click the **"OK"** button.
- Select your monitor model and click the **"Next"** button. The files will be copied from the CD to your hard disk drive.
- Close all open windows and remove the CD.
- Restart the system. The system will automatically select the maximum refresh rate and corresponding Color Matching Profiles.

Windows 8

- Start Windows® 8
- Right click and click **All apps** at the bottom-right of the screen.

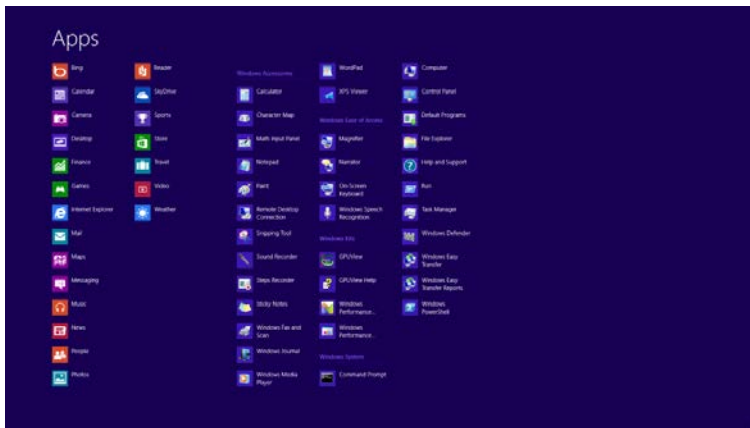
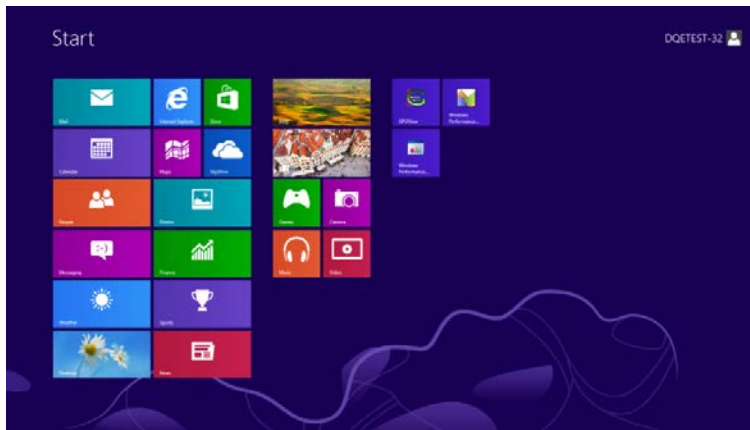

- Click on the "Control Panel" icon
- Set the "View by" to "Large icons" or "Small icons".

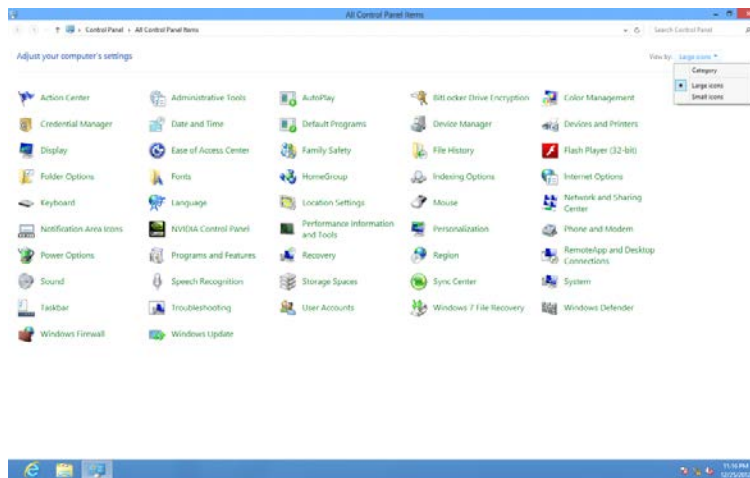

- Click on the "**Display**" icon.

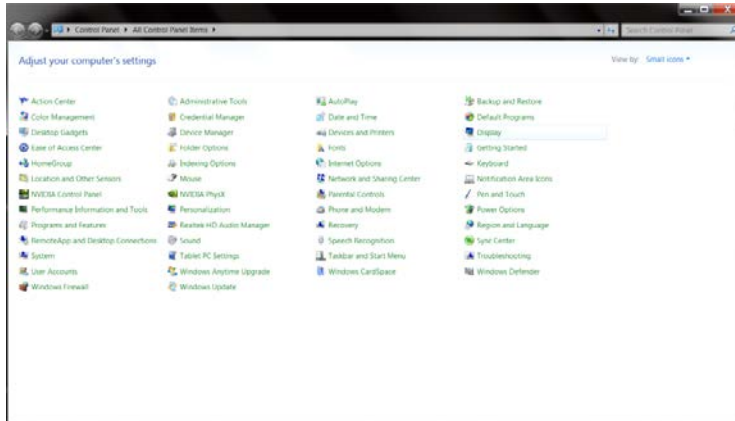

- Click on the "**Change display settings**" button.

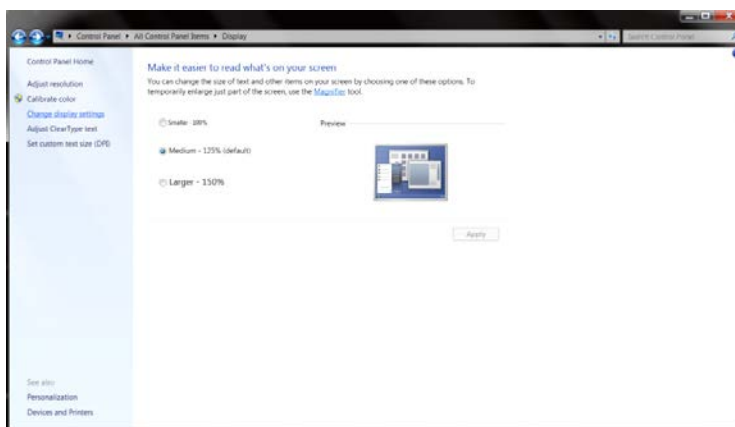

- Click the "**Advanced Settings**" button.

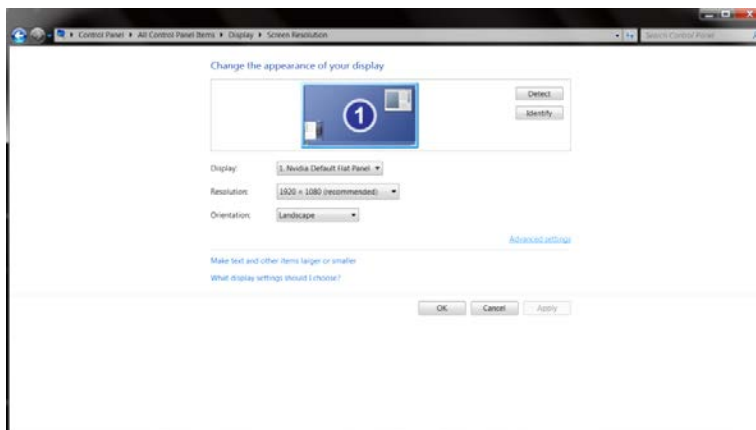

- Click the **"Monitor"** tab and then click the **"Properties"** button.

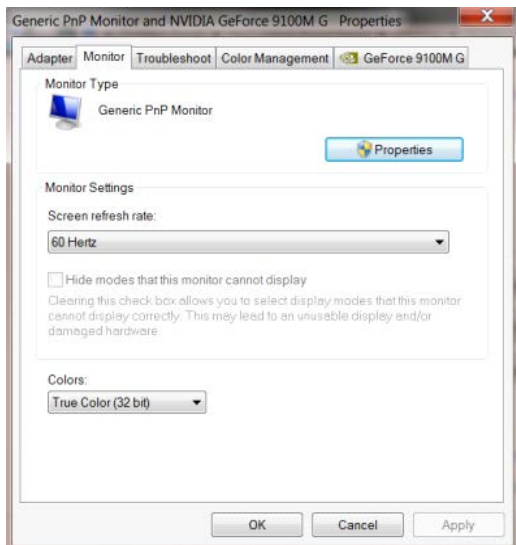

- Click the **"Driver"** tab.

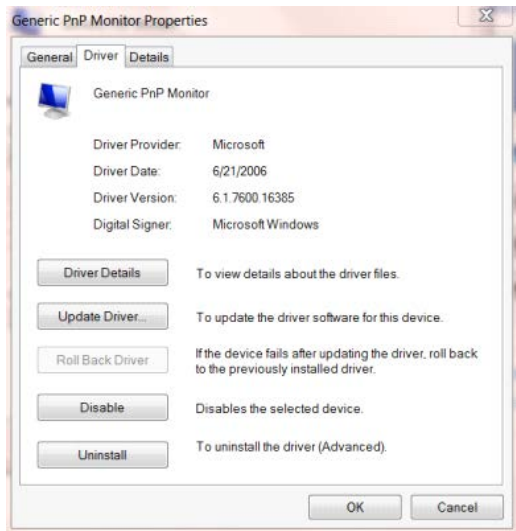

- Open the **"Update Driver Software-Generic PnP Monitor"** window by clicking on **"Update Driver..."** and then click the **"Browse my computer for driver software"** button.

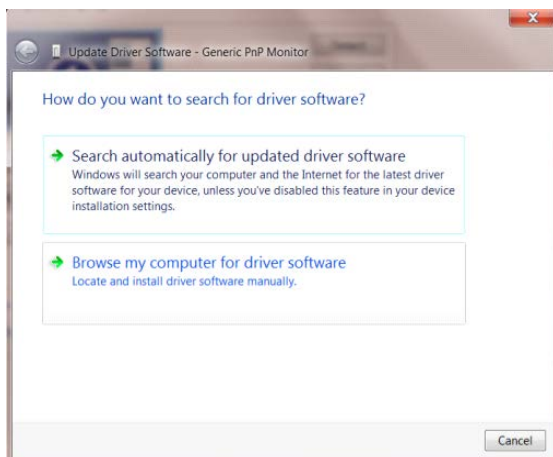

- Select **"Let me pick from a list of device drivers on my computer"**.

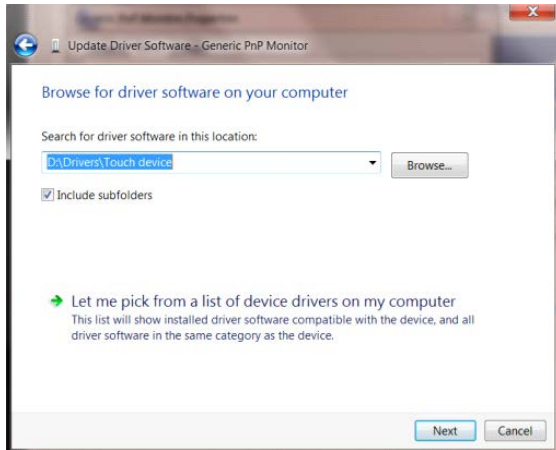

- Click the **"Have Disk"** button. Click on the **"Browse"** button and navigate to the following directory:
X:\Driver\module name (where X is the drive letter designator for the CD-ROM drive).

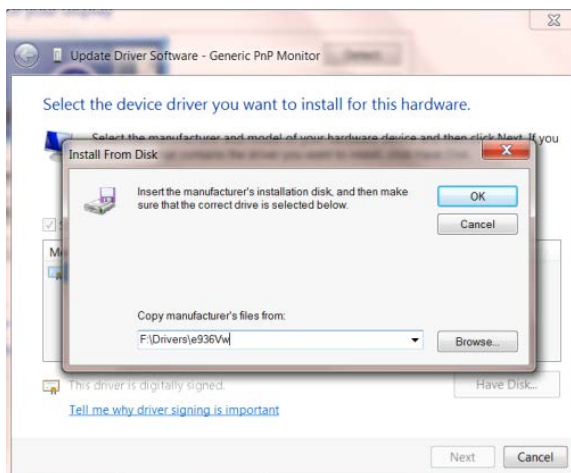

- Select the **"xxx.inf"** file and click the **"Open"** button. Click the **"OK"** button.
- Select your monitor model and click the **"Next"** button. The files will be copied from the CD to your hard disk drive.
- Close all open windows and remove the CD.
- Restart the system. The system will automatically select the maximum refresh rate and corresponding Color Matching Profiles.

Windows 7

- Start Windows® 7
- Click on the **"Start"** button and then click on **"Control Panel"**.

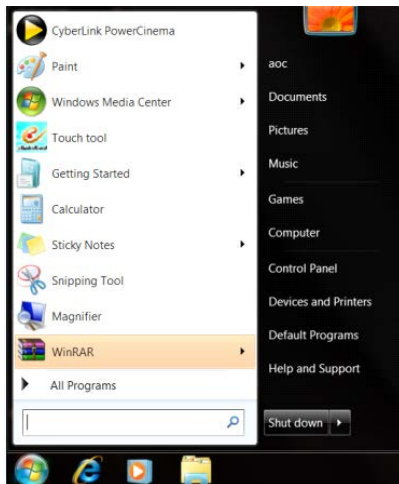

- Click on the **"Display"** icon.

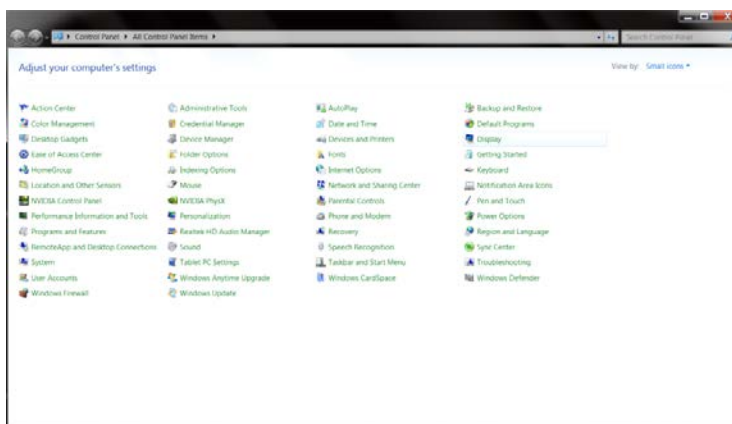

- Click on the **"Change display settings"** button.

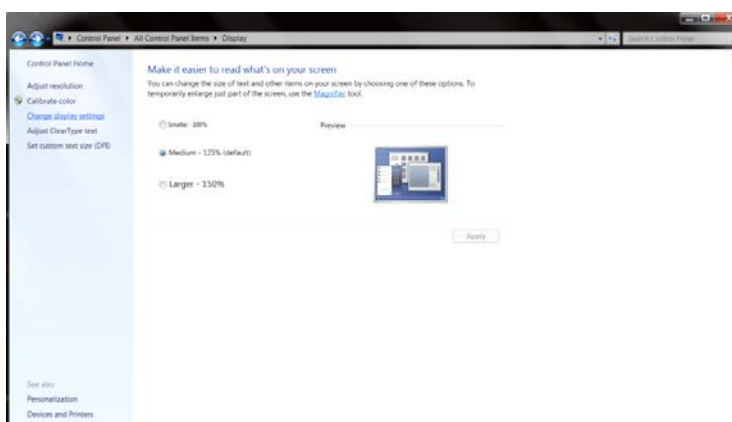

- Click the **"Advanced Settings"** button.

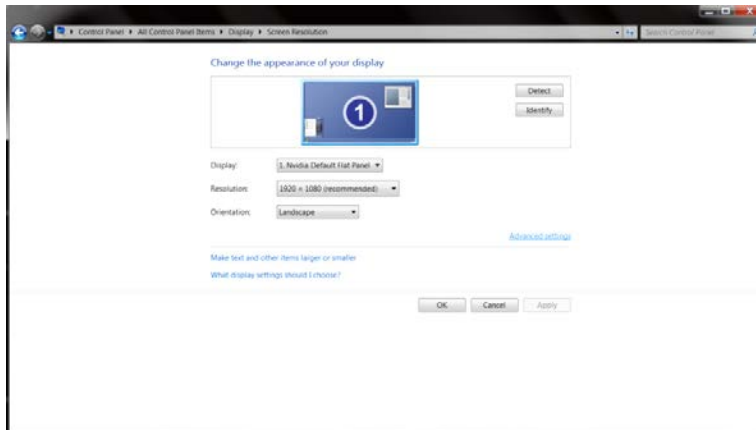

- Click the **"Monitor"** tab and then click the **"Properties"** button.

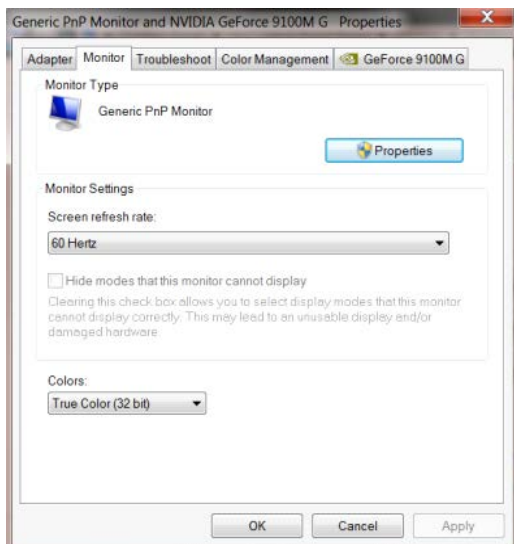

- Click the **"Driver"** tab.

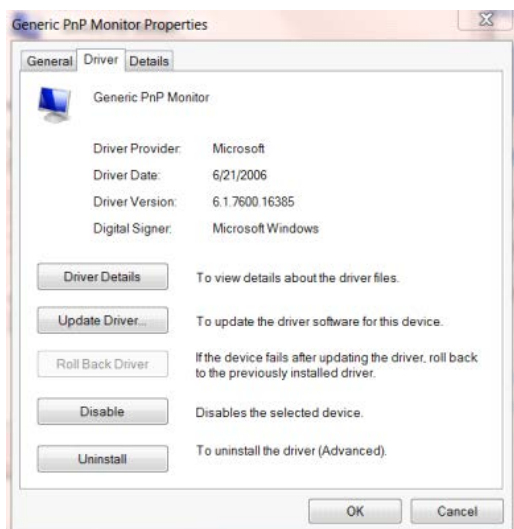

- Open the "Update Driver Software-Generic PnP Monitor" window by clicking on "Update Driver..." and then click the "Browse my computer for driver software" button.

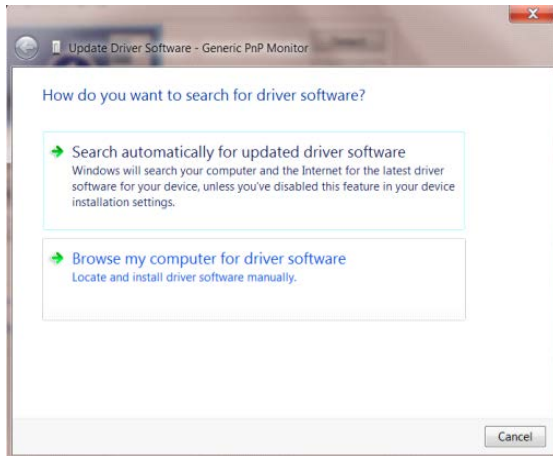

- Select "Let me pick from a list of device drivers on my computer".

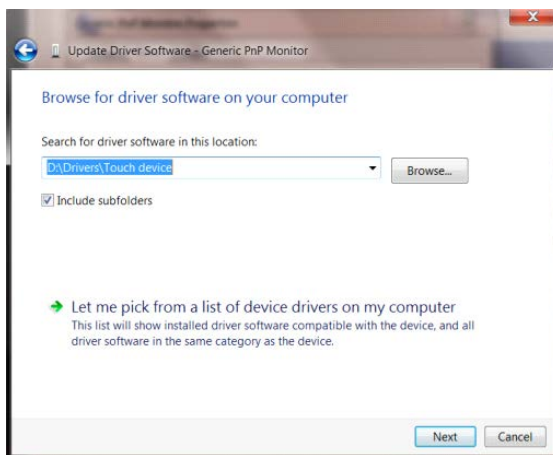

- Click the "Have Disk" button. Click on the "Browse" button and navigate to the following directory: X:\Driver\module name(where X is the drive letter designator for the CD-ROM drive).

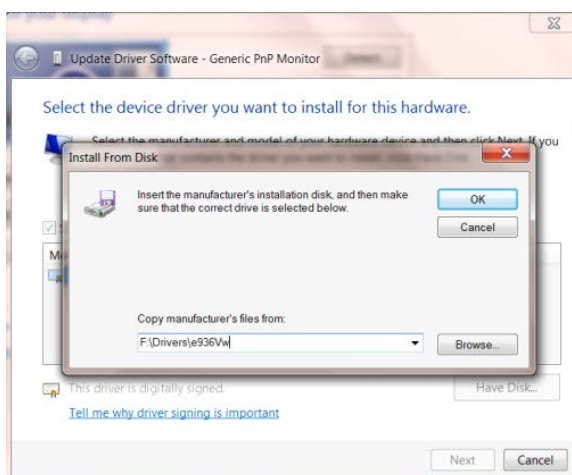

-
- Select the "**xxx.inf**" file and click the "**Open**" button. Click the "**OK**" button.
 - Select your monitor model and click the "**Next**" button. The files will be copied from the CD to your hard disk drive.
 - Close all open windows and remove the CD.
 - Restart the system. The system will automatically select the maximum refresh rate and corresponding Color Matching Profiles.

i-Menu



Welcome to "i-Menu" software by AOC. i-Menu makes it easy to adjust your monitor display setting by using on screen menus instead of the OSD button on the monitor. To complete installation, please follow the installation guide.



e-Saver



Welcome to use AOC e-Saver monitor power management software! The AOC e-Saver features Smart Shutdown functions for your monitors, allows your monitor to timely shutdown when PC unit is at any status (On, Off, Sleep or Screen Saver); the actual shutdown time depends on your preferences (see example below).

Please click on "driver/e-Saver/setup.exe" to start installing the e-Saver software, follow the install wizard to complete software installation.

Under each of the four PC statuses, you may choose the desired time (in minutes) from the pull-down menu for your monitor to automatically shutdown. The example below illustrated:

- 1) The monitor will never shutdown when the PC is powered on.
- 2) The monitor will automatically shutdown 5 minutes after the PC is powered off.
- 3) The monitor will automatically shutdown 10 minutes after the PC is in sleep/stand-by mode.
- 4) The monitor will automatically shutdown 20 minutes after the screen saver appears.

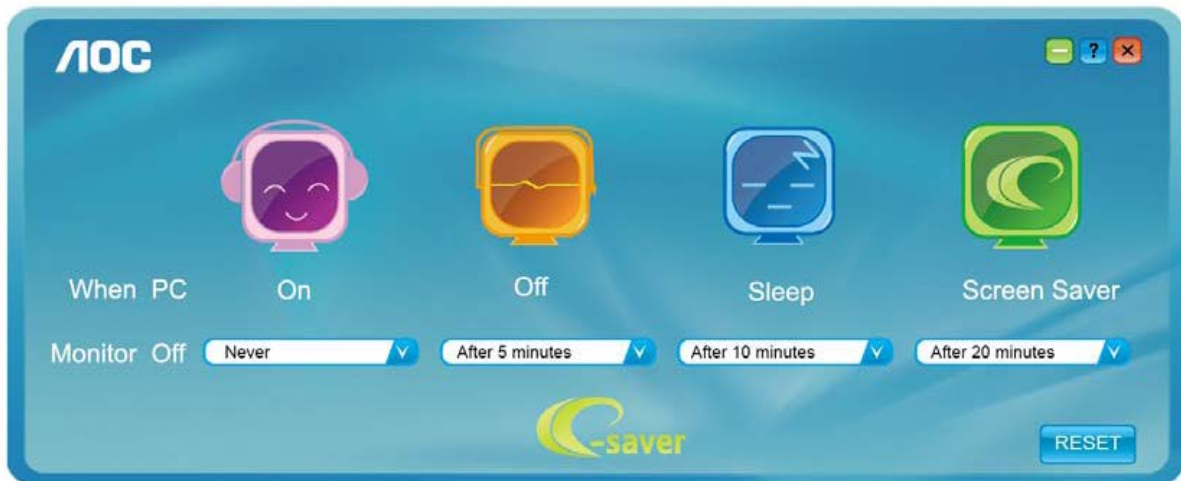

You can click "RESET" to set the e-Saver to its default settings like below.

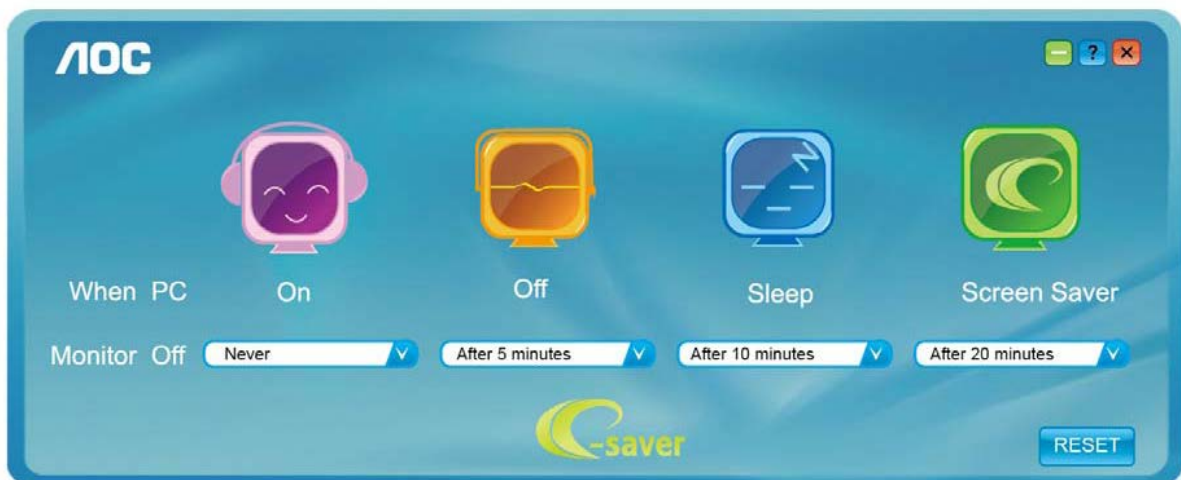

Screen+



Welcome to "Screen+" software by AOC. Screen+ software is a desktop screen splitting tool; it splits the desktop into different panels, and each panel displays a different window. You only need to drag the window to a corresponding panel when you want to access it. It supports multiple monitor display to make your task easier. Please follow the installation software to install it.

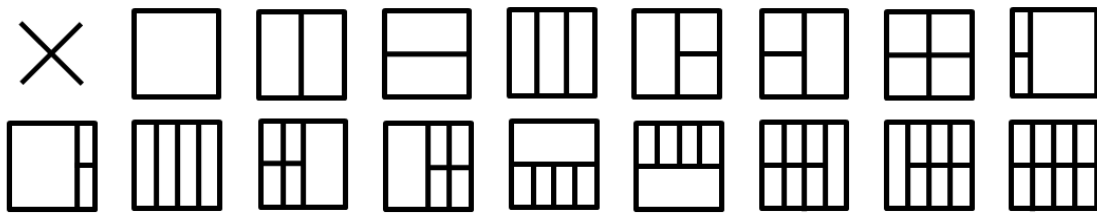

Troubleshoot

| Problem & Question | Possible Solutions |
|---|--|
| Power LED Is Not ON | Make sure the power button is ON and the Power Cord is properly connected to a grounded power outlet and to the monitor. |
| No images on the screen | <ul style="list-style-type: none"> ● Is the power cord connected properly? Check the power cord connection and power supply. ● Is the cable connected correctly? (Connected using the D-sub cable) Check the DB-15 cable connection. (Connected using the DVI cable) Check the DVI cable connection. * DVI input is not available on every model. ● If the power is on, reboot the computer to see the initial screen (the login screen), which can be seen. If the initial screen (the login screen) appears, boot the computer in the applicable mode (the safe mode for Windows ME/2000) and then change the frequency of the video card. (Refer to the Setting the Optimal Resolution) If the initial screen (the login screen) does not appear, contact the Service Center or your dealer. ● Can you see "Input Not Supported" on the screen? You can see this message when the signal from the video card exceeds the maximum resolution and frequency that the monitor can handle properly. Adjust the maximum resolution and frequency that the monitor can handle properly. ● Make sure the AOC Monitor Drivers are installed. |
| Picture Is Fuzzy & Has Ghosting Shadowing Problem | <p>Adjust the Contrast and Brightness Controls. Press to auto adjust.</p> <p>Make sure you are not using an extension cable or switch box. We recommend plugging the monitor directly to the video card output connector on the back.</p> |
| Picture Bounces, Flickers Or Wave Pattern Appears In The Picture | <p>Move electrical devices that may cause electrical interference as far away from the monitor as possible.</p> <p>Use the maximum refresh rate your monitor is capable of at the resolution you are using.</p> |

| | |
|---|---|
| <p>Monitor Is Stuck In Active Off-Mode"</p> | <p>The Computer Power Switch should be in the ON position. The Computer Video Card should be snugly fitted in its slot. Make sure the monitor's video cable is properly connected to the computer. Inspect the monitor's video cable and make sure no pin is bent. Make sure your computer is operational by hitting the CAPS LOCK key on the keyboard while observing the CAPS LOCK LED. The LED should either turn ON or OFF after hitting the CAPS LOCK key.</p> |
| <p>Missing one of the primary colors (RED, GREEN, or BLUE)</p> | <p>Inspect the monitor's video cable and make sure that no pin is damaged. Make sure the monitor's video cable is properly connected to the computer.</p> |
| <p>Screen image is not centered or sized properly</p> | <p>Adjust H-Position and V-Position or press hot-key (AUTO).</p> |
| <p>Picture has color defects (white does not look white)</p> | <p>Adjust RGB color or select desired color temperature.</p> |
| <p>Horizontal or vertical disturbances on the screen</p> | <p>Use Windows 95/98/2000/ME shut-down mode to adjust CLOCK and PHASE. Press to auto-adjust.</p> |

Specification

General Specification

| | | | | |
|--------------------------|-------------------------------|--|-------|--|
| Panel | Model name | C4008VU8 | | |
| | Driving system | TFT Color LCD | | |
| | Viewable Image Size | 101.6 mm diagonal | | |
| | Pixel pitch | 0.230(H)mm x 0.230(V)mm | | |
| | Video | R, G, B Analog Interface & Digital Interface | | |
| | Separate Sync. | H/V TTL | | |
| | Display Color | 1.07B Colors | | |
| | Pixel Clock | 210MHz(D-SUB) 300MHz(HDMI1.4,MHL) 600MHz(DP,HDMI2.0) | | |
| Others | Horizontal scan range | 30~99KHz (D-SUB, MHL,HDMI1.4) 30~160KHz(DP,HDMI2.0) | | |
| | Horizontal scan Size(Maximum) | 884.736 mm | | |
| | Vertical scan range | 23Hz ~ 80Hz | | |
| | Vertical scan Size(Maximum) | 497.664 mm | | |
| | Optimal preset resolution | 1920x1080@60Hz(D-SUB,MHL) 3840x2160@30Hz(HDMI1.4) 3840x2160@60Hz(DP,HDMI2.0) | | |
| | Plug & Play | VESA DDC2B/CI | | |
| | Input Connector | VGA/ HDMI/MHL/DP/Audio in/ Earphone out/USB3.0x4 | | |
| | Input Video Signal | Analog: 0.7Vp-p(standard), 75 OHM, Positive, TMDS | | |
| | Speaker | 5 W x 2 | | |
| | Power Source | 100-240V~, 50/60Hz, 1.5A | | |
| | Power Consumption | Typical (Brightness = 90,Contrast = 50) | 50W | |
| | | (Brightness = 100,Contrast = 100) | 110W | |
| | | Power saving | ≤0.5W | |
| Off timer | 0-24 hrs | | | |
| Physical Characteristics | Connector Type | VGA\ HDMI\DP \ Line in\Earphone out\ USB2.0x2\USB3.0x4 | | |
| | Signal Cable Type | Detachable | | |
| | Dimensions & Weight: | | | |
| | Height (with base) | 631.8mm | | |
| | Width | 906.8mm | | |
| | Depth | 245.8 mm | | |
| | Weight (monitor only) | 11.85 kg | | |
| Environmental | Temperature: | | | |
| | Operating | 0° to 40°C | | |
| | Non-Operating | -25° to 55°C | | |
| | Humidity: | | | |
| | Operating | 10% to 85% (non-condensing) | | |
| | Non-Operating | 5% to 93% (non-condensing) | | |
| | Altitude: | | | |
| Operating | 0~ 5000m(0~ 16404 ft) | | | |

| | | |
|--|---------------|--------------------------|
| | Non-Operating | 0~ 12192m (0~ 40000 ft) |
|--|---------------|--------------------------|

Since the MHL provides mobile phone charging function and share the same connector with HDMI, Whether the MHL is set to On, Off or Standby mode, the MHL port provides power to charge the connected device simultaneously. In Standby and Off energy saving of ErP not applicable for the MHL charging functionality.

Preset Display Modes

| Standard | Resolution | H. Frequency (kHz) | V. Frequency (Hz) |
|----------|----------------|--------------------|-------------------|
| VGA | 640x480@60Hz | 31.469 | 59.94 |
| VGA | 640x480@67Hz | 35 | 66.667 |
| VGA | 640x480@72Hz | 37.861 | 72.809 |
| VGA | 640x480@75Hz | 37.5 | 75 |
| DOS MODE | 720x400@70Hz | 31.469 | 70.087 |
| SVGA | 800x600@56Hz | 35.156 | 56.25 |
| SVGA | 800x600@60Hz | 37.879 | 60.317 |
| SVGA | 800x600@72Hz | 48.077 | 72.188 |
| SVGA | 800x600@75Hz | 46.875 | 75 |
| MAC MODE | 832x624@75Hz | 49.725 | 74.551 |
| XGA | 1024x768@60Hz | 48.363 | 60.004 |
| XGA | 1024x768@70Hz | 56.476 | 70.069 |
| XGA | 1024x768@75Hz | 60.023 | 75.029 |
| SXGA | 1280x1024@60Hz | 63.981 | 60.02 |
| SXGA | 1280x1024@75Hz | 79.976 | 75.025 |
| WXGA+ | 1440x900@60Hz | 55.935 | 59.887 |
| WSXGA | 1680x1050@60Hz | 64.674 | 59.954 |
| FHD | 1920x1080@60Hz | 67.5 | 60 |
| HD | 1280x960@60HZ | 60 | 60 |
| HD | 1280x720@60HZ | 44.772 | 59.885 |
| QWHD | 2560x1440@60Hz | 88.786 | 59.9 |
| UHD | 3840X2160@30Hz | 67.5 | 30 |
| UHD | 3840X2160@60Hz | 133.32 | 60 |

Pin Assignments

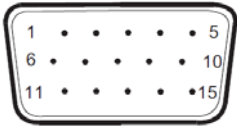

15-Pin Color Display Signal Cable

| Pin No. | Signal Name | Pin No. | Signal Name |
|---------|--------------|---------|------------------|
| 1 | Video-Red | 9 | +5V |
| 2 | Video-Green | 10 | Ground |
| 3 | Video-Blue | 11 | N.C. |
| 4 | N.C. | 12 | DDC-Serial data |
| 5 | Detect Cable | 13 | H-sync |
| 6 | GND-R | 14 | V-sync |
| 7 | GND-G | 15 | DDC-Serial clock |
| 8 | GND-B | | |



19-Pin Color Display Signal Cable

| Pin No. | Signal Name | Pin No. | Signal Name |
|---------|--------------------|---------|---------------------------|
| 1 | TMDS Data 2+ | 11 | TMDS Clock Shield |
| 2 | TMDS Data 2 Shield | 12 | TMDS Clock |
| 3 | TMDS Data 2 | 13 | CEC |
| 4 | TMDS Data 1+ | 14 | Reserved (N.C. on device) |
| 5 | TMDS Data 1Shield | 15 | SCL |
| 6 | TMDS Data 1 | 16 | SDA |
| 7 | TMDS Data 0+ | 17 | DDC/CEC Ground |
| 8 | TMDS Data 0 Shield | 18 | +5V Power |
| 9 | TMDS Data 0 | 19 | Hot Plug Detect |
| 10 | TMDS Clock + | | |

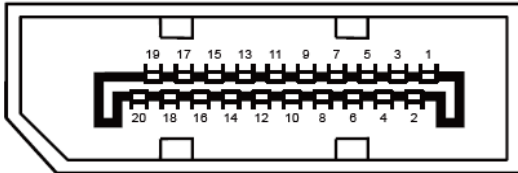

20-Pin Color Display Signal Cable

| Pin No. | Signal Name | Pin No. | Signal Name |
|---------|---------------|---------|-----------------|
| 1 | ML_Lane 3 (n) | 11 | GND |
| 2 | GND | 12 | ML_Lane 0 (p) |
| 3 | ML_Lane 3 (p) | 13 | CONFIG1 |
| 4 | ML_Lane 2 (n) | 14 | CONFIG2 |
| 5 | GND | 15 | AUX_CH(p) |
| 6 | ML_Lane 2 (p) | 16 | GND |
| 7 | ML_Lane 1 (n) | 17 | AUX_CH(n) |
| 8 | GND | 18 | Hot Plug Detect |
| 9 | ML_Lane 1 (p) | 19 | Return DP_PWR |
| 10 | ML_Lane 0 (n) | 20 | DP_PWR |

Plug and Play

Plug & Play DDC2B Feature

This monitor is equipped with VESA DDC2B capabilities according to the VESA DDC STANDARD. It allows the monitor to inform the host system of its identity and, depending on the level of DDC used, communicate additional information about its display capabilities.

The DDC2B is a bi-directional data channel based on the I2C protocol. The host can request EDID information over the DDC2B channel.

Regulation

FCC Notice

FCC Class B Radio Frequency Interference Statement WARNING: (FOR FCC CERTIFIED MODELS)

NOTE: This equipment has been tested and found to comply with the limits for a Class B digital device, pursuant to Part 15 of the FCC Rules. These limits are designed to provide reasonable protection against harmful interference in a residential installation. This equipment generates, uses and can radiate radio frequency energy, and if not installed and used in accordance with the instructions, may cause harmful interference to radio communications. However, there is no guarantee that interference will not occur in a particular installation. If this equipment does cause harmful interference to radio or television reception, which can be determined by turning the equipment off and on, the user is encouraged to try to correct the interference by one or more of the following measures:

Reorient or relocate the receiving antenna.

Increase the separation between the equipment and receiver.

Connect the equipment into an outlet on a circuit different from that to which the receiver is connected.

Consult the dealer or an experienced radio/TV technician for help.

NOTICE:

The changes or modifications not expressly approved by the party responsible for compliance could void the user's authority to operate the equipment.

Shielded interface cables and AC power cord, if any, must be used in order to comply with the emission limits.

The manufacturer is not responsible for any radio or TV interference caused by unauthorized modification to this equipment. It is the responsibilities of the user to correct such interference. It is the responsibility of the user to correct such interference.

WEEE Declaration

Disposal of Waste Equipment by Users in Private Household in the European Union.



This symbol on the product or on its packaging indicates that this product must not be disposed of with your other household waste. Instead, it is your responsibility to dispose of your waste equipment by handing it over to a designated collection point for the recycling of waste electrical and electronic equipment. The separate collection and recycling of your waste equipment at the time of disposal will help to conserve natural resources and ensure that it is recycled in a manner that protects human health and the environment. For more information about where you can drop off your waste equipment for recycling, please contact your local city office, your household waste disposal service or the shop where you purchased the product.

This product complies with all implemented RoHS type regulations worldwide, including but not limited to, EU, Korea, Japan, US States (e.g. California), Ukraine, Serbia, Turkey, Vietnam and India.

We continue to monitor, influence and develop our processes to comply with upcoming proposed RoHS type regulations, including but not limited to, Brazil, Argentina, Canada.

WEEE Declaration for India



This symbol on the product or on its packaging indicates that this product must not be disposed of with your other household waste. Instead it is your responsibility to dispose of your waste equipment by handing it over to a designated collection point for the recycling of waste electrical and electronic equipment . The separate collection and recycling of your waste equipment at the time of disposal will help to conserve natural resources and ensure that it is recycled in a manner that protects human health and the environment. For more information about E-waste please visit <http://www.aocindia.com/ewaste.php> and to know where you can drop off your waste equipment for recycling in India please contact on below given contact details.

Helpline number: 080-6788-6788 / 080-3323-1313 (Monday to Saturday, 10 a.m. to 6 p.m.)

Centralized E-waste collection center

Address: TPV Technology India Private Limited, 59, Maheswari Nagar, 1st Main Road, Mahadevapura Post, Whitefield Road, Bangalore, Karnataka, PIN: 560048, Tel: 080-3023-1000

E-mail: serviceindia@aoc.com

Restriction on Hazardous Substances statement (India)

This product complies with the “E-Waste (Management) Rules, 2016” CHAPTER V, rule 16, sub-rule (1) . Whereas

New Electrical and Electronic Equipment and their components or consumables or parts or spares do not contain Lead, Mercury, Cadmium, Hexavalent Chromium, polybrominated biphenyls and polybrominated diphenyl ethers beyond a maximum concentration value of 0.1% by weight in homogenous materials for lead, mercury, hexavalent chromium, polybrominated biphenyls and polybrominated diphenyl ethers and of 0.01% by weight in homogenous materials for cadmium. except of exemptions set in Schedule 2 of the Rule.

EPA Energy Star



ENERGY STAR® is a U.S. registered mark. As an ENERGY STAR® Partner, AOC International (Europe) BV and Envision Peripherals, Inc. have determined that this product meets the ENERGY STAR® guidelines for energy efficiency. (FOR EPA CERTIFIED MODELS)

EPEAT Declaration



EPEAT is a system to help purchasers in the public and private sectors evaluate, compare and select desktop computers, notebooks and monitors based on their environmental attributes. EPEAT also provides a clear and consistent set of performance criteria for the design of products, and provides an opportunity for manufacturers to secure market recognition for efforts to reduce the environmental impact of its products. (FOR EPEAT CERTIFIED MODELS)

AOC believes in protecting the environment. With a key concern for the conservation of natural resources, as well as landfill protection, AOC announces the launch of AOC monitor's packaging recycling program. This program is designed to help you discard of your monitor carton and filler materials properly. If a local recycling center is not available, AOC will recycle the packaging material for you, including foam filler and carton. AOC Display solution will only recycle AOC monitor packaging. Please refer to the following website address:

Only for North and South American, excluding Brazil:

<http://us.aoc.com/aoc-corporation/?page=environmental-impact>

For Germany:

<http://aoc-europe.com/de/content/environment>

For Brazil:

<http://www.aoc.com.br/pg/embalagem-verde>

Service

Warranty Statement for Europe

LIMITED THREE-YEAR WARRANTY*

For AOC LCD Monitors sold within Europe, AOC International (Europe) B.V. warrants this product to be free from defects in material and workmanship for a period of Three (3) years after the original date of consumer purchase. During this period, AOC International (Europe) B.V. will, at its option, either repair the defective product with new or rebuilt parts, or replace it with a new or rebuilt product at no charge except as *stated below. In the absent of the proof of purchase, the warranty will start 3 months after the date of manufacturing indicated on the product.

If the product appears to be defective, please contact your local dealer or refer to the service and support section on www.aoc-europe.com for the warranty instructions in your country. The freight cost for the warranty is pre-paid by AOC for the delivery and return. Please ensure you provide a dated proof of purchase along with the product and deliver to the AOC Certified or Authorized Service Center under the following condition:

- Make sure the LCD Monitor is packed in a proper carton box (AOC prefers the original carton box to protect your monitor well enough during transport).
- Put the RMA number on the address label
- Put the RMA number on the shipping carton

AOC International (Europe) B.V. will pay the return shipping charges within one of the countries specified within this warranty statement. AOC International (Europe) B.V. is not responsible for any costs associated with the transportation of product across international borders. This includes the international border within the European Union. If the LCD Monitor is not available for collection when the carrier attends, you will be charged a collection fee.

*** This limited warranty does not cover any losses or damages that occur as a result of:**

- Damages during transport due to improper packaging
- Improper installation or maintenance other than in accordance with AOC's user manual
- Misuse
- Neglect
- Any cause other than ordinary commercial or industrial application
- Adjustment by non-authorized source
- Repair, modification, or installation of options or parts by anyone other than an AOC Certified or Authorized Service Center
- Improper environments like humidity, water damage and dusts
- Damaged by violence, earthquake and terrorist attacks
- Excessive or inadequate heating or air conditioning or electrical powers failures, surges, or other irregularities

This limited warranty does not cover any of the product firmware or hardware that you or any third party have modified or altered; you bear the sole responsibility and liability for any such modifications or alteration.

All AOC LCD Monitors are produced according to the ISO 9241-307 Class 1 pixel policy standards.

If your warranty has expired, you still have access to all available service options, but you will be responsible for the cost of service, including parts, labor, shipping (if any) and applicable taxes. AOC Certified or Authorized Service Center will provide you with an estimate of service costs before receiving your authorization to perform service.

ALL EXPRESS AND IMPLIED WARRANTIES FOR THIS PRODUCT (INCLUDING THE WARRANTIES OF MERCHANTABILITY AND FITNESS FOR A PARTICULAR PURPOSE) ARE LIMITED IN DURATION TO A PERIOD OF THREE (3) YEARS FOR PARTS AND LABOR FROM THE ORIGINAL DATE OF CONSUMER PURCHASE. NO WARRANTIES (EITHER EXPRESSED OR IMPLIED) APPLY AFTER THIS PERIOD. AOC INTERNATIONAL (EUROPE) B.V. OBLIGATIONS AND YOUR REMEDIES HEREUNDER ARE SOLELY AND EXCLUSIVELY AS STATED HERE. AOC INTERNATIONAL (EUROPE) B.V. LIABILITY, WHETHER BASED ON CONTRACT, TORT, WARRANTY, STRICT LIABILITY, OR OTHER THEORY, SHALL NOT EXCEED THE PRICE OF THE INDIVIDUAL UNIT WHOSE DEFECT OR DAMAGE IS THE BASIS OF THE CLAIM. IN NO EVENT SHALL AOC INTERNATIONAL (EUROPE) B.V. BE LIABLE FOR ANY LOSS OF PROFITS, LOSS OF USE OR FACILITIES OR EQUIPMENT, OR OTHER INDIRECT, INCIDENTAL, OR CONSEQUENTIAL DAMAGE. SOME STATES DO NOT ALLOW THE EXCLUSION OR LIMITATION OF INCIDENTAL OR CONSEQUENTIAL DAMAGES, SO THE ABOVE LIMITATION MAY NOT APPLY TO YOU. ALTHOUGH THIS LIMITED WARRANTY GIVES YOU SPECIFIC LEGAL RIGHTS, YOU MAY HAVE OTHER RIGHTS, WHICH MAY VARY FROM COUNTRY TO COUNTRY. THIS LIMITED WARRANTY IS ONLY VALID FOR PRODUCTS PURCHASED IN THE MEMBER COUNTRIES OF THE EUROPEAN UNION.

Information in this document is subject to change without notice. For more information, please visit:

<http://www.aoc-europe.com>

Warranty Statement for Middle East and Africa (MEA)

And

The Commonwealth of Independent States (CIS)

LIMITED ONE to THREE YEARS WARRANTY*

For AOC LCD Monitors sold within the Middle East and Africa (MEA) and the Commonwealth of Independent States (CIS), AOC International (Europe) B.V. warrants this product to be free from defects in material and workmanship for a period of One (1) to Three (3) years from the manufacture date depending on sale country. During this period, AOC International (Europe) B.V. offers a Carry-In (return to Service Center) Warranty Support at an AOC's Authorized Service Center or Dealer and at its option, either repair the defective product with new or rebuilt parts, or replace it with a new or rebuilt product at no charge except as *stated below. As a Standard Policy, the warranty will be calculated from the manufacture date identified from the product ID serial number, but the total warranty will be Fifteen (15) months to Thirty Nine (39) months from MFD (manufacture date) depending on sale country. Warranty will be considered for exceptional cases that are out of warranty as per the product ID serial number and for such exceptional cases; Original Invoice/Proof Of Purchase Receipt is mandatory.

If the product appears to be defective, please contact your AOC authorized dealer or refer to the service and support section on AOC's website for the warranty instructions in your country:

- Egypt: http://aocmonitorap.com/egypt_eng
- CIS Central Asia: <http://aocmonitorap.com/ciscentral>
- Middle East: <http://aocmonitorap.com/middleeast>
- South Africa: <http://aocmonitorap.com/southafrica>
- Saudi Arabia: <http://aocmonitorap.com/saudiarabia>

Please ensure you provide a dated proof of purchase along with the product and deliver to the AOC Authorized Service Center or Dealer under the following condition:

- Make sure the LCD Monitor is packed in a proper carton box (AOC prefers the original carton box to protect your monitor well enough during transport).
- Put the RMA number on the address label
- Put the RMA number on the shipping carton

*** This limited warranty does not cover any losses or damages that occur as a result of:**

- Damages during transport due to improper packaging
- Improper installation or maintenance other than in accordance with AOC's user manual
- Misuse
- Neglect
- Any cause other than ordinary commercial or industrial application
- Adjustment by non-authorized source

-
- Repair, modification, or installation of options or parts by anyone other than an AOC Certified or Authorized Service Center
 - Improper environments like humidity, water damage and dusts
 - Damaged by violence, earthquakes and terrorist attacks
 - Excessive or inadequate heating or air conditioning or electrical powers failures, surges, or other irregularities

This limited warranty does not cover any of the product firmware or hardware that you or any third party have modified or altered; you bear the sole responsibility and liability for any such modifications or alteration.

All AOC LCD Monitors are produced according to the ISO 9241-307 Class 1 pixel policy standards.

If your warranty has expired, you still have access to all available service options, but you will be responsible for the cost of service, including parts, labor, shipping (if any) and applicable taxes. AOC Certified, Authorized Service Center or dealer will provide you with an estimate of service costs before receiving your authorization to perform service.

ALL EXPRESS AND IMPLIED WARRANTIES FOR THIS PRODUCT (INCLUDING THE WARRANTIES OF MERCHANTABILITY AND FITNESS FOR A PARTICULAR PURPOSE) ARE LIMITED IN DURATION TO A PERIOD OF ONE (1) to THREE (3) YEARS FOR PARTS AND LABOR FROM THE ORIGINAL DATE OF CONSUMER PURCHASE. NO WARRANTIES (EITHER EXPRESSED OR IMPLIED) APPLY AFTER THIS PERIOD. AOC INTERNATIONAL (EUROPE) B.V. OBLIGATIONS AND YOUR REMEDIES HEREUNDER ARE SOLELY AND EXCLUSIVELY AS STATED HERE. AOC INTERNATIONAL (EUROPE) B.V. LIABILITY, WHETHER BASED ON CONTRACT, TORT, WARRANTY, STRICT LIABILITY, OR OTHER THEORY, SHALL NOT EXCEED THE PRICE OF THE INDIVIDUAL UNIT WHOSE DEFECT OR DAMAGE IS THE BASIS OF THE CLAIM. IN NO EVENT SHALL AOC INTERNATIONAL (EUROPE) B.V. BE LIABLE FOR ANY LOSS OF PROFITS, LOSS OF USE OR FACILITIES OR EQUIPMENT, OR OTHER INDIRECT, INCIDENTAL, OR CONSEQUENTIAL DAMAGE. SOME STATES DO NOT ALLOW THE EXCLUSION OR LIMITATION OF INCIDENTAL OR CONSEQUENTIAL DAMAGES, SO THE ABOVE LIMITATION MAY NOT APPLY TO YOU. ALTHOUGH THIS LIMITED WARRANTY GIVES YOU SPECIFIC LEGAL RIGHTS, YOU MAY HAVE OTHER RIGHTS, WHICH MAY VARY FROM COUNTRY TO COUNTRY. THIS LIMITED WARRANTY IS ONLY VALID FOR PRODUCTS PURCHASED IN THE MEMBER COUNTRIES OF THE EUROPEAN UNION.

Information in this document is subject to change without notice. For more information, please visit:

<http://www.aocmonitorap.com>

AOC International (Europe) B.V.

Prins Bernhardplein 200 / 6th floor, Amsterdam, The Netherlands

Tel: +31 (0)20 504 6962 • Fax: +31 (0)20 5046933

AOC Pixel Policy ISO 9241-307 Class 1

July 25th, 2013

AOC strives to deliver the highest quality products. We use some of the industry’s most advanced manufacturing processes and practice stringent quality control. However, pixel or sub pixel defects on the TFT monitor panels used in flat panel monitors are sometimes unavoidable. No manufacturer can guarantee that all panels will be free from pixel defects, but AOC guarantees that any monitor with an unacceptable number of defects will be repaired or replaced under warranty. This Pixel Policy explains the different types of pixel defects and defines acceptable defect levels for each type. In order to qualify for repair or replacement under warranty, the number of pixel defects on a TFT monitor panel must exceed these acceptable levels.

Pixels and Sub Pixel Definition

A pixel, or picture element, is composed of three sub pixels in the primary colors of red, green and blue. When all sub pixels of pixel are lit, the three colored sub pixel together appear as a single white pixel. When all are dark, the three colored sub pixels together appear as a single black pixel.

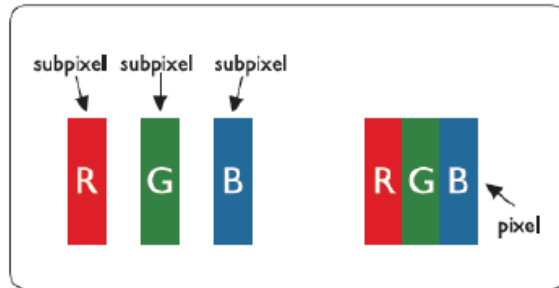

Types of Pixel Defects

- Bright Dot Defects: the monitor displays a dark pattern, sub pixels or pixels are always lit or “on”
- Black Dot Defects: the monitor displays a light pattern, sub pixels or pixels are always dark or “off”.

| ISO 9241-307 Pixel Defect Class | Defect Type 1 Bright Pixel | Defect Type 2 Black Pixel | Defect Type 3 Bright Sub pixel | Defect Type 4 Black Sub pixel |
|------------------------------------|-------------------------------|------------------------------|-----------------------------------|----------------------------------|
| Class 1 | 1 | 1 | 2 1 0 | + + + |
| | | | | 1 3 5 |

Warranty Statement for North & South America (excluding Brazil)

WARRANTY STATEMENT
for AOC Color Monitors
Including those Sold within North America as Specified

Envision Peripherals, Inc. warrants this product to be free from defects in material and workmanship for a period of three (3) years for parts & labor and one (1) year for CRT Tube or LCD Panel after the original date of consumer purchase. During this period, EPI (EPI is the abbreviation of Envision Peripherals, Inc.) will, at its option, either repair the defective product with new or rebuilt parts, or replace it with a new or rebuilt product at no charge except as *stated below. The parts or product that are replaced become the property of EPI.

In the USA to obtain service under this limited warranty, call EPI for the name of the Authorized Service Center closest to your area. Deliver the product freight pre-paid, along with the dated proof of purchase, to the EPI Authorized Service Center. If you cannot deliver the product in person:

- Pack it in its original shipping container (or equivalent)
- Put the RMA number on the address label
- Put the RMA number on the shipping carton
- Insure it (or assume the risk of loss/damage during shipment)
- Pay all shipping charges

EPI is not responsible for damage to inbound product that was not properly packaged.

EPI will pay the return shipment charges within one of the countries specified within this warranty statement. EPI is not responsible for any costs associated with the transportation of product across international borders. This includes the international borders of the countries within this warranty statements.

In the United States and Canada contact your Dealer or EPI Customer Service, RMA Department at the toll free number (888) 662-9888. Or you can request an RMA Number online at www.aoc.com/na-warranty.

* This limited warranty does not cover any losses or damages that occur as a result of:

- Shipping or improper installation or maintenance
- Misuse
- Neglect
- Any cause other than ordinary commercial or industrial application
- Adjustment by non-authorized source
- Repair, modification, or installation of options or parts by anyone other than an EPI Authorized Service Center
- Improper environment
- Excessive or inadequate heating or air conditioning or electrical power failures, surges, or other irregularities

This three-year limited warranty does not cover any of the product's firmware or hardware that you or any third party have modified or altered; you bear the sole responsibility and liability for any such modification or alteration.

ALL EXPRESS AND IMPLIED WARRANTIES FOR THIS PRODUCT (INCLUDING THE WARRANTIES OF MERCHANTABILITY AND FITNESS FOR A PARTICULAR PURPOSE) ARE LIMITED IN DURATION TO A PERIOD OF THREE (3) YEARS FOR PARTS AND LABOR AND ONE (1) YEAR FOR CRT TUBE OR LCD PANEL FROM THE ORIGINAL DATE OF CONSUMER PURCHASE. NO WARRANTIES (EITHER EXPRESSED OR IMPLIED) APPLY AFTER THIS PERIOD. IN THE UNITED STATES OF AMERICA, SOME STATES DO NOT ALLOW LIMITATIONS ON HOW LONG AN IMPLIED WARRANTY LASTS, SO THE ABOVE LIMITATIONS MAY NOT APPLY TO YOU.

EPI OBLIGATIONS AND YOUR REMEDIES HEREUNDER ARE SOLELY AND EXCLUSIVELY AS STATED HERE. EPI' LIABILITY, WHETHER BASED ON CONTRACT, TORT, WARRANTY, STRICT LIABILITY, OR OTHER THEORY, SHALL NOT EXCEED THE PRICE OF THE INDIVIDUAL UNIT WHOSE DEFECT OR DAMAGE IS THE BASIS OF THE CLAIM. IN NO EVENT SHALL ENVISION PERIPHERALS, INC. BE LIABLE FOR ANY LOSS OF PROFITS, LOSS OF USE OR FACILITIES OR EQUIPMENT OR OTHER INDIRECT, INCIDENTAL, OR CONSEQUENTIAL DAMAGE. IN THE UNITED STATES OF AMERICA, SOME STATES DO NOT ALLOW THE EXCLUSION OR LIMITATION OF INCIDENTAL OR CONSEQUENTIAL DAMAGES. SO THE ABOVE LIMITATION MAY NOT APPLY TO YOU. ALTHOUGH THIS LIMITED WARRANTY GIVES YOU SPECIFIC LEGAL RIGHTS. YOU MAY HAVE OTHER RIGHTS WHICH MAY VARY FROM STATE TO STATE.

In the United States of America, this limited warranty is only valid for Products purchased in the Continental United States, Alaska, and Hawaii.

Outside the United States of America, this limited warranty is only valid for Products purchased in Canada.

Information in this document is subject to change without notice.

For more details, please visit:

USA: http://us.aoc.com/support/find_service_center
ARGENTINA: http://ar.aoc.com/support/find_service_center
BOLIVIA: http://bo.aoc.com/support/find_service_center
CHILE: http://cl.aoc.com/support/find_service_center
COLOMBIA: http://co.aoc.com/support/find_service_center
COSTA RICA: http://cr.aoc.com/support/find_service_center
DOMINICAN REPUBLIC: http://do.aoc.com/support/find_service_center
ECUADOR: http://ec.aoc.com/support/find_service_center
EL SALVADOR: http://sv.aoc.com/support/find_service_center
GUATEMALA: http://gt.aoc.com/support/find_service_center
HONDURAS: http://hn.aoc.com/support/find_service_center
NICARAGUA: http://ni.aoc.com/support/find_service_center
PANAMA: http://pa.aoc.com/support/find_service_center
PARAGUAY: http://py.aoc.com/support/find_service_center
PERU: http://pe.aoc.com/support/find_service_center
URUGUAY: http://pe.aoc.com/support/find_service_center
VENEZUELA: http://ve.aoc.com/support/find_service_center
IF COUNTRY NOT LISTED: http://latin.aoc.com/support/find_service_center

EASE PROGRAM



Only for AOC branded monitors sold within the continental United States.

All AOC branded monitors are now covered by the EASE Program. If your monitor malfunctions at any time during the first three months, AOC will provide a replacement monitor within 72 hours after you are approved for our program. If your monitor qualifies for the EASE program, AOC will pay for freight both ways.

Step 1: Phone our TECH Department at 888.662.9888.

Step 2: Fill out and return EASE registration forms by mail or fax.

Step 3: We will issue a Return Authorization Number upon verification into the program.

Step 4: A monitor will be advance shipped to your location.

Step 5: We will issue a UPS Call Tag to pick up the defective unit.

Step 6: Please review the following chart to see your EASE program qualifications.

| WARRANTY PERIOD | COVERAGE AT NO CHARGE | CUSTOMER CHARGES |
|--|--|-----------------------------|
| Within the first three months of purchase: Covered by EASE | - New AOC monitor - Call tag dispatched and return freight charges via UPS | - None* |
| Between 4 months – 1 Year | - All Parts & Labor Including CRT Tube & LCD Panel | - UPS Return Freight to AOC |
| Between 1 Year - 3 Years: Covered by standard limited warranty | - Parts & Labor (excluding CRT Tube & LCD Panel) | - UPS Return Freight to AOC |

*AOC will need to obtain a credit card number if you would like to get a new AOC monitor advanced shipped to your location, prior to the defective unit arriving at AOC's service center. If you do not wish to supply a credit card, AOC will only ship the new monitor, once the defective unit arrives at the AOC service center.

