

Q87T
Q87T/CSM

ASUS[®]

Motherboard

E8629
First Edition
September 2013

Copyright © 2013 ASUSTeK COMPUTER INC. All Rights Reserved.

No part of this manual, including the products and software described in it, may be reproduced, transmitted, transcribed, stored in a retrieval system, or translated into any language in any form or by any means, except documentation kept by the purchaser for backup purposes, without the express written permission of ASUSTeK COMPUTER INC. ("ASUS").

Product warranty or service will not be extended if: (1) the product is repaired, modified or altered, unless such repair, modification or alteration is authorized in writing by ASUS; or (2) the serial number of the product is defaced or missing.

ASUS PROVIDES THIS MANUAL "AS IS" WITHOUT WARRANTY OF ANY KIND, EITHER EXPRESS OR IMPLIED, INCLUDING BUT NOT LIMITED TO THE IMPLIED WARRANTIES OR CONDITIONS OF MERCHANTABILITY OR FITNESS FOR A PARTICULAR PURPOSE. IN NO EVENT SHALL ASUS, ITS DIRECTORS, OFFICERS, EMPLOYEES OR AGENTS BE LIABLE FOR ANY INDIRECT, SPECIAL, INCIDENTAL, OR CONSEQUENTIAL DAMAGES (INCLUDING DAMAGES FOR LOSS OF PROFITS, LOSS OF BUSINESS, LOSS OF USE OR DATA, INTERRUPTION OF BUSINESS AND THE LIKE), EVEN IF ASUS HAS BEEN ADVISED OF THE POSSIBILITY OF SUCH DAMAGES ARISING FROM ANY DEFECT OR ERROR IN THIS MANUAL OR PRODUCT.

SPECIFICATIONS AND INFORMATION CONTAINED IN THIS MANUAL ARE FURNISHED FOR INFORMATIONAL USE ONLY, AND ARE SUBJECT TO CHANGE AT ANY TIME WITHOUT NOTICE, AND SHOULD NOT BE CONSTRUED AS A COMMITMENT BY ASUS. ASUS ASSUMES NO RESPONSIBILITY OR LIABILITY FOR ANY ERRORS OR INACCURACIES THAT MAY APPEAR IN THIS MANUAL, INCLUDING THE PRODUCTS AND SOFTWARE DESCRIBED IN IT.

Products and corporate names appearing in this manual may or may not be registered trademarks or copyrights of their respective companies, and are used only for identification or explanation and to the owners' benefit, without intent to infringe.

Offer to Provide Source Code of Certain Software

This product contains copyrighted software that is licensed under the General Public License ("GPL"), under the Lesser General Public License Version ("LGPL") and/or other Free Open Source Software Licenses. Such software in this product is distributed without any warranty to the extent permitted by the applicable law. Copies of these licenses are included in this product.

Where the applicable license entitles you to the source code of such software and/or other additional data, you may obtain it for a period of three years after our last shipment of the product, either

(1) for free by downloading it from <http://support.asus.com/download>
or

(2) for the cost of reproduction and shipment, which is dependent on the preferred carrier and the location where you want to have it shipped to, by sending a request to:

ASUSTeK Computer Inc.
Legal Compliance Dept.
15 Li Te Rd.,
Beitou, Taipei 112
Taiwan

In your request please provide the name, model number and version, as stated in the About Box of the product for which you wish to obtain the corresponding source code and your contact details so that we can coordinate the terms and cost of shipment with you.

The source code will be distributed WITHOUT ANY WARRANTY and licensed under the same license as the corresponding binary/object code.

This offer is valid to anyone in receipt of this information.

ASUSTeK is eager to duly provide complete source code as required under various Free Open Source Software licenses. If however you encounter any problems in obtaining the full corresponding source code we would be much obliged if you give us a notification to the email address gpl@asus.com, stating the product and describing the problem (please DO NOT send large attachments such as source code archives, etc. to this email address).

Contents

Safety information	iv
About this guide	iv
Package contents	vi
Q87T specifications summary	vi

Product introduction

1.1	Before you proceed	1-1
1.2	Motherboard overview	1-1
1.3	Central Processing Unit (CPU)	1-3
1.4	System memory	1-7
1.5	Expansion slots	1-9
1.6	Jumpers	1-10
1.7	Connectors	1-13
1.8	Onboard LEDs	1-21
1.9	Software support	1-22

BIOS information

2.1	Managing and updating your BIOS	2-1
2.2	BIOS setup program	2-5
2.3	My Favorites	2-9
2.4	Main menu	2-10
2.5	Ai Tweaker menu	2-12
2.6	Advanced menu	2-23
2.7	Monitor menu	2-37
2.8	Boot menu	2-40
2.9	Tools menu	2-47
2.10	Exit menu	2-48

Appendices

Notices	A-1
ASUS contact information	A-3

Safety information

Electrical safety

- To prevent electrical shock hazard, disconnect the power cable from the electrical outlet before relocating the system.
- When adding or removing devices to or from the system, ensure that the power cables for the devices are unplugged before the signal cables are connected. If possible, disconnect all power cables from the existing system before you add a device.
- Before connecting or removing signal cables from the motherboard, ensure that all power cables are unplugged.
- Seek professional assistance before using an adapter or extension cord. These devices could interrupt the grounding circuit.
- Ensure that your power supply is set to the correct voltage in your area. If you are not sure about the voltage of the electrical outlet you are using, contact your local power company.
- If the power supply is broken, do not try to fix it by yourself. Contact a qualified service technician or your retailer.

Operation safety

- Before installing the motherboard and adding components, carefully read all the manuals that came with the package.
- Before using the product, ensure all cables are correctly connected and the power cables are not damaged. If you detect any damage, contact your dealer immediately.
- To avoid short circuits, keep paper clips, screws, and staples away from connectors, slots, sockets and circuitry.
- Avoid dust, humidity, and temperature extremes. Do not place the product in any area where it may be exposed to moisture.
- Place the product on a stable surface.
- If you encounter technical problems with the product, contact a qualified service technician or your retailer.

About this guide

This user guide contains the information you need when installing and configuring the motherboard.

How this guide is organized

This guide contains the following parts:

- **Chapter 1: Product introduction**
This chapter describes the features of the motherboard and the new technology it supports. It includes descriptions of the switches, jumpers, and connectors on the motherboard.
- **Chapter 2: BIOS information**
This chapter discusses changing system settings through the BIOS Setup menus. Detailed descriptions of the BIOS parameters are also provided.

Where to find more information

Refer to the following sources for additional information and for product and software updates.

1. ASUS websites

The ASUS website provides updated information on ASUS hardware and software products. Refer to the ASUS contact information.

2. Optional documentation

Your product package may include optional documentation, such as warranty flyers, that may have been added by your dealer. These documents are not part of the standard package.

Conventions used in this guide

To ensure that you perform certain tasks properly, take note of the following symbols used throughout this manual.



DANGER/WARNING: Information to prevent injury to yourself when completing a task.



CAUTION: Information to prevent damage to the components when completing a task.



IMPORTANT: Instructions that you **MUST** follow to complete a task.



NOTE: Tips and additional information to help you complete a task.

Typography

Bold text

Indicates a menu or an item to select.

Italics

Used to emphasize a word or a phrase.

<Key>

Keys enclosed in the less-than and greater-than sign means that you must press the enclosed key.

Example: <Enter> means that you must press the Enter or Return key.

<Key1> + <Key2> + <Key3>

If you must press two or more keys simultaneously, the key names are linked with a plus sign (+).

Package contents

Check your motherboard package for the following items.

Motherboard	ASUS Q87T motherboard
Cables	2 x Serial ATA 6.0 Gb/s cables, 1 x SATA power cable
Accessories	2 x I/O Shield (1 x mini-ITX, 1 x thin mini-ITX)
Application DVD	Support DVD
Documentation	User Guide



If any of the above items is damaged or missing, contact your retailer.

Q87T specifications summary

CPU	LGA1150 socket for Intel® 4th Generation Core™ i7 / i5 / i3, Pentium®, and Celeron® processors Supports 22nm CPU* Supports Intel® Turbo Boost Technology 2.0** * Up to 65W Thermal Design Power support for Intel® standard thin mini-ITX heatsink. Up to 84W Thermal Design Power support for standard 1150/1155 heatsink. ** Intel® Turbo Boost Technology 2.0 support depends on the CPU type. *** Refer to www.asus.com for Intel® CPU support list.
Chipset	Intel® Q87 Express Chipset
Memory	2 x SO-DIMMs, max. 16GB, DDR3 1600 / 1333 / 1066 MHz, non-ECC, un-buffered memory Dual-channel memory architecture * Refer to www.asus.com for the latest Memory QVL (Qualified Vendors List). ** When you install a total memory of 4GB capacity or more, Windows® 32-bit operating system may only recognize less than 3GB. We recommend a maximum of 3GB system memory if you are using a Windows® 32-bit operating system.
Graphics	Integrated graphics processor Multi-VGA output support: DisplayPort / eDP / HDMI / LVDS* - Supports DisplayPort 1.2 / eDP with max. resolution of 4096 x 2160@24Hz / 3840 x 2160 @60Hz - Supports HDMI with max. resolution of 4096 x 2160 @24Hz / 2560 x 1600 @60Hz - Supports LVDS with max.resolution of 1920 x 1200 @60Hz Maximum shared memory of 1024 MB *LVDS and eDP share the same video output. An onboard header is available to switch output.
Expansion slots	1 x PCI Express 3.0/2.0 x4 slot 1 x mini PCIe (full length, with mSATA support) 1 x mini PCIe (half length) *mSATA shares the same slot with the full-length mini PCIe. When an mSATA card is inserted, the mini PCIe slot is not available.

(continued on the next page)

Q87T specifications summary

Storage	<p>Intel® Q87 Express Chipset:</p> <ul style="list-style-type: none"> - 4 x Serial ATA 6.0 Gb/s connector - 1 x mSATA connector* <p>*mSATA shares the same slot with the full-length mini-PCIe card. A mini-PCIe card cannot be used if an mSATA card is inserted into the slot.</p>
LAN	<p>Dual LAN support</p> <ul style="list-style-type: none"> - Intel® I217LM Gigabit LAN controller - Realtek® 8111G Gigabit LAN controller
Audio	<p>8-channel Realtek® ALC887-VD High Definition Audio CODEC</p> <ul style="list-style-type: none"> - Supports Jack-Detection, Multi-streaming, Anti-pop Function, Front Panel Retasking <p>* Use a chassis with HD audio module in the front panel to support an 8-channel audio output.</p>
USB	<p>5 x USB 2.0 ports (5 ports at mid-board, 2 x 2-port header and 1 x 1-port header)</p> <p>6 x USB 3.0 ports (2 ports at mid-board, 4 ports at back panel)</p>
ASUS unique features	<p>ASUS EZ DIY:</p> <ul style="list-style-type: none"> - ASUS CrashFree BIOS 3 - ASUS EZ Flash 2 - ASUS MyLogo 2™ <p>ASUS Exclusive Features</p> <ul style="list-style-type: none"> - ASUS USB 3.0 Boost - ASUS Network iControl - ASUS AI Suite III - ASUS Ai Charger - ASUS UEFI BIOS EZ Mode - ASUS Enhanced DRAM Overcurrent Protection - Short circuit damage prevention - ASUS ESD Guards - Enhanced ESD protection <p>ASUS Quiet Thermal Solution:</p> <ul style="list-style-type: none"> - ASUS Fan Xpert <p>100% Solid Capacitors</p>
Rear panel I/O ports	<p>1 x DC Power connector</p> <p>1 x DisplayPort port</p> <p>1 x HDMI port</p> <p>2 x LAN (RJ-45) port</p> <p>4 x USB 3.0 ports</p> <p>2 x Audio jacks</p>

(continued on the next page)

Q87T specifications summary

<p>Internal connectors/ switches/ buttons</p>	<p>1 x USB 3.0 connector supports additional 2 USB 3.0 ports 2 x USB 2.0 2-port connectors support additional 4 USB 2.0 ports 1 x USB 2.0 1-port connectors support additional 1 USB 2.0 ports 1 x eDP connector 1 x LVDS connector 1 x eDP/LVDS switch jumper 4 x SATA 6.0Gb/s connector 1 x mSATA connector 1 x CPU fan connector 1 x Chassis fan connector 1 x Front panel audio connector (AAFP) 1 x System panel connector 1 x Clear CMOS jumper 1 x DIS ME jumper 1 x COM port header 1 x Chassis intrusion header 1 x SATA power connector</p> <p>Connectors for AIO System</p> <p>1 x 2-pin internal DC power connector 1 x Stereo speaker connector 1 x DMIC header 1 x Custom solutions header</p> <p>Connectors for Flat Panel Display</p> <p>1 x Backlight inverter voltage selection header 1 x FPD brightness header 1 x Panel voltage selection header 1 x Panel off header</p> <p>TPM IC Onboard</p>
<p>BIOS features</p>	<p>128 Mb Flash ROM, AMI BIOS, PnP, DMI v2.0, WfM2.0, SM BIOS v2.5, ACPI v2.0a, Multi-language BIOS, ASUS EZ Flash 2, ASUS CrashFree BIOS 3</p>
<p>Manageability</p>	<p>WfM 2.0, DMI 2.0, WOL by PME, WOR by PME, PXE</p>
<p>Support DVD</p>	<p>Drivers ASUS utilities ASUS Update Anti-virus software (OEM version)</p>
<p>Form factor</p>	<p>Thin mini-ITX form factor: 6.7" x 6.7" (17.0cm x 17.0cm)</p>



Specifications are subject to change without notice.

Product introduction

1

1.1 Before you proceed

Take note of the following precautions before you install motherboard components or change any motherboard settings.



-
- Unplug the power cord from the wall socket before touching any component.
 - Before handling components, use a grounded wrist strap or touch a safely grounded object or a metal object, such as the power supply case, to avoid damaging them due to static electricity.
 - Hold components by the edges to avoid touching the ICs on them.
 - Whenever you uninstall any component, place it on a grounded antistatic pad or in the bag that came with the component.
 - Before you install or remove any component, ensure that the ATX power supply is switched off or the power cord is detached from the power supply. Failure to do so may cause severe damage to the motherboard, peripherals, or components.
-

1.2 Motherboard overview

Before you install the motherboard, study the configuration of your chassis to ensure that the motherboard fits.



Unplug the power cord before installing or removing the motherboard. Failure to do so can cause you physical injury and damage to motherboard components.

1.2.1 Placement direction

When installing the motherboard, place it into the chassis in the correct orientation. The edge with external ports goes to the rear part of the chassis as indicated in the image.

1.2.2 Screw holes

Place six screws into the holes indicated by circles to secure the motherboard to the chassis.



Do not overtighten the screws! Doing so can damage the motherboard.

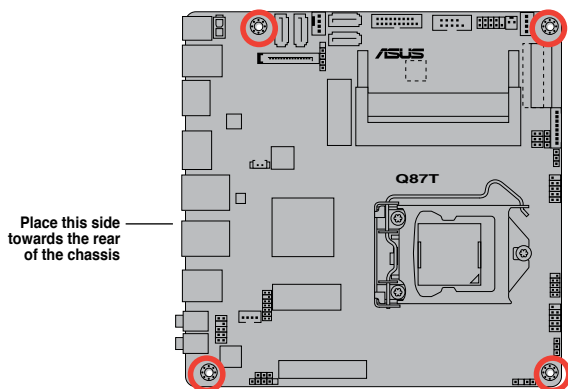

1.2.3 Motherboard layout

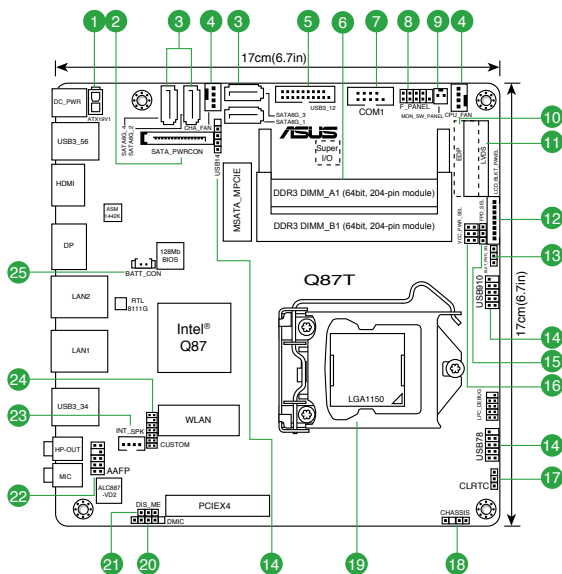

1.2.4 Layout contents

Connectors/Jumpers/Slots/LED	Page
1. ATX power connector (2-pin ATX19V)	1-15
2. SATA power connector (15-pin SATA_PWRCON)	1-16
3. Intel® Q87 Serial ATA 6.0Gb/s connector (7-pin SATA6G_1~4 [yellow])	1-15
4. CPU and chassis fan connectors (4-pin CPU_FAN, 4-pin CHA_FAN)	1-14
5. USB 3.0 connector (20-1 pin USB3_12)	1-17
6. DDR3 SO-DIMM slots	1-7
7. Serial port connector (10-1 pin COM)	1-14
8. System panel connector (10-1 pin F_PANEL)	1-18
9. Display panel power button (2-1 pin MON_SW_PANEL)	1-18
10. Embedded DisplayPort (30-pin eDP)	1-19
11. LVDS connector (30-pin LVDS)	1-19
12. Flat panel display brightness (8-pin LCD_BLK_PANEL)	1-20
13. Display panel backlight power selector (BLKT_PWR_SEL)	1-12
14. USB 2.0 connectors (5-1 pin USB14, 10-1 pin USB78, 10-2 pin USB910)	1-17
15. LVDS panel or eDP selector (3-pin FPD_SEL)	1-12
16. Display panel VCC power selector (6-pin VCC_PWR_SEL)	1-12
17. Clear RTC RAM (3-pin CLRTC)	1-10
18. Chassis intrusion connector (4-1 pin CHASSIS)	1-11
19. Intel® LGA1150 CPU socket	1-3
20. DMIC connectors (5-1 pin DMIC)	1-20
21. Intel® ME jumper (3-pin DIS_ME)	1-11
22. Front panel audio connector (10-1 pin AAFP)	1-16
23. Internal stereo speaker header (4-pin INT_SPK)	1-20
24. Custom header (14-1 pin CUSTOM)	1-20
25. RTC battery header (2-pin BATT_CON)	1-19

1.3 Central Processing Unit (CPU)

This motherboard comes with a surface mount LGA1150 socket designed for the Intel 4th generation Core™ i7 / Core™ i5 / Core™ i3, Pentium®, Celeron® processors.

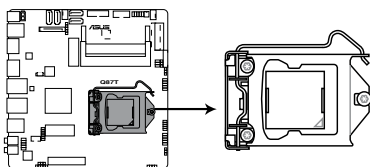

Q87T CPU socket LGA1150



Unplug all power cables before installing the CPU.



- Upon purchase of the motherboard, ensure that the PnP cap is on the socket and the socket contacts are not bent. Contact your retailer immediately if the PnP cap is missing, or if you see any damage to the PnP cap/socket contacts/motherboard components. ASUS will shoulder the cost of repair only if the damage is shipment/transit-related.
 - Keep the cap after installing the motherboard. ASUS will process Return Merchandise Authorization (RMA) requests only if the motherboard comes with the cap on the LGA1150 socket.
 - The product warranty does not cover damage to the socket contacts resulting from incorrect CPU installation/removal, or misplacement/loss/incorrect removal of the PnP cap.
-

1.3.1 Installing the CPU

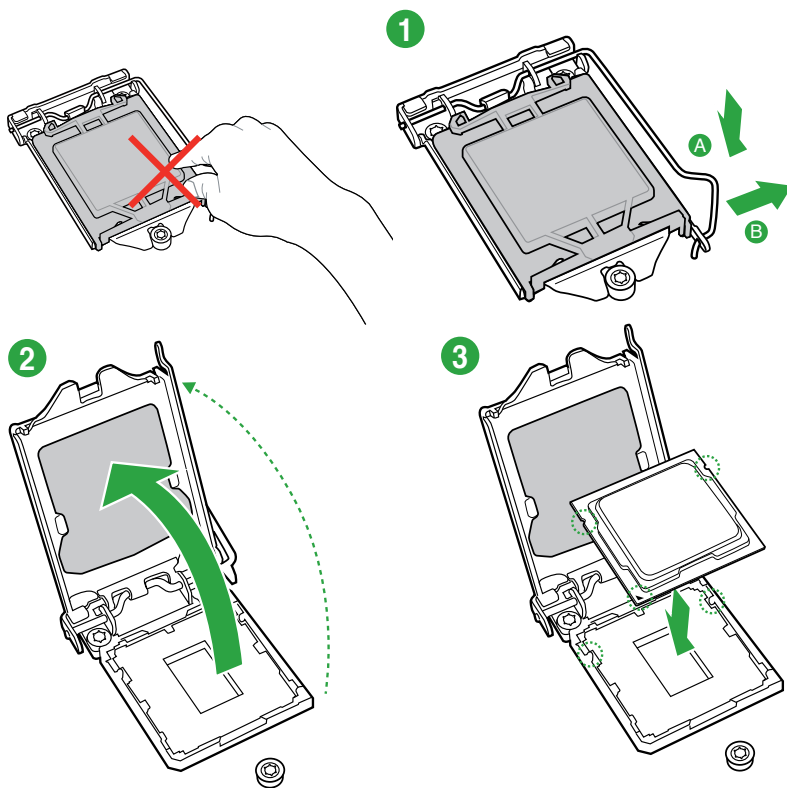

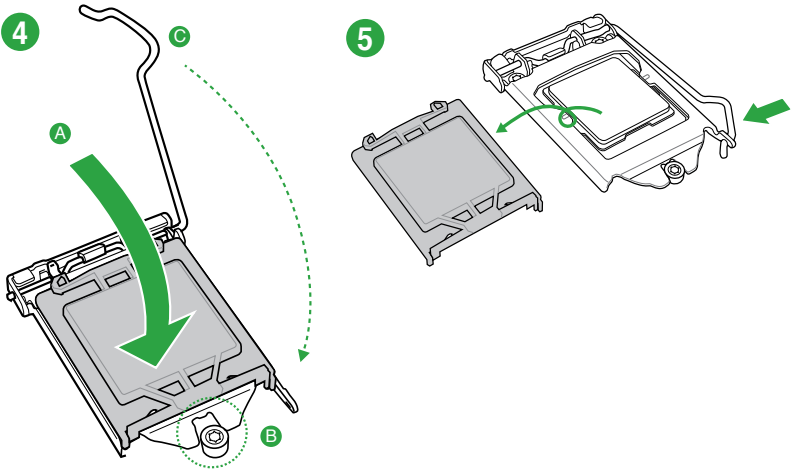

1.3.2 CPU heatsink and fan assembly installation

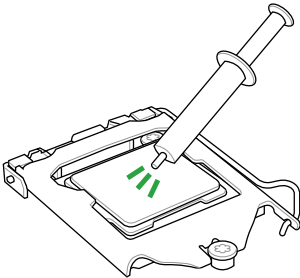

Apply the Thermal Interface Material to the CPU heatsink and CPU before you install the heatsink and fan if necessary.

To install the CPU heatsink and fan assembly

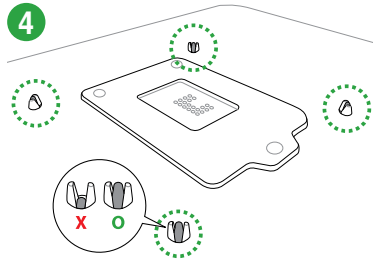
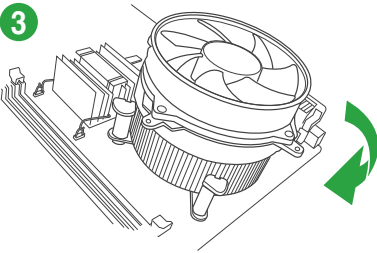
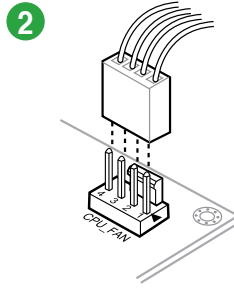
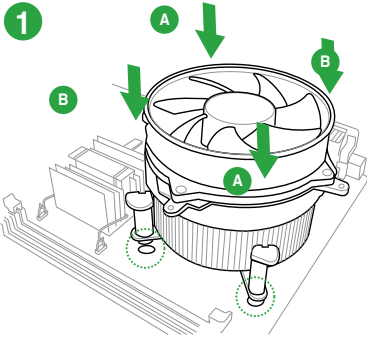

To uninstall the CPU heatsink and fan assembly

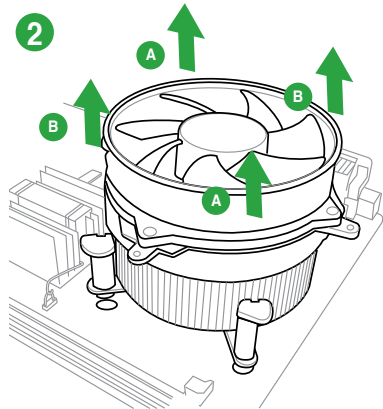
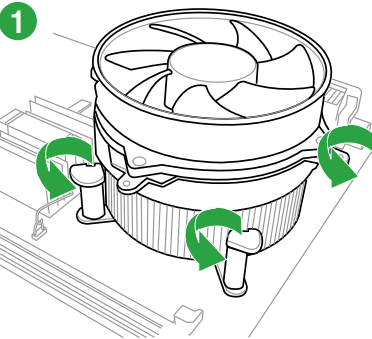

1.4 System memory

1.4.1 Overview

This motherboard comes with two Double Data Rate 3 (DDR3) Small Outline Dual Inline Memory Module (SO-DIMM) sockets. The figure illustrates the location of the DDR3 SO-DIMM sockets:

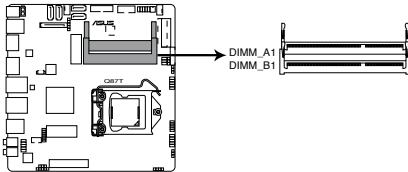

Channel	Sockets
Channel A	DIMM_A1
Channel B	DIMM_B1

Q87T 204-pin DDR3 DIMM sockets

1.4.2 Memory configurations

You may install 1GB, 2GB, 4GB, and 8GB unbuffered non-ECC DDR3 DIMMs into the DIMM sockets.



- You may install varying memory sizes in Channel A and Channel B. The system maps the total size of the lower-sized channel for the dual-channel configuration. Any excess memory from the higher-sized channel is then mapped for single-channel operation.
- Always install DIMMs with the same CAS latency. For optimal compatibility, we recommend that you install memory modules of the same version or date code (D/C) from the same vendor. Check with the retailer to get the correct memory modules.
- Due to the memory address limitation on 32-bit Windows® OS, when you install 4GB or more memory on the motherboard, the actual usable memory for the OS can be about 3GB or less. For effective use of memory, we recommend that you do any of the following:
 - Use a maximum of 3GB system memory if you are using a 32-bit Windows® OS.
 - Install a 64-bit Windows® OS if you want to install 4GB or more on the motherboard.
- This motherboard does not support DIMMs made up of 512 megabits (Mb) chips or less.
- Memory modules with memory frequency higher than 2133 MHz and its corresponding timing or the loaded X.M.P. Profile is not the JEDEC memory standard. The stability and compatibility of these memory modules depend on the CPU's capabilities and other installed devices.
- The maximum 16GB memory capacity can be supported with 8GB or above DIMMs. ASUS will update the memory QVL once the DIMMs are available in the market.



- The default memory operation frequency is dependent on its Serial Presence Detect (SPD), which is the standard way of accessing information from a memory module. Under the default state, some memory modules for overclocking may operate at a lower frequency than the vendor-marked value. To operate at the vendor-marked or at a higher frequency, refer to section **2.5 Ai Tweaker menu** for manual memory frequency adjustment.
- For system stability, use a more efficient memory cooling system to support a full memory load (4 DIMMs) or overclocking condition.
- Visit the ASUS website at: www.asus.com for the latest QVL.

1.4.3 Installing a DIMM

To install a DIMM

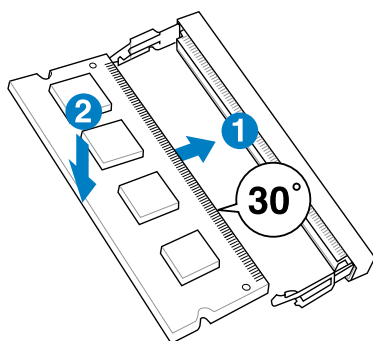

To remove a DIMM

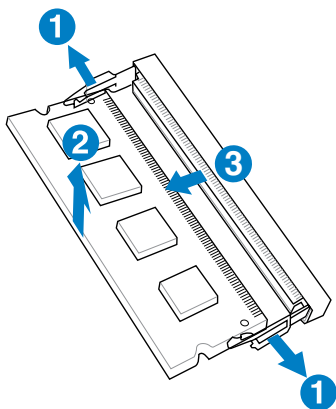

1.5 Expansion slots

In the future, you may need to install expansion cards. The following sub-sections describe the slots and the expansion cards that they support.



Unplug the power cord before adding or removing expansion cards. Failure to do so may cause you physical injury and damage motherboard components.

1.5.1 Installing an expansion card

To install an expansion card:

1. Before installing the expansion card, read the documentation that came with it and make the necessary hardware settings for the card.
2. Remove the system unit cover (if your motherboard is already installed in a chassis).
3. Remove the bracket opposite the slot that you intend to use. Keep the screw for later use.
4. Align the card connector with the slot and press firmly until the card is completely seated on the slot.
5. Secure the card to the chassis with the screw you removed earlier.
6. Replace the system cover.

1.5.2 Configuring an expansion card

After installing the expansion card, configure it by adjusting the software settings.

1. Turn on the system and change the necessary BIOS settings, if any. See Chapter 2 for information on BIOS setup.
2. Assign an IRQ to the card.
3. Install the software drivers for the expansion card.



When using PCI cards on shared slots, ensure that the drivers support “Share IRQ” or that the cards do not need IRQ assignments. Otherwise, conflicts will arise between the two PCI groups, making the system unstable and the card inoperable.

1.5.3 PCI Express 3.0/2.0 x4 slot

This motherboard supports PCI Express x4 network cards, SCSI cards, and other cards that comply with the PCI Express specifications.

IRQ assignments for this motherboard

	A	B	C	D	E	F	G	H
Intel PCH SATA controller #0	–	–	–	shared	–	–	–	–
Intel PCH SATA controller #1	–	–	–	shared	–	–	–	–
Realtek 8111G controller	–	–	shared	–	–	–	–	–

1.6 Jumpers

1. Clear RTC RAM (3-pin CLRRTC)

This jumper allows you to clear the Real Time Clock (RTC) RAM in CMOS. You can clear the CMOS memory of date, time, and system setup parameters by erasing the CMOS RTC RAM data. The onboard button cell battery powers the RAM data in CMOS, which include system setup information such as system passwords.

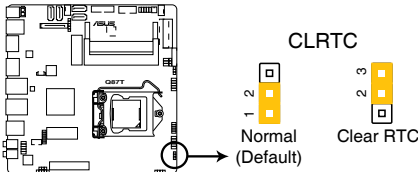

Q87T Clear RTC RAM

To erase the RTC RAM:

1. Turn OFF the computer and unplug the power cord.
2. Move the jumper cap from pins 1-2 (default) to pins 2-3. Keep the cap on pins 2-3 for about 5-10 seconds, then move the cap back to pins 1-2.
3. Plug the power cord and turn ON the computer.
4. Hold down the key during the boot process and enter BIOS setup to re-enter data.



Except when clearing the RTC RAM, never remove the cap on CLRRTC jumper default position. Removing the cap will cause system boot failure!



- If the steps above do not help, remove the onboard battery and move the jumper again to clear the CMOS RTC RAM data. After clearing the CMOS, reinstall the battery.
 - You do not need to clear the RTC when the system hangs due to overclocking. For system failure due to overclocking, use the CPU Parameter Recall (C.P.R.) feature. Shut down and reboot the system, then the BIOS automatically resets parameter settings to default values.
-

2. Intel® ME jumper (3-pin DIS_ME)

This jumper allows you to enable or disable the Intel® ME function. Set this jumper to pins 1-2 to enable (default) the Intel® ME function and to pins 2-3 to disable it.

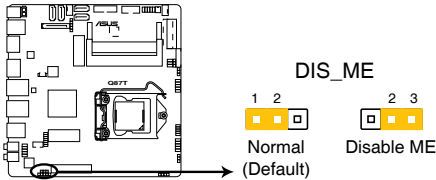

Q87T Intel® ME jumper



Disable the Intel® ME function before updating it.

3. Chassis intrusion connector (4-1 pin CHASSIS)

This connector is for a chassis-mounted intrusion detection sensor or switch. Connect one end of the chassis intrusion sensor or switch cable to this connector. The chassis intrusion sensor or switch sends a high-level signal to this connector when a chassis component is removed or replaced. The signal is then generated as a chassis intrusion event.

By default, the pins labeled “Intruder” are shorted with a jumper cap. Remove the jumper caps only when you intend to use the chassis intrusion detection feature.

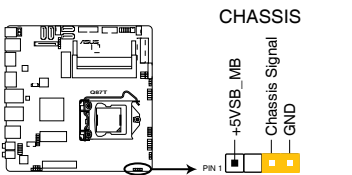

Q87T Chassis intrusion connector

4. Display panel backlight power selector (BLKT_PWR_SEL)

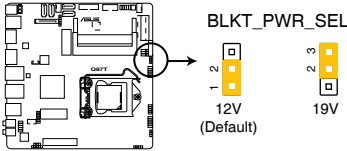

Q87T Display panel backlight power selection

Pins	Setting
1-2	12V
2-3	19V

5. LVDS panel or eDP selector (3-pin FPD_SEL)

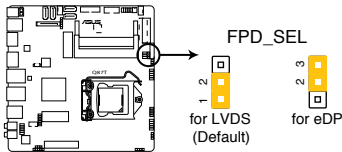

Q87T LVDS or eDP selection

Pins	Setting
1-2	LVDS (Default)
2-3	eDP

6. Display panel VCC power selector (VCC_PWR_SEL)

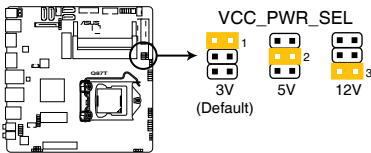

Q87T Display panel VCC power

Pins	Setting
1	3V
2	5V
3	12V

1.7 Connectors

1.7.1 Rear panel connectors

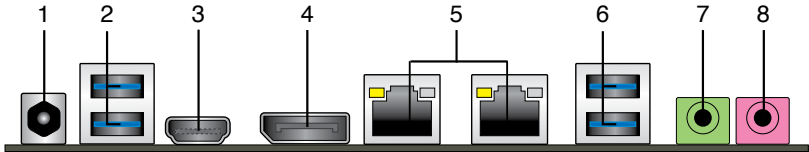

1. **DC power connector.** Insert the power adapter into this port.
2. **USB 3.0 ports 5 and 6.** These two 9-pin Universal Serial Bus (USB) ports are for connecting USB 3.0 devices.
3. **HDMI port.** This port is for a High-Definition Multimedia Interface (HDMI) connector, and is HDCP compliant allowing playback of HD DVD, Blu-ray, and other protected content.
4. **DisplayPort.** Connect a DisplayPort cable into this port for high-definition video and audio.
5. **LAN (RJ-45) port.** These ports allow Gigabit connection to a Local Area Network (LAN) through a network hub.

LAN port LED indications

Activity/Link LED		Speed LED	
Status	Description	Status	Description
OFF	No link	OFF	10Mbps connection
GREEN	Linked	ORANGE	100Mbps connection
GREEN	Data activity	GREEN	1Gbps connection

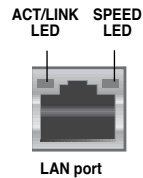

6. **USB 3.0 ports 3 and 4.** These two 9-pin Universal Serial Bus (USB) ports are for connecting USB 3.0 devices.
7. **Line Out port (lime).** This port connects to a headphone or a speaker.
8. **Microphone port (pink).** This port connects to a microphone.

1.7.2 Internal connectors

1. Serial port connector (10-1 pin COM)

This connector is for a serial (COM) port. Connect the serial port module cable to this connector, then install the module to a slot opening at the back of the system chassis.

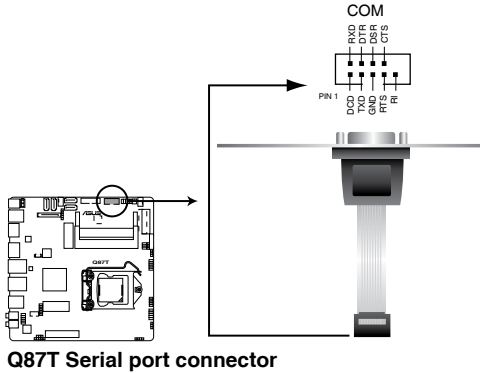

The COM module is purchased separately.

2. CPU and chassis fan connectors (4-pin CPU_FAN, and 4-pin CHA_FAN)

Connect the fan cables to the fan connectors on the motherboard, ensuring that the black wire of each cable matches the ground pin of the connector.

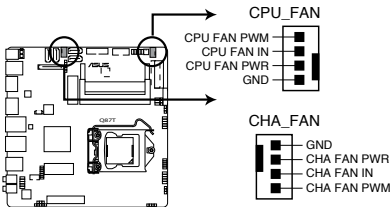

Q87T Fan connectors



DO NOT forget to connect the fan cables to the fan connectors. Insufficient air flow inside the system may damage the motherboard components. These are not jumpers! DO NOT place jumper caps on the fan connectors.

3. ATX power connector (2-pin ATX19V)

This connector is for an ATX power supply. The plug from the power supply is designed to fit this connector in only one orientation. Find the proper orientation and push down firmly until the connector completely fits.

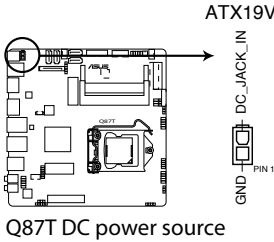

4. Serial ATA 6.0 Gb/s connectors (7-pin SATA6G 1~4)

These connectors connect to Serial ATA 6.0 Gb/s hard disk drives via Serial ATA 6.0 Gb/s signal cables.

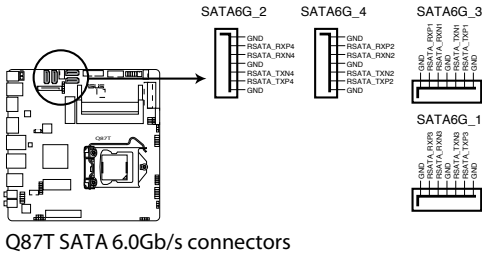

When using hot-plug and NCQ, set the type of the SATA connectors in the BIOS to **[AHCI]**. See section **2.6.4 SATA Configuration** for details.

5. Front panel audio connector (10-1 pin AAFP)

This connector is for a chassis-mounted front panel HD audio I/O module. Connect one end of the front panel audio I/O module cable to this connector.

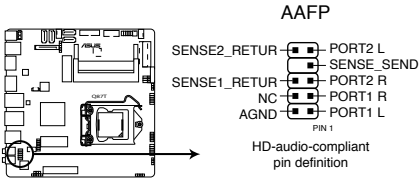

Q87T Front panel audio connector



We recommend that you connect a high-definition front panel audio module to this connector to avail of the motherboard's high-definition audio capability.

6. SATA power connector (15-pin SATA_PWRCON)

This connector is for the SATA power cable. The power cable plug is designed to fit this connector in only one orientation. Find the proper orientation and push down firmly until the connector completely fit. To provide power to your SATA device, connect the SATA power cable to this connector.

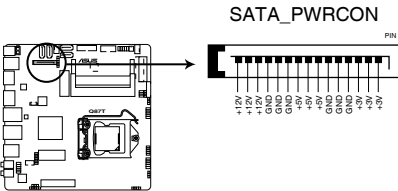

Q87T SATA HDD power source

7. USB 3.0 connector (20-1 pin USB3_12)

This connector allows you to connect a USB 3.0 module for additional USB 3.0 front or rear panel ports. With an installed USB 3.0 module, you can enjoy all the benefits of USB 3.0 including faster data transfer speeds of up to 4.8Gbps, faster charging time for USB-chargable devices, optimized power efficiency, and backward compatibility with USB 2.0.

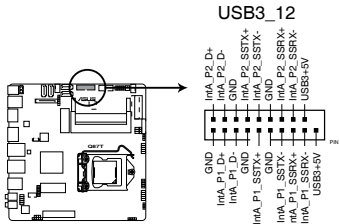

Q87T USB3.0 Front panel connector



The USB 3.0 module is purchased separately.

8. USB 2.0 connectors (10-1 pin USB14, USB78, USB910)

These connectors are for USB 2.0 ports. Connect the USB module cable to any of these connectors, then install the module to a slot opening at the back of the system chassis. These USB connectors comply with USB 2.0 specifications and supports up to 480Mbps connection speed.

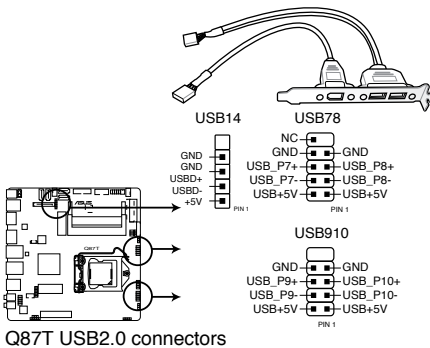

Q87T USB2.0 connectors



Never connect a 1394 cable to the USB connectors. Doing so will damage the motherboard!



The USB 2.0 module is purchased separately.

9. System panel connector (10-1 pin PANEL)

This connector supports several chassis-mounted functions.

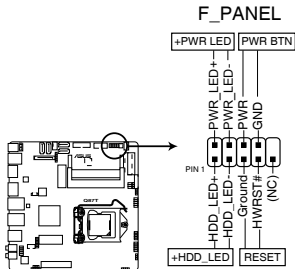

Q87T System panel connector

- **System power LED (2-pin PWR_LED)**

This 2-pin connector is for the system power LED. Connect the chassis power LED cable to this connector. The system power LED lights up when you turn on the system power, and blinks when the system is in sleep mode.

- **Hard disk drive activity LED (2-pin HDD_LED)**

This 2-pin connector is for the HDD Activity LED. Connect the HDD Activity LED cable to this connector. The HDD LED lights up or flashes when data is read from or written to the HDD.

- **ATX power button/soft-off button (2-pin PWR_BTN)**

This connector is for the system power button.

- **Reset button (2-pin RESET)**

This 2-pin connector is for the chassis-mounted reset button for system reboot without turning off the system power.

10. Display panel power button (2-1 pin MON_SW_PANEL)

This connector is used for the display panel power switch.

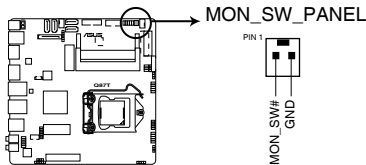

Q87T Display panel power button

11. RTC Battery header (2-pin BATT_CON)

This connector is for the lithium CMOS battery.

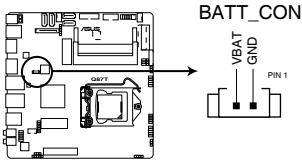

Q87T RTC battery header

12. Embedded DisplayPort (40-pin eDP)

The connector is for an internal embedded DisplayPort connection.

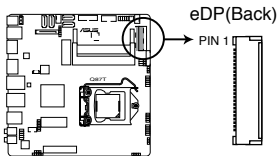

Q87T embedded Display Port

13. LVDS connector (40-pin LVDS)

This connector is for an LCD monitor that supports Low-voltage Differential Signaling (LVDS) interface.

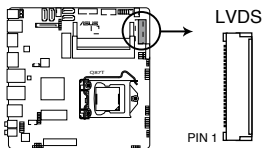

Q87T LVDS connector

14. Flat panel display brightness (8-pin LCD_BLK_PANEL)

This connector is for the LCD panel brightness controls.

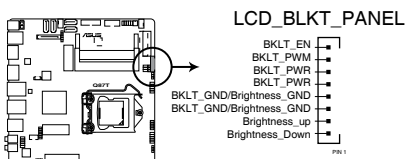

Q87T Flat Panel Display Brightness

15. Internal stereo speaker header (2-pin INT_SPK)

The internal mono speaker header allows connection to an internal, low-power speaker for basic system sound capability. The subsystem is capable of driving a speaker load of 4 Ohms at 3 Watts (rms).

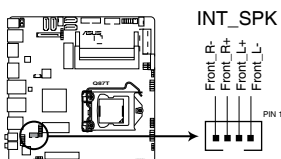

Q87T Internal Stereo Speakers Header

16. Custom header (14-pin CUSTOM)

The custom header is for connecting customized modules for additional features.

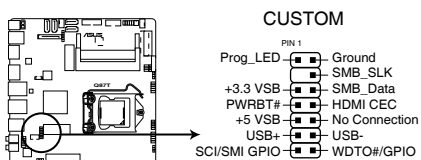

Q87T Custom header

17. DMIC connectors (4-pin DMIC)

The DMIC connector is for connecting the digital microphone module used in All-in-One chassis.

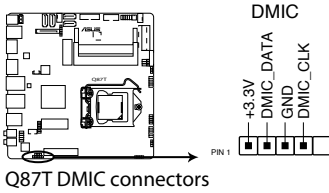

1.8 Onboard LEDs

1. Standby Power LED

The motherboard comes with a standby power LED that lights up to indicate that the system is ON, in sleep mode, or in soft-off mode. This is a reminder that you should shut down the system and unplug the power cable before removing or plugging in any motherboard component. The illustration below shows the location of the onboard LED.

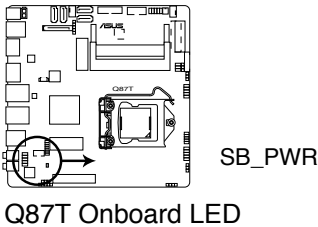

1.9 Software support

1.9.1 Installing an operating system

This motherboard supports Windows® 7, Windows® 8 and Windows® 8.1 (32/64bit) Operating Systems (OS). Always install the latest OS version and corresponding updates to maximize the features of your hardware.



Motherboard settings and hardware options vary. Refer to your OS documentation for detailed information.

1.9.2 Support DVD information

The Support DVD that comes with the motherboard package contains the drivers, software applications, and utilities that you can install to avail all motherboard features.



The contents of the Support DVD are subject to change at any time without notice. Visit the ASUS website at www.asus.com for updates.

To run the Support DVD

Place the Support DVD into the optical drive. If Autorun is enabled in your computer, the DVD automatically displays the Specials screen which lists the unique features of your ASUS motherboard. Click Drivers, Utilities, AHCI/RAID Driver, Manual, Contact, and Specials tabs to display their respective menus.



The following screen is for reference only.

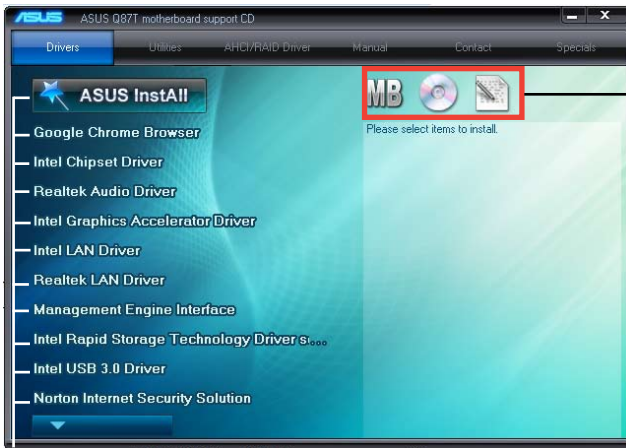

Click an icon to display Support DVD/motherboard information

Click an item to install



If Autorun is NOT enabled in your computer, browse the contents of the Support DVD to locate the file ASSETUP.EXE from the BIN folder. Double-click the ASSETUP.EXE to run the DVD.

1.9.3 Intel® SBA support

Intel® SBA (Small Business Advantage) is a combination of hardware and software that provides unique security and productivity capabilities designed for small businesses.



-
- Intel® SBA requires MEI driver (AMT host software kit) installed.
 - Some models without the 5MB ME firmware do not support Intel® SBA. Please refer to the spec sheet for details.
-

Platform requirements:

- Windows® 7 (32/64bit) / Windows® 8 (32/64bit) / Windows® 8.1 (32/64bit)
- Lynx Point PCH with Core™ Haswell CPU (Shark Bay platforms) with 5MB ME 9.0 firmware load

CPU and chipsets requirements:

- * Intel® Core™ i3 with B85, H87, Q87
- * Intel® Core™ i5 with B85, H87, Q87
- * Intel® Core™ i7 with B85, H87, Q87
- * Intel® Core™ i5 vPro with one of these chipsets: B85, H87, Q87
- * Intel® Core™ i7 vPro with one of these chipsets: B85, H87, Q87
- The Intel® Management Engine software kit must be installed (The Local Manageability Service and the Intel® Management Engine Interface must be installed and running.)
- Local Administrator rights on the target machine



The Intel® SBA does not support the 800 x 600 screen resolution.
Visit the ASUS website at www.asus.com for the latest CPU QVL (Qualified Vendors List).

BIOS information

2

2.1 Managing and updating your BIOS



Save a copy of the original motherboard BIOS file to a USB flash disk in case you need to restore the BIOS in the future. Copy the original motherboard BIOS using the ASUS Update utility.

2.1.1 EZ Update

EZ Update is a utility that allows you to automatically update your motherboard's softwares, drivers and the BIOS version easily. With this utility, you can also manually update the saved BIOS and select a boot logo when the system goes into POST.

To launch EZ Update, click **EZ Update** on the AI Suite 3 main menu bar.

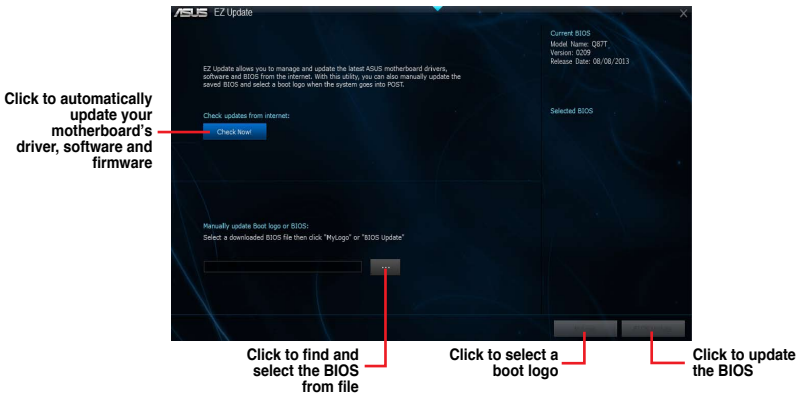

EZ Update requires an Internet connection either through a network or an ISP (Internet Service Provider).

2.1.2 ASUS EZ Flash 2

The ASUS EZ Flash 2 feature allows you to update the BIOS without using an OS-based utility.



Before you start using this utility, download the latest BIOS file from the ASUS website at www.asus.com.

To update the BIOS using EZ Flash 2:

1. Insert the USB flash disk that contains the latest BIOS file to the USB port.
2. Enter the **Advanced Mode** of the BIOS setup program. Go to the **Tool** menu to select **ASUS EZ Flash Utility** and press <Enter> to enable it.
3. Press <Tab> to switch to the **Drive** field.
4. Press the Up/Down arrow keys to find the USB flash disk that contains the latest BIOS, and then press <Enter>.
5. Press <Tab> to switch to the **Folder Info** field.
6. Press the Up/Down arrow keys to find the BIOS file, and then press <Enter> to perform the BIOS update process. Reboot the system when the update process is done.



- This function supports USB flash disks formatted using FAT32/16 on a single partition only.
- DO NOT shut down or reset the system while updating the BIOS to prevent system boot failure!

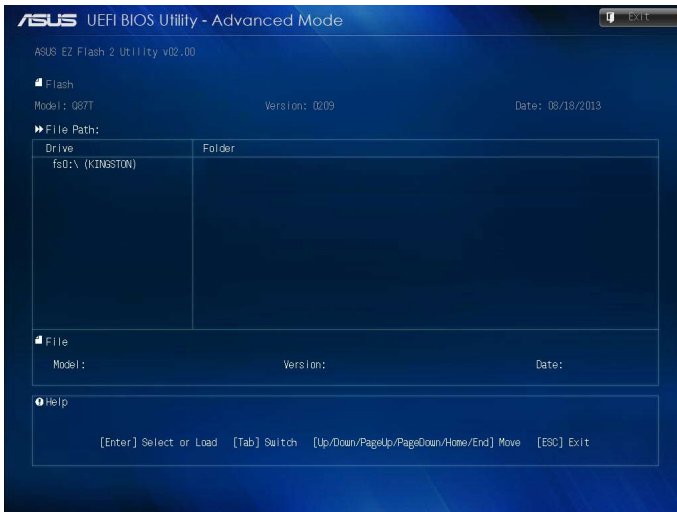

2.1.3 ASUS CrashFree BIOS 3 utility

The ASUS CrashFree BIOS 3 is an auto recovery tool that allows you to restore the BIOS file when it fails or gets corrupted during the updating process. You can restore a corrupted BIOS file using the motherboard support DVD or a USB flash drive that contains the updated BIOS file.



- Before using this utility, rename the BIOS file in the removable device into **Q87T.CAP**.
- The BIOS file in the support DVD may not be the latest version. Download the latest BIOS file from the ASUS website at www.asus.com.

Recovering the BIOS

To recover the BIOS:

1. Turn on the system.
2. Insert the support DVD to the optical drive or the USB flash drive that contains the BIOS file to the USB port.
3. The utility automatically checks the devices for the BIOS file. When found, the utility reads the BIOS file and enters ASUS EZ Flash 2 utility automatically.
4. The system requires you to enter BIOS Setup to recover BIOS settings. To ensure system compatibility and stability, we recommend that you press <F5> to load default BIOS values.



DO NOT shut down or reset the system while updating the BIOS! Doing so can cause system boot failure!

2.1.4 ASUS BIOS Updater

The ASUS BIOS Updater allows you to update BIOS in a DOS environment. This utility also allows you to copy the current BIOS file that you can use as a backup when the BIOS fails or gets corrupted during the updating process.



The succeeding utility screens are for reference only. The actual utility screen displays may not be same as shown.

Before updating BIOS

1. Prepare the motherboard support DVD and a USB flash drive formatted using FAT32/16 on a single partition.
2. Download the latest BIOS file and BIOS Updater from the ASUS website at <http://support.asus.com> and save them on the USB flash drive.



NTFS is not supported under DOS environment. Do not save the BIOS file and BIOS Updater to a hard disk drive or USB flash drive in NTFS format.

3. Turn off the computer and disconnect all SATA hard disk drives (optional).

Booting the system to a DOS environment

1. Insert the USB flash drive with the latest BIOS file and BIOS Updater to the USB port.
2. Boot your computer. When the ASUS Logo appears, press <F8> to show the **BIOS Boot Device Select Menu**. Insert the support DVD into the optical drive and select the optical drive as the boot device.

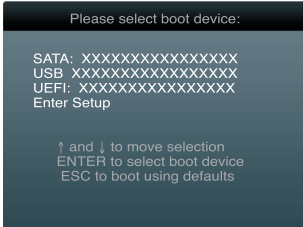

3. When the Make Disk menu appears, select the FreeDOS command prompt item by pressing the item number.
4. At the FreeDOS prompt, type d: and press <Enter> to switch the disk from Drive C (optical drive) to Drive D (USB flash drive).

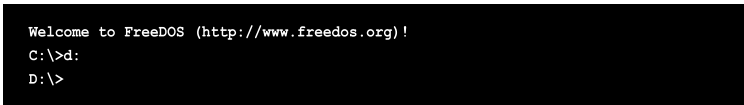

Updating the BIOS file

To update the BIOS file using BIOS Updater:

1. At the FreeDOS prompt, type **bupdater /pc /g** and press <Enter>.



2. The BIOS Updater screen appears as below.

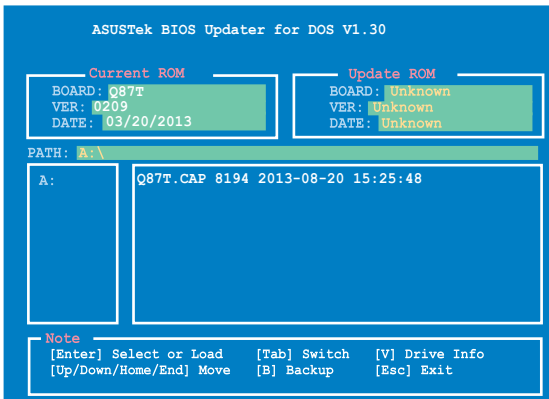

3. Press <Tab> to switch between screen fields and use the <Up/Down/Home/End> keys to select the BIOS file and press <Enter>. BIOS Updater checks the selected BIOS file and prompts you to confirm BIOS update.



4. Select Yes and press <Enter>. When BIOS update is done, press <ESC> to exit BIOS Updater. Restart your computer.



DO NOT shut down or reset the system while updating the BIOS to prevent system boot failure!



- For BIOS Updater version 1.30 or later, the utility automatically exits to the DOS prompt after updating BIOS.
 - Ensure to load the BIOS default settings to ensure system compatibility and stability. Select the Load Optimized Defaults item under the Exit menu. Refer to section **2.10 Exit menu** for details.
 - Ensure to connect all SATA hard disk drives after updating the BIOS file if you have disconnected them.
-

2.2 BIOS setup program

Use the BIOS Setup program to update the BIOS or configure its parameters. The BIOS screens include navigation keys and brief online help to guide you in using the BIOS Setup program.

Entering BIOS Setup at startup

To enter BIOS Setup at startup:

- Press <Delete> during the Power-On Self Test (POST). If you do not press <Delete>, POST continues with its routines.

Entering BIOS Setup after POST

To enter BIOS Setup after POST:

- Press <Ctrl>+<Alt>+ simultaneously.
- Press the reset button on the system chassis.
- Press the power button to turn the system off then back on. Do this option only if you failed to enter BIOS Setup using the first two options.



Using the power button, reset button, or the <Ctrl>+<Alt>+ keys to force reset from a running operating system can cause damage to your data or system. We recommend you always shut down the system properly from the operating system.



-
- The BIOS setup screens shown in this section are for reference purposes only, and may not exactly match what you see on your screen.
 - Visit the ASUS website at www.asus.com to download the latest BIOS file for this motherboard.
 - Ensure that a USB mouse is connected to your motherboard if you want to use the mouse to control the BIOS setup program.
 - If the system becomes unstable after changing any BIOS setting, load the default settings to ensure system compatibility and stability. Select the **Load Optimized Defaults** item under the Exit menu or press hotkey F5. See section **2.10 Exit Menu** for details.
 - If the system fails to boot after changing any BIOS setting, try to clear the CMOS and reset the motherboard to the default value. See section **1.6 Jumpers** for information on how to erase the RTC RAM.

BIOS menu screen

The BIOS setup program can be used under two modes: **EZ Mode** and **Advanced Mode**. You can change modes from the **Exit** menu or from the **Exit/Advanced Mode** button in the **EZ Mode/Advanced Mode** screen.

EZ Mode

By default, the EZ Mode screen appears when you enter the BIOS setup program. The EZ Mode provides you an overview of the basic system information, and allows you to select the display language, system performance mode and boot device priority. To access the Advanced Mode, click **Exit/Advanced Mode**, then select **Advanced Mode** or press F7 for the advanced BIOS settings.



The default screen for entering the BIOS setup program can be changed. Refer to the **Setup Mode** item in section **2.8 Boot menu** for details.

Displays the CPU/motherboard temperature, CPU voltage output, and CPU/chassis fan speed

Selects the display language of the BIOS setup program

Exits the BIOS setup program without saving the changes, saves the changes and resets the system, or enters the Advanced Mode

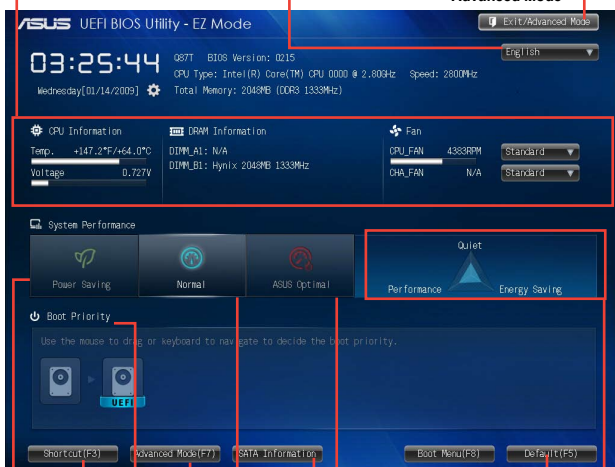

Selects the Advanced mode functions

Power saving mode

Normal mode

ASUS Optimal mode

Displays the Advanced mode menus

Displays SATA Information

Loads optimized default

Displays the system properties of the selected mode on the right hand side



- The boot device options vary depending on the devices you installed to the system.
- The **Boot Menu (F8)** button is available only when the boot device is installed to the system.

Advanced Mode

The Advanced Mode provides advanced options for experienced end-users to configure the BIOS settings. The figure below shows an example of the **Advanced Mode**. Refer to the following sections for the detailed configurations.



To access the EZ Mode, click **Exit**, then select **ASUS EZ Mode** or press **F7**.

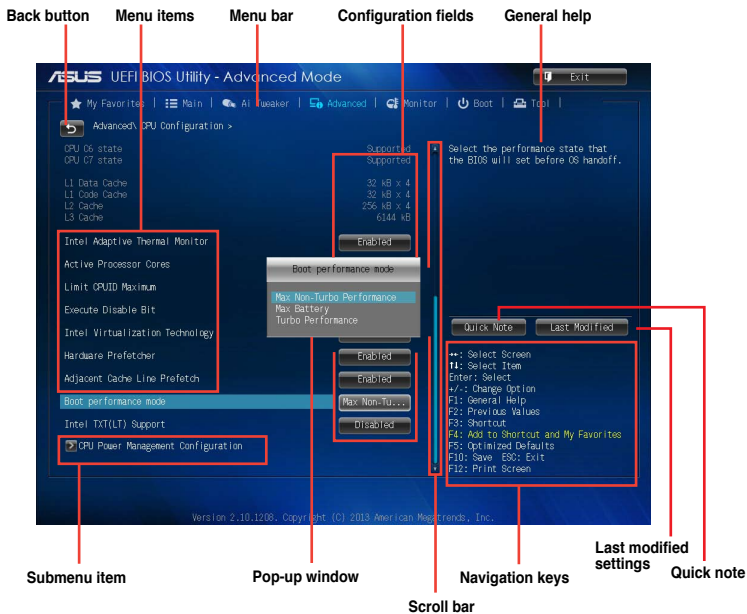

Menu bar

The menu bar on top of the screen has the following main items:

My Favorites	For saving the frequently-used system settings and configuration
Main	For changing the basic system configuration
Ai Tweaker	For changing the overclocking settings
Advanced	For changing the advanced system settings
Monitor	For displaying the system temperature, power status, and changing the fan settings
Boot	For changing the system boot configuration
Tool	For configuring options for special functions
Exit	For selecting the exit options and loading default settings

Menu items

The highlighted item on the menu bar displays the specific items for that menu. For example, selecting **Main** shows the Main menu items.

The other items (Ai Tweaker, Advanced, Monitor, Boot, Tool, and Exit) on the menu bar have their respective menu items.

Back button

This button appears when entering a submenu. Press <Esc> or use the USB mouse to click this button to return to the previous menu screen.

Submenu items

A greater than sign (>) before each item on any menu screen means that the item has a submenu. To display the submenu, select the item and press <Enter>.

Pop-up window

Select a menu item and press <Enter> to display a pop-up window with the configuration options for that item.

Scroll bar

A scroll bar appears on the right side of a menu screen when there are items that do not fit on the screen. Press the Up/Down arrow keys or <Page Up> / <Page Down> keys to display the other items on the screen.

Navigation keys

At the bottom right corner of the menu screen are the navigation keys for the BIOS setup program. Use the navigation keys to select items in the menu and change the settings.

General help

At the top right corner of the menu screen is a brief description of the selected item.

Configuration fields

These fields show the values for the menu items. If an item is user-configurable, you can change the value of the field opposite the item. You cannot select an item that is not user-configurable.

A configurable field is highlighted when selected. To change the value of a field, select it and press <Enter> to display a list of options.

Quick Note button

This button allows you to enter notes of the activities that you have done in BIOS.

Last Modified button

This button shows the items that you last modified and saved in BIOS Setup.

2.3 My Favorites

MyFavorites is your personal space where you can easily save and access your favorite BIOS items.

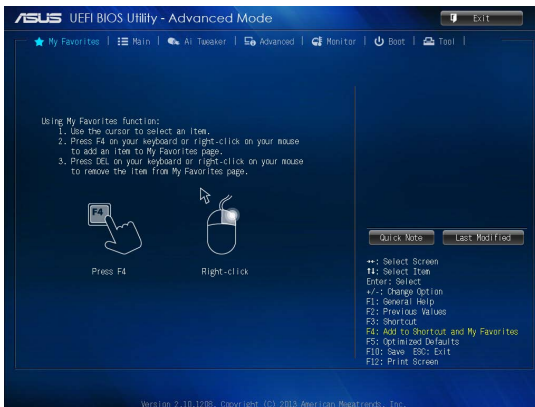

Adding items to My Favorites

To add frequently-used BIOS items to My Favorites:

1. Use the arrow keys to select an item that you want to add. When using a mouse, hover the pointer to the item.
2. Press <F4> on your keyboard or right-click on your mouse to add the item to My Favorites page.



You cannot add the following items to My Favorites:

- Items with submenu options
- User-configurable items such as language and boot device order
- Configuration items such as Memory SPD Information, system time and date

2.4 Main menu

The Main menu screen appears when you enter the Advanced Mode of the BIOS Setup program. The Main menu provides you an overview of the basic system information, and allows you to set the system date, time, language, and security settings.

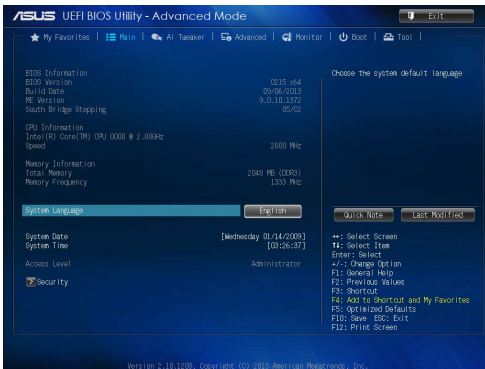

2.4.1 System Language [English]

Allows you to choose the BIOS language version from the options. Configuration options: [English] [Français] [Deutsch] [简体中文] [繁體中文] [日本語] [Español] [Русский] [한국어]

2.4.2 System Date [Day xx/xx/xxxx]

Allows you to set the system date.

2.4.3 System Time [xx:xx:xx]

Allows you to set the system time.

2.4.4 Security

The Security menu items allow you to change the system security settings.



-
- If you have forgotten your BIOS password, erase the CMOS Real Time Clock (RTC) RAM to clear the BIOS password. See section **1.6 Jumpers** for information on how to erase the RTC RAM.
 - The **Administrator** or **User Password** items on top of the screen show the default **Not Installed**. After you set a password, these items show **Installed**.
-

Administrator Password

If you have set an administrator password, we recommend that you enter the administrator password for accessing the system. Otherwise, you might be able to see or change only selected fields in the BIOS setup program.

To set an administrator password:

1. Select the **Administrator Password** item and press <Enter>.
2. From the **Create New Password** box, key in a password, then press <Enter>.
3. Confirm the password when prompted.

To change an administrator password:

1. Select the **Administrator Password** item and press <Enter>.
2. From the **Enter Current Password** box, key in the current password, then press <Enter>.
3. From the **Create New Password** box, key in a new password, then press <Enter>.
4. Confirm the password when prompted.

To clear the administrator password, follow the same steps as in changing an administrator password, but press <Enter> when prompted to create/confirm the password. After you clear the password, the **Administrator Password** item on top of the screen shows **Not Installed**.

User Password

If you have set a user password, you must enter the user password for accessing the system. The **User Password** item on top of the screen shows the default **Not Installed**. After you set a password, this item shows **Installed**.

To set a user password:

1. Select the **User Password** item and press <Enter>.
2. From the **Create New Password** box, key in a password, then press <Enter>.
3. Confirm the password when prompted.

To change a user password:

1. Select the **User Password** item and press <Enter>.
2. From the **Enter Current Password** box, key in the current password, then press <Enter>.
3. From the **Create New Password** box, key in a new password, then press <Enter>.
4. Confirm the password when prompted.

To clear the user password, follow the same steps as in changing a user password, but press <Enter> when prompted to create/confirm the password. After you clear the password, the **User Password** item on top of the screen shows **Not Installed**.

2.5 Ai Tweaker menu

The Ai Tweaker menu items allow you to configure overclocking-related items.



Be cautious when changing the settings of the Ai Tweaker menu items. Incorrect field values can cause the system to malfunction.



The configuration options for this section vary depending on the CPU and DIMM model you installed on the motherboard.



Scroll down to display the following items:

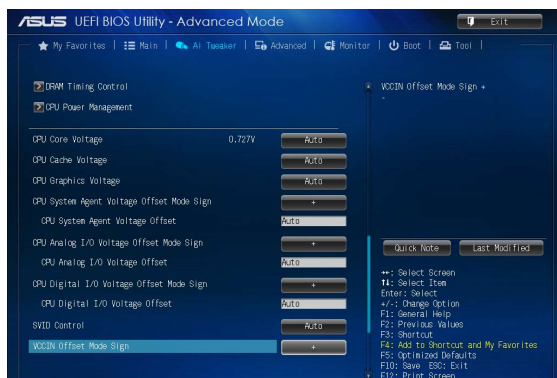

Scroll down to display the following items:



Target CPU Turbo-Mode Speed : xxxxMHz

Displays the target CPU Turbo-Mode speed.

Target DRAM Speed : xxxxMHz

Displays the target DRAM speed.

Target Cache Speed : xxxxMHz

Displays the target Cache speed.

Target DMI/PEG Clock : xxxxMHz

Displays the target DMI/PEG clock.

Target CPU Graphics Speed : xxxxMHz

Displays the target iGPU speed.

2.5.1 CPU Core Ratio [Auto]

Allows you to set the CPU core ratio automatically or manually.

[Auto] Sets all CPU Core Ratio to Intel® CPU default settings automatically.

[Sync All Cores] Allows you to set CPU Core Ratio settings for all cores.

[Per Core] Allows you to set CPU Core Ratio individually.



The following two items appear only when you set the **CPU Core Ratio** to **[Sync All Cores]** or **[Per Core]**.

1-Core Ratio Limit [Auto]

Select [Auto] to apply the CPU default Turbo Ratio setting or manually assign a 1-Core Limit value, which should be higher than or equal to the 2-Core Ratio Limit.

2-/3-/4-Core Ratio Limit [Auto]

These items become configurable only when you set the **CPU Core Ratio** item to [Per Core].

2.5.2 Min CPU Cache Ratio [Auto]

Allows you to set the minimum CPU Cache Ratio.

2.5.3 Max CPU Cache Ratio [Auto]

Allows you to set the maximum CPU Cache Ratio.

2.5.4 BCLK Frequency: DRAM Frequency Ratio [Auto]

Allows you to set the CPU bus speed to DRAM speed ratio mode.

[Auto] DRAM speed is set to the optimized settings.

[100:133] The CPU bus speed to DRAM speed ratio is set to 100:133.

[100:100] The CPU bus speed to DRAM speed ratio is set to 100:100.

2.5.5 DRAM Frequency [Auto]

Allows you to set the memory operating frequency. Configuration options: [DDR3-800MHz][DDR3-1066MHz][DDR3-1333MHz][DDR3-1600MHz][DDR3-1866MHz][DDR3-2133MHz]~[DDR3-3200MHz]



Selecting a very high memory frequency may cause the system to become unstable! If this happens, revert to the default setting.

2.5.6 Max. CPU Graphics Ratio [Auto]

Allows you to set the CPU Graphics maximum ratio. The maximum ratio is 60x. Use <+>/<-> to adjust the value.

2.5.7 GPU Boost [As is]

Allows you to enable the GPU Boost to accelerate the integrated GPU for extreme graphics performance. Configuration options: [As is] [Enabled].

2.5.8 EPU Power Saving Mode [Disabled]

Allows you to enable or disable the EPU power saving function. Configuration options: [Disabled] [Enabled]

2.5.9 DRAM Timing Control

The subitems in this menu allow you to set the DRAM timing control features. Use the <+> and <-> keys to adjust the value. To restore the default setting, type [auto] using the keyboard and press the <Enter> key.



Changing the values in this menu may cause the system to become unstable! If this happens, revert to the default settings.

Primary Timings

DRAM CAS# Latency [Auto]

Configuration options: [Auto] [1 DRAM Clock] – [31 DRAM Clock]

DRAM RAS# to CAS# Delay [Auto]

Configuration options: [Auto] [1 DRAM Clock] – [31 DRAM Clock]

DRAM RAS# PRE Time [Auto]

Configuration options: [Auto] [1 DRAM Clock] – [31 DRAM Clock]

DRAM RAS# ACT Time [Auto]

Configuration options: [Auto] [1 DRAM Clock] – [63 DRAM Clock]

DRAM COMMAND Rate [Auto]

Configuration options: [Auto] [1 DRAM Clock] [2 DRAM Clock] [3 DRAM Clock]

Secondary Timings

DRAM RAS# to RAS# Delay [Auto]

Configuration options: [Auto] [1 DRAM Clock] – [15 DRAM Clock]

DRAM REF Cycle Time [Auto]

Configuration options: [Auto] [1 DRAM Clock] – [511 DRAM Clock]

DRAM Refresh Interval [Auto]

Configuration options: [Auto] [1 DRAM Clock] – [65535 DRAM Clock]

DRAM WRITE Recovery Time [Auto]

Configuration options: [Auto] [1 DRAM Clock] – [16 DRAM Clock]

DRAM READ to PRE Time [Auto]

Configuration options: [Auto] [1 DRAM Clock] – [15 DRAM Clock]

DRAM FOUR ACT WIN Time [Auto]

Configuration options: [Auto] [1 DRAM Clock] – [255 DRAM Clock]

DRAM WRITE to READ Delay [Auto]

Configuration options: [Auto] [1 DRAM Clock] – [15 DRAM Clock]

DRAM CKE Minimum pulse width [Auto]

Configuration options: [Auto] [1 DRAM Clock] – [15 DRAM Clock]

DRAM CAS# Write to Latency [Auto]

Configuration options: [Auto] [1 DRAM Clock] – [31 DRAM Clock]

RTL IOL control

DRAM RTL initial Value [Auto]

Configuration options: [Auto] [1 DRAM Clock] – [63 DRAM Clock]

DRAM RTL (CHA) [Auto]

Configuration options: [Auto] [1 DRAM Clock] – [63 DRAM Clock]

DRAM RTL (CHB) [Auto]

Configuration options: [Auto] [1 DRAM Clock] – [63 DRAM Clock]

DRAM IO-L (CHA) [Auto]

Configuration options: [Auto] [Delay 1 Clock] - [Delay 15 Clock]

DRAM IO-L (CHB) [Auto]

Configuration options: [Auto] [Delay 1 Clock] - [Delay 15 Clock]

Third Timings

tRDRD [Auto]

Configuration options: [Auto] [1 DRAM Clock] – [7 DRAM Clock]

tRDRD_dr [Auto]

Configuration options: [Auto] [1 DRAM Clock] – [15 DRAM Clock]

tRDRD_dd [Auto]

Configuration options: [Auto] [1 DRAM Clock] – [15 DRAM Clock]

tWRRD [Auto]

Configuration options: [Auto] [1 DRAM Clock] – [63 DRAM Clock]

tWRRD_dr [Auto]

Configuration options: [Auto] [1 DRAM Clock] – [15 DRAM Clock]

tWRRD_dd [Auto]

Configuration options: [Auto] [1 DRAM Clock] – [15 DRAM Clock]

tWRWR [Auto]

Configuration options: [Auto] [1 DRAM Clock] – [7 DRAM Clock]

tWRWR_dr [Auto]

Configuration options: [Auto] [1 DRAM Clock] – [15 DRAM Clock]

tWRWR_dd [Auto]

Configuration options: [Auto] [1 DRAM Clock] – [15 DRAM Clock]

Dec_WRD [Auto]

Configuration options: [Auto] [0] [1]

tRDWR [Auto]

Configuration options: [Auto] [1 DRAM Clock] – [31 DRAM Clock]

tRDWR_dr [Auto]

Configuration options: [Auto] [1 DRAM Clock] – [31 DRAM Clock]

tRDWR_dd [Auto]

Configuration options: [Auto] [1 DRAM Clock] – [31 DRAM Clock]

MISC

MRC Fast Boot [Enabled]

Allows you to enable or disable the MRC fast boot.

[Enabled] Enables the MRC fast boot.

[Disable] Disables the MRC fast boot.

DRAM CLK Period [Auto]

Configuration options: [Auto] [1] – [14]

Channel A DIMM Control [Enable Bot...]

Configuration options: [Enable Both DIMMS] [Disable DIMM0] [Disable DIMM1]
[Disable Both DIMMS]

Channel B DIMM Control [Enable Bot...]

Configuration options: [Enable Both DIMMS] [Disable DIMM0] [Disable DIMM1]
[Disable Both DIMMS]

Scrambler Setting [Optimized ...]

Configuration options: [Optimized (ASUS)] [Default (MRC)]

2.5.10 CPU Power Management

The subitems in this menu allow you to set the CPU ratio and features.

Enhanced Intel® SpeedStep Technology [Enabled]

Allows you to enable or disable the Enhanced Intel® SpeedStep Technology (EIST).

[Disabled] Disables this function.

[Enabled] The operating system dynamically adjusts the processor voltage and core frequency which may result in decreased average consumption and decreased average heat production.

Turbo Mode [Enabled]

Allows you to enable your core processor's speed to run faster than the marked frequency in a specific condition. Configuration options: [Disabled] [Enabled]



-
- Turbo Mode is only available on selected CPU models only.
 - The following first three items appear only when you set the Turbo Mode to **[Enabled]**.
-

Turbo Mode Parameters

Long Duration Package Power Limit [Auto]

Allows you to limit the turbo ratio's long duration package power.
Use the <+> and <-> keys to adjust the value.

Package Power Time Window [Auto]

Allows you to set the package power time window.
Use the <+> and <-> keys to adjust the value.

Short Duration Package Power Limit [Auto]

Allows you to limit the turbo ratio's long duration power.
Use the <+> and <-> keys to adjust the value.

CPU Integrated VR Current Limit [Auto]

Allows you to limit the CPU Integrated VR current.
Use <+> and <-> key to adjust the value.

CPU Internal Power Switching Frequency**Frequency Tuning Mode [Auto]**

Allows you to set the frequency tuning mode. Configuration options: [Auto] [+] [-]

CPU Internal Power Fault Control**Thermal Feedback [Auto]**

When enabled, it allows CPU to take precautionary actions when the thermal of the external regulator exceeds the limit. Configuration options: [Auto] [Disabled] [Enabled]

CPU Integrated VR Fault Management [Auto]

Allows you to manage the CPU Integrated VR fault. Configuration options: [Auto] [Disabled] [Enabled]

CPU Internal Power Configuration**CPU Integrated VR Efficiency Management [Auto]**

Allows you to manage the CPU integrated VR efficiency. Configuration options: [Auto] [High Performance] [Balanced]

Power Decay Mode [Auto]

Enable to improve power saving on the Fully Integrated Voltage Regulator as the processor enters low current mode. Configuration options: [Auto] [Disabled] [Enabled]

Idle Power-in Response [Auto]

Allows you to set the idle power-in response. Configuration options: [Auto] [Regular] [Fast]

Idle Power-out Response [Auto]

Allows you to set the idle power-out response. Configuration options: [Auto] [Regular] [Fast]

Power Current Slope [Auto]

Allows you to set the power current slope. Configuration options: [Auto] [Level 4] [Level 3] [Level 2] [Level 1] [Level 0] [Level -1] [Level -2] [Level -3] [Level -4].

Power Current Offset [Auto]

Allows you to set the power current offset. Configuration options: [Auto] [100%] [87.5%] [75%] [62.5%] [50%] [37.5%] [25%] [12.5%] [0%] [-12.5%] [-25%] [-37.5%] [-50.0%] [-62.5%] [-75%] [-87.5%] [-100%]

Power Fast Ramp Response [Auto]

Allows you to set the power fast ramp response. Use the <+> and <-> keys to adjust the value.

CPU Internal Power Saving Control

Power Saving Level 1 Threshold [Auto]

Allows you to set the power saving level 1 threshold. Use the <+> and <-> keys to adjust the value.

Power Saving Level 2 Threshold [Auto]

Allows you to set the power saving level 2 threshold. Use the <+> and <-> keys to adjust the value.

Power Saving Level 3 Threshold [Auto]

Allows you to set the power saving level 3 threshold. Use the <+> and <-> keys to adjust the value.

2.5.11 CPU Core Voltage [Auto]

This item allows you to set the CPU core voltage. Increase the voltage when increasing the core frequency. Configuration options: [Auto] [Manual Mode] [Offset Mode] [Adaptive Mode].



[Adaptive Mode] is available for some specific CPU types.

CPU Core Voltage Override [Auto]

This item appears only when you set the CPU Core Voltage to [Manual Mode] and allows you to set the CPU core voltage override. The values range from 0.001V to 1.920V with a 0.001V interval.

Offset Mode Sign [+]

This item appears only when you set the CPU Core Voltage to [Offset Mode] or [Adaptive Mode] and allows you to set the offset mode sign. Configuration options: [+] [-]

CPU Core Voltage Offset [Auto]

This item appears only when you set the CPU Core Voltage to [Offset Mode] or [Adaptive Mode] and allows you to set the CPU core voltage offset. The values range from 0.001V to 0.999V with a 0.001V interval.

2.5.12 CPU Cache Voltage [Auto]

This item allows you to set the CPU Cache voltage. Increase the cache voltage when increasing the ring frequency. Configuration options: [Auto] [Manual Mode] [Offset Mode] [Adaptive Mode].



[Adaptive Mode] is available for some specific CPU types.

CPU Cache Voltage Override [Auto]

This item appears only when you set the CPU Cache Voltage to [Manual Mode] and allows you to set the CPU Cache voltage override. The values range from 0.001V to 1.920V with a 0.001V interval.

Offset Mode Sign [+]

This item appears only when you set the CPU Cache Voltage to [Offset Mode] or [Adaptive Mode] and allows you to set the offset mode sign. Configuration options: [+] [-]

CPU Cache Voltage Offset [Auto]

This item appears only when you set the CPU Cache Voltage to [Offset Mode] or [Adaptive Mode] and allows you to set the CPU cache voltage offset. The values range from 0.001V to 0.999V with a 0.001V interval.

2.5.13 CPU Graphics Voltage [Auto]

This item allows you to set the CPU graphics voltage. Increase the graphics voltage when increasing the iGPU frequency. Configuration options: [Auto] [Manual Mode] [Offset Mode] [Adaptive Mode].



[Adaptive Mode] is available for some specific CPU types.

CPU Graphics Voltage Override [Auto]

This item appears only when you set the CPU Graphics Voltage to [Manual Mode] and allows you to set the CPU graphics voltage override. The values range from 0.001V to 1.920V with a 0.001V interval.

Offset Mode Sign [+]

This item appears only when you set the CPU Graphics Voltage to [Offset Mode] or [Adaptive Mode] and allows you to set the offset mode sign. Configuration options: [+] [-]

CPU Graphics Voltage Offset [Auto]

This item appears only when you set the CPU Graphics Voltage to [Offset Mode] or [Adaptive Mode] and allows you to set the CPU graphics voltage offset. The values range from 0.001V to 0.999V with a 0.001V interval.

Additional Turbo Mode CPU Graphics Voltage [Auto]

This item appears only when you set the CPU Graphics Voltage to [Adaptive Mode] and allows you to set the additional turbo mode CPU graphics voltage. The values range from 0.001V to 1.920V with a 0.001V interval.

Total Adaptive Mode CPU Graphics Voltage [Auto]

This item appears only when you set the CPU Graphics Voltage to [Adaptive Mode] and allows you to set the total adaptive mode CPU graphics voltage. The values range from 0.001V to 1.920V with a 0.001V interval.

2.5.14 CPU System Agent Voltage Offset Mode Sign [+]

This item allows you to set the CPU system agent voltage offset mode sign. Configuration options: [+] [-].

CPU System Agent Voltage Offset [Auto]

This item allows you to set the CPU system agent voltage offset. Increase the value when increasing DRAM frequency. The values range from 0.001V to 0.999V with a 0.001V interval.

2.5.15 CPU Analog I/O Voltage Offset Mode Sign [+]

This item allows you to set the CPU analog I/O voltage offset mode sign. Configuration options: [+] [-].

CPU Analog I/O Voltage Offset [Auto]

This item allows you to set the CPU analog I/O voltage offset. Increase the value when increasing DRAM frequency. The values range from 0.001V to 0.999V with a 0.001V interval.

2.5.16 CPU Digital I/O Voltage Offset Mode Sign [+]

This item allows you to set the CPU digital I/O voltage offset mode sign. Configuration options: [+] [-].

CPU Digital I/O Voltage Offset [Auto]

This item allows you to set the CPU digital I/O voltage offset. Increase the value when increasing DRAM frequency. The values range from 0.001V to 0.999V with a 0.001V interval.

2.5.17 SVID Support [Auto]

Disabling SVID Support stops the processor from communicating with the external voltage regulator. Configuration options: [Auto] [Disabled] [Enabled].

2.5.18 VCCIN Offset Mode Sign [Auto]

This item allows you to set the CPU input voltage. The values range from 0.010V to 0.600V with a 0.010V interval when the VCCIN Offset Mode Sign is [+]. The values range from 0.010V to 0.250V with a 0.010V interval when the VCCIN Offset Mode Sign is [-].

2.5.19 DRAM Voltage [Auto]

Allows you to set the DRAM Voltage. The values range from 1.185V to 1.800V with a 0.005V interval.

2.5.20 DRAM CTRL REF Voltage [Auto]

Allows you to set the DRAM CTRL REF Voltage. The values range from 0.3950V to 0.6300V with a 0.0050V interval.

2.5.21 DRAM DATA REF Voltage on CHA [Auto]

Allows you to set the DRAM DATA REF Voltage on CHA. The values range from 0.3950V to 0.6300V with a 0.0050V interval

2.5.22 DRAM DATA REF Voltage on CHB [Auto]

Allows you to set the DRAM DATA REF Voltage on CHB. The values range from 0.3950V to 0.6300V with a 0.0050V interval

2.5.23 CPU Spread Spectrum [Auto]

- | | |
|------------|---|
| [Auto] | Automatic configuration. |
| [Disabled] | Enhances the BCLK overclocking ability. |
| [Enabled] | Sets to [Enabled] for EMI control. |

2.6 Advanced menu

The Advanced menu items allow you to change the settings for the CPU and other system devices.



Be cautious when changing the settings of the Advanced menu items. Incorrect field values can cause the system to malfunction.

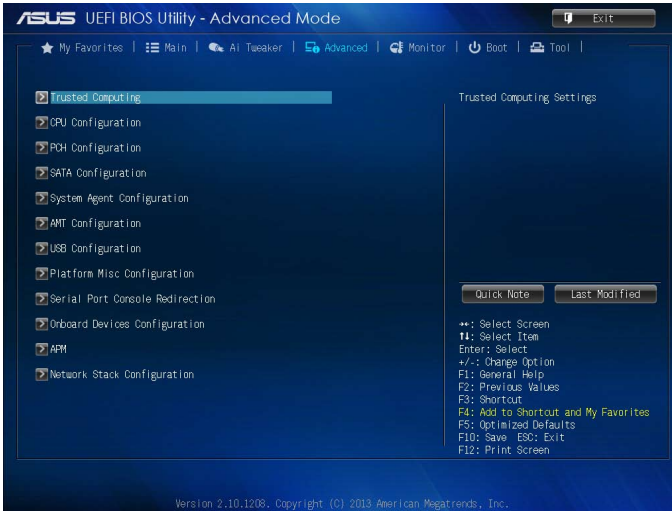

2.6.1 Trusted Computing

Security Device Support [Disable]

Enables or disables BIOS support for security devices. Configuration options: [Disable] [Enable]



The following items appear only when you set the Security Device Support to **[Enable]**.

TPM Support [Disabled]

Allows you to enable or disable the TPM support. Configuration options: [Disabled] [Enabled]

TPM State [Disabled]

This item appears only when you set the **TPM Support** item to [Enabled] and allows you to enable or disable the TPM after POST. Reboot your system for the changes to take effect. Configuration options: [Disabled] [Enabled]

2.6.2 CPU Configuration

The items in this menu show the CPU-related information that the BIOS automatically detects.



The items shown in submenu may be different due to the CPU you installed.

Intel® Adaptive Thermal Monitor [Enabled]

[Enabled] Enables the overheated CPU to throttle its clock speed to cool down.
[Disabled] Disables the CPU thermal monitor function.

Hyper-threading [Enabled]

The Intel Hyper-Threading Technology allows a hyper-threading processor to appear as two logical processors to the operating system, allowing the operating system to schedule two threads or processes simultaneously.

[Enabled] Two threads per activated core are enabled.
[Disabled] Only one thread per activated core is enabled.

Active Processor Cores [All]

Allows you to choose the number of CPU cores to activate in each processor package. Configuration options: [All] [1] [2] [3]

Limit CPUID Maximum [Disabled]

[Enabled] Allows legacy operating systems to boot even without support for CPUs with extended CPUID functions.
[Disabled] Disables this function.

Execute Disable Bit [Enabled]

[Enabled] Enables the No-Execution Page Protection Technology.

[Disabled] Forces the XD feature flag to always return to zero (0).

Intel® Virtualization Technology [Enabled]

[Enabled] Allows a hardware platform to run multiple operating systems separately and simultaneously, enabling one system to virtually function as several systems.

[Disabled] Disables this function.

Hardware Prefetcher [Enabled]

[Enabled] Allows a hardware platform to automatically analyze the requirements and prefetch data and codes for the CPU.

[Disabled] Disables this function.

Adjacent Cache Line Prefetch [Enabled]

[Enabled] Allows a hardware platform to perform adjacent cache line prefetching.

[Disabled] Disables this function.

Boot performance mode [Max Non-Tu...]

This item allows you to select the boot performance mode. Configuration options: [Max Non-Turbo Performance] [Max battery] [Turbo Performance]

Intel TXT (LT) Support [Disabled]

Enables or disables Intel(R) TXT(LT) support. Configuration options: [Disabled] [Enabled]

CPU Power Management Configuration

This item allows you to manage and configure the CPU's power.

Enhanced Intel® SpeedStep Technology [Enabled]

Allows you to enable or disable the Enhanced Intel® SpeedStep Technology (EIST).

[Disabled] The CPU runs at its default speed.

[Enabled] The operating system controls the CPU speed.

Turbo Mode [Enabled]

Allows you to set the processor cores to run faster than the marked frequency in a specific condition. Configuration options: [Enabled] [Disabled]



Turbo Mode is only available on selected CPU models only.

CPU C states [Auto]

[Auto] Automatic configuration.

[Enabled] Enables the CPU C states.

[Disabled] Disables the CPU C states.



The following items appear only when you set the CPU C states to **[Enabled]**.

Enhanced C1 state [Enabled]

[Enabled] Enables enhanced C1 state.

[Disabled] Disables enhanced C1 state.

CPU C3 Report [Enabled]

Allows you to disable or enable the CPU C3 report to OS. Configuration options: [Enabled] [Disabled]

CPU C6 report [Enabled]

Allows you to disable or enable the CPU C6 report to OS. Configuration options: [Enabled] [Disabled]

C6 Latency [Short]

Allows you to choose short or long latency for C6. Configuration options: [Short] [Long]

CPU C7 report [CPU C7s]

Allows you to disable or enable the CPU C7 report to OS. Configuration options: [Disabled] [CPU C7] [CPU C7s]

C7 Latency [Long]

Allows you to choose short or long latency for C6. Configuration options: [Short] [Long]

Package C State Support [Auto]

Allows you to disable or enable the whole C-State package support. Configuration options: [Auto] [Enabled] [C0/C1] [C2] [C3] [C6] [CPU C7] [CPU C7s]

2.6.3 PCH Configuration

PCI Express Configuration

DMI Link ASPM Control [Auto]

Allows you to control the Active State Power Management on both NB and SB side of the DMI Link. Configuration options: [Auto] [Enabled] [Disabled]

ASPM Support [Disabled]

Allows you to set the ASPM support. Configuration options: [Disabled] [Auto] [L0s] [L1] [L0sL1].

PCIe Speed [Auto]

Allows you to select the PCI Express port speed. Configuration options: [Auto] [Gen1] [Gen2]

Intel® Rapid Start Technology

Intel® Rapid Start Technology [Disabled]

Allows you to enable or disable Intel® Rapid Start Technology. Configuration options: [Enabled] [Disabled]



The following items appear only when you set the Intel® Rapid Start Technology to **[Enabled]**.

Entry on S3 RTC Wake [Enabled]

The system automatically wakes up and set to Rapid Start Technology S4 mode. Configuration options: [Enabled] [Disabled]

Entry After [x]

Allows you to set the wake-up time. The values range from 0 (immediately) to 120.

Active Page Threshold Support [Enabled]

The system automatically set itself to sleep when the partition size is not enough for Rapid Start Technology to work. Configuration options: [Enabled] [Disabled]

Active Memory Threshold [0]

Key in the value for the additional partition size for Rapid Start Technology to work.



Ensure that the caching partition size is larger than the total memory size.

Hybrid Hard Disk Support [Disabled]

Allows you to enable or disable hybrid hard disk support. Configuration options: [Enabled] [Disabled]

Intel® Smart Connect Technology [Disabled]

ICST Configuration [Disabled]

Allows you to enable or disable the ISCT configuration. Configuration options: [Enabled] [Disabled]

DeepSx Power Policies [Disabled]

Allows you to configure the DeepSx Mode. Configuration options: [Disabled] [Enabled in S5] [Enabled in S4-S5].

2.6.4 SATA Configuration

While entering Setup, the BIOS automatically detects the presence of SATA devices. The SATA Port items show Not Present if no SATA device is installed to the corresponding SATA port.

SATA Mode Selection [AHCI]

Allows you to set the SATA configuration.

[Disabled] Disables the SATA function.

[IDE] Set to [IDE] when you want to use the Serial ATA hard disk drives as Parallel ATA physical storage devices.

[AHCI] Set to [AHCI] when you want the SATA hard disk drives to use the AHCI (Advanced Host Controller Interface). The AHCI allows the onboard storage driver to enable advanced Serial ATA features that increases storage performance on random workloads by allowing the drive to internally optimize the order of commands.

[RAID] Set to [RAID Mode] when you want to create a RAID configuration from the SATA hard disk drives.

Aggressive LPM Support [Auto]

This item appears only when you set **SATA Mode Selection** to [AHCI] and allows you to enable or disable PCH entering link power state aggressively. Configuration options: [Auto] [Disabled] [Enabled]

S.M.A.R.T. Status Check [Enabled]

S.M.A.R.T. (Self-Monitoring, Analysis and Reporting Technology) is a monitor system. When read/write of your hard disk errors occur, this feature allows the hard disk to report warning messages during the POST. Configuration options: [Enabled] [Disabled]

Hot Plug [Disabled]

These items appear only when you set the SATA Mode Selection item to [AHCI] and allow you to enable/disable SATA Hot Plug Support. Configuration options: [Disabled] [Enabled]

2.6.5 System Agent Configuration

VT-d [Disabled]

Allows you to enable or disable VT-d function on MCH. Configuration options: [Enabled] [Disabled]

CPU Audio Device [Enabled]

Allows you to enable or disable CPU SA Audio Device. Configuration options: [Enabled] [Disabled]

Graphics Configuration

Allows you to select a primary display from iGPU, and PCIe graphical devices.

Primary Display [Auto]

Allows you to select which of the iGPU/PCIe Graphics device should be the Primary Display. Configuration options: [Auto] [iGPU] [PCIe] [PCI]

iGPU Memory [Auto]

Allows you to select the amount of system memory allocated to DVMT 5.0 used by the iGPU. Configuration options: [Auto] [32M] [64M] [96M] [128M] [160M] [192M] [224M] [256M] [288M] [320M] [352M] [384M] [416M] [448M] [480M] [512M] [1024M]

Render Standby [Auto]

Allows you to enable or disable Intel® Graphics Render Standby support to reduce iGPU power use when the system is idle. Configuration options: [Auto] [Disabled] [Enabled]

iGPU Multi-Monitor [Disabled]

Allows you to enable the iGPU Multi-Monitor. For LucidLogix Virtu MVP function support, set this item to [Enabled] to empower both integrated and discrete graphics. The iGPU shared system memory size will be fixed at 64MB. Configuration options: [Disabled] [Enabled]

IGD Flat Panel [Auto]

Allows you to enable or disable IGD video output to onboard LVDS. Configuration options: [Disable] [LVDS]

LVDS Configuration

All-in-One Chassis [None]

Select All-in-One Chassis if applicable.

EDID Data Source [Pre-Defined]

Configuration options: [Pre-Defined] [Flat Panel Display]



The following item appears only when you set the **EDID Data Source** to **[Pre-Defined]**.

Pre-Defined LVDS Panel Type [1920x1080 LVDS]

Select LVDS Panel Type.

Configuration options: [640x480 LVDS] ~ [2048x1536 LVDS]

Screen Brightness [Neutral]

Adjust screen brightness.

Configuration options: [Dimmest] [Dimmer] [Dim] [Neutral] [Bright] [Brighter] [Brightest]

Channel Select [Dual Channel]

Configuration options: [Dual Channel] [Single Channel]

Mode Select [8bit Mode(JEIDA)]

Select LVDS bit rate.

Configuration options: [8bit Mode(JEIDA)] [8bit Mode(VESA)] [6bit Mode(VESA and JEIDA)]

Panel Power Sequence Control [Enabled]

Configuration options: [Enabled] [Disabled]



The following items appear only when you set **Panel Power Sequence Control** to **[Enabled]**.

Panel_Vcc ON to Video_Data ON (T8) [Enabled]

Configuration options: [10 ms] [20 ms] [30 ms] [40 ms]

Video_Data ON to BKLT_PWM ON (T9) [250 ms]

Configuration options: [100 ms] [200 ms] [250 ms] [300 ms]

BKLT_PWM ON to BKLT_Enable ON (T10) [15 ms]

Configuration options: [10 ms] [15 ms] [20 ms] [25 ms]

BKLT_Enable OFF to BKLT_PWM OFF (T11) [10 ms]

Configuration options: [5 ms] [10 ms] [15 ms] [20 ms]

BKLT_PWM OFF to Video_Data OFF (T12) [250 ms]

Configuration options: [100 ms] [200 ms] [250 ms] [300 ms]

Video_Data OFF to Panel_Vcc OFF (T13) [20 ms]

Configuration options: [10 ms] [20 ms] [30 ms] [40 ms]

Min Panel_Vcc OFF Time (T15) [600 ms]

Configuration options: [600 ms] [700 ms] [800 ms] [1000 ms]

LVDS Spread Spectrum Control [+/- 0.5% Center Spread]

Adjusts LVDS spread spectrum clocking.

Configuration options: [Disabled] [+/- 0.5% Center Spread] [+/- 1% Center Spread]

DMI Configuration

Allows you to control various DMI functions.

DMI Gen 2 [Auto]

Allows you to enable or disable DMI Gen 2. Configuration options: [Auto] [Enabled] [Disabled]

NB PCIe Configuration

Allows you to configure the NB PCI Express settings.

PCIEX4 Link Speed [Auto]

Allows you to configure the PCIEX4 speed.
Configuration options: [Auto] [Gen1] [Gen2] [Gen3]

DMI Link ASPM Control [Auto]

Allows you to enable or disable the control of Active State Power Management on SA side of the DMI Link. Configuration options: [Auto] [Disabled] [L0s] [L1] [L0sL1]

PEG - ASPM [Disabled]

Allows you to control ASPM support for the PEG Device. The setting takes no effect if PEG is not the active device at present. Configuration options: [Disabled] [Auto] [ASPM L0s] [ASPM L1] [ASPM L0sL1]

Memory Configuration

Memory Scrambler [Enabled]

Allows you to enable or disable Memory Scrambler support.

Memory Remap [Enabled]

Allows you to enable or disable remapping the memory above 4GB.

[Enabled] Enables the function.

[Disabled] Disables this function.

2.6.6 AMT Configuration

The items in this menu allow you to change the Intel® Active Management Technology (AMT) feature.

Intel® AMT [Enabled]

Allow you to enable or disable the Intel® Active Management Technology (AMT) in the BIOS extension. Configuration options: [Enabled] [Disabled]



- iAMT H/W is always enabled. This option just controls the BIOS extension execution. If enabled, this requires additional firmware in the SPI device.
- The following two items become configurable only when you set the Intel®AMT item to [Enabled].

BIOS Hotkey Pressed [Disabled]

This item become configurable only when the previous item is set to [Enabled] and allows you to enable or disable this function. Configuration options: [Enabled] [Disabled]

Un-Configure ME [Disabled]

Sets this item to [Disabled] to unconfigure AMT/ME without using a password or set it to [Enabled] to use a password. Configuration options: [Enabled] [Disabled]

WatchDog [Disabled]

When set to [Enabled], the WatchDog Timer will monitor the time taken for each task performed by a software or hardware. Configuration options: [Enabled] [Disabled]



The following two items become configurable only when you set the WatchDog Timer item to [Enabled].

OS Timer [0]

Use the <+> and <-> keys to adjust the value or key in a number directly.

BIOS Timer [0]

Use the <+> and <-> keys to adjust the value or key in a number directly.

2.6.7 USB Configuration

The items in this menu allow you to change the USB-related features.



The **USB Devices** item shows the auto-detected values. If no USB device is detected, the item shows None.

Legacy USB Support [Enabled]

- [Enabled] Enables the support for USB devices on legacy operating systems (OS).
- [Disabled] The USB devices can be used only for the BIOS setup program.
- [Auto] Allows the system to detect the presence of USB devices at startup. If detected, the USB controller legacy mode is enabled. If no USB device is detected, the legacy USB support is disabled.

Intel® xHCI Mode [Smart Auto]

- [Auto] Keeps the last operation of xHCI controller in OS during bootup.
- [Smart Auto] Enables the operation of xHCI controller.
- [Enabled] Enables the function.
- [Disabled] Disables the function.

EHCI Hand-off [Disabled]

- [Enabled] Enables the support for operating systems without an EHCI hand-off feature.
- [Disabled] Disables the function.

USB Single Port Control

USB3_1~6 [Enabled]

Allows you to enable or disable an individual USB port. Refer to the section **1.2.2 Motherboard layout** in this user manual for the locations of the USB ports.
Configuration options: [Enabled] [Disabled].

USB3_14, 7~10 [Enabled]

Allows you to enable or disable an individual USB port. Refer to the section **1.2.2 Motherboard layout** in this user manual for the locations of the USB ports.
Configuration options: [Enabled] [Disabled].

2.6.8 Platform Misc Configuration

The items in this menu allow you to configure the Platform Misc.

PCI Express Native Power Management [Disabled]

Allows you to enable or disable PCI Express native power management. Configuration options: [Enabled] [Disabled]

Native ASPM [Disabled]

The item appears only when you set the previous item to [Enabled] and allows you to enable or disable ASPM. Configuration options: [Enabled] [Disabled]

2.6.9 Serial Port Console Redirection

Console Redirection [Disabled]

Enables or disables the console redirection feature. When enabled, it allows you to maintain a system from a remote location by redirecting keyboard input and text output through the serial port. Configuration options: [Enabled] [Disabled]

Console Redirection Settings

The following items become configurable only when you set the previous item to [Enabled].

Out-of-Band Mgmt Port [COM0 (DISA...)]

Microsoft Windows Emergency Management Services (EMS) allows for remote management of a Windows Server OS through a serial port. Configuration options: [COM0 (Disabled)] [COM1 (Disabled)] [COM2 (Pci Bys0, Dev0, Func0) (Disabled)]

Terminal Type [VT-UTF8]

VT-UTF8 is the preferred terminal type for out-of-band management. The next best choice is VT100+ and then VT100. Configuration options: [VT100] [VT100+] [VT-UTF8] [ANSI]

Bits per second [115200]

Allows you to select the transmission speed of the serial port. Configuration options: [9600] [19200] [57600] [115200]

Flow Control [None]

Flow control prevents data loss from buffer overflow. This item allows you to set the flow control. Configuration options: [None] [Hardware RTS/CTS] [Software Xon/Xoff]

2.6.10 Onboard Devices Configuration

HD Audio Controller [Enabled]

[Enabled] Enables the HD Audio Device.

[Disabled] Disables the HD Audio Device.

Realtek LAN Controller [Enabled]

[Enabled] Enables the Realtek LAN controller.

[Disabled] Disables the controller.

Realtek PXE OPROM [Disabled]

This item appears only when you set the previous item to [Enabled] and allows you to enable or disable the PXE OptionRom of the Realtek LAN controller. Configuration options: [Enabled] [Disabled]

Intel LAN Controller [Enabled]

[Enabled] Enables the Intel LAN controller.

[Disabled] Disables the controller.

Intel PXE OPROM [Disabled]

This item appears only when you set the previous item to [Enabled] and allows you to enable or disable the PXE OptionRom of the Intel LAN controller. Configuration options: [Enabled] [Disabled]

Ai Charge [Disabled]

This item disables or enables AI Charger while the system is in S5 mode. Configuration options: [Enabled] [Disabled]

Serial Port Configuration

The sub-items in this menu allow you to set the serial port configuration.

Serial Port [Enabled]

Allows you to enable or disable the serial port (COM). Configuration options: [Enabled] [Disabled]

Change Settings [IO=3F8h; IRQ=4]

This item appears only when you set the **Serial Port** to [Enabled] and allows you to select the Serial Port base address. Configuration options: [IO=3F8h; IRQ=4] [IO=2F8h; IRQ=3] [IO=3E8h; IRQ=4] [IO=2E8h; IRQ=3]

2.6.11 APM

Restore AC Power Loss [Power Off]

- [Power On] The system goes into on state after an AC power loss.
- [Power Off] The system goes into off state after an AC power loss.
- [Last State] The system goes into either off or on state, whatever the system state was before the AC power loss.

Power On By PCIE [Disabled]

- [Disabled] Disables the PCIE devices to generate a wake-on-LAN feature of the Intel®/Realtek LAN device.
- [Enabled] Enables the PCIE devices to generate a wake-on-LAN feature of the Intel®/Realtek LAN device.

Power On By Ring [Disabled]

- [Disabled] Disables Ring to generate a wake event.
- [Enabled] Enables Ring to generate a wake event.

Power On By RTC [Disabled]

- [Disabled] Disables RTC to generate a wake event.
- [Enabled] When set to [Enabled], the items **RTC Alarm Date (Days) and Hour/Minute/Second** will become user-configurable with set values.

2.6.12 Network Stack Configuration

Network Stack [Disabled]

This item allows user to disable or enable the UEFI network stack. Configuration options:
[Disabled] [Enabled]



The following two items appear only when you set the previous item to [Enabled].

Ipv4 PXE Support [Enabled]

This item allows user to disable or enable the Ipv4 PXE Boot support. Configuration options:
[Disable Link] [Enabled]

Ipv6 PXE Support [Enabled]

This item allows user to disable or enable the Ipv6 PXE Boot support. Configuration options:
[Disable Link] [Enabled]

2.7 Monitor menu

The Monitor menu displays the system temperature/power status, and allows you to change the fan settings.

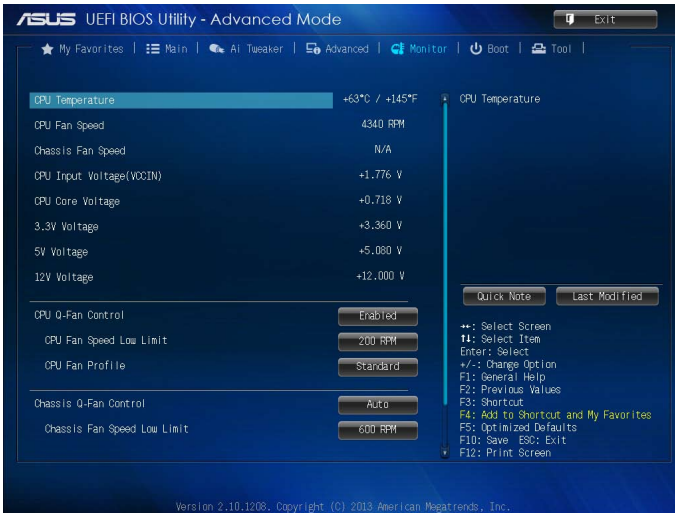

2.7.1 CPU Temperature [xxx°C/xxx°F]

The onboard hardware monitor automatically detects and displays the CPU temperature. Select **Ignore** if you do not wish to display the detected temperature.

2.7.2 CPU / Chassis Fan 1/2 Speed [xxxx RPM] or [Ignore] / [N/A]

The onboard hardware monitor automatically detects and displays the CPU / chassis fan 1/2 speeds in rotations per minute (RPM). If the fan is not connected to the motherboard, the field shows N/A. Select **Ignore** if you do not wish to display the detected speed.

2.7.3 CPU Input Voltage (VCCIN), CPU Core Voltage, 3.3V Voltage, 5V Voltage, 12V Voltage

The onboard hardware monitor automatically detects the voltage output through the onboard voltage regulators. Select **Ignore** if you do not want to detect this item.

2.7.4 CPU Q-Fan Control [Enabled]

[Disabled] Disables the CPU Q-Fan control feature.

[Enabled] Enables the CPU Q-Fan control feature.

CPU Fan Speed Low Limit [200 RPM]

This item appears only when you enable the CPU Q-Fan Control feature and allows you to disable or set the CPU fan warning speed.

Configuration options: [Ignore] [100RPM] [200RPM] [300 RPM] [400 RPM] [500 RPM]

CPU Fan Profile [Standard]

This item appears only when you enable the CPU Q-Fan Control feature and allows you to set the appropriate performance level of the CPU fan.

[Standard] Sets to [Standard] to make the CPU fan automatically adjust depending on the CPU temperature.

[Silent] Sets to [Silent] to minimize the fan speed for quiet CPU fan operation.

[Turbo] Sets to [Turbo] to achieve maximum CPU fan speed.

[Manual] Sets to [Manual] to assign detailed fan speed control parameters.



The following four items appear only when you set **CPU Fan Profile** to [Manual].

CPU Upper Temperature [70]

Use the <+> and <-> keys to adjust the upper limit of the CPU temperature. The values range from 20°C to 75°C.

CPU Fan Max. Duty Cycle(%) [100]

Use the <+> and <-> keys to adjust the maximum CPU fan duty cycle. The values range from 20% to 100%. When the CPU temperature reaches the upper limit, the CPU fan will operate at the maximum duty cycle.

CPU Lower Temperature [20]

Displays the lower limit of the CPU temperature.

CPU Fan Min. Duty Cycle(%) [20]

Use the <+> and <-> keys to adjust the minimum CPU fan duty cycle. The values range from 20% to 100%. When the CPU temperature is under the lower limit, the CPU fan will operate at the minimum duty cycle.

2.7.5 Chassis Q-Fan Control [Auto]

[Disabled] Disables the Chassis Q-Fan control feature.

[Auto] Enables the Chassis Q-Fan control feature for a 3-pin chassis fan.

[Advanced Mode] Enables DC mode Q-Fan control for a 4-pin chassis fan.

Chassis Fan Speed Low Limit [600 RPM]

This item appears only when you enable the Chassis1/2 Q-Fan Control feature and allows you to disable or set the chassis1/2 fan warning speed.

Configuration options: [Ignore] [200RPM] [300 RPM] [400 RPM] [500 RPM] [600 RPM]

Chassis Fan Profile [Standard]

This item appears only when you enable the Chassis1/2 Q-Fan Control feature and allows you to set the appropriate performance level of the chassis1/2 fan.

[Standard] Sets to [Standard] to make the chassis1/2 fan automatically adjust depending on the chassis1/2 temperature.

[Silent] Sets to [Silent] to minimize the fan speed for quiet chassis1/2 fan operation.

[Turbo] Sets to [Turbo] to achieve maximum chassis1/2 fan speed.

[Manual] Sets to [Manual] to assign detailed fan speed control parameters.



The following four items appear only when you set **Chassis1/2 Fan Profile** to [Manual].

Chassis1/2 Upper Temperature [70]

Use the <+> and <-> keys to adjust the upper limit of the chassis temperature. The values range from 40°C to 75°C.

Chassis1/2 Fan Max. Duty Cycle(%) [100]

Use the <+> and <-> keys to adjust the maximum chassis fan duty cycle. The values range from 60% to 100%. When the chassis temperature reaches the upper limit, the chassis fan will operate at the maximum duty cycle.

Chassis1/2 Lower Temperature [40]

Displays the lower limit of the chassis temperature.

Chassis1/2 Fan Min. Duty Cycle(%) [60]

Use the <+> and <-> keys to adjust the minimum chassis fan duty cycle. The values range from 60% to 100%. When the chassis temperature is under 40°C, the chassis fan will operate at the minimum duty cycle.

2.8 Boot menu

The Boot menu items allow you to change the system boot options.



Scroll down to display the following items:



2.8.1 Fast Boot [Enabled]

[Enabled] Select to accelerate the boot speed.

[Disabled] Select to go back to normal boot.



The following four items appear when you set **Fast Boot** to [Enabled].

SATA Support [All Devices]

[All Devices] All devices connected to SATA ports will be available during POST. This process will extend the POST time.

[Hard Drive Only] Only hard drives connected to SATA ports will be detected during POST. Any hardware change will disable fast boot.

[Boot Drive Only] Only boot drive connected to SATA ports will be detected during POST. Any hardware change will disable fast boot.

USB Support [Partial In...]

[Disabled] All USB devices will not be available until OS boot up for a fastest POST time.

[Full Initialization] All USB devices will be available during POST. This process will extend the POST time.

[Partial Initialization] For a faster POST time, only the USB ports with keyboard and mouse connections will be detected.

Network Stack Driver Support [Disabled]

[Disabled] Select to skip the network stack driver from loading during POST.

[Enabled] Select to load the network stack driver during POST.

Next Boot after AC Power Loss [Normal Boot]

[Normal Boot] Returns to normal boot on the next boot after AC power loss.

[Fast Boot] Accelerates the boot speed on the next boot after AC power loss.

2.8.2 Boot Logo Display [Enabled]

- [Auto] Adjusts logo automatically based on Windows® display requirementst.
- [Full Screen] Maximize the boot logo size.
- [Disabled] Hide the logo during POST.

POST Delay Time [3 sec]

This item appears only when you set **Boot Logo Display** to [Enabled]. This item allows you to select the desired additional POST waiting time to easily enter the BIOS setup. You can only execute the POST delay time during Normal Boot. The values range from 0 to 10 seconds.



This feature will only work under normal boot.

Post Report [5 sec]

This item appears only when you set **Boot Logo Display** to [Disabled]. This item allows you to select a desired post report waiting time. Configuration options: [1 sec] ~ [10 sec] [Until Press ESC].

2.8.3 Bootup NumLock State [On]

- [On] Sets the power-on state of the NumLock to [On].
- [Off] Sets the power-on state of the NumLock to [Off].

2.8.4 Wait for 'F1' If Error [Enabled]

When this item is set to [Enabled], the system waits for the F1 key to be pressed when error occurs. Configuration options: [Disabled] [Enabled]

2.8.5 Option ROM Messages [Force BIOS]

- [Force BIOS] The third-party ROM messages will be forced to display during the boot sequence.
- [Keep Current] The third-party ROM messages will be displayed only if the third-party manufacturer had set the add-on device to do so.

2.8.6 Interrupt 19 Capture [Disabled]

- [Enabled] Allows the option ROMs to trap Interrupt 19.
- [Disabled] Disables this function.

2.8.7 Setup Mode [EZ Mode]

- [Advanced Mode] Sets Advanced Mode as the default screen for entering the BIOS setup program.
- [EZ Mode] Sets EZ Mode as the default screen for entering the BIOS setup program.

2.8.8 CSM (Compatibility Support Module)

Allows you to configure the CSM (Compatibility Support Module) items to fully support the various VGA, bootable devices and add-on devices for better compatibility.

Launch CSM [Enabled]

- [Auto] The system automatically detects the bootable devices and the add-on devices.
- [Enabled] For better compatibility, enable the CSM to fully support the non-UEFI driver add-on devices or the Windows® UEFI mode.
- [Disabled] Disable the CSM to fully support the Windows® Security Update and Security Boot.



The following four items appear when you set Launch CSM to [Enabled].

Boot Devices Control [UEFI and Legacy OpROM]

Allows you to select the type of devices that you want to boot up. Configuration options: [UEFI and Legacy OpROM] [Legacy OpROM only] [UEFI only]

Boot from Network Devices [Legacy OpROM first]

Allows you to select the type of network devices that you want to launch. Configuration options: [Legacy OpROM first] [UEFI driver first] [Ignore]

Boot from Storage Devices [Legacy OpROM first]

Allows you to select the type of storage devices that you want to launch. Configuration options: [Both, Legacy OpROM first] [Both, UEFI first] [Legacy OpROM first] [UEFI driver first] [Ignore]

Boot from PCIe/PCI Expansion Devices [Legacy OpROM first]

Allows you to select the type of PCIe/PCI expansion devices that you want to launch. Configuration options: [Legacy OpROM first] [UEFI driver first]

2.8.9 Secure Boot

Allows you to configure the Windows® Secure Boot settings and manage its keys to protect the system from unauthorized access and malwares during POST.

OS Type [Windows UE...]

Allows you to select your installed operating system.

[Windows UEFI mode] Executes the Microsoft® Secure Boot check. Only select this option when booting on Windows® UEFI mode or other Microsoft® Secure Boot compliant OS.

[Other OS] Get the optimized function when booting on Windows® non-UEFI mode, Windows® Vista/XP, or other Microsoft® Secure Boot non-compliant OS. Only on Windows® UEFI mode that Microsoft® Secure Boot can function properly.



The following item appears when **OS Type** is set to **[Windows UEFI mode]**.

Key Management

This item appears only when you set Secure Boot Mode to [Custom]. It allows you to manage the Secure Boot keys.

Clear Secure Boot keys

This item appears only when you load the default Secure Boot keys. This item allows you to clear all default Secure Boot keys.

Save Secure Boot keys

This item appears only when you load the default Secure Boot keys. This item allows you to save all default Secure Boot keys.

PK Management

The Platform Key (PK) locks and secures the firmware from any non-permissible changes. The system verifies the PK before your system enters the OS.

Delete PK

Allows you to delete the PK from your system. Once the PK is deleted, all the system's Secure Boot keys will not be active. Configuration options: [Yes] [No]

Load PK from File

Allows you to load the downloaded PK from a USB storage device.



The PK file must be formatted as a UEFI variable structure with time-based authenticated variable.

KEK Management

The KEK (Key-exchange Key or Key Enrollment Key) manages the Signature database (db) and Revoked Signature database (dbx).



Key-exchange Key (KEK) refers to Microsoft® Secure Boot Key-Enrollment Key (KEK).

Delete the KEK

Allows you to delete the KEK from your system. Configuration options:
[Yes] [No]

Load KEK from File

Allows you to load the downloaded KEK from a USB storage device.

Append KEK from file

Allows you to load the additional KEK from a storage device for an additional db and dbx loaded management.



The KEK file must be formatted as a UEFI variable structure with time-based authenticated variable.

DB Management

The db (Authorized Signature database) lists the signers or images of UEFI applications, operating system loaders, and UEFI drivers that you can load on the single computer.

Delete the db

Allows you to delete the db file from your system. Configuration options:
[Yes] [No]

Load db from File

Allows you to load the downloaded db from a USB storage device.

Append db from file

Allows you to load the additional db from a storage device so that more images can be loaded securely.



The DB file must be formatted as a UEFI variable structure with time-based authenticated variable.

DBX Management

The dbx (Revoked Signature database) lists the forbidden images of db items that are no longer trusted and cannot be loaded.

Delete the DBX

Allows you to delete the DBX file from your system. Configuration options:
[Yes] [No]

Load DBX from File

Allows you to load the downloaded DBX from a USB storage device.

Append DBX from file

Allows you to load the additional DBX from a storage device so that more db's images cannot be loaded.



The DBX file must be formatted as a UEFI variable structure with time-based authenticated variable.

2.8.10 Boot Option Priorities

These items specify the boot device priority sequence from the available devices. The number of device items that appears on the screen depends on the number of devices installed in the system.



- To select the boot device during system startup, press <F8> when ASUS Logo appears.
 - To access Windows OS in Safe Mode, do any of the following:
 - Press <F5> when ASUS Logo appears.
 - Press <F8> after POST.
-

2.8.11 Boot Override

These items displays the available devices. The number of device items that appears on the screen depends on the number of devices installed in the system. Click an item to start booting from the selected device.

2.9 Tools menu

The Tools menu items allow you to configure options for special functions. Select an item then press <Enter> to display the submenu.

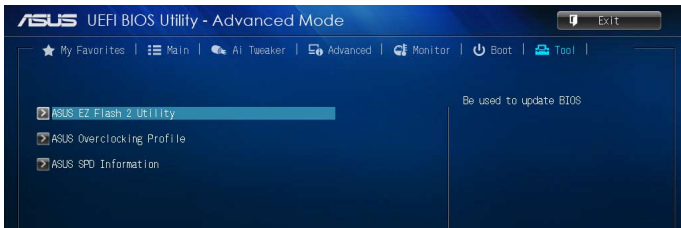

2.9.1 ASUS EZ Flash 2 Utility

Allows you to run ASUS EZ Flash 2. Press [Enter] to launch the ASUS EZ Flash 2 screen.



For more details, see section 2.1.2 **ASUS EZ Flash 2**.

2.9.2 ASUS O.C. Profile

This item allows you to store or load multiple BIOS settings.



The **Setup Profile Status** items show **Not Installed** if no profile is created.

Save to Profile

Allows you to save the current BIOS settings to the BIOS Flash, and create a profile. Key in a profile number from one to eight, press <Enter>, and then select **Yes**.

Load from Profile

Allows you to load the previous BIOS settings saved in the BIOS Flash. Key in the profile number that saved your CMOS settings, press <Enter>, and then select **Yes**.



-
- DO NOT shut down or reset the system while updating the BIOS to prevent the system boot failure!
 - We recommend that you update the BIOS file only coming from the same memory/CPU configuration and BIOS version.
-

2.9.3 ASUS SPD Information

DIMM Slot # [DIMM_A1]

Displays the Serial Presence Detect (SPD) information of the DIMM module installed on the selected slot. Configuration options: [DIMM_A1] [DIMM_B1]

2.10 Exit menu

The Exit menu items allow you to load the optimal default values for the BIOS items, and save or discard your changes to the BIOS items. You can access the EZ Mode from the Exit menu.

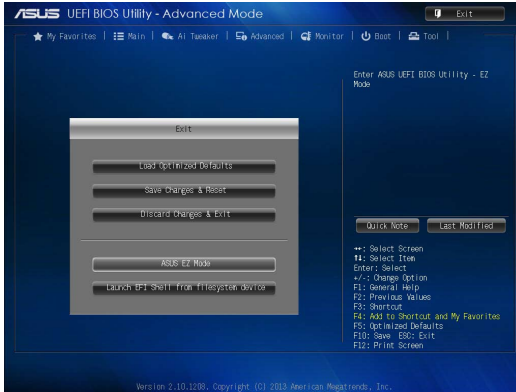

Load Optimized Defaults

This option allows you to load the default values for each of the parameters on the Setup menus. When you select this option or if you press <F5>, a confirmation window appears. Select Yes to load the default values.

Save Changes & Reset

Once you are finished making your selections, choose this option from the Exit menu to ensure the values you selected are saved. When you select this option or if you press <F10>, a confirmation window appears. Select Yes to save changes and exit.

Discard Changes & Exit

This option allows you to exit the Setup program without saving your changes. When you select this option or if you press <Esc>, a confirmation window appears. Select Yes to discard changes and exit.

ASUS EZ Mode

This option allows you to enter the EZ Mode screen.

Launch EFI Shell from filesystem device

This option allows you to attempt to launch the EFI Shell application (shellx64.efi) from one of the available devices that have a filesystem.

Appendices

Notices

Federal Communications Commission Statement

This device complies with Part 15 of the FCC Rules. Operation is subject to the following two conditions:

- This device may not cause harmful interference.
- This device must accept any interference received including interference that may cause undesired operation.

This equipment has been tested and found to comply with the limits for a Class B digital device, pursuant to Part 15 of the FCC Rules. These limits are designed to provide reasonable protection against harmful interference in a residential installation. This equipment generates, uses and can radiate radio frequency energy and, if not installed and used in accordance with manufacturer's instructions, may cause harmful interference to radio communications. However, there is no guarantee that interference will not occur in a particular installation. If this equipment does cause harmful interference to radio or television reception, which can be determined by turning the equipment off and on, the user is encouraged to try to correct the interference by one or more of the following measures:

- Reorient or relocate the receiving antenna.
- Increase the separation between the equipment and receiver.
- Connect the equipment to an outlet on a circuit different from that to which the receiver is connected.
- Consult the dealer or an experienced radio/TV technician for help.



The use of shielded cables for connection of the monitor to the graphics card is required to assure compliance with FCC regulations. Changes or modifications to this unit not expressly approved by the party responsible for compliance could void the user's authority to operate this equipment.

IC: Canadian Compliance Statement

Complies with the Canadian ICES-003 Class B specifications. This device complies with RSS 210 of Industry Canada. This Class B device meets all the requirements of the Canadian interference-causing equipment regulations.

This device complies with Industry Canada license exempt RSS standard(s). Operation is subject to the following two conditions: (1) this device may not cause interference, and (2) this device must accept any interference, including interference that may cause undesired operation of the device.

Cet appareil numérique de la Classe B est conforme à la norme NMB-003 du Canada.

Cet appareil numérique de la Classe B respecte toutes les exigences du Règlement sur le matériel brouilleur du Canada.

Cet appareil est conforme aux normes CNR exemptes de licence d'Industrie Canada. Le fonctionnement est soumis aux deux conditions suivantes :

- (1) cet appareil ne doit pas provoquer d'interférences et
- (2) cet appareil doit accepter toute interférence, y compris celles susceptibles de provoquer un fonctionnement non souhaité de l'appareil.

Canadian Department of Communications Statement

This digital apparatus does not exceed the Class B limits for radio noise emissions from digital apparatus set out in the Radio Interference Regulations of the Canadian Department of Communications.

This class B digital apparatus complies with Canadian ICES-003.

VCCI: Japan Compliance Statement

VCCI Class B Statement

情報処理装置等電波障害自主規制について

この装置は、情報処理装置等電波障害自主規制協議会（VCCI）の基準に基づくクラスB情報技術装置です。この装置は家庭環境で使用されることを目的としていますが、この装置がラジオやテレビジョン受信機に近接して使用されると、受信障害を引き起こすことがあります。

取扱説明書に従って正しい取り扱いをして下さい。

KC: Korea Warning Statement

B급 기기 (가정용 방송통신기자재)

이 기기는 가정용(B급) 전자파적합기기로서 주로 가정에서 사용하는 것을 목적으로 하며, 모든 지역에서 사용할 수 있습니다.

*당해 무선설비는 전파혼신 가능성이 있으므로 인명안전과 관련된 서비스는 할 수 없습니다.

REACH

Complying with the REACH (Registration, Evaluation, Authorisation, and Restriction of Chemicals) regulatory framework, we published the chemical substances in our products at ASUS REACH website at <http://csr.asus.com/english/REACH.htm>.



DO NOT throw the motherboard in municipal waste. This product has been designed to enable proper reuse of parts and recycling. This symbol of the crossed out wheeled bin indicates that the product (electrical and electronic equipment) should not be placed in municipal waste. Check local regulations for disposal of electronic products.



DO NOT throw the mercury-containing button cell battery in municipal waste. This symbol of the crossed out wheeled bin indicates that the battery should not be placed in municipal waste.

ASUS Recycling/Takeback Services

ASUS recycling and takeback programs come from our commitment to the highest standards for protecting our environment. We believe in providing solutions for you to be able to responsibly recycle our products, batteries, other components as well as the packaging materials. Please go to <http://csr.asus.com/english/Takeback.htm> for detailed recycling information in different regions.

ASUS contact information

ASUSTeK COMPUTER INC.

Address 15 Li-Te Road, Peitou, Taipei, Taiwan 11259
Telephone +886-2-2894-3447
Fax +886-2-2890-7798
E-mail info@asus.com.tw
Web site <http://www.asus.com>

Technical Support

Telephone +86-21-3842-9911
Fax +86-21-5866-8722 ext. 9101#
Online support <http://support.asus.com/techserv/techserv.aspx>

ASUS COMPUTER INTERNATIONAL (America)

Address 800 Corporate Way, Fremont, CA 94539, USA
Telephone +1-510-739-3777
Fax +1-510-608-4555
Web site <http://usa.asus.com>

Technical Support

Support fax +1-812-284-0883
General support +1-812-282-2787
Online support <http://support.asus.com/techserv/techserv.aspx>

ASUS COMPUTER GmbH (Germany and Austria)

Address Harkort Str. 21-23, D-40880 Ratingen, Germany
Fax +49-2102-959931
Web site <http://www.asus.com/de>
Online contact <http://eu-rma.asus.com/sales>

Technical Support

Telephone +49-2102-5789555
Support Fax +49-2102-959911
Online support support.asus.com

DECLARATION OF CONFORMITY

Per FCC Part 2 Section 2.1077(a)



Responsible Party Name: **Asus Computer International**

Address: **800 Corporate Way, Fremont, CA 94539,**

Phone/Fax No: **(510)739-3777/(510)608-4555**

hereby declares that the product

Product Name : Motherboard

Model Number : Q87T

Conforms to the following specifications:

FCC Part 15, Subpart B, Unintentional Radiators

Supplementary Information:

This device complies with part 15 of the FCC Rules. Operation is subject to the following two conditions: (1) This device may not cause harmful interference, and (2) this device must accept any interference received, including interference that may cause undesired operation.

Representative Person's Name : Steve Chang / President

Signature :

Date : Sept. 12, 2013

Ver. 12/001

EC Declaration of Conformity



We, the undersigned,

Manufacturer: **ASUSTEK COMPUTER INC.**
Address, City: **#F, No. 150, LI-FU ERG, PEITOU, TAIPEI 112, TAIWAN**
Country: **TAIWAN**
Authorized representative in Europe: **ASUS COMPUTER GmbH**
Address, City: **HAKSBOFF STR. 21-23, 40880 RATINGEN**
Country: **GERMANY**

declare the following apparatus:

Product name : **Motherboard**
Model name : **Q87T**

conform with the essential requirements of the following directives:

- 2002/95/EC-EMC Directive**
 EN 141065-2:2006-4:2009
 EN 141065-2:2006-4:2009
 EN 55013:2001+A1:2003-04:2006
 1999/5/EC-RTTE Directive
 EN 300 328 V1.7 (2006-10)
 EN 300 440-1 V1.5 (2001-08)
 EN 300 440-2 V1.5 (2001-08)
 EN 301 511 V6.02 (2003-03)
 EN 301 808-1 V5.2 (2001-05)
 EN 301 908-2 V5.2 (2001-07)
 EN 302 544-2 V1.1 (2009-01)
 EN 302 683 V1.1 (2009-01)
 EN 302 328-3 V1.3 (2007-06)
 EN 302 328-3 V1.2 (2007-06)
 EN 302 328-3 V1.1 (2007-06)
 EN 302 291-1 V1.1 (2006-07)
 EN 302 291-2 V1.1 (2006-07)
 EN 302 291-1 V1.1 (2006-07)
 EN 302 291-2 V1.1 (2006-07)
 EN 301 488-1 V1.9.2 (2011-09)
 EN 301 488-3 V1.4 (2006-08)
 EN 301 488-3 V1.3 (2006-08)
 EN 301 488-3 V1.3 (2006-11)
 EN 301 488-9 V1.4 (2007-11)
 EN 301 488-17 V1.2 (2012-09)
 EN 301 488-17 V1.2 (2012-09)
 EN 302 328-2 V1.2 (2007-06)
 EN 302 328-2 V1.2 (2007-06)
 EN 302 328-2 V1.1 (2007-06)
 EN 302 328-2 V1.1 (2007-06)
 EN 302 291-1 V1.1 (2006-07)
 EN 302 291-2 V1.1 (2006-07)

2006/95/EC-LVD Directive

EN 60950-1 / A12:2011

2006/125/EC-ERP Directive

Regulation (EC) No. 175/2008

Regulation (EC) No. 642/2009

2011/65/EU-RoHS Directive

CE marking



(EC conformity marking)

Position : **CEO**
Name : **Jerry Shan**

Signature : _____

Declaration Date: **12/09/2013**
Year to begin affixing CE marking: **2013**

Ver. 120816