

## All-in-One PC for POS, POI, Kiosk Applications

The Shuttle XPC all-in-one X50V6 is the latest addition to the X50 Series and is powered by Intel's Celeron 3865U processor. The all-new 14 nm Kaby Lake architecture helps improve on power consumption and computing power. Thanks to its passive cooling, the system is virtually noiseless, maintenance-free and approved for 24/7 nonstop operation. Particularly suitable for vertical applications is the arrangement of connectors at the bottom and the IP54 compliant front panel which is dust-protected and protected from splashing of water.

### Feature Highlights

<b>All-in-One Design</b>	<ul style="list-style-type: none"> <li>• XPC all-in-one with touchscreen</li> <li>• Small: 391 x 327 x 42 mm (WHL)</li> <li>• Stand can also be used as a handle</li> <li>• 100 mm VESA mount capable</li> <li>• IP54 compliant front panel</li> <li>• Approved for 24/7 nonstop operation</li> </ul>
<b>Display &amp; Graphics</b>	<ul style="list-style-type: none"> <li>• 39.6 cm (15.6") resistive touchscreen with a 1366 x 768 resolution</li> <li>• Integrated Intel HD 610 graphics</li> <li>• HDMI 1.4 + D-Sub/VGA Video output</li> </ul>
<b>CPU &amp; Cooling</b>	<ul style="list-style-type: none"> <li>• Intel Celeron 3865U, 1.8 GHz, 15 W TDP</li> <li>• Fanless heatpipe cooling system</li> </ul>
<b>Storage (not included)</b>	<ul style="list-style-type: none"> <li>• Supports max. 2x 16 GB DDR4-2133 SO-DIMM</li> <li>• Supports one 2.5" SATA hard disk / SSD</li> <li>• Supports one M.2-2280 SSD (SATA / PCIe)</li> <li>• Supports internal USB stick (USB 2.0, type A)</li> </ul>
<b>Operating System</b>	<ul style="list-style-type: none"> <li>• Operating system is not included</li> <li>• Supports Windows 10 (64-bit) &amp; Linux (64-bit)</li> </ul>
<b>Connectivity</b>	<ul style="list-style-type: none"> <li>• HDMI 1.4, D-Sub/VGA</li> <li>• 2x USB 3.0, 4x USB 2.0, internal: 2x USB 2.0</li> <li>• Microphone input, headphones output</li> <li>• Gigabit LAN, Wireless LAN 802.11n</li> <li>• Optional: 4x RS232, 1x LPT, 1x RJ11</li> </ul>
<b>Built-in</b>	<ul style="list-style-type: none"> <li>• SD card reader</li> <li>• 2.0 Megapixel HD webcam</li> <li>• 2x 2 W speakers</li> <li>• Electret Condenser Microphone</li> </ul>
<b>Power Supply</b>	<ul style="list-style-type: none"> <li>• External fanless power adapter, 65 W</li> </ul>
<b>Warranty</b>	<ul style="list-style-type: none"> <li>• 24 months Bring-in Service</li> </ul>

## XPC all-in-one Barebone X50V6 White

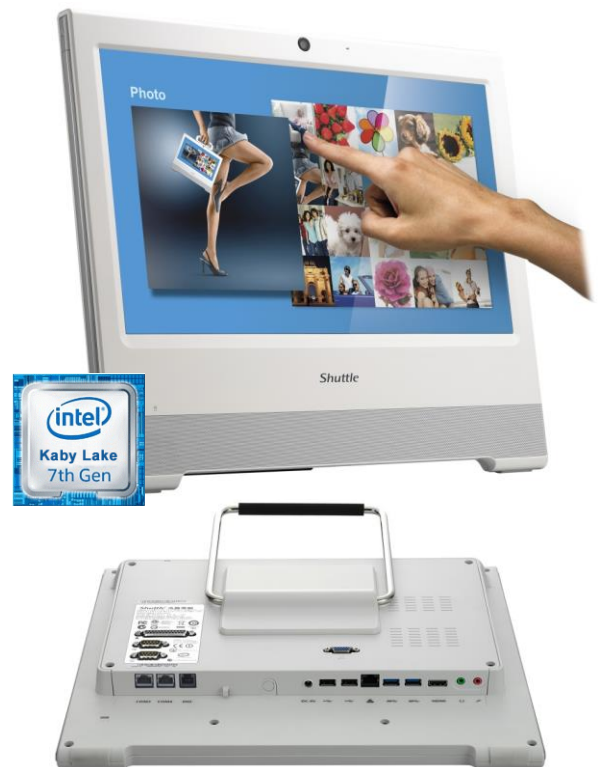

Images for illustration purposes only.



15.6" Touchscreen



Nonstop operating



Fanless cooling



Front protected: dust & water



Up to four COM ports



Windows 10 & Linux (64-bit)



Wireless and Wired Network



2x USB 3.0 4x USB 2.0



Watchdog Hardware



Shuttle XPC all-in-one X50V6 – Overview

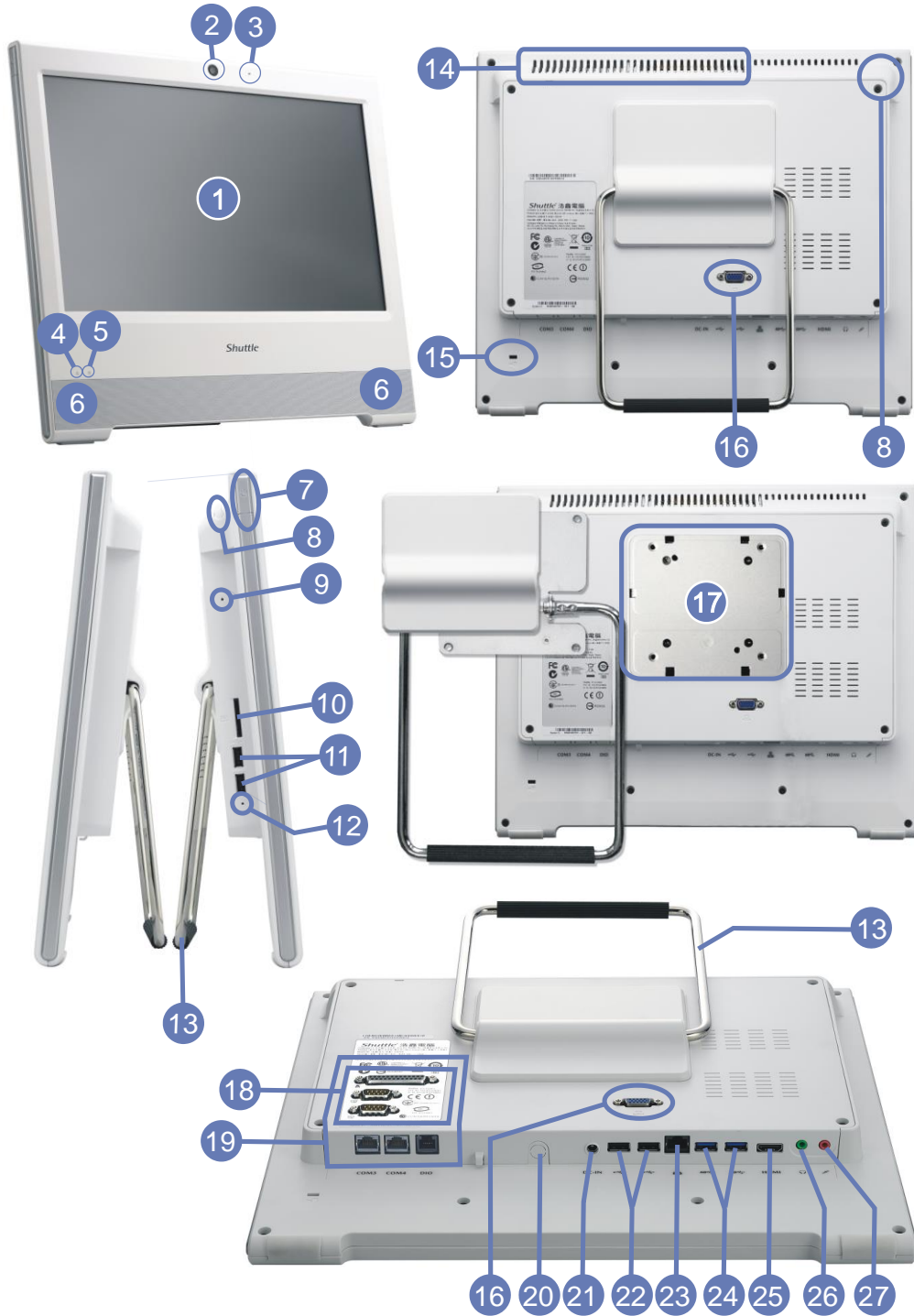

- |   |                         |    |                                |    |                                     |
|---|-------------------------|----|--------------------------------|----|-------------------------------------|
| 1 | Touchscreen LCD display | 10 | SD Card Reader                 | 19 | Optional: 4x COM, LPT, RJ11 (POS01) |
| 2 | Webcam                  | 11 | 2x USB 2.0                     | 20 | Perforation for TV antenna (9 mm)   |
| 3 | Microphone              | 12 | Clear CMOS Button              | 21 | DC-input for Power Adapter          |
| 4 | Power on LED            | 13 | Stand (handle)                 | 22 | 2x USB 2.0                          |
| 5 | Hard disk LED           | 14 | Cooling Vents                  | 23 | RJ45 Gigabit LAN                    |
| 6 | Stereo speakers         | 15 | Kensington lock                | 24 | 2x USB 3.0                          |
| 7 | Power-on button         | 16 | D-Sub/VGA Video Output         | 25 | HDMI Video Output                   |
| 8 | Stylus with holder      | 17 | Vesa Mount 100x100mm           | 26 | Audio Line-out (headphones)         |
| 9 | Power Button            | 18 | Optional: 2x COM + LPT (PCL71) | 27 | Microphone Input                    |

© 2017 by Shuttle Computer Handels GmbH (Germany). All information subject to change without notice. Pictures for illustration purposes only.

Shuttle XPC all-in-one X50V6 – Mainboard

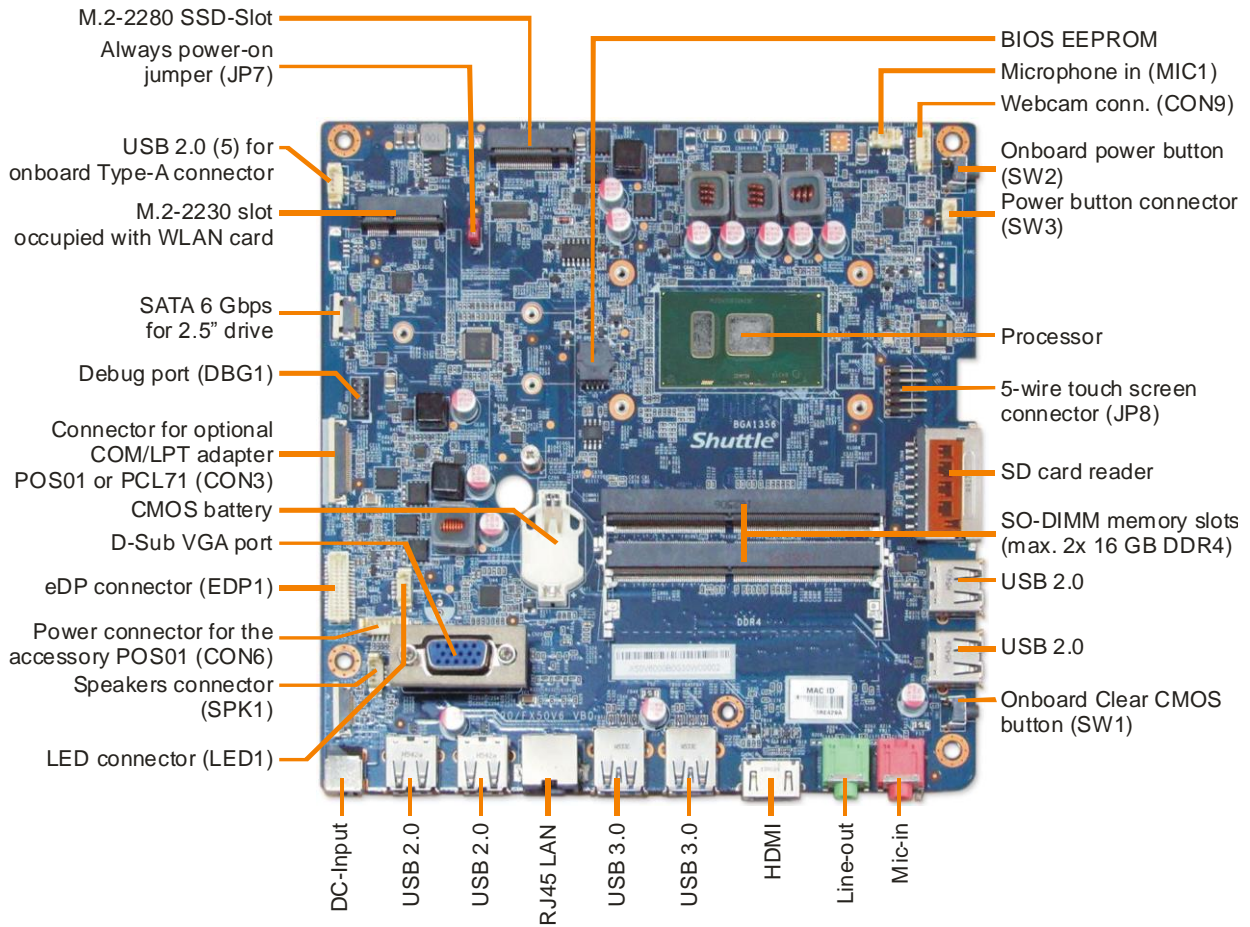

Installable Components:

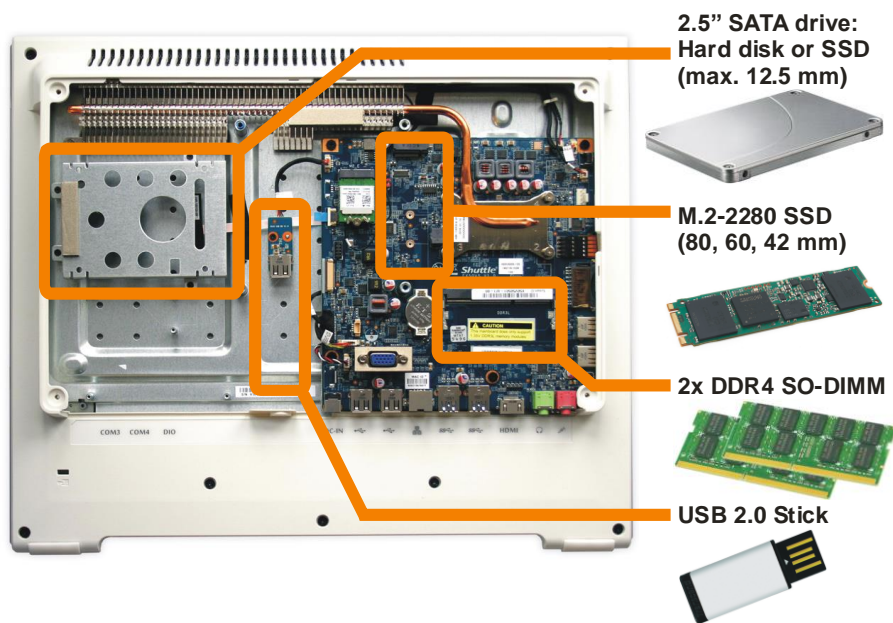



## Shuttle XPC all-in-one X50V6 – Special Features



### All applications at your fingertips

The innovative touchscreen technology delivers the simplest operation possible and makes the screen the centre of action. Its high-quality design lets you control the whole range of multimedia - music, movies, video playback and web browsers start by just touching the screen.



### All-in-One PC

Your complete PC system with many components already built in comes in just one single device! This includes the webcam, microphone, mainboard, display, touchscreen input interface, wireless LAN module and speakers. It helps you save space, looks simply stylish and reduces cable clutter.

### 24/7 nonstop operation

The Shuttle XPC all-in-one X50V6 is officially approved for 24/7 permanent operation. Thanks to its low power consumption and completely passive cooling, this PC runs highly reliable making it perfectly suitable for digital signage and POI/POS applications.



### Conditions for permanent use:

- Ambient temperature while under load: 5 - 35 °C
- Air humidity while under load: 10 - 80 % (not condensing)
- Free circulation of air amongst the PC must be guaranteed
- Ventilation holes must be kept clear
- If a hard disk is installed, this must also be approved for permanent operation by its manufacturer.



### Fanless and quiet

The Shuttle XPC all-in-one X50V6 uses a passive thermal module with heatpipes to lead heat out of the case quickly and evenly. The unique fanless design makes it perfect to be used in noise-sensitive environments such as living rooms, hospitals, libraries etc. As an additional benefit, fanless cases rarely gather dust on the inside and stay cleaner than others. So it's not only quiet and low in energy use, but also virtually maintenance-free.



**Connects to two external Full HD displays**

The Shuttle XPC all-in-one X50V6 features two video outputs: One analog D-Sub/VGA connector and one HDMI connector. Two external Full HD displays can be connected in extended mode. Now add the built-in display of the X50V6 and there are three displays showing different content.



**Protection Class IP54**

The front panel of the Shuttle XPC all-in-one X50V6 is dust-protected and protected from splashing of water according to IP protection class 54. Consequently, this All-in-One PC can be used for those indoor applications, where the touchscreen may be exposed to humidity and occasional splashing of water. This is particularly welcome in restaurants, laboratories, production or other places.



**Supports high-performance M.2 SSDs**

The M.2 slot (type 2280) is fully-equipped with 4X PCI-Express v3.0 lanes and SATA 3.0 interfaces. Modern M.2 SSDs with PCI Express interface (PCIe) and NVMe provide a significant higher bandwidth compared to the usual SATA standard. Type 2280 means it supports the usual M.2 cards with a width of 22 mm and a length of 80 mm, but also 2242 and 2260 standard cards are supported.



**Optimised Cable Management**

Most of the connectors are now located at the back panel facing down. This leads to an effective cable management making for a clean, tidy appearance on the desk. On the left side sit those connectors which need to be accessed from the front: the card reader and two USB ports.



**Connects to two external Full HD displays**

The Shuttle XPC all-in-one X50V6 features two video outputs: One analog D-Sub/VGA connector and one HDMI connector. Two external Full HD displays can be connected in extended mode. Now add the built-in display of the X50V6 and there are three displays showing different content.

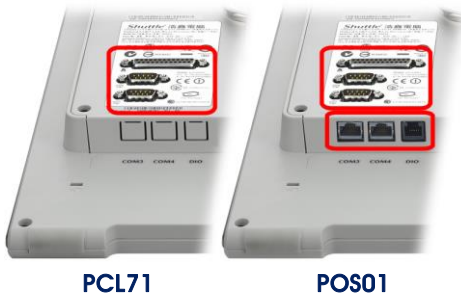

**Optional COM, LPT, DIO ports**

Shuttle offers two optional accessories in order to add legacy ports to the Shuttle XPC all-in-one X50V6. While the Shuttle Accessory **PCL71** adds two serial COM ports and one parallel LPT port, the **POS01** adds two more COM ports (with RJ45 connector) and one Digital I/O 12 V / 24 V (RJ11) for a cash drawer, for example. COM ports are still commonly used for applications such as industrial automation systems, scientific analysis, POS systems and other industrial applications.

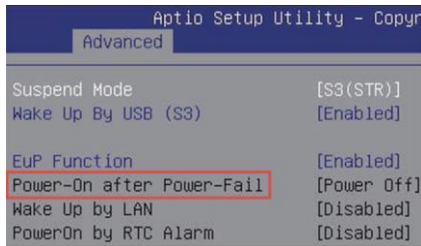

**Power on after Power fail**

The BIOS setup provides a "Power-On after Power Fail" function that can be found under "Power Management Configuration" where the PC's behaviour after power failure can be determined.

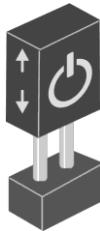

**Always Power-on Jumper**

The Shuttle XPC all-in-one X50V6 also comes with a hardware-based solution. By removing Jumper 7, the system will start unconditionally once power is applied.



**Hidden Power Button**

The power button can be deactivated to prevent unauthorized use. Still it can be used with a straightened paper clip as shown on the left.



**Internal USB Slot and perforation for external antenna**

The Shuttle XPC all-in-one X50V6 features an internal USB 2.0 connector (type A) for a USB stick of max. 9 cm in length and a 9 mm perforation for an optional antenna. The internal USB connector for expansion sticks (such as flash memory, DVB-T, SAT, 3G) or other USB devices like a radio module for home automation or RFID. Furthermore, there is a free USB header available on the mainboard.



### VESA mount

The stand on the rear can easily be removed to unveil four VESA mounting screw holes that can be used for mounting arms and other mounting devices from a variety of manufacturers.



### Stylus for the touchscreen

The Shuttle XPC all-in-one X50V6 is equipped with a 5-wire resistive touchscreen for simple operation by finger (even with gloves) or stylus. The stylus comes supplied as standard and sits in an opening located at the top of the chassis. Using the stylus results in a smoother and more precise input than just using a finger.



### Kensington Lock

This is a small, metal-reinforced hole as part of an anti-theft system. (Lock and cable not included.)



### Carrying handle

The practical stand can be pulled upwards to also serve as a handle making the Shuttle XPC all-in-one X50V6 easy to carry. Clever!



Shuttle XPC all-in-one X50V6 – Range of Applications



**Digital Signage**  
Visual advertising,  
entertainment, displaying  
information in public areas

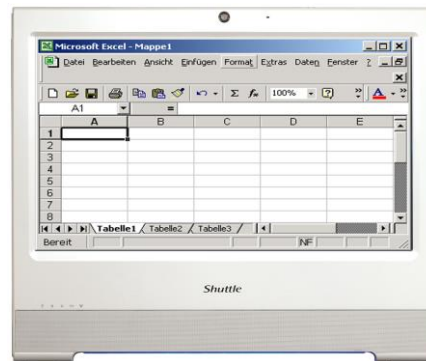

**Office Work**  
Word and spreadsheet  
processing, email, internet



**P.O.S.**  
Point of sales



**Control**  
Surveillance,  
Home Automation,  
Control device



**Communication**  
Email, VoIP, Messenger,  
Blog, Video Conferencing



**Instore Radio**  
Playing advertising  
and music

© 2017 by Shuttle Computer Handels GmbH (Germany). All information subject to change without notice. Pictures for illustration purposes only.



## Shuttle XPC all-in-one X50V6 – Specifications

<i>Fanless and silent</i>	<p>Passive heatpipe cooling, no fan noise at all                  Perfect to be used in noise-sensitive environments                  Fanless, dust-free and thus virtually maintenance-free</p>
<i>24/7 nonstop operation</i>	<p>This device is approved for 24/7 permanent operation.                  Requirements:                  - Free circulation of air amongst the PC must be guaranteed.                  - Ventilation holes must be kept clear.                  - If a hard disk is installed, this must also be approved for permanent operation by its manufacturer.</p>
<i>IP54 protected</i>	<p>The front panel is dust-protected and protected from splashing of water according to protection class IP54.</p>
<i>Chassis</i>	<p>Colour: white                  Dimensions: 391 x 327 x 42 mm (W x H x D)                  100mm VESA mount capable                  Mounting hole for Kensington lock                  Weight: 3.6 kg net, 4.8 kg gross</p>
<i>Operation System</i>	<p>This system comes without operating system.                  It is compatible with:                  - Windows 10 (64-bit)                  - Linux (64-bit)</p>
<i>Touchscreen</i>	<p>Touchscreen function supports fingertip input                  Resistive 5-wire single-touch technology                  Stylus for the touchscreen included</p>
<i>15.6" Display</i>	<p>39.6 cm / 15.6" LCD display, ratio: 16:9 widescreen panel                  Resolution: 1366 x 768 = 1.05 Megapixel                  Backlight unit: High power LED, Luminance: 220 cd/sqm                  Glass thickness: 0.5 mm</p>
<i>Processor</i>	<p>Model: Intel Celeron 3865U (ULV)                  System-on-a-chip architecture (SoC): no chipset required                  BGA1356 package - directly soldered onto the mainboard                  Code name: Kaby Lake-U (7th Generation Intel Core)                  Cores / Threads: 2 / 2, Clock rate: 1.8 GHz                  L1/L2/L3 Cache: 128 kB / 512 kB / 2048 kB                  Memory controller: DDR4-2133 Dual Channel (1.2 V)                  TDP wattage: 15 W maximum                  Manufacturing process: 14 nm                  Maximum Tjunction Temperature: 100 °C                  Supports 64-bit, VT-x (EPT), VT-d, Enhanced SpeedStep, NX bit, AES-NI, SSE 4.1/4.2                  Integrated graphics engine</p>

© 2017 by Shuttle Computer Handels GmbH (Germany). All information subject to change without notice. Pictures for illustration purposes only.

<p><i>Integrated Graphics</i></p>	<p>Intel HD Graphics 610                      GPU clock frequency: 300~900 MHz                      Execution Units (EUs): 12                      Supports DirectX 12                      Supports full H264, H265 8/10 bit, VP8/9, VC-1, AVC hardware decoding                      Supports Quick Sync Video and Clear Video HD technology</p>
<p><i>Up to three displays</i></p>	<p>Two video ports support two additional independent screens:                      1) HDMI 1.4 supports 1920 x 1080 @ 60 Hz or 3840 x 2160 @ 30 Hz                      2) VGA / D-Sub analog video supports 1920 x 1080 @ 60 Hz                      Special conditions for operation in Multi-Monitoring mode:                      1) Clone mode: all displays show the same content at 1366 x 768 resolution                      2) Extended mode: all displays show different content</p>
<p><i>BIOS</i></p>	<p>AMI BIOS in 8 MByte EEPROM with SPI interface                      Supports Power fail resume / always on                      Supports Wake-on-LAN (WOL) from S3, S4, S5 ACPI states                      Supports hardware monitoring and watch dog functionality                      Supports Firmware TPM v2.0 functionality</p>
<p><i>Memory</i></p>	<p>2x SO-DIMM slot with 260 pins                      Supports DDR4-2133 (PC4-17000) SDRAM at 1.2 V                      Supports Dual Channel mode                      Supports a maximum of 16 GB per DIMM, maximum total size: 32 GB                      Supports two unbuffered DIMM modules (no ECC or registered)</p>
<p><i>Storage</i></p>	<p>Supports one SATA hard disk or one SATA SSD drive in 6.35 cm /2.5" format                      The SATA 3.0 interface supports up to 600 MB/s data transfer speed (6 Gbit/s).                      Supports one drive with up to 12.5 mm in height</p>
<p><i>M.2-2280 Slot</i></p>	<p>The M.2 2280 BM slot provides the following interfaces:                      - PCI-Express Gen. 3.0 X4 with up to 32 Gbps Data Transfer Speed                      - SATA v3.0 (max. 6 Gbps)                      It supports M.2 cards with a width of 22 mm and a length of 42, 60 or 80 mm (type 2242, 2260, 2280).                      Supports M.2 SATA SSDs (with B+M key) and M.2 PCIe SSDs (with M key)</p>
<p><i>Card Reader</i></p>	<p>Integrated card reader supports SD, SDHC and SDXC memory flash cards</p>
<p><i>Webcam</i></p>	<p>Integrated 2.0 Megapixel (1600 x 1200) HD webcam</p>
<p><i>Microphone Speakers</i></p>	<p>Front panel with integrated Electret Condenser Microphone and 2x 2W speakers</p>
<p><i>Audio</i></p>	<p>Realtek ALC269 Audio Codec                      Two analog audio connectors (3.5 mm) on the bottom side:                      1) Line-out (headphones)                      2) Microphone input                      Digital Audio is supported via HDMI.</p>

© 2017 by Shuttle Computer Handels GmbH (Germany). All information subject to change without notice. Pictures for illustration purposes only.

<i>Wired Network</i>	<p>Intel i211 Ethernet Controller with MAC, PHY and PCIe interface</p> <p>Supports 10 / 100 / 1.000 MBit/s operation</p> <p>Supports WAKE ON LAN (WOL) from S3, S4 modes</p> <p>Supports network boot by Preboot eXecution Environment (PXE)</p>
<i>Wireless Network</i>	<p>WLAN chip: Realtek 8188EE</p> <p>Supports IEEE 802.11b/g/n for 2.4 GHz band</p> <p>Speed: max. 150Mbps up-/downstream</p> <p>Security: WPA/WPA2, WEP</p> <p>M.2-2230AE card with internal antenna</p>
<i>Front LEDs</i>	<p>Power LED (blue)</p> <p>Hard disk LED (orange)</p>
<i>Connectors left side</i>	<p>Power button</p> <p>2x USB 2.0</p> <p>SD card reader</p> <p>Hole with power button</p> <p>Hole with Clear CMOS button</p>
<i>Connectors bottom side</i>	<p>HDMI 1.4 (supports digital video and digital audio)</p> <p>2x USB 3.0</p> <p>2x USB 2.0</p> <p>Gigabit Network (LAN, RJ45)</p> <p>Audio Line-out / headphones (3.5 mm jack)</p> <p>Microphone input (3.5 mm jack)</p> <p>DC input for external power adapter (5.5 / 2.5 mm)</p> <p>Perforation for optional TV/3G antenna (diameter: 9 mm)</p> <p>Optional: 2x COM/serial (RJ45), DIO (RJ11) for cash drawer (accessory POS01)</p>
<i>Connectors rear side</i>	<p>VGA connector (D-Sub 15 pol., analog video)</p> <p>Optional: 2x COM/serial (D-Sub), 1x LPT/parallel (accessory: PCL71 or POS01)</p>
<i>Connectors onboard</i>	<p>Internal USB 2.0 type A connector for a USB stick</p> <p>Serial ATA (6 Gbps)</p> <p>Serial ATA power connector</p> <p>3x USB 2.0 header (all occupied)</p> <p>eDP connector (Embedded DisplayPort) - occupied by the display</p> <p>Connector for optional COM/LPT adapter POS01 or PCL71</p>
<i>Power Adapter</i>	<p>External 65 W power adapter (fanless)</p> <p>Input: 100~240 V AC, 50/60 Hz, max. 1.6 A</p> <p>Output: 19 V DC, max. 3.42 A, max. 65 W</p>
<i>DC Input</i>	<p>DC Input Connector: 5.5 / 2.5 mm (outer/inner diameter)</p> <p>The DC-input of the computer supports an external power source with either 12V±5% or 19V±5%.</p>

© 2017 by Shuttle Computer Handels GmbH (Germany). All information subject to change without notice. Pictures for illustration purposes only.

<p><i>Included Accessories</i></p>	<p>Quick Guide                  Driver DVD                  External Power Adapter (65W / 19V) with Power cord                  Serial ATA cable for the 2.5" drive                  Screws</p>
<p><i>Optional Accessories</i></p>	<p><u>PCL71</u>: COM / LPT adapter:                  - 1x Parallel (25p D-Sub)                  - 2x Serial RS232 (9p D-Sub) supports 0 / 5 / 12V  <u>POS01</u>: COM / LPT adapter:                  - 1x Parallel (25p D-Sub)                  - 2x Serial RS232 (9p D-Sub) supports 0 / 5 / 12V                  - 2x Serial RS232 (8p RJ45)                  - 1x DIO/RJ11 connector for cash drawer supports 12 / 24V  <u>PF55</u>: Carrying bag</p>
<p><i>Environmental criteria</i></p>	<p>Operating temperature: 0~40 °C                  Humidity: 10~90 %</p>
<p><i>Certification and Compliance</i></p>	<p>EMI: CE, FCC, BSMI                  Safety: CB, BSMI, ETL                  Other compliances: RoHS, ErP Lot6, Energy Star v5.0</p>
<p><i>Conformity</i></p>	<p>This device is classed as a technical information equipment (ITE) in class B and is intended for use in living room and office. The CE-mark approves the conformity by the EU directives:                  (1) 2004/108/EC relating to electromagnetic compatibility (EMC),                  (2) 2006/95/EC relating to Electrical Equipment designed for use within certain voltage limits (LVD),                  (3) 2009/125/EC relating to ecodesign requirements for energy-related products (ErP),                  (4) 1999/5/EC related to Radio and Telecommunications Terminal Equipment (R&amp;TTE)</p>

© 2017 by Shuttle Computer Handels GmbH (Germany). All information subject to change without notice. Pictures for illustration purposes only.



## Shuttle XPC all-in-one X50 Series Product Comparison

Model	X50V4	X50V5 Series	X50V6 Series
<b>Processor</b>	Intel ULV processor Code name: Haswell-U 22 nm, 15 W TDP	Intel ULV processor Code name: Skylake-U 14 nm, 15 W TDP	Intel ULV processor Code name: Kaby Lake-U 14 nm, 15 W TDP
<b>SKUs</b>	<b>X50V4:</b> Celeron 2957U	<b>X50V5:</b> Celeron 3855U <b>X50V5U3:</b> Core i3-6100U	<b>X50V6:</b> Celeron 3865U
<b>Operation System Support</b>	Windows 7 – 64-bit Windows 8.1 – 64-bit Windows 10 – 64-bit Linux – 64-bit	Windows 7 – 64-bit Windows 8.1 – 64-bit Windows 10 – 64-bit Linux – 64-bit	Windows 10 – 64-bit Linux – 64-bit
<b>SSD Card Support</b>	mSATA	M.2-2280BM (PCIe x4, SATA)	M.2-2280BM (PCIe x4, SATA)
<b>Memory Support</b>	Max. 1x 8 GB DDR3L-1600 204-pin SO-DIMM	Max. 1x 16 GB DDR3L-1600 204-pin SO-DIMM	Max. 2x 16 GB DDR4-2133 260-pin SO-DIMM
<b>Wired LAN</b>	Realtek RTL8411 Gigabit LAN	Intel i219LM Gigabit LAN	Intel i211 Gigabit LAN
<b>Wireless LAN</b>	Realtek RTL8188EE IEEE 802.11n Internal antenna	Realtek RTL8821AE IEEE 802.11ac + BT 2x internal antenna	Realtek RTL8188EE IEEE 802.11n Internal antenna
<b>Power adapter</b>	65 W / 19 V	65 W / 19 V (supports 60 W / 12 V)	65 W / 19 V (supports 60 W / 12 V)
<b>TPM</b>	-	Firmware TPM v2.0 (since 2016-09-13)	Firmware TPM v2.0



© 2017 by Shuttle Computer Handels GmbH (Germany). All information subject to change without notice. Pictures for illustration purposes only.