

PRIME B360M-D

ASUS[®]

Motherboard

E14018
First Edition
March 2018

Copyright © 2018 ASUSTeK COMPUTER INC. All Rights Reserved.

No part of this manual, including the products and software described in it, may be reproduced, transmitted, transcribed, stored in a retrieval system, or translated into any language in any form or by any means, except documentation kept by the purchaser for backup purposes, without the express written permission of ASUSTeK COMPUTER INC. ("ASUS").

Product warranty or service will not be extended if: (1) the product is repaired, modified or altered, unless such repair, modification of alteration is authorized in writing by ASUS; or (2) the serial number of the product is defaced or missing.

ASUS PROVIDES THIS MANUAL "AS IS" WITHOUT WARRANTY OF ANY KIND, EITHER EXPRESS OR IMPLIED, INCLUDING BUT NOT LIMITED TO THE IMPLIED WARRANTIES OR CONDITIONS OF MERCHANTABILITY OR FITNESS FOR A PARTICULAR PURPOSE. IN NO EVENT SHALL ASUS, ITS DIRECTORS, OFFICERS, EMPLOYEES OR AGENTS BE LIABLE FOR ANY INDIRECT, SPECIAL, INCIDENTAL, OR CONSEQUENTIAL DAMAGES (INCLUDING DAMAGES FOR LOSS OF PROFITS, LOSS OF BUSINESS, LOSS OF USE OR DATA, INTERRUPTION OF BUSINESS AND THE LIKE), EVEN IF ASUS HAS BEEN ADVISED OF THE POSSIBILITY OF SUCH DAMAGES ARISING FROM ANY DEFECT OR ERROR IN THIS MANUAL OR PRODUCT.

SPECIFICATIONS AND INFORMATION CONTAINED IN THIS MANUAL ARE FURNISHED FOR INFORMATIONAL USE ONLY, AND ARE SUBJECT TO CHANGE AT ANY TIME WITHOUT NOTICE, AND SHOULD NOT BE CONSTRUED AS A COMMITMENT BY ASUS. ASUS ASSUMES NO RESPONSIBILITY OR LIABILITY FOR ANY ERRORS OR INACCURACIES THAT MAY APPEAR IN THIS MANUAL, INCLUDING THE PRODUCTS AND SOFTWARE DESCRIBED IN IT.

Products and corporate names appearing in this manual may or may not be registered trademarks or copyrights of their respective companies, and are used only for identification or explanation and to the owners' benefit, without intent to infringe.

Offer to Provide Source Code of Certain Software

This product contains copyrighted software that is licensed under the General Public License ("GPL"), under the Lesser General Public License Version ("LGPL") and/or other Free Open Source Software Licenses. Such software in this product is distributed without any warranty to the extent permitted by the applicable law. Copies of these licenses are included in this product.

Where the applicable license entitles you to the source code of such software and/or other additional data, you may obtain it for a period of three years after our last shipment of the product, either

(1) for free by downloading it from <http://support.asus.com/download>

or

(2) for the cost of reproduction and shipment, which is dependent on the preferred carrier and the location where you want to have it shipped to, by sending a request to:

ASUSTeK Computer Inc.
Legal Compliance Dept.
15 Li Te Rd.,
Beitou, Taipei 112
Taiwan

In your request please provide the name, model number and version, as stated in the About Box of the product for which you wish to obtain the corresponding source code and your contact details so that we can coordinate the terms and cost of shipment with you.

The source code will be distributed WITHOUT ANY WARRANTY and licensed under the same license as the corresponding binary/object code.

This offer is valid to anyone in receipt of this information.

ASUSTeK is eager to duly provide complete source code as required under various Free Open Source Software licenses. If however you encounter any problems in obtaining the full corresponding source code we would be much obliged if you give us a notification to the email address gpl@asus.com, stating the product and describing the problem (please DO NOT send large attachments such as source code archives, etc. to this email address).

Contents

| | |
|--|-----|
| Safety information..... | iv |
| About this guide..... | iv |
| Package contents..... | vi |
| PRIME B360M-D specifications summary | vi |
| | |
| Chapter 1: Product introduction | |
| Before you proceed | 1-1 |
| Motherboard overview..... | 1-1 |
| Central Processing Unit (CPU)..... | 1-7 |
| System memory | 1-8 |
| M.2 Anchor Installation | 1-9 |
| | |
| Chapter 2: BIOS information | |
| BIOS setup program | 2-1 |
| EZ Mode | 2-2 |
| Advanced Mode..... | 2-3 |
| Exit menu | 2-4 |
| | |
| Appendix | |
| Notices | A-1 |
| ASUS contact information..... | A-4 |

Safety information

Electrical safety

- To prevent electrical shock hazard, disconnect the power cable from the electrical outlet before relocating the system.
- When adding or removing devices to or from the system, ensure that the power cables for the devices are unplugged before the signal cables are connected. If possible, disconnect all power cables from the existing system before you add a device.
- Before connecting or removing signal cables from the motherboard, ensure that all power cables are unplugged.
- Seek professional assistance before using an adapter or extension cord. These devices could interrupt the grounding circuit.
- Ensure that your power supply is set to the correct voltage in your area. If you are not sure about the voltage of the electrical outlet you are using, contact your local power company.
- If the power supply is broken, do not try to fix it by yourself. Contact a qualified service technician or your retailer.

Operation safety

- Before installing the motherboard and adding components, carefully read all the manuals that came with the package.
- Before using the product, ensure all cables are correctly connected and the power cables are not damaged. If you detect any damage, contact your dealer immediately.
- To avoid short circuits, keep paper clips, screws, and staples away from connectors, slots, sockets and circuitry.
- Avoid dust, humidity, and temperature extremes. Do not place the product in any area where it may be exposed to moisture.
- Place the product on a stable surface.
- If you encounter technical problems with the product, contact a qualified service technician or your retailer.

About this guide

This user guide contains the information you need when installing and configuring the motherboard.

How this guide is organized

This guide contains the following parts:

- **Chapter 1: Product introduction**
This chapter describes the features of the motherboard and the new technology it supports. It includes descriptions of the switches, jumpers, and connectors on the motherboard.
- **Chapter 2: BIOS information**
This chapter discusses changing system settings through the BIOS Setup menus.

Where to find more information

Refer to the following sources for additional information and for product and software updates.

1. ASUS websites

The ASUS website provides updated information on ASUS hardware and software products. Refer to the ASUS contact information.

2. Optional documentation

Your product package may include optional documentation, such as warranty flyers, that may have been added by your dealer. These documents are not part of the standard package.

Conventions used in this guide

To ensure that you perform certain tasks properly, take note of the following symbols used throughout this manual.



DANGER/WARNING: Information to prevent injury to yourself when completing a task.



CAUTION: Information to prevent damage to the components when completing a task.



IMPORTANT: Instructions that you **MUST** follow to complete a task.



NOTE: Tips and additional information to help you complete a task.

Typography

Bold text

Indicates a menu or an item to select.

Italics

Used to emphasize a word or a phrase.

<Key>

Keys enclosed in the less-than and greater-than sign means that you must press the enclosed key.

Example: <Enter> means that you must press the Enter or Return key.

<Key1> + <Key2> + <Key3>

If you must press two or more keys simultaneously, the key names are linked with a plus sign (+).

Package contents

Check your motherboard package for the following items.

| | |
|-----------------|----------------------------------|
| Motherboard | ASUS PRIME B360M-D motherboard |
| Cables | 2 x Serial ATA 6.0 Gb/s cables |
| Accessories | 1 x I/O Shield 1 x M.2 Anchor |
| Application DVD | Support DVD |
| Documentation | User Guide |



If any of the above items is damaged or missing, contact your retailer.

PRIME B360M-D specifications summary

| | |
|-----------------|--|
| CPU | LGA1151 socket for 8th Generation Intel® Core™ i7/ i5/ i3, Pentium®, and Celeron® processors Supports Intel® 14nm CPU Supports Intel® Turbo Boost Technology 2.0* * The Intel® Turbo Boost Technology 2.0 support depends on the CPU types. ** Refer to www.asus.com for Intel® CPU support list. |
| Chipset | Intel® B360 Chipset |
| Memory | 2 x DIMMs, maximum 32 GB, DDR4 2666/ 2400/ 2133 MHz, non-ECC, un-buffered memory Dual-channel memory architecture Supports Intel® Extreme Memory Profile (XMP) * The maximum memory frequency supported varies by processor. ** DDR4 2666MHz and higher memory modules will run at max. 2666MHz on Intel® 8th Generation 6-core or higher processors. *** Refer to www.asus.com for the latest Memory QVL (Qualified Vendors List). |
| Expansion slots | 1 x PCI Express 3.0/2.0 x16 slot (at x16 mode) 2 x PCI Express 3.0/2.0 x1 slots 1 x PCI slot |
| Graphics | Integrated graphics processor - Intel® HD Graphics support Multi-VGA output support: HDMI and D-Sub ports - Supports HDMI 1.4b with max. resolution of 4096 x 2160@24Hz/ 2560 x 1600@60Hz - Supports D-Sub with max. resolution 1920 x 1200@60Hz Supports Intel® InTru™ 3D/ Quick Sync Video/ Clear Video HD Technology/ Insider™ Maximum shared memory of 1024MB (for iGPU exclusively) |
| Storage | Intel® B360 Chipset - 1 x M.2 Socket 3 with M Key, type 2242/ 2260/ 2280 storage devices support (SATA mode & x4 PCIe mode)* - 6 x SATA 6.0 Gb/s ports (gray) - Intel® Optane™ Memory Ready * When a device in SATA mode is installed on the M.2 socket, SATA_2 port cannot be used. |

(continued on the next page)

PRIME B360M-D specifications summary

| | |
|----------------------|---|
| LAN | Realtek® 8111H Gigabit LAN support LANGuard |
| Audio | <p>Realtek® ALC887 8-channel* high definition audio CODEC</p> <ul style="list-style-type: none"> - LED-illuminated design: Brighten up your build with the gorgeous illuminated audio trace path - Audio Shielding: Ensures precision analog/digital separation and greatly reduces multi-lateral interference - Dedicated audio PCB layers: Separate layers for left and right channels to guard the quality of the sensitive audio signals - Premium Japanese audio capacitors: Provide warm, natural and immersive sound with exceptional clarity and fidelity - Supports jack-detection and front panel jack-retasking <p>* Use a chassis with HD audio module in the front panel to support an 8-channel audio output.</p> |
| USB | <p>Intel® B360 Chipset:</p> <ul style="list-style-type: none"> - 6 x USB 3.1 Gen 1 (up to 5Gbps) ports (2 ports at mid-board; 4 ports at the back panel, blue, Type A) - 6 x USB 2.0/1.1 ports (4 ports at mid-board; 2 ports at the back panel) |
| ASUS unique features | <p>ASUS 5X PROTECTION III</p> <ul style="list-style-type: none"> - ASUS SafeSlot Core: Fortified PCIe Slot prevents damage - ASUS LANGuard: Protects against LAN surges, lightning strikes and static-electricity discharges! - ASUS Overvoltage Protection: World-class circuit-protecting power design - ASUS Stainless-Steel Back I/O: 3X corrosion-resistance for greater durability - ASUS DIGI+ VRM: 5 Phase digital power design <p>Superb Performance</p> <p>ASUS OptiMem</p> <ul style="list-style-type: none"> - Improved DDR4 stability <p>M.2 onboard</p> <ul style="list-style-type: none"> - The latest transfer technologies with up to 32Gb/s data transfer speeds <p>ASUS EPU</p> <ul style="list-style-type: none"> - EPU <p>UEFI BIOS</p> <ul style="list-style-type: none"> - Most advanced options with fast response time <p>Gaming Scenario</p> <p>Audio Features</p> <ul style="list-style-type: none"> - Audio that roars on the battlefield <p>ASUS Exclusive Features</p> <ul style="list-style-type: none"> - ASUS Ai Charger - ASUS AI Suite 3 - ASUS File Transfer - ASUS PC Cleaner <p>EZ DIY</p> <p>UEFI BIOS EZ Mode</p> <ul style="list-style-type: none"> - Featuring a friendly graphics user interface - ASUS CrashFree BIOS 3 - ASUS EZ Flash 3 <p>Q-Design</p> <ul style="list-style-type: none"> - ASUS Q-DIMM - ASUS Q-Slot |

(continued on the next page)

PRIME B360M-D specifications summary

| | |
|------------------------------------|---|
| ASUS quiet thermal solution | Quiet Thermal Design - ASUS Fan Xpert - Stylish Fanless Design: PCH Heat-sink solution |
| Back panel I/O ports | 1 x PS/2 keyboard/mouse combo port 1 x HDMI port 1 x D-Sub port 1 x COM port 1 x LAN (RJ-45) port 4 x USB 3.1 Gen 1 (up to 5Gbps) Type A ports (blue) 2 x USB 2.0/1.1 ports 3-Jack 8-Channel Audio I/O ports |
| Internal I/O connectors | 1 x USB 3.1 Gen 1 (up to 5Gbps) connector supports additional 2 USB ports (19-pin) 2 x USB 2.0/1.1 connectors support additional 4 USB ports 6 x SATA 6.0 Gb/s connectors (gray) 1 x M.2 Socket 3 (for M Key) 1 x 4-pin CPU Fan connector for 4-pin (PWM mode) coolers control 1 x 4-pin Chassis Fan connector for 3-pin (DC mode) and 4-pin (PWM mode) coolers control 1 x Front panel audio connector (AAFP) 1 x System panel connector 1 x S/PDIF out connector 1 x Speaker connector 1 x 24-pin EATX power connector 1 x 8-pin EATX 12V power connector 1 x Clear CMOS header |
| BIOS features | 128 Mb Flash ROM, UEFI AMI BIOS, PnP, SM BIOS 3.1, ACPI 6.1, Multi-language BIOS, ASUS EZ Flash 3, CrashFree BIOS 3, F6 Qfan Control, F3 My Favorites, Last Modified log, F12 PrintScreen, F9 Search, and ASUS DRAM SPD (Serial Presence Detect) memory information |
| Manageability | WOL by PME, PXE |
| Support DVD | Drivers ASUS utilities ASUS EZ Update Anti-virus software (OEM version) |
| Operating system support | Windows® 10 (64-bit) |
| Form factor | mATX form factor: 9.6 in. x 7.35 in. (24.4 cm x 18.7 cm) |



Specifications are subject to change without notice.

1**ATX power connectors (24-pin EATXPWR, 8-pin EATX12V)**

These connectors are for ATX power supply plugs. The power supply plugs are designed to fit these connectors in only one orientation. Find the proper orientation and push down firmly until the connectors completely fit.



- We recommend that you use an ATX 12V Specification 2.0-compliant power supply unit (PSU) with a minimum of 350W power rating. This PSU type has 24-pin and 8-pin power plugs.
- DO NOT forget to connect the 8-pin EATX +12V power plug. Otherwise, the system will not boot up.
- We recommend that you use a PSU with higher power output when configuring a system with more power-consuming devices or when you intend to install additional devices. The system may become unstable or may not boot up if the power is inadequate.
- If you are uncertain about the minimum power supply requirement for your system, refer to the Recommended Power Supply Wattage Calculator at <http://support.asus.com.cn/PowerSupply.aspx?SLanguage=en> for details.

2**CPU and chassis fan connectors (4-pin CPU_FAN, 4-pin CHA_FAN)**

Connect the fan cables to the fan connectors on the motherboard, ensuring that the black wire of each cable matches the ground pin of the connector.



Do not forget to connect the fan cables to the fan connectors. Insufficient air flow inside the system may damage the motherboard components. These are not jumpers! Do not place jumper caps on the fan connectors! The CPU_FAN connector supports a CPU fan of maximum 1A (12 W) fan power.

3**Intel® LGA1151 CPU socket**

Install Intel® LGA1151 CPU into this surface mount LGA1151 socket, which is designed for the 8th Generation Intel® Core™ i7 / i5 / i3, Pentium®, and Celeron® processors.



For more details, refer to **Central Processing Unit (CPU)**.

4**M.2 socket 3**

This socket allows you to install M.2 (NGFF) SSD modules.

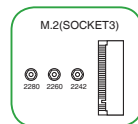

- This socket supports M Key and type 2242/ 2260/ 2280 storage devices.
- When a device in SATA mode is installed on the M.2 socket, SATA_2 port cannot be used.

5

DDR4 DIMM slots

Install 2 GB, 4 GB, 8 GB, and 16 GB unbuffered non-ECC DDR4 DIMMs into these DIMM sockets.



For more details, refer to **System memory**.

6

USB 3.1 Gen 1 (up to 5Gbps) connector (20-1 pin U31G1_12)

Connect a USB 3.1 Gen 1 module to this connector for additional USB 3.1 Gen 1 front or rear panel ports. This connector complies with USB 3.1 Gen 1 specifications and provide faster data transfer speeds of up to 5 Gbps, faster charging time for USB-chargeable devices, optimized power efficiency, and backward compatibility with USB 2.0.

7

Intel® B360 Serial ATA 6.0Gb/s connectors (7-pin SATA6G_1~6)

These connectors connect to Serial ATA 6.0 Gb/s hard disk drives via Serial ATA 6.0 Gb/s signal cables.

8

Speaker connector (4-pin SPEAKER)

This 4-pin connector is for the chassis-mounted system warning speaker. The speaker allows you to hear system beeps and warnings.

9

System panel connector (10-1 pin F_PANEL)

This connector supports several chassis-mounted functions.

10

Clear RTC RAM (2-pin CLRRTC)

This header allows you to clear the CMOS RTC RAM data of the system setup information such as date, time, and system passwords.

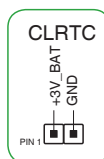

To erase the RTC RAM:

1. Turn OFF the computer and unplug the power cord.
2. Use a metal object such as a screwdriver to short the two pins.
3. Plug the power cord and turn ON the computer.
4. Hold down the key during the boot process and enter BIOS setup to re-enter data.



If the steps above do not help, remove the onboard battery and short the two pins again to clear the CMOS RTC RAM data. After clearing the CMOS, reinstall the battery.

11

USB 2.0 connectors (10-1 pin USB914, USB1011)

These connectors are for USB 2.0 ports. Connect the USB module cable to any of these connector, then install the module to a slot opening at the back of the system chassis. These USB connectors comply with USB 2.0 specifications and supports up to 480Mbps connection speed.

12

Digital audio connector (4-1 pin SPDIF_OUT)

This connector is for an additional Sony/Philips Digital Interface (S/PDIF) port. Connect the S/PDIF Out module cable to this connector, then install the module to a slot opening at the back of the system chassis.

13

Front panel audio connector (10-1 pin AAFP)

This connector is for a chassis-mounted front panel audio I/O module that supports HD Audio audio standard. Connect one end of the front panel audio I/O module cable to this connector.



-
- We recommend that you connect a high-definition front panel audio module to this connector to avail of the motherboard's high-definition audio capability.
 - If you want to connect a high-definition front panel audio module to this connector, set the Front Panel Type item in the BIOS setup to [HD Audio]. By default, this connector is set to [HD Audio].
-

14

PCI slot

The PCI slot supports cards such as LAN card, SCSI card, USB card, and other cards that comply with the PCI specifications.

15

PCI Express 3.0/2.0 x1 slots

This motherboard has two PCI Express 3.0/2.0 x1 slots that support PCI Express 3.0/2.0 x1 network cards, SCSI cards, and other cards that comply with the PCI Express specifications.

16

PCI Express 3.0/2.0 x16 slot

This motherboard has a PCI Express 3.0/2.0 x16 slot that supports PCI Express 3.0/2.0 x16 graphic cards complying with the PCI Express specifications.

Rear panel connectors

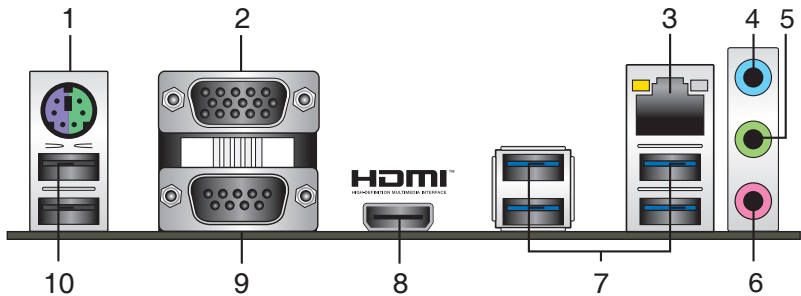

- PS/2 keyboard/mouse combo port.** This port is for a PS/2 mouse or keyboard.
- Video Graphics Adapter (VGA) port.** This 15-pin port is for a VGA monitor or other VGA-compatible devices.
- LAN (RJ-45) port.** This port allows Gigabit connection to a Local Area Network (LAN) through a network hub.

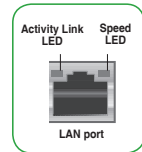

LAN port LED indications

| Activity/Link LED | | Speed LED | |
|-------------------------------|-------------------------------|-----------|--------------------|
| Status | Description | Status | Description |
| Off | No link | OFF | 10Mbps connection |
| Orange | Linked | ORANGE | 100Mbps connection |
| Orange (Blinking) | Data activity | GREEN | 1Gbps connection |
| Orange (Blinking then steady) | Ready to wake up from S5 mode | — | — |

- Line In port (light blue).** This port connects to the tape, CD, DVD player, or other audio sources.
- Line Out port (lime).** This port connects to a headphone or a speaker. In the 4.1, 5.1 and 7.1-channel configurations, the function of this port becomes Front Speaker Out.
- Microphone port (pink).** This port connects to a microphone.



Refer to the audio configuration table for the function of the audio ports in 2.1, 4.1, 5.1, or 7.1-channel configuration.

Audio 2.1, 4.1, 5.1 or 7.1-channel configuration

| Port | Headset 2.1-channel | 4.1-channel | 5.1-channel | 7.1-channel |
|-------------------------|---------------------|-------------------|-------------------|-------------------|
| Light Blue (Rear panel) | Line In | Rear Speaker Out | Rear Speaker Out | Rear Speaker Out |
| Lime (Rear panel) | Line Out | Front Speaker Out | Front Speaker Out | Front Speaker Out |
| Pink (Rear panel) | Mic In | Mic In | Bass/Center | Bass/Center |
| Lime (Front panel) | — | — | — | Side Speaker Out |



To configure a 7.1-channel audio output:

Use a chassis with HD audio module in the front panel to support a 7.1-channel audio output.

- 7. USB 3.1 Gen 1 (up to 5Gbps) ports (blue, Type A).** These 9-pin Universal Serial Bus (USB) ports connect to USB 3.1 Gen 1 devices.



- USB 3.1 Gen 1 devices can only be used for data storage.
- Due to the design of the Intel® 300 series chipset, all USB devices connected to the USB 2.0 and USB 3.1 Gen 1 ports are controlled by the xHCI controller. Some legacy USB devices must update their firmware for better compatibility.
- We strongly recommend that you connect USB 3.1 Gen 1 devices to USB 3.1 Gen 1 ports for faster and better performance from your USB 3.1 Gen 1 devices.

- 8. HDMI port.** This port is for a High-Definition Multimedia Interface (HDMI) connector, and is HDCP compliant allowing playback of HD DVD, Blu-ray, and other protected content.
- 9. Serial port connector (10-1 pin COM).** This port connects a modem, or other devices that conform with serial specification.
- 10. USB 2.0 ports** These 4-pin Universal Serial Bus (USB) ports are for USB 2.0/1.1 devices.

Central Processing Unit (CPU)

This motherboard comes with a surface mount LGA1151 socket designed for the 8th Generation Intel® Core™ i7 / Core™ i5 / Core™ i3, Pentium®, and Celeron® processors.

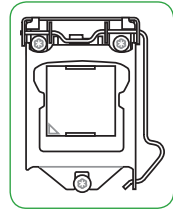

Unplug all power cables before installing the CPU.



- Ensure that you install the correct CPU designed for the LGA1151 socket only. **DO NOT** install a CPU designed for LGA1150, LGA1155 and LGA1156 sockets on the LGA1151 socket.
- Upon purchase of the motherboard, ensure that the PnP cap is on the socket and the socket contacts are not bent. Contact your retailer immediately if the PnP cap is missing, or if you see any damage to the PnP cap/socket contacts/motherboard components.
- Keep the cap after installing the motherboard. ASUS will process Return Merchandise Authorization (RMA) requests only if the motherboard comes with the cap on the LGA1151 socket.
- The product warranty does not cover damage to the socket contacts resulting from incorrect CPU installation/removal, or misplacement/loss/incorrect removal of the PnP cap.

Installing the CPU

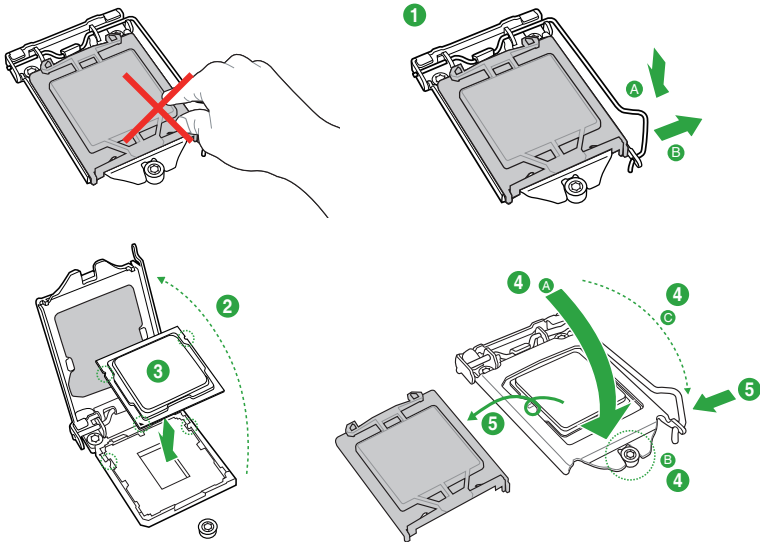

Apply the Thermal Interface Material to the CPU heatsink and CPU before you install the heatsink and fan if necessary.

System memory

This motherboard comes with two Double Data Rate 4 (DDR4) Dual Inline Memory Module (DIMM) sockets. The figure illustrates the location of the DDR4 DIMM sockets:

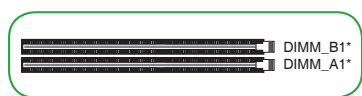

| Channel | Sockets |
|-----------|----------|
| Channel A | DIMM_A1* |
| Channel B | DIMM_B1* |



- You may install varying memory sizes in Channel A and Channel B. The system maps the total size of the lower-sized channel for the dual-channel configuration. Any excess memory from the higher-sized channel is then mapped for single-channel operation.
- Always install DIMMs with the same CAS latency. For optimal compatibility, we recommend that you install memory modules of the same version or date code (D/C) from the same vendor. Check with the retailer to get the correct memory modules.
- DDR4 2666MHz and higher memory modules will run at max. 2666MHz on Intel® 8th Generation 6-core or higher processors.
- Memory modules with memory frequency higher than 2133 MHz and its corresponding timing or the loaded X.M.P. Profile is not the JEDEC memory standard. The stability and compatibility of these memory modules depend on the CPU's capabilities and other installed devices.



- The default memory operation frequency is dependent on its Serial Presence Detect (SPD), which is the standard way of accessing information from a memory module. Under the default state, some memory modules for overclocking may operate at a lower frequency than the vendor-marked value.
- Refer to www.asus.com for the latest Memory QVL (Qualified Vendors List)

Recommended memory configurations

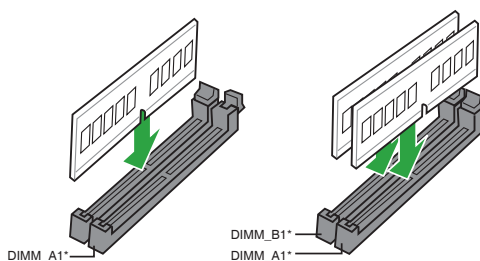

Installing a DIMM

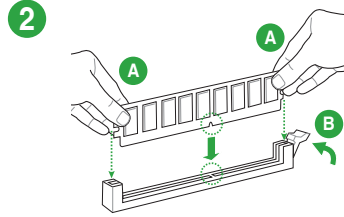
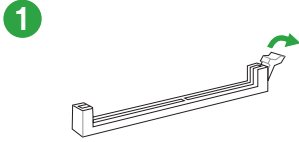

To remove a DIMM

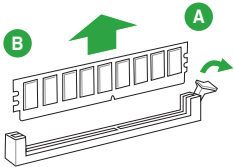

M.2 Anchor Installation

The M.2 Anchor is a tool-less design to easily fasten and secure your M.2 SSD card to your motherboard without using extra tools.

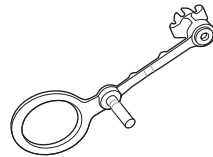

To install the M.2 SSD card using the M.2 Anchor:

1. Locate the M.2 mounting hole on your motherboard and firmly insert the M.2 Anchor into the hole.

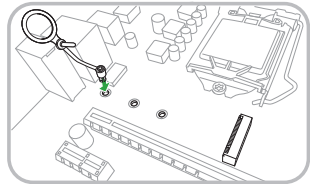

2. Insert the M.2 SSD card into the M.2 slot. The notch at the end of the M.2 SSD card shall align with the rod of the M.2 Anchor.

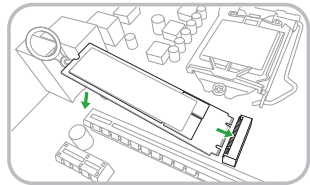

3. Firmly insert the pin on the M.2 Anchor into the hole on itself.

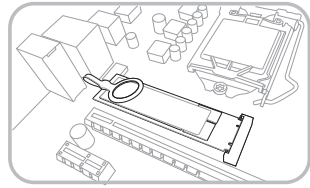
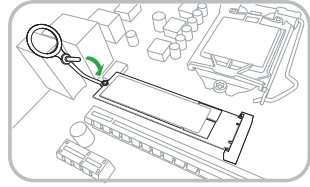

To uninstall the M.2 SSD card:

1. Pull up the ring on the M.2 Anchor until it is separated from the hole.
2. Remove the M.2 SSD card from the M.2 slot.

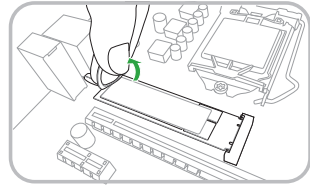

BIOS information

2



- Scan the QR code to view the BIOS update guide.
- Before using the ASUS CrashFree BIOS 3 utility, rename the BIOS file in the removable device into **PB360MD.CAP**.



BIOS setup program

Use the BIOS Setup program to update the BIOS or configure its parameters. The BIOS screens include navigation keys and brief online help to guide you in using the BIOS Setup program.

Entering BIOS Setup at startup

To enter BIOS Setup at startup:

Press <Delete> or <F2> during the Power-On Self Test (POST). If you do not press <Delete> or <F2>, POST continues with its routines.

Entering BIOS Setup after POST

To enter BIOS Setup after POST:

Press <Ctrl>+<Alt>+ simultaneously.

Press the reset button on the system chassis.

Press the power button to turn the system off then back on. Do this option only if you failed to enter BIOS Setup using the first two options.



Using the power button, reset button, or the <Ctrl>+<Alt>+ keys to force reset from a running operating system can cause damage to your data or system. We recommend you always shut down the system properly from the operating system.



- The BIOS setup screens shown in this section are for reference purposes only, and may not exactly match what you see on your screen.
- Visit the ASUS website at www.asus.com to download the latest BIOS file for this motherboard.
- If the system becomes unstable after changing any BIOS setting, load the default settings to ensure system compatibility and stability. Select the **Load Optimized Defaults** item under the Exit menu or press hotkey F5.
- If the system fails to boot after changing any BIOS setting, try to clear the CMOS and reset the motherboard to the default value. See section **Motherboard overview** for information on how to erase the RTC RAM.

BIOS menu screen

The BIOS setup program can be used under two modes: **EZ Mode** and **Advanced Mode**. Press <F7> to change between the two modes.

EZ Mode

By default, the EZ Mode screen appears when you enter the BIOS setup program. The EZ Mode provides you an overview of the basic system information, and allows you to select the display language, system performance mode, fan profile and boot device priority. To access the Advanced Mode, click **Advanced Mode(F7)** or press <F7>.



The default screen for entering the BIOS setup program can be changed. Refer to the **Setup Mode** item under the **Boot** menu for details.

Displays the CPU/motherboard temperature, CPU voltage output, CPU/chassis fan speed, and SATA information

Displays the system properties of the selected mode. Click <Enter> to switch EZ System Tuning modes

Selects the display language of the BIOS setup program

Searches by BIOS item name, enter the item name to find the related item listing

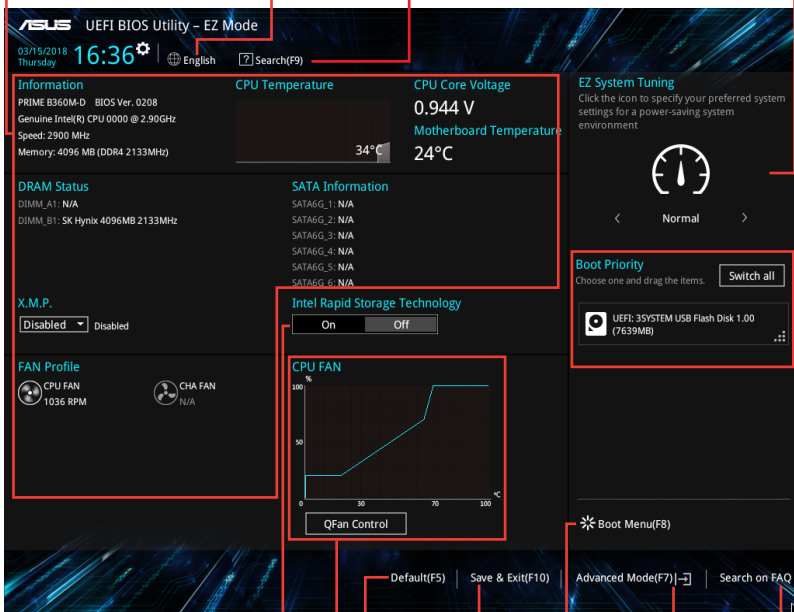

Enables or disables the Intel Rapid Storage Technology

Displays the CPU Fan's speed. Click the button to manually tune the fans

Loads optimized default settings

Saves the changes and resets the system

Shows the bootable devices

Displays the Advanced mode menus

Search on FAQs

Selects the boot device priority



The boot device options vary depending on the devices you installed to the system.

Advanced Mode

The Advanced Mode provides advanced options for experienced end-users to configure the BIOS settings. The figure below shows an example of the **Advanced Mode**. Refer to the following sections for the detailed configurations.



To access the EZ Mode, click **EzMode(F7)** or press <F7>.

The screenshot shows the ASUS UEFI BIOS Utility in Advanced Mode. The interface is dark-themed with blue accents. At the top, there is a menu bar with options: My Favorites, Main, Ai Tweaker, Advanced, Monitor, Boot, Tool, and Exit. The current page is 'Ai Tweaker', which displays various system settings such as Target CPU Turbo-Mode Frequency (4000MHz), Target DRAM Frequency (2133MHz), and Target Cache Frequency (3700MHz). A 'Q-Fan control' section is visible, showing a dropdown menu with options: Auto, Auto, Enabled, Auto, and Auto. A 'Hardware Monitor' panel on the right displays real-time data for CPU (Frequency: 2900 MHz, Temperature: 38°C), Memory (Frequency: 2133 MHz, Capacity: 4096 MB), and Voltage (+12V: +5V, 12.192 V, 5.160 V; +3.3V: 3.376 V). A 'Sub-menu item' is highlighted in the 'Power-saving & Performance Mode' section, showing options like DRAM Timing Control, DIGI+ VRM, and Internal CPU Power Management. A 'Pop-up window' is open, displaying a message: 'Power-saving Mode reduces power usage to a minimum level. Performance mode lets you get the best system performance.' The bottom of the screen shows 'Last Modified', 'EzMode(F7) ->', 'Hot Keys [F7]', and 'Search on FAQ'. The version number 'Version 2.19.1269. Copyright (C) 2018 American Megatrends, Inc.' is also visible.

Labels in the image:

- Menu bar
- Language
- MyFavorite
- Q-Fan control
- Scroll bar
- Search
- Hardware Monitor
- Sub-menu item
- General help
- Last modified settings
- Hot Keys
- Searches FAQ
- Menu items
- Configuration fields
- Goes back to EZ Mode
- Displays hardware monitoring data
- Pop-up window

Search on FAQ

Move your mouse over this button to show a QR code. Scan this QR code with your mobile device to connect to the ASUS BIOS FAQ web page. You can also scan the QR code below.



Exit menu

The Exit menu items allow you to load the optimal default values for the BIOS items, and save or discard your changes to the BIOS items.

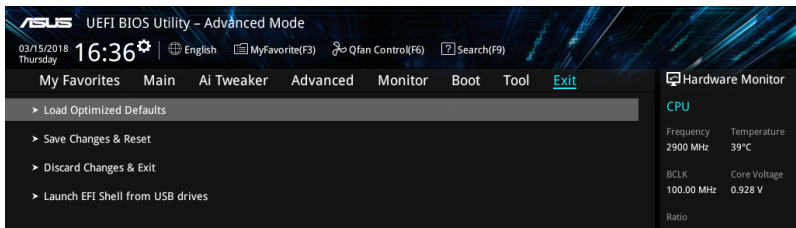

Load Optimized Defaults

This option allows you to load the default values for each of the parameters on the Setup menus. When you select this option or if you press <F5>, a confirmation window appears. Select OK to load the default values.

Save Changes & Reset

Once you are finished making your selections, choose this option from the Exit menu to ensure the values you selected are saved. When you select this option or if you press <F10>, a confirmation window appears. Select OK to save changes and exit.

Discard Changes and Exit

This option allows you to exit the Setup program without saving your changes. When you select this option or if you press <Esc>, a confirmation window appears. Select OK to discard changes and exit.

Launch EFI Shell from USB drives

This option allows you to attempt to launch the EFI Shell application (shellx64.efi) from one of the available USB devices.

Appendix

Notices

Federal Communications Commission Statement

This device complies with Part 15 of the FCC Rules. Operation is subject to the following two conditions:

- This device may not cause harmful interference.
- This device must accept any interference received including interference that may cause undesired operation.

This equipment has been tested and found to comply with the limits for a Class B digital device, pursuant to Part 15 of the FCC Rules. These limits are designed to provide reasonable protection against harmful interference in a residential installation. This equipment generates, uses and can radiate radio frequency energy and, if not installed and used in accordance with manufacturer's instructions, may cause harmful interference to radio communications. However, there is no guarantee that interference will not occur in a particular installation. If this equipment does cause harmful interference to radio or television reception, which can be determined by turning the equipment off and on, the user is encouraged to try to correct the interference by one or more of the following measures:

- Reorient or relocate the receiving antenna.
- Increase the separation between the equipment and receiver.
- Connect the equipment to an outlet on a circuit different from that to which the receiver is connected.
- Consult the dealer or an experienced radio/TV technician for help.



The use of shielded cables for connection of the monitor to the graphics card is required to assure compliance with FCC regulations. Changes or modifications to this unit not expressly approved by the party responsible for compliance could void the user's authority to operate this equipment.

Compliance Statement of Innovation, Science and Economic Development Canada (ISED)

This device complies with Innovation, Science and Economic Development Canada licence exempt RSS standard(s). Operation is subject to the following two conditions: (1) this device may not cause interference, and (2) this device must accept any interference, including interference that may cause undesired operation of the device.

CAN ICES-3(B)/NMB-3(B)

Déclaration de conformité de Innovation, Sciences et Développement économique Canada (ISED)

Le présent appareil est conforme aux CNR d'Innovation, Sciences et Développement économique Canada applicables aux appareils radio exempts de licence. L'exploitation est autorisée aux deux conditions suivantes : (1) l'appareil ne doit pas produire de brouillage, et (2) l'utilisateur de l'appareil doit accepter tout brouillage radioélectrique subi, même si le brouillage est susceptible d'en compromettre le fonctionnement.

CAN ICES-3(B)/NMB-3(B)

VCCI: Japan Compliance Statement

Class B ITE

この装置は、クラスB 情報技術装置です。この装置は、家庭環境で使用することを目的としていますが、この装置がラジオやテレビジョン受信機に近接して使用されると、受信障害を引き起こすことがあります。

取扱説明書に従って正しい取り扱いをして下さい。

V C C I - B

KC: Korea Warning Statement

B급 기기 (가정용 방송통신기자재)

이 기기는 가정용(B급) 전자파적합기기로서 주로 가정에서 사용하는 것을 목적으로 하며, 모든 지역에서 사용할 수 있습니다.

REACH

Complying with the REACH (Registration, Evaluation, Authorisation, and Restriction of Chemicals) regulatory framework, we published the chemical substances in our products at ASUS REACH website at <http://csr.asus.com/english/REACH.htm>.



DO NOT throw the motherboard in municipal waste. This product has been designed to enable proper reuse of parts and recycling. This symbol of the crossed out wheeled bin indicates that the product (electrical and electronic equipment) should not be placed in municipal waste. Check local regulations for disposal of electronic products.



DO NOT throw the mercury-containing button cell battery in municipal waste. This symbol of the crossed out wheeled bin indicates that the battery should not be placed in municipal waste.

ASUS Recycling/Takeback Services

ASUS recycling and takeback programs come from our commitment to the highest standards for protecting our environment. We believe in providing solutions for you to be able to responsibly recycle our products, batteries, other components as well as the packaging materials. Please go to <http://csr.asus.com/english/Takeback.htm> for detailed recycling information in different regions.

Regional notice for California



WARNING

Cancer and Reproductive Harm -
www.P65Warnings.ca.gov

Google™ License Terms

Copyright© 2018 Google Inc. All Rights Reserved.

Licensed under the Apache License, Version 2.0 (the “License”); you may not use this file except in compliance with the License. You may obtain a copy of the License at:

<http://www.apache.org/licenses/LICENSE-2.0>

Unless required by applicable law or agreed to in writing, software distributed under the License is distributed on an “AS IS” BASIS, WITHOUT WARRANTIES OR CONDITIONS OF ANY KIND, either express or implied.

See the License for the specific language governing permissions and limitations under the License.

English ASUSTeK Computer Inc. hereby declares that this device is in compliance with the essential requirements and other relevant provisions of related Directives. Full text of EU declaration of conformity is available at: www.asus.com/support

Français ASUSTeK Computer Inc. déclare par la présente que cet appareil est conforme aux critères essentiels et autres clauses pertinentes des directives concernées. La déclaration de conformité de l'UE peut être téléchargée à partir du site Internet suivant : www.asus.com/support

Deutsch ASUSTeK Computer Inc. erklärt hiermit, dass dieses Gerät mit den wesentlichen Anforderungen und anderen relevanten Bestimmungen der zugehörigen Richtlinien übereinstimmt. Der gesamte Text der EU-Konformitätserklärung ist verfügbar unter: www.asus.com/support

Italiano ASUSTeK Computer Inc. con la presente dichiara che questo dispositivo è conforme ai requisiti essenziali e alle altre disposizioni pertinenti con le direttive correlate. Il testo completo della dichiarazione di conformità UE è disponibile all'indirizzo: www.asus.com/support

Русский Компания ASUS заявляет, что это устройство соответствует основным требованиям и другим соответствующим условиям соответствующих директив. Подробную информацию, пожалуйста, смотрите на www.asus.com/support

Български С настоящото ASUSTeK Computer Inc. декларира, че това устройство е в съответствие със съществените изисквания и другите приложими постановления на свързаните директиви. Пълният текст на декларацията за съответствие на ЕС е достъпна на адрес: www.asus.com/support

Hrvatski ASUSTeK Computer Inc. ovim izjavljuje da je ovaj uređaj skladan s bitnim zahtjevima i ostalim odgovarajućim odredbama vezanih direktiva. Cijeli tekst EU izjave o skladnosti dostupan je na: www.asus.com/support

Čeština Společnost ASUSTeK Computer Inc. tímto prohlašuje, že toto zařízení splňuje základní požadavky a další příslušná ustanovení souvisejících směrnic. Plné znění prohlášení o shodě EU je k dispozici na adrese: www.asus.com/support

Dansk ASUSTeK Computer Inc. erklærer hermed, at denne enhed er i overensstemmelse med hovedkravene og andre relevante bestemmelser i de relaterede direktiver. Hele EU-overensstemmelseserklæringen kan findes på: www.asus.com/support

Nederlands ASUSTeK Computer Inc. verklaart hierbij dat dit apparaat voldoet aan de essentiële vereisten en andere relevante bepalingen van de verwante richtlijnen. De volledige tekst van de EU-verklaring van conformiteit is beschikbaar op: www.asus.com/support

Eesti Käesolevaga kinnitab ASUSTeK Computer Inc. et see seade vastab asjakohaste direktiivide oluliste nõuetele ja teistele asjassepuutuvatele sätetele. EL vastavusdeklaratsiooni täielik tekst on saadaval järgmisel aadressil: www.asus.com/support

Suomi ASUSTeK Computer Inc. ilmoittaa täten, että tämä laite on asiaankuuluvien direktiivien olennaisien vaatimusten ja muiden tätä koskevien säädösten mukainen. EU-yhdenmukaisuusilmoituksen koko teksti on luettavissa osoitteessa: www.asus.com/support

Ελληνικά Με το παρόν, η ASUSTeK Computer Inc. δηλώνει ότι αυτή η συσκευή συμμορφώνεται με τις θεμελιώδεις απαιτήσεις και άλλες σχετικές διατάξεις των Οδηγίων της ΕΕ. Το πλήρες κείμενο της δήλωσης συμμόρφωσης είναι διαθέσιμο στη διεύθυνση: www.asus.com/support

Magyar Az ASUSTeK Computer Inc. ezennel kijelenti, hogy ez az eszköz megfelel a kapcsolódó irányelvek lényeges követelményeinek és egyéb vonatkozó rendelkezésének. Az EU-megfelelőségi nyilatkozat teljes szövege innen letölthető: www.asus.com/support

Latviski ASUSTeK Computer Inc. ar šo paziņo, ka šī ierīce atbilst saistošo Direktīvu būtiskajām prasībām un citiem citiem saistošajiem nosacījumiem. Pils ES atbilstības paziņojuma teksts pieejams šeit: www.asus.com/support

Lietuvių „ASUSTeK Computer Inc.“ šiuo tvirtina, kad šis įrenginys atitinka pagrindinius reikalavimus ir kitas svarbias susijusių direktyvų nuostatas. Visa ES atitikties deklaracijos tekstą galima rasti: www.asus.com/support

Norsk ASUSTeK Computer Inc. erklærer herved at denne enheten er i samsvar med hovedsaklige krav og andre relevante forskrifter i relaterte direktiver. Fullstendig tekst for EU-samsvarserklæringen finnes på: www.asus.com/support

Polski Firma ASUSTeK Computer Inc. niniejszym oświadcza, że urządzenie to jest zgodne z zasadniczymi wymogami i innymi właściwymi postanowieniami powiązanych dyrektyw. Pełny tekst deklaracji zgodności UE jest dostępny pod adresem: www.asus.com/support

Português A ASUSTeK Computer Inc. declara que este dispositivo está em conformidade com os requisitos essenciais e outras disposições relevantes das Diretivas relacionadas. Texto integral da declaração da UE disponível em: www.asus.com/support

Română ASUSTeK Computer Inc. declară că acest dispozitiv se conformează cerințelor esențiale și altor prevederi relevante ale directivelor conexe. Textul complet al declarației de conformitate a Uniunii Europene se găsește la: www.asus.com/support

Srpski ASUSTeK Computer Inc. ovim izjavljuje da je ovaj uređaj u saglasnosti sa osnovnim zahtevima i drugim relevantnim odredbama povezanih direktiva. Pun tekst EU deklaracije o usaglašenosti je dostupan da adresi: www.asus.com/support

Slovensky Spoločnosť ASUSTeK Computer Inc. týmto vyhlasuje, že toto zariadenie vyhovie základným požiadavkám a ostatným príslušným ustanoveniam príslušných smerníc. Celý text vyhlásenia o zhode pre štáty EÚ je dostupný na adrese: www.asus.com/support

Slovenščina ASUSTeK Computer Inc. izjavlja, da je ta naprava skladna z bistvenimi zahtevami in drugimi ustreznimi določbami povezanih direktiv. Celotno besedilo EU-izjave o skladnosti je na voljo na spletnem mestu: www.asus.com/support

Español Por la presente, ASUSTeK Computer Inc. declara que este dispositivo cumple los requisitos básicos y otras disposiciones pertinentes de las directivas relacionadas. El texto completo de la declaración de la UE de conformidad está disponible en: www.asus.com/support

Svenska ASUSTeK Computer Inc. förklarar härmed att denna enhet överensstämmer med de grundläggande kraven och andra relevanta föreskrifter i relaterade direktiv. Fulltext av EU-försäkran om överensstämmelse finns på: www.asus.com/support

Українська ASUSTeK Computer Inc. заявляє, що цей пристрій відповідає основним вимогам та іншим відповідним положенням відповідних Директив. Повний текст декларації відповідності стандартам ЄС доступний на: www.asus.com/support

Türkçe ASUSTeK Computer Inc., bu aygıtın temel gereksinimlerle ve ilişkili Yönergelere diğer ilgili koşullarla uyumlu olduğunu beyan eder. AB uygunluk bildirimini tam metnini şu adreste bulabilirsiniz: www.asus.com/support

Bosanski ASUSTeK Computer Inc. ovim izjavljuje da je ovaj uređaj uskladen sa bitnim zahtjevima i ostalim odgovarajućim odredbama vezanih direktiva. Cijeli tekst EU izjave o skladnosti dostupan je na: www.asus.com/support

ASUS contact information

ASUSTeK COMPUTER INC.

Address 4F, No. 150, Li-Te Road, Peitou, Taipei 112, Taiwan
Telephone +886-2-2894-3447
Fax +886-2-2890-7798
Web site www.asus.com

Technical Support

Telephone +86-21-38429911
Fax +86-21-5866-8722, ext. 9101#
Online support <http://qr.asus.com/techserv>

ASUS COMPUTER INTERNATIONAL (America)

Address 800 Corporate Way, Fremont, CA 94539, USA
Telephone +1-510-739-3777
Fax +1-510-608-4555
Web site <http://www.asus.com/us/>

Technical Support

Support fax +1-812-284-0883
Telephone +1-812-282-2787
Online support <http://qr.asus.com/techserv>

ASUS COMPUTER GmbH (Germany and Austria)

Address Harkort Str. 21-23, 40880 Ratingen, Germany
Fax +49-2102-959931
Web site <http://www.asus.com/de>
Online contact <http://eu-rma.asus.com/sales>

Technical Support

Telephone +49-2102-5789555
Support Fax +49-2102-959911
Online support <http://qr.asus.com/techserv>

FCC COMPLIANCE INFORMATION

Per FCC Part 2 Section 2.1077



Responsible Party: **Asus Computer International**

Address: **800 Corporate Way, Fremont, CA 94539.**

Phone/Fax No: **(510)739-3777/(510)608-4555**

hereby declares that the product

Product Name : **Motherboard**

Model Number : **PRIME B360M-D**

compliance statement:

This device complies with part 15 of the FCC Rules. Operation is subject to the following two conditions: (1) This device may not cause harmful interference, and (2) this device must accept any interference received, including interference that may cause undesired operation.

Ver. 180125