

DIR-1360 | AC1300 Smart Mesh Wi-Fi Router
DIR-1760 | AC1750 Smart Mesh Wi-Fi Router
DIR-1960 | AC1900 Smart Mesh Wi-Fi Router
DIR-2660 | AC2600 Smart Mesh Wi-Fi Router
DIR-3060 | AC3000 Smart Mesh Wi-Fi Router

User Manual

Preface

D-Link reserves the right to revise this publication and to make changes in the content hereof without obligation to notify any person or organization of such revisions or changes.

Manual Revisions

Hardware	Revision	Date	Description
A1	v1.00	2019/08/16	Initial release for EU Region

Trademarks

D-Link and the D-Link logo are trademarks or registered trademarks of D-Link Corporation or its subsidiaries in the United States or other countries. All other company or product names mentioned herein are trademarks or registered trademarks of their respective companies.

Apple®, Apple logo®, Safari®, iPhone®, and Macintosh® are trademarks of Apple Inc., registered in the U.S. and other countries. App StoreSM is a service mark of Apple Inc.

Chrome™ browser, Google Play™ and Android™ are trademarks of Google Inc.

Internet Explorer®, Windows® and the Windows logo are trademarks of the Microsoft group of companies.

Copyright © 2017 by D-Link Corporation, Inc.

All rights reserved. This publication may not be reproduced, in whole or in part, without prior expressed written permission from D-Link Corporation, Inc.

ErP Power Usage

This device is an Energy Related Product (ErP) with High Network Availability (HiNA), and automatically switches to a power-saving Network Standby mode within 1 minute of no packets being transmitted. It can also be turned off through a power switch to save energy when it is not needed.

DIR-1360	Network Standby: 3.55 watts Switched Off: 0.10 watts
DIR-1760	Network Standby: 5.26 watts Switched Off: 0.06 watts
DIR-1960	Network Standby: 5.35 watts Switched Off: 0.06 watts
DIR-2660	Network Standby: 5.58 watts Switched Off: 0.08 watts
DIR-3060	Network Standby: 5.90 watts Switched Off: 0.07 watts

Table of Contents

Product Overview	1	Installation	20
Package Contents.....	1	Before you Begin.....	20
System Requirements.....	2	Wireless Installation Considerations.....	21
Features.....	3	Setup.....	22
Hardware Overview.....	4	D-Link Wi-Fi App Setup.....	23
Hardware Overview - DIR-1360.....	5	Hardware Setup.....	27
LED Indicators.....	5	Setup Wizard.....	29
Back Panel.....	6	Configuration	36
Front Panel.....	7	Home.....	37
Hardware Overview - DIR-1760.....	8	Internet.....	38
LED Indicators.....	8	EXO Series Router.....	39
Back Panel.....	9	Connected Clients.....	40
Front Panel.....	10	Extenders.....	41
Hardware Overview - DIR-1960.....	11	Mesh Network.....	43
LED Indicators.....	11	USB Device.....	44
Back Panel.....	12	Settings.....	45
Front Panel.....	13	Wizard.....	45
Hardware Overview - DIR-2660.....	14	Internet - IPv4.....	46
LED Indicators.....	14	IPv4 - Dynamic IP (DHCP).....	47
Back Panel.....	15	IPv4 - Static IP.....	48
Front Panel.....	16	IPv4 - PPPoE.....	49
Hardware Overview - DIR-3060.....	17	IPv4 - PPTP.....	51
LED Indicators.....	17	IPv4 - L2TP.....	53
Back Panel.....	18	IPv4 - DS-Lite.....	55
Front Panel.....	19	Internet - IPv6.....	56

IPv6 - Auto Detection	57	User	106
IPv6 - Static IPv6	59	Upgrade	108
IPv6 - Auto Configuration (SLAAC/DHCPv6).....	61	Statistics	109
IPv6 - PPPoE	64	Statistics - Extender.....	110
IPv6 - 6rd	68	Third Party Services.....	111
IPv6 - Local Connectivity Only	70	Registering a D-Link Cloud Service Account	112
Internet - VLAN	71	Voice Assistants	115
Wireless	73	Amazon Alexa Setup	116
Guest Zone	78	Amazon Alexa Voice Commands	120
Network.....	80	The Google Assistant Setup.....	121
USB Sharing	82	The Google Assistant Voice Commands.....	124
D-Link Cloud.....	84	D-Link defend	125
Features.....	85	D-Link defend Setup.....	126
QoS Engine.....	85	D-Link defend and Amazon Alexa Setup	130
Firewall Settings - Advanced	87	D-Link defend and Amazon Alexa Voice	
Firewall Settings - IPv4/IPv6 Rules.....	89	Commands.....	134
Port Forwarding	91	D-Link defend Features	135
Port Forwarding - Virtual Server.....	93	D-Link defend Tutorials	136
Static Route - IPv4.....	95	Wi-Fi Mesh Setup	137
Static Route - IPv6.....	96	Setup Using an Ethernet Cable	138
Dynamic DNS	97	Device Placement Considerations.....	139
Quick VPN	99	Quick VPN.....	142
Management.....	100	Important Information	143
Time & Schedule - Time	100	iOS Devices	144
Time & Schedule - Schedule	101	VPN Setup Instructions.....	144
System Log.....	102	Connect or Disconnect.....	146
System Admin - Admin.....	104	Mac OS X.....	147
System Admin - System.....	105		

VPN Setup Instructions.....	147	Technical Specifications	185
Connect or Disconnect.....	149	DIR-1360	185
Windows 7.....	150	DIR-1760	186
VPN Setup Instructions.....	150	DIR-1960	187
Connect or Disconnect.....	153	DIR-2660	188
Windows 8.1/8.....	154	DIR-3060	189
VPN Setup Instructions.....	154	Regulatory Statements	190
Connect or Disconnect.....	159		
Windows 10.....	160		
VPN Setup Instructions.....	160		
Connect or Disconnect.....	162		
Android	163		
VPN Setup Instructions.....	163		
Connect or Disconnect.....	165		
Connect a Wireless Client to your Router	167		
WPS Button.....	167		
Windows® 10.....	168		
Windows® 8 - WPA/WPA2.....	169		
Windows® 7.....	171		
Troubleshooting	173		
Wireless Basics	177		
Wireless Modes	181		
Networking Basics	182		
Wireless Security	184		

Product Overview

Package Contents

	DIR-1360	DIR-1760	DIR-1960	DIR-2660	DIR-3060
Smart Mesh Wi-Fi Router	V	V	V	V	V
Quick Setup Guide	V	V	V	V	V
Quick Installation Card	V	V	V	V	V
D-Link defend Quick Setup Guide/McAfee LiveSafe Support	V	V	V	V	V
Documentation	V	V	V	V	V
Ethernet Cable (RJ-45)	V	V	V	V	V
Power Adapter	V	V	V	V	V

If any of the above items are missing or damaged, please contact your local reseller.

Note: *Using a power supply with a different voltage rating than the one included with the router will cause damage and void the warranty for this product.*

System Requirements

Network Requirements	<ul style="list-style-type: none"> • An Ethernet-based cable or DSL modem • IEEE 802.11ac/n/g/b/a wireless clients • 10/100/1000 Ethernet
Web-based Configuration Utility Requirements	<p>Computer with the following:</p> <ul style="list-style-type: none"> • Windows®, Macintosh, or Linux-based operating system • An installed Ethernet adapter <p>Browser Requirements:</p> <ul style="list-style-type: none"> • Internet Explorer 10 or higher • Firefox 28 or higher • Safari 6 or higher • Chrome 28 or higher <p>Windows® Users: Make sure you have the latest version of Java installed. Visit www.java.com to download the latest version.</p>
D-Link Wi-Fi App Requirements	<ul style="list-style-type: none"> • iOS® or Android™ device (Please refer to the app's store page to check whether your device is compatible.)
D-Link defend App Requirements	<ul style="list-style-type: none"> • iOS® or Android™ device (Please refer to the app's store page to check whether your device is compatible.)

Features

Handle More with a High-Power Processor

With the EXO Series Routers, you're not only enjoying buffer-free gaming and lightning fast surfing, you're also enjoying features such as an integrated mesh for a higher coverage network, an automatically optimizing QoS with a built-in speedtest, an automatic firmware update system that ensures the best protection and the latest features, and compatibility with voice assistants. All this is possible with the router's 880 Mhz dual-core high-power processor, 128 MB of flash memory and 256 MB of RAM.

Extend and Customize Your High-speed Wireless AC Network

D-Link's Wi-Fi Mesh is a scalable solution that allows you to easily increase the coverage of your home or office wireless AC network. Expand your Wi-Fi coverage by adding compatible D-Link access points. Mix and match suitable D-Link devices according to your budget and preferences to fit any floorplan. Setup is effortless; configuration of multiple access points can be done in minutes.

Security for Your Network with McAfee Protection

Kick security up a notch with McAfee protection for your network. Keep your kids safe online with age-based profiles and the ability to pause the internet when you need to. All this is part of the comprehensive parental controls offered by the McAfee Secure Home Platform. With the McAfee Secure Home Platform you can also take control of your devices and be the first to know and respond to potentially threatening activity on your network, such as devices trying to connect to malicious addresses, or unidentified devices joining your network. When you are away from home you can also deny any new devices from connecting to your network. The McAfee Secure Home Platform works with Amazon Alexa to give you a new way to command and monitor your home network using your voice. You can scan your network, block devices, and get up to speed on your network notifications - all without lifting a finger.

Easy to Set Up and Manage

Sharing your Internet connection doesn't have to be a complicated process; just download the free D-Link Wi-Fi app for your mobile device and follow the onscreen step-by-step instructions to set up your EXO Series Router.

Always Up-to-Date with the Latest Features

The router will automatically check daily for updates to make sure that the device always has the latest features and the most secure firmware, and will install the update silently in the background.

Enhanced Quality of Service Features

The built-in Quality of Service (QoS) engine allows you to prioritize important traffic to ensure that your favorite applications are receiving optimal bandwidth. Also included as part of the QoS feature is the speedtest, which not only allows you to check the current upload and download speed of your Internet connection, but also gives you the option of automatically configuring your router to optimize your traffic according to speedtest results.

Hardware Overview

This section will walk you through the hardware of each of the EXO Series Routers. Please refer to the respective page for your router:

- For the **DIR-1360** refer to **Hardware Overview - DIR-1360** on page **5**
- For the **DIR-1760** refer to **Hardware Overview - DIR-1760** on page **8**
- For the **DIR-1960** refer to **Hardware Overview - DIR-1960** on page **11**
- For the **DIR-2660** refer to **Hardware Overview - DIR-2660** on page **14**
- For the **DIR-3060** refer to **Hardware Overview - DIR-3060** on page **17**

Hardware Overview - DIR-1360

LED Indicators

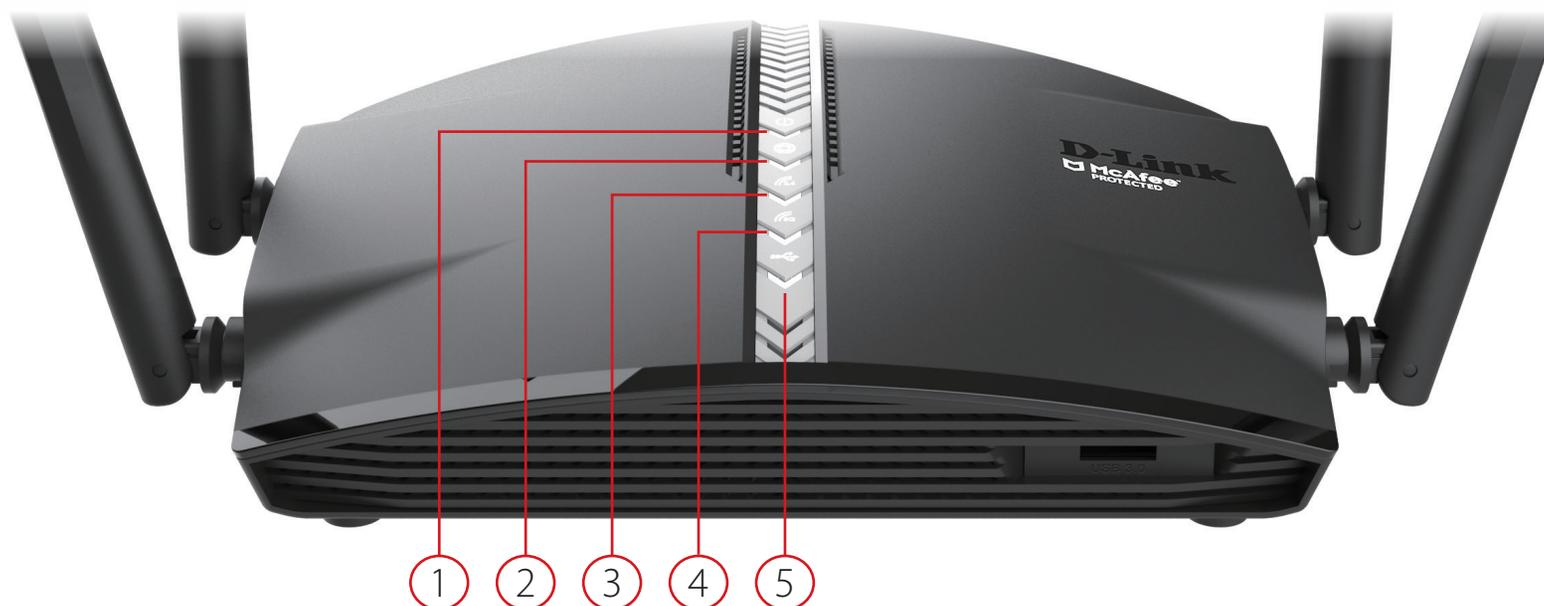

1	Power	Solid White	The device is on and the system is healthy.
		Solid Orange	The device is booting up or performing the factory reset process.
		Blinking Orange	The device is under recovery mode.
2	Internet	Solid White	The Internet port connection is established.
		Solid Orange	The device cannot connect to the Internet.
		Blinking Orange	The device is undergoing the firmware upgrade process.
3	Wireless (2.4 GHz)	White	The 2.4 GHz wireless band is enabled.
		Blinking White	The device is processing WPS.
4	Wireless (5 GHz)	White	The 5 GHz wireless band is enabled.
		Blinking White	The device is processing WPS.
5	Super Speed USB	Solid White	A USB storage device is connected to the USB 3.0 port.

Hardware Overview - DIR-1360 Back Panel

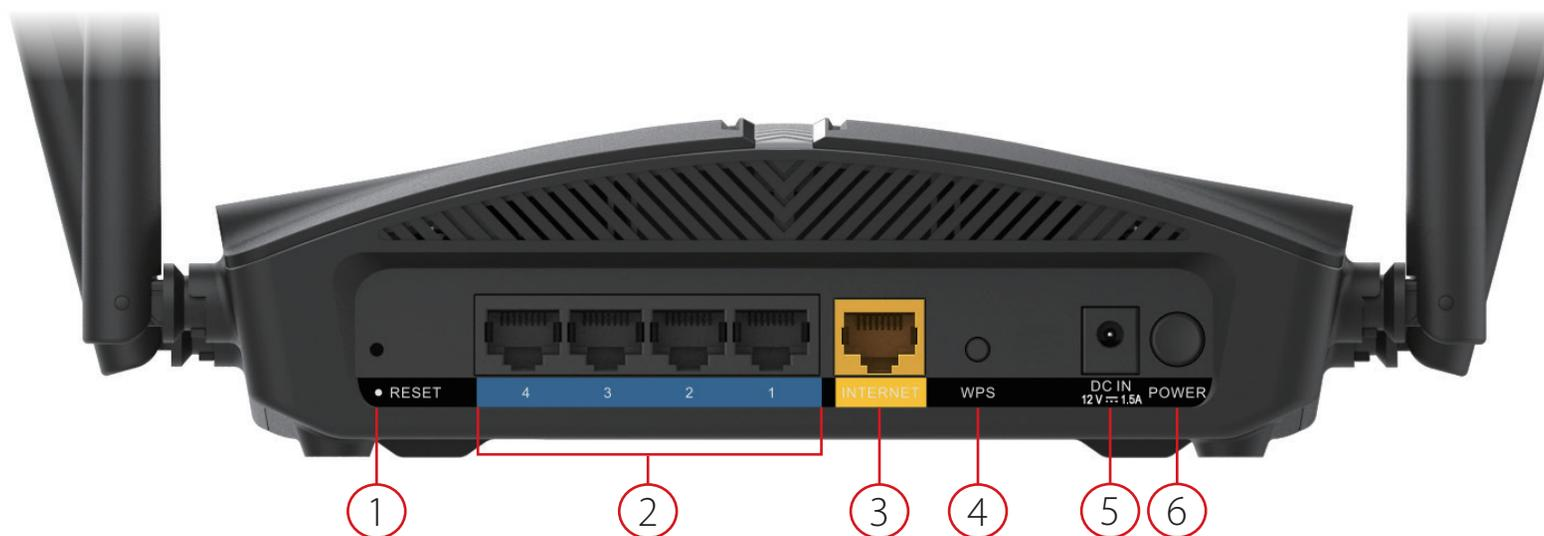

1	Reset Button	Insert a paperclip in the hole, wait for 10 seconds, then release to reset the router to default settings.
2	Gigabit LAN Ports (1- 4)	Connect Ethernet devices such as computers, switches, storage (NAS) devices, and game consoles.
3	Gigabit WAN Port	Using an Ethernet cable, connect your broadband modem to this port.
4	WPS Button	Press to start the WPS process and automatically create an encrypted connection to a WPS client.
5	Power Connector	Connector for the supplied power adapter.
6	Power Button	Press the power button to power the device on or off.

Hardware Overview - DIR-1360 Front Panel



- | | | |
|----------|---------------------|---|
| 1 | USB 3.0 Port | Connect a USB storage device to share files over the network. |
|----------|---------------------|---|

Hardware Overview - DIR-1760

LED Indicators

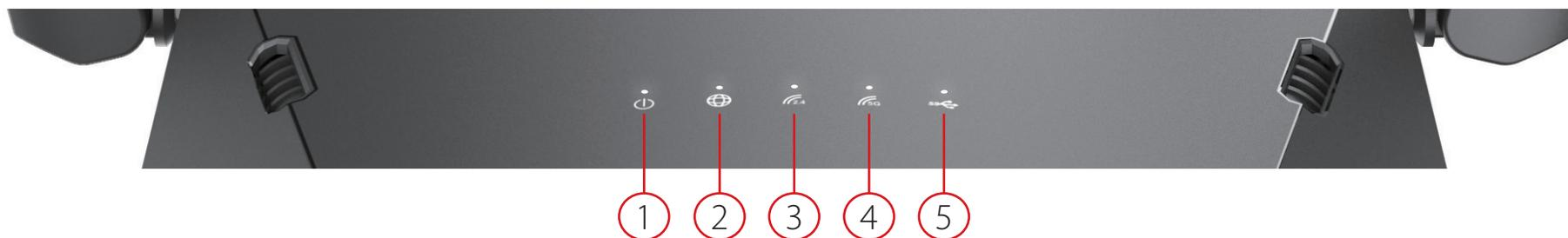

1	Power	Solid White	The device is on and the system is healthy.
		Solid Orange	The device is booting up or performing the factory reset process.
		Blinking Orange	The device is under recovery mode.
2	Internet	Solid White	The Internet port connection is established.
		Solid Orange	The device cannot connect to the Internet.
		Blinking Orange	The device is undergoing the firmware upgrade process.
3	Wireless (2.4 GHz)	White	The 2.4 GHz wireless band is enabled.
		Blinking White	The device is processing WPS.
4	Wireless (5 GHz)	White	The 5 GHz wireless band is enabled.
		Blinking White	The device is processing WPS.
5	Super Speed USB	Solid White	A USB storage device is connected to the USB 3.0 port.

Hardware Overview - DIR-1760 Back Panel

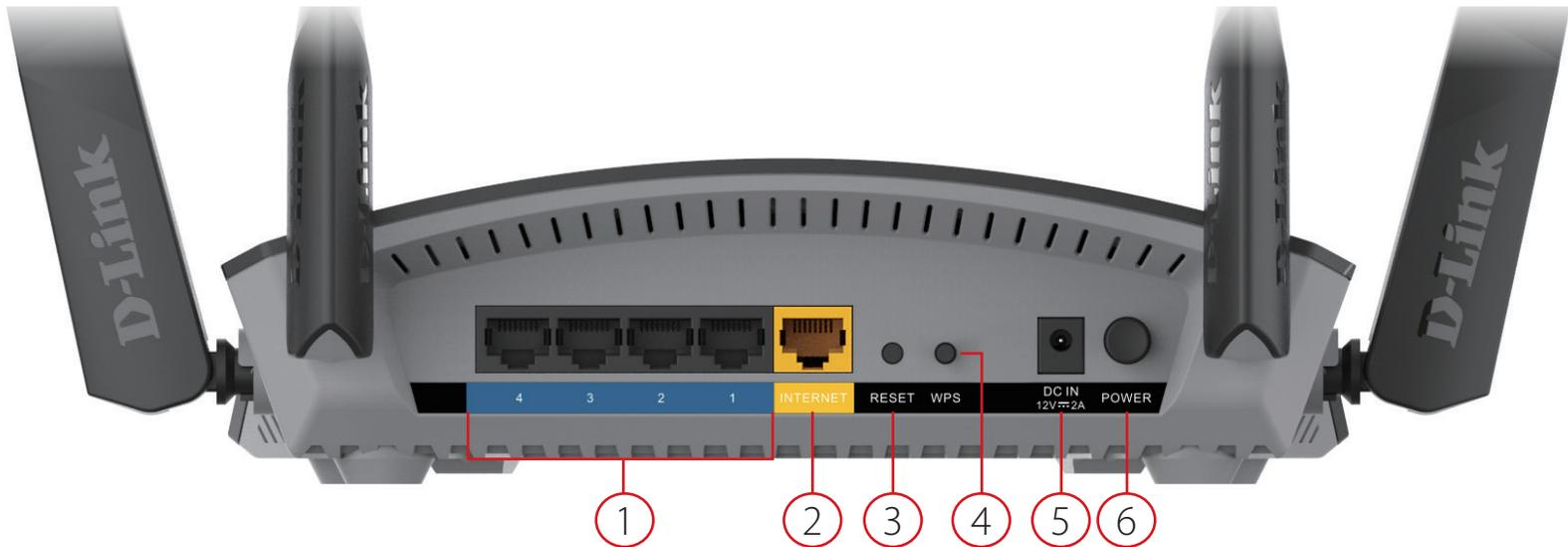

1	Gigabit LAN Ports (1- 4)	Connect Ethernet devices such as computers, switches, storage (NAS) devices, and game consoles.
2	Gigabit WAN Port	Using an Ethernet cable, connect your broadband modem to this port.
3	Reset Button	Insert a paperclip in the hole, wait for 10 seconds, and release to reset the router to default settings.
4	WPS Button	Press to start the WPS process and automatically create an encrypted connection to a WPS client.
5	Power Connector	Connector for the supplied power adapter.
6	Power Button	Press the power button to power the device on or off.

Hardware Overview - DIR-1760 Front Panel



- | | | |
|----------|---------------------|---|
| 1 | USB 3.0 Port | Connect a USB storage device to share files over the network. |
|----------|---------------------|---|

Hardware Overview - DIR-1960

LED Indicators



1	Power	Solid White	The device is on and the system is healthy.
		Solid Orange	The device is booting up or performing the factory reset process.
		Blinking Orange	The device is under recovery mode.
2	Internet	Solid White	The Internet port connection is established.
		Solid Orange	The device cannot connect to the Internet.
		Blinking Orange	The device is undergoing the firmware upgrade process.
3	Wireless (2.4 GHz)	White	The 2.4 GHz wireless band is enabled.
		Blinking White	The device is processing WPS.
4	Wireless (5 GHz)	White	The 5 GHz wireless band is enabled.
		Blinking White	The device is processing WPS.
5	Super Speed USB	Solid White	A USB storage device is connected to the USB 3.0 port.

Hardware Overview - DIR-1960 Back Panel

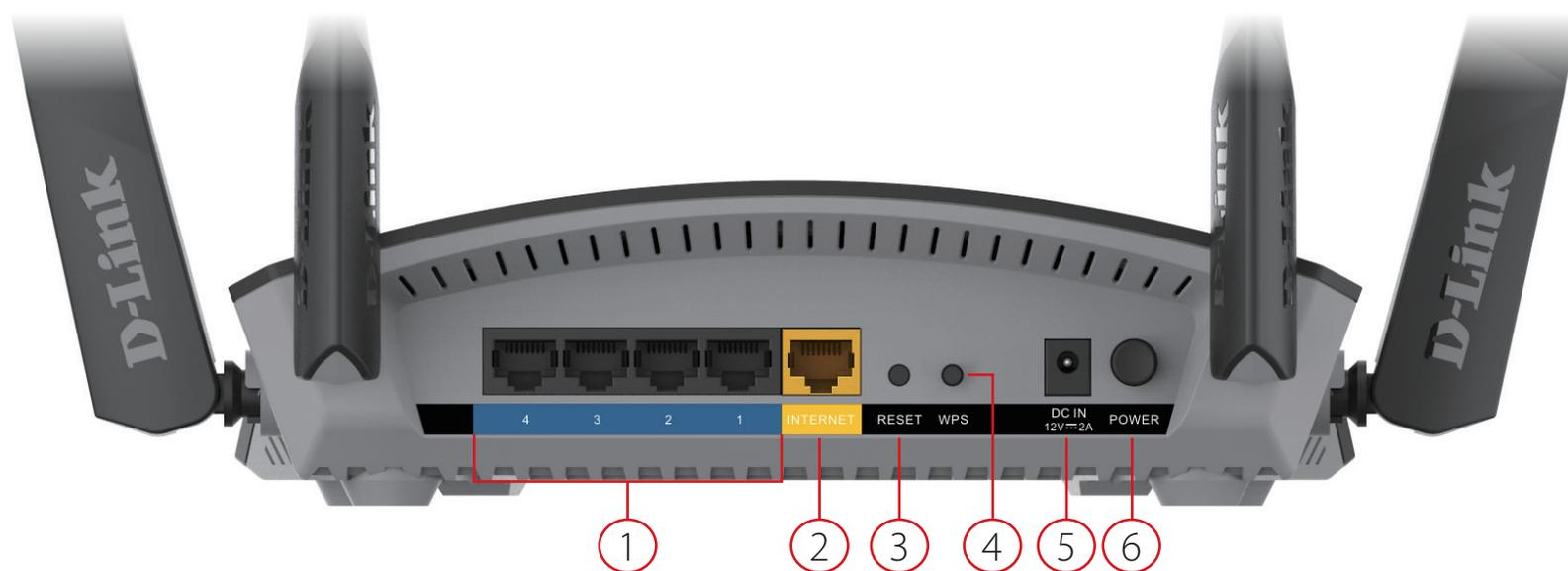

1	Gigabit LAN Ports (1- 4)	Connect Ethernet devices such as computers, switches, storage (NAS) devices, and game consoles.
2	Gigabit WAN Port	Using an Ethernet cable, connect your broadband modem to this port.
3	Reset Button	Insert a paperclip in the hole, wait for 10 seconds, and release to reset the router to default settings.
4	WPS Button	Press to start the WPS process and automatically create an encrypted connection to a WPS client.
5	Power Connector	Connector for the supplied power adapter.
6	Power Button	Press the power button to power the device on or off.

Hardware Overview - DIR-1960 Front Panel



- | | | |
|----------|---------------------|---|
| 1 | USB 3.0 Port | Connect a USB storage device to share files over the network. |
|----------|---------------------|---|

Hardware Overview - DIR-2660

LED Indicators

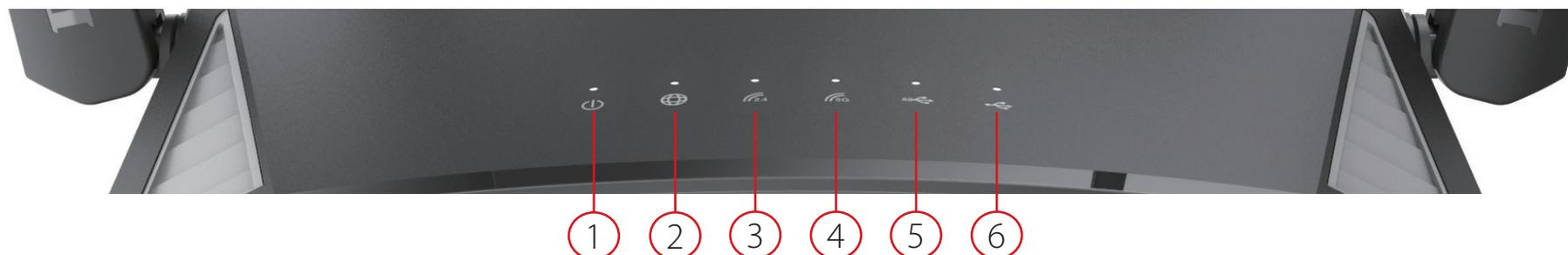

1	Power	Solid White	The device is on and the system is healthy.
		Solid Orange	The device is booting up or performing the factory reset process.
		Blinking Orange	The device is under recovery mode.
2	Internet	Solid White	The Internet port connection is established.
		Solid Orange	The device cannot connect to the Internet.
		Blinking Orange	The device is undergoing the firmware upgrade process.
3	Wireless (2.4 GHz)	White	The 2.4 GHz wireless band is enabled.
		Blinking White	The device is processing WPS.
4	Wireless (5 GHz)	White	The 5 GHz wireless band is enabled.
		Blinking White	The device is processing WPS.
5	Super Speed USB	Solid White	A USB storage device is connected to the USB 3.0 port.
6	USB	Solid White	A USB storage device is connected to the USB 2.0 port.

Hardware Overview - DIR-2660 Back Panel

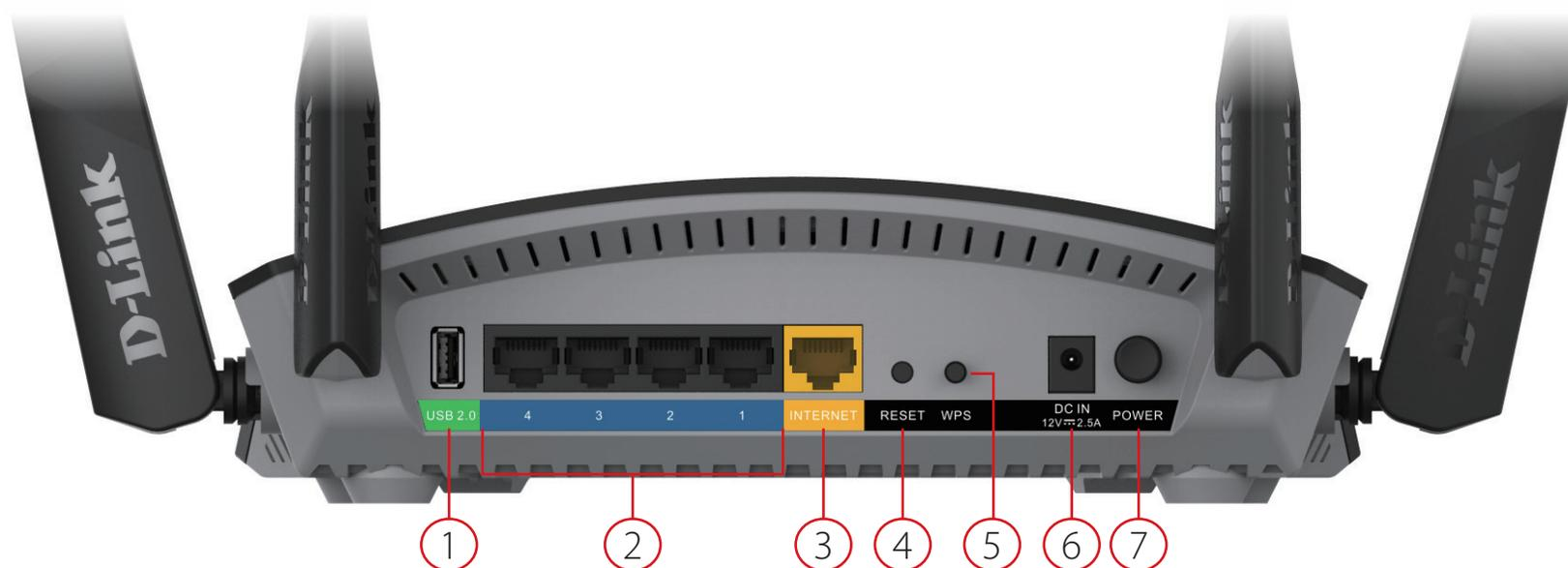

1	USB 2.0 Port	Connect a USB storage device to share files over the network.
2	Gigabit LAN Ports (1- 4)	Connect Ethernet devices such as computers, switches, storage (NAS) devices, and game consoles.
3	Gigabit WAN Port	Using an Ethernet cable, connect your broadband modem to this port.
4	Reset Button	Insert a paperclip in the hole, wait for 10 seconds, and release to reset the router to default settings.
5	WPS Button	Press to start the WPS process and automatically create an encrypted connection to a WPS client.
6	Power Connector	Connector for the supplied power adapter.
7	Power Button	Press the power button to power the device on or off.

Hardware Overview - DIR-2660 Front Panel



1	USB 3.0 Port	Connect a USB storage device to share files over the network.
----------	---------------------	---

Hardware Overview - DIR-3060

LED Indicators

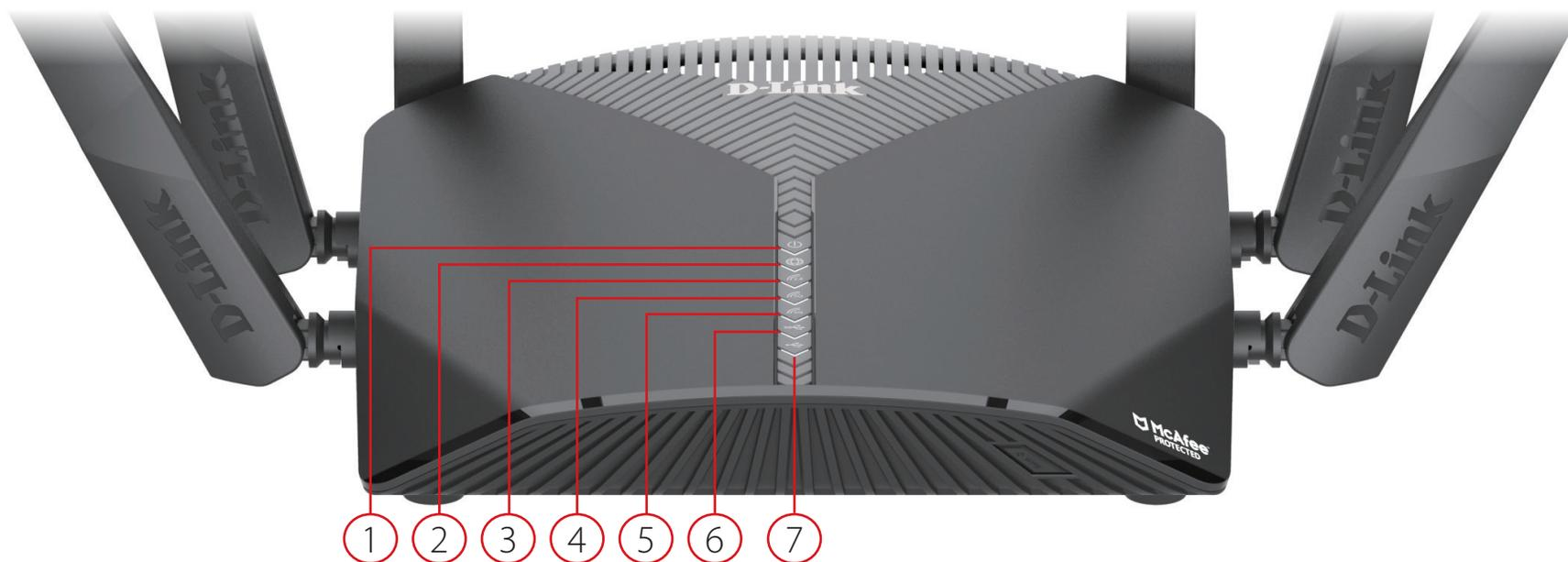

1	Power LED	A solid white light indicates a proper connection to the power supply. The light will be solid orange during boot up or during the factory reset process.
2	Internet LED	A solid white light indicates a connection on the Internet port. If the LED is orange, the router cannot connect to the Internet.
3	Wireless (2.4 GHz LED)	A solid light indicates that the 2.4 GHz wireless band is enabled.
4	Wireless (5 GHz LED)	A solid light indicates that the 5 GHz wireless band is enabled.
5	Wireless (2 nd 5 GHz LED)	A solid light indicates that the 2 nd 5 GHz wireless band is enabled.
6	Super Speed USB LED	A solid white light indicates a USB storage device is connected to the USB 3.0 port at the back of the router.
7	USB LED	A solid white light indicates a USB storage device is connected to the USB 2.0 port at the back of the router.

Hardware Overview - DIR-3060 Back Panel

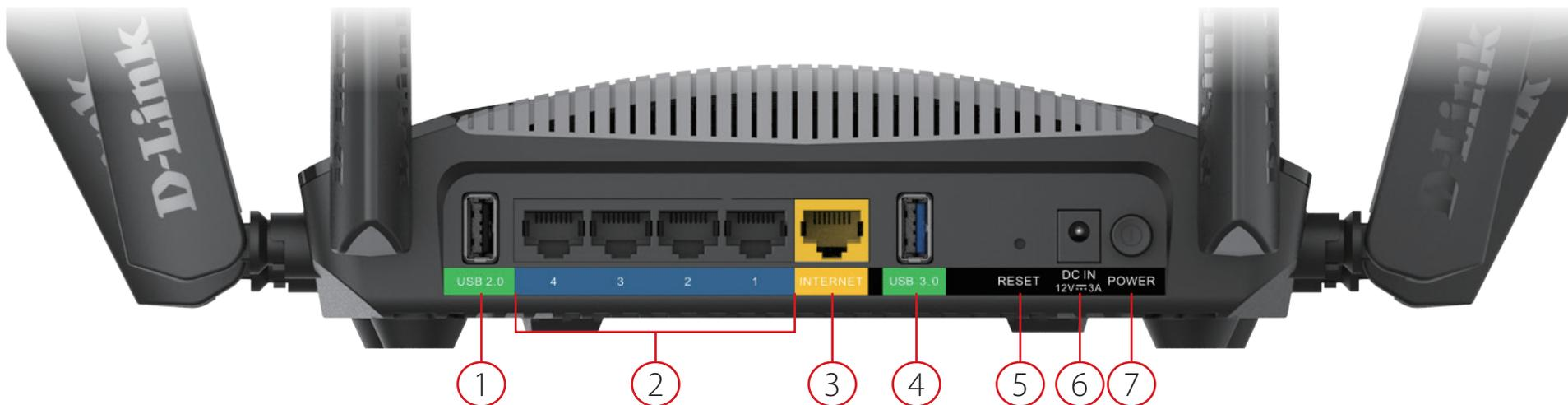

1	USB 2.0 Port	Connect a USB storage device to share files over the network.
2	Gigabit LAN Ports (1- 4)	Connect Ethernet devices such as computers, switches, storage (NAS) devices, and game consoles.
3	Gigabit WAN Port	Using an Ethernet cable, connect your broadband modem to this port.
4	USB 3.0 Port	Connect a USB storage device to share files over the network.
5	Reset Button	Insert a paperclip in the hole, wait for 10 seconds, and release to reset the router to default settings.
6	Power Connector	Connector for the supplied power adapter.
7	Power Button	Press the power button to power the device on or off.

Hardware Overview - DIR-3060 Front Panel



1	WPS Button	Press to start the WPS process and automatically create an encrypted connection to a WPS client.
---	------------	--

Installation

This section will walk you through the installation of your EXO Series Router.

Before you Begin

- Placement of the router is very important. Do not place the router in an enclosed area such as a closet, cabinet, attic, or garage.
- Configure the router with the computer that was last connected directly to your Internet connection. Verify that it is connected to the Internet before connecting additional devices.
- If your ISP provided you with a modem/router combo, you will need to set it to “bridge” mode so the router can work properly. Please contact your ISP or refer to the user manual for your modem/router device.
- You can only use the Ethernet port on your modem. If you were using the USB connection before using the router, then you must turn off your modem, disconnect the USB cable and connect an Ethernet cable to the Internet port on the router, and then turn the modem back on. In some cases, you may need to call your Internet Service Provider (ISP) to change connection types (USB to Ethernet).
- If connecting to a DSL modem, make sure to have your DSL service information provided by your Internet Service Provider handy. This information is likely to include your DSL account's Username and Password. Your ISP may also supply you with additional WAN configuration settings which might be necessary to establish a connection.
- If you are connecting a considerable amount of networking equipment, it may be a good idea to take the time to label each cable or take a picture of your existing setup before making any changes.
- If you have DSL and are connecting via PPPoE, make sure you disable or uninstall any PPPoE software such as WinPoET, BroadJump, or EnterNet 300 from your computer or you will not be able to connect to the Internet.

Wireless Installation Considerations

The D-Link wireless router lets you access your network using a wireless connection from virtually anywhere within the operating range of your wireless network. Keep in mind that the number, thickness and location of walls, ceilings, or other objects that the wireless signals must pass through may limit the range. Typical ranges vary depending on the types of materials and background RF (radio frequency) noise in your home or business. The key to maximizing wireless range is to follow these basic guidelines:

1. Keep the number of walls and ceilings between the D-Link router and other network devices to a minimum - each wall or ceiling can reduce your adapter's range from 3-90 feet (1-30 meters.) Position your devices so that the number of walls or ceilings is minimized.
2. Be aware of the direct line between network devices. A wall that is 1.5 feet thick (0.5 meters), at a 45-degree angle appears to be almost 3 feet (1 meter) thick. At a 2-degree angle it looks over 42 feet (14 meters) thick. Position devices so that the signal will travel straight through a wall or ceiling (instead of at an angle) for better reception.
3. Building materials make a difference. A solid metal door or aluminum studs may have a negative effect on range. Try to position access points, wireless routers, and computers so that the signal passes through drywall or open doorways. Materials and objects such as glass, steel, metal, walls with insulation, water (fish tanks), mirrors, file cabinets, brick, and concrete will degrade your wireless signal.
4. Keep your product away (at least 3-6 feet or 1-2 meters) from electrical devices or appliances that generate RF noise.
5. If you are using 2.4 GHz cordless phones or X-10 (wireless products such as ceiling fans, lights, and home security systems), your wireless connection may degrade dramatically or drop completely. Make sure your 2.4 GHz phone base is as far away from your wireless devices as possible. The base transmits a signal even if the phone is not in use.

Setup

There are several different ways you can configure your router to connect to the Internet and connect to your clients:

- **D-Link Wi-Fi App** - Use your compatible Android or iOS device to install and configure your router. Refer to **D-Link Wi-Fi App Setup** on page **23**.
- **Hardware Setup** - This section explains how to setup your EXO Series Router. Refer to **Hardware Setup** on page **27**.
- **D-Link Setup Wizard** - This wizard will launch when you log into the router by using your PC for the first time. Refer to **Setup Wizard** on page **29**.
- **Manual Setup** - Log in to the router to manually configure your router. Refer to **Configuration** on page **36**

D-Link Wi-Fi App Setup

The D-Link Wi-Fi app allows you to install and configure your EXO Series Router from your compatible Android or iOS device.

Note: *The screenshots may be different depending on your mobile device's OS version. The following steps show the iOS interface of the D-Link Wi-Fi app. If you are using an Android device, the appearance may be different from that of the screenshots, but the process is the same.*

Step 1

Search and install the free **D-Link Wi-Fi** app available on the App Store or on Google Play. You can also scan the QR code on the right, which will take you to the respective D-Link Wi-Fi app store page.



Step 2

Launch the D-Link Wi-Fi app from the home screen of your device.



D-Link Wi-Fi

Step 3

Tap on the **Install New Device** button at the middle of the screen.

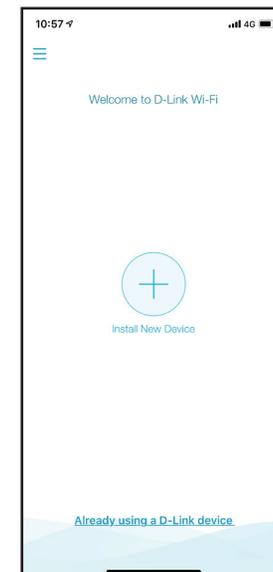

Step 4

Tap **Yes** to scan the setup QR code located in the Quick Install Card and proceed to step 6. Alternatively, you can tap **No** to proceed to step 5.

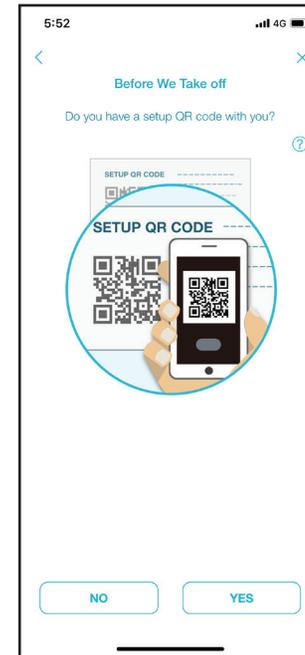

Step 5

Select **Router** and select your EXO Series Router from the list of available devices. Tap **Next** to continue.

- **DIR-1360** | AC1300 Smart Mesh Wi-Fi Router
- **DIR-1760** | AC1750 Smart Mesh Wi-Fi Router
- **DIR-1960** | AC1900 Smart Mesh Wi-Fi Router
- **DIR-2660** | AC2600 Smart Mesh Wi-Fi Router
- **DIR-3060** | AC3000 Smart Mesh Wi-Fi Router

Step 6

You will now be guided through a step-by-step process for setting up your router. Simply follow the on-screen instructions to continue the installation and the configuration process.

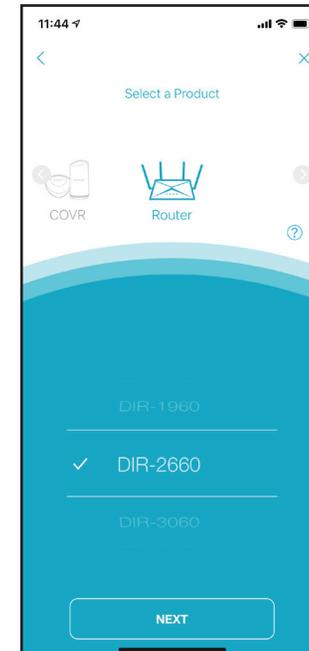

Step 7

Tap **Register** to sign up for a D-Link account in order to utilize available third party services, or tap **Not Now** and proceed to step 9.

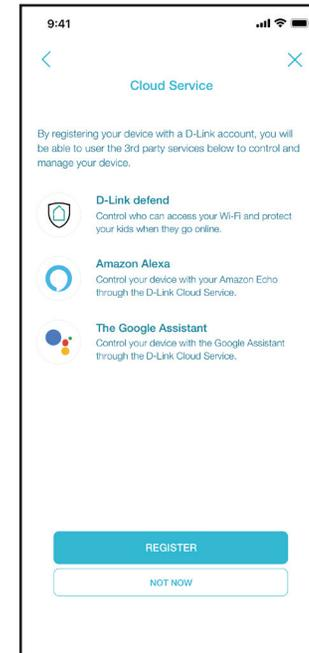

Step 8

Agree to the Terms of Service and Privacy Notice and tap **Keep Protecting Me** to use D-Link defend, or tap **Not Now** to continue.



Step 9

Congratulations! You can now connect to your Wi-Fi network using the Wi-Fi name and password created during the setup. Tap **Finish** to end setup.

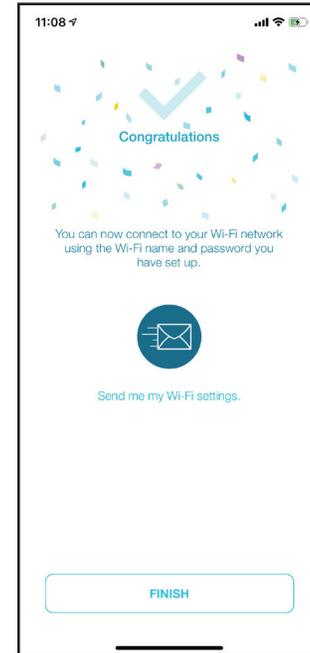

Hardware Setup

Step 1

The EXO Series Routers are designed to give you the fastest, most stable network connection possible. In order to maximize performance, fully extend the antennas into a 105 degree angle to provide optimal wireless coverage. Keep the router in an open area for better wireless coverage.

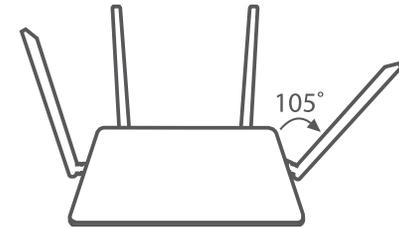

Step 2

Position your EXO Series Router near your Internet-connected modem. Place it in an open area for better wireless coverage.

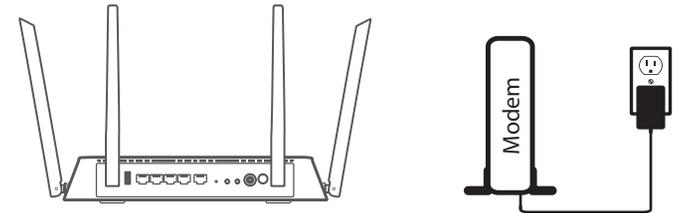

Step 3

Use the included Ethernet cable to connect your modem to the yellow port labelled **INTERNET** on the router.

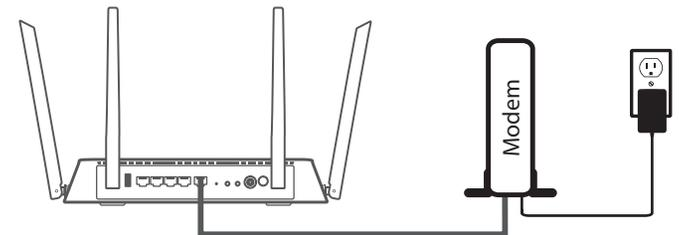

Step 6

Connect the supplied power adapter to the router and a power outlet, press the power button, and wait approximately one minute until the LED indicator on the front of the device changes from orange to solid white.

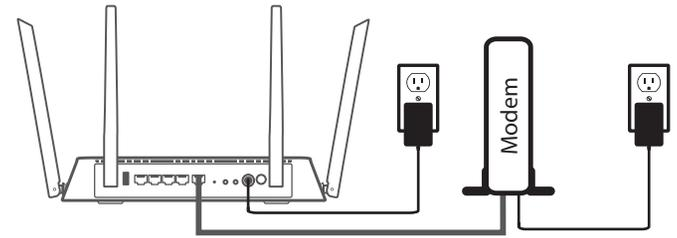

Step 7

If you are configuring the router wirelessly from a PC, connect to the Wi-Fi network printed on the label attached to the bottom of your router or in the Quick Installation Card.

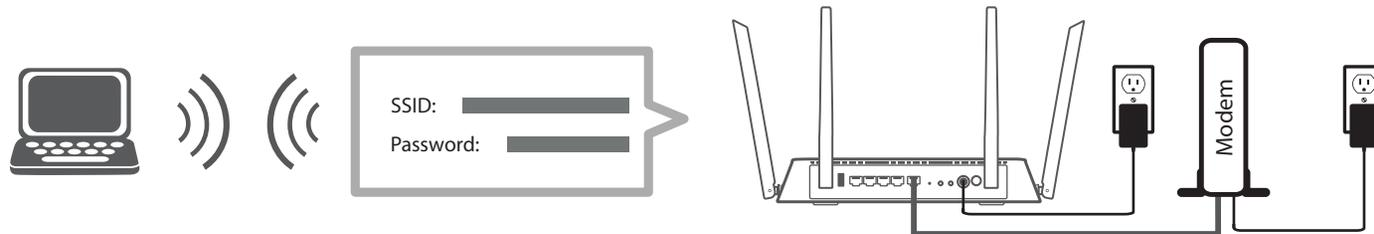

If you are configuring the router from a PC with a wired Ethernet connection, plug one end of an Ethernet cable into the port labeled 1 on the back of the router, and the other end into the Ethernet port on your computer.

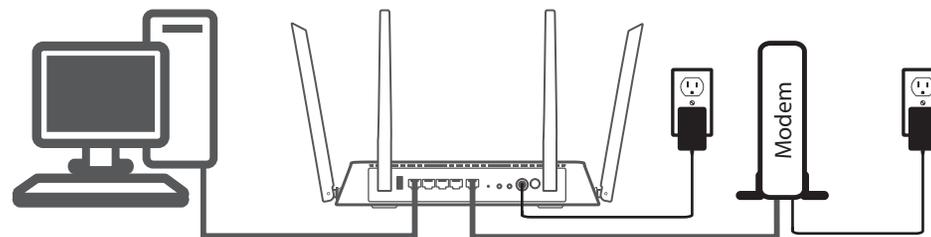

Step 8

If you are connecting to a broadband service that uses a dynamic connection (not PPPoE), you may be online already. Try opening a web browser and connecting to a website. If the website does not load, proceed to **Setup Wizard** on page **29**.

Setup Wizard

The setup wizard is designed to guide you through a step-by-step process to configure your new EXO Series Router and connect to the Internet via a wireless setup process.

If this is your first time installing the router, open your web browser and enter **http://dlinkrouter.local/** in the address bar. Alternatively, enter the IP address of the router (default: **http://192.168.0.1**).

If this is your first time logging in to the and no connection has been established, the setup wizard will automatically appear instead of the log in page. If the setup process was not previously completed, then log in to the interface by leaving the password field blank.

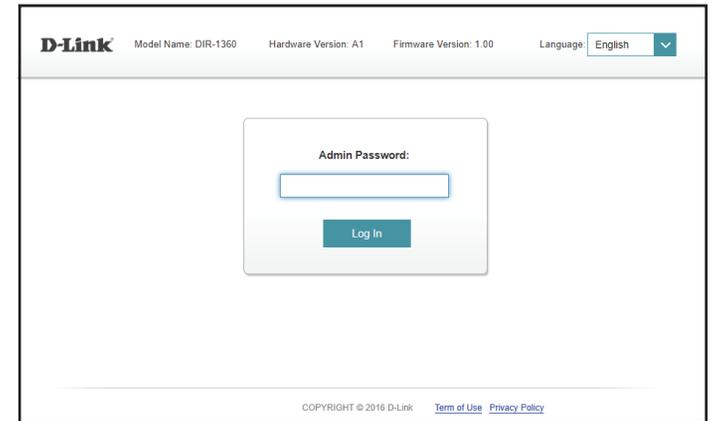
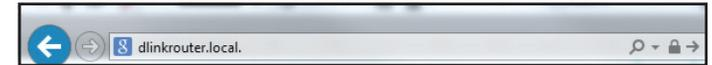

Agree to the Terms of Use and Privacy Policy before proceeding.

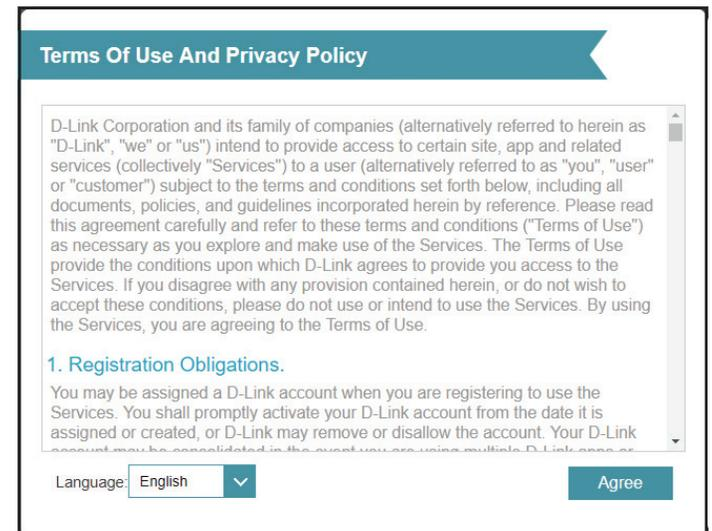

Follow the on-screen instructions to configure your new D-Link router and connect to the Internet.

Click **Next** to continue.

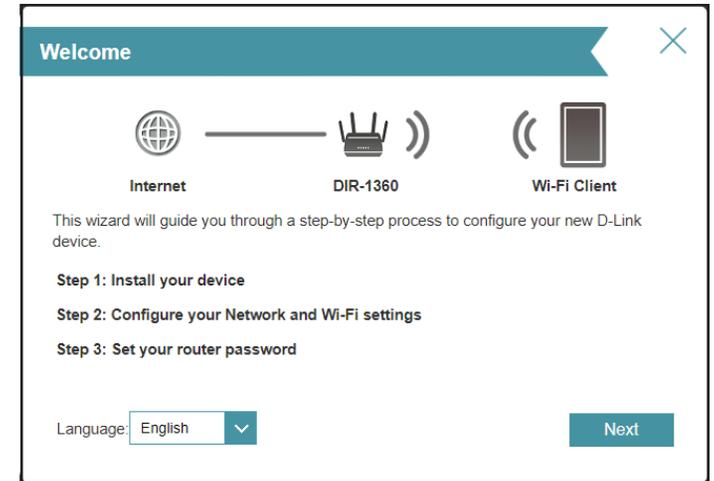

Please wait while your router detects your Internet connection type.

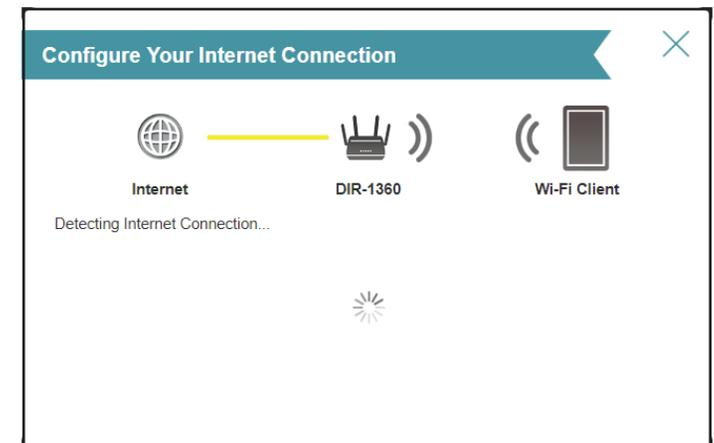

If the router does not detect a valid Internet connection, a list of connection types to choose from will be displayed. Select your Internet connection type (this information can be obtained from your Internet Service Provider).

Click **Next** to continue.

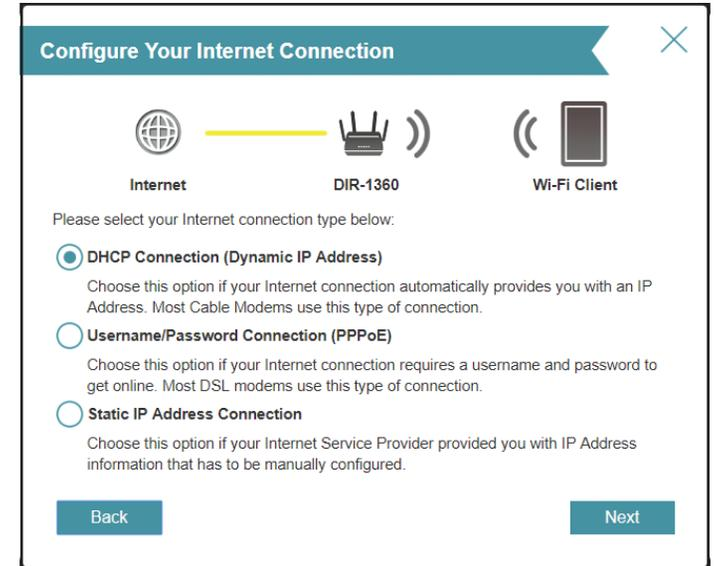

If the router detected or you selected **PPPoE**, enter your PPPoE username and password. If you do not have this information, please contact your ISP.

Click **Next** to continue.

Note: Make sure to remove all other existing PPPoE software from your computer. The software is no longer needed and will not work through a router.

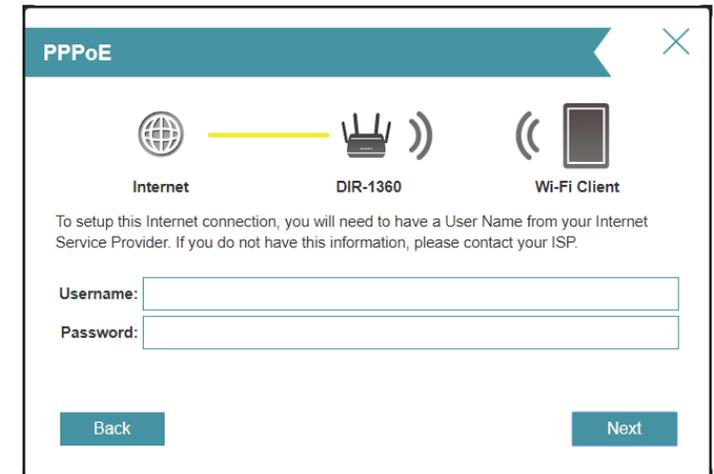

If the router detected or you selected **Static**, enter the IP and DNS settings supplied by your ISP. If you do not have this information, please contact your ISP.

Click **Next** to continue.

Type in a **Wi-Fi Network Name** and **Wi-Fi Password** to setup your Wi-Fi network. Your wireless clients will need to have this passphrase to be able to connect to your wireless network.

Click **Next** to continue.

Note: *The router's Smart Connect feature presents a single wireless network. When connecting clients to an extension network, they will be automatically added to the best band, either 2.4 GHz or 5 GHz. To disable the Smart Connect feature and individually configure 2.4 GHz and 5 GHz networks, refer to **Wireless** on page **73**.*

In order to secure the router's configuration access, please enter a password. You will be prompted for this password every time you want to use the router's web configuration utility.

Click **Next** to continue.

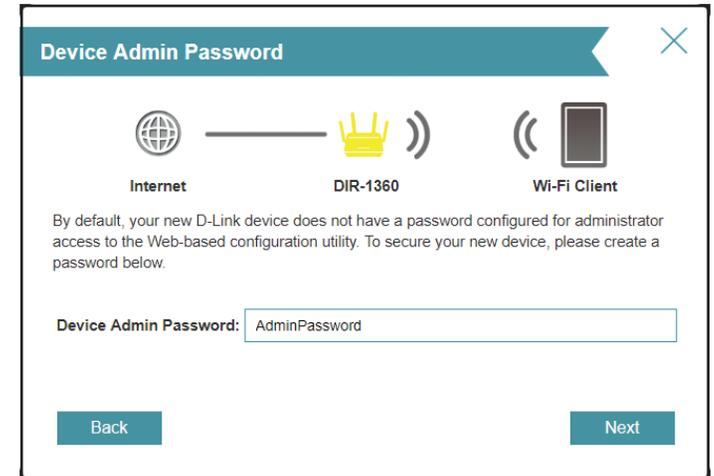

Select your time zone from the drop-down menu.

Click **Next** to continue.

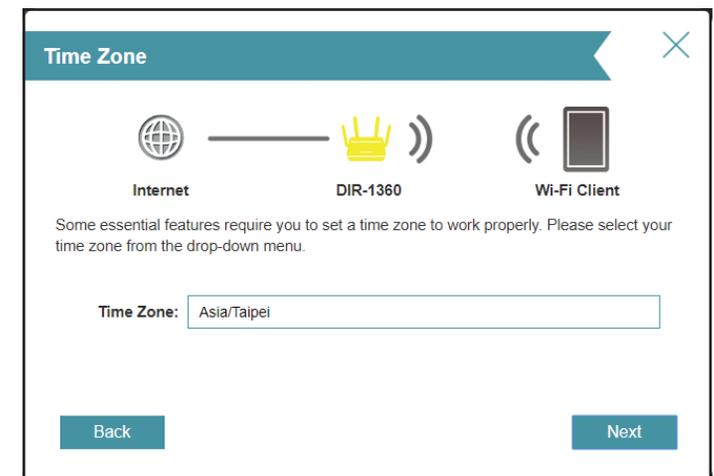

Keeping your router's firmware up to date provides you with the latest protection and new features over the air. Choose whether to keep your device up to date automatically or to manage the device updates by yourself.

Click **Next** to continue.

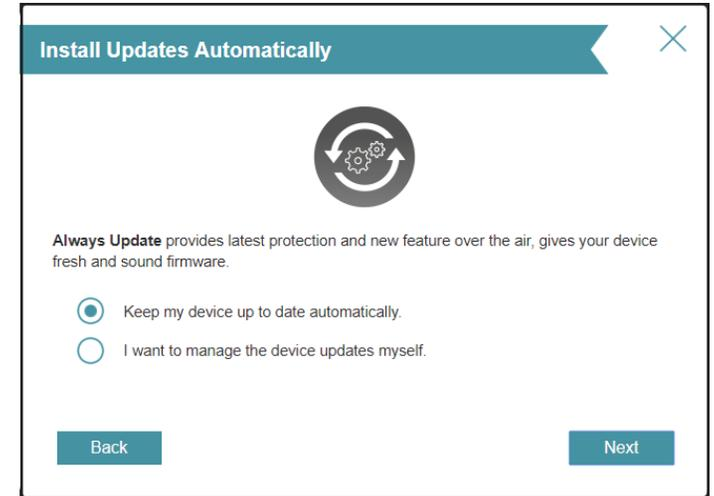

You will be presented with a summary of your settings.

Click **Next** to finalize the settings or **Back** to make changes.

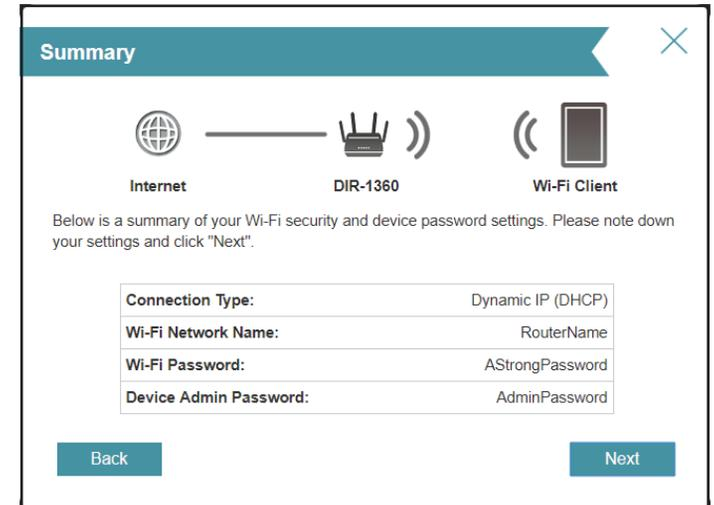

Please wait while the device settings are saved.

Do not turn off or unplug your router during this time.



Your new settings have been saved and your router is now configured.

Click **OK** to close the Setup Wizard.

Congratulations, your device has been successfully configured!

You can log in to the configuration utility by inputting the Admin Password.

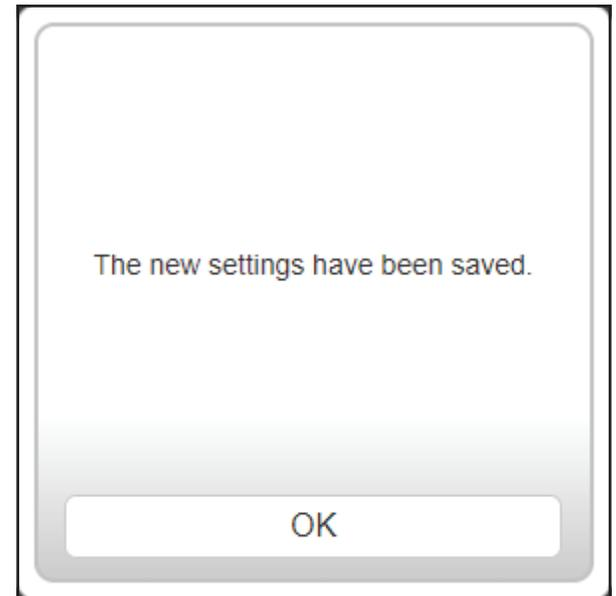

Configuration

To access the configuration utility, open your web-browser and enter **http://dlinkrouter.local./** or you may also connect by typing the IP address of the router (by default this is **http://192.168.0.1**) in the address bar.

Enter your password. If you previously followed the setup wizard, please use the admin password you entered during the wizard. Otherwise, leave the password blank. Click **Log In** to proceed.

Note: *If you cannot remember your password and cannot log in, use a paperclip to press the recessed **Reset** button on the back of the device for longer than 10 seconds to restore the router to its default settings.*

The router's home page will open displaying its current connection status.

The bar at the top of the page has quick access to **Settings**, **Features** and **Management** functions. You can quickly jump back **Home** at any time.

Note: *The system will automatically log out after a period of inactivity.*

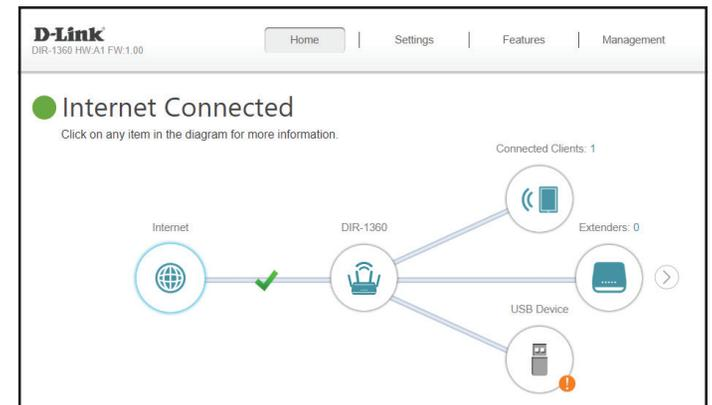
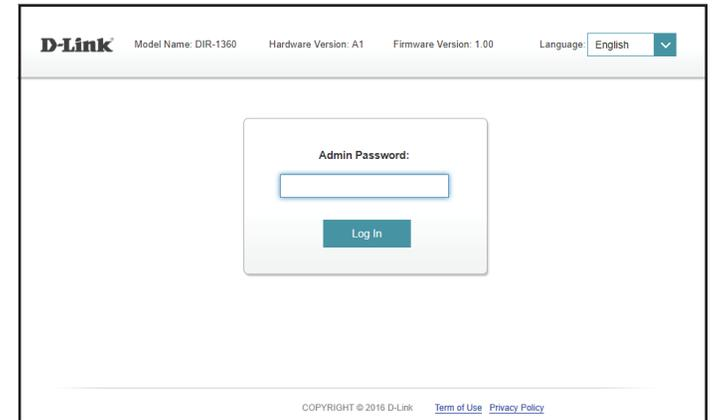
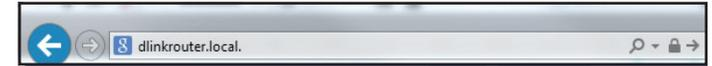

Home

The Home page displays the current status of the router in the form of an interactive diagram. You can click each icon to display information about each part of the network at the bottom of the screen. The menu bar at the top of the page will allow you to quickly navigate to other pages.

The Home page displays whether or not the router is currently connected to the Internet.

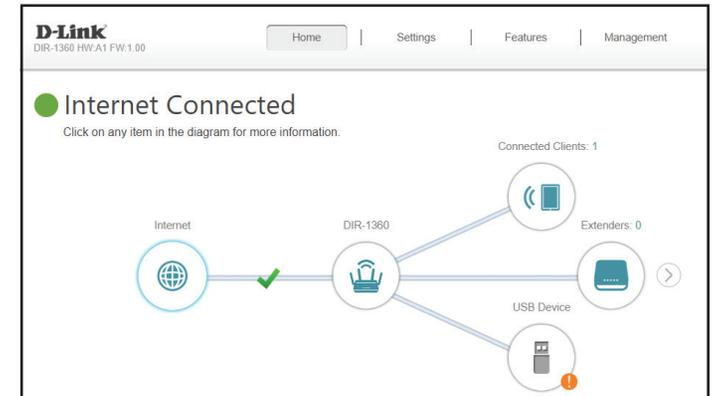

If it is disconnected, click **Click to repair** to bring up the setup wizard, refer to the **Setup Wizard** on page **29** for more information.

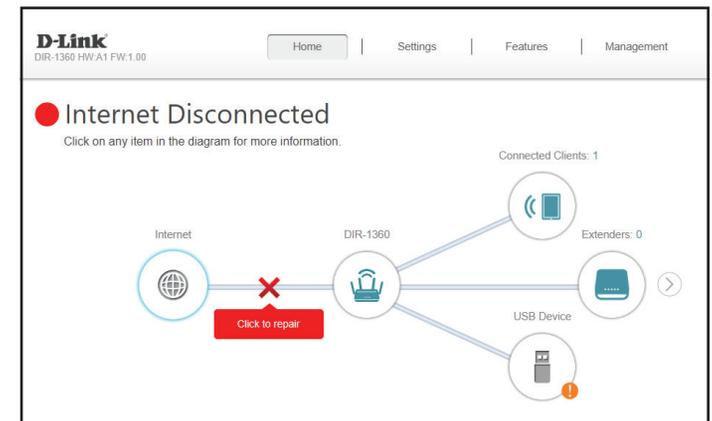

Internet

To bring up more details about your Internet connection, click on the **Internet** icon.

Click **IPv4** or **IPv6** to see details of the IPv4 connection and IPv6 connection respectively.

Click **Release IP Address** to disconnect from the Internet. If you do this and wish to reconnect, click **Renew**.

To reconfigure the Internet settings, refer to **Internet - IPv4** on page **46**

D-Link
DIR-1360 HW: A1 FW: 1.00

Home | Settings | Features | Management

Internet Connected

Click on any item in the diagram for more information.

Connected Clients: 1
Extenders: 0
USB Device

Internet

Cable Status:	Connected	MAC Address:	0C:B6:D2:93:7C:DB
Connection Type:	Dynamic IP (DHCP)	IP Address:	172.17.6.87
Network Status:	Connected	Subnet Mask:	255.255.255.0
Connection Uptime:	0 Day 0 Hour 5 Min 27 Sec	Default Gateway:	172.17.6.254
		Primary DNS Server:	192.168.168.249
		Secondary DNS Server:	192.168.168.201 192.168.168.250

[Release IP Address](#)

[Go to settings](#)

EXO Series Router

Click on your **EXO Series Router** icon to view details about the router and its wireless settings.

Here you can see the router's current Wi-Fi network name and password, as well as the router's MAC address, IPv4 address, and IPv6 address.

To reconfigure the network settings, either click **Go to settings** on the lower left, or click **Settings** (at the top of the page) and then **Network** on the menu that appears. Refer to **Network** on page **80** for more information.

To reconfigure the wireless settings, either click **Go to settings**, on the lower right, or click **Settings** (at the top of the page) and then **Wireless** on the menu that appears. Refer to **Wireless** on page **73** for more information.

The screenshot displays the D-Link DIR-1360 web interface. At the top, there is a navigation bar with 'Home', 'Settings', 'Features', and 'Management'. Below this, a green circle indicates 'Internet Connected'. A network diagram shows the router (DIR-1360) connected to the Internet, with 1 Connected Client, 0 Extenders, and 1 USB Device. Below the diagram, the router's status is shown as 'DIR-1360'. The IPv4 Network section lists: MAC Address: 0C:B6:D2:93:7C:D8, Router IP Address: 192.168.0.1, and Subnet Mask: 255.255.255.0. The IPv6 Network section lists: Link-Local Address: FE80:EB6:D2FF:FE93:7CD8, Router IPv6 Address: Not Available, DHCP-PD: Enabled, and Assigned Prefix: /64. The Wi-Fi section shows: Status: Enabled, Wi-Fi Name (SSID): RouterName, and Password: AStrongPassword. There are 'Go to settings' links at the bottom of the IPv4, IPv6, and Wi-Fi sections.

Connected Clients

Click on the **Connected Clients** icon to view details about the connected clients to the router and their wireless settings.

On this page you can see all the clients currently connected to the router, and their IP addresses.

To edit each client's settings, click the pencil icon on the client you want to edit.

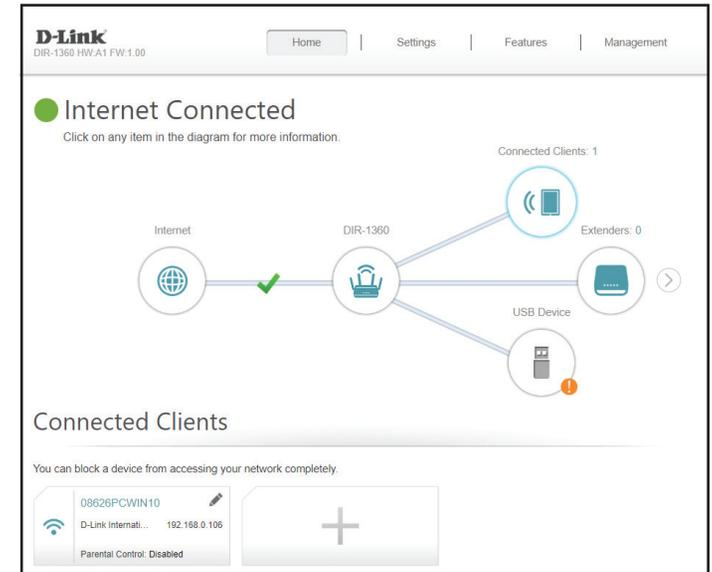

Edit Rule

Name Enter a custom name for this client.

Vendor Displays the vendor of the client.

MAC Address Displays the MAC address of the client.

IP Address Displays the current IP address of the client.

Reserve IP Enable to reserve an IP address for the client.

IP Address (Reserved) Specify an IP address for the router's DHCP server to assign.

Click **Save** when you are done.

Edit Rule

Name: 08626PCWIN10

Vendor: Universal Global Scientific Industrial Co., Ltd.

MAC Address: cc:52:af:49:e6:9e

IP Address: 192.168.0.124

Reserve IP: Remaining: 24

IP Address (Reserved):

Save

Extenders

Click on the **Extenders** icon to view details about the connected extenders to the router and their wireless settings.

On this page you can see all the extenders currently connected to the router, and configure them.

To edit each extender's settings, click the pencil icon on the extender you want to edit.

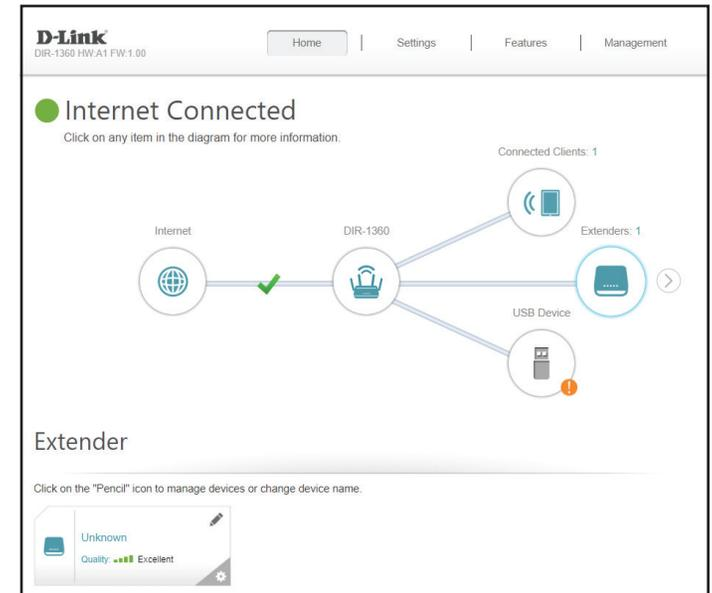

Edit Rule

Name Enter a custom name for this extender.

MAC Address Displays the MAC address of the extender.

Click **Save** when you are done.

The screenshot shows the "Edit Rule" dialog box. It has a title bar with a close button (X). Inside, there is a "Name:" label followed by an empty text input field. Below that, it says "MAC Address: 58:d5:6e:36:71:a8". At the bottom, there is a "Save" button.

Click the settings cog on the bottom right of the extender you wish to configure to either **Reboot** the device or to **Remove** the device from the network.

Click the arrow next to the Extenders icon to access information regarding your Mesh Network. For more information regarding your Mesh Network, refer to **Mesh Network** on page **43**.

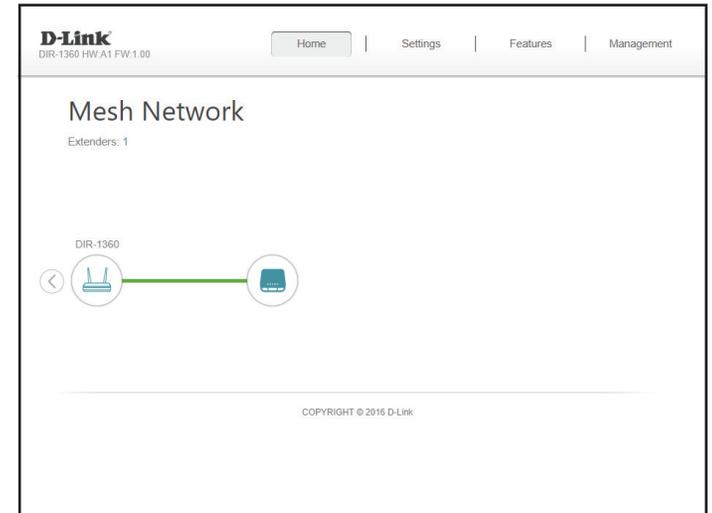
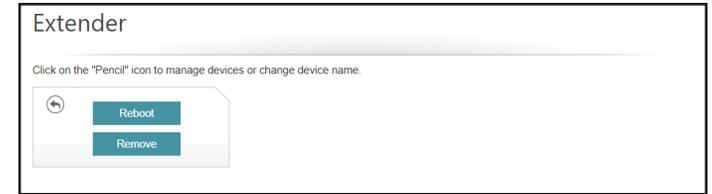

Mesh Network

D-Link's Wi-Fi Mesh is a scalable solution that allows you to easily increase the coverage of your home or office wireless AC network. Expand your Wi-Fi coverage by adding compatible D-Link access points. Mix and match suitable D-Link devices according to your budget and preferences to fit any floorplan. Setup is effortless; configuration of multiple access points can be done in minutes as settings can be passed on to other access points once the first access point is configured.

Wi-Fi Mesh intelligently finds the shortest/fastest path to your router. So even if you have eight mesh nodes, you can count on Wi-Fi Mesh to push your 4K streaming movies and intense VR games to your device at lightning speeds. Wi-Fi Mesh can also automatically detect malfunctioning nodes and reroute the connection to your working mesh devices.

The Mesh Network page gives you an instant, up-to-date overview of your mesh network topology complete with intuitive routing paths, bottle-necks and weak spots.

Please refer to the **Wi-Fi Mesh** on page **73** for Wi-Fi Mesh configuration options.

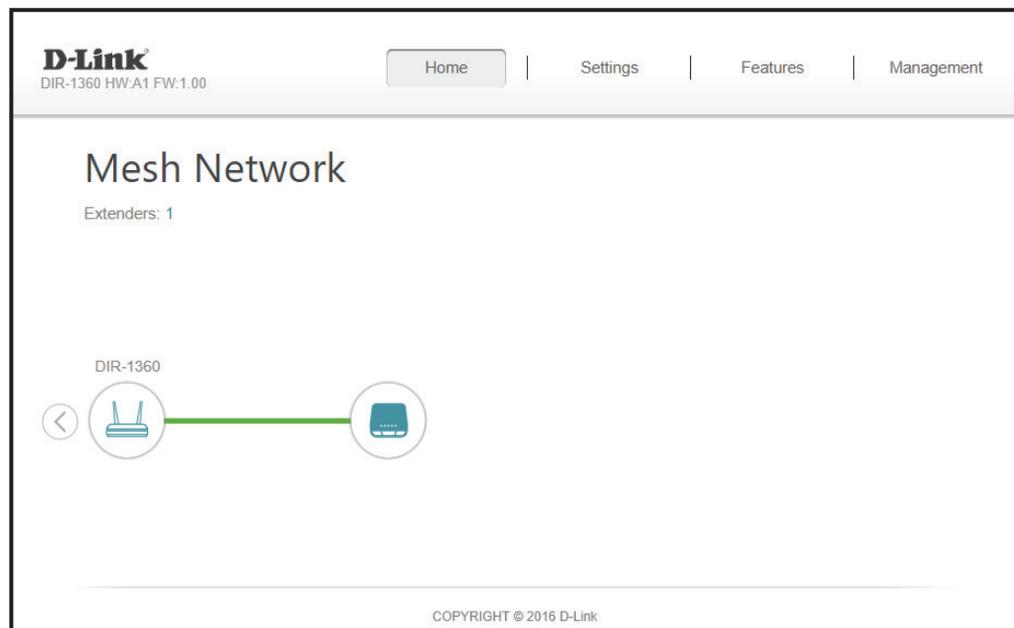

USB Device

Click on the USB Device icon to view details about the currently connected USB storage device, DLNA media server, Windows File Sharing, and FTP.

If you have a USB device connected, you can see its name and how much free space it has.

To reconfigure the USB sharing settings, either click **Go to settings** on the lower right, or click **Settings** (at the top of the page) and then **USB Sharing** on the drop down menu that appears. Refer to **USB Sharing** on page **82** for more information.

The screenshot displays the D-Link DIR-1360 web interface. At the top, there is a navigation bar with 'Home', 'Settings', 'Features', and 'Management' tabs. Below the navigation bar, a green circle indicates 'Internet Connected' with a subtext 'Click on any item in the diagram for more information.' A network diagram shows 'Internet' connected to 'DIR-1360', which is further connected to 'Connected Clients: 1', 'Extenders: 1', and 'USB Device'. Below the diagram, the 'USB Device' section is expanded, showing a progress bar for 'Flash Disk' at 0.01%. It lists 'Available Space: 7.49 GB' and 'Total Space: 7.49 GB'. To the right, there are three sharing options: 'DLNA Media Server' (Status: Enabled, Service Name: DIR-1360_DMS), 'Windows File Sharing' (Status: Disabled), and 'FTP' (Status: Disabled). A 'Go to settings' button is located at the bottom right of the USB Device section.

Settings Wizard

In the Settings menu on the bar at the top of the page, click **Wizard** to open the setup wizard. This is the same wizard that appears when you start the router for the first time. Refer to **Setup Wizard** on page **29** for details.

Note: *When the Wizard is opened, the router will disconnect from the internet.*

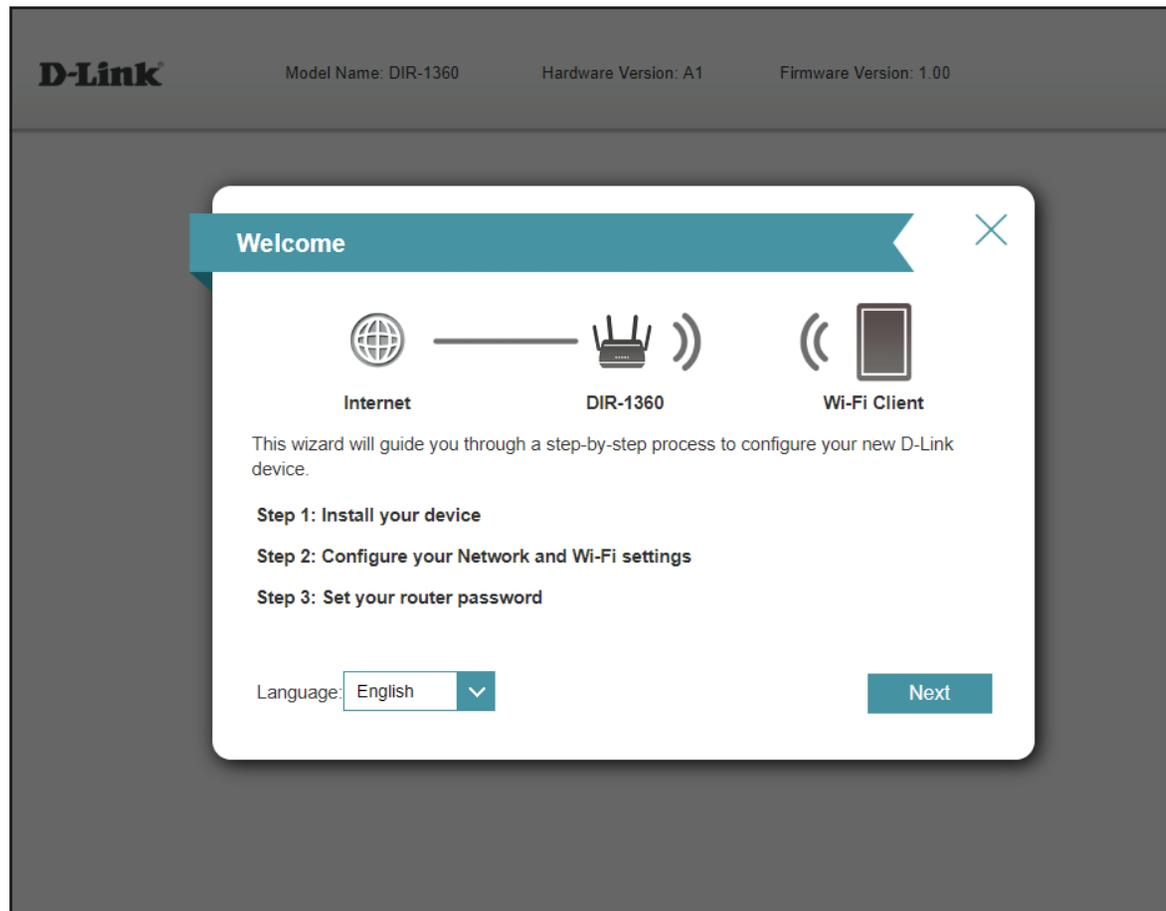

Internet - IPv4

In the Settings menu on the bar at the top of the page, click **Internet** to see the Internet configuration options for the IPv4 connection details.

To configure the IPv6 Internet and network connection details, click the **IPv6** link. Refer to **Internet - IPv6** on page **56**

To configure the VLAN connection details, click the **VLAN** link. Refer to **Internet - VLAN** on page **71**

Click **Save** at any time to save the changes you have made on this page.

My Internet Connection is

Choose your Internet connection type from the drop-down menu. You will be presented with the appropriate options for your connection type.

For **IPv4 - Dynamic IP (DHCP)** refer to page **47**

For **IPv4 - Static IP** refer to page **48**

For **IPv4 - PPPoE** refer to page **49**

For **IPv4 - PPTP** refer to page **51**

For **IPv4 - L2TP** refer to page **53**

For **IPv4 - DS-Lite** refer to page **55**

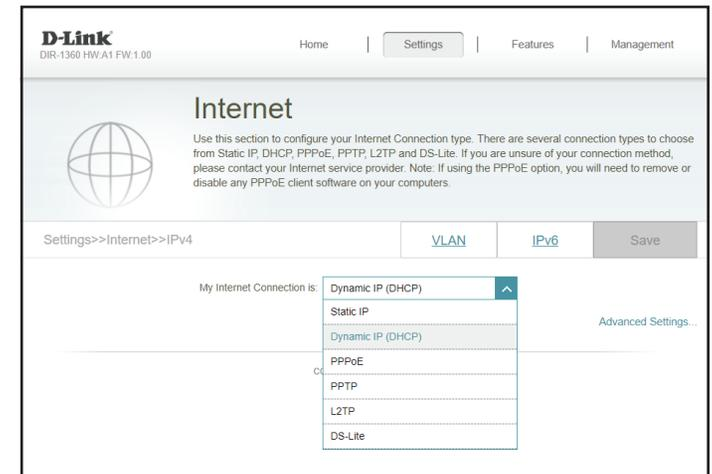

IPv4 - Dynamic IP (DHCP)

Select **Dynamic IP (DHCP)** to obtain IP address information automatically from your Internet Service Provider (ISP). Select this option if your ISP does not specify an IP address to use. Click **Save** at any time to save the changes you have made on this page.

Advanced Settings...

- Host Name** The host name is optional but may be required by some ISPs. Leave it blank if you are not sure.
- Primary DNS Server** Enter the primary DNS server IP address assigned by your ISP. This address is usually obtained automatically from your ISP.
- Secondary DNS Server** Enter the secondary DNS server IP address assigned by your ISP. This address is usually obtained automatically from your ISP.
- MTU** Maximum Transmission Unit - you may need to change the MTU for optimal performance with your ISP.
- MAC Address Clone** The default MAC address is set to the Internet port's physical interface MAC address on the router. You can use the drop-down menu to replace the Internet port's MAC address with the MAC address of a connected client.

The screenshot shows the D-Link router's web interface for configuring the Internet connection. The page title is "Internet" and the breadcrumb is "Settings > Internet > IPv4". The "My Internet Connection is:" dropdown is set to "Dynamic IP (DHCP)". Below this, there are input fields for "Host Name", "Primary DNS Server", "Secondary DNS Server", and "MTU" (set to 1500). The "MAC Address Clone" dropdown is set to "<< MAC Address". A "Save" button is located at the top right of the configuration area. The footer of the page reads "COPYRIGHT © 2016 D-Link".

IPv4 - Static IP

Select **Static IP** if your IP information is provided by your Internet Service Provider (ISP). Click **Save** at any time to save the changes you have made on this page.

- IP Address** Enter the IP address provided by your ISP.
- Subnet Mask** Enter the subnet mask provided by your ISP.
- Default Gateway** Enter the default gateway address provided by your ISP.
- Primary DNS Server** Enter the primary DNS server IP address assigned by your ISP.

The screenshot shows the D-Link router's web interface for configuring the Internet connection. The breadcrumb trail is 'Settings > Internet > IPv4'. The 'My Internet Connection is:' dropdown menu is set to 'Static IP'. Below this, there are four input fields: 'IP Address', 'Subnet Mask', 'Default Gateway', and 'Primary DNS Server'. A 'Save' button is located in the top right corner of the configuration area. The page also includes a 'VLAN' button and a 'Save' button in the top right navigation bar.

Advanced Settings...

- Secondary DNS Server** Enter the secondary DNS server IP address assigned by your ISP.
- MTU** Maximum Transmission Unit - you may need to change the MTU for optimal performance with your ISP.
- MAC Address Clone** The default MAC address is set to the Internet port's physical interface MAC address on the router. You can use the drop-down menu to replace the Internet port's MAC address with the MAC address of a connected client.

The screenshot shows the 'Advanced Settings...' section of the router's configuration page. It contains three input fields: 'Secondary DNS Server', 'MTU' (with a value of 1500), and 'MAC Address Clone' (with a dropdown menu set to '<< MAC Address'). A 'Save' button is located in the top right corner of the configuration area. The page also includes a 'VLAN' button and a 'Save' button in the top right navigation bar.

IPv4 - PPPoE

Select **PPPoE** if your ISP provides and requires you to enter a PPPoE username and password in order to connect to the Internet. Click **Save** at any time to save the changes you have made on this page.

Username Enter the username provided by your ISP.

Password Enter the password provided by your ISP.

Reconnect Mode Select either **Always on**, **On Demand**, or **Manual**.

Maximum Idle Time Configurable when **On Demand** is selected. Enter a maximum idle time during which the Internet connection is maintained during inactivity. To disable this feature, select **Always on** as the reconnect mode.

D-Link
DIR-1360 HW:V1 FW:1.00

Home | Settings | Features | Management

Internet

Use this section to configure your Internet Connection type. There are several connection types to choose from: Static IP, DHCP, PPPoE, PPTP, L2TP and DS-Lite. If you are unsure of your connection method, please contact your Internet service provider. Note: If using the PPPoE option, you will need to remove or disable any PPPoE client software on your computers.

Settings>>Internet>>IPv4

VLAN | IPv6 | Save

My Internet Connection is: **PPPoE**

Username:

Password:

Reconnect Mode: **On demand**

Maximum Idle Time: minutes

[Advanced Settings...](#)

COPYRIGHT © 2016 D-Link

Advanced Settings...

Address Mode Select **Static IP** if your ISP assigned you the IP address, subnet mask, gateway, and DNS server addresses. In most cases, select **Dynamic IP**.

[Advanced Settings...](#)

Address Mode: **Dynamic IP**

Service Name:

Primary DNS Server:

Advanced Settings... - Dynamic IP

- Address Mode** Shows your chosen address mode.
- Service Name** Enter the ISP service name (optional)
- Primary DNS Server** Enter the primary DNS server IP address assigned by your ISP.
- Secondary DNS Server** Enter the secondary DNS server IP address assigned by your ISP.
- MTU** Maximum Transmission Unit - you may need to change the MTU for optimal performance with your ISP.
- MAC Address Clone** The default MAC address is set to the Internet port's physical interface MAC address on the router. You can use the drop-down menu to replace the Internet port's MAC address with the MAC address of a connected client.

The screenshot shows the 'Advanced Settings...' page for Dynamic IP configuration. The 'Address Mode' is set to 'Dynamic IP'. The 'Service Name' field is empty. The 'Primary DNS Server' and 'Secondary DNS Server' fields are empty. The 'MTU' is set to '1492'. The 'MAC Address Clone' field is empty, and the dropdown menu is set to '<< MAC Address'. The copyright notice 'COPYRIGHT © 2016 D-Link' is visible at the bottom.

Advanced Settings... - Static IP

- Address Mode** Shows your chosen address mode.
- IP Address** Enter the IP address provided by your ISP.
- Service Name** Enter the ISP service name (optional)
- Primary DNS Server** Enter the primary DNS server IP address assigned by your ISP.
- Secondary DNS Server** Enter the secondary DNS server IP address assigned by your ISP.
- MTU** Maximum Transmission Unit - you may need to change the MTU for optimal performance with your ISP.
- MAC Address Clone** The default MAC address is set to the Internet port's physical interface MAC address on the router. You can use the drop-down menu to replace the Internet port's MAC address with the MAC address of a connected client.

The screenshot shows the 'Advanced Settings...' page for Static IP configuration. The 'Address Mode' is set to 'Static IP'. The 'IP Address' field is empty. The 'Service Name' field is empty. The 'Primary DNS Server' and 'Secondary DNS Server' fields are empty. The 'MTU' is set to '1492'. The 'MAC Address Clone' field is empty, and the dropdown menu is set to '<< MAC Address'. The copyright notice 'COPYRIGHT © 2016 D-Link' is visible at the bottom.

IPv4 - PPTP

Choose **PPTP** (Point-to-Point-Tunneling Protocol) if your Internet Service Provider (ISP) uses a PPTP connection. Your ISP will provide you with a username and password. Click **Save** at any time to save the changes you have made on this page.

PPTP Server Enter the PPTP server IP address provided by your ISP.

Username Enter the username provided by your ISP.

Password Enter the password provided by your ISP.

Reconnect Mode Select either **Always on**, **On Demand**, or **Manual**.

Maximum Idle Time Configurable when **On Demand** is selected. Enter a maximum idle time during which the Internet connection is maintained during inactivity. To disable this feature, select **Always on** as the reconnect mode.

D-Link
DIR-1360 HW:V1 FW:1.00

Home | Settings | Features | Management

Internet

Use this section to configure your Internet Connection type. There are several connection types to choose from: Static IP, DHCP, PPPoE, PPTP, L2TP and DS-Lite. If you are unsure of your connection method, please contact your Internet service provider. Note: If using the PPPoE option, you will need to remove or disable any PPPoE client software on your computers.

Settings>>Internet>>IPv4

VLAN | IPv6 | Save

My Internet Connection is: PPTP

PPTP Server: IP or Domain name

Username:

Password:

Reconnect Mode: On demand

Maximum Idle Time: 5 minutes

Advanced Settings...

COPYRIGHT © 2016 D-Link

Advanced Settings...

Address Mode Select **Static IP** if your ISP assigned you the IP address, subnet mask, gateway, and DNS server addresses. In most cases, select **Dynamic IP**.

Advanced Settings...

Address Mode: Dynamic IP

Primary DNS Server: Dynamic IP

Secondary DNS Server: Static IP

Advanced Settings... - Dynamic IP

- Address Mode** Shows your chosen address mode.
- Primary DNS Server** Enter the primary DNS server IP address assigned by your ISP.
- Secondary DNS Server** Enter the secondary DNS server IP address assigned by your ISP.
- MTU** Maximum Transmission Unit - you may need to change the MTU for optimal performance with your ISP.

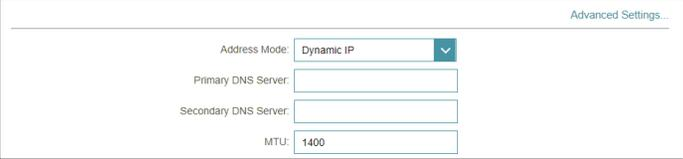

Advanced Settings...

Address Mode:

Primary DNS Server:

Secondary DNS Server:

MTU:

Advanced Settings... - Static IP

- Address Mode** Shows your chosen address mode.
- PPTP IP Address** Enter the IP address provided by your ISP.
- PPTP Subnet Mask** Enter the subnet mask provided by your ISP.
- PPTP Gateway IP Address** Enter the gateway IP address provided by your ISP.
- Primary DNS Server** Enter the primary DNS server IP address assigned by your ISP.
- Secondary DNS Server** Enter the secondary DNS server IP address assigned by your ISP.
- MTU** Maximum Transmission Unit - you may need to change the MTU for optimal performance with your ISP.

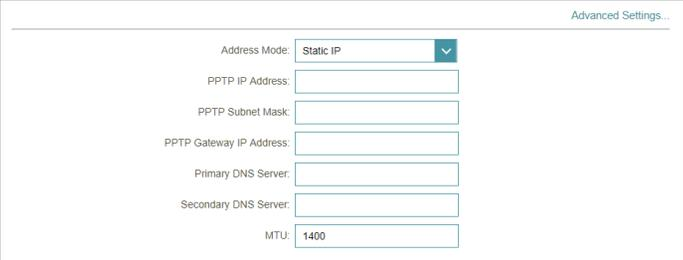

Advanced Settings...

Address Mode:

PPTP IP Address:

PPTP Subnet Mask:

PPTP Gateway IP Address:

Primary DNS Server:

Secondary DNS Server:

MTU:

IPv4 - L2TP

Choose **L2TP** (Layer 2 Tunneling Protocol) if your Internet Service Provider (ISP) uses a L2TP connection. Your ISP will provide you with a username and password. Click **Save** at any time to save the changes you have made on this page.

L2TP Server Enter the L2TP server IP address provided by your ISP.

Username Enter the username provided by your ISP.

Password Enter the password provided by your ISP.

Reconnect Mode Select either **Always on**, **On Demand**, or **Manual**.

Maximum Idle Time Configurable when **On Demand** is selected. Enter a maximum idle time during which the Internet connection is maintained during inactivity. To disable this feature, select **Always on** as the reconnect mode.

D-Link
DIR-1360 HW:A1 FW:1.00

Home | Settings | Features | Management

Internet

Use this section to configure your Internet Connection type. There are several connection types to choose from Static IP, DHCP, PPPoE, PPTP, L2TP and DS-Lite. If you are unsure of your connection method, please contact your Internet service provider. Note: If using the PPPoE option, you will need to remove or disable any PPPoE client software on your computers.

Settings>>Internet>>IPv4

VLAN | IPv6 | Save

My Internet Connection is: L2TP

L2TP Server: IP or Domain name

Username:

Password:

Reconnect Mode: On demand

Maximum Idle Time: 5 minutes

Advanced Settings...

Advanced Settings...

Address Mode Select **Static IP** if your ISP assigned you the IP address, subnet mask, gateway, and DNS server addresses. In most cases, select **Dynamic IP**.

Advanced Settings...

Address Mode: Dynamic IP

Primary DNS Server: Dynamic IP

Secondary DNS Server: Static IP

Advanced Settings... - Dynamic IP

- Address Mode** Shows your chosen address mode.
- Primary DNS Server** Enter the primary DNS server IP address assigned by your ISP.
- Secondary DNS Server** Enter the secondary DNS server IP address assigned by your ISP.
- MTU** Maximum Transmission Unit - you may need to change the MTU for optimal performance with your ISP.

The screenshot shows the 'Advanced Settings...' configuration page for Dynamic IP. It includes a dropdown menu for 'Address Mode' set to 'Dynamic IP', and three input fields for 'Primary DNS Server', 'Secondary DNS Server', and 'MTU' (set to 1400).

Advanced Settings... - Static IP

- Address Mode** Shows your chosen address mode.
- L2TP IP Address** Enter the IP address provided by your ISP.
- L2TP Subnet Mask** Enter the subnet mask provided by your ISP.
- L2TP Gateway IP Address** Enter the gateway IP address provided by your ISP.
- Primary DNS Server** Enter the primary DNS server IP address assigned by your ISP.
- Secondary DNS Server** Enter the secondary DNS server IP address assigned by your ISP.
- MTU** Maximum Transmission Unit - you may need to change the MTU for optimal performance with your ISP.

The screenshot shows the 'Advanced Settings...' configuration page for Static IP. It includes a dropdown menu for 'Address Mode' set to 'Static IP', and input fields for 'L2TP IP Address', 'L2TP Subnet Mask', 'L2TP Gateway IP Address', 'Primary DNS Server', 'Secondary DNS Server', and 'MTU' (set to 1400).

IPv4 - DS-Lite

DS-Lite is an IPv6 connection type. After selecting DS-Lite, the following parameters will be available for configuration. Click **Save** at any time to save the changes you have made on this page.

Advanced Settings...

DS-Lite Configuration

Select **DS-Lite DHCPv6 Option** to let the router allocate the AFTR IPv6 address automatically. Select **Manual Configuration** to enter the AFTR IPv6 address manually.

D-Link
DIR-1360 HW: A1 FW: 1.00

Home | Settings | Features | Management

Internet

Use this section to configure your Internet Connection type. There are several connection types to choose from: Static IP, DHCP, PPPoE, PPTP, L2TP and DS-Lite. If you are unsure of your connection method, please contact your Internet service provider. Note: If using the PPPoE option, you will need to remove or disable any PPPoE client software on your computers.

Settings>>Internet>>IPv4

VLAN | IPv6 | Save

My Internet Connection is: DS-Lite

Advanced Settings...

DS-Lite Configuration: DS-Lite DHCPv6 Option

B4 IPv4 Address: DS-Lite DHCPv6 Option

WAN IPv6 Address: Manual Configuration

Advanced Settings... - DS-Lite DHCPv6 Option

B4 IPv4 Address Enter the B4 IPv4 address value used here.

WAN IPv6 Address Once connected, the WAN IPv6 address will be displayed here.

IPv6 Default WAN Gateway Once connected, the IPv6 WAN default gateway address will be displayed here.

Advanced Settings...

DS-Lite Configuration: DS-Lite DHCPv6 Option

B4 IPv4 Address: 192.0.0.

WAN IPv6 Address: Not Available

IPv6 WAN Default Gateway: Not Available

Advanced Settings... - Manual Configuration Option

AFTR IPv6 Address Enter the AFTR IPv6 address used here.

B4 IPv4 Address Enter the B4 IPv4 address value used here.

WAN IPv6 Address Once connected, the WAN IPv6 address will be displayed here.

IPv6 WAN Default Gateway Once connected, the IPv6 WAN default gateway address will be displayed here.

Advanced Settings...

DS-Lite Configuration: Manual Configuration

AFTR IPv6 Address:

B4 IPv4 Address: 192.0.0.

WAN IPv6 Address: Not Available

IPv6 WAN Default Gateway: Not Available

Internet - IPv6

In the Settings menu on the bar at the top of the page, click **Internet** to see the Internet configuration options for the IPv4 connection details, then click the **IPv6** link to access the configuration options for the IPv6 connection details.

To configure the IPv4 Internet and network connection details, click the **IPv4** link. Refer to **Internet - IPv4** on page **46**

To configure the VLAN connection details, click the **VLAN** link. Refer to **Internet - VLAN** on page **71**

Click **Save** at any time to save the changes you have made on this page.

My Internet Connection is

Choose your Internet connection type from the drop-down menu. You will be presented with the appropriate options for your connection type.

For **IPv6 - Auto Detection** refer to page **57**

For **IPv6 - Static IPv6** refer to page **59**

For **IPv6 - Auto Configuration (SLAAC/DHCPv6)** refer to page **61**

For **IPv6 - PPPoE** refer to page **64**

For **IPv6 - 6rd** refer to page **68**

For **IPv6 - Local Connectivity Only** refer to page **70**

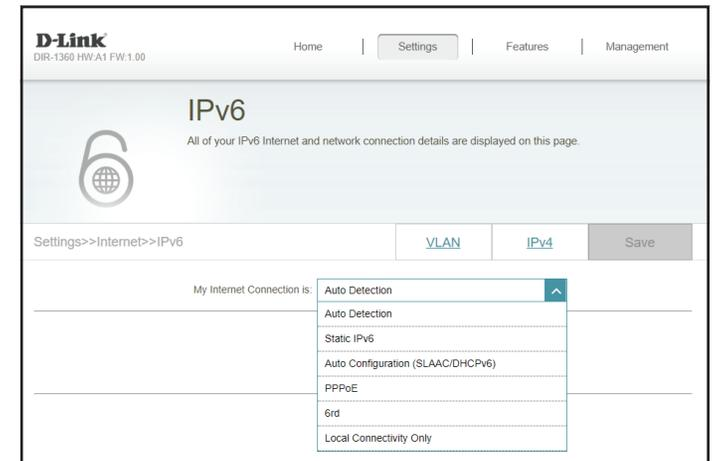

IPv6 - Auto Detection

Select **Auto Detection** to automatically detect the IPv6 connection method used by your Internet Service Provider (ISP). If Auto Detection fails, you can manually select another IPv6 connection type. Click **Save** at any time to save the changes you have made on this page.



IPv6 DNS Settings

DNS Type Select either **Obtain DNS server address automatically** or **Use the following DNS address**.

Primary DNS Server If you selected **Use the following DNS address**, enter the primary DNS server address.

Secondary DNS Server If you selected **Use the following DNS address**, enter the secondary DNS server address.

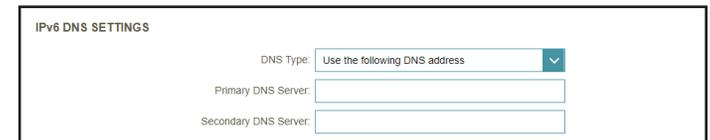
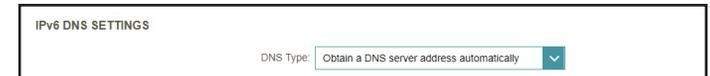

LAN IPv6 Address Settings

Enable DHCP-PD Enable or disable DHCP Prefix Delegation.

LAN IPv6 Link-Local Address Displays the router's LAN link-local address.

*If **Enable DHCP-PD** is disabled, these additional parameters are available for configuration:*

LAN IPv6 Address Enter a valid LAN IPv6 address.

LAN IPv6 Link-Local Address Displays the router's LAN link-local address.

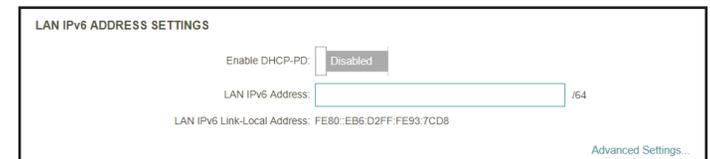
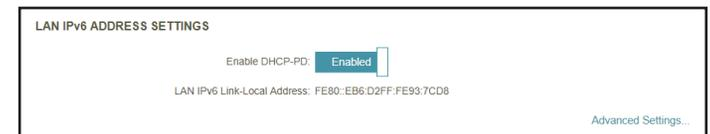

Advanced Settings... - Address Autoconfiguration Settings

- Enable Automatic IPv6 Address Assignment** Enable or disable the Automatic IPv6 Address Assignment feature.
- Enable Automatic DHCP-PD in LAN** Enable or disable DHCP-PD for other IPv6 routers connected to the LAN interface.
- Autoconfiguration Type** Select **SLAAC+RDNSS**, **SLAAC+Stateless DHCP**, or **Stateful DHCPv6**.

If you selected **SLAAC+RDNSS** or **SLAAC+Stateless DHCP** as the Autoconfiguration Type:

- Router Advertisement Lifetime** Enter the router advertisement lifetime (in minutes).
- IPv6 Address Range (End)** Enter the ending IPv6 address for the DHCP server's IPv6 assignment.

If you selected **Stateful DHCPv6** as the Autoconfiguration Type:

- IPv6 Address Range (Start)** Enter the starting IPv6 address for the DHCP server's IPv6 assignment.
- IPv6 Address Range (End)** Enter the ending IPv6 address for the DHCP server's IPv6 assignment.

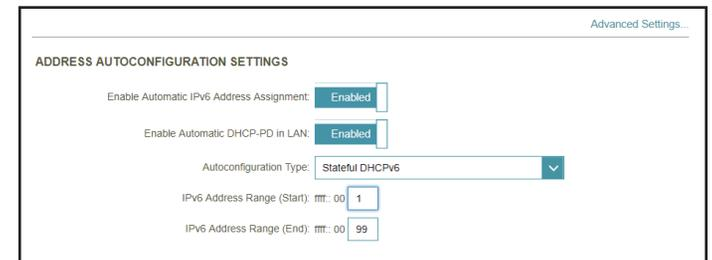
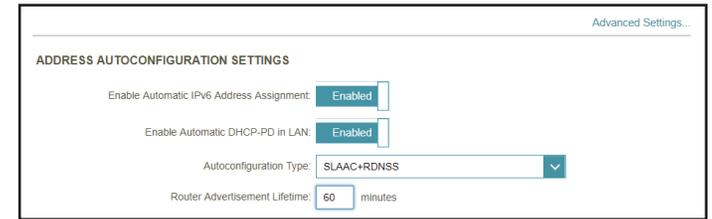
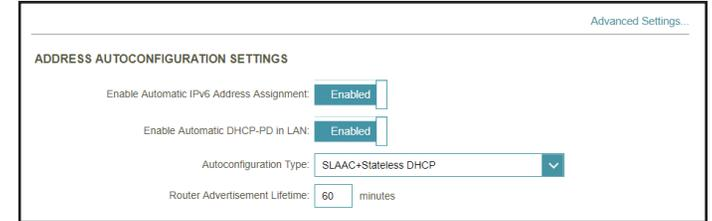

IPv6 - Static IPv6

Select **Static IP** if your IPv6 information is provided by your Internet Service Provider (ISP). Click **Save** at any time to save the changes you have made on this page.

- Use Link-Local Address** Enable or disable link-local address use.
- IPv6 Address** Configurable when **Use Link-Local Address** is disabled. Enter the address supplied by your ISP.
- Subnet Prefix Length** Configurable when **Use Link-Local Address** is disabled. Enter the subnet prefix length supplied by your ISP.
- Default Gateway** Enter the default gateway for your IPv6 connection.
- Primary DNS Server** Enter the primary DNS server address.
- Secondary DNS Server** Enter the secondary DNS server address.

LAN IPv6 Address Settings

- LAN IPv6 Address** Enter the LAN (local) IPv6 address for the router.
- LAN IPv6 Link-Local Address** Displays the router's LAN link-local address.

The screenshot shows the D-Link IPv6 configuration interface. At the top, there are navigation links for Home, Settings, Features, and Management. The main heading is 'IPv6' with a sub-note: 'All of your IPv6 Internet and network connection details are displayed on this page.' Below this is a breadcrumb trail: 'Settings >> Internet >> IPv6'. There are three tabs: 'VLAN', 'IPv4', and 'Save'. The 'Static IPv6' option is selected under 'My Internet Connection is:'. The 'Use Link-Local Address' checkbox is disabled. Below are input fields for IPv6 Address, Subnet Prefix Length, Default Gateway, Primary DNS Server, and Secondary DNS Server. At the bottom, there is a section for 'LAN IPv6 ADDRESS SETTINGS' with fields for LAN IPv6 Address (ending in /64) and LAN IPv6 Link-Local Address (FE80::EB6:D2FF:FE93:7CDB). An 'Advanced Settings...' link is visible at the bottom right.

Advanced Settings... - Address Autoconfiguration Settings

Enable Automatic IPv6 Address Assignment Enable or disable the Automatic IPv6 Address Assignment feature.

Autoconfiguration Type Select **SLAAC+RDNSS**, **SLAAC+Stateless DHCP**, or **Stateful DHCPv6**.

If you selected **SLAAC+RDNSS** or **SLAAC+Stateless DHCP** as the Autoconfiguration Type:

Router Advertisement Lifetime Enter the router advertisement lifetime (in minutes).

If you selected **Stateful DHCPv6** as the Autoconfiguration Type:

IPv6 Address Range (Start) Enter the starting IPv6 address for the DHCP server's IPv6 assignment.

IPv6 Address Range (End) Enter the ending IPv6 address for the DHCP server's IPv6 assignment.

IPv6 Address Lifetime Enter the IPv6 address lifetime (in minutes).

Advanced Settings...

ADDRESS AUTOCONFIGURATION SETTINGS

Enable Automatic IPv6 Address Assignment: Enabled

Autoconfiguration Type: SLAAC+Stateless DHCP

Router Advertisement Lifetime: 30 minutes

Advanced Settings...

ADDRESS AUTOCONFIGURATION SETTINGS

Enable Automatic IPv6 Address Assignment: Enabled

Autoconfiguration Type: SLAAC+RDNSS

Router Advertisement Lifetime: 30 minutes

Advanced Settings...

ADDRESS AUTOCONFIGURATION SETTINGS

Enable Automatic IPv6 Address Assignment: Enabled

Autoconfiguration Type: Stateful DHCPv6

IPv6 Address Range (Start): ffff: 00

IPv6 Address Range (End): ffff: 00

IPv6 Address Lifetime: 10080 minutes

IPv6 - Auto Configuration (SLAAC/DHCPv6)

Select **Auto Configuration** if your ISP assigns your IPv6 address when your router requests one from the ISP's server. Some ISPs require you to adjust settings on your side before your router can connect to the IPv6 Internet. Click **Save** at any time to save the changes you have made on this page.



IPv6 DNS Settings

DNS Type Select either **Obtain DNS server address automatically** or **Use the following DNS address**.

Primary DNS Server If you selected **Use the following DNS address**, enter the primary DNS server address.

Secondary DNS Server If you selected **Use the following DNS address**, enter the secondary DNS server address.

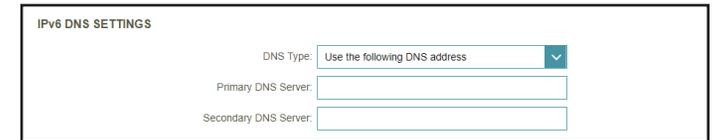

LAN IPv6 Address Settings

Enable DHCP-PD Enable or disable prefix delegation services.

LAN IPv6 Link-Local Address Displays the router's LAN link-local address.

*If **Enable DHCP-PD** is disabled, these additional parameters are available for configuration:*

LAN IPv6 Address Enter a valid LAN IPv6 address.

LAN IPv6 Link-Local Address Displays the router's LAN link-local address.



Advanced Settings... - Address Autoconfiguration Settings

Enable Automatic IPv6 Address Assignment Enable or disable the Automatic IPv6 Address Assignment feature.

If **Enable DHCP-PD** is enabled in the previous LAN IPv6 Address Settings:

Enable Automatic DHCP-PD in LAN Enable or disable DHCP-PD for other IPv6 routers connected to the LAN interface.

Autoconfiguration Type Select **SLAAC+RDNSS**, **SLAAC+Stateless DHCP**, or **Stateful DHCPv6**.

If you selected **SLAAC+RDNSS** or **SLAAC+Stateless DHCP** as the Autoconfiguration Type:

Router Advertisement Lifetime Enter the router advertisement lifetime (in minutes).

If you selected **Stateful DHCPv6** as the Autoconfiguration Type:

IPv6 Address Range (Start) Enter the starting IPv6 address for the DHCP server's IPv6 assignment.

IPv6 Address Range (End) Enter the ending IPv6 address for the DHCP server's IPv6 assignment.

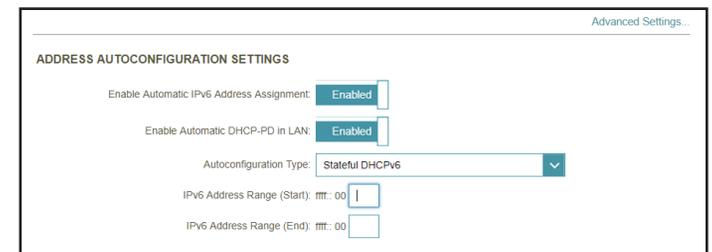
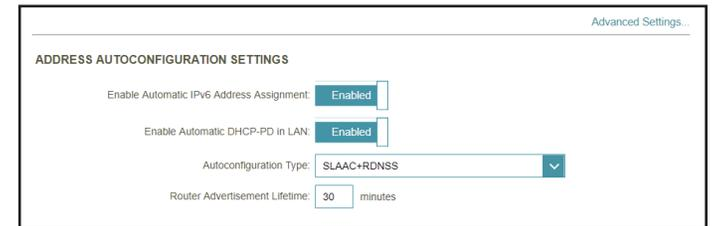
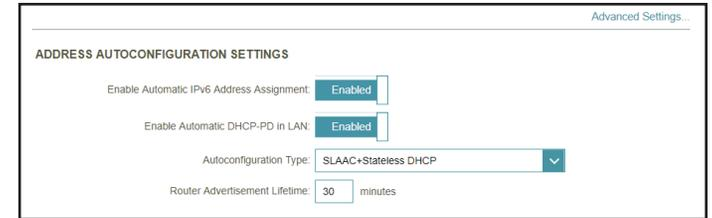

Advanced Settings... - Address Autoconfiguration Settings

Enable Automatic IPv6 Address Assignment Enable or disable the Automatic IPv6 Address Assignment feature.

If **Enable DHCP-PD** is disabled in the previous LAN IPv6 Address Settings:

Autoconfiguration Type Select **SLAAC+RDNSS**, **SLAAC+Stateless DHCP**, or **Stateful DHCPv6**.

If you selected **SLAAC+RDNSS** or **SLAAC+Stateless DHCP** as the Autoconfiguration Type:

Router Advertisement Lifetime Enter the router advertisement lifetime (in minutes).

If you selected **Stateful DHCPv6** as the Autoconfiguration Type:

IPv6 Address Range (Start) Enter the starting IPv6 address for the DHCP server's IPv6 assignment.

IPv6 Address Range (End) Enter the ending IPv6 address for the DHCP server's IPv6 assignment.

IPv6 Address Lifetime Enter the IPv6 address lifetime (in minutes).

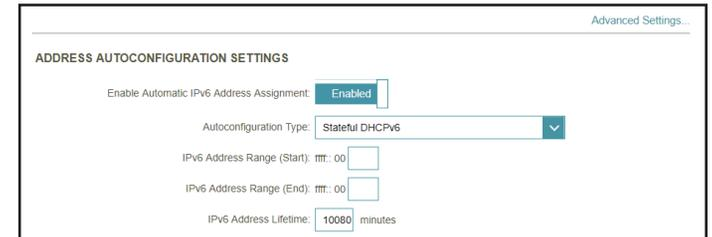
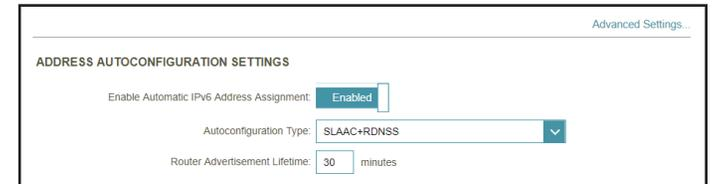
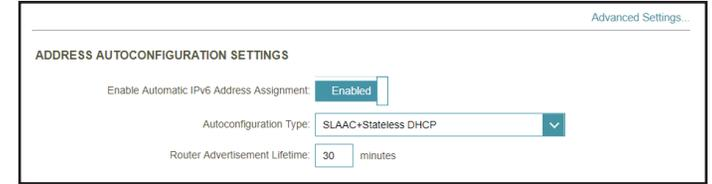

IPv6 - PPPoE

Select **PPPoE** if your ISP provides and requires you to enter a PPPoE username and password in order to connect to the Internet. Click **Save** at any time to save the changes you have made on this page.

- PPPoE Session** Create a new PPPoE session.
- Username** Enter the username provided by your ISP.
- Password** Enter the password provided by your ISP.
- Address Mode** Select either **Dynamic IP** or **Static IP**.
- IP Address** Configurable if Static IP is chosen. Enter the IP address provided by your ISP
- Service Name** Enter the ISP service name (optional).
- Reconnect Mode** Select either **Always On** or **Manual**.
- MTU** Maximum Transmission Unit - you may need to change the MTU for optimal performance with your ISP.

The screenshot shows the D-Link IPv6 configuration interface. At the top, there is a navigation bar with 'Home', 'Settings', 'Features', and 'Management'. Below this, the page title is 'IPv6' with a subtitle: 'All of your IPv6 Internet and network connection details are displayed on this page.' A breadcrumb trail reads 'Settings >> Internet >> IPv6'. There are tabs for 'VLAN', 'IPv4', and 'Save'. The main configuration area includes the following fields:

- My Internet Connection is: **PPPoE** (dropdown menu)
- PPPoE Session: **Create a new session** (dropdown menu)
- Username:
- Password:
- Address Mode: **Static IP** (dropdown menu)
- IP Address:
- Service Name:
- Reconnect Mode: **Always on** (dropdown menu)
- MTU: bytes

IPv6 DNS Settings

DNS Type Select either **Obtain DNS server address automatically** or **Use the following DNS address**.

Primary DNS Server If you selected **Use the following DNS address**, enter the primary DNS server address.

Secondary DNS Server If you selected **Use the following DNS address**, enter the secondary DNS server address.

IPv6 DNS SETTINGS

DNS Type: Obtain a DNS server address automatically

IPv6 DNS SETTINGS

DNS Type: Use the following DNS address

Primary DNS Server:

Secondary DNS Server:

LAN IPv6 Address Settings

Enable DHCP-PD Enable or disable prefix delegation services.

LAN IPv6 Link-Local Address Displays the router's LAN link-local address.

*If **Enable DHCP-PD** is disabled, these additional parameters are available for configuration:*

LAN IPv6 Address Enter a valid LAN IPv6 address.

LAN IPv6 Link-Local Address Displays the router's LAN link-local address.

LAN IPv6 ADDRESS SETTINGS

Enable DHCP-PD: Enabled

LAN IPv6 Link-Local Address: FE80::EB6:D2FF:FE93:7CD8

[Advanced Settings...](#)

LAN IPv6 ADDRESS SETTINGS

Enable DHCP-PD: Disabled

LAN IPv6 Address: /64

LAN IPv6 Link-Local Address: FE80::EB6:D2FF:FE93:7CD8

[Advanced Settings...](#)

Advanced Settings... - Address Autoconfiguration Settings

Enable Automatic IPv6 Address Assignment Enable or disable the Automatic IPv6 Address Assignment feature.

If **Enable DHCP-PD** is enabled in the previous LAN IPv6 Address Settings:

Enable Automatic DHCP-PD in LAN Enable or disable DHCP-PD for other IPv6 routers connected to the LAN interface.

Autoconfiguration Type Select **SLAAC+RDNSS**, **SLAAC+Stateless DHCP**, or **Stateful DHCPv6**.

If you selected **SLAAC+RDNSS** or **SLAAC+Stateless DHCP** as the Autoconfiguration Type:

Router Advertisement Lifetime Enter the router advertisement lifetime (in minutes).

If you selected **Stateful DHCPv6** as the Autoconfiguration Type:

IPv6 Address Range (Start) Enter the starting IPv6 address for the DHCP server's IPv6 assignment.

IPv6 Address Range (End) Enter the ending IPv6 address for the DHCP server's IPv6 assignment.

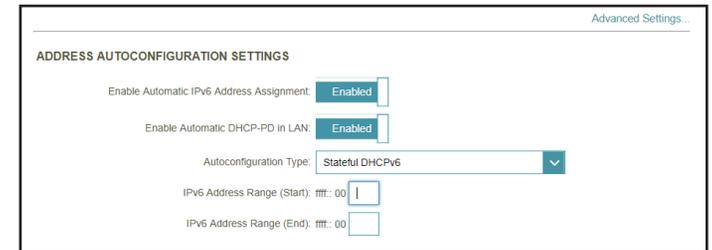
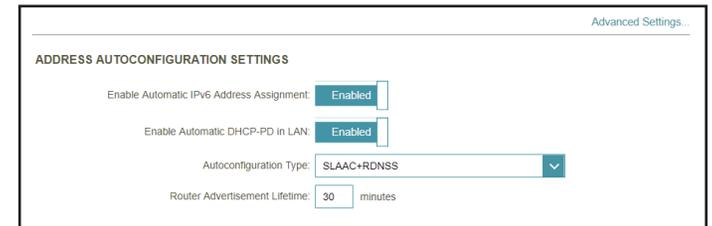
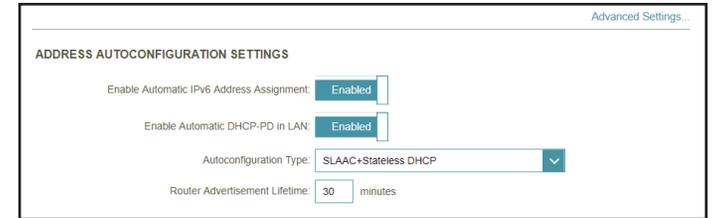

Advanced Settings... - Address Autoconfiguration Settings

Enable Automatic IPv6 Address Assignment Enable or disable the Automatic IPv6 Address Assignment feature.

If **Enable DHCP-PD** is disabled in the previous LAN IPv6 Address Settings:

Autoconfiguration Type Select **SLAAC+RDNSS**, **SLAAC+Stateless DHCP**, or **Stateful DHCPv6**.

If you selected **SLAAC+RDNSS** or **SLAAC+Stateless DHCP** as the Autoconfiguration Type:

Router Advertisement Lifetime Enter the router advertisement lifetime (in minutes).

If you selected **Stateful DHCPv6** as the Autoconfiguration Type:

IPv6 Address Range (Start) Enter the starting IPv6 address for the DHCP server's IPv6 assignment.

IPv6 Address Range (End) Enter the ending IPv6 address for the DHCP server's IPv6 assignment.

IPv6 Address Lifetime Enter the IPv6 address lifetime (in minutes).

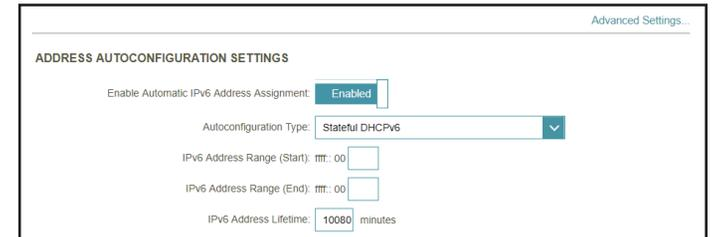
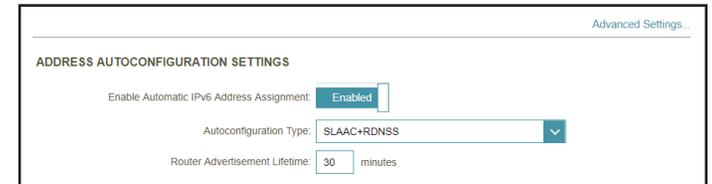
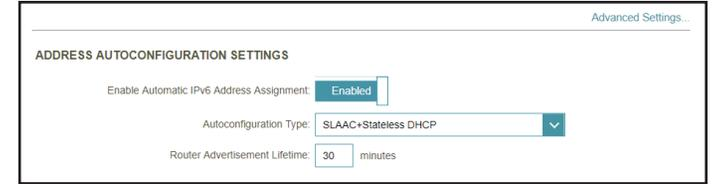

IPv6 - 6rd

In this section the user can configure the IPv6 **6rd** connection settings. Click **Save** at any time to save the changes you have made on this page.

- Assign IPv6 Prefix** Currently unsupported.
- Primary DNS Server** Enter the primary DNS server address.
- Secondary DNS Server** Enter the secondary DNS server address.

6rd Manual Configuration

Enable Hub and Spoke Mode Enable this option if you want to minimize the number of routes to the destination by using a hub and spoke method of networking.

6rd Configuration Choose the **6rd DHCPv4 Option** to automatically discover and populate the data values, or **Manual Configuration** to enter the settings yourself.

*If you selected **Manual Configuration** as the 6rd Configuration:*

- 6rd IPv6 Prefix** Enter the 6rd IPv6 prefix and mask length supplied by your ISP.
- WAN IPv4 Address** Displays the router's IPv4 address.
- 6rd Border Relay IPv4 Address** Enter the 6rd border relay IPv4 address settings supplied by your ISP.

LAN IPv6 Address Settings

LAN IPv6 Address Displays the router's LAN IPv6 Address link-local address.

LAN IPv6 Link-Local Address Displays the router's LAN link-local address.



Advanced Settings... - Address Autoconfiguration Settings

Enable Automatic IPv6 Address Assignment Enable or disable the Automatic IPv6 Address Assignment feature.

Autoconfiguration Type Select **SLAAC+RDNSS**, **SLAAC+Stateless DHCP**, or **Stateful DHCPv6**.



If you selected **SLAAC+RDNSS** or **SLAAC+Stateless DHCP** as the Autoconfiguration Type:

Router Advertisement Lifetime Enter the router advertisement lifetime (in minutes).

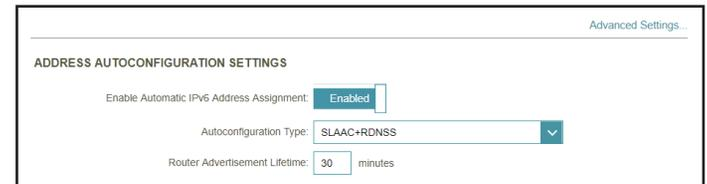

If you selected **Stateful DHCPv6** as the Autoconfiguration Type:

IPv6 Address Range (Start) Enter the starting IPv6 address for the DHCP server's IPv6 assignment.

IPv6 Address Range (End) Enter the ending IPv6 address for the DHCP server's IPv6 assignment.

IPv6 Address Lifetime Enter the IPv6 address lifetime (in minutes).

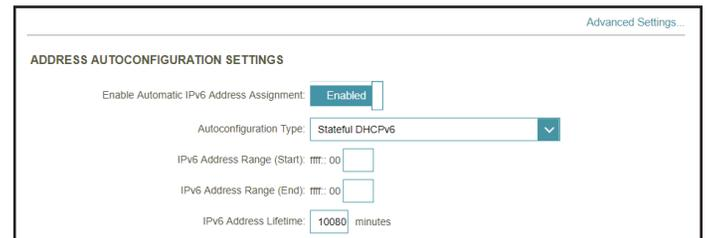

IPv6 - Local Connectivity Only

Local Connectivity Only allows you to set up an IPv6 connection that will not connect to the Internet. Click **Save** at any time to save the changes you have made on this page.



Advanced Settings... - IPv6 ULA Settings

Enable ULA Click here to enable Unique Local IPv6 Unicast Addresses settings.

Use Default ULA Prefix Enable this option to use the default ULA prefix.

ULA Prefix Configurable if you disable Use Default ULA Prefix. Enter your own ULA prefix.

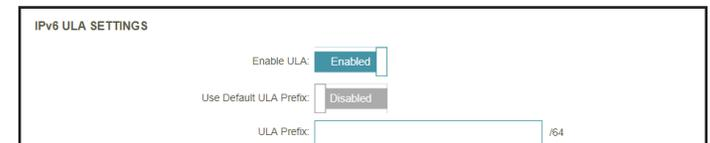

Advanced Settings... - Current IPv6 ULA Settings

Current ULA Prefix Displays the current ULA prefix.

LAN IPv6 ULA Displays the LAN's IPv6 ULA.



Internet - VLAN

In the Settings menu on the bar at the top of the page, click **Internet** to see the Internet configuration options for the IPv4 connection details, then click the **VLAN** link to access the configuration options for the VLAN connection details.

VLAN allows for services such as Triple-Play to be used, and divides a network into segments that can only be accessed by other devices in the same VLAN.

To configure the IPv4 Internet and network connection details, click the **IPv4** link. Refer to **Internet - IPv4** on page **46**

To configure the IPv6 Internet and network connection details, click the **IPv6** link. Refer to **Internet - IPv6** on page **56**

Click **Save** at any time to save the changes you have made on this page.

Status Click to enable or disable the Triple-Play VLAN feature. More configuration options will be available if the Status is enabled.

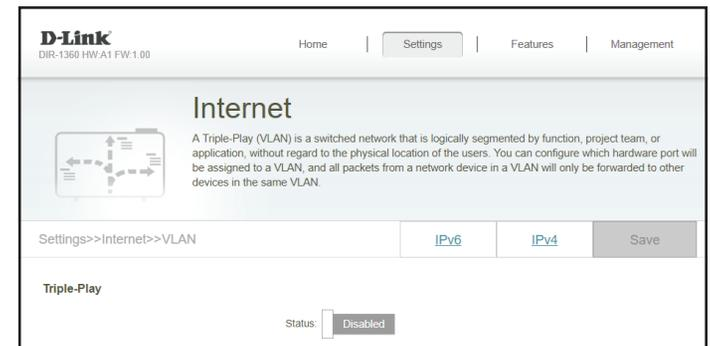

If Triple-Play Status is **Enabled**:

Priority ID Enable or disable traffic priority ID for the Internet, IPTV, and VoIP VLANs. If Priority ID is enabled, Priority ID options are available for configuration. Select a priority ID from the drop-down menus to assign to the corresponding VLAN. Higher priority ID traffic takes precedence over traffic with a low priority ID tag.

Internet VLAN ID Enter the VLAN ID for your Internet connection, as provided by your ISP.

IPTV VLAN ID Enter the VLAN ID for your IPTV service, as provided by your ISP.

VOIP VLAN ID Enter the VLAN ID for your VoIP network, as provided by your ISP.

Interface Traffic Type Setting

LAN Port 1-4 From the drop-down menu, you can select the type of connection (Internet, IPTV, or Voice over IP) coming from the WAN connection to each interface on the router.

D-Link
DIR-1360 HW-A1 FW:1.00

Home | Settings | Features | Management

Internet

A Triple-Play (VLAN) is a switched network that is logically segmented by function, project team, or application, without regard to the physical location of the users. You can configure which hardware port will be assigned to a VLAN, and all packets from a network device in a VLAN will only be forwarded to other devices in the same VLAN.

Settings >> Internet >> VLAN | IPv6 | IPv4 | Save

Triple-Play

Status: Enabled

Priority ID: Enabled

Internet VLAN

Internet VLAN ID: Priority ID: ▼

IPTV VLAN

IPTV VLAN ID: Priority ID: ▼

VOIP VLAN

VOIP VLAN ID: Priority ID: ▼

Interface Traffic Type Setting

LAN Port 1: ▼

LAN Port 2: ▼

LAN Port 3: ▼

LAN Port 4: ▼

Wireless

In the Settings menu on the bar at the top of the page, click **Wireless** to see your wireless network settings for your EXO Series Router.

Click **Save** at any time to save the changes you have made on this page.

Wi-Fi Mesh

Status Enable or disable the Wi-Fi Mesh feature. Refer to **Mesh Network** on page **43** for more information.

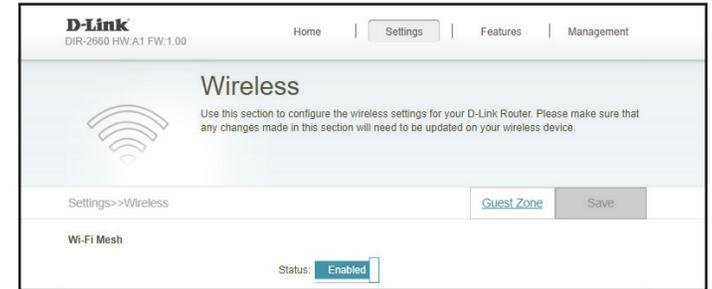

Smart Connect

Status Enable or disable the Smart Connect Feature. When enabled, only a few configuration options are available to simplify configuration.

If Smart Connect is Status is **Enabled**:

Wireless

Wi-Fi Name (SSID) Create a name for your wireless network using up to 32 characters.

Password Create a password to use for wireless security. Wireless clients will need to enter this password to successfully connect to the network.

Wireless - Advanced Settings...

Security Mode Choose **None** or **WPA/WPA2-Personal** (recommended).

Transmission Power Select the desired wireless transmission power.

Schedule Use the drop-down menu to select the time schedule that the rule will be enabled for. The schedule may be set to Always Enable, or you can create your own schedules in the Schedules section. Refer to **Time & Schedule - Schedule** on page **101** for more information.

Smart Connect

Status: **Enabled**

Wireless

Wi-Fi Name (SSID): RouterName

Password: AStrongPassword

[Advanced Settings...](#)

Security Mode: WPA/WPA2-Personal

Transmission Power: High

Schedule: Always Enable

Smart Connect

Status Enable or disable the Smart Connect Feature. When disabled, 2.4GHz and 5GHz configuration options become available.

If Smart Connect is Status is **Disabled**:

2.4GHz / 5GHz

Status Enable or disable the 2.4GHz / 5GHz wireless network.

Wi-Fi Name (SSID) Create a name for your wireless network using up to 32 characters.

Password Create a password to use for wireless security. Wireless clients will need to enter this password to successfully connect to the network.



Smart Connect

Status: Disabled

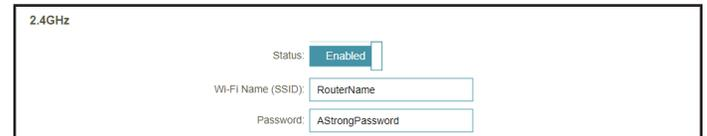

2.4GHz

Status: Enabled

Wi-Fi Name (SSID):

Password:

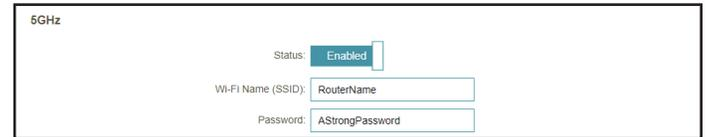

5GHz

Status: Enabled

Wi-Fi Name (SSID):

Password:

Note: For the DIR-3060, the 5GHz section is separated into Primary 5GHz and Secondary 5GHz but contain the same configuration elements.

2.4GHz / 5GHz - Advanced Settings...

Security Mode Choose **None** or **WPA/WPA2-Personal** (recommended).

802.11 Mode (2.4GHz) Select the desired wireless networking standards to use. The available options for the 2.4 GHz wireless network are **Mixed 802.11b/g/n**, **Mixed 802.11g/n**, or **802.11n only**.

802.11 Mode (5GHz) Select the desired wireless networking standards to use. The available options for the 5 GHz wireless network are **Mixed 802.11a/n/ac**, **Mixed 802.11n/ac**, **Mixed 802.11a/n**, **802.11ac only**, **Mixed 802.11a only**, or **802.11n only**.

Wi-Fi Channel Select the desired channel. The default is **Auto** (recommended).

Transmission Power Select the desired wireless transmission power.

Channel Width (2.4GHz) Select **Auto 20/40** if you are using both 802.11n and non-802.11n devices, or select **20 MHz** if you are not using any 802.11n devices.

Channel Width (5GHz) Select **Auto 20/40/80** if you are using 802.11ac, 802.11n, and 802.11a devices, select **Auto 20/40** if you are using 802.11n and 802.11a devices, or select **20 MHz** if you are using 802.11a devices.

HT20/40 Coexistence (2.4GHz) Enable or disable HT20/40 Coexistence.

Visibility Status The default setting is **Visible**. Select **Invisible** if you do not want to broadcast the SSID of your wireless network.

Schedule Use the drop-down menu to select the time schedule that the rule will be enabled for. The schedule may be set to **Always Enable**, or you can create your own schedules in the **Schedules** section. Refer to **Time & Schedule - Schedule** on page **101** for more information.

2.4GHz

Status: Enabled

Wi-Fi Name (SSID):

Password:

Advanced Settings...

Security Mode:

802.11 Mode:

Wi-Fi Channel:

Transmission Power:

Channel Width:

HT20/40 Coexistence: Enabled

Visibility Status:

Schedule:

5GHz

Status: Enabled

Wi-Fi Name (SSID):

Password:

Advanced Settings...

Security Mode:

802.11 Mode:

Wi-Fi Channel:

Transmission Power:

Channel Width:

Visibility Status:

Schedule:

Note: For the DIR-3060, the 5GHz section is separated into Primary 5GHz and Secondary 5GHz but contain the same configuration elements.

Wi-Fi Protected Setup

The easiest way to connect your wireless devices to the router is with Wi-Fi Protected Setup (WPS).

WPS-PBC Status Enable or disable WPS-PBC (Push Button Configuration) functionality.



Guest Zone

In the Settings menu on the bar at the top of the page, click **Wireless** to see your wireless network settings for your EXO Series Router. Then click the link to **Guest Zone** to configure your guest zone settings.

The **Guest Zone** feature will allow you to create temporary zones that can be used by guests to access the Internet. These zones will be separate from your main wireless network. You may configure different zones for the 2.4 GHz and 5 GHz wireless bands.

Click **Save** at any time to save the changes you have made on this page.

If Smart Connect is Status is **Enabled** in the previous Wireless settings:

Wireless

Status Enable or disable the Guest Zone feature. The status is disabled by default.

Wireless Name (SSID) Create a name for your wireless network using up to 32 characters.

Password Create a password to use for wireless security.

Schedule Use the drop-down menu to select the time schedule that the rule will be enabled for. The schedule may be set to **Always Enable**, or you can create your own schedules in the **Schedules** section. Refer to **Time & Schedule - Schedule** on page **101** for more information.

Home Network Access

Internet Access Only Enabling this option will confine connectivity to the Internet, preventing guests from accessing other local network devices.

The screenshot displays the D-Link Guest Zone configuration interface. At the top, there's a navigation bar with 'Home', 'Settings', 'Features', and 'Management'. The main heading is 'Guest Zone' with a sub-note: 'This page lets you enable and configure a Wi-Fi Guest Zone. Users connected to a Guest Zone cannot communicate or detect devices on your home network unless Internet Access Only is disabled under Home Network Access.' Below this, there's a breadcrumb trail 'Settings>>Wireless>>Guest Zone' and a 'Save' button. The 'Wireless' section contains:

- Status: Enabled (checkbox)
- Wi-Fi Name (SSID): dlink-guest
- Password: abcde88888
- Schedule: Always Enable (dropdown menu)

 The 'Home Network Access' section contains:

- Internet Access Only: Enabled (checkbox)

If Smart Connect is Status is **Disabled** in the previous Wireless settings:

2.4 GHz / 5GHz

Status Enable or disable the Guest Zone feature. The status is disabled by default.

Wireless Name (SSID) Create a name for your wireless network using up to 32 characters.

Password Create a password to use for wireless security.

Schedule Use the drop-down menu to select the time schedule that the rule will be enabled for. The schedule may be set to **Always Enable**, or you can create your own schedules in the **Schedules** section. Refer to **Time & Schedule - Schedule** on page **101** for more information.

Home Network Access

Internet Access Only Enabling this option will confine connectivity to the Internet, preventing guests from accessing other local network devices.

Network

In the Settings menu on the bar at the top of the page, click **Network** to change the local network settings of the router and to configure the DHCP settings.

Click **Save** at any time to save the changes you have made on this page.

Network Settings

LAN IP Address Enter the IP address of the router. The default IP address is **192.168.0.1**. If you change the IP address, once you click **Save**, you will need to enter the new IP address in your browser to get back into the configuration utility.

Subnet Mask Enter the subnet mask of the router. The default subnet mask is **255.255.255.0**.

Management Link The default address to access the router's configuration is **http://dlinkrouter.local/**. You can replace **dlinkrouter** with a name of your choice.

Local Domain Name Enter the domain name (optional).

Enable DNS Relay Disable to transfer the DNS server information from your ISP to your computers. If enabled, your computers will use the router for a DNS server.

The screenshot shows the D-Link Network Settings page. At the top, there is a navigation bar with 'Home', 'Settings', 'Features', and 'Management'. Below the navigation bar, the page title is 'Network'. A brief instruction reads: 'Use this section to configure the network settings for your device. You can enter a name for your device in the management link field, and use the link to access web UI in a web browser. We recommend you change the management link if there are more than one D-Link devices within the network.' Below this, there is a 'Save' button. The main section is titled 'Network Settings' and contains the following fields:

- LAN IP Address:
- Subnet Mask:
- Management Link:
- Local Domain Name:
- Enable DNS Relay: Enabled

At the bottom right of the form area, there is a link for 'Advanced Settings...'.

DHCP Server

Status Enable or disable the DHCP server.

DHC IP Address Range Enter the starting and ending IP addresses for the DHCP server's IP assignment. **Note:** *If you statically assign IP addresses to your computers or devices, make sure the IP addresses are outside of this range or you may have an IP conflict.*

DHCP Lease Time Enter the length of time for the IP address lease in minutes.

Always Broadcast Enable this feature to broadcast your network's DHCP server to LAN/WLAN clients.

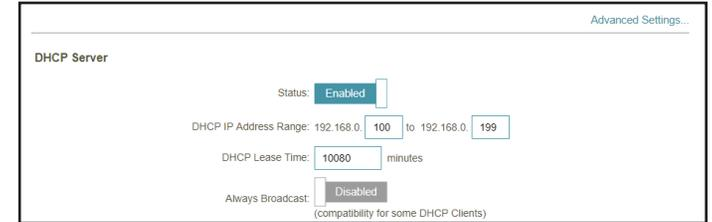

Advanced Settings

WAN Port Speed You may set the port speed of the Internet port to **10 Mbps**, **100 Mbps**, **1000 Mbps**, or **Auto** (recommended).

UPnP Enable or disable Universal Plug and Play (UPnP). UPnP provides compatibility with networking equipment, software, and peripherals.

IPv4 Multicast Streams Enable to allow IPv4 multicast traffic to pass through the router from the Internet. This is enabled by default.

IPv6 Multicast Streams Enable to allow IPv6 multicast traffic to pass through the router from the Internet. This is enabled by default.

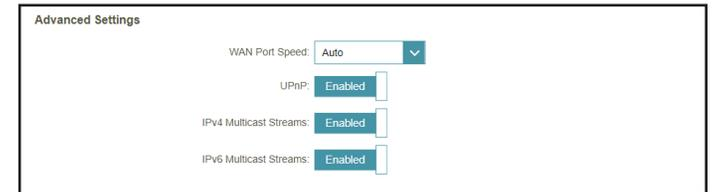

USB Sharing

In the Settings menu on the bar at the top of the page, click **USB Sharing** to set up access to files on an external USB drive plugged into the router. You can access shared files such as photos, music, and movies through the local network or from the Internet using a web browser or an app on your mobile device. Access your files on your local network using SAMBA or UPnP media sharing, or access them over the web using FTP.

You can also click on the User tab which will redirect you to create and configure user accounts. For more details, refer to **User** on page **106**

Click **Save** at any time to save the changes you have made on this page.

UPnP Media Server

Status Enable or disable the UPnP media server function, allowing connected clients access to media files over the network.

UPnP Media Server Choose a name for your DLNA media server so that it can be found.

Windows File Sharing (SAMBA)

Status Enable or disable the Windows file sharing function, allowing connected clients access to shared files over the network.

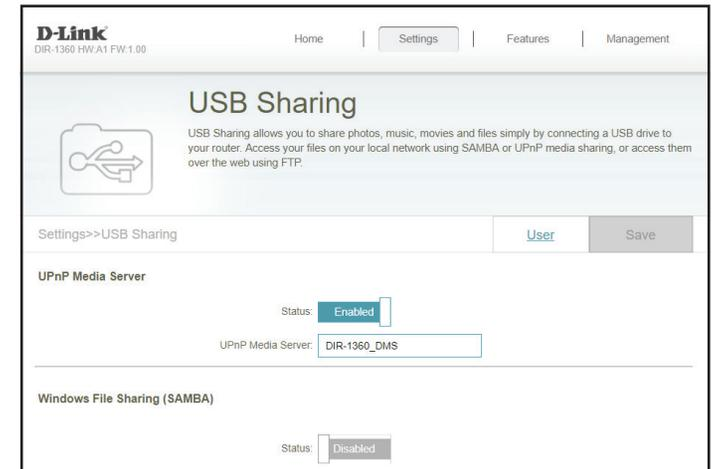

FTP Server

Status Enable or disable the FTP server function, allowing connected clients access to media files through FTP.

FTP Server - Advanced Settings...

Enable Remote Sharing If **FTP server** is enabled, enable or disable remote access to files stored on a USB device plugged into the router through a web browser.

FTP Server Port Enter the port number of FTP server.

Idle Time Enter the time (in minutes) before connected clients will be considered idle.

The screenshot shows the 'FTP Server' configuration page. At the top, the title 'FTP Server' is displayed. Below it, the 'Status' is set to 'Enabled'. A link for 'Advanced Settings...' is visible on the right. Underneath, the 'Enable Remote Sharing' option is also set to 'Enabled'. The 'FTP Server Port' is configured to '21', and the 'Idle Time' is set to '5' minutes.

D-Link Cloud

In the Settings menu on the bar at the top of the page, click **D-Link Cloud** to see your D-Link Cloud Service details. This page lists whether you are registered with D-Link Cloud Service and email address associated with the account. Use the D-Link Wi-Fi app to find out more about D-Link Cloud's features.

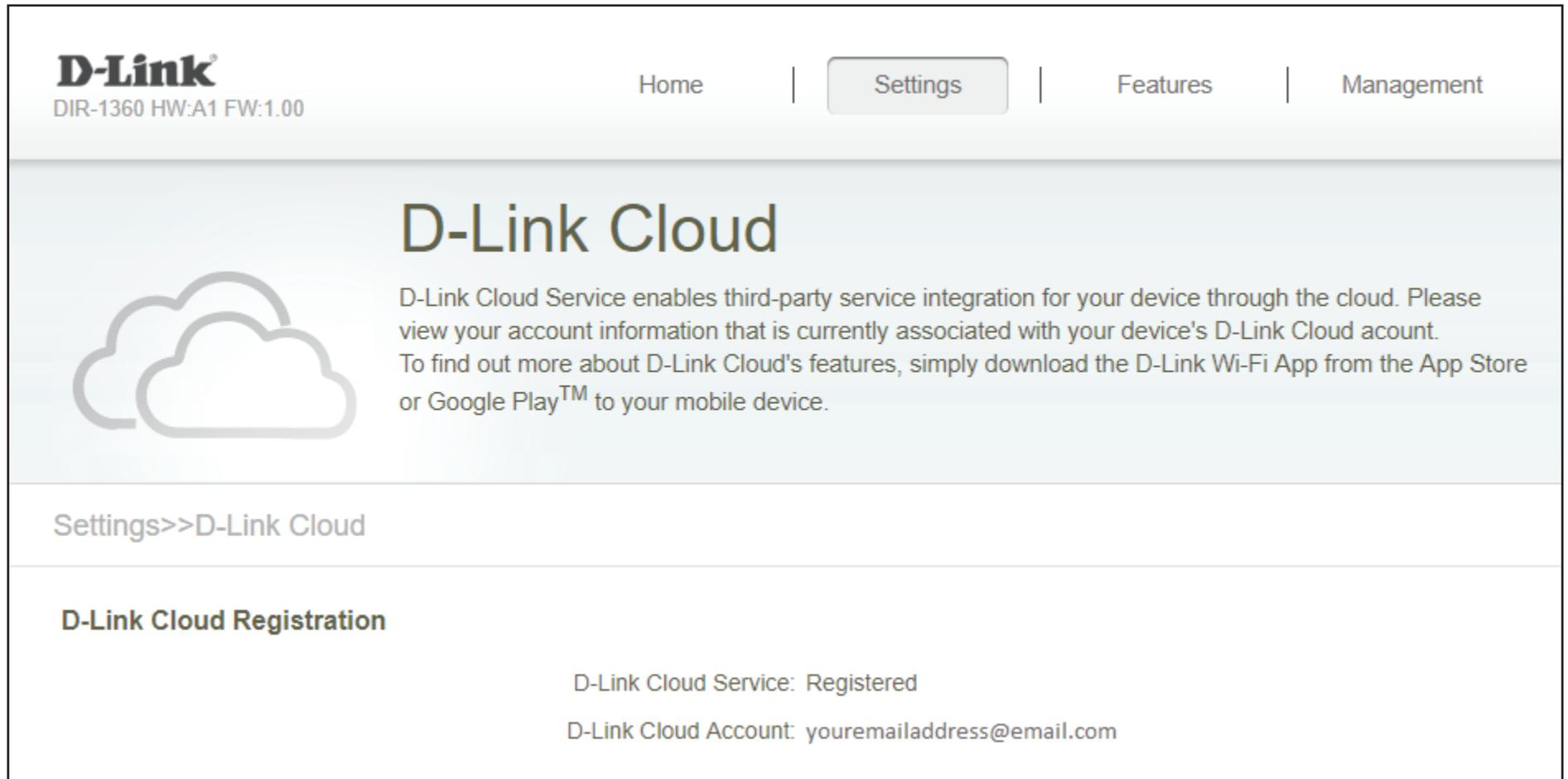

The screenshot shows the D-Link Cloud settings page. At the top left is the D-Link logo and the model number DIR-1360 HW:A1 FW:1.00. The navigation bar includes Home, Settings (highlighted), Features, and Management. The main heading is "D-Link Cloud" with a cloud icon. Below the heading is a paragraph explaining the service and providing instructions on how to find more information. A breadcrumb trail shows "Settings >> D-Link Cloud". The section "D-Link Cloud Registration" displays the status "D-Link Cloud Service: Registered" and the account email "D-Link Cloud Account: youremailaddress@email.com".

D-Link
DIR-1360 HW:A1 FW:1.00

Home | **Settings** | Features | Management

D-Link Cloud

D-Link Cloud Service enables third-party service integration for your device through the cloud. Please view your account information that is currently associated with your device's D-Link Cloud account. To find out more about D-Link Cloud's features, simply download the D-Link Wi-Fi App from the App Store or Google Play™ to your mobile device.

Settings >> D-Link Cloud

D-Link Cloud Registration

D-Link Cloud Service: Registered
D-Link Cloud Account: youremailaddress@email.com

Features

QoS Engine

In the Features menu on the bar at the top of the page, click **QoS Engine** to configure connected clients Internet access priority.

Click **Save** at any time to save the changes you have made on this page.

Internet Speed Checkup

Click on the **Check Speed** button to launch the Internet Speedtest. A window will pop up to show you the results of the speedtest. When the test is complete, you can either choose **Detect Again** to run the speedtest again, or you can choose **Apply to QoS** to apply the results to the download and upload speeds.

Management Type

Use the drop-down menu to select the Management Type that the rule will be enabled for. This may be set to **Off** or **Manage By Device**.

Download Speed (Mbps)

Set the download speed based on your ISP subscription plan in order to adjust the QoS engine. Alternatively, you can input the values from the speedtest through the **Check Speed** button above and apply the results by clicking **Apply to QoS** after the speedtest is complete.

Upload Speed (Mbps)

Set the upload speed based on your ISP subscription plan in order to adjust the QoS engine. Alternatively, you can input the values from the speedtest through the **Check Speed** button above and apply the results by clicking **Apply to QoS** after the speedtest is complete.

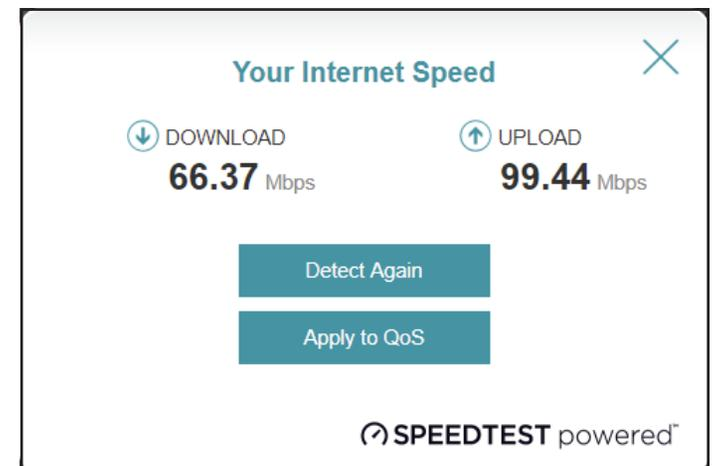
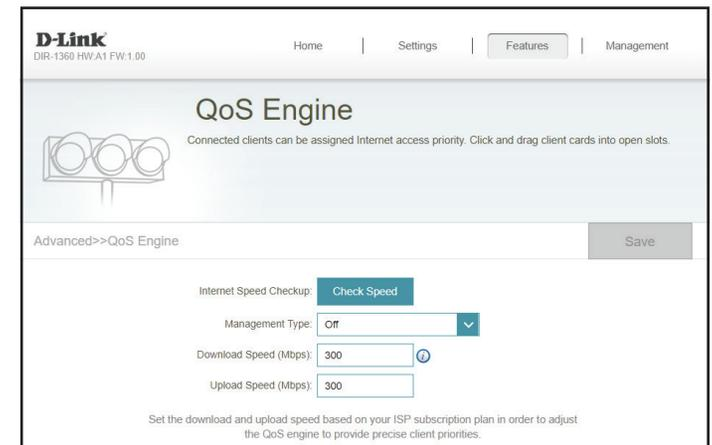

This **Quality of Service (QoS) Engine** will allow you to prioritize particular clients over others, so that those clients receive higher bandwidth. For example, if one client is streaming a movie and another is downloading a non-urgent file, you might wish to assign the former device a higher priority than the latter so that the movie streaming is not disrupted by the traffic of the other devices on the network.

Under **Connected Clients**, you will see device cards representing each connected client. If some are off-screen, you can use the < and > buttons to scroll through the cards.

A maximum of **one** device can be assigned **Highest** priority.

A maximum of **two** devices can be assigned **High** priority.

A maximum of **eight** devices can be assigned **Medium** priority.

If no devices are explicitly assigned a priority, they will all be treated with equal priority. If some devices are not assigned a priority and others are, the unassigned devices will be treated with the lowest priority.

To assign a priority level to a device, drag the device card from the All Devices list over an empty slot and release the mouse button. The card will remain in the slot. If you want to remove a priority assignment from a device and return it to the All Devices list, click the cross icon in the top right of the device card.

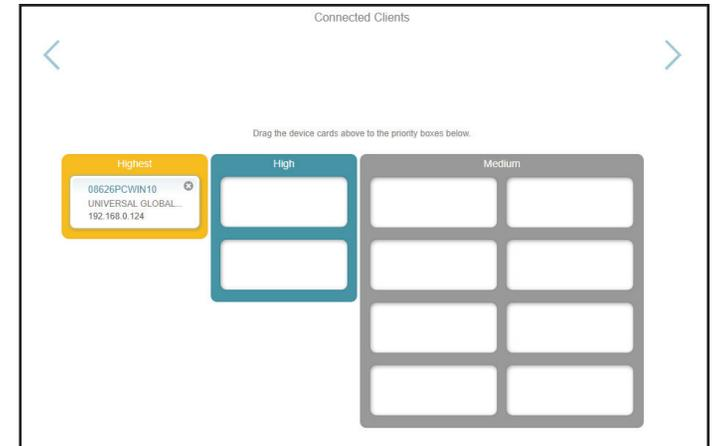

Firewall Settings - Advanced

In the Features menu on the bar at the top of the page, click **Firewall** to configure the router's firewall settings. The firewall feature protects your network from malicious attacks over the Internet.

To configure the IPv4 firewall rules, click the **IPv4 Rules** link. Refer to **Firewall Settings - IPv4/IPv6 Rules** on page **89**

To configure the IPv6 firewall rules, click the **IPv6 Rules** link. Refer to **Firewall Settings - IPv4/IPv6 Rules** on page **89**

Click **Save** at any time to save the changes you have made on this page.

Enable DMZ Enable or disable Demilitarized Zone (DMZ). This completely exposes the client to threats over the Internet, and is not recommended in ordinary situations.

DMZ IP Address If you enabled DMZ, enter the IP address of the client you wish to expose, or use the drop-down menu to quickly select it.

Enable SPI IPv4 Enabling Stateful Packet Inspection (SPI) helps to prevent cyber attacks by validating that the traffic passing through the session conforms to the protocol.

Enable Anti-spoof Checking Enable this feature to help protect your network from certain kinds of "spoofing" attacks.

IPv6 Simple Security Enable or disable IPv6 simple security.

IPv6 Ingress Filtering Enable or disable IPv6 ingress filtering.

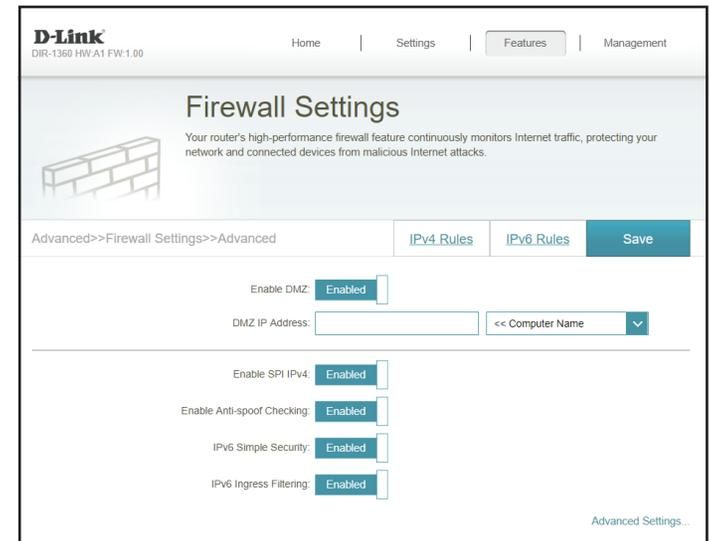

Advanced Settings... - Application Level Gateway (ALG) Configuration

- PPTP** Allows multiple machines on the LAN to connect to their corporate network using the PPTP protocol.
- IPSec (VPN)** Allows multiple VPN clients to connect to their corporate network using IPSec. Some VPN clients support traversal of IPSec through NAT. This Application Level Gateway (ALG) may interfere with the operation of such VPN clients. If you are having trouble connecting with your corporate network, try turning this ALG off. Please check with the system administrator of your corporate network whether your VPN client supports NAT traversal.
- RTSP** Allows applications that uses Real Time Streaming Protocol (RTSP) to receive streaming media from the Internet.
- SIP** Allows devices and applications using VoIP (Voice over IP) to communicate across NAT. Some VoIP applications and devices have the ability to discover NAT devices and work around them. This ALG may interfere with the operation of such devices. If you are having trouble making VoIP calls, try turning this ALG off.



Firewall Settings - IPv4/IPv6 Rules

In the Features menu on the bar at the top of the page, click **Firewall** to configure the router's firewall settings, then click the **IPv4 Rules** link or the **IPv6 Rules** link to configure what kind of traffic is allowed to pass through the network.

To configure the Firewall Advanced settings, click the **Advanced** link. Refer to **Firewall Settings - Advanced** on page **87**

Click **Save** at any time to save the changes you have made on this page.

To begin, use the drop-down menu to select whether you want to **ALLOW** or **DENY** the rules you create. You can also choose to turn filtering **OFF**.

If you wish to remove a rule, click on the trash can icon in the Delete column. If you wish to edit a rule, click on the pencil icon in the Edit column. If you wish to create a new rule, click the **Add Rule** button.

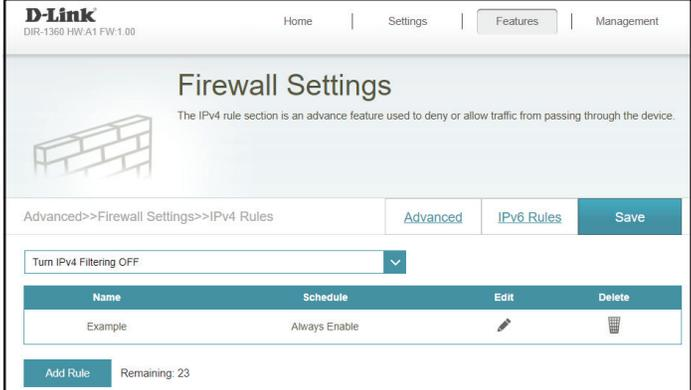

The screenshot shows the D-Link Firewall Settings page for IPv4 Rules. The page title is "Firewall Settings" and it includes a sub-header "The IPv4 rule section is an advance feature used to deny or allow traffic from passing through the device." The page is divided into sections for "Advanced", "IPv6 Rules", and "Save". A dropdown menu is set to "Turn IPv4 Filtering OFF". Below this is a table with columns for Name, Schedule, Edit, and Delete. The table contains one row with the name "Example", schedule "Always Enable", and icons for edit and delete. At the bottom, there is an "Add Rule" button and a "Remaining: 23" indicator.

Name	Schedule	Edit	Delete
Example	Always Enable		

If you clicked on **Edit** or **Add Rule**, the following options will appear:

- Name** Enter a name for the rule.
- Source IP Address Range** Enter the source IP address range that the rule will apply to. Using the drop-down menu, specify whether it is a **WAN** or **LAN** IP address.
- Destination IP Address Range** Enter the destination IP address range that the rule will apply to. Using the drop-down menu, specify whether it is a **WAN** or **LAN** IP address.
- Protocol & Port Range** Select the protocol of the traffic to allow or deny (**Any, TCP, or UDP**) and then enter the range of ports that the rule will apply to.
- Schedule** Use the drop-down menu to select the time schedule that the rule will be enabled for. The schedule may be set to **Always Enable**, or you can create your own schedules in the **Schedules** section. Refer to **Time & Schedule - Schedule** on page **101** for more information.

Port Forwarding

In the Features menu on the bar at the top of the page, click **Port Forwarding** to specify a port or range of ports to open for specific devices on the network. This might be necessary for certain applications to connect through the router.

To configure the Virtual Server settings, click the **Virtual Server** link. Refer to **Port Forwarding - Virtual Server** on page **93**

Click **Save** at any time to save the changes you have made on this page.

If you wish to remove a rule, click on the trash can icon in the Delete column. If you wish to edit a rule, click on the pencil icon in the Edit column. If you wish to create a new rule, click the **Add Rule** button.

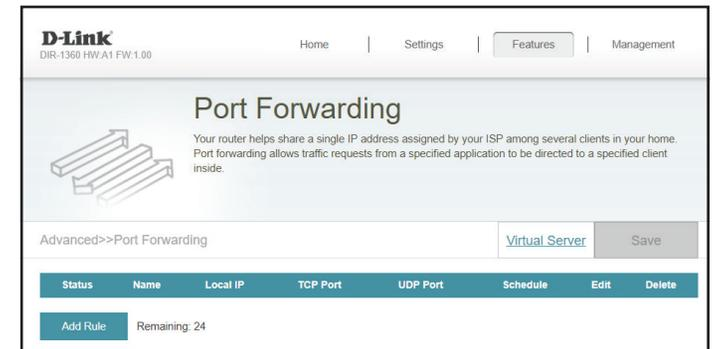

If you clicked on **Edit** or **Add Rule**, the following options will appear:

- Name** Enter a name for the rule.
- Local IP** Enter the IP address of the computer on your local network that you want to allow the incoming service to. Alternatively, select the device from the drop-down menu.
- TCP Port** Enter the TCP ports that you want to open. You can enter a single port or a range of ports. Separate ports with a comma (for example: 24,1009,3000-4000).
- UDP Port** Enter the UDP ports that you want to open. You can enter a single port or a range of ports. Separate ports with a comma (for example: 24,1009,3000-4000).
- Schedule** Use the drop-down menu to select the time schedule that the rule will be enabled for. The schedule may be set to **Always Enable**, or you can create your own schedules in the **Schedules** section. Refer to **Time & Schedule - Schedule** on page **101** for more information.



The screenshot shows a 'Create New Rule' dialog box with the following fields and options:

- Name:** A text input field.
- Local IP:** A text input field and a drop-down menu showing '<< Computer Name'.
- TCP Port:** A text input field.
- UDP Port:** A text input field.
- Schedule:** A drop-down menu showing 'Always Enable'.
- Apply:** A teal button at the bottom right.

Port Forwarding - Virtual Server

In the Features menu on the bar at the top of the page, click **Port Forwarding** then click the **Virtual Server** link to configure its settings and specify a single public port on your router for redirection to an internal LAN IP address and Private LAN port. This might be necessary for certain applications to connect through the router.

To configure the Port Forwarding settings, click the **Port Forwarding** link. Refer to **Port Forwarding** on page 91

Click **Save** at any time to save the changes you have made on this page.

If you wish to remove a rule, click on the trash can icon in the Delete column. If you wish to edit a rule, click on the pencil icon in the Edit column. If you wish to create a new rule, click the **Add Rule** button.



If you clicked on **Edit** or **Add Rule**, the following options will appear:

- Name** Enter a name for the rule. Alternatively, select the protocol/ Application Name from the drop-down menu.
- Local IP** Enter the IP address of the computer on your local network that you want to allow the incoming service to. Alternatively, select the device from the drop-down menu.
- Protocol** Select the protocol of the traffic to allow or deny (**TCP, UDP, Both, or Other**).
- Protocol Number** If you entered **Other** above, enter the protocol number.
- External Port** Enter the public port you want to open.
- Internal Port** Enter the private port you want to open.
- Schedule** Use the drop-down menu to select the time schedule that the rule will be enabled for. The schedule may be set to **Always Enable**, or you can create your own schedules in the **Schedules** section. Refer to **Time & Schedule - Schedule** on page **101** for more information.

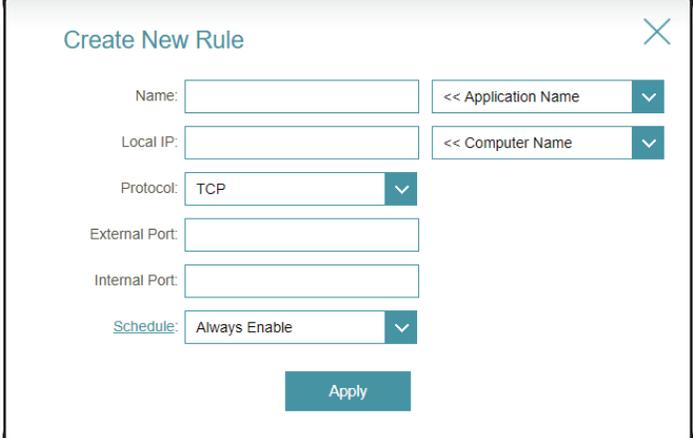

The screenshot shows a 'Create New Rule' dialog box with the following fields and options:

- Name:** A text input field followed by a dropdown menu showing '<< Application Name'.
- Local IP:** A text input field followed by a dropdown menu showing '<< Computer Name'.
- Protocol:** A dropdown menu currently set to 'TCP'.
- External Port:** A text input field.
- Internal Port:** A text input field.
- Schedule:** A dropdown menu currently set to 'Always Enable'.
- Apply:** A teal button at the bottom right.

Static Route - IPv4

In the Features menu on the bar at the top of the page, click **Static Route** to define custom routes, controlling how data traffic is moved around your network.

To configure the Static Route IPv6 settings, click the **IPv6** link. Refer to **Static Route - IPv6** on page **96**

Click **Save** at any time to save the changes you have made on this page.

If you wish to remove a route, click on the trash can icon in the Delete column. If you wish to edit a route, click on the pencil icon in the Edit column. If you wish to create a new route, click the **Add Route** button.

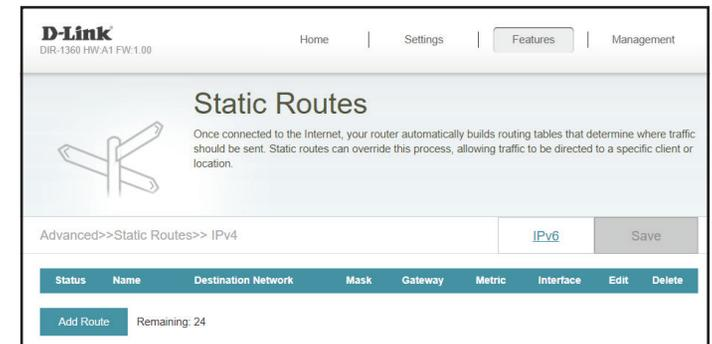

If you clicked on **Edit** or **Add Rule**, the following options will appear:

- Name** Enter a name for the rule.
- Destination Network** Enter the IP address of packets that will take this route.
- Mask** Enter the subnet mask of the route.
- Gateway** Enter your next hop gateway to be taken when this route is used.
- Metric** Enter a route metric value ranging from **0** to **15**. This value indicates the cost of using this route.
- Interface** Select the interface that the IP packet must use to transit out of the router when this route is used.

Static Route - IPv6

In the Features menu on the bar at the top of the page, click **Static Route** to access the IPv4 Static Route settings, then click **IPv6** to configure the IPv6 Static Routes.

To configure the Static Route IPv4 settings, click the **IPv4** link. Refer to **Static Route - IPv4** on page **95**

Click **Save** at any time to save the changes you have made on this page.

If you wish to remove a route, click on the trash can icon in the Delete column. If you wish to edit a route, click on the pencil icon in the Edit column. If you wish to create a new route, click the **Add Route** button.

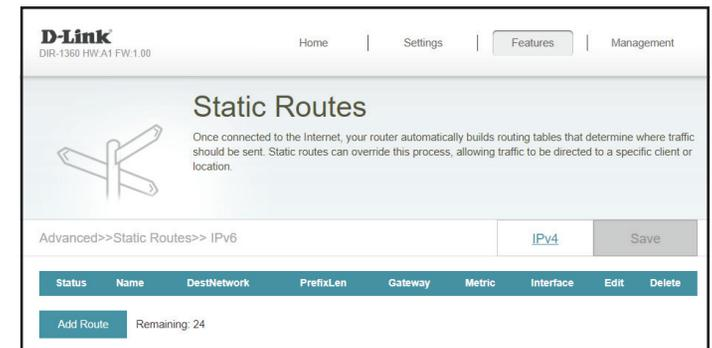

If you clicked on **Edit** or **Add Rule**, the following options will appear:

- Name** Enter a name for the rule.
- DestNetwork** This is the IP address of the router used to reach the specified destination.
- PrefixLen** Enter the IPv6 address prefix length of the packets that will take this route.
- Gateway** Enter your next hop gateway to be taken when this route is used.
- Metric** Enter a route metric value ranging from **0** to **15**. This value indicates the cost of using this route.
- Interface** Select the interface that the IP packet must use to transit out of the router when this route is used.

Dynamic DNS

In the Features menu on the bar at the top of the page, click **Dynamic DNS**. This setting allows your router to associate an easy-to-remember domain name such as [YourDomainName].com with the regularly changing IP address assigned by your Internet Service provider. This feature is helpful when running a virtual server.

Click **Save** at any time to save the changes you have made on this page.

- Enable Dynamic DNS** Enable or disable dynamic DNS. Enabling this feature will reveal further configuration options.
- Status** Displays the current dynamic DNS connection status.
- Server Address** Enter the address of your dynamic DNS server, or select one from the drop-down menu.
- Host Name** Enter the host name that you registered with your dynamic DNS service provider.
- User Name** Enter your dynamic DNS username.
- Password** Enter your dynamic DNS password.
- Time Out** Enter a time out time (in hours).

The screenshot shows the D-Link Dynamic DNS configuration interface. At the top, there is a navigation bar with 'Home', 'Settings', 'Features', and 'Management'. The main heading is 'Dynamic DNS'. Below the heading, there is a description: 'Dynamic Domain Name Service allows your router to associate an easy-to-remember domain name such as [YourDomainName].com with the regularly changing IP address assigned by your Internet Service provider. This feature is helpful when running a virtual server.' A callout box points to the 'http://Betty.dlink.com' link.

The configuration section includes:

- Enable Dynamic DNS:** A toggle switch set to 'Enabled'.
- Status:** Disconnected.
- Server Address:** A text input field containing 'dlinkddns.com' and a dropdown menu also showing 'dlinkddns.com'.
- Host Name:** An empty text input field.
- User Name:** An empty text input field.
- Password:** A text input field with masked characters (dots).
- Time Out:** A text input field containing '24' and the unit 'hours'.

At the bottom, there is a table with columns: Status, Host Name, IPv6 Address, Edit, and Delete. Below the table, there is a button 'Add Record' and the text 'Remaining: 10'.

At the bottom of the page are the IPv6 host settings.

If you wish to remove a record, click on the trash can icon in the Delete column. If you wish to edit a record, click on the pencil icon in the Edit column. If you wish to create a new record, click the **Add Record** button.

Host Name Enter the host name that you registered with your dynamic DNS service provider.

IPv6 Address Enter the IPv6 address of the dynamic DNS server. Alternatively, select the server device in the drop-down menu.

Status	Host Name	IPv6 Address	Edit	Delete
Add Record	Remaining: 10			

Create New Record ✕

Host Name:

IPv6 Address: << Computer Name ▾

Quick VPN

In the Features menu on the bar at the top of the page, click **Quick VPN**. This page will help you configure the Quick VPN feature of your router. For more information, refer to **Quick VPN** on page **142**. Before proceeding, ensure that your Internet connection is working properly. We recommend configuring Dynamic DNS before proceeding with Quick VPN setup. If your router is assigned an IP address from your ISP using DHCP, it may frequently change, requiring clients credentials to be set up again and a simple DDNS address will be easier than an IP address.

To configure the User settings and create, manage, and delete user accounts with user-defined access to certain router services, click the **User** link. Refer to **User** on page **106**

Click **Save** at any time to save the changes you have made on this page.

- L2TP over IPSec** Enable or disable the Quick VPN server.
- Username** Enter a username between 1 and 20 characters.
- Password** Enter a password between 1 and 20 characters.
- PSK** Enter a passkey between 6 and 64 characters.

VPN Profile for iOS Device and MAC OS X Click export to save the VPN profile settings file for iOS devices or Mac OS X.

Advanced Settings...

- Authentication Protocol** Choose the authentication protocol type: **MSCHAPv2**, **PAP**, or **CHAP**. **MSCHAPv2** is the default.
- MPPE** Select the encryption cipher strength: **None**, **RC4-40**, or **RC4-128**. **RC4-128** is the default.

The screenshot displays the D-Link Quick VPN configuration interface. At the top, there are navigation links for Home, Settings, Features, and Management. The main heading is 'Quick VPN' with a sub-description: 'Quickly and easily create a profile for secure remote access to a Local Area Network (LAN). This profile can be used to configure other devices to connect to your LAN via a secure VPN tunnel.' Below this, there are 'User' and 'Save' buttons. The 'General' section contains a toggle for 'L2TP over IPSec' (set to 'Enabled'), input fields for 'Username' (vpn), 'Password' (vpn), and 'PSK' (dyBjE70502), and an 'Export' button for the 'VPN Profile for iOS Device and Mac OS X'. The 'Advanced' section shows dropdown menus for 'Authentication Protocol' (MSCHAPv2) and 'MPPE' (None).

Management

Time & Schedule - Time

In the Management menu on the bar at the top of the page, click **Time & Schedule**. The **Time** page allows you to configure, update, and maintain the correct time on the internal system clock. From here you can set the time zone and the Network Time Protocol (NTP) server.

To configure the Schedule settings, click the **Schedule** link. Refer to **Time & Schedule - Schedule** on page 101

Click **Save** at any time to save the changes you have made on this page.

Time Configuration

Time Zone Select your time zone from the drop-down menu.

Time Displays the current date and time of the router.

The screenshot shows the D-Link router's web interface for Time Configuration. At the top, there are navigation links for Home, Settings, Features, and Management. The main heading is 'Time', with a sub-heading explaining that the device's internal clock is used for time-sensitive applications and can be synchronized with a public time server. Below this, there are two tabs: 'Schedule' and 'Save'. The 'Time Configuration' section includes a 'Time Zone' dropdown menu set to 'Asia/Taipei' and a 'Time' display showing '2018/11/02 10:48:14 AM'. The 'Automatic Time Configuration' section has an 'NTP Server' dropdown menu currently set to 'D-Link NTP Server'.

Automatic Time Configuration

NTP Server Select from the drop-down menu to either use the D-Link NTP Server to synchronize the time and date for your router, or choose Manual to set the NTP server's IP address.

The screenshot shows the 'Automatic Time Configuration' section of the D-Link router's web interface. It features an 'NTP Server' dropdown menu with 'Manual' selected. Below the dropdown, there is an input field for the IP address, which is currently empty and has a red border. A red error message 'Please enter an IP address.' is displayed below the input field.

Time & Schedule - Schedule

In the Management menu on the bar at the top of the page, click **Time & Schedule** to access the Time page, then click the **Schedule** link. The **Schedule** page allows you to control some of the router functions through a pre-configured schedule.

To configure the Time settings, click the **Time** link. Refer to **Time & Schedule - Time** on page 100

Click **Save** at any time to save the changes you have made on this page.

If you wish to remove a schedule, click on the trash can icon in the Delete column. If you wish to edit a schedule, click on the pencil icon in the Edit column. If you wish to create a new schedule, click the **Add a Schedule** button.

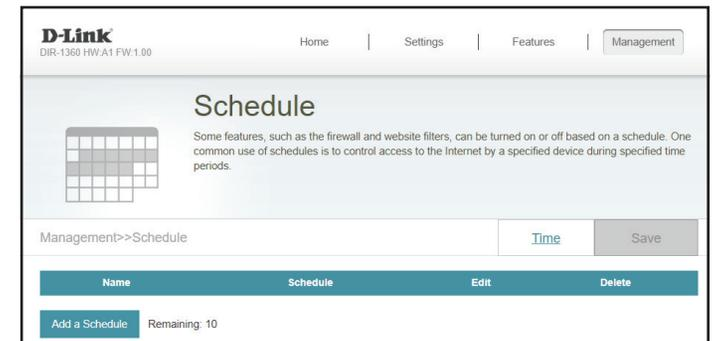

First, enter the name of your schedule in the **Name** field.

Each box represents one hour, with the time at the top of each column. To add a time period to the schedule, simply click on the starting hour and drag to the ending hour. You can add multiple days to the schedule, but only one period per day.

To remove a time period from the schedule, click on the cross icon.

Click **Apply** when you are done.

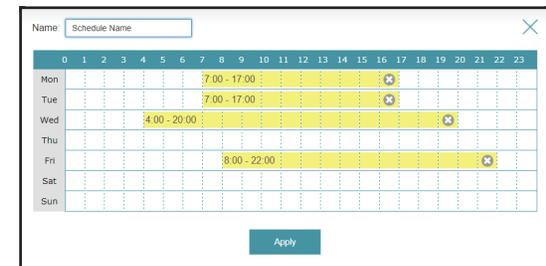
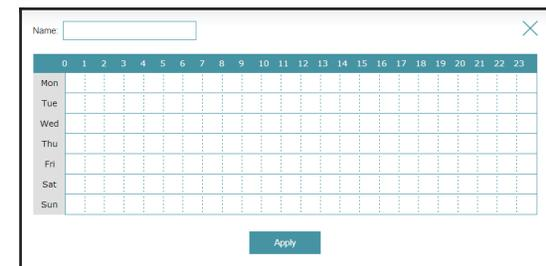

System Log

In the Management menu on the bar at the top of the page, click **System Log**. The router keeps a running log of events. This log can be sent to a Syslog server, or sent to your email address.

Click **Save** at any time to save the changes you have made on this page.

Log Settings

System Log

Click the **Check System Log** button to download a text file containing the system log.

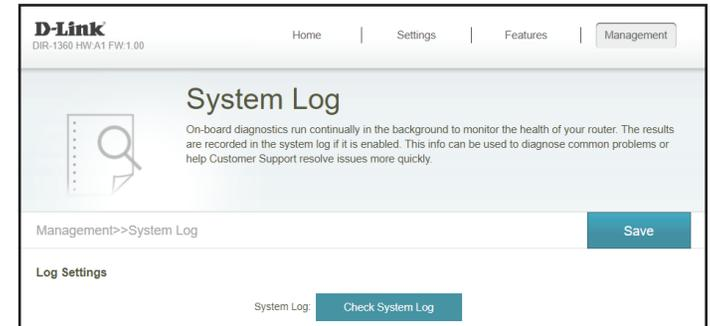

SysLog Settings

Enable Logging to Syslog Server

Check this box to send the router logs to a SysLog Server.

SysLog Server IP Address

Configurable if **Enable Logging to Syslog Server** is enabled. Enter the IP address for the Syslog server. If the Syslog server is connected to the router, select it from the drop-down menu to automatically populate the field.



Email Settings

Enable E-mail Notification Enable this option if you want the logs to be automatically sent to an email address.

If you enabled **Enable E-mail Notification**, the following options will appear:

From E-mail Address Enter the email address your SysLog messages will be sent from.

To E-mail Address Enter the email address your SysLog messages will be sent to.

SMTP Server Address Enter your SMTP server address.

SMTP Server Port Enter your SMTP server port.

Enable Authentication Check this box if your SMTP server requires authentication.

Account Name Enter your SMTP account name.

Password Enter your SMTP account's password.

E-mail Log When Full or On Schedule

Send When Log Full If enabled, this option will set the router to send the log when it is full.

Send on Schedule If enabled, this option will set the router to send according to a set schedule.

Schedule If you enable Send On Schedule, use the drop-down menu to select a schedule to apply. The schedule may be set to Always Enable, or you can create your own schedules in the Schedules section. Refer to **Time & Schedule - Schedule** on page **101** for more information.

System Admin - Admin

In the Management menu on the bar at the top of the page, click **System Admin** to access the Admin page. This page will allow you to change the administrator (Admin) password.

To configure the System settings, click the **System** link. Refer to **System Admin - System** on page 105

Click **Save** at any time to save the changes you have made on this page.

Password Enter a new password for the administrator account. You will need to enter this password whenever you configure the router using a web browser or the D-Link Wi-Fi app.

Status LED Turn the LED status lights on or off.

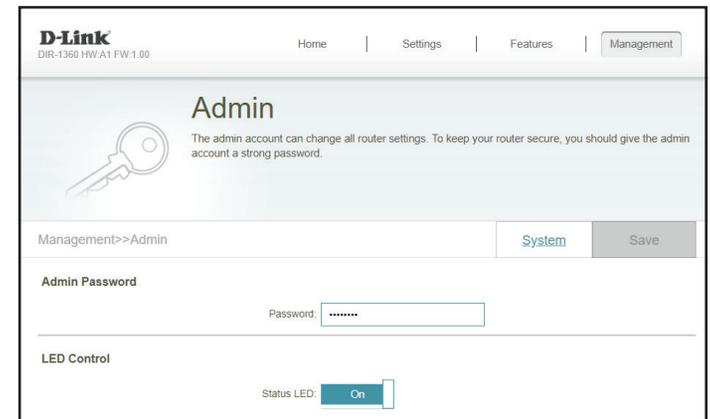

System Admin - System

In the Management menu on the bar at the top of the page, click **System Admin** to access the Admin page, then click **System**. This page allows you to save the router's current configuration, load a previously saved configuration, reset the router to its factory default settings, or reboot the router.

To configure the Admin settings, click the **Admin** link. Refer to **System Admin - Admin** on page 104

Click **Save** at any time to save the changes you have made on this page.

System

Save Settings to Local Hard Drive

This option will save the current router configuration settings to a file on your computer.

Load Settings from Local Hard Drive

This option will load a previously saved router configuration file. This will overwrite the router's current configuration.

Restore to Factory Default Settings

This option will restore the router back to the default configurations stored in the firmware. Any settings that have not been saved will be lost, including any rules that you have created. If you want to save the current router configuration settings, use the **Save Settings To Local Hard Drive** button above.

Auto Reboot Configuration

Reboot the Device

Click to reboot the router immediately.

Auto Reboot

You may set the router to automatically reboot at a set time. The options are **Never**, **Daily**, or **Weekly**. You may set the hour, the minute, and the day you wish to have the router automatically reboot at.

The screenshot shows the D-Link System Admin interface. At the top, there is a navigation bar with 'Home', 'Settings', 'Features', and 'Management'. The main heading is 'System' with a sub-heading 'DIR-1360 HW:V1 FW:1.00'. Below the heading, there is a gear icon and a paragraph: 'This page lets you save your router's current settings to a file, restore your settings from a file, restore your router to factory default settings, or reboot the device. Please note that restoring the settings to the factory defaults will erase all settings, including any rules you have created.' There are two tabs: 'Admin' (selected) and 'Save'. The 'System' section contains three buttons: 'Save' for 'Save Settings To Local Hard Drive', 'Select File' for 'Load Settings From Local Hard Drive', and 'Restore' for 'Restore To Factory Default Settings'. Below this is the 'Auto Reboot Configuration' section with a 'Reboot' button and an 'Auto Reboot' dropdown menu set to 'Never'.

This screenshot shows the 'Auto Reboot Configuration' section with 'Auto Reboot' set to 'Daily'. It includes a 'Reboot' button and a 'Time' field set to '12 AM' with a '00' minute field and '(Hour/ Minute)' label.

This screenshot shows the 'Auto Reboot Configuration' section with 'Auto Reboot' set to 'Weekly'. It includes a 'Reboot' button, a 'Day of week' dropdown set to 'Mon', and a 'Time' field set to '12 AM' with a '00' minute field and '(Hour/ Minute)' label.

User

In the Management menu on the bar at the top of the page, click **User**. The User section is used to create, manage, and delete user accounts with user-defined access to certain router services.

Click **Save** at any time to save the changes you have made on this page.

If you wish to remove a user, click on the trash can icon in the Delete column. If you wish to edit a user, click on the pencil icon in the Edit column. If you wish to create a new user, click the **Create User** button.

Status	Name	SAMBA	FTP	VPN	Export VPN Profile (iOS/Mac OS X)	Edit	Delete
	Admin	Read/Write	Read/Write	-	-	-	-

Create User Remaining: 9

User Name Enter a username for the new user account.

Password Enter a password for the new user account.

SAMBA

Status Enable or disable the Windows file sharing function for this user, allowing connected clients access to media files over the network.

Permission If **SAMBA** is enabled, choose to assign either **Read Only** or **Read/Write** permission.

Folder Click **Browse** to select the folder you want to share.

FTP

Status Enable or disable FTP server access for this user.

Permission If **FTP** is enabled, choose to assign either **Read Only** or **Read/Write** permission.

Folder Click **Browse** to select the folder you want to share.

VPN

Status Enable or disable Virtual Private Network (VPN) functionality for this user.

Create New User ✕

User Name:

Password:

SAMBA

Status: Enabled

Permission: ▼

Folder:

FTP

Status: Disabled

Permission: ▼

Folder:

VPN

Status: Disabled

Upgrade

In the Management menu on the bar at the top of the page, click **Upgrade**. This page will allow you to upgrade the router's firmware, either automatically or manually. To manually upgrade the firmware, you must first download the relevant file from <http://support.dlink.com>.

Click **Save** at any time to save the changes you have made on this page.

Firmware

Current Firmware Version The current firmware's version will be displayed.

Check for New Firmware Click this button to prompt the router to automatically check for a new firmware version. If a newer version is found, it will prompt you to install it.

Automatic Firmware Upgrade

Automatic Upgrade If enabled, the router will automatically check for and upgrade to the newest firmware.

Choose Upgrade Time Enable this function to set the router to automatically upgrade its firmware at a set time.

Upgrade Time Configurable if **Choose Upgrade Time** is enabled. Set the hour and minute to automatically upgrade by using the drop-down menus.

Upgrade Firmware

Upgrade Firmware If you wish to upgrade manually, first download the firmware file you wish to upgrade to. Next, click the **Select File** button and browse to the file to install the new firmware.

The screenshot displays the 'Upgrade' page in the D-Link management interface. At the top, there is a navigation bar with 'Home', 'Settings', 'Features', and 'Management' tabs. The main heading is 'Upgrade', accompanied by a circular arrow icon with 'FW' inside. Below the heading, a brief description states: 'Your device can automatically detect firmware updates, but requires your authorization to install them. You can also check for new firmware manually, and upgrade it from a local file. Firmware may use code that is subject to the GPL licenses. For more information, visit <http://tsd.dlink.com.tw/GPL.asp>.' A 'Save' button is located to the right of this text.

The 'Firmware' section shows 'Current Firmware Version: 1.00' and a 'Check for New Firmware' button. The 'Automatic Firmware Upgrade' section has 'Automatic Upgrade' set to 'Enabled' (indicated by a blue bar) and a sub-note: 'Update my device automatically every day at 3:30-4:00 AM to always enjoy the latest improvements and features.' Below this, 'Choose Upgrade Time' is set to 'Disabled'. The 'Upgrade Time' is configured as '3 AM' and ':30'. The 'Upgrade Manually' section features a 'Select File' button.

Statistics

In the Management menu on the bar at the top of the page, click **Statistics**. On the Statistics page you can view the amount of packets that pass through the router on the Internet, LAN, Wi-Fi 2.4 GHz and Wi-Fi 5GHz networks.

To view the Extender statistics, click the **Extender** link. Refer to **Statistics - Extender** on page **110**

You can view the **Internet**, **LAN**, **Wi-Fi 2.4 GHz**, or **Wi-Fi 5 GHz** by clicking on the respective tabs at the top. The graph will update in real time. To clear the information on the graph, click **Clear** near the top of the page.

The traffic counter will reset if the device is rebooted.

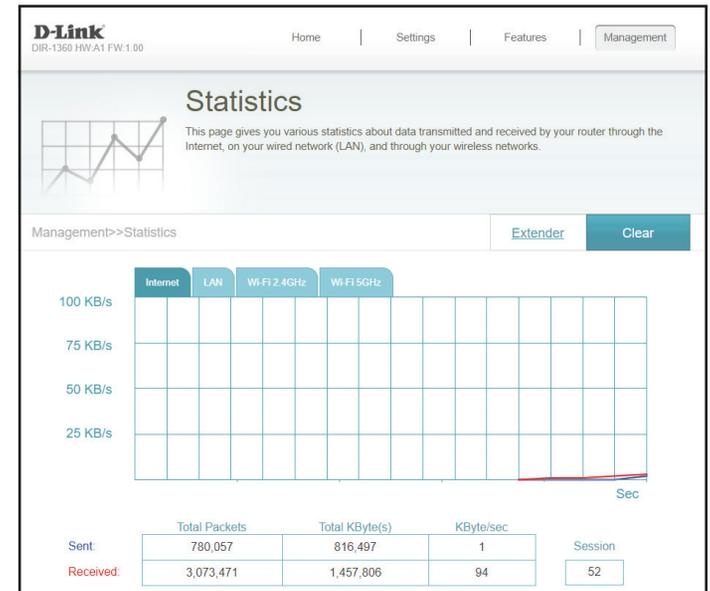

Statistics - Extender

In the Management menu on the bar at the top of the page, click **Statistics** to access the Statistics page, then click **Extender**. This page lets you view the amount of packets that pass through connected extenders.

To view the router's statistics, click the **Router** link. Refer to **Statistics** on page **109**

Click the tabs at the top of the graph to view different extenders if you have more than one connected. The graph will update in real time.

The traffic counter will reset if the device is rebooted.

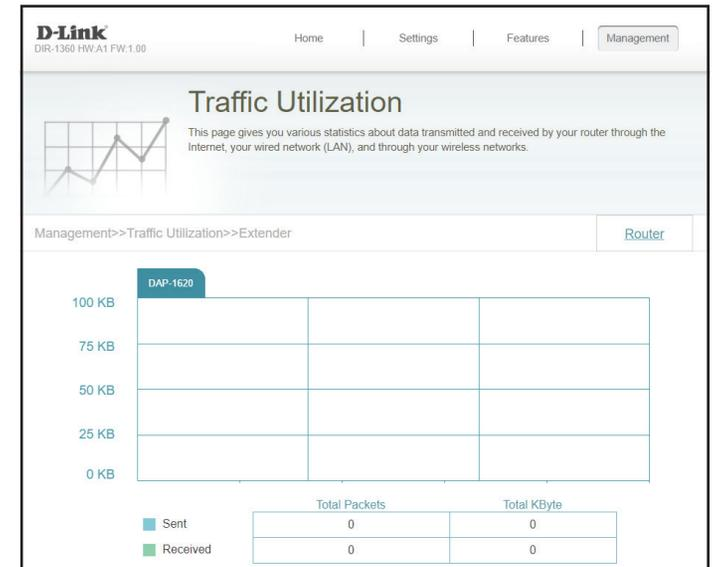

Third Party Services

Connect to the future of intelligent home network control. The EXO Smart Mesh Wi-Fi Routers integrate with your Google Assistant and Alexa, so you can finally manage and control your network without lifting a finger. Whether you want to turn on/off your guest Wi-Fi network, check your network for vulnerabilities, or block unwanted devices, EXO lets you do it all, hands-free.

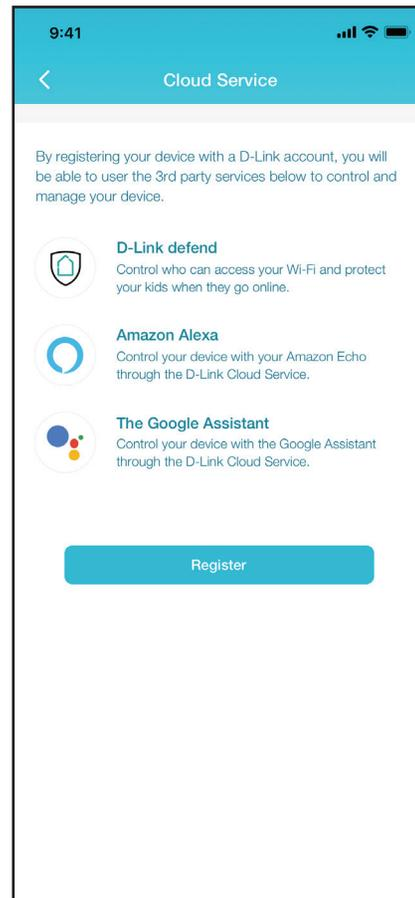

D-Link defend



Registering a D-Link Cloud Service Account

In order to use third party services to control and manage your device, you will first need to register your device with D-Link Cloud Service. Follow the steps below if you do not have a D-Link Cloud Service account.

Step 1

Launch the **D-Link Wi-Fi** app.



D-Link Wi-Fi

Step 2

Tap the settings gear icon on the top right corner of the screen.



Step 3

Tap the **Cloud Service** icon.

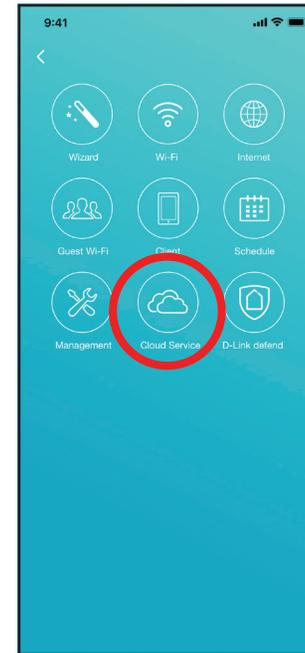

Step 4

Tap the **Register** button.

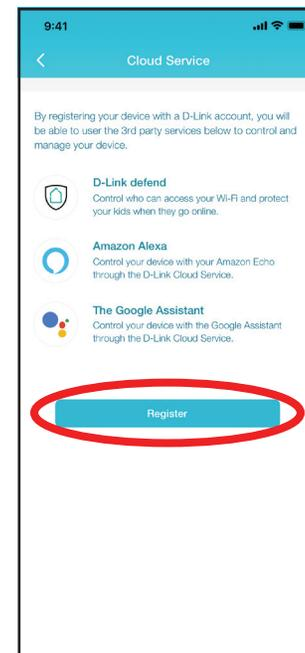

Step 5

In this menu, you can sign up for a D-Link account using Facebook, Google or an Email address. If you already have a D-Link account, you can tap the **Log In** link at the bottom of the screen to be redirected to the login page.

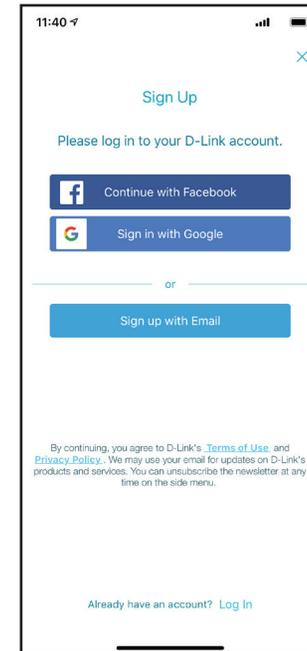

Voice Assistants

With the EXO Series Routers, you can command your router's functionality with your voice through Amazon Alexa and the Google Assistant, enabling you to control your network with voice commands. Features include enabling and disabling your Wi-Fi guest zone without having to go into the UI, rebooting the router and checking your router for firmware upgrades. In order to use third party services to control and manage your device, please register your device with D-Link Cloud Service.

This section will go through how to set up and link your Amazon Alexa or the Google Assistant to D-Link Wi-Fi.

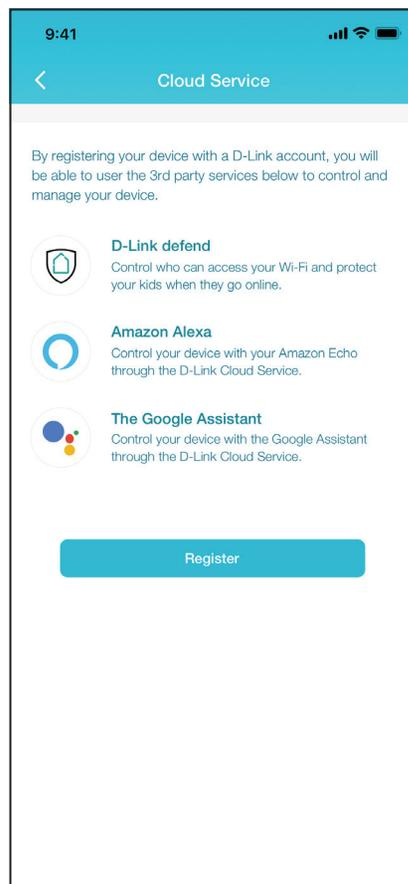

Amazon Alexa Setup

You will need the Amazon Alexa app, an Amazon account, an Amazon Alexa device and a D-Link Cloud Service account to use this feature.

Note: *The screenshots may be different depending on your mobile device's OS version. The following steps show the iOS interface. If you are using an Android device, the appearance may be different from that of the screenshots, but the process is the same.*

Step 1

Launch the **Amazon Alexa** app.

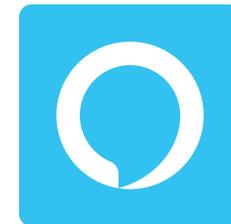

Amazon Alexa

Step 2

Tap the menu icon on the top left-hand corner of the home screen.

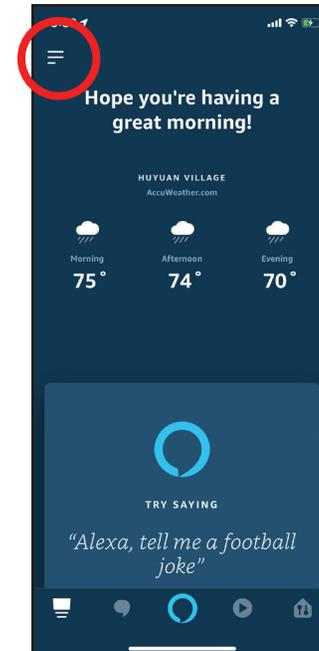

Step 3

Tap on **Skills & Games**.

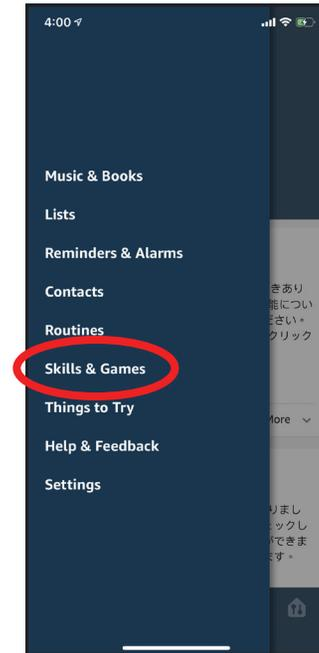

Step 4

Search for "D-Link Wi-Fi". Tap on the search result.

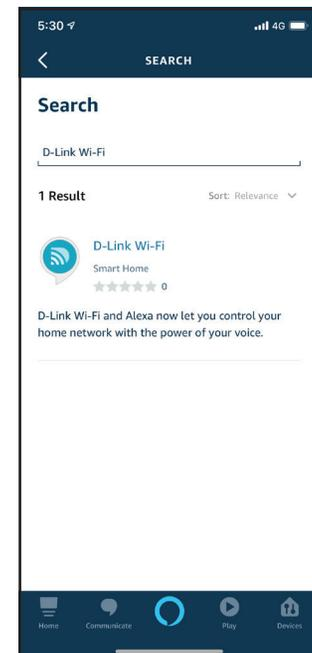

Step 5

Tap **Enable** to link the skill.

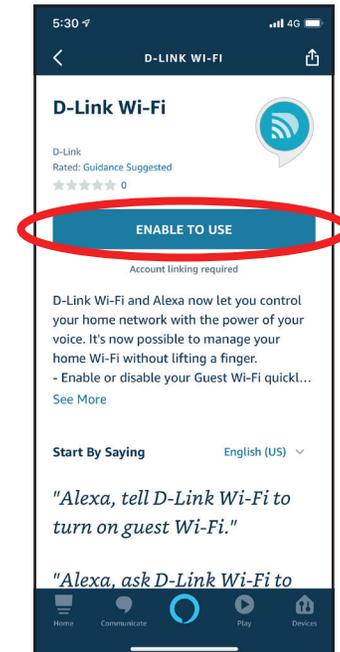

Step 6

Sign in using your D-Link account details.



Step 7

Congratulations! D-Link Wi-Fi has been successfully linked as a skill for your Amazon device. Close the window by tapping **Done** on the top left corner of the screen. Refer to **Amazon Alexa Voice Commands** on page 120 for tasks that you can ask your Amazon Alexa to perform.



Amazon Alexa Voice Commands

With D-Link Wi-Fi enabled as a skill for Alexa, you can ask Alexa to do any of these tasks:

Task	Command
Enable the guest zone.	"Alexa, ask D-Link Wi-Fi to enable my guest zone."
Disable the guest zone.	"Alexa, ask D-Link Wi-Fi to disable my guest zone."
Find out the guest zone credentials.	"Alexa, ask D-Link Wi-Fi what are my guest network credentials."
Reboot the router	"Alexa, ask D-Link Wi-Fi to reboot the router."
Upgrade the router.	"Alexa, ask D-Link Wi-Fi to upgrade my router."

The Google Assistant Setup

You will need the Google Assistant app, a Google account and a D-Link Cloud Service account to use this feature.

Note: *The screenshots may be different depending on your mobile device's OS version. The following steps show the iOS interface. If you are using an Android device, the appearance may be different from that of the screenshots, but the process is the same.*

Step 1

Launch the **Google Assistant** app.



Assistant

Step 2

Tell your Google Assistant to **"Talk to D-Link Wi-Fi."**

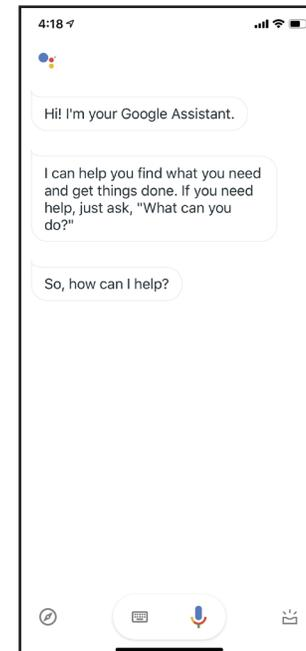

Step 3
Tap **Yes**.

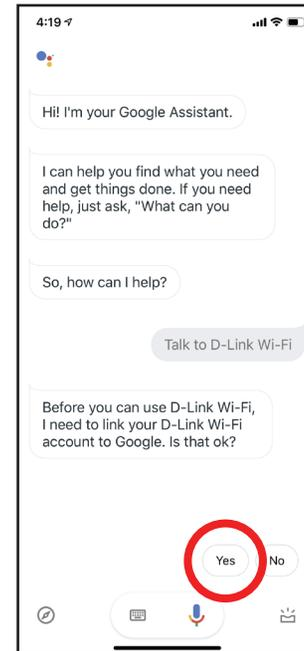

Step 4
Sign in using your D-Link account details.

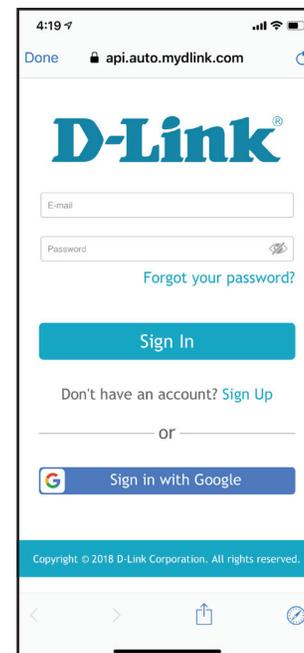

Step 5

Tap **Allow** to continue setup..

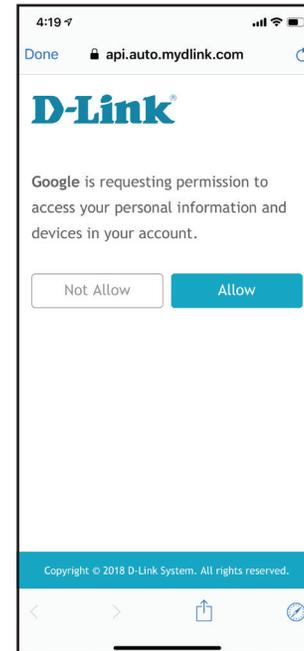

Step 6

Congratulations! D-Link Wi-Fi has been successfully linked to your Google Assistant. Refer to **The Google Assistant Voice Commands** on page 124 for tasks that you can ask your Google Assistant to perform.

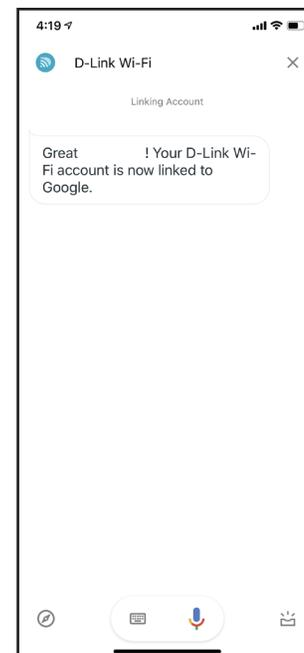

The Google Assistant Voice Commands

With D-Link Wi-Fi enabled as a skill for the Google Assistant, you can ask your Google Assistant to do any of these tasks:

Task	Command
Enable the guest zone.	"OK Google, talk to D-Link Wi-Fi to enable my guest zone."
Disable the guest zone.	"OK Google, talk to D-Link Wi-Fi to disable my guest zone."
Find out the guest zone credentials.	"OK Google, talk to D-Link Wi-Fi to tell me my guest zone credentials."
Reboot the router	"OK Google, talk to D-Link Wi-Fi to reboot the router."
Upgrade the router.	"OK Google, talk to D-Link Wi-Fi to upgrade my router."

D-Link defend

Kick security up a notch with McAfee protection for your network. Keep your kids safe online with age-based profiles and the ability to pause the internet when you need to. All this is part of the comprehensive parental controls offered by the McAfee Secure Home Platform. With the McAfee Secure Home Platform you can also take control of your devices and be the first to know and respond to potentially threatening activity on your network, such as devices trying to connect to malicious addresses, or unidentified devices joining your network. When you are away from home you can also deny any new devices from connecting to your network. The McAfee Secure Home Platform works with Amazon Alexa to give you a new way to command and monitor your home network using your voice. You can scan your network, block devices, and get up to speed on your network notifications - all without lifting a finger.

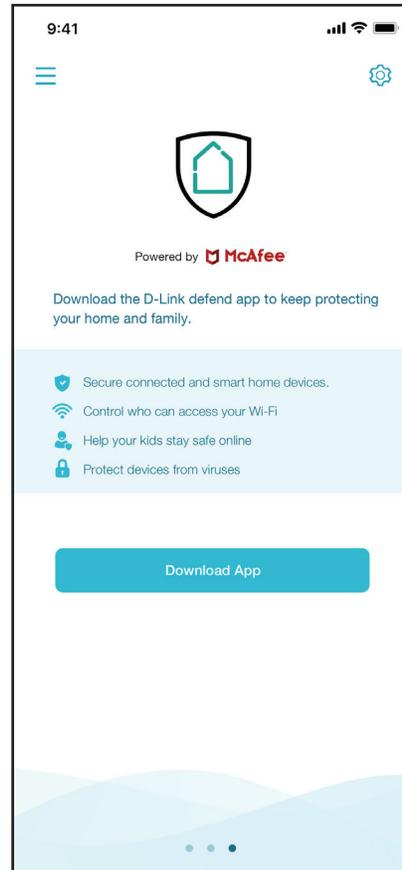

D-Link defend Setup

You will need a D-Link Cloud Service account to enable this third party service.

Note: *The screenshots may be different depending on your mobile device's OS version. The following steps show the iOS interface. If you are using an Android device, the appearance may be different from that of the screenshots, but the process is the same.*

Step 1

Launch the **D-Link Wi-Fi** app.



D-Link Wi-Fi

Step 2

Tap the settings gear icon on the top right corner of the screen.



Step 3

Tap the **D-Link defend** icon.



Step 4

Tap the **Download App** button. The link will direct you to download the app from Google Play or the App Store.

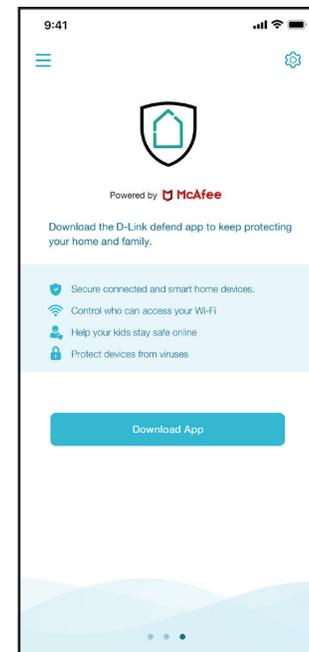

Step 5

After D-Link defend is installed, return to the D-Link Wi-Fi app. Repeat step 2 and 3 to launch D-Link defend.

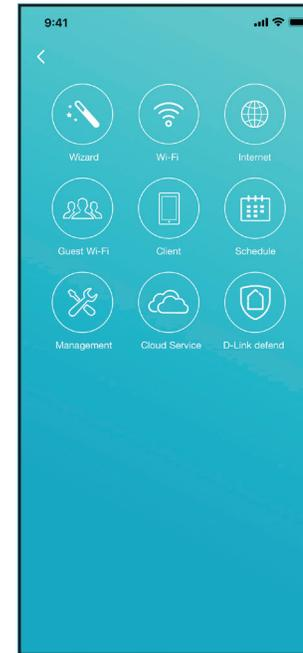

D-Link defend

Step 6

Swipe to go through a short introduction on the features of D-Link defend. Wait while the app connects to your device. Once the connection is established, tap **Let's Go**.



Step 7

Follow the on-screen tips to make your Internet more secure.

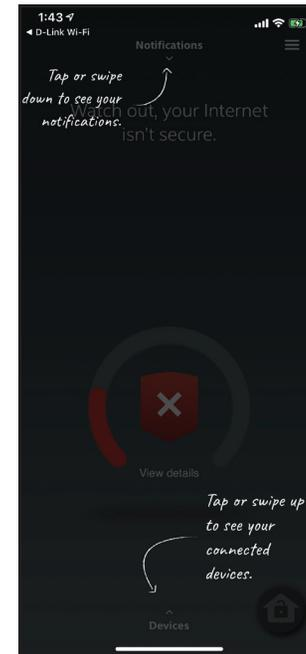

Step 8

Tap  on the home screen to configure more features such as Parental Controls. Tap **Devices** at the bottom of the home screen to configure and set permissions for your connected devices.

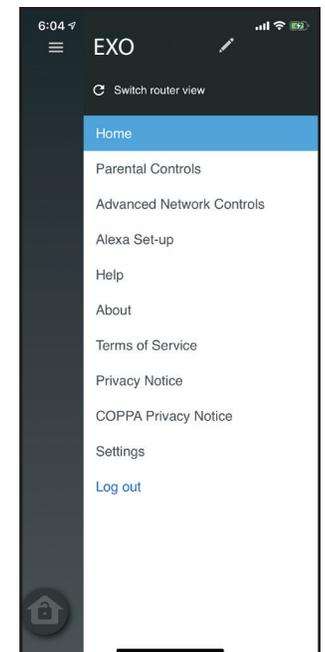
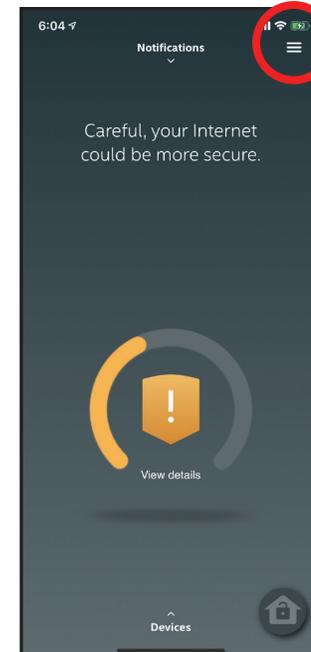

D-Link defend and Amazon Alexa Setup

You will need the Amazon Alexa app, an Amazon account, an Amazon Alexa device and a D-Link Cloud Service account to use this feature.

Note: *The screenshots may be different depending on your mobile device's OS version. The following steps show the iOS interface. If you are using an Android device, the appearance may be different from that of the screenshots, but the process is the same.*

Step 1

Launch the **Amazon Alexa** app.



Amazon Alexa

Step 2

Tap the menu icon on the top left-hand corner of the home screen.

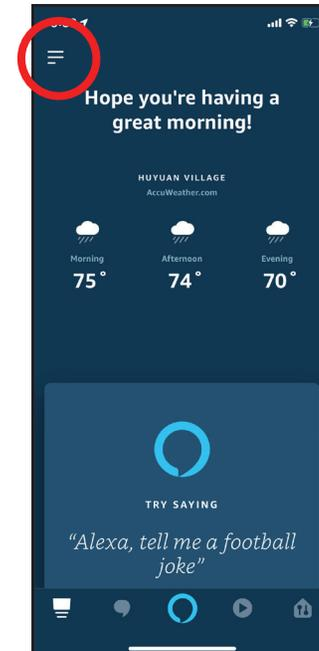

Step 3

Tap on **Skills & Games**.

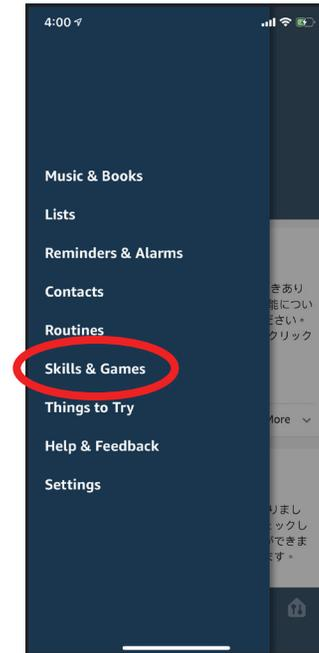

Step 4

Search for "D-Link defend". Tap on the search result.

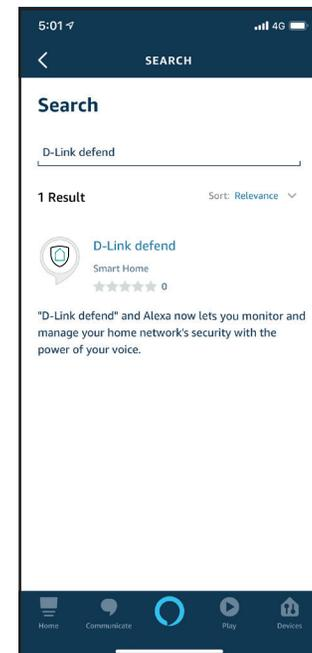

Step 5

Tap **Enable** to link the skill.

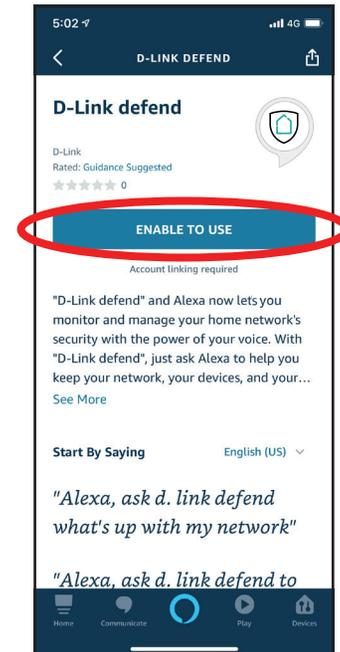

Step 6

Sign in using your D-Link account details.



Step 7

Congratulations! D-Link defend has been successfully linked as a skill for your Amazon device. Close the window by tapping **Done** on the top left corner of the screen. Refer to **D-Link defend and Amazon Alexa Voice Commands** on page **134** for tasks that you can ask your Amazon Alexa to perform.

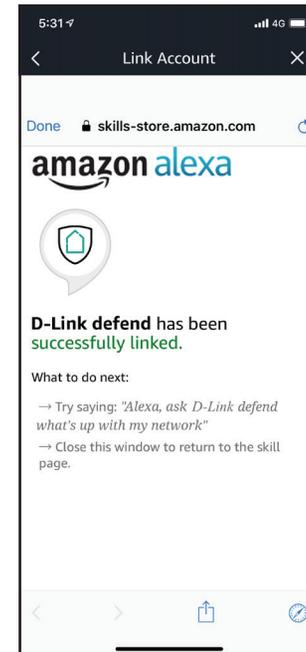

D-Link defend and Amazon Alexa Voice Commands

With D-Link defend enabled as a skill for Alexa, you can ask Alexa to do any of these tasks:

Task	Command
Block a device from accessing the network.	"Alexa, ask D-Link defend to block Jim's iPad."
Check your network summary.	"Alexa, ask D-Link defend what's up with my network."
Find out how many devices are connected to the network.	"Alexa, ask D-Link defend how many devices are online right now."
Get the five latest notifications of what's happening on your network.	"Alexa, ask D-Link defend what notifications I have."
Get the results of a scan.	"Alexa, ask D-Link defend if there are any vulnerabilities found."
Pause the internet for the children.	"Alexa, ask D-Link defend to pause the internet for all kids."
Pause the internet for someone.	"Alexa, ask D-Link defend to pause the internet for Jim."
Restart the internet for everyone.	"Alexa, ask D-Link defend to resume the internet for all kids."
Restart the internet for someone.	"Alexa, ask D-Link defend to resume the internet for Jim."
Scan for vulnerabilities to threats.	"Alexa, ask D-Link defend to start a vulnerability scan."
Set web time rules.	"Alexa, ask D-Link defend to assign web time for Jim."
Switch router.	"Alexa, ask D-Link defend to switch to home router."
Unblock a device from accessing the network.	"Alexa, ask D-Link defend to unblock Jim's iPhone."
Which router am I connected to?	"Alexa, ask D-Link defend which router am I currently managing."

D-Link defend Features

Name the Devices on Your Network

Naming devices that are connected to your Wi-Fi network helps you quickly recognize them and distinguish one from another - especially if you have more than one of any type of device. If you use a virtual assistant in your home it's easier to use voice commands for devices that you've named than it is to use their often cryptic default names.

Manage New Devices

Anytime a new device joins your network, you will receive a notification. If you recognize the new device, consider naming it. If this new device is for a child, you can add it to a "kid profile". This way, it will be governed by the parental controls you set for that child.

Block, Unblock and Forget a Device

The D-Link defend app makes it easy to block, unblock, or forget an individual device on your Wi-Fi network. You may want to block a device you do not recognize or if it's showing suspicious or malicious behavior, or if you want to forget a device that you no longer own.

Set Up and Use Away Mode

Chances are that any network security set up you've done up to this point represents how you want your network to behave while you're home. But do you really need all those connected devices to have access to your network while you're away? Probably not. With a single tap, "Away Mode" allows you to temporarily block Internet access for specific devices on your network that you've defined.

Advanced Network Controls

Advanced Network Controls are critical settings for the security of your router and all devices in your network. By properly configuring these settings, you will be able to lock down your devices so they can't be accessed remotely using Telnet and SSH protocols. These protocols are essentially ways to allow deeper and broader access to your device.

Run a Vulnerability Scan

A common way for a hacker to take control of your connected devices is to log in to them by using well-known default usernames and passwords. If your firmware is out of date, your device could be exposed to security vulnerabilities. The Vulnerability Scan allows you to scan your smart IoT devices for these weaknesses, so you can take steps to fix what is found. It is a good idea to run this scan after installing a new device and connecting it to your network.

Parental Controls

Part of keeping the home network safe for everyone is making sure that kids don't access sites that might technically be "safe", but that contain inappropriate content for children. 'Parental Controls' let you block such sites on kids' devices, as well as set schedules for when each child is permitted to access the Internet, and pause Internet access for one kid or all kids.

D-Link defend Tutorials

Scan the QR codes using a QR reader on your device or copy the links below to access videos on how to use D-Link defend.



Getting Started

https://www.youtube.com/watch?v=fY9qxJ_9nBA



How To Use Away Mode

<https://www.youtube.com/watch?v=TXF0fu3strM>



How To Name Devices

<https://www.youtube.com/watch?v=i9bqnmDMdQ4>



How To Run a Vulnerability Scan

<https://www.youtube.com/watch?v=9as51qZRL5o>



How To Manage New Devices

<https://www.youtube.com/watch?v=CmnmWG3HJJM>



How To Use Parental Controls

<https://www.youtube.com/watch?v=DwJ5aBgoMtw>



How To Block, Unblock & Forget Devices

<https://www.youtube.com/watch?v=7eAU6CYmEic>



How To Use McAfee LiveSafe

<https://www.youtube.com/watch?v=6WzoL614xc0>

Wi-Fi Mesh Setup

D-Link's Wi-Fi Mesh is a scalable solution that allows you to easily increase the coverage of your home or office wireless AC network. Expand your Wi-Fi coverage by adding compatible D-Link access points. Mix and match suitable D-Link devices according to your budget and preferences to fit any floorplan. Setup is effortless; configuration of multiple access points can be done in minutes as settings can be passed on to other access points once the first access point is configured.

Wi-Fi Mesh intelligently finds the shortest/fastest path to your router. So even if you have eight mesh nodes, you can count on Wi-Fi Mesh to push your 4K streaming movies and intense VR games to your device at lightning speeds. Wi-Fi Mesh can also automatically detect malfunctioning nodes and reroute the connection to your working mesh devices.

Please refer to the **Wi-Fi Mesh** on page **73** for Wi-Fi Mesh configuration options.

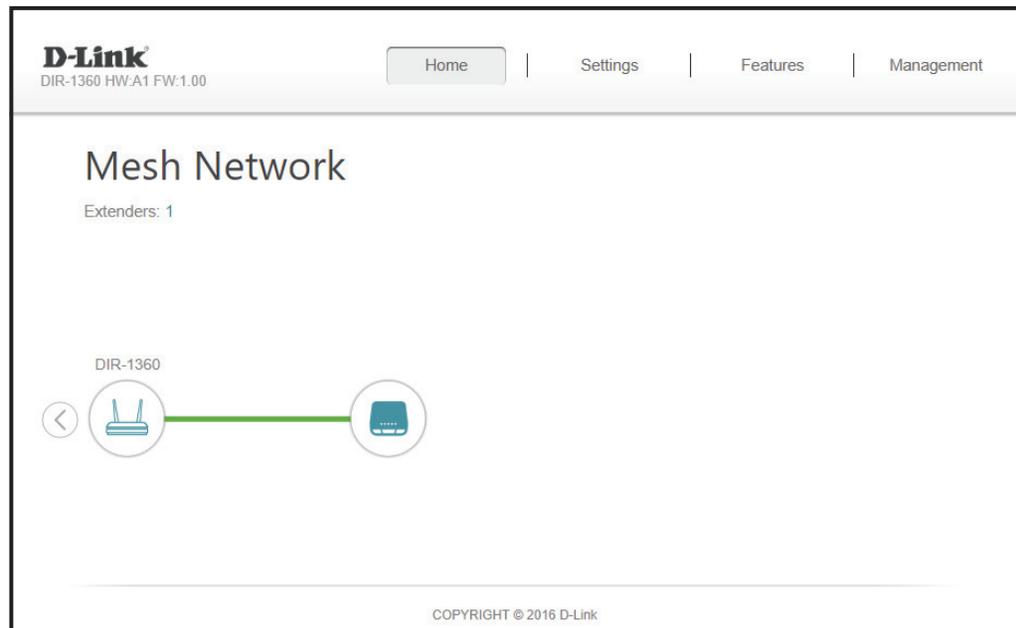

Setup Using an Ethernet Cable

Step 1

Connect and plug in the Wi-Fi Mesh compatible device close to your EXO Series Router and wait for the device to be ready. Refer to the device's manual for behavioural indications.

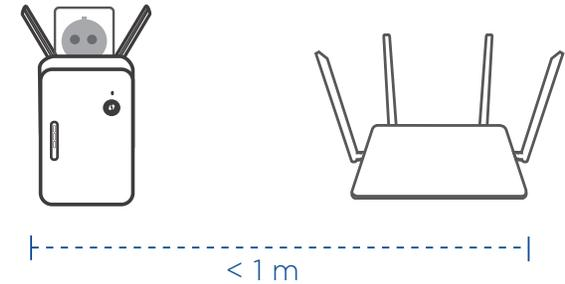

Step 2

Use the Ethernet cable to connect the Wi-Fi Mesh compatible device to one of the LAN ports on the EXO Series Router. Refer to the device's manual for behavioural indications signifying that your device has finished being paired.

Note: Please make sure that the device you are pairing to is in factory default settings prior to initiating the mesh pairing process.

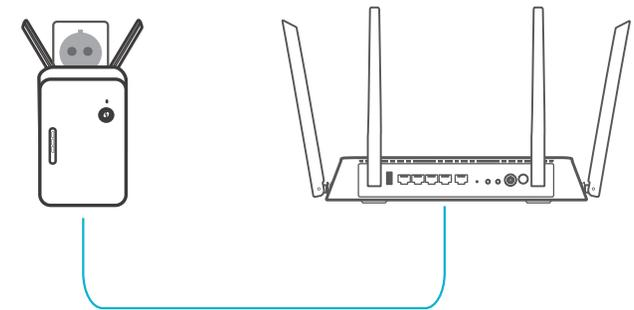

Step 3

Disconnect the Ethernet cable and place the Wi-Fi Mesh compatible device anywhere in your home to extend your whole home Wi-Fi.

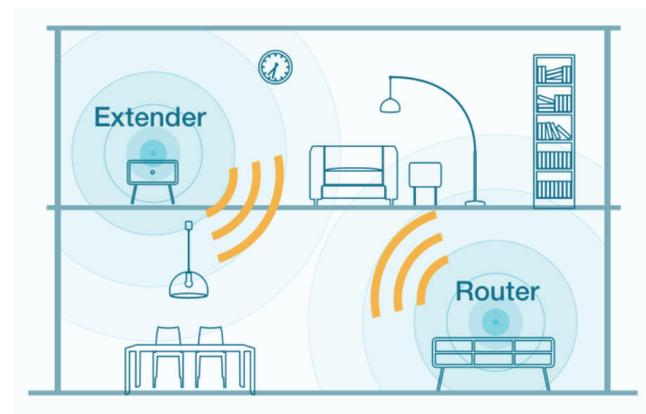

Device Placement Considerations

Wi-Fi Mesh intelligently finds the shortest/fastest path to your router. However, the number, thickness and location of walls, ceilings, or other objects that the wireless signals must pass through may hinder the mesh connection. Therefore, the key to maximizing the power of your mesh system is to follow these basic guidelines:

- If the router and the extender are placed on the same floor, position the extender so that it is facing the router directly forwards or backwards, and not at an angle.
- If the router and the extender are placed on the different floors, do not place the extender directly above or below the router. The optimal angle for the mesh link resides at more than 30 degrees but less than 5 metres away from the vertical line of where the router is.
- Try to position the router and the extender more than 75 cm from the floor and more than 30 cm from a wall.

Bad deployment

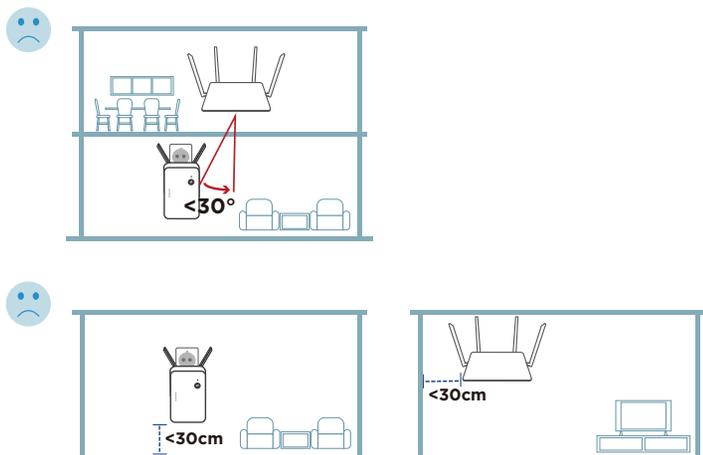

Good deployment

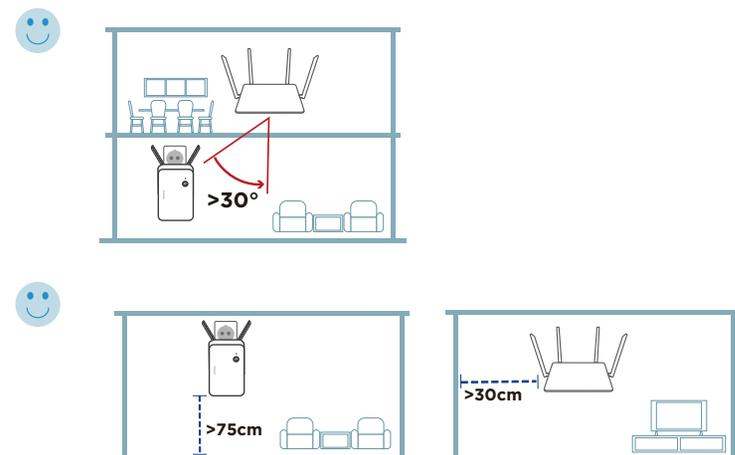

- Building materials make a difference. A solid brick or concrete wall may have a negative effect on the mesh link. Try to position your mesh devices that the signal passes through drywall or open doorways. Materials and objects such as glass, steel, metal, walls with insulation, water (fish tanks), mirrors, file cabinets, brick, and concrete will degrade your mesh link.
- Keep the number of walls and ceilings between the router and the extender to a minimum. Position your devices so that the number of walls or ceilings follow the rules below:
 - If the router and the extender are placed on the same floor, only have one brick or concrete wall between them.
 - If the router and the extender are placed on the different floors, only have one floor between them.
 - If the router and the extender are placed on the same floor, the mesh link can travel through up to 2-3 walls made light compartment materials such as wood.

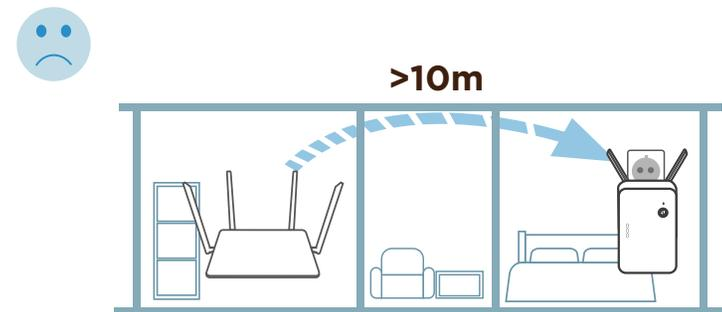
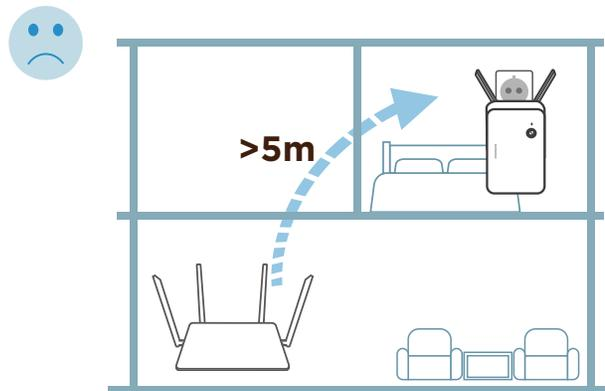

- Place the router so that it is located physically in the centre of the mesh network in order to minimize the number of hops to the router. A topology of **Extender 1 - Router - Extender 2** where the router is in the centre is better than a topology of **Router - Extender 1 - Extender 2** as extender 2 has to go through extender 1 to get to the router.

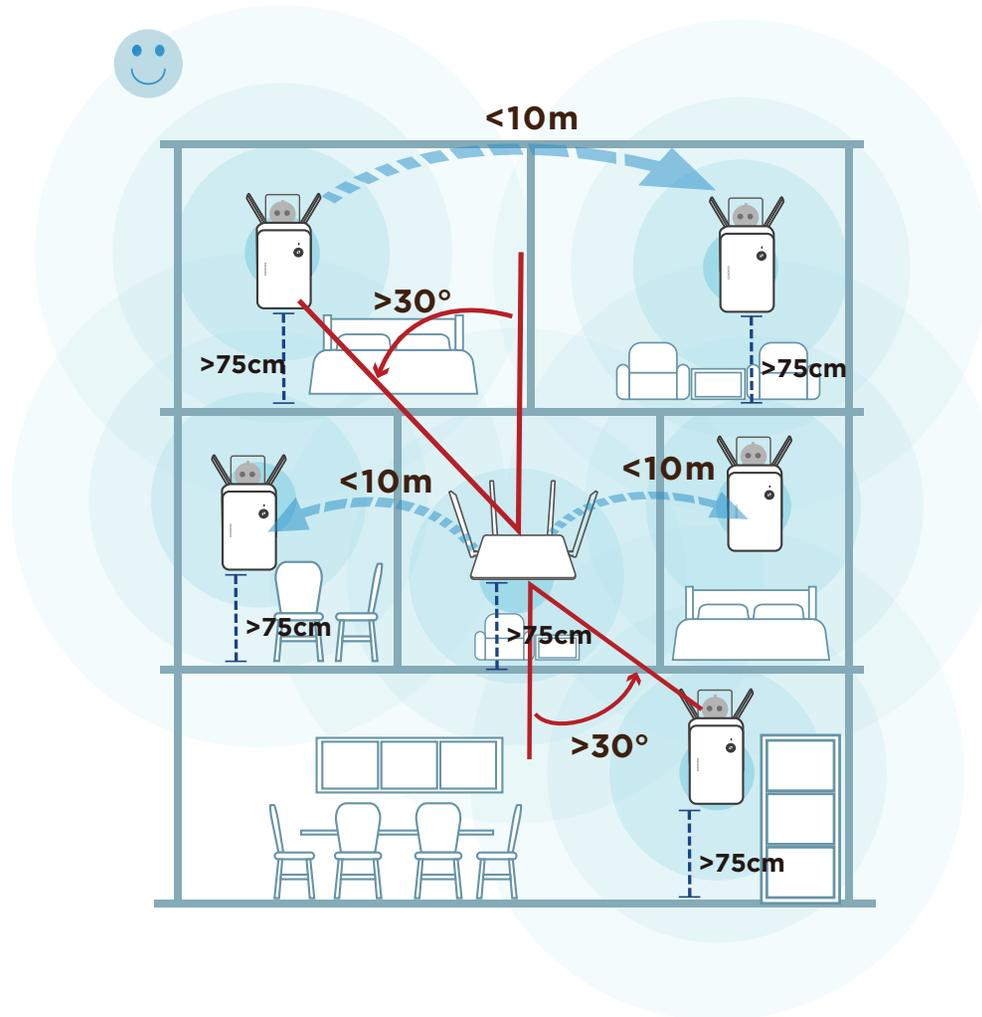

Quick VPN

This router is equipped with D-Link's Quick VPN technology. Virtual Private Networking (VPN) creates a connection between devices across the Internet. Using Quick VPN allows you to securely connect your computer or mobile device to places with free, untrusted Wi-Fi hotspots in places like coffee shops and hotels by encrypting and relaying it through your home Internet connection. This extra 'hop' reduces the chances of hackers stealing your information, such as logins, passwords, and credit card numbers. When traveling, Quick VPN lets you watch sports and use video streaming services without experiencing blackouts or filtering. You can surf the whole Internet unfiltered and unblocked, just as you would at home.

Without Quick VPN



With Quick VPN

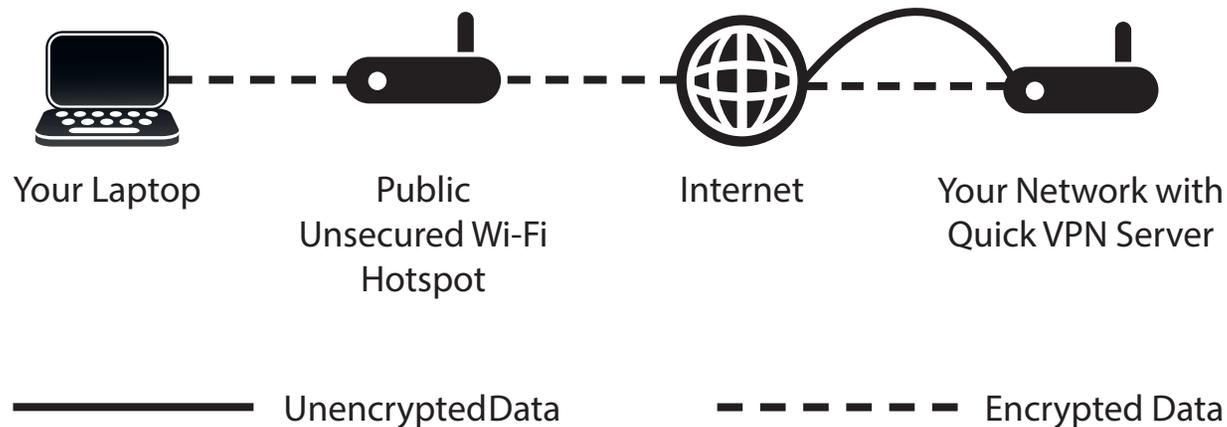

Important Information

The following instructions explain and help you to configure your D-Link Quick VPN enabled router and devices to create a Virtual Private Network (VPN). This feature is provided for advanced users who wish to connect remotely and use their router's Internet connection to add a layer of security while using untrusted networks. Configure the Quick VPN Server on your router first and then set up client devices to connect through your router's WAN connection.

- Quick VPN only provides an added layer of security against specific types of snooping attacks and does not guarantee complete data integrity or protection. Only traffic in the tunnel between your router and device will be encrypted, WAN traffic will leave your D-Link Quick VPN enabled router unencrypted.
- Keep your Quick VPN Username, Password, and Passkey safe. Keep your Quick VPN Username, Password, and Passkey safe. It is recommended that you change these credentials periodically.
- A device connected via Quick VPN tunnel may experience lower data throughput and higher latency due to a number of factors including: Internet conditions, local and remote network Wi-Fi and WAN bandwidth limitations, and increased latency. This may negatively impact real time voice and video communication.
- Quick VPN supports up to five concurrent VPN client sessions using the same login and password are supported. Quick VPN uses L2TP/IPsec with MSCHAPv2, PAP, or CHAP authentication.
- Your device may warn you that your information may be intercepted, since you control the Quick VPN server, you may ignore this.
- UDP Ports 500, 4500, 1701 and IP Port 50 must be open in order for Quick VPN to work.
- L2TP/IPsec VPN usage may be restricted in some countries and on some networks. If you have trouble using Quick VPN on some networks, but not others and are not violating network access rules, try contacting your ISP or network administrator.
- Devices connected via Quick VPN are assigned addresses on a separate subnet (ex. 192.168.1.x). Some network resources may be unavailable when connecting via Quick VPN.
- If your Internet connection uses DHCP, it is strongly recommended that you first set up Dynamic DNS (DDNS), such as D-Link DDNS, to eliminate the need to reconfigure client devices in the event your ISP assigns you a new WAN IP address.

iOS Devices

VPN Setup Instructions

This section provides Quick VPN setup instructions for iOS devices. Refer to **Quick VPN** on page **99** for your router setup instructions.

Go into **Settings** on your compatible iOS device.

Scroll to and tap **General**.

Scroll to and tap **VPN**.

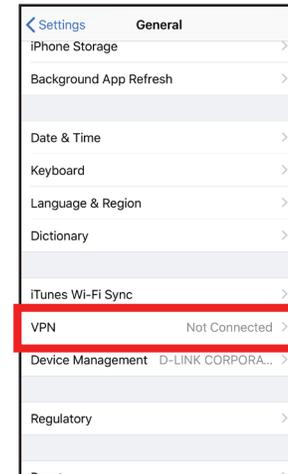

Tap **Add VPN Configuration...**

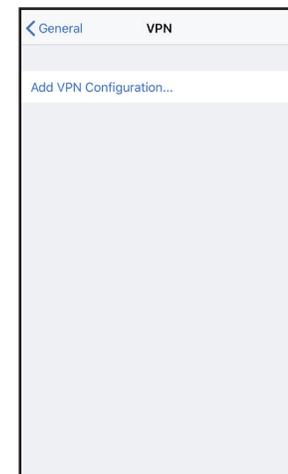

You should see a pop up window asking you to fill out the details of your VPN connection.

Type: Choose **IPSec**. Tap **Back** to return to the Add Configuration page.

Description: For reference purposes only, used to differentiate between multiple VPN connections.

Server: Enter the IP/DDNS address of your Quick VPN server.

Account: Enter the Username used to authenticate login to VPN server

Password: Enter Password used to authenticate login to VPN server

Secret: Enter your Passkey (PSK).

Tap **Done** at the top right corner of the page to finish adding the configuration.

Your iOS device is now configured to connect to your Quick VPN server.

The screenshot displays the 'Quick VPN' configuration interface. At the top, there are three buttons: 'Cancel', 'Quick VPN', and 'Done'. The main configuration area includes the following fields and controls:

- Type:** Set to 'IPsec'.
- Description:** Set to 'Quick VPN'.
- Server:** Set to 'IP/DDNS_address_of_QuickVPN'.
- Account:** Set to 'vpn'.
- Password:** Masked with three dots.
- Use Certificate:** A toggle switch that is currently turned off.
- Group Name:** An empty text field.
- Secret:** Masked with six dots.
- PROXY:** A section with three buttons: 'Off' (selected), 'Manual', and 'Auto'.

Connect or Disconnect

To connect or disconnect from to your Quick VPN server, open **Settings** and tap the button next to **VPN**.

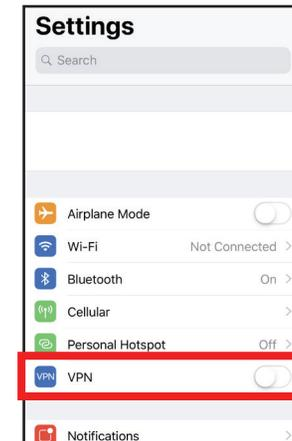

The VPN icon will appear in the notification area at the top of your screen indicating that your device is currently connected to the Quick VPN server.

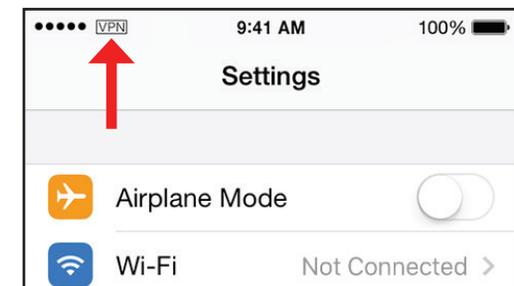

Mac OS X VPN Setup Instructions

This section provides Quick VPN setup instructions for OS X using the **Export** Profile function. Refer to **Quick VPN** on page **99** for your router setup instructions.

Open the exported profile. The Install Profile dialog will appear; click **Continue** and **Install**.

Enter your user account password when prompted. Close the **Profiles** dialog.

Go to  > **System Preferences...** > **Network** and select the Quick VPN connection and click **Authentication Settings**.

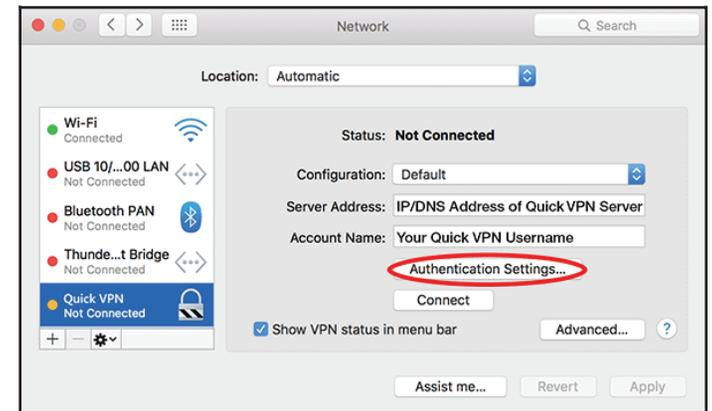

Enter your **Passkey** in the **Shared Secret** text box and click **OK, Apply**, then **OK**.

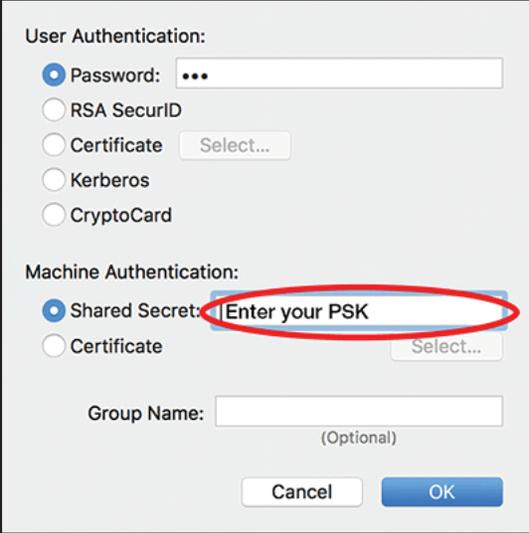

The image shows a configuration dialog box for VPN authentication. It is divided into two sections: 'User Authentication' and 'Machine Authentication'. In the 'User Authentication' section, the 'Password' option is selected with a radio button, and its text box contains three dots. Other options include 'RSA SecurID', 'Certificate' (with a 'Select...' button), 'Kerberos', and 'CryptoCard'. In the 'Machine Authentication' section, the 'Shared Secret' option is selected with a radio button, and its text box contains the text 'Enter your PSK', which is circled in red. Other options include 'Certificate' (with a 'Select...' button). Below these sections is a 'Group Name' text box with '(Optional)' written below it. At the bottom right, there are 'Cancel' and 'OK' buttons.

Your Mac is now configured to connect to your Quick VPN server.

Connect or Disconnect

To connect to or disconnect from your Quick VPN server, go to **Apple > System Preferences... > Network**.

Select the Quick VPN connection and click on the **Connect** or **Disconnect** button.



Windows 7

VPN Setup Instructions

This section provides Quick VPN setup instructions for Windows 7. Refer to **Quick VPN** on page **99** for your router setup instructions.

Click the **Start** button and type **vpn** into the **Search programs and files** box.

Select **Set up a virtual private network (VPN) connection**.

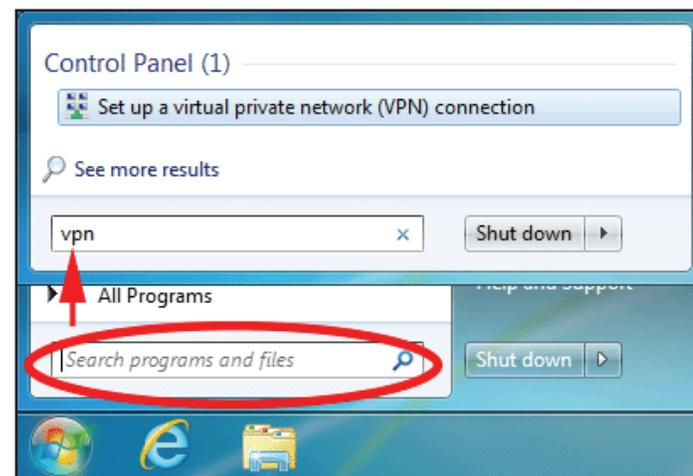

Enter the **IP/DDNS address** of your Quick VPN server in the **Internet address** box, create a name for your connection in the **Destination Name**, check **Don't Connect now; just set it up so I can connect later**, and click **Next**.

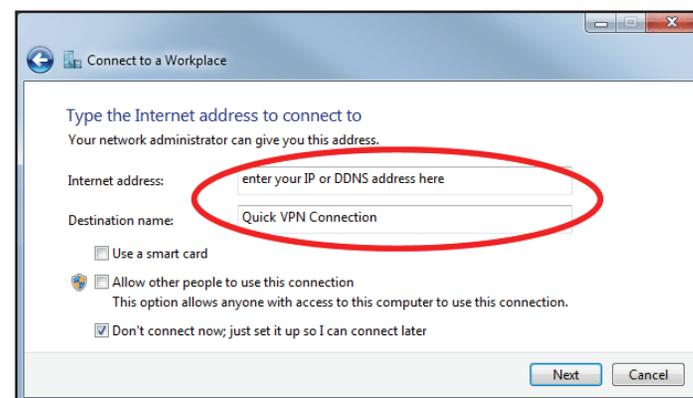

Enter your **Username**. If you would like windows to save your password, enter your **Password** and check **Remember this password**. Click **Create** to continue.

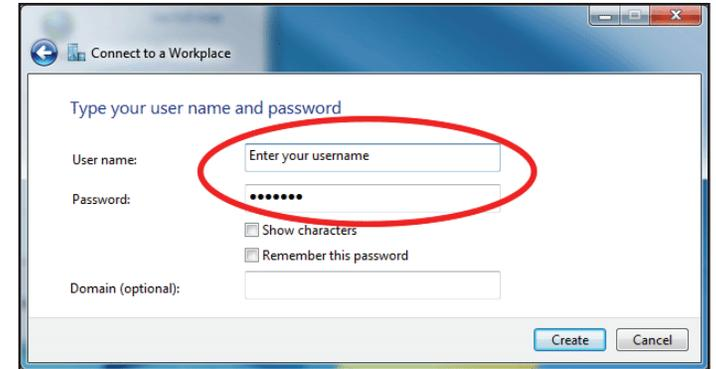

Do not click **Connect Now**.

Click **Close**. Click the **Start** button and type **view network connections** into the **Search programs and files** text box. Select **View network connections**.

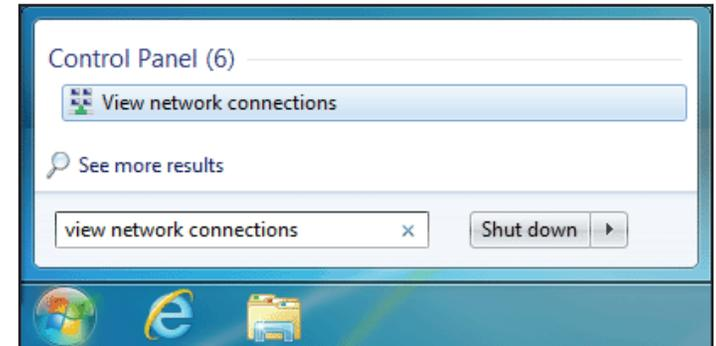

Click **Advanced settings**. Enter your **Passkey** in the **Key** text box under **Use preshared key for authentication**. Click **OK** to close **Advanced Properties** and click **OK** to close **Quick VPN Connection Properties**.

Your Windows 7 system is now configured to connect to your Quick VPN server.

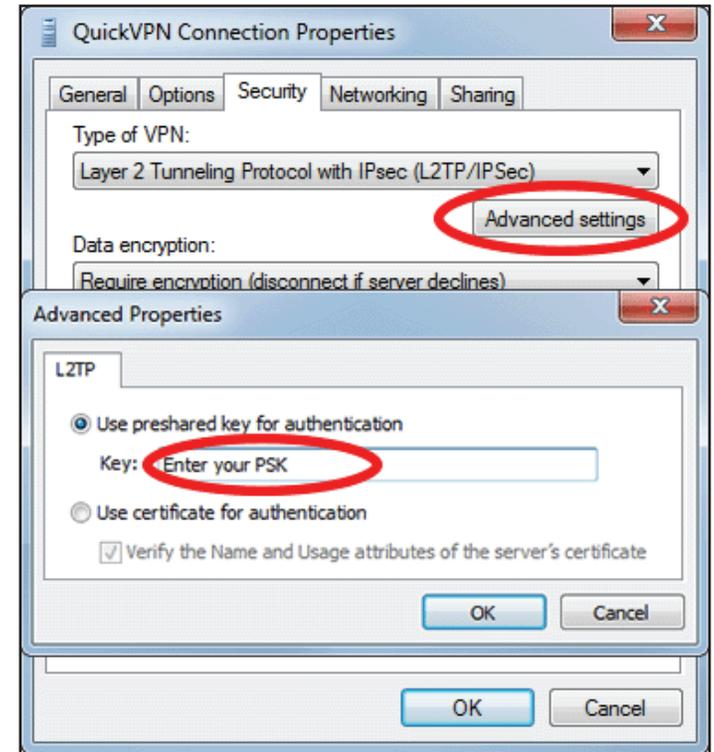

Connect or Disconnect

To connect to or disconnect from your Quick VPN server, click on the **Network Settings** icon in the notification area of the Windows taskbar and from the **Dial Up and VPN** section click on your Quick VPN connection and click on the **Connect** or **Disconnect** button.

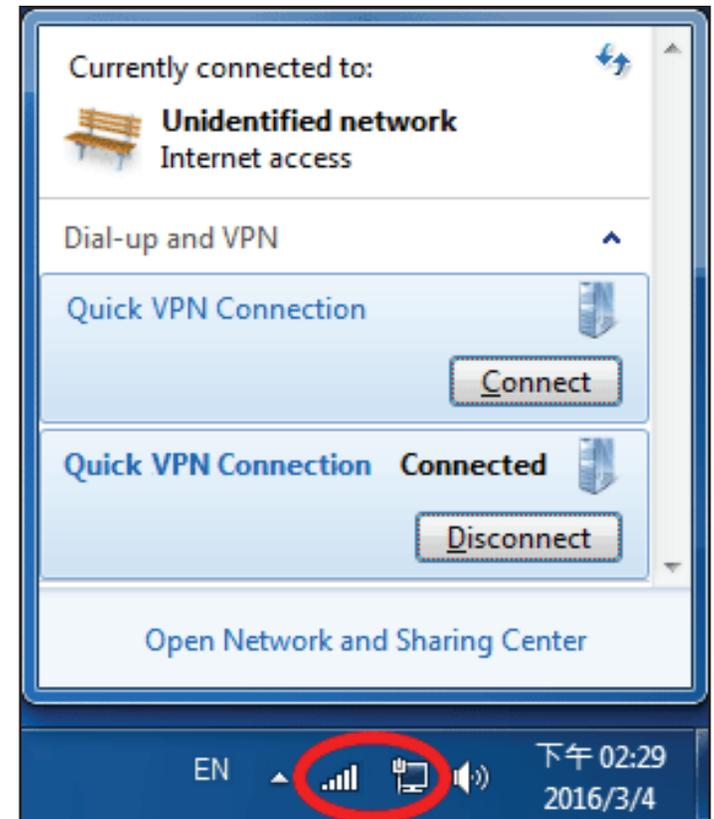

Windows 8.1/8

VPN Setup Instructions

This section provides Quick VPN setup instructions for Windows 8.1/8. Refer to **Quick VPN** on page **99** for your router setup instructions.

This section provides Quick VPN setup instructions for Windows 8.1/8.

Click the **Start** button and type **vpn**.

Select **Manage virtual private networks**.

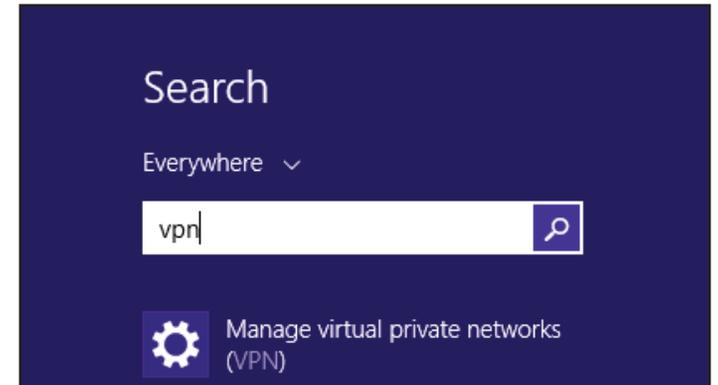

From the Network Settings page, click **Add a VPN Connection**.

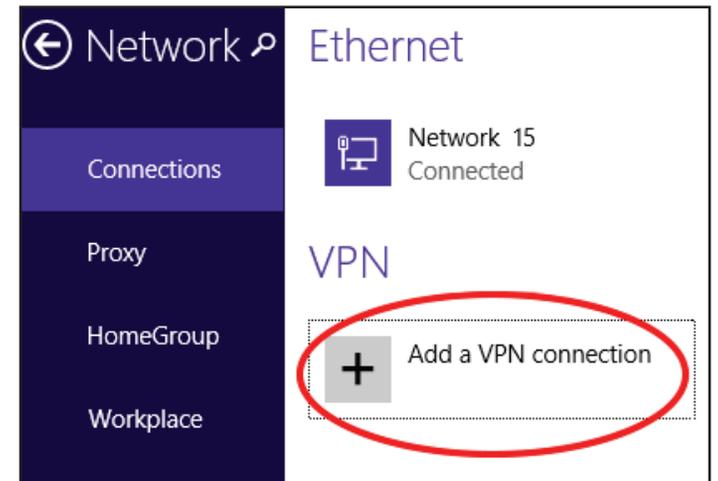

- 1 Select **Microsoft** from **VPN Provider**.
- 2 Create a name for your VPN connection.
- 3 Enter your **IP/DDNS address** of your Quick VPN server.
- 4 Select **User name and password** from **Type of sign-in info**.
- 5 If you would like windows to remember your sign-in information, enter your **User name, Password**, and select **Remember my sign-in info**
- 6 Choose **Save**.

The screenshot shows the 'Add a VPN connection' dialog box with the following fields and options:

- 1** VPN provider: Microsoft
- 2** Connection name: Quick VPN
- 3** Server name or address: IP/DDNS Address of Quick VPN Server
- 4** Type of sign-in info: User name and password
- 5** User name (optional): Username
- 5** Password (optional): [Redacted]
- Remember my sign-in info
- 6** Save
- Cancel

Right-click on the Quick VPN Connection you just created and left-click on **Properties**.

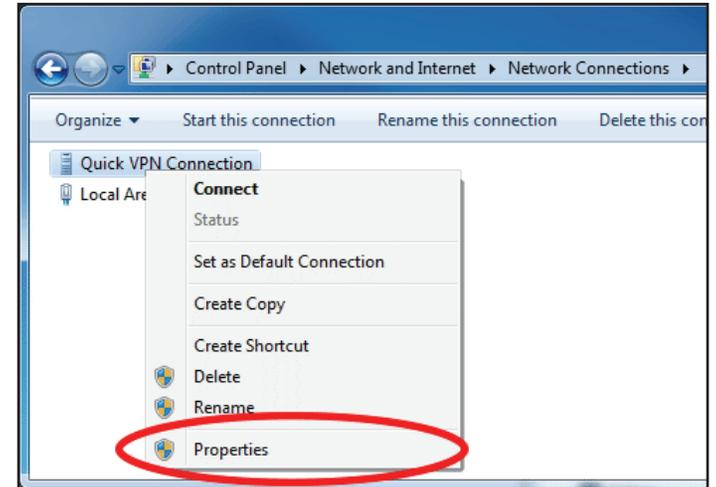

Select the **Security** tab. For the **Type of VPN**, select **Layer 2 Tunneling with IPsec (L2TP/IPSec)**.

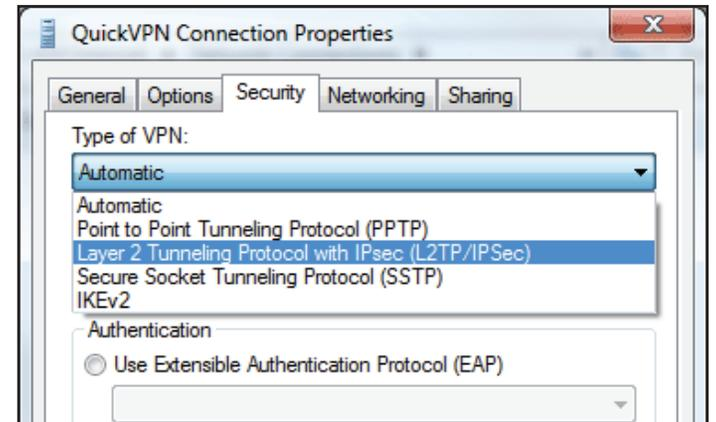

Click the **Start** button and type **view network connections**.

Select **View network connections**.

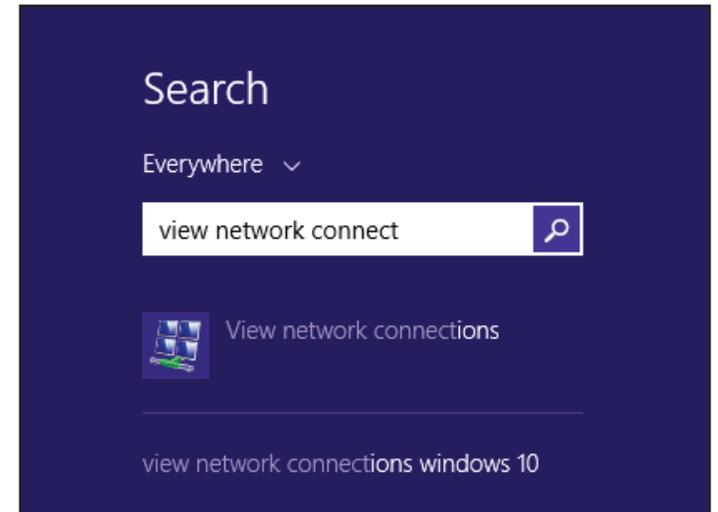

Right-click your **Quick VPN Connection** and left-click **Properties**.
Select the **Security** tab.

For the **Type of VPN**, select **Layer 2 Tunneling with IPsec (L2TP/IPSec)**.



Click **Advanced settings**. Enter your **Passkey** in the **Key** text box under **Use preshared key for authentication**.

Click **OK** to close **Advanced Properties** and click **OK** to close **Quick VPN Properties**.

Your Windows 8.1/8 system is now configured to connect to your Quick VPN server.

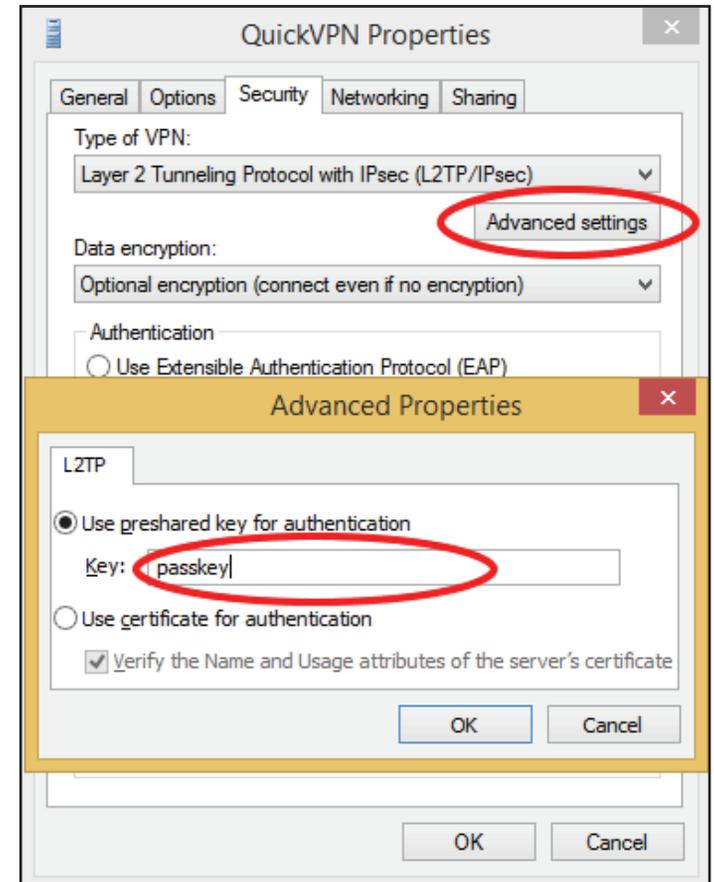

Connect or Disconnect

To connect to or disconnect from your Quick VPN server, click on the **Network Settings** icon in the notification area of the Windows taskbar. Click on your Quick VPN connection and click on the **Connect** or **Disconnect** button.

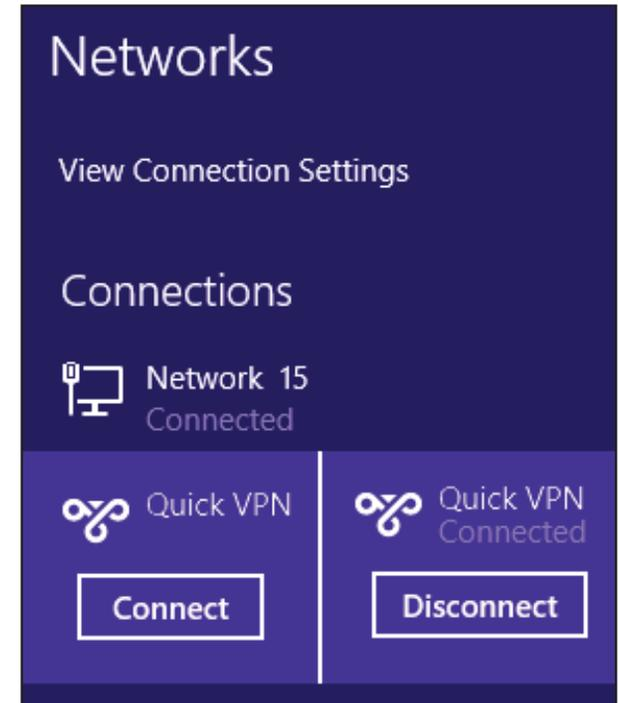
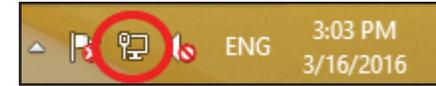

Windows 10 VPN Setup Instructions

This section provides Quick VPN setup instructions for Windows 7. Refer to **Quick VPN** on page **99** for your router setup instructions.

This section provides Quick VPN setup instructions for Windows 10.

Click **Start > Settings > Network & Internet > Network and Sharing Center > VPN > Add a VPN Connection.**

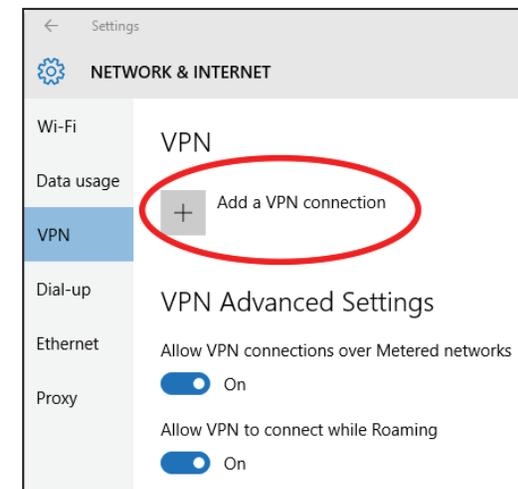
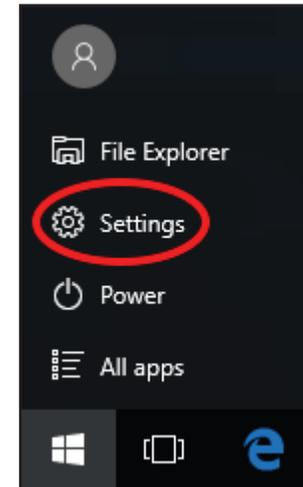

- 1 Select **Windows (built-in)** from the **VPN Provider** drop down menu.
- 2 Create a name for your VPN connection.
- 3 Enter your **IP/DDNS address** of your Quick VPN server.
- 4 Select **L2TP/IPSec with pre-shared key** from **VPN type**.
- 5 Enter the **Passkey**.
- 6 Select **User name and password** from **Type of sign-in info**.
If you would like windows to remember your sign-in information, enter your **User name, Password**, and select **Remember my sign-in info**
- 7 Choose **Save**.

Your Windows 10 system is now configured to connect to your Quick VPN server.

Add a VPN connection

VPN provider
1 Windows (built-in) ▾

Connection name
2 Quick VPN

Server name or address
3 IP/DDNS Address of Quick VPN Server

VPN type
4 L2TP/IPsec with pre-shared key ▾

Pre-shared key
5 Passkey

Type of sign-in info
6 User name and password ▾

User name (optional)
Username

Password (optional)
••••••••

Remember my sign-in info

7 Save Cancel

Connect or Disconnect

To connect to or disconnect from your Quick VPN server, click on the **Network Settings** icon in the notification area of the Windows taskbar and click on your Quick VPN connection. The **Network & Internet** Settings page will open. Click on the **Connect** or **Disconnect** button.

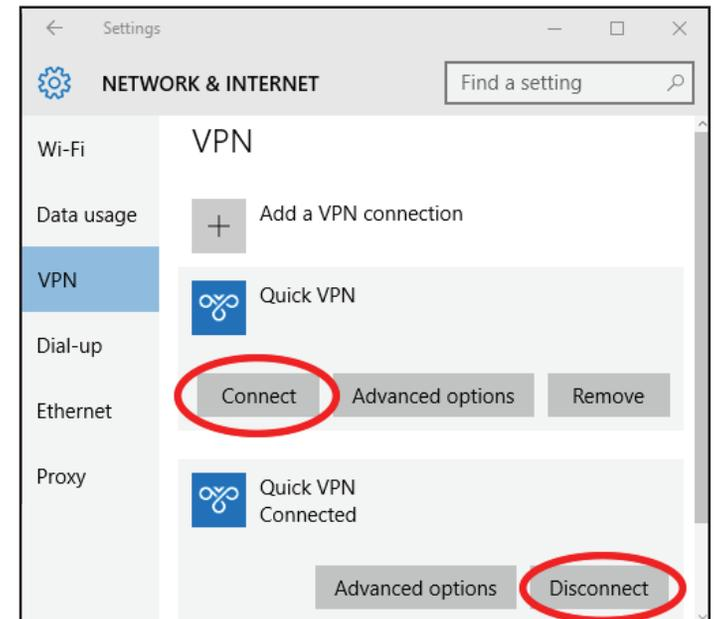
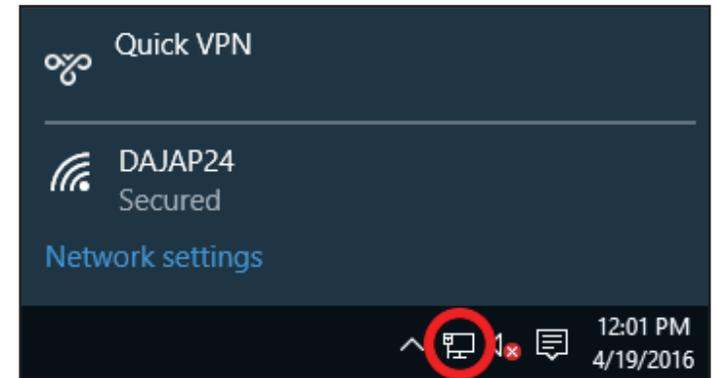

Android

VPN Setup Instructions

This section provides Quick VPN setup instructions for Android devices. Your device's screens may vary. Refer to **Quick VPN** on page **99** for your router setup instructions.

Go to **Settings** > **More** from the **Wireless & networks** > **VPN** > +

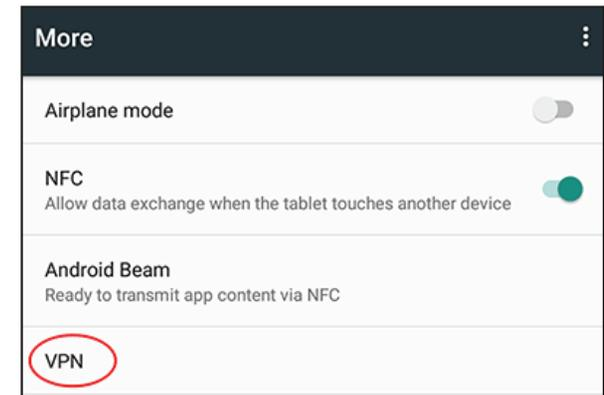
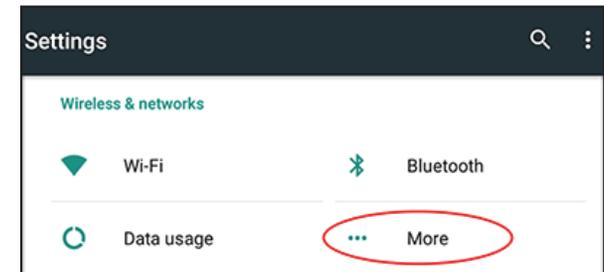

- 1 Enter a name for your VPN connection.
- 2 Select **L2TP/IPSec PSK** for **Type**.
- 3 Enter the **IP/DDNS address** of your Quick VPN server.
- 4 Enter your **Passkey** in **IPSec pre-shared key** field.
- 5 Choose **Save**.

Your Android device is now configured to connect to your Quick VPN server.

VPN

Edit VPN profile

Name
1 Quick VPN

Type
2 L2TP/IPSec PSK

Server address
3 Quick VPN IP/DDNS address

L2TP secret
(not used)

IPSec identifier
(not used)

IPSec pre-shared key
4

Show advanced options

5

CANCEL SAVE

Connect or Disconnect

To connect to or disconnect from your Quick VPN server, go to **Settings** > **More** from the **Wireless & networks** > **VPN** and select the **Quick VPN** connection you created.

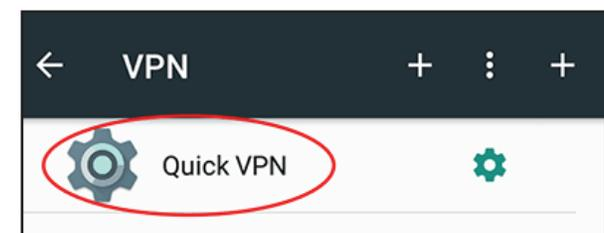
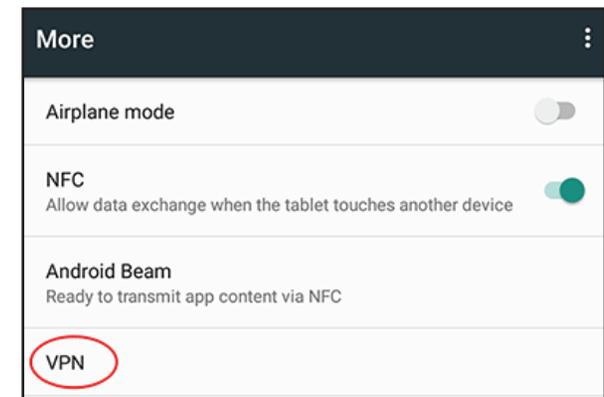
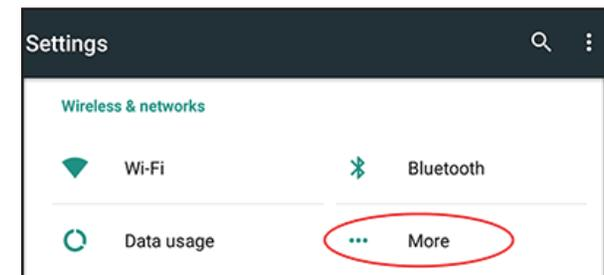

To connect, enter your **Username** and **Password** and select **CONNECT**.

Connect to Quick VPN

Username
Your Quick VPN Username

Password
.....

Save account information

CANCEL CONNECT

To disconnect, select **DISCONNECT**.

VPN is connected

Session: Quick VPN
Duration: 00:00:09
Sent: 97 bytes / 5 packets
Received: 64 bytes / 4 packets

DISCONNECT CANCEL

Connect a Wireless Client to your Router

WPS Button

The easiest and most secure way to connect your wireless devices to the router is with WPS (Wi-Fi Protected Setup). Most wireless devices such as wireless adapters, media players, Blu-ray DVD players, wireless printers and cameras will have a WPS button (or a software utility with WPS) that you can press to connect to the router. Please refer to your user manual for the wireless device you want to connect to make sure you understand how to enable WPS. Once you know, follow the steps below:

Step 1 - Press the WPS button on the router for about 1 second. The wireless LEDs will start to blink.

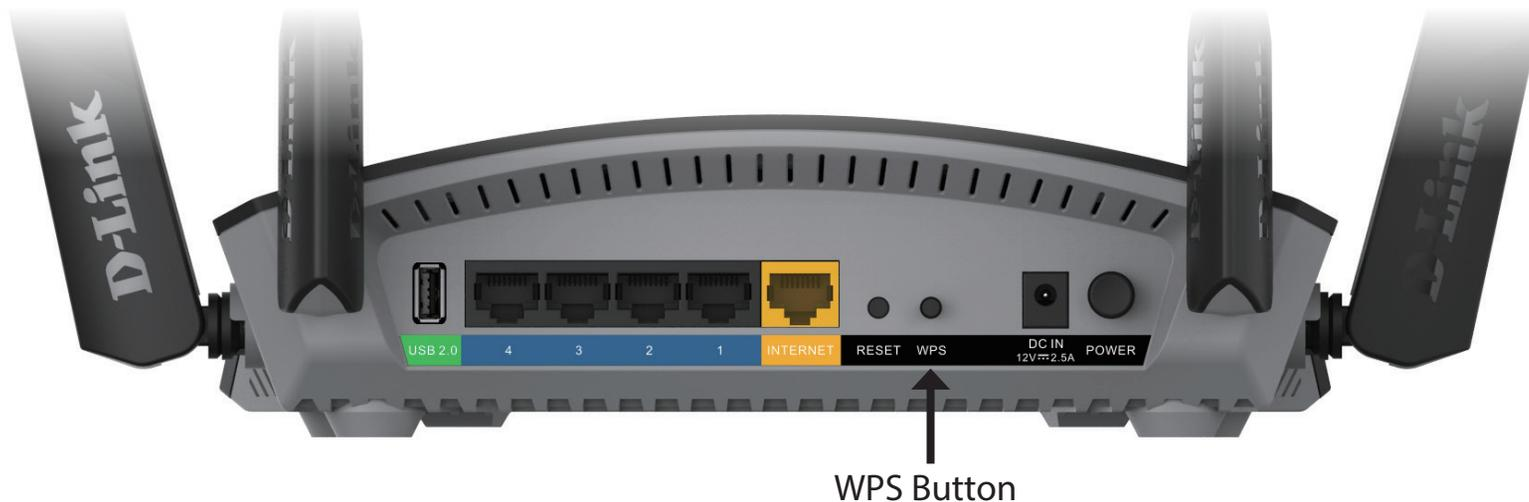

Step 2 - Within 2 minutes, press the WPS button on your wireless device (or launch the software utility and start the WPS process).

Step 3 - Allow up to 1 minute for your connection to be configured. Once the Internet light stops blinking, you will be connected and your wireless connection will be secure with WPA2.

Windows® 10

To join an existing network, locate the wireless network icon in the taskbar, next to the time display and click on it.

Clicking on this icon will display a list of wireless networks which are within range of your computer. Select the desired network by clicking on the SSID.

To connect to the SSID, click **Connect**.

To automatically connect with the router when your device next detects the SSID, check the **Connect Automatically** check box.

You will then be prompted to enter the Wi-Fi password (network security key) for the wireless network. Enter the password into the box and click **Next** to connect to the network. Your computer will now automatically connect to this wireless network when it is detected.



Wireless Icon

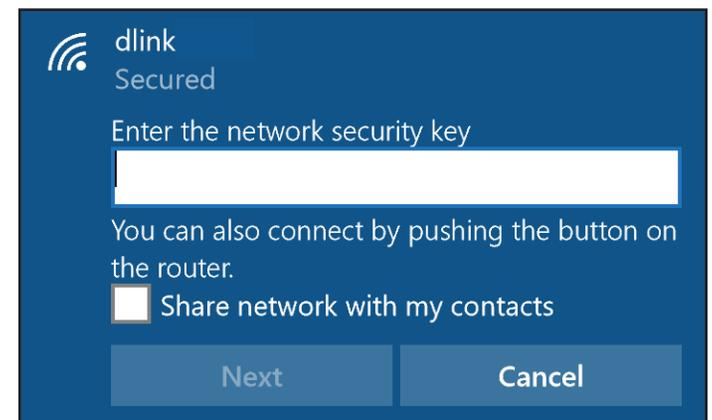
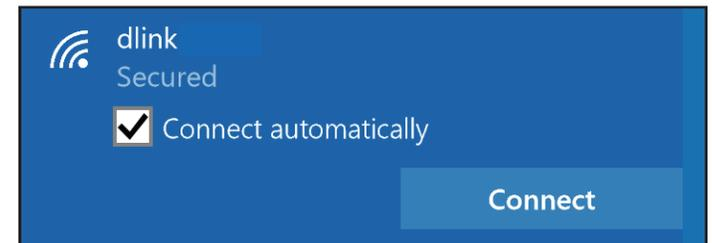
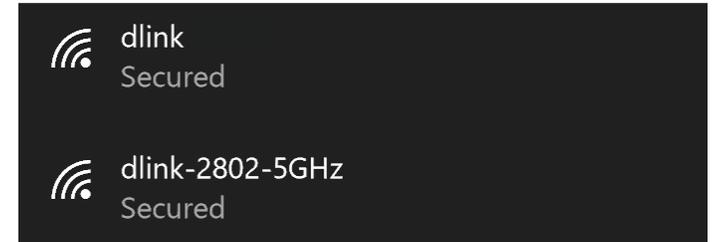

Windows® 8 - WPA/WPA2

To join an existing network, locate the wireless network icon in the taskbar, next to the time display.



↑
Wireless Icon

Clicking on this icon will display a list of wireless networks which are within connecting proximity of your computer. Select the extender's network by clicking on the network name.

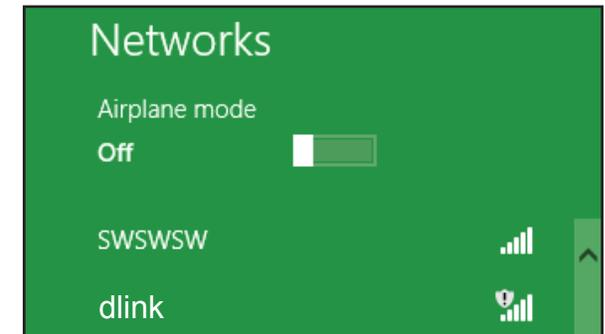

You will then be prompted to enter the network security key (Wi-Fi password) for the wireless network. Enter the password into the box and click **Next**.

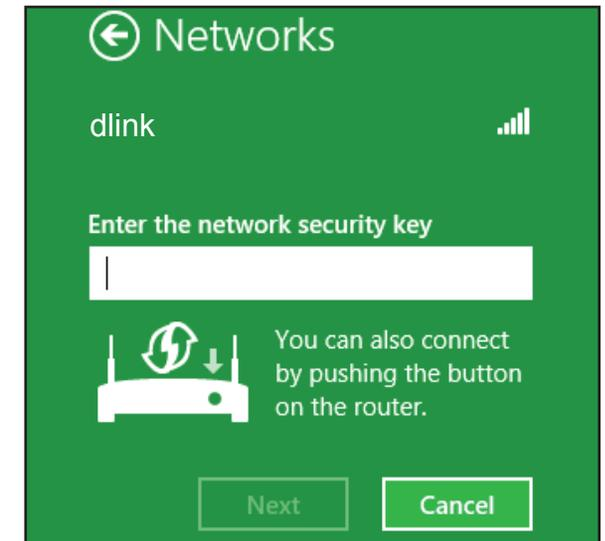

When you have established a successful connection with a wireless network, the word **Connected** will appear next to the name of the network to which you are connected.

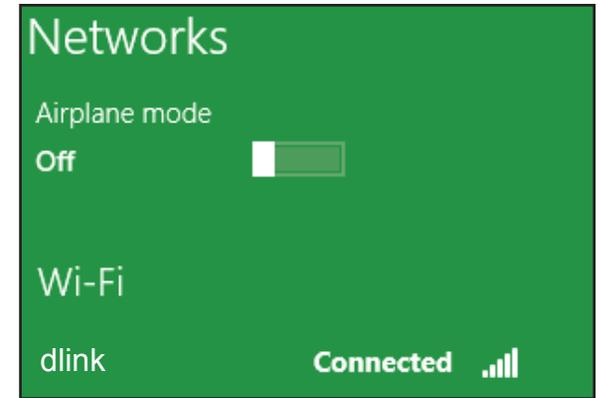

Windows® 7

WPA/WPA2

It is recommended that you enable wireless security (WPA/WPA2) on your wireless router or access point before configuring your wireless adapter. If you are joining an existing network, you will need to know the security key or passphrase being used.

Click on the wireless icon in your system tray (lower-right corner).



Wireless Icon

The utility will display any available wireless networks in your area.

Highlight the wireless connection with Wi-Fi name (SSID) you would like to connect to and click the **Connect** button.

If you get a good signal but cannot access the Internet, check your TCP/IP settings for your wireless adapter. Refer to **Networking Basics** on page **182** for more information.



The following window appears while your computer tries to connect to the router.

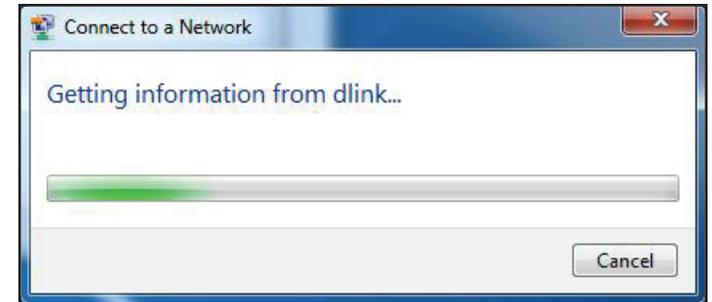

Enter the same security key or passphrase (Wi-Fi password) that is on your router and click **OK**. You can also connect by pushing the WPS button on the router.

It may take 20-30 seconds to connect to the wireless network. If the connection fails, please verify that the security settings are correct. The key or passphrase must be exactly the same as the one on the wireless router.



Troubleshooting

This chapter provides solutions to problems that can occur during the installation and operation of the router. Read the following descriptions if you are having problems.

1. Why can't I access the web-based configuration utility?

When entering the IP address of the D-Link router (**192.168.0.1** for example), you are not connecting to a website, nor do you have to be connected to the Internet. The device has the utility built-in to a ROM chip in the device itself. Your computer must be on the same IP subnet to connect to the web-based utility.

- Make sure you have an updated Java-enabled web browser. We recommend the following:
 - Microsoft Internet Explorer® 10 or higher
 - Mozilla Firefox 28 or higher
 - Google™ Chrome 28 or higher
 - Apple Safari 6 or higher
- Verify physical connectivity by checking for solid link lights on the device. If you do not get a solid link light, try using a different cable, or connect to a different port on the device if possible. If the computer is turned off, the link light may not be on.
- Disable any Internet security software running on the computer. Software firewalls such as ZoneAlarm, BlackICE, Sygate, Norton Personal Firewall, and Windows® XP firewall may block access to the configuration pages. Check the help files included with your firewall software for more information on disabling or configuring it.

- Configure your Internet settings:
 - Go to **Start > Settings > Control Panel**. Double-click the **Internet Options** icon. From the **Security** tab, click the button to restore the settings to their defaults.
 - Click the **Connection** tab and set the dial-up option to Never Dial a Connection. Click the LAN Settings button. Make sure nothing is checked. Click **OK**.
 - Go to the **Advanced** tab and click the button to restore these settings to their defaults. Click **OK** three times.
 - Close your web browser (if open) and open it.
- Access the web management. Open your web browser and enter the IP address of your D-Link router in the address bar. This should open the login page for your web management.
- If you still cannot access the configuration, unplug the power to the router for 10 seconds and plug back in. Wait about 30 seconds and try accessing the configuration. If you have multiple computers, try connecting using a different computer.

2. What can I do if I forgot my password?

If you forgot your password, you must reset your router. This process will change all your settings back to the factory defaults.

To reset the router, locate the reset button (hole) on the rear panel of the unit. With the router powered on, use a paperclip to hold the button down for 10 seconds. Release the button and the router will go through its reboot process. Wait about 30 seconds to access the router. The default IP address is **192.168.0.1**. When logging in, leave the password box empty.

3. Why can't I connect to certain sites or send and receive emails when connecting through my router?

If you are having a problem sending or receiving email, or connecting to secure sites such as eBay, banking sites, and Hotmail, we suggest lowering the MTU in increments of ten (Ex. 1492, 1482, 1472, etc).

To find the proper MTU Size, you'll have to do a special ping of the destination you're trying to go to. A destination could be another computer, or a URL.

- Click on **Start** and then click **Run**.
- Windows® 95, 98, and Me users type in **command** (Windows® NT, 2000, XP, Vista®, and 7 users type in **cmd**) and press **Enter** (or click **OK**).
- Once the window opens, you'll need to do a special ping. Use the following syntax: **ping [url] [-f] [-l] [MTU value]**
Example: **ping yahoo.com -f -l 1472**

You should start at 1472 and work your way down by 10 each time. Once you get a reply, go up by 2 until you get a fragmented packet. Take that value and add 28 to the value to account for the various TCP/IP headers. For example, lets say that 1452 was the proper value, the actual MTU size would be 1480, which is the optimum for the network we're working with (1452+28=1480).

```
C:\>ping yahoo.com -f -l 1482
Pinging yahoo.com [66.94.234.13] with 1482 bytes of data:
Packet needs to be fragmented but DF set.
Packet needs to be fragmented but DF set.
Packet needs to be fragmented but DF set.
Packet needs to be fragmented but DF set.

Ping statistics for 66.94.234.13:
    Packets: Sent = 4, Received = 0, Lost = 4 (100% loss),
Approximate round trip times in milli-seconds:
    Minimum = 0ms, Maximum = 0ms, Average = 0ms

C:\>ping yahoo.com -f -l 1472
Pinging yahoo.com [66.94.234.13] with 1472 bytes of data:
Reply from 66.94.234.13: bytes=1472 time=93ms TTL=52
Reply from 66.94.234.13: bytes=1472 time=109ms TTL=52
Reply from 66.94.234.13: bytes=1472 time=125ms TTL=52
Reply from 66.94.234.13: bytes=1472 time=203ms TTL=52

Ping statistics for 66.94.234.13:
    Packets: Sent = 4, Received = 4, Lost = 0 (0% loss),
Approximate round trip times in milli-seconds:
    Minimum = 93ms, Maximum = 203ms, Average = 132ms

C:\>
```

Once you find your MTU, you can now configure your router with the proper MTU size.

To change the MTU rate on your router follow the steps below:

- Open your browser, enter the IP address of your router (192.168.0.1) and click **OK**.
- Enter your password (blank by default). Click **OK** to enter the web configuration page for the device.
- Click on **Setup** and then click **Manual Configure**.
- To change the MTU, enter the number in the MTU field and click **Save Settings** to save your settings.
- Test your email. If changing the MTU does not resolve the problem, continue changing the MTU in increments of ten.

Wireless Basics

D-Link wireless products are based on industry standards to provide easy-to-use and compatible high-speed wireless connectivity within your home, business, or public access wireless networks. Strictly adhering to the IEEE standard, the D-Link wireless family of products will allow you to securely access the data you want, when, and where you want it. You will be able to enjoy the freedom that wireless networking delivers.

A wireless local area network (WLAN) is a cellular computer network that transmits and receives data with radio signals instead of wires. Wireless LANs are used increasingly in both home and office environments, and public areas such as airports, coffee shops and universities. Innovative ways to utilize WLAN technology are helping people work, and communicate more efficiently. Increased mobility and the absence of cabling and other fixed infrastructure have proven to be beneficial for many users.

Wireless users can use the same applications they use on a wired network. Wireless adapter cards used on laptop and desktop systems support the same protocols as Ethernet adapter cards.

Under many circumstances, it may be desirable for mobile network devices to link to a conventional Ethernet LAN in order to use servers, printers or an Internet connection supplied through the wired LAN. A wireless router is a device used to provide this link.

What is Wireless?

Wireless or Wi-Fi technology is another way of connecting your computer to the network without using wires. Wi-Fi uses radio frequency to connect wirelessly so you have the freedom to connect computers anywhere in your home or office network.

Why D-Link Wireless?

D-Link is the worldwide leader and award winning designer, developer, and manufacturer of networking products. D-Link delivers the performance you need at a price you can afford. D-Link has all the products you need to build your network.

How does wireless work?

Wireless works similarly to how cordless phones work, through radio signals that transmit data from one point A to point B. But wireless technology has restrictions as to how you can access the network. You must be within the wireless network range area to be able to connect your computer. There are two different types of wireless networks: Wireless Local Area Network (WLAN), and Wireless Personal Area Network (WPAN).

Wireless Local Area Network (WLAN)

In a wireless local area network, a device called an Access Point (AP) connects computers to the network. The access point has a small antenna attached to it, which allows it to transmit data back and forth over radio signals. With an indoor access point the signal can travel up to 300 feet. With an outdoor access point the signal can reach out up to 30 miles to serve places like manufacturing plants, industrial locations, university and high school campuses, airports, golf courses, and many other outdoor venues.

Wireless Personal Area Network (WPAN)

Bluetooth is the industry standard wireless technology used for WPAN. Bluetooth devices in WPAN operate in a range up to 30 feet away. Compared to WLAN the speed and wireless operation range are both less than WLAN, but in return it doesn't use nearly as much power. This makes it ideal for personal devices, such as mobile phones, PDAs, headphones, laptops, speakers, and other devices that operate on batteries.

Who uses wireless?

Wireless technology has become so popular in recent years that almost everyone is using it, whether it's for home, office, business, D-Link has a wireless solution for it.

Home Uses/Benefits

- Gives everyone at home broadband access
- Surf the web, check email, instant message, etc.
- Gets rid of the cables around the house
- Simple and easy to use

Small Office and Home Office Uses/Benefits

- Stay on top of everything at home as you would at office
- Remotely access your office network from home
- Share Internet connection and printer with multiple computers
- No need to dedicate office space

Where is wireless used?

Wireless technology is expanding everywhere, not just at home or office. People like the freedom of mobility and it's becoming so popular that more and more public facilities now provide wireless access to attract people. The wireless connection in public places is usually called "hotspots".

Using a D-Link USB adapter with your laptop, you can access the hotspot to connect to the Internet from remote locations like: airports, hotels, coffee shops, libraries, restaurants, and convention centers.

Wireless network is easy to setup, but if you're installing it for the first time it could be quite a task not knowing where to start. That's why we've put together a few setup steps and tips to help you through the process of setting up a wireless network.

Tips

Here are a few things to keep in mind, when you install a wireless network.

Centralize your router or access point

Make sure you place the router/access point in a centralized location within your network for the best performance. Try to place the router/access point as high as possible in the room, so the signal gets dispersed throughout your home. If you have a two-story home, you may need a repeater to boost the signal to extend the range.

Eliminate Interference

Place home appliances such as cordless telephones, microwaves, and televisions as far away as possible from the router/access point. This would significantly reduce any interference that the appliances might cause since they operate on same frequency.

Security

Don't let your next-door neighbors or intruders connect to your wireless network. Secure your wireless network by turning on the WPA or WEP security feature on the router. Refer to the product manual for detail information on how to set it up.

Wireless Modes

There are basically two modes of networking:

- **Infrastructure** – All wireless clients will connect to an access point or wireless router.
- **Ad-hoc** – Directly connecting to another computer for peer-to-peer communication using wireless network adapters on each computer, such as two or more wireless network USB adapters.

An Infrastructure network contains an access point or wireless router. All the wireless devices, or clients, will connect to the wireless router or access point.

An Ad-hoc network contains only clients, such as laptops with wireless USB adapters. All the adapters must be in Ad-hoc mode to communicate.

Networking Basics

Check your IP address

After you install your new D-Link adapter, by default, the TCP/IP settings should be set to obtain an IP address from a DHCP server (i.e. wireless router) automatically. To verify your IP address, please follow the steps below.

Click on **Start > Run**. In the run box type **cmd** and click **OK**. (Windows® 7/Vista® users type **cmd** in the **Start Search** box.)

At the prompt, type **ipconfig** and press **Enter**.

This will display the IP address, subnet mask, and the default gateway of your adapter.

If the address is 0.0.0.0, check your adapter installation, security settings, and the settings on your router. Some firewall software programs may block a DHCP request on newly installed adapters.

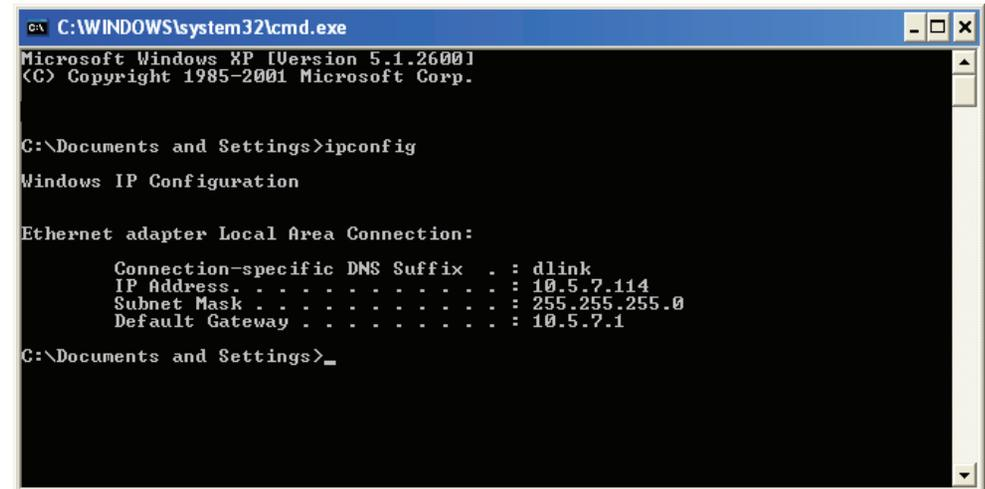

```
C:\WINDOWS\system32\cmd.exe
Microsoft Windows XP [Version 5.1.2600]
(C) Copyright 1985-2001 Microsoft Corp.

C:\Documents and Settings>ipconfig

Windows IP Configuration

Ethernet adapter Local Area Connection:

    Connection-specific DNS Suffix  . : dlink
    IP Address. . . . .               : 10.5.7.114
    Subnet Mask . . . . .             : 255.255.255.0
    Default Gateway . . . . .         : 10.5.7.1

C:\Documents and Settings>_
```

Statically Assign an IP address

1. If you are not using a DHCP capable gateway/router, or you need to assign a static IP address, please follow the steps below:

- Windows® 7** Start > Control Panel > Network and Internet > Network and Sharing Center
- Windows Vista®** Start > Control Panel > Network and Internet > Network and Sharing Center > Manage Network Connections
- Windows® XP** Start > Control Panel > Network Connections
- Windows® 2000** From the desktop, right-click My Network Places > Properties

2. Right-click on the **Local Area Connection** which represents your network adapter and select **Properties**.

3. Highlight **Internet Protocol (TCP/IP)** and click **Properties**.

4. Click **Use the following IP address** and enter an IP address that is on the same subnet as your network or the LAN IP address on your router.

Example: If the router's LAN IP address is 192.168.0.1, make your IP address 192.168.0.X where X is a number between 2 and 99. Make sure that the number you choose is not in use on the network. Set the Default Gateway the same as the LAN IP address of your router (I.E. 192.168.0.1).

Set Primary DNS the same as the LAN IP address of your router (192.168.0.1). The Secondary DNS is not needed or you may enter a DNS server from your ISP.

5. Click **OK** twice to save your settings.

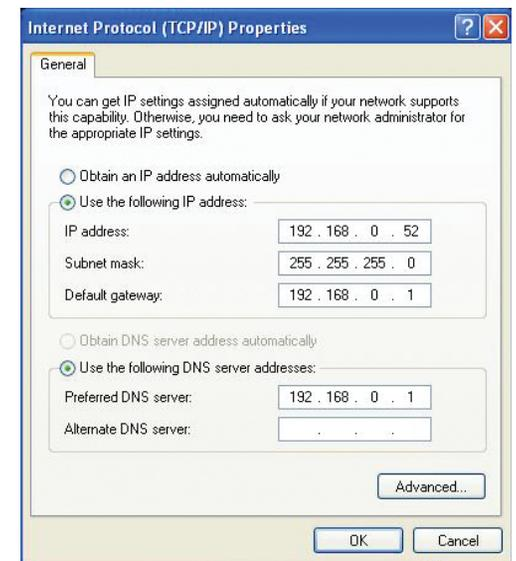

Wireless Security

This section will show you the different levels of security you can use to protect your data from intruders. The router offers the following types of security:

- WPA2 (Wi-Fi Protected Access 2)
- WPA (Wi-Fi Protected Access)
- WPA2-PSK (Pre-Shared Key)
- WPA-PSK (Pre-Shared Key)

What is WPA?

WPA (Wi-Fi Protected Access), is a Wi-Fi standard that was designed to improve the security features of WEP (Wired Equivalent Privacy).

The 2 major improvements over WEP:

- Improved data encryption through the Temporal Key Integrity Protocol (TKIP). TKIP scrambles the keys using a hashing algorithm and by adding an integrity-checking feature, ensures that the keys haven't been tampered with. WPA2 is based on 802.11i and uses Advanced Encryption Standard (AES) instead of TKIP.
- User authentication, which is generally missing in WEP, through the extensible authentication protocol (EAP). WEP regulates access to a wireless network based on a computer's hardware-specific MAC address, which is relatively simple to be sniffed out and stolen. EAP is built on a more secure public-key encryption system to ensure that only authorized network users can access the network.

WPA-PSK/WPA2-PSK uses a passphrase or key to authenticate your wireless connection. The key is an alpha-numeric password between 8 and 63 characters long. The password can include symbols (!?*&_) and spaces. This key must be the exact same key entered on your wireless router or access point.

WPA/WPA2 incorporates user authentication through the Extensible Authentication Protocol (EAP). EAP is built on a more secure public key encryption system to ensure that only authorized network users can access the network.

Technical Specifications

DIR-1360

Device Interfaces

- Wireless Interface (2.4 GHz): IEEE 802.11n/g/b
- Wireless Interface (5 GHz): IEEE 802.11 ac/n/a
- Four 10/100/1000 Mbps LAN ports
- One 10/100/1000 Mbps WAN port
- One SuperSpeed USB 3.0 port

Antenna Types

- Four external antennas

Standards

- IEEE 802.11ac^{1,2,3}
- IEEE 802.11b
- IEEE 802.11n
- IEEE 802.11a
- IEEE 802.11g
- IEEE 802.3u
- IEEE 802.3ab
- IEEE 802.1p
- IEEE 802.1q

Security

- WPA™ - Personal
- WPA2™ - Personal
- Wi-Fi Protected Setup (WPS)

Power

- Input: 100 to 240 V AC, 50 / 60 Hz
- Output: 12 V, 1.5 A

Temperature

- Operating: 0 to 40 °C (32 to 104 °F)
- Storage: -20 to 65 °C (-4 to 149 °F)

Humidity

- Operating: 10% to 90% maximum, non-condensing
- Storage: 5% to 95% maximum, non-condensing

Certifications

- FCC
- CE
- IC

Dimensions

- L x W x H: 202.70 x 144.39 x 58.35 mm (7.98 x 5.68 x 2.59 in)

Weight

- 370 g (0.81 lbs)

¹ Maximum wireless signal rate derived from IEEE Standard 802.11a, 802.11g, 802.11n, and 802.11ac specifications. Actual data throughput will vary. Network conditions and environmental factors - including volume of network traffic, building materials and construction, and network overhead - lower actual data throughput rate. Environmental factors will adversely affect wireless signal range.

² Frequency Range varies depending on country's regulation.

³ The router does not include 5.25-5.35 GHz & 5.47-5.725 GHz in some regions.

DIR-1760

Device Interfaces

- Wireless Interface (2.4 GHz): IEEE 802.11n/g/b
- Wireless Interface (5 GHz): IEEE 802.11 ac/n/a
- Four 10/100/1000 Mbps LAN ports
- One 10/100/1000 Mbps WAN port
- One SuperSpeed USB 3.0 port

Antenna Types

- Four external antennas

Standards

- IEEE 802.11ac^{1,2,3}
- IEEE 802.11b
- IEEE 802.11n
- IEEE 802.11a
- IEEE 802.11g
- IEEE 802.3u
- IEEE 802.3ab
- IEEE 802.1p
- IEEE 802.1q

Security

- WPA™ - Personal
- WPA2™ - Personal
- Wi-Fi Protected Setup (WPS)

Power

- Input: 100 to 240 V AC, 50 / 60 Hz
- Output: 12 V, 2 A

Temperature

- Operating: 0 to 40 °C (32 to 104 °F)
- Storage: -20 to 65 °C (-4 to 149 °F)

Humidity

- Operating: 10% to 90% maximum, non-condensing
- Storage: 5% to 95% maximum, non-condensing

Certifications

- FCC
- CE
- IC

Dimensions

- L x W x H: 222.92 x 176.58 x 65.00 mm (8.78 x 6.95 x 2.56 in)

Weight

- 590 g (1.30 lbs)

¹ Maximum wireless signal rate derived from IEEE Standard 802.11a, 802.11g, 802.11n, and 802.11ac specifications. Actual data throughput will vary. Network conditions and environmental factors - including volume of network traffic, building materials and construction, and network overhead - lower actual data throughput rate. Environmental factors will adversely affect wireless signal range.

² Frequency Range varies depending on country's regulation.

³ The router does not include 5.25-5.35 GHz & 5.47-5.725 GHz in some regions.

DIR-1960

Device Interfaces

- Wireless Interface (2.4 GHz): IEEE 802.11n/g/b
- Wireless Interface (5 GHz): IEEE 802.11 ac/n/a
- Four 10/100/1000 Mbps LAN ports
- One 10/100/1000 Mbps WAN port
- One SuperSpeed USB 3.0 port

Antenna Types

- Four external antennas

Standards

- IEEE 802.11ac^{1,2,3}
- IEEE 802.11b
- IEEE 802.11n
- IEEE 802.11a
- IEEE 802.11g
- IEEE 802.3u
- IEEE 802.3ab
- IEEE 802.1p
- IEEE 802.1q

Security

- WPA™ - Personal
- WPA2™ - Personal
- Wi-Fi Protected Setup (WPS)

Power

- Input: 100 to 240 V AC, 50 / 60 Hz
- Output: 12 V, 2 A

Temperature

- Operating: 0 to 40 °C (32 to 104 °F)
- Storage: -20 to 65 °C (-4 to 149 °F)

Humidity

- Operating: 10% to 90% maximum, non-condensing
- Storage: 5% to 95% maximum, non-condensing

Certifications

- FCC
- CE
- IC

Dimensions

- L x W x H: 222.92 x 176.58 x 65.00 mm (8.78 x 6.95 x 2.56 in)

Weight

- 593 g (1.31 lbs)

¹ Maximum wireless signal rate derived from IEEE Standard 802.11a, 802.11g, 802.11n, and 802.11ac specifications. Actual data throughput will vary. Network conditions and environmental factors - including volume of network traffic, building materials and construction, and network overhead - lower actual data throughput rate. Environmental factors will adversely affect wireless signal range.

² Frequency Range varies depending on country's regulation.

³ The router does not include 5.25-5.35 GHz & 5.47-5.725 GHz in some regions.

DIR-2660

Device Interfaces

- Wireless Interface (2.4 GHz): IEEE 802.11n/g/b
- Wireless Interface (5 GHz): IEEE 802.11 ac/n/a
- Four 10/100/1000 Mbps LAN ports
- One 10/100/1000 Mbps WAN port
- One USB 2.0 port
- One SuperSpeed USB 3.0 port

Antenna Types

- Four external antennas

Standards

- IEEE 802.11ac^{1,2,3}
- IEEE 802.11b
- IEEE 802.11n
- IEEE 802.11a
- IEEE 802.11g
- IEEE 802.3u
- IEEE 802.3ab
- IEEE 802.1p
- IEEE 802.1q

Security

- WPA™ - Personal
- WPA2™ - Personal
- Wi-Fi Protected Setup (WPS)

Power

- Input: 100 to 240 V AC, 50 / 60 Hz
- Output: 12 V, 2.5 A

Temperature

- Operating: 0 to 40 °C (32 to 104 °F)
- Storage: -20 to 65 °C (-4 to 149 °F)

Humidity

- Operating: 10% to 90% maximum, non-condensing
- Storage: 5% to 95% maximum, non-condensing

Certifications

- FCC
- CE
- IC

Dimensions

- L x W x H: 222.92 x 176.58 x 65.00 mm (8.78 x 6.95 x 2.56 in)

Weight

- 610 g (1.34 lbs)

¹ Maximum wireless signal rate derived from IEEE Standard 802.11a, 802.11g, 802.11n, and 802.11ac specifications. Actual data throughput will vary. Network conditions and environmental factors - including volume of network traffic, building materials and construction, and network overhead - lower actual data throughput rate. Environmental factors will adversely affect wireless signal range.

² Frequency Range varies depending on country's regulation.

³ The router does not include 5.25-5.35 GHz & 5.47-5.725 GHz in some regions.

DIR-3060

Device Interfaces

- Wireless Interface (2.4 GHz): IEEE 802.11n/g/b
- Wireless Interface (5 GHz): IEEE 802.11 ac/n/a
- Four 10/100/1000 Mbps LAN ports
- One 10/100/1000 Mbps WAN port
- One USB 2.0 port
- One SuperSpeed USB 3.0 port

Antenna Types

- Six external antennas

Standards

- IEEE 802.11ac^{1,2,3}
- IEEE 802.11b
- IEEE 802.11n
- IEEE 802.11a
- IEEE 802.11g
- IEEE 802.3u
- IEEE 802.3ab
- IEEE 802.1p
- IEEE 802.1q

Security

- WPA™ - Personal
- WPA2™ - Personal
- Wi-Fi Protected Setup (WPS)

Power

- Input: 100 to 240 V AC, 50 / 60 Hz
- Output: 12 V, 3 A

Temperature

- Operating: 0 to 40 °C (32 to 104 °F)
- Storage: -20 to 65 °C (-4 to 149 °F)

Humidity

- Operating: 10% to 90% maximum, non-condensing
- Storage: 5% to 95% maximum, non-condensing

Certifications

- FCC
- CE
- IC

Dimensions

- L x W x H: 221.80 x 201.40 x 58.80 mm (8.70 x 7.90 x 2.30 in)

Weight

- 578 g (1.27 lbs)

¹ Maximum wireless signal rate derived from IEEE Standard 802.11a, 802.11g, 802.11n, and 802.11ac specifications. Actual data throughput will vary. Network conditions and environmental factors - including volume of network traffic, building materials and construction, and network overhead - lower actual data throughput rate. Environmental factors will adversely affect wireless signal range.

² Frequency Range varies depending on country's regulation.

³ The router does not include 5.25-5.35 GHz & 5.47-5.725 GHz in some regions.

Regulatory Statements

Federal Communication Commission Interference Statement

This equipment has been tested and found to comply with the limits for a Class B digital device, pursuant to Part 15 of the FCC Rules. These limits are designed to provide reasonable protection against harmful interference in a residential installation. This equipment generates, uses and can radiate radio frequency energy and, if not installed and used in accordance with the instructions, may cause harmful interference to radio communications. However, there is no guarantee that interference will not occur in a particular installation. If this equipment does cause harmful interference to radio or television reception, which can be determined by turning the equipment off and on, the user is encouraged to try to correct the interference by one of the following measures:

- Reorient or relocate the receiving antenna.
- Increase the separation between the equipment and receiver.
- Connect the equipment into an outlet on a circuit different from that to which the receiver is connected.
- Consult the dealer or an experienced radio/TV technician for help.

Non-modifications Statement:

Any changes or modifications not expressly approved by the party responsible for compliance could void the user's authority to operate this equipment.

Caution:

This device complies with Part 15 of the FCC Rules. Operation is subject to the following two conditions:

- (1) This device may not cause harmful interference, and
- (2) this device must accept any interference received, including interference that may cause undesired operation.

This device and its antenna(s) must not be co-located or operating in conjunction with any other antenna or transmitter except in accordance with FCC multi-transmitter product procedures. For product available in the USA/Canada market, only channel 1~11 can be operated. Selection of other channels is not possible.

Note

The country code selection is for non-USA models only and is not available to all USA models. Per FCC regulations, all WiFi product marketed in the USA must be fixed to USA operational channels only.

RF Frequency Requirements

This device is for indoor use only when using all channels in the 5.150 GHz-5.250 GHz, 5.250 GHz-5.350 GHz, 5.470 GHz-5.725 GHz frequency range. High power radars are allocated as primary users of the 5.150 GHz-5.250 GHz, 5.250 GHz-5.350 GHz, 5.470 GHz-5.725 GHz bands. These radar stations can cause interference with and/or damage this device. This device will not operate on channels which overlap the 5600-5650 MHz band.

It is restricted to indoor environments only.

IMPORTANT NOTICE:

FCC Radiation Exposure Statement

This equipment complies with FCC radiation exposure limits set forth for an uncontrolled environment. This equipment should be installed and operated with minimum distance 36 cm between the radiator and your body.

Innovation, Science and Economic Development Canada (ISED) Statement:

This Class B digital apparatus complies with Canadian ICES-003.

Cet appareil numérique de la classe B est conforme à la norme NMB-003 du Canada.

Innovation, Science and Economic Development Canada (ISED) Statement:

This device complies with ISED licence-exempt RSS standard(s). Operation is subject to the following two conditions:

- (1) this device may not cause interference, and
- (2) this device must accept any interference, including interference that may cause undesired operation of the device.

Le présent appareil est conforme aux CNR d'ISED applicables aux appareils radio exempts de licence. L'exploitation est autorisée aux deux conditions suivantes :

- (1) l'appareil ne doit pas produire de brouillage, et
- (2) l'utilisateur de l'appareil doit accepter tout brouillage radioélectrique subi, même si le brouillage est susceptible d'en compromettre le fonctionnement.

(i) the device for operation in the band 5150-5250 MHz is only for indoor use to reduce the potential for harmful interference to co-channel mobile satellite systems;

(i) les dispositifs fonctionnant dans la bande 5150-5250 MHz sont réservés uniquement pour une utilisation à l'intérieur afin de réduire les risques de brouillage préjudiciable aux systèmes de satellites mobiles utilisant les mêmes canaux;

Operations in the 5.25-5.35 GHz band are restricted to indoor usage only.

Les opérations dans la bande de 5.25-5.35 GHz sont limités à un usage intérieur seulement.

Radiation Exposure Statement

This equipment complies with ISED radiation exposure limits set forth for an uncontrolled environment. This equipment should be installed and operated with minimum distance 38 cm between the radiator and your body.

Déclaration d'exposition aux radiations

Cet équipement est conforme aux limites d'exposition aux rayonnements ISED établies pour un environnement non contrôlé. Cet équipement doit être installé et utilisé avec un minimum de 38 cm de distance entre la source de rayonnement et votre corps.



	Frequency Band(s) Frequenzband Fréquence bande(s) Bandas de Frecuencia Frequenza/e Frequentie(s)	Max. Output Power (EIRP) Max. Output Power Consommation d'énergie max. Potencia máxima de Salida Potenza max. Output Max. Output Power
5 G	5.15 – 5.25 GHz	200 mW
	5.25 – 5.35 GHz	200 mW
	5.47 – 5.725 GHz	1 W
2.4 G	2.4 – 2.4835 GHz	100 mW

European Community Declaration of Conformity:

Česky [Czech]	Tímto D-Link Corporation prohlašuje, že tento produkt, jeho příslušenství a software jsou v souladu se směrnicí 2014/53/EU. Celý text ES prohlášení o shodě vydaného EU a o firmwaru produktu lze stáhnout na stránkách k produktu www.dlink.com .
Dansk [Danish]	D-Link Corporation erklærer herved, at dette produkt, tilbehør og software er i overensstemmelse med direktiv 2014/53/EU. Den fulde tekst i EU-overensstemmelseserklæringen og produktfirmware kan wnloades fra produktsiden hos www.dlink.com .
Deutsch [German]	Hiermit erklärt die D-Link Corporation, dass dieses Produkt, das Zubehör und die Software der Richtlinie 2014/53/EU entsprechen. Der vollständige Text der Konformitätserklärung der Europäischen Gemeinschaft sowie die Firmware zum Produkt stehen Ihnen zum Herunterladen von der Produktseite im Internet auf www.dlink.com zur Verfügung.
Eesti [Estonian]	Käesolevaga kinnitab D-Link Corporation, et see toode, tarvikud ja tarkvara on kooskõlas direktiiviga 2014/53/EL. Euroopa Liidu vastavusdeklaratsiooni täistekst ja toote püsivara on allalaadimiseks saadaval tootelehel www.dlink.com .
English	Hereby, D-Link Corporation, declares that this product, accessories, and software are in compliance with directive 2014/53/EU. The full text of the EU Declaration of Conformity and product firmware are available for download from the product page at www.dlink.com
Español [Spanish]	Por la presente, D-Link Corporation declara que este producto, accesorios y software cumplen con las directivas 2014/53/UE. El texto completo de la declaración de conformidad de la UE y el firmware del producto están disponibles y se pueden descargar desde la página del producto en www.dlink.com .
Ελληνική [Greek]	Με την παρούσα, η D-Link Corporation δηλώνει ότι αυτό το προϊόν, τα αξεσουάρ και το λογισμικό συμμορφώνονται με την Οδηγία 2014/53/ΕΕ. Το πλήρες κείμενο της δήλωσης συμμόρφωσης της ΕΕ και το υλικολογισμικό του προϊόντος είναι διαθέσιμα για λήψη από τη σελίδα του προϊόντος στην τοποθεσία www.dlink.com .
Français [French]	Par les présentes, D-Link Corporation déclare que ce produit, ces accessoires et ce logiciel sont conformes aux directives 2014/53/UE. Le texte complet de la déclaration de conformité de l'UE et le microprogramme du produit sont disponibles au téléchargement sur la page des produits à www.dlink.com .
Italiano [Italian]	Con la presente, D-Link Corporation dichiara che questo prodotto, i relativi accessori e il software sono conformi alla direttiva 2014/53/UE. Il testo completo della dichiarazione di conformità UE e il firmware del prodotto sono disponibili per il download dalla pagina del prodotto su www.dlink.com .

Appendix F - Regulatory Statements

Latviski [Latvian]	Ar šo uzņēmums D-Link Corporation apliecina, ka šis produkts, piederumi un programmatūra atbilst direktīvai 2014/53/ES. ES atbilstības deklarācijas pilno tekstu un produkta aparātprogrammatūru var lejupielādēt attiecīgā produkta lapā vietnē www.dlink.com .
Lietuvių [Lithuanian]	Šiuo dokumentu „D-Link Corporation“ pareiškia, kad šis gaminys, priedai ir programinė įranga atitinka direktyvą 2014/53/ES. Visą ES atitikties deklaracijos tekstą ir gaminio programinę aparatinę įrangą galima atsisiųsti iš gaminio puslapio adresu www.dlink.com .
Nederlands [Dutch]	Hierbij verklaart D-Link Corporation dat dit product, accessoires en software voldoen aan de richtlijnen 2014/53/EU. De volledige tekst van de EU conformiteitsverklaring en productfirmware is beschikbaar voor download van de productpagina op www.dlink.com .
Malti [Maltese]	Bil-preżenti, D-Link Corporation tiddikjara li dan il-prodott, l-aċċessorji, u s-software huma konformi mad-Direttiva 2014/53/UE. Tista' tniżżel it-test s'hiñ tad-dikjarazzjoni ta' konformità tal-UE u l-firmware tal-prodott mill-paġna tal-prodott fuq www.dlink.com .
Magyar [Hungarian]	Ezennel a D-Link Corporation kijelenti, hogy a jelen termék, annak tartozékai és szoftvere megfelelnek a 2014/53/EU sz. rendeletnek. Az EU Megfelelőségi nyilatkozat teljes szövege és a termék firmware a termék oldaláról tölthető le a www.dlink.com címen.
Polski [Polish]	D-Link Corporation niniejszym oświadcza, że ten produkt, akcesoria oraz oprogramowanie są zgodne z dyrektywami 2014/53/EU. Pełen tekst deklaracji zgodności UE oraz oprogramowanie sprzętowe do produktu można pobrać na stronie produktu w witrynie www.dlink.com .
Português [Portuguese]	Desta forma, a D-Link Corporation declara que este produto, os acessórios e o software estão em conformidade com a diretiva 2014/53/UE. O texto completo da declaração de conformidade da UE e do firmware
Slovensko[Slovenian]	Podjetje D-Link Corporation s tem izjavlja, da so ta izdelek, dodatna oprema in programnska oprema skladni z direktivami 2014/53/EU. Celotno besedilo izjave o skladnosti EU in vdelana programska oprema sta na voljo za prenos na strani izdelka na www.dlink.com .
Slovensky [Slovak]	Spoločnosť D-Link týmto vyhlasuje, že tento produkt, príslušenstvo a softvér sú v súlade so smernicou 2014/53/EÚ. Úplné znenie vyhlásenia EÚ o zhode a firmvéri produktu sú k dispozícii na prevzatie zo stránky produktu www.dlink.com .
Suomi [Finnish]	D-Link Corporation täten vakuuttaa, että tämä tuote, lisävarusteet ja ohjelmisto ovat direktiivin 2014/53/EU vaatimusten mukaisia. Täydellinen EU-vaatimustenmukaisuusvakuutus samoin kuin tuotteen laiteohjelmisto ovat ladattavissa osoitteesta www.dlink.com .
Svenska[Swedish]	D-Link Corporation försäkrar härmed att denna produkt, tillbehör och programvara överensstämmer med direktiv 2014/53/EU. Hela texten med EU-försäkran om överensstämmelse och produkt-firmware kan hämtas från produktsidan på www.dlink.com .

Appendix F - Regulatory Statements

Íslenska [Icelandic]	Hér með lýsir D-Link Corporation því yfir að þessi vara, fylgihlutir og hugbúnaður eru í samræmi við tilskipun 2014/53/EB. Sækja má ESB-samræmisýfirlýsinguna í heild sinni og fastbúnað vörunnar af vefsíðu vörunnar á www.dlink.com .
Norsk [Norwegian]	Herved erklærer D-Link Corporation at dette produktet, tilbehøret og programvaren er i samsvar med direktivet 2014/53/EU. Den fullstendige teksten i EU-erklæring om samsvar og produktets fastvare er tilgjengelig for nedlasting fra produktsiden på www.dlink.com .

Warning Statement:

The power outlet should be near the device and easily accessible.

NOTICE OF WIRELESS RADIO LAN USAGE IN THE EUROPEAN COMMUNITY (FOR WIRELESS PRODUCT ONLY):

- This device is restricted to indoor use when operated in the European Community using channels in the 5.15-5.35 GHz band to reduce the potential for interference.
- This device is a 2.4 GHz wideband transmission system (transceiver), intended for use in all EU member states and EFTA countries. This equipment may be operated in AL, AD, BE, BG, DK, DE, FI, FR, GR, GW, IS, IT, HR, LI, LU, MT, MK, MD, MC, NL, NO, AT, PL, PT, RO, SM, SE, RS, SK, ES, CI, HU, and CY.

Usage Notes:

- To remain in conformance with European National spectrum usage regulations, frequency and channel limitations will be applied on the products according to the country where the equipment will be deployed.
- This device is restricted from functioning in Ad-hoc mode while operating in 5 GHz. Ad-hoc mode is direct peer-to-peer communication between two client devices without an Access Point.
- Access points will support DFS (Dynamic Frequency Selection) and TPC (Transmit Power Control) functionality as required when operating in 5 GHz band within the EU.
- Please refer to the product manual or datasheet to check whether your product uses 2.4 GHz and/or 5 GHz wireless.

HINWEIS ZUR VERWENDUNG VON DRAHTLOS-NETZWERK (WLAN) IN DER EUROPÄISCHEN GEMEINSCHAFT (NUR FÜR EIN DRAHTLOSES PRODUKT)

- Der Betrieb dieses Geräts in der Europäischen Gemeinschaft bei Nutzung von Kanälen im 5,15-5,35 GHz Frequenzband ist ausschließlich auf Innenräume beschränkt, um das Interferenzpotential zu reduzieren.
- Bei diesem Gerät handelt es sich um ein zum Einsatz in allen EU-Mitgliedsstaaten und in EFTA-Ländern - ausgenommen Frankreich. Der Betrieb dieses Geräts ist in den folgenden Ländern erlaubt: AL, AD, BE, BG, DK, DE, FI, FR, GR, GW, IS, IT, HR, LI, LU, MT, MK, MD, MC, NL, NO, AT, PL, PT, RO, SM, SE, RS, SK, ES, CI, HU, CY

Gebrauchshinweise:

- Um den in Europa geltenden nationalen Vorschriften zum Nutzen des Funkspektrums weiterhin zu entsprechen, werden Frequenz und Kanalbeschränkungen, dem jeweiligen Land, in dem das Gerät zum Einsatz kommt, entsprechend, auf die Produkte angewandt.
- Die Funktionalität im Ad-hoc-Modus bei Betrieb auf 5 GHz ist für dieses Gerät eingeschränkt. Bei dem Ad-hoc-Modus handelt es sich um eine Peer-to-Peer-Kommunikation zwischen zwei Client-Geräten ohne einen Access Point.
- Access Points unterstützen die Funktionen DFS (Dynamic Frequency Selection) und TPC (Transmit Power Control) wie erforderlich bei Betrieb auf 5 GHz innerhalb der EU.
- Bitte schlagen Sie im Handbuch oder Datenblatt nach nach, ob Ihr Gerät eine 2,4 GHz und / oder 5 GHz Verbindung nutzt.

AVIS CONCERNANT L'UTILISATION DE LA RADIO SANS FIL LAN DANS LA COMMUNAUTÉ EUROPÉENNE (UNIQUEMENT POUR LES PRODUITS SANS FIL)

- Cet appareil est limité à un usage intérieur lorsqu'il est utilisé dans la Communauté européenne sur les canaux de la bande de 5,15 à 5,35 GHz afin de réduire les risques d'interférences.
- Cet appareil est un système de transmission à large bande (émetteur-récepteur) de 2,4 GHz, destiné à être utilisé dans tous les États-membres de l'UE et les pays de l'AELE. Cet équipement peut être utilisé dans les pays suivants : AL, AD, BE, BG, DK, DE, FI, FR, GR, GW, IS, IT, HR, LI, LU, MT, MK, MD, MC, NL, NO, AT, PL, PT, RO, SM, SE, RS, SK, ES, CI, HU, CY

Notes d'utilisation:

- Pour rester en conformité avec la réglementation nationale européenne en matière d'utilisation du spectre, des limites de fréquence et de canal seront appliquées aux produits selon le pays où l'équipement sera déployé.
- Cet appareil ne peut pas utiliser le mode Ad-hoc lorsqu'il fonctionne dans la bande de 5 GHz. Le mode Adhoc fournit une communication directe pair à pair entre deux périphériques clients sans point d'accès.
- Les points d'accès prendront en charge les fonctionnalités DFS (Dynamic Frequency Selection) et TPC (Transmit Power Control) au besoin lors du fonctionnement dans la bande de 5 GHz au sein de l'UE.
- Merci de vous référer au guide d'utilisation ou de la fiche technique afin de vérifier si votre produit utilise 2.4 GHz et/ou 5 GHz sans fil.

AVISO DE USO DE LA LAN DE RADIO INALÁMBRICA EN LA COMUNIDAD EUROPEA (SOLO PARA EL PRODUCTO INALÁMBRICO)

- El uso de este dispositivo está restringido a interiores cuando funciona en la Comunidad Europea utilizando canales en la banda de 5,15-5,35 GHz, para reducir la posibilidad de interferencias.
- Este dispositivo es un sistema de transmisión (transceptor) de banda ancha de 2,4 GHz, pensado para su uso en todos los estados miembros de la UE y en los países de la AELC. Este equipo se puede utilizar en AL, AD, BE, BG, DK, DE, FI, FR, GR, GW, IS, IT, HR, LI, LU, MT, MK, MD, MC, NL, NO, AT, PL, PT, RO, SM, SE, RS, SK, ES, CI, HU, CY

Notas de uso:

- Para seguir cumpliendo las normas europeas de uso del espectro nacional, se aplicarán limitaciones de frecuencia y canal en los productos en función del país en el que se pondrá en funcionamiento el equipo.
- Este dispositivo tiene restringido el funcionamiento en modo Ad-hoc mientras funcione a 5 Ghz. El modo Ad-hoc es la comunicación directa de igual a igual entre dos dispositivos cliente sin un punto de acceso.
- Los puntos de acceso admitirán la funcionalidad DFS (Selección de frecuencia dinámica) y TPC (Control de la potencia de transmisión) si es necesario cuando funcionan a 5 Ghz dentro de la UE.
- Por favor compruebe el manual o la ficha de producto para comprobar si el producto utiliza las bandas inalámbricas de 2.4 GHz y/o la de 5 GHz.

AVVISO PER L'USO DI LAN RADIO WIRELESS NELLA COMUNITÀ EUROPEA (SOLO PER PRODOTTI WIRELESS)

- Nella Comunità europea, l'uso di questo dispositivo è limitato esclusivamente agli ambienti interni sui canali compresi nella banda da 5,15 a 5,35 GHz al fine di ridurre potenziali interferenze. Questo dispositivo è un sistema di trasmissione a banda larga a 2,4 GHz (ricetrasmittente), destinato all'uso in tutti gli stati membri dell'Unione europea e nei paesi EFTA.
- Questo dispositivo può essere utilizzato in AL, AD, BE, BG, DK, DE, FI, FR, GR, GW, IS, IT, HR, LI, LU, MT, MK, MD, MC, NL, NO, AT, PL, PT, RO, SM, SE, RS, SK, ES, CI, HU, CY

Note per l'uso

- Al fine di mantenere la conformità alle normative nazionali europee per l'uso dello spettro di frequenze, saranno applicate limitazioni sulle frequenze e sui canali per il prodotto in conformità alle normative del paese in cui il dispositivo viene utilizzato.
- Questo dispositivo non può essere attivato in modalità Ad-hoc durante il funzionamento a 5 GHz. La modalità Ad-hoc è una comunicazione diretta peer-to-peer fra due dispositivi client senza un punto di accesso.
- I punti di accesso supportano le funzionalità DFS (Dynamic Frequency Selection) e TPC (Transmit Power Control) richieste per operare a 5 GHz nell'Unione europea.
- Ti invitiamo a fare riferimento al manuale del prodotto o alla scheda tecnica per verificare se il tuo prodotto utilizza le frequenze 2,4 GHz e/o 5 GHz.

KENNISGEVING VAN DRAADLOOS RADIO LAN-GEbruik IN DE EUROPESE GEMEENSCHAP (ALLEEN VOOR DRAADLOOS PRODUCT)

- Dit toestel is beperkt tot gebruik binnenshuis wanneer het wordt gebruikt in de Europese Gemeenschap gebruik makend van kanalen in de 5.15-5.35 GHz band om de kans op interferentie te beperken.
- Dit toestel is een 2.4 GHz breedband transmissiesysteem (transceiver) dat bedoeld is voor gebruik in alle EU lidstaten en EFTA landen. Deze uitrusting mag gebruikt worden in AL, AD, BE, BG, DK, DE, FI, FR, GR, GW, IS, IT, HR, LI, LU, MT, MK, MD, MC, NL, NO, AT, PL, PT, RO, SM, SE, RS, SK, ES, CI, HU, CY

Gebruiksaanwijzingen:

- Om de gebruiksvoorschriften van het Europese Nationale spectrum na te leven, zullen frequentie- en kanaalbeperkingen worden toegepast op de producten volgens het land waar de uitrusting gebruikt zal worden.
- Dit toestel kan niet functioneren in Ad-hoc mode wanneer het gebruikt wordt in 5 GHz. Ad-hoc mode is directe peer-to-peer communicatie tussen twee klantenapparaten zonder een toegangspunt.
- Toegangspunten ondersteunen DFS (Dynamic Frequency Selection) en TPC (Transmit Power Control) functionaliteit zoals vereist bij gebruik in 5 GHz binnen de EU.
- Raadpleeg de handleiding of de datasheet om te controleren of uw product gebruik maakt van 2.4 GHz en/of 5 GHz.

SAFETY INSTRUCTIONS

The following general safety guidelines are provided to help ensure your own personal safety and protect your product from potential damage. Remember to consult the product user instructions for more details.

- Static electricity can be harmful to electronic components. Discharge static electricity from your body (i.e. touching grounded bare metal) before touching the product.
- Do not attempt to service the product and never disassemble the product. For some products with a user replaceable battery, please read and follow the instructions in the user manual.
- Do not spill food or liquid on your product and never push any objects into the openings of your product.
- Do not use this product near water, areas with high humidity, or condensation unless the product is specifically rated for outdoor application.
- Keep the product away from radiators and other heat sources.
- Always unplug the product from mains power before cleaning and use a dry lint free cloth only.

SICHERHEITSVORSCHRIFTEN

Die folgenden allgemeinen Sicherheitsvorschriften dienen als Hilfe zur Gewährleistung Ihrer eigenen Sicherheit und zum Schutz Ihres Produkts. Weitere Details finden Sie in den Benutzeranleitungen zum Produkt.

- Statische Elektrizität kann elektronischen Komponenten schaden. Um Schäden durch statische Aufladung zu vermeiden, leiten Sie elektrostatische Ladungen von Ihrem Körper ab, (z. B. durch Berühren eines geerdeten blanken Metallteils), bevor Sie das Produkt berühren.
- Unterlassen Sie jeden Versuch, das Produkt zu warten, und versuchen Sie nicht, es in seine Bestandteile zu zerlegen. Für einige Produkte mit austauschbaren Akkus lesen Sie bitte das Benutzerhandbuch und befolgen Sie die dort beschriebenen Anleitungen.
- Vermeiden Sie, dass Speisen oder Flüssigkeiten auf Ihr Produkt gelangen, und stecken Sie keine Gegenstände in die Gehäuseschlitze oder -öffnungen Ihres Produkts.
- Verwenden Sie dieses Produkt nicht in unmittelbarer Nähe von Wasser und nicht in Bereichen mit hoher Luftfeuchtigkeit oder Kondensation, es sei denn, es ist speziell zur Nutzung in Außenbereichen vorgesehen und eingestuft.
- Halten Sie das Produkt von Heizkörpern und anderen Quellen fern, die Wärme erzeugen.
- Trennen Sie das Produkt immer von der Stromzufuhr, bevor Sie es reinigen und verwenden Sie dazu ausschließlich ein trockenes fusselfreies Tuch.

CONSIGNES DE SÉCURITÉ

Les consignes générales de sécurité ci-après sont fournies afin d'assurer votre sécurité personnelle et de protéger le produit d'éventuels dommages. Veuillez consulter les consignes d'utilisation du produit pour plus de détails.

- L'électricité statique peut endommager les composants électroniques. Déchargez l'électricité statique de votre corps (en touchant un objet en métal relié à la terre par exemple) avant de toucher le produit.
- N'essayez pas d'intervenir sur le produit et ne le démontez jamais. Pour certains produits contenant une batterie remplaçable par l'utilisateur, veuillez lire et suivre les consignes contenues dans le manuel d'utilisation.
- Ne renversez pas d'aliments ou de liquide sur le produit et n'insérez jamais d'objets dans les orifices.
- N'utilisez pas ce produit à proximité d'un point d'eau, de zones très humides ou de condensation sauf si le produit a été spécifiquement conçu pour une application extérieure.
- Éloignez le produit des radiateurs et autres sources de chaleur.
- Débranchez toujours le produit de l'alimentation avant de le nettoyer et utilisez uniquement un chiffon sec non pelucheux.

INSTRUCCIONES DE SEGURIDAD

Las siguientes directrices de seguridad general se facilitan para ayudarle a garantizar su propia seguridad personal y para proteger el producto frente a posibles daños. No olvide consultar las instrucciones del usuario del producto para obtener más información.

- La electricidad estática puede resultar nociva para los componentes electrónicos. Descargue la electricidad estática de su cuerpo (p. ej., tocando algún metal sin revestimiento conectado a tierra) antes de tocar el producto.
- No intente realizar el mantenimiento del producto ni lo desmonte nunca. Para algunos productos con batería reemplazable por el usuario, lea y siga las instrucciones del manual de usuario.
- No derrame comida o líquidos sobre el producto y nunca deje que caigan objetos en las aberturas del mismo.
- No utilice este producto cerca del agua, en zonas con humedad o condensación elevadas a menos que el producto esté clasificado específicamente para aplicación en exteriores.
- Mantenga el producto alejado de los radiadores y de otras fuentes de calor.
- Desenchufe siempre el producto de la alimentación de red antes de limpiarlo y utilice solo un paño seco sin pelusa.

ISTRUZIONI PER LA SICUREZZA

Le seguenti linee guida sulla sicurezza sono fornite per contribuire a garantire la sicurezza personale degli utenti e a proteggere il prodotto da potenziali danni. Per maggiori dettagli, consultare le istruzioni per l'utente del prodotto.

- L'elettricità statica può essere pericolosa per i componenti elettronici. Scaricare l'elettricità statica dal corpo (ad esempio toccando una parte metallica collegata a terra) prima di toccare il prodotto.
- Non cercare di riparare il prodotto e non smontarlo mai. Per alcuni prodotti dotati di batteria sostituibile dall'utente, leggere e seguire le istruzioni riportate nel manuale dell'utente.
- Non versare cibi o liquidi sul prodotto e non spingere mai alcun oggetto nelle aperture del prodotto.
- Non usare questo prodotto vicino all'acqua, in aree con elevato grado di umidità o soggette a condensa a meno che il prodotto non sia specificatamente approvato per uso in ambienti esterni.
- Tenere il prodotto lontano da caloriferi e altre fonti di calore.
- Scollegare sempre il prodotto dalla presa elettrica prima di pulirlo e usare solo un panno asciutto che non lasci filacce.

VEILIGHEIDSINFORMATIE

De volgende algemene veiligheidsinformatie werd verstrekt om uw eigen persoonlijke veiligheid te waarborgen en uw product te beschermen tegen mogelijke schade. Denk eraan om de gebruikersinstructies van het product te raadplegen voor meer informatie.

- Statische elektriciteit kan schadelijk zijn voor elektronische componenten. Ontlaad de statische elektriciteit van uw lichaam (d.w.z. het aanraken van geaard bloot metaal) voordat u het product aanraakt.
- U mag nooit proberen het product te onderhouden en u mag het product nooit demonteren. Voor sommige producten met door de gebruiker te vervangen batterij, dient u de instructies in de gebruikershandleiding te lezen en te volgen.
- Mors geen voedsel of vloeistof op uw product en u mag nooit voorwerpen in de openingen van uw product duwen.
- Gebruik dit product niet in de buurt van water, gebieden met hoge vochtigheid of condensatie, tenzij het product specifiek geclassificeerd is voor gebruik buitenshuis.
- Houd het product uit de buurt van radiators en andere warmtebronnen.
- U dient het product steeds los te koppelen van de stroom voordat u het reinigt en gebruik uitsluitend een droge pluisvrije doek.

Disposing and Recycling Your Product

ENGLISH

EN



This symbol on the product or packaging means that according to local laws and regulations this product should be not be disposed of in household waste but sent for recycling. Please take it to a collection point designated by your local authorities once it has reached the end of its life, some will accept products for free. By recycling the product and its packaging in this manner you help to conserve the environment and protect human health.

D-Link and the Environment

At D-Link, we understand and are committed to reducing any impact our operations and products may have on the environment. To minimise this impact D-Link designs and builds its products to be as environmentally friendly as possible, by using recyclable, low toxic materials in both products and packaging.

D-Link recommends that you always switch off or unplug your D-Link products when they are not in use. By doing so you will help to save energy and reduce CO2 emissions.

To learn more about our environmentally responsible products and packaging please visit www.dlinkgreen.com.

DEUTSCH

DE



Dieses Symbol auf dem Produkt oder der Verpackung weist darauf hin, dass dieses Produkt gemäß bestehender örtlicher Gesetze und Vorschriften nicht über den normalen Hausmüll entsorgt werden sollte, sondern einer Wiederverwertung zuzuführen ist. Bringen Sie es bitte zu einer von Ihrer Kommunalbehörde entsprechend amtlich ausgewiesenen Sammelstelle, sobald das Produkt das Ende seiner Nutzungsdauer erreicht hat. Für die Annahme solcher Produkte erheben einige dieser Stellen keine Gebühren. Durch ein auf diese Weise durchgeführtes Recycling des Produkts und seiner Verpackung helfen Sie, die Umwelt zu schonen und die menschliche Gesundheit zu schützen.

D-Link und die Umwelt

D-Link ist sich den möglichen Auswirkungen seiner Geschäftstätigkeiten und seiner Produkte auf die Umwelt bewusst und fühlt sich verpflichtet, diese entsprechend zu mindern. Zu diesem Zweck entwickelt und stellt D-Link seine Produkte mit dem Ziel größtmöglicher Umweltfreundlichkeit her und verwendet wiederverwertbare, schadstoffarme Materialien bei Produktherstellung und Verpackung.

D-Link empfiehlt, Ihre Produkte von D-Link, wenn nicht in Gebrauch, immer auszuschalten oder vom Netz zu nehmen. Auf diese Weise helfen Sie, Energie zu sparen und CO2-Emissionen zu reduzieren.

Wenn Sie mehr über unsere umweltgerechten Produkte und Verpackungen wissen möchten, finden Sie entsprechende Informationen im Internet unter www.dlinkgreen.com.

FRANÇAIS**FR**

Ce symbole apposé sur le produit ou son emballage signifie que, conformément aux lois et réglementations locales, ce produit ne doit pas être éliminé avec les déchets domestiques mais recyclé. Veuillez le rapporter à un point de collecte prévu à cet effet par les autorités locales; certains accepteront vos produits gratuitement. En recyclant le produit et son emballage de cette manière, vous aidez à préserver l'environnement et à protéger la santé de l'homme.

D-Link et l'environnement

Chez D-Link, nous sommes conscients de l'impact de nos opérations et produits sur l'environnement et nous engageons à le réduire. Pour limiter cet impact, D-Link conçoit et fabrique ses produits de manière aussi écologique que possible, en utilisant des matériaux recyclables et faiblement toxiques, tant dans ses produits que ses emballages.

D-Link recommande de toujours éteindre ou débrancher vos produits D-Link lorsque vous ne les utilisez pas. Vous réaliserez ainsi des économies d'énergie et réduirez vos émissions de CO2.

Pour en savoir plus sur les produits et emballages respectueux de l'environnement, veuillez consulter le www.dlinkgreen.com.

ESPAÑOL**ES**

Este símbolo en el producto o el embalaje significa que, de acuerdo con la legislación y la normativa local, este producto no se debe desechar en la basura doméstica sino que se debe reciclar. Llévelo a un punto de recogida designado por las autoridades locales una vez que ha llegado al fin de su vida útil; algunos de ellos aceptan recogerlos de forma gratuita. Al reciclar el producto y su embalaje de esta forma, contribuye a preservar el medio ambiente y a proteger la salud de los seres humanos.

D-Link y el medio ambiente

En D-Link, comprendemos y estamos comprometidos con la reducción del impacto que puedan tener nuestras actividades y nuestros productos en el medio ambiente. Para reducir este impacto, D-Link diseña y fabrica sus productos para que sean lo más ecológicos posible, utilizando materiales reciclables y de baja toxicidad tanto en los productos como en el embalaje.

D-Link recomienda apagar o desenchufar los productos D-Link cuando no se estén utilizando. Al hacerlo, contribuirá a ahorrar energía y a reducir las emisiones de CO2.

Para obtener más información acerca de nuestros productos y embalajes ecológicos, visite el sitio www.dlinkgreen.com.

ITALIANO**IT**

La presenza di questo simbolo sul prodotto o sulla confezione del prodotto indica che, in conformità alle leggi e alle normative locali, questo prodotto non deve essere smaltito nei rifiuti domestici, ma avviato al riciclo. Una volta terminato il ciclo di vita utile, portare il prodotto presso un punto di raccolta indicato dalle autorità locali. Alcuni questi punti di raccolta accettano gratuitamente i prodotti da riciclare. Scegliendo di riciclare il prodotto e il relativo imballaggio, si contribuirà a preservare l'ambiente e a salvaguardare la salute umana.

D-Link e l'ambiente

D-Link cerca da sempre di ridurre l'impatto ambientale dei propri stabilimenti e dei propri prodotti. Allo scopo di ridurre al minimo tale impatto, D-Link progetta e realizza i propri prodotti in modo che rispettino il più possibile l'ambiente, utilizzando materiali riciclabili a basso tasso di tossicità sia per i prodotti che per gli imballaggi.

D-Link raccomanda di spegnere sempre i prodotti D-Link o di scollegarne la spina quando non vengono utilizzati. In questo modo si contribuirà a risparmiare energia e a ridurre le emissioni di anidride carbonica.

Per ulteriori informazioni sui prodotti e sugli imballaggi D-Link a ridotto impatto ambientale, visitate il sito all'indirizzo www.dlinkgreen.com.

NEDERLANDS**NL**

Dit symbool op het product of de verpakking betekent dat dit product volgens de plaatselijke wetgeving niet mag worden weggegooid met het huishoudelijk afval, maar voor recyclage moeten worden ingeleverd. Zodra het product het einde van de levensduur heeft bereikt, dient u het naar een inzamelpunt te brengen dat hiertoe werd aangeduid door uw plaatselijke autoriteiten, sommige autoriteiten accepteren producten zonder dat u hiervoor dient te betalen. Door het product en de verpakking op deze manier te recyclen helpt u het milieu en de gezondheid van de mens te beschermen.

D-Link en het milieu

Bij D-Link spannen we ons in om de impact van onze handelingen en producten op het milieu te beperken. Om deze impact te beperken, ontwerpt en bouwt D-Link zijn producten zo milieuvriendelijk mogelijk, door het gebruik van recycleerbare producten met lage toxiciteit in product en verpakking.

D-Link raadt aan om steeds uw D-Link producten uit te schakelen of uit de stekker te halen wanneer u ze niet gebruikt. Door dit te doen bespaart u energie en beperkt u de CO₂-emissies.

Breng een bezoek aan www.dlinkgreen.com voor meer informatie over onze milieuverantwoorde producten en verpakkingen.

POLSKI**PL**

Ten symbol umieszczony na produkcie lub opakowaniu oznacza, że zgodnie z miejscowym prawem i lokalnymi przepisami niniejszego produktu nie wolno wyrzucać jak odpady czy śmieci z gospodarstwa domowego, lecz należy go poddać procesowi recyklingu. Po zakończeniu użytkowania produktu, niektóre odpowiednie do tego celu podmioty przyjmą takie produkty nieodpłatnie, dlatego prosimy dostarczyć go do punktu zbiórki wskazanego przez lokalne władze. Poprzez proces recyklingu i dzięki takiemu postępowaniu z produktem oraz jego opakowaniem, pomogą Państwo chronić środowisko naturalne i dbać o ludzkie zdrowie.

D-Link i środowisko

D-Link podchodzimy w sposób świadomy do ochrony otoczenia oraz jesteśmy zaangażowani w zmniejszanie wpływu naszych działań i produktów na środowisko naturalne. W celu zminimalizowania takiego wpływu firma D-Link konstruuje i wytwarza swoje produkty w taki sposób, aby były one jak najbardziej przyjazne środowisku, stosując do tych celów materiały nadające się do powtórnego wykorzystania, charakteryzujące się małą toksycznością zarówno w przypadku samych produktów jak i opakowań.

Firma D-Link zaleca, aby Państwo zawsze prawidłowo wyłączali z użytku swoje produkty D-Link, gdy nie są one wykorzystywane. Postępując w ten sposób pozwalają Państwo oszczędzać energię i zmniejszać emisje CO₂.

Aby dowiedzieć się więcej na temat produktów i opakowań mających wpływ na środowisko prosimy zapoznać się ze stroną Internetową www.dlinkgreen.com.

ČESKY**CZ**

Tento symbol na výrobku nebo jeho obalu znamená, že podle místně platných předpisů se výrobek nesmí vyhazovat do komunálního odpadu, ale odeslat k recyklaci. Až výrobek doslouží, odnese jej prosím na sběrné místo určené místními úřady k tomuto účelu. Někteřá sběrná místa přijímají výrobky zdarma. Recyklací výrobku i obalu pomáháte chránit životní prostředí i lidské zdraví.

D-Link a životní prostředí

Ve společnosti D-Link jsme si vědomi vlivu našich provozů a výrobků na životní prostředí a snažíme se o minimalizaci těchto vlivů. Proto své výrobky navrhujeme a vyrábíme tak, aby byly co nejekologičtější, a ve výrobcích i obalech používáme recyklovatelné a nízkotoxické materiály.

Společnost D-Link doporučuje, abyste své výrobky značky D-Link vypnuli nebo vytáhli ze zásuvky vždy, když je nepoužíváte. Pomůžete tak šetřit energii a snížit emise CO₂.

Více informací o našich ekologických výrobcích a obalech najdete na adrese www.dlinkgreen.com.

MAGYAR**HU**

Ez a szimbólum a terméken vagy a csomagoláson azt jelenti, hogy a helyi törvényeknek és szabályoknak megfelelően ez a termék nem semmisíthető meg a háztartási hulladékkal együtt, hanem újrahasznosításra kell küldeni. Kérjük, hogy a termék élettartamának elteltét követően vigye azt a helyi hatóság által kijelölt gyűjtőhelyre. A termékek egyes helyeken ingyen elhelyezhetők. A termék és a csomagolás újrahasznosításával segíti védeni a környezetet és az emberek egészségét.

A D-Link és a környezet

A D-Linknél megértjük és elköteleztük magunkat a műveleteink és termékeink környezetre gyakorolt hatásainak csökkentésére. Az ezen hatás csökkentése érdekében a D-Link a lehető leginkább környezetbarát termékeket tervez és gyárt azáltal, hogy újrahasznosítható, alacsony károsanyag-tartalmú termékeket gyárt és csomagolásokat alkalmaz.

A D-Link azt javasolja, hogy mindig kapcsolja ki vagy húzza ki a D-Link termékeket a tápforrásból, ha nem használja azokat. Ezzel segít az energia megtakarításában és a széndioxid kibocsátásának csökkentésében.

Környezetbarát termékeinkről és csomagolásainkról további információkat a www.dlinkgreen.com weboldalon tudhat meg.

NORSK**NO**

Dette symbolet på produktet eller forpakningen betyr at dette produktet ifølge lokale lover og forskrifter ikke skal kastes sammen med husholdningsavfall, men leveres inn til gjenvinning. Vennligst ta det til et innsamlingssted anvist av lokale myndigheter når det er kommet til slutten av levetiden. Noen steder aksepteres produkter uten avgift. Ved på denne måten å gjenvinne produktet og forpakningen hjelper du å verne miljøet og beskytte folks helse.

D-Link og miljøet

Hos D-Link forstår vi oss på og er forpliktet til å minske innvirkningen som vår drift og våre produkter kan ha på miljøet. For å minimalisere denne innvirkningen designer og lager D-Link produkter som er så miljøvennlig som mulig, ved å bruke resirkulerbare, lav-toksiske materialer både i produktene og forpakningen.

D-Link anbefaler at du alltid slår av eller frakobler D-Link-produkter når de ikke er i bruk. Ved å gjøre dette hjelper du å spare energi og å redusere CO2-utslipp.

For mer informasjon angående våre miljøansvarlige produkter og forpakninger kan du gå til www.dlinkgreen.com.

DANSK**DK**

Dette symbol på produktet eller emballagen betyder, at dette produkt i henhold til lokale love og regler ikke må bortskaffes som husholdningsaffald, mens skal sendes til genbrug. Indlever produktet til et indsamlingssted som angivet af de lokale myndigheder, når det er nået til slutningen af dets levetid. I nogle tilfælde vil produktet blive modtaget gratis. Ved at indlevere produktet og dets emballage til genbrug på denne måde bidrager du til at beskytte miljøet og den menneskelige sundhed.

D-Link og miljøet

Hos D-Link forstår vi og bestræber os på at reducere enhver indvirkning, som vores aktiviteter og produkter kan have på miljøet. For at minimere denne indvirkning designer og producerer D-Link sine produkter, så de er så miljøvenlige som muligt, ved at bruge genanvendelige materialer med lavt giftighedsniveau i både produkter og emballage.

D-Link anbefaler, at du altid slukker eller frakobler dine D-Link-produkter, når de ikke er i brug. Ved at gøre det bidrager du til at spare energi og reducere CO₂-udledningerne.

Du kan finde flere oplysninger om vores miljømæssigt ansvarlige produkter og emballage på www.dlinkgreen.com.

SUOMI**FI**

Tämä symboli tuotteen pakkauksessa tarkoittaa, että paikallisten lakien ja säännösten mukaisesti tätä tuotetta ei pidä hävittää yleisen kotitalousjätteen seassa vaan se tulee toimittaa kierrätettäväksi. Kun tuote on elinkaarensa päässä, toimita se lähimpään viranomaisten hyväksymään kierrätyspisteeseen. Kierrättämällä käytetyn tuotteen ja sen pakkauksen autat tukemaan sekä ympäristön että ihmisten terveyttä ja hyvinvointia.

D-Link ja ympäristö

D-Link ymmärtää ympäristönsuojelun tärkeyden ja on sitoutunut vähentämään tuotteistaan ja niiden valmistuksesta ympäristölle mahdollisesti aiheutuvia haittavaikutuksia. Nämä negatiiviset vaikutukset minimoidakseen D-Link suunnittelee ja valmistaa tuotteensa mahdollisimman ympäristöystävällisiksi käyttämällä kierrätettäviä, alhaisia pitoisuuksia haitallisia aineita sisältäviä materiaaleja sekä tuotteissaan että niiden pakkauksissa.

Suosittellemme, että irrotat D-Link-tuotteesi virtalähteestä tai sammutat ne aina, kun ne eivät ole käytössä. Toimimalla näin autat säästämään energiaa ja vähentämään hiilidioksiidipäästöjä.

Lue lisää ympäristöystävällisistä D-Link-tuotteista ja pakkauksistamme osoitteesta www.dlinkgreen.com.

SVENSKA**SE**

Den här symbolen på produkten eller förpackningen betyder att produkten enligt lokala lagar och föreskrifter inte skall kastas i hushållssoporna utan i stället återvinnas. Ta den vid slutet av dess livslängd till en av din lokala myndighet utsedd uppsamlingsplats, vissa accepterar produkter utan kostnad. Genom att på detta sätt återvinna produkten och förpackningen hjälper du till att bevara miljön och skydda människors hälsa.

D-Link och miljön

På D-Link förstår vi och är fast beslutna att minska den påverkan våra verksamheter och produkter kan ha på miljön. För att minska denna påverkan utformar och bygger D-Link sina produkter för att de ska vara så miljövänliga som möjligt, genom att använda återvinningsbara material med låg gifthalt i både produkter och förpackningar.

D-Link rekommenderar att du alltid stänger av eller kopplar ur dina D-Link produkter när du inte använder dem. Genom att göra detta hjälper du till att spara energi och minska utsläpp av koldioxid.

För mer information om våra miljöansvariga produkter och förpackningar www.dlinkgreen.com.

PORTUGUÊS**PT**

Este símbolo no produto ou embalagem significa que, de acordo com as leis e regulamentações locais, este produto não deverá ser eliminado juntamente com o lixo doméstico mas enviado para a reciclagem. Transporte-o para um ponto de recolha designado pelas suas autoridades locais quando este tiver atingido o fim da sua vida útil, alguns destes pontos aceitam produtos gratuitamente. Ao reciclar o produto e respectiva embalagem desta forma, ajuda a preservar o ambiente e protege a saúde humana.

A D-Link e o ambiente

Na D-Link compreendemos e comprometemo-nos com a redução do impacto que as nossas operações e produtos possam ter no ambiente. Para minimizar este impacto a D-Link concebe e constrói os seus produtos para que estes sejam o mais inofensivos para o ambiente possível, utilizando materiais recicláveis e não tóxicos tanto nos produtos como nas embalagens.

A D-Link recomenda que desligue os seus produtos D-Link quando estes não se encontrarem em utilização. Com esta acção ajudará a poupar energia e reduzir as emissões de CO₂.

Para saber mais sobre os nossos produtos e embalagens responsáveis a nível ambiental visite www.dlinkgreen.com.