

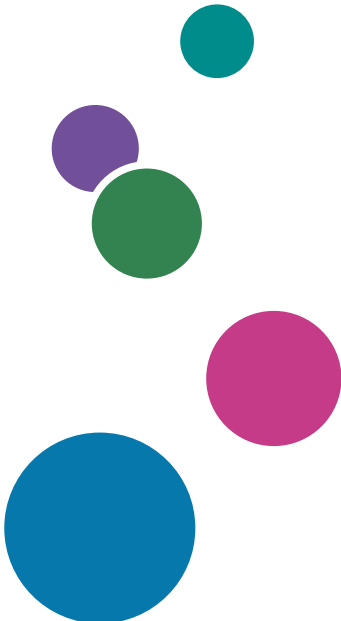

User Guide

Selected Version

Getting Started	1
Copy	2
Fax	3
Print	4
Scan	5
Web Image Monitor	6
Adding Paper and Toner	7
Troubleshooting	8
Specifications for The Machine	9
Legal and Contact Information	10



For information not found in this manual, see the online manuals available on our web site (<https://www.ricoh.com/>) or via the control panel.



For safe and correct use, be sure to read Safety Information before using the machine.

How to Read the Manuals

Symbols Used in the Manuals

This manual uses the following symbols:

 **Important**

Indicates points to pay attention to when using the machine, and explanations of likely causes of paper misfeeds, damage to originals, or loss of data. Be sure to read these explanations.

 **Note**

Indicates supplementary explanations of the machine's functions, and instructions on resolving user errors.

[]

Indicates the names of keys on the machine's display or control panels.

TABLE OF CONTENTS

How to Read the Manuals.....	1
Symbols Used in the Manuals.....	1
1. Getting Started	
Turning On and Off the Power.....	9
Turning On the Main Power.....	9
Turning Off the Main Power.....	10
Energy Saving Mode.....	10
Guide to Names and Functions of Components.....	12
Front and Right View.....	13
Rear and Left View.....	15
Names and Functions of the Control Panel.....	17
Touch Panel/Interface.....	17
LED Indicators.....	18
Changing the Display Language.....	20
How to Use the Home Screen.....	21
Intuitive Screen Operation Using Fingertips.....	23
How to Use the Copy Screen.....	26
How to Use the Copy Screen (Standard View).....	27
How to Use the Copy Screen (Full View).....	28
How to Use the Fax Screen.....	29
How to Use the Scanner Screen.....	30
Adding a Frequently Used Application or Widget to the Home Screen.....	31
Adding an Icon/Widget to the Home Screen.....	31
Moving or Deleting Icons and Widgets.....	32
Creating a Folder to Organize Icons.....	32
Registering Frequently Used Settings as a Program.....	34
Registering Settings as a Program.....	34
Changing the Contents of the Program.....	36
Logging In from the Control Panel.....	38
Logging In by Entering the User Name and Password.....	39
Logging In Using an IC Card.....	40
Logging In Using a Mobile Device.....	41
Authenticating Using the User Code.....	41

Changing the Login Password.....	42
Placing an Original on the Exposure Glass.....	44
Placing an Original in the Auto Document Feeder (ADF).....	46
Placing Originals in the ADF.....	47

2. Copy

Basic Procedure for Copying Documents.....	51
Making Enlarged or Reduced Copies.....	53
Specifying a Copy Ratio or Size.....	53
Enlarging or Reducing According to the Paper Size.....	55
Duplex Copying.....	57
Combining and Copying a Multi-page Original onto a Single Sheet of Paper.....	59
Copying Onto Envelopes.....	62
Copying in Page Order or for Each Page Number.....	64

3. Fax

Basic Procedure for Transmitting Faxes.....	67
Registering Fax Numbers in the Address Book.....	69
Registering a Fax Number and Send Conditions.....	69
Changing/Deleting the Registered Data Such as Fax Number.....	71
Viewing the Transmission Result of Sent Faxes.....	72
Confirming the Information on the Fax Screen.....	72
Checking the Result in Communication Failure Report.....	73
Confirming the Information in Web Image Monitor.....	73

4. Print

Installing the Printer Driver by Using Device Software Manager Installer.....	75
Installing Device Software Manager from the CD-ROM.....	75
Installing Device Software Manager from the Downloaded File.....	77
Installing the Printer Driver for Network Connection (Windows).....	81
Installing the PCL 6 Printer Driver from the CD-ROM.....	81
Installing the PostScript 3 Printer Driver from the CD-ROM.....	84
Installing the PCL 6/PostScript 3 Printer Driver from the Downloaded File.....	86
If the Machine Cannot Be Found.....	87
Installing the Printer Driver for Network Connection (OS X/macOS).....	91
Installing the PPD file.....	91

Registering the Machine in [Print & Scan] or [Printers & Scanners].....	92
Specifying the Option Settings.....	95
Basic Procedure for Printing Documents.....	97
Printing a Document in Windows.....	97
Printing a Document in OS X/macOS.....	99
Printing on Both Sides of Paper.....	102
Specifying 2-sided Print (Windows).....	102
Specifying 2-sided Print (OS X/macOS).....	103
Combining and Printing Multiple Pages on a Single Sheet of Paper.....	104
Specifying the Combine 2 Originals Function (Windows).....	104
Specifying the Combine 2 Originals Function (OS X/macOS).....	105
Printing on Envelopes.....	106
Printing a Locked Print File Using Quick Print Release.....	110
Printing from a USB Flash Memory Device or SD Card Directly.....	111
Printable File Formats.....	111
Printing from a Memory Storage Device or Scan Application.....	112

5. Scan

Scanning Documents and Sending the Scanned Data by E-mail.....	115
Basic Procedure for Sending an E-mail.....	115
Registering the E-mail Destination Specified When Sending an E-mail in the Address Book.....	116
Scanning Documents and Sending the Scanned Data to a Folder.....	119
Printing the Check Sheet.....	119
Confirming the Computer Information (Windows).....	120
Creating a Shared Folder (Windows).....	121
Confirming the Computer Information (OS X/macOS).....	124
Creating a Shared Folder (OS X/macOS).....	124
Registering the Created Shared Folder in the Address Book.....	126
Basic Procedure for Performing Send to Folder.....	128
Scanning an Original with Suitable Quality and Density.....	130
Specifying the File Type When Scanning a Document.....	132

6. Web Image Monitor

Using Web Image Monitor.....	135
What You Can Do on the Web Image Monitor.....	136

Web Image Monitor Screen.....	137
Specifying Web Image Monitor Help.....	138

7. Adding Paper and Toner

Loading Paper into the Paper Tray.....	141
Loading Paper into Tray 1 to 3.....	141
Loading Paper into the Bypass Tray.....	144
Specifying the Paper Size That Is Not Automatically Detected.....	145
Recommended Paper Sizes and Types.....	147
Tray 1.....	147
Lower Paper Trays (Trays 2, 3).....	149
Bypass tray.....	151
Notes on Special Paper.....	153
Paper Thickness for Each Paper Weight.....	154
Unusable Paper.....	154
Paper Storage.....	155
Saving Printouts.....	156
Thick Paper Orientation and Recommended Status.....	157
Envelope Orientation and Recommended Status.....	158
Using the Copy Function.....	159
Using the Printer Function.....	159
Loading Orientation-fixed Paper or Two-sided Paper.....	161
Copying onto Letterhead Paper.....	161
Printing onto Letterhead Paper Using the Printer Driver.....	162
Recommended Original Size and Weight.....	164
Sizes Detectable with Auto Paper Select.....	165
Replacing the Toner.....	166
Precautions When Storing Toner.....	167
Precautions When Replacing the Toner.....	168
Disposing Exhausted Toners.....	169

8. Troubleshooting

Alert Sounds.....	171
Checking the Messages, Icons, and Indicators on the Control Panel.....	173
When an Icon is Displayed with a Message.....	173

When the [Check Status] Indicator is Lit or Flashing.....	174
When the Machine Cannot Be Operated.....	176
When the Machine Does Not Respond Correctly to an Operation on the Control Panel.....	176
When the Machine Does Not Respond Correctly to an Operation from a Computer.....	179
When a Message Is Displayed and the Machine Cannot Be Operated.....	181
When a Message Appears While Using the Copy Function.....	184
When a Message Is Displayed While Using the Fax Function.....	185
Messages Displayed During Operation or When Sending/Receiving a Fax Cannot Be Performed.....	185
When a Message Appears While Using the Printer Function.....	187
Messages Displayed without Error Codes.....	187
Messages Displayed with Error Codes.....	193
When a Message Is Displayed While Using the Scanner Function.....	195
Messages Displayed on the Control Panel.....	195
Messages Displayed on the Computer.....	199
When Other Messages Are Displayed.....	205
Messages Displayed When Machine Login Fails.....	207
Messages Displayed When Logging in to the Machine Using an IC Card Fails.....	214
Messages Displayed When the LDAP Server Is Unavailable.....	215
Messages Displayed When an Application Site Cannot Be Used.....	216

9. Specifications for The Machine

List of Specifications.....	217
Specifications for the Main Unit.....	217
Specifications for Facsimile.....	221
Specifications for Printer.....	222
Specifications for Scanner.....	223
Specifications for Auto Document Feeder (ADF).....	226
Specifications for Internal Tray 2.....	226
Specifications for Lower Paper Tray.....	227
Specifications for Lower Paper Trays.....	228
The Setting Values of the Transmission Function.....	229
Send Email.....	229
Send to Folder.....	229

Broadcast Transmission.....	230
Printable Area and Margin.....	231
Machine Options.....	233
Guide to Functions of the Machine's External Options.....	233
Guide to Functions of the Machine's Internal Options.....	234
Function Compatibility.....	235

10. Legal and Contact Information

Environmental Regulations.....	237
Energy Saving Functions.....	237
User Information on Electrical and Electronic Equipment.....	238
Note for the Battery and/or Accumulator Symbol (For EU countries only).....	239
Environmental Advice for Users.....	239
Trademarks (User Guide).....	241



1. Getting Started

Turning On and Off the Power

To turn the machine on and off, press the main power switch on the right of the machine.

★ Important

- When you are using the fax function on the machine, do not turn the power off under normal operation. If the power is turned off, data stored in the fax memory will be lost in about one hour after the machine is turned off. If you have to turn the power off or unplug the power cord for some reason, make sure 100% is shown as available memory on the screen for the fax function.

Turning On the Main Power

★ Important

- Do not press the main power switch soon after you press the main power of the machine. When you turn the power on or off, wait at least 10 seconds after confirming that the main power indicator on the control panel has turned on or off.
1. Make sure the power cord is firmly plugged into the wall outlet.
 2. Open the cover of the main power switch, and push the main power switch.

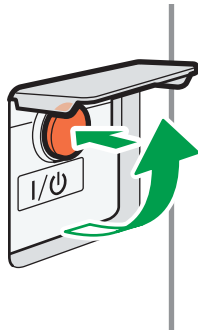

EBW162

The main power indicator on the right side of the control panel turns on.

↓ Note

- When the power is turned on, the screen may show that the machine is performing an auto restart. Do not turn off the main power while the machine is processing. It takes about five minutes until the machine restarts.

Turning Off the Main Power

★ Important

- Do not turn off the power while the machine is in operation. To turn the power off, confirm that the operation is finished.
- Do not hold down the main power switch while turning off the main power. Doing so forcibly turns off the machine's power and may damage the memory and cause malfunctions.
- Do not press the main power switch soon after pressing the main power switch on the machine. When you turn the power on or off, wait at least 10 seconds after confirming that the main power indicator on the control panel has turned on or off.

1. Open the cover of the main power switch, and push the main power switch.

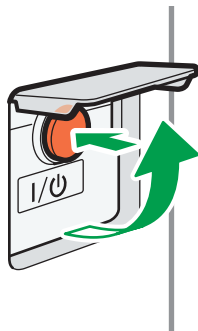

EBW162

The main power indicator on the right side of the control panel turns off. The main power turns off automatically after the machine has shut down properly.

Energy Saving Mode

When the machine is not operated for a specified period of time, the machine enters the "Energy Saver Mode" automatically. "Energy Save mode" has three modes, "Fusing Unit Off mode", "Low Power mode" and "Sleep mode", and the machine enters the Fusing Unit Off mode first. In the factory default, the machine is configured to use "Fusing Unit Off mode" and "Sleep mode".

Fusing Unit Off Mode

Because the heater of the fusing unit is turned off but the screen of the control panel is still displayed, the power consumption decreases, but you can start operation promptly. If you do not operate the machine for a specified period of time, the machine emits a clicking sound and enters Fusing Unit Off mode.

- You can specify whether to enable the Fusing Unit Off mode and the time to wait before the machine enters Fusing Unit Off mode under [Fusing Unit Off Mode (Energy Saving) On/Off]. See "Timer Settings", User Guide (Full Version).

- In this mode, you can scan documents, send faxes, receive faxes into memory, change the machine settings on the control panel, and perform other operations that do not require printing.

Low Power Mode

If you do not use the machine for a certain period after an operation, the display will turn off and the machine goes into Low Power mode. The machine uses less electricity in Low Power mode.

- You can change the amount of time that the machine waits before switching to Low Power mode under [Low Power Mode Timer].
See "Timer Settings", User Guide (Full Version).
- You can change the machine's settings to enter Low Power mode when you press the [Energy Save] (⏻) key.
See "Timer Settings", User Guide (Full Version).
- The machine recovers from Low Power mode when you perform one of the following:
 - Lift the ADF.
 - Place an original in the ADF.
 - Touch the display of the control panel.
 - Open the front or right cover.

Sleep Mode

In this mode, the display of the control panel turns off and the main power indicator blinks slowly. Power consumption is minimized. When you do not operate the machine for a specified period of time or press [Energy Save] (⏻), the machine enters Sleep mode.

- You can specify the amount of time that the machine waits before entering Sleep mode under [Sleep Mode Timer].
See "Timer Settings", User Guide (Full Version).
- The machine recovers from Sleep mode when you perform one of the following:
 - Lift the ADF.
 - Place an original in the ADF.
 - Touch the display of the control panel.
 - Open the front or right cover.

Note

- The energy saving functions are disabled when an error occurs or while an operation is in progress.

Guide to Names and Functions of Components

1

CAUTION

- Do not obstruct the machine's vents. Doing so risks fire caused by overheated internal components.

Note

- When touching the machine, you may experience a static shock which is harmless to humans. For details, refer to the following:
<https://www.ricoh-europe.com/support/health-safety/ricoh-static-shock.html>

Front and Right View

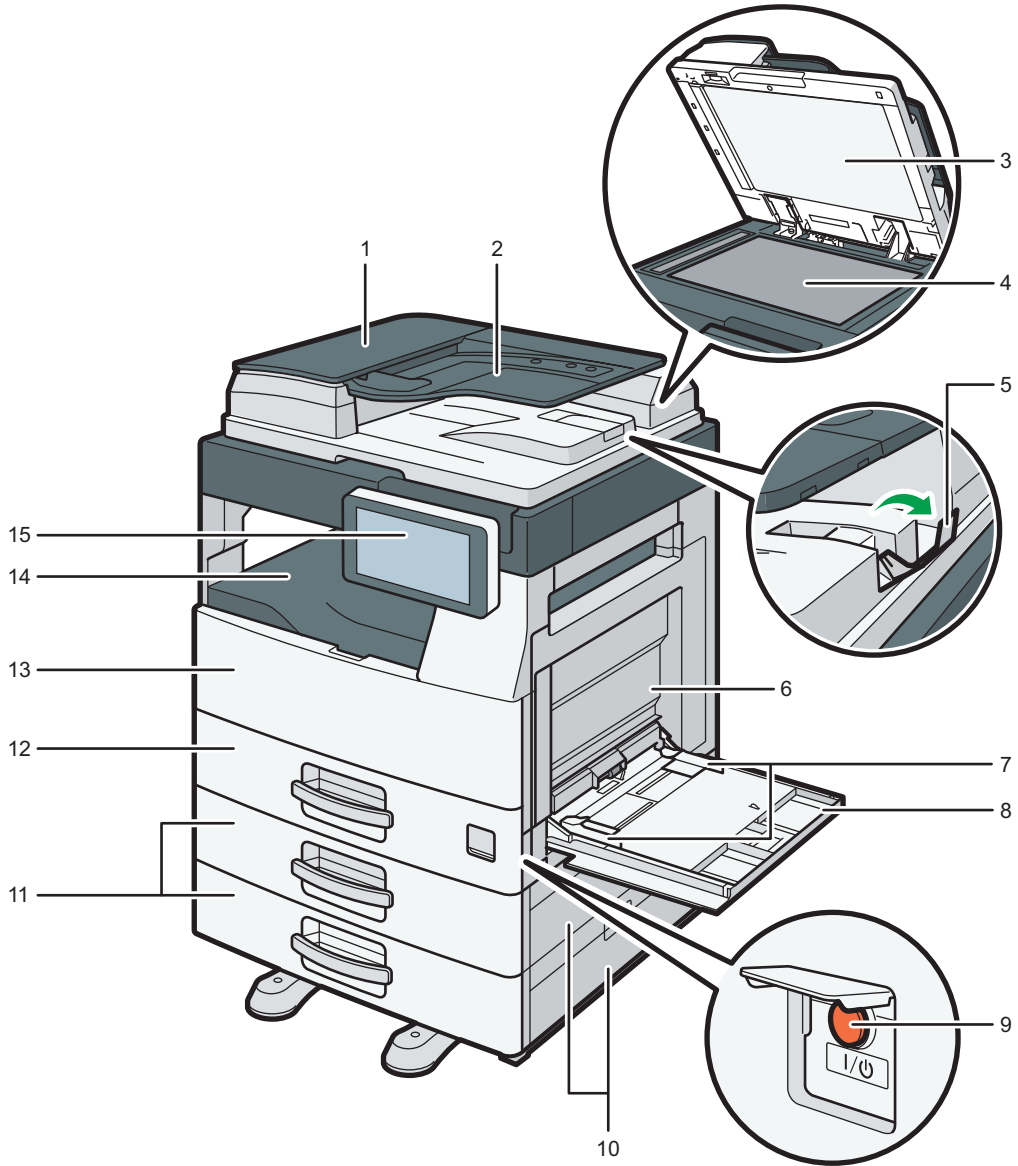

EBW112

1. ADF cover

Open this cover to remove originals jammed in the ADF.

2. Input tray for the ADF

If you load a stack of originals here, the ADF will automatically feed the originals one by one.

3. Exposure glass cover

Lower the cover over originals placed on the exposure glass.

4. Exposure glass

Place originals facedown here.

5. ADF tray extender

Pull this extender out to prevent originals larger than B4 or $8\frac{1}{2} \times 14$ size from falling.

6. Right cover

Open this cover to remove jammed paper. To open this cover, first open the bypass tray.

7. Paper guides

When loading paper in the bypass tray, align the paper guides with the edges of the paper.

8. Bypass tray

Use the tray to copy or print on adhesive labels or paper that cannot be loaded in the paper trays.

page 144 "Loading Paper into the Bypass Tray"

If you load A4, 8.5×11 or larger size paper, pull out the extender.

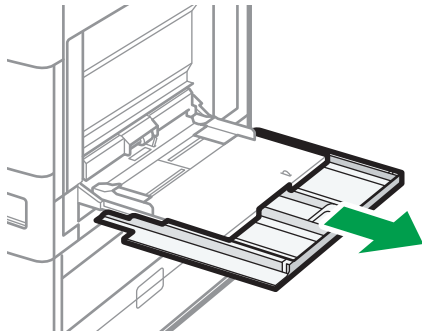

EBW151

9. Main power switch

To turn the power on and off, open the cover of the main power switch and press the main power switch.

page 9 "Turning On and Off the Power"

10. Tray 2 right cover/Tray 3 right cover

Open this cover to remove jammed paper.

11. Lower paper trays (Trays 2, 3)

Optional paper trays. Load paper here.

page 141 "Loading Paper into the Paper Tray"

12. Paper tray (Tray 1)

Standard paper trays. Load paper here.

page 141 "Loading Paper into the Paper Tray"

13. Front cover

Open to access the inside of the machine.

page 166 "Replacing the Toner"

14. Internal tray

Copied/printed paper and received fax pages are delivered here.

15. Control panel

page 17 "Names and Functions of the Control Panel"

Rear and Left View

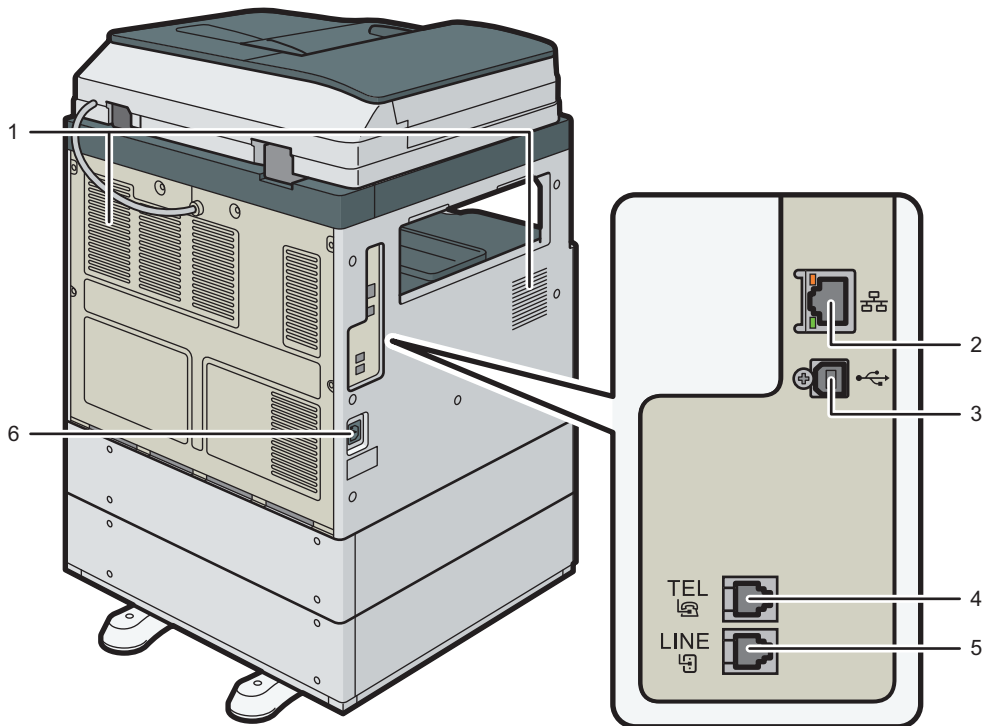

EBW113

1. Vents

Holes for ventilating the inside the machine to prevent the internal components from overheat.

After large-volume printing, the ventilation fan may continue to work to lower the temperature inside the machine.

2. Ethernet interface

Used the port to connect the machine to the network or to use the remote management service (RICOH @Remote) over the Internet.

3. USB2.0 Interface Type B

Use the port to connect the machine and the computer with the USB cable.

4. TEL: External telephone connector

Connect an external telephone.

5. Line: G3 interface unit connector

Connect the line for fax use.

6. Power Socket

For connecting the power cord to the machine.

Names and Functions of the Control Panel

The touch panel (Smart Operation Panel) that displays the operation screen of the machine is referred to as the "Control Panel".

- On the left side of the control panel, interfaces for connecting external devices and slots to insert an SD card/USB flash memory device are provided.
- Even when the screen is turned off, the LED indicators on the frame of the control panel show the status of the machine.

1

Touch Panel/Interface

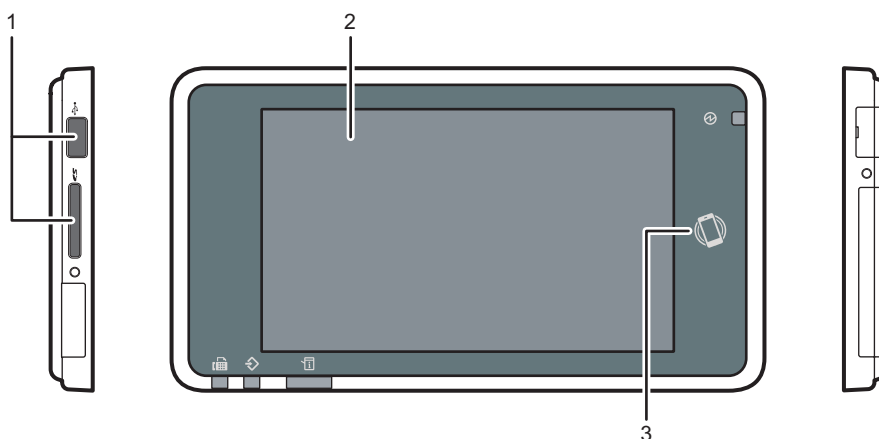

EBW738

1. Media slots

Insert an SD card or USB flash memory device. You can store the scanned data or print the file stored on the media.

- Use an SD memory card or SDHC memory card with a maximum capacity of 32 GB. You cannot use an SDXC memory card.
- Use the media formatted in FAT16 or FAT32.
- Certain types of USB flash memory devices cannot be used in the machine.
- A USB extension cable, hub, or card reader cannot be used.
- If the power of the machine is turned off or the media is removed from the machine while the machine is reading the data in the media, check the data in the media.
- Before removing the media from the slot, press the icon displayed on the screen (🗑️/🗑️) to cancel the connection.

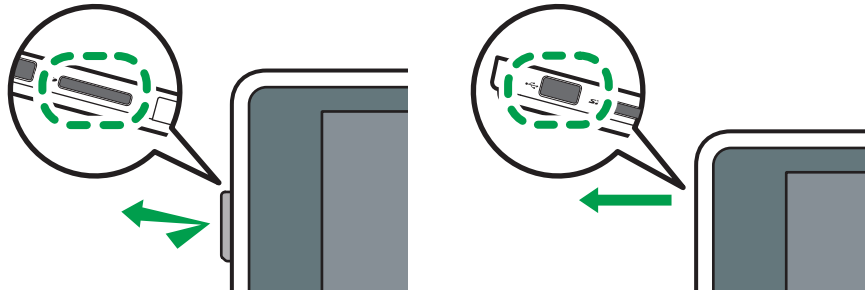

EBW739

2. Touch Panel

Displays the Home screen, operation screen of applications, and messages. Operate with the fingertips.

page 21 "How to Use the Home Screen"

page 23 "Intuitive Screen Operation Using Fingertips"

3. NFC tag

Used to connect the machine and a smart device with the RICOH Smart Device Connector.

See "Using the Machine Functions from a Mobile Device", User Guide (Full Version).

↓ Note

- You can adjust the angle of the control panel to improve visibility.



EBW114

LED Indicators

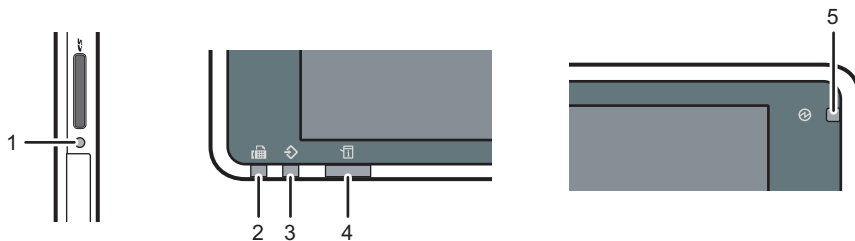

EBW740

1. Media access indicator

Flashes when data is being read from or written to an SD card

While the machine is accessing the SD card or USB flash memory device, do not turn the power off or remove the media.

2. Fax indicator

Indicates the status of the fax function.

- Flashing: transmitting and receiving data
- Lit: receiving data (Substitute RX File/Memory Lock Reception)

3. Data In indicator

Flashes when the machine is receiving data sent from the printer driver or LAN-Fax driver.

4. Status indicator

Indicates the status of the system. Stays lit when an error occurs or toner runs out.

page 173 "Checking the Messages, Icons, and Indicators on the Control Panel"

5. Main power indicator

The main power indicator lights up when you turn on the main power switch. In Sleep mode, it flickers slowly.

Changing the Display Language

You can change the language used on the display. English is set as default.

1

1. On the Home screen, press [Change Language] widget.



2. Select the display language.



3. Press [OK].

How to Use the Home Screen

Press [Home] (🏠) at the bottom center of the screen to display the Home screen on which icons for each function are shown. On the Home screen, you can register frequently used shortcuts and widgets.

- Touch the Home screen to operate it.
page 23 "Intuitive Screen Operation Using Fingertips"
- You can add or delete icons and widgets, and change their order.
page 31 "Adding a Frequently Used Application or Widget to the Home Screen"

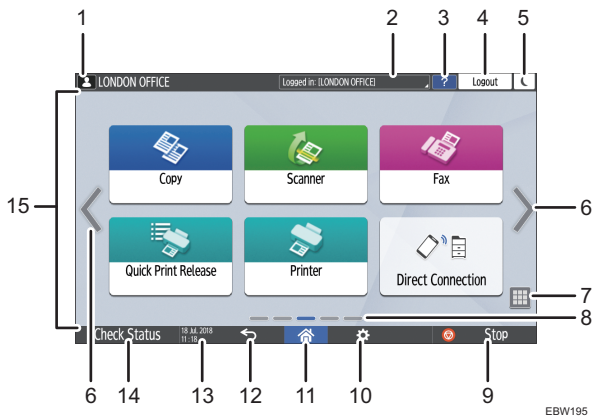

1. Login icon

This icon is displayed when users are logged in. When you press the icon, the names of the users who are currently logged in are displayed.

2. System message

Displays system and application messages. If there are two or more messages, they will be displayed alternately.

If a message indicating that the toner has run out or an error has occurred is displayed, press the message to display the system message list to check the contents.

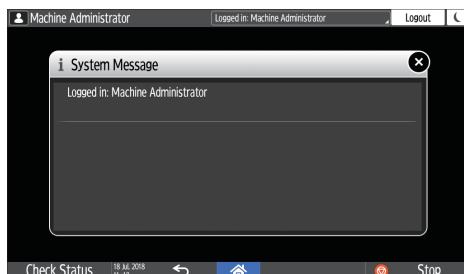

3. Help ?

This icon is displayed when Help is available for the displayed screen or errors occurring when the machine is connected to the Internet.

Specify [Cookie] in the control panel browser to [ON] to display Help properly.

See "Browser Settings", User Guide (Full Version).

4. [Login]/[Logout]

These keys are displayed when user authentication is enabled. Press the keys to log in to or log out from the machine.

page 38 "Logging In from the Control Panel"

5. [Energy Save] 

Press to enter or exit Sleep mode.

page 10 "Energy Saving Mode"

6. Switch Screens 

Press to scroll the screens right and left. The Home screen has 5 screens.

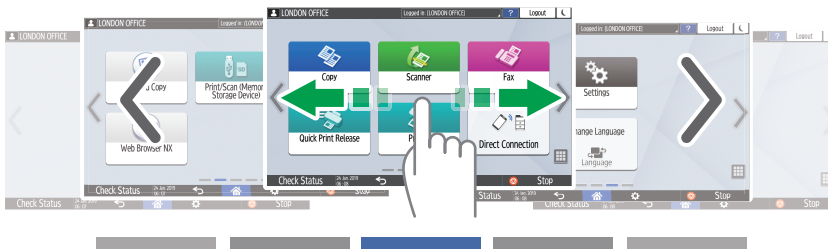

EBW196

You can switch between the screens by flicking.

page 23 "Intuitive Screen Operation Using Fingertips"

7. Application list 

Press to display applications that are not displayed on the Home screen.

page 31 "Adding a Frequently Used Application or Widget to the Home Screen"

8. Current display position

Shows which of the five screens is currently displayed.

9. [Stop]

Press to stop scanning or printing.

You can change the setting to stop only a job in progress with [Stop Key to Suspend Print Job].

See "Administrator Tools (System Settings)", User Guide (Full Version).

10. [Menu] 

Displayed if a menu is available in the currently selected application.

On the Home screen, press to restore the icons to their factory default positions.

11. [Home] 

Press to display the Home screen.

12. [Return] 

Press to return to the previous screen.

13. Date/Time and Toner remaining

The current date and time is displayed.

To display the information about Toner remaining, specify [Display Time/Remaining Toner] of [Screen Features Settings] to [Remaining Toner].

14. [Check Status]

Press to check the following system statuses of the machine. This lights up in red when an error occurs.

- Machine's status
Indicates the error status and network status.
- Operational status of each function
Status of functions such as Copy or Scanner
- Current jobs
- Job history
- Machine's maintenance information

See "Checking the Machine Status from the Control Panel", User Guide (Full Version).

15. Icon display area

Displays the icons and widgets.

↓ Note

- You can change the screen displayed when the power is turned on under [Function Priority].
- See "Displaying Frequently Used Functions on the First Screen", User Guide (Full Version).
- When you press [Menu] ► [Reset Home Screen] with the Embedded Software Architecture application being installed in the machine, the application icons are not deleted.

Intuitive Screen Operation Using Fingertips

On the Home screen or application screen, you can perform the following operations by touching the screen with your fingertips.

Flick (for switching between screens)

Touch and slide your finger on the screen quickly left or right to switch between the screens.

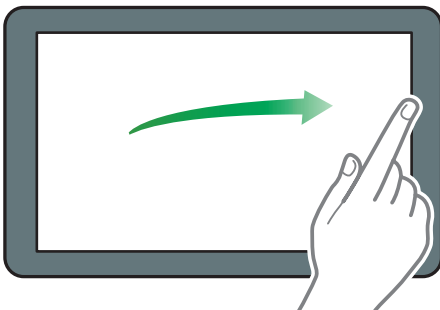

DZB181

Drag (for moving an icon)

Press and hold an icon, and then slide your finger while pressing on the screen to move the icon.

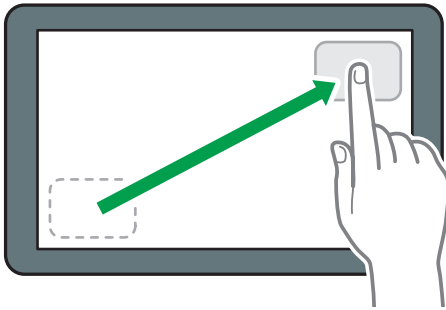

DZB182

Press and hold (for displaying the available menu screen)

Press and hold on a blank area on the screen to display the menu screen.

On the Home screen you can add a folder or change the wallpaper from the menu.

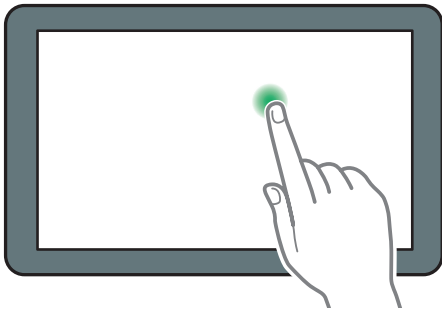

DZB183

In some applications, you can also use the following actions to operate the screen:

Pinch-in (for zooming out the screen)

Touch the screen with your thumb and forefinger, and pinch them together. This feature is useful when previewing files and images.

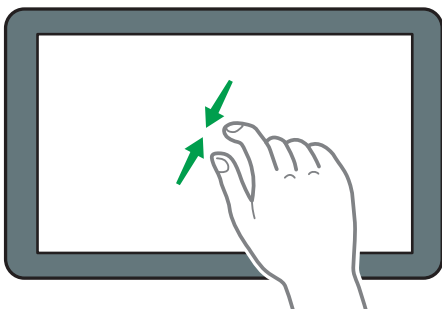

DZB185

Pinch-out (for zooming in the screen)

Touch the screen with your thumb and forefinger, and spread them apart. You can also zoom in the screen by tapping the screen twice quickly. When you quickly tap the screen twice again, the screen returns to full display. This feature is useful when previewing files and images.

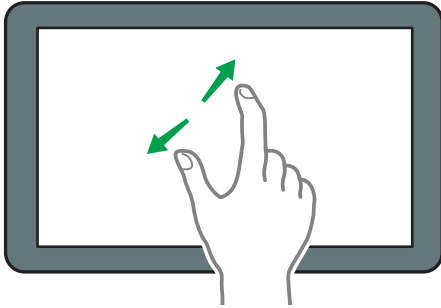

DZB184

How to Use the Copy Screen

You can select from one of two types for the Copy screen:

1

Standard View (factory-default)

The basic functions that are used frequently are displayed with big keys. Scroll down the screen to see the keys used to configure the functions for finishing or editing.

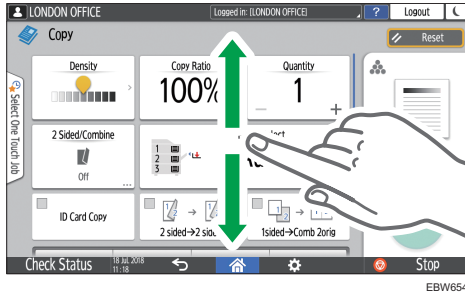

Full View

You can see all the function keys on a single screen. You do not need to scroll through the screens to select a function.

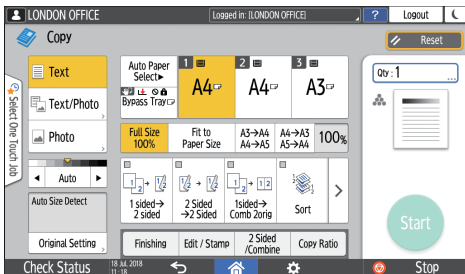

- To switch the screen type, press [Menu]([Settings Icon]) ► [Screen Settings] ► [Switch Screen Type] on the Copy screen.
- You can use the same functions on either screen.
- When the administrator has configured user authentication and User's Own Customization is enabled, each login user can change the screen type.

How to Use the Copy Screen (Standard View)

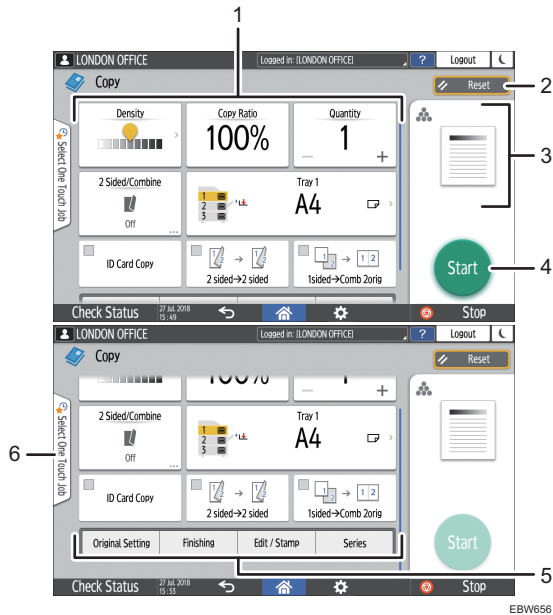

1. Copy function keys

Press a key to select the function to assign to the key. Flick up and down on the screen to display the keys out of the visible area. The keys with assigned functions are displayed in yellow or with  in the upper left corner. Depending on the assigned function, the display of the key changes according to the specified setting.

2. [Reset]

Reset the settings configured on the Copy screen.

3. Preview of the current setting status

Displays an image representing the settings configured on the Copy screen. Press the image to display the list of the settings.

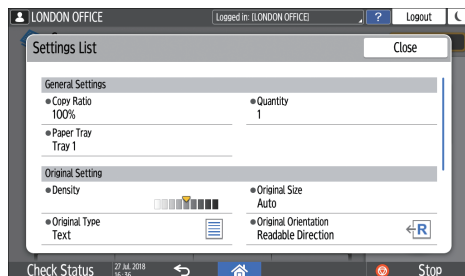

4. [Start]

Press to perform copying.

5. Other keys for Copy function

Press to select the functions whose keys are out of the visible area of the screen. The key of the function that is currently configured is displayed with  in the upper left corner.

6. Select One Touch Job

You can see the preset settings in the machine. "Economy" and "Copy to same size" are available as recommended settings.

How to Use the Copy Screen (Full View)

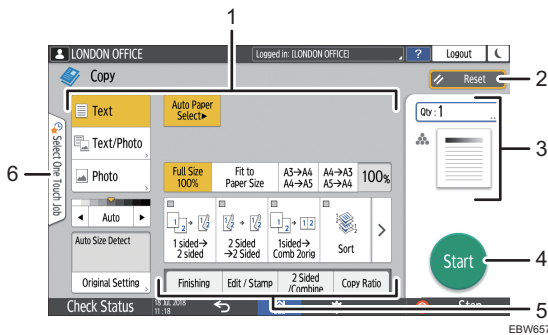

1. Copy function keys

Press a key to select the function to assign to the key. The keys with assigned functions are displayed in yellow. To see the display area in the illustration below, press \triangleright or flick to the left or right.



2. [Reset]

Reset the settings configured on the Copy screen.

3. Preview of the current setting status

Displays an image representing the quantity and the settings configured on the Copy screen. Press [Quantity] to display the number keys. Press the image to display the list of the settings.

4. [Start]

Press to perform copying.

5. Other keys for Copy function

Press to select the functions whose keys are out of the visible area of the screen. The key of the function that is currently configured is displayed with  in the upper left corner.

6. Select One Touch Job

You can see the preset settings in the machine. "Economy" and "Copy to same size" are available as recommended settings.

How to Use the Fax Screen

There are five kinds of functions and settings on the Fax screen.

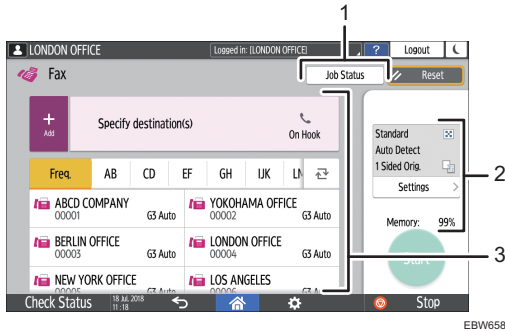

1. Job Status

You can browse and print the transmission and reception history.

2. Transmission settings

You can specify the additional features to use when sending a fax, configure the scan settings appropriately for the original to scan. You can also check the settings that are currently specified and the remaining amount of memory.

3. Destination specification

You can select an address registered in the address book through one-touch operation. Press **+** to specify a destination by using various other methods such as by entering manually or selecting from the history. You can also register a new destination in the address book.

How to Use the Scanner Screen

There are five kinds of functions and settings on the Scanner screen.

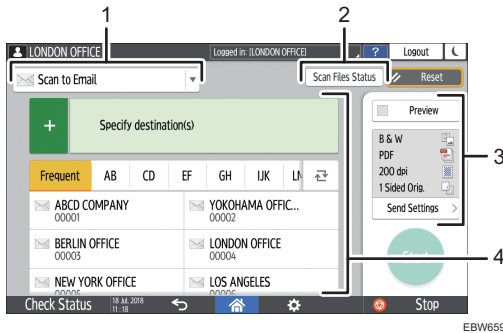

1. Destination type selection

You can switch between [Scan to Email] and [Scan to Folder]. The items displayed in the address book and destination entry screen for manual entry also change when you switch the destination type.

2. Scan Files Status

You can browse the transmission history of the sent documents and cancel sending of a document waiting in the queue. The transmission file status may not be displayed depending on the security settings.

3. Transmission settings

You can specify the scan settings according to the type of document to scan and the purpose of the scanned data.

4. Destination specification

You can select a destination registered in the address book through one-touch operation. Press  to specify a destination by using various other methods such as by entering manually or selecting from the history. You can also register a new destination in the address book.

Adding a Frequently Used Application or Widget to the Home Screen

You can use a frequently used icon or widget easily by adding it to the Home screen. You can organize the icons on the Home screen as you like by changing their order or using folders.

- Add an icon or widget from the application list screen.
- Each page of the Home screen can display up to 6 icons, widgets or folders, for a total of 30 items. A folder can hold up to 80 icons.
- You can add the following items to the Home screen: shortcuts of bookmarks in the browser on the screen and programs registered in the Copy, Fax or Scanner.

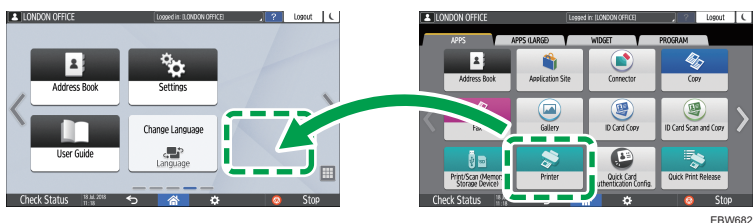

Note

- When you have set user authentication, log in and customize it. Each user can register their own Home screen.
- A shortcut, folder, or widget cannot be created or moved if there is no space on the Home screen. In this case, delete one of the registered items, and then perform the same operation.
- The names of icons and widgets are displayed up to 20 double-byte or 30 single-byte characters. Names composed of 21 or more double-byte characters are displayed with "...", indicating the 20th and later characters.

Adding an Icon/Widget to the Home Screen

1. Press the application list icon on the Home screen.

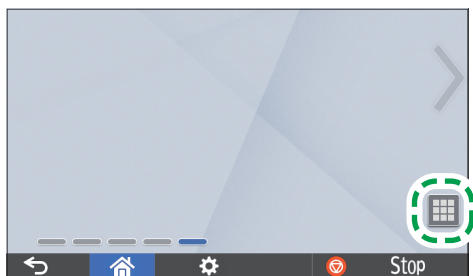

EBW743

2. Press and hold the icon or widget to be added to the Home screen.



- Select the [WIDGET] tab to add a widget, or select the [PROGRAM] tab to add a program.

3. After the screen changes to the Home screen, move the icon or widget to the desired position and release it.

Moving or Deleting Icons and Widgets

- To move an icon or widget, press and hold the icon and move it to the desired position, and then release it.
- To delete an icon or widget, press and hold the icon and move it to the trash icon, and then release it.
- When you delete a shortcut icon of a function or program from the Home screen, the function or program is not deleted.
- To reset the Home screen, perform the following procedure.

1. Press [Menu] () on the bottom center of the Home screen.
2. Press [Reset Home Screen].
3. Press [OK].

Creating a Folder to Organize Icons

1. Press and hold a spot on the Home screen where you want to create a folder.

2. When the "Add to Home Screen" screen is displayed, press [Folder].

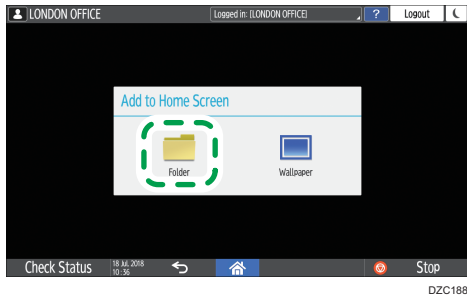

3. Open the created folder, press and hold its title, and then change the folder name.
You can enter up to 30 characters for a folder name.
4. Drag the icon and release it over the folder.

Registering Frequently Used Settings as a Program

1

You can register a "program" made of a combination of the functions used in the Copy, Fax, or Scanner, such as the scan setting, output setting, and address.

- You can load the registered program easily from the application screen.

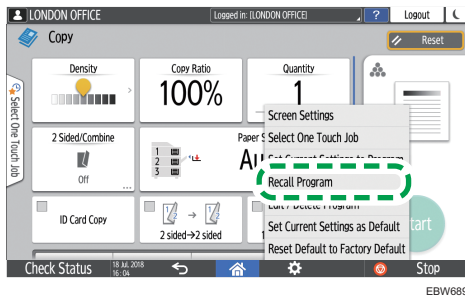

- When you press the icon of a program on the Home screen, the machine applies the settings and performs the function registered in the program automatically.
- You can register the following number of items as programs.
 - Copy: 25 items
 - Fax: 100 items
 - Scanner: 100 items

Note

- You cannot register the following Touch settings as a program:
 - Copy
[Orientation] of [2 Sided/Combine]
 - Fax
[Subject], [Sender]
 - Scanner
[Sender], [PDF Security Settings], [Start Number]
- A folder destination with a destination protection code cannot be registered on a program of the scanner function.

Registering Settings as a Program

First, configure the settings to be registered on the Copy, Fax, or Scanner screen, and then register them.

1. On the Home screen, press [Copy], [Fax], or [Scanner].



2. Specify scan and output settings to be registered as a program.

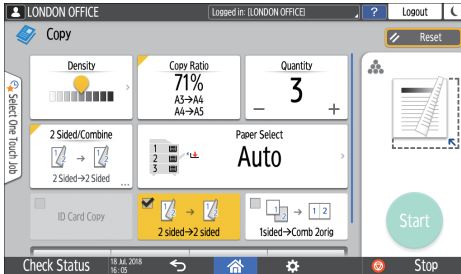

3. Press [Menu] (⚙️).

4. Press [Set Current Settings to Program].

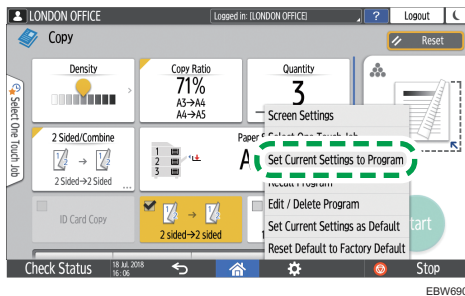

5. Press a program number to register the settings.

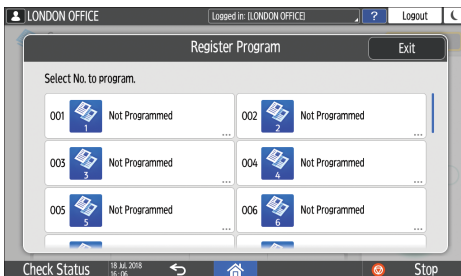

6. Enter a program name and select an icon, and then press [OK].

7. Press [Place] to place the registered icon on the Home screen.

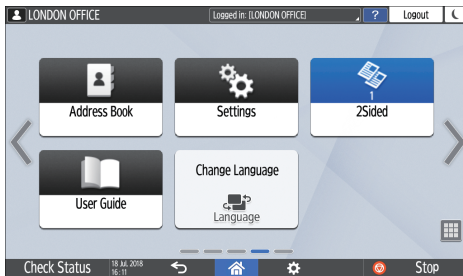

8. Press [Exit].

Changing the Contents of the Program

You can change a part of the program and overwrite it or change the contents and register them as a new program.

1. On the Home screen, press [Copy], [Fax], or [Scanner].

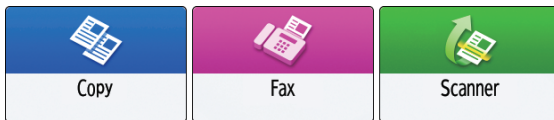

2. Press [Menu] (⚙️), and then press [Recall Program].

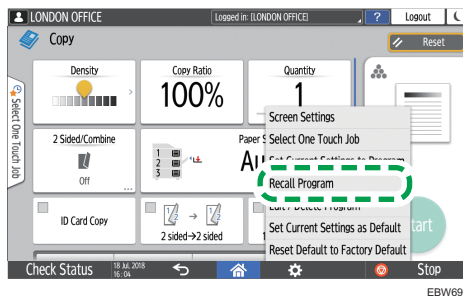

3. Press the program number to be changed.

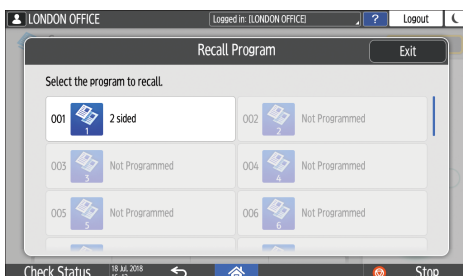

4. Change the scan and output settings.

5. Press [Menu] () , and then press [Set Current Settings to Program].

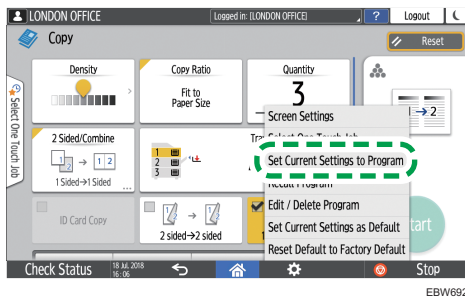

6. Select a program number to register the changed settings.

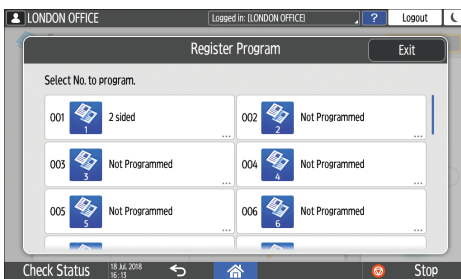

- To overwrite the program, select the number of the loaded program.
- To register the contents as a new program, select a number that is not programmed.

7. Enter a program name and select an icon.

8. Press [OK].

Note

- To change the icon or program name or to delete the program, press [Menu] () and operate from [Edit/Delete Program].

Logging In from the Control Panel

When the machine is configured by the administrator to restrict use by unauthorized users, you must authenticate your login information before starting the operation.

The authentication methods are described below.

- When Basic Authentication, Windows Authentication, or LDAP Authentication is configured on the machine, enter the user name and password for authentication to log in to the machine before starting operation.

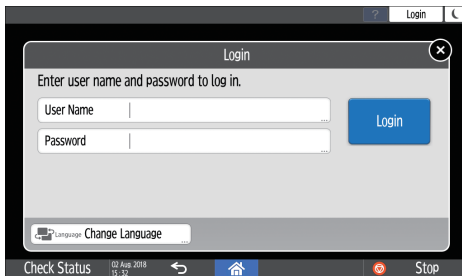

- Depending on the machine settings, you can use an IC card or mobile device for authentication.

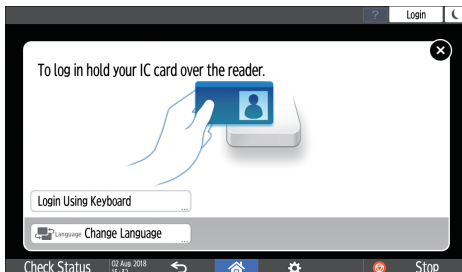

- If user code authentication is specified, you may need to enter the user code to operate the restricted application.

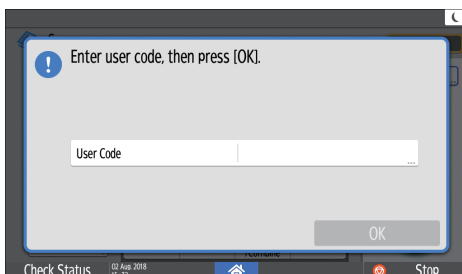

To prevent use of the machine by an unauthorized person, always log out when you have finished using the machine. While a user is logged in, the name of the user is displayed in the system message.

↓ Note

- If the machine is not used for a specified period, the user is automatically logged out (Auto Logout). The default setting for Auto Logout is 3 minutes. The period of Auto Logout can be changed by [Auto Logout Timer] of [Timer Settings] or the Auto Logout setting can be disabled.
- See "Timer Settings", User Guide (Full Version).
- Ask the administrator for the login user name, login password, and user code.
- See "Verifying Users to Operate the Machine (User Authentication)", User Guide (Full Version).

Logging In by Entering the User Name and Password

Enter the authentication information using the keyboard displayed on the control panel.

1. Press [Login] at the top right on the screen.

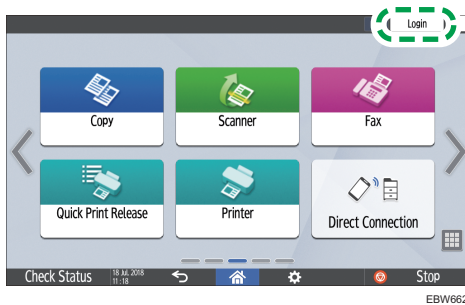

2. Press [User Name].

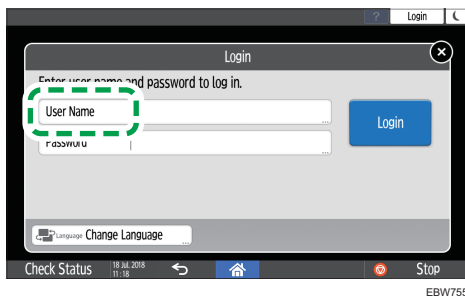

3. Enter the login user name, and then press [Done].
4. Press [Password].
5. Enter the login password, and then press [Done].
6. Press [Login].

↓ Note

- If an incorrect password is entered a specified number of times, login with the same name is disabled (Lockout Function). The default setting for unsuccessful attempts before a user is locked out is five. If the user is locked out, the administrator must release the lockout.
- To log out from the machine, press [Logout] at the top right on the screen, and then press [OK].

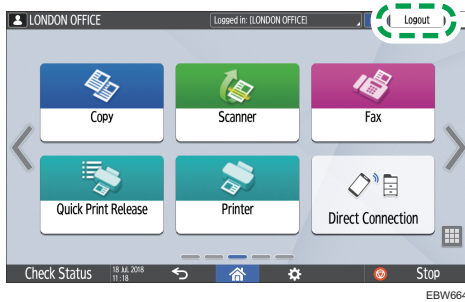

Logging In Using an IC Card

Hold an IC card over the card reader to the right of the control panel. If the card is not registered on the machine, enter the authentication information and register the card.

1. Hold an IC card over the card reader.

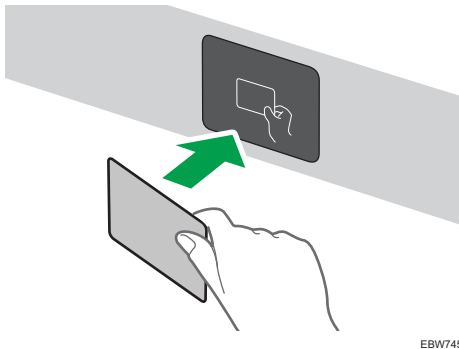

- When the card is registered on the machine, login operation finishes.
- When the card is not registered, the registration screen is displayed. Proceed to the next step to register the card.

2. Enter the Login User Name and Login Password, and then press [Register].

3. Hold the IC card over the card reader again.

↓ Note

- To log out, hold the IC card over the card reader or press [Logout] at the top right on the screen.

- If another user holds the IC card over the card reader while you are still logged in, you are automatically logged out and the new user logs in.

Logging In Using a Mobile Device

1

Log in to the machine using the RICOH Smart Device Connector app on your mobile device. You need a mobile device that supports Bluetooth Low Energy (BLE).

1. Enable the Bluetooth function on your mobile device.
2. Start the RICOH Smart Device Connector application on the mobile device, and then flick left or right to display the login screen.
3. Press [NEXT].
4. Display the login screen on the control panel of the machine, and hold the mobile device over the Bluetooth label.



Note

- To log out from the machine, hold the mobile device over the Bluetooth label on the control panel or press [Logout] at the top right on the screen.
- If another user holds a mobile device over the card reader while you are still logged in, you are automatically logged out and the new user logs in.

Authenticating Using the User Code

When User Code Authentication is specified as the authentication method on the machine, enter the user code before operating an application.

1. Enter the user code, and then press [OK].

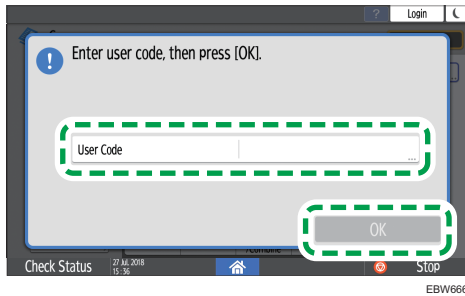

Note

- When you finish the operation of the application, press [Energy Save] (⏻) or press and hold [Reset] to release the authentication status.

Changing the Login Password

When Basic Authentication, Windows Authentication, or LDAP Authentication is configured on the machine, change the password periodically to prevent use of the machine by an unauthorized person.

Passwords can contain the following characters. Make the password difficult to guess.

- Uppercase letters: A to Z (26 characters)
- Lowercase letters: a to z (26 characters)
- Numbers: 0 to 9 (10 characters)
- Symbols: (space) ! " # \$ % & ' () * + , - . / : ; < = > ? @ [\] ^ _ ` { | } ~ (33 characters)

1. Log in to the machine.
2. Press [Address Book] on the Home screen.

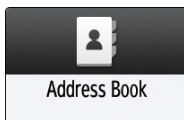

3. Select the login user from the address book, and then press [Edit].

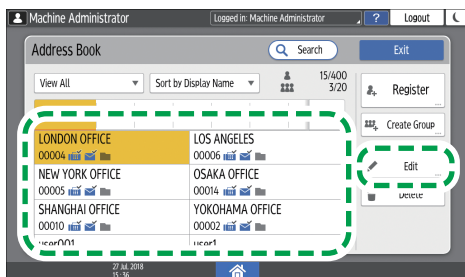

4. Press the [User Management / Others] tab ► [User Management].

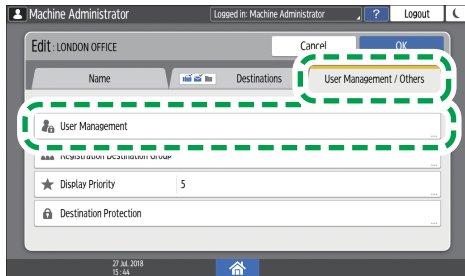

EBW668

5. Enter the new login password, and then press [OK].

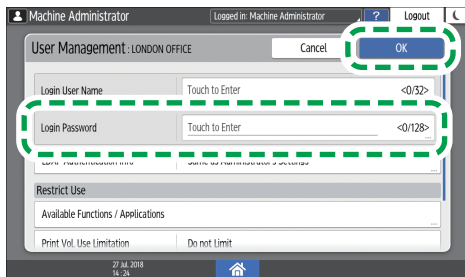

EBW669

You can enter up to 128 characters.

6. Press [Settings].
7. After completing the procedure, press [Home] (🏠).

Placing an Original on the Exposure Glass

Use the exposure glass to scan originals that cannot be placed in the auto document feeder (ADF), such as books and license cards.

⚠ CAUTION

- When lowering the ADF, do not place your hands on the hinges and exposure glass. Your hands or fingers are caught, which can result in injury.

★ Important

- Do not lift the ADF forcefully. The cover of the ADF might open and cause injury. The ADF, or its hinges may also become damaged.

1. Lift the ADF.

Lift the ADF by more than 30 degrees to detect the document size automatically when placing an original on the exposure glass.

- #### **2. Place the original face down and aligned to the mark on the upper left corner of the scan area.**

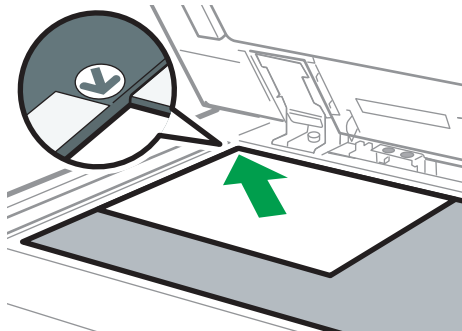

EBW111

page 164 "Recommended Original Size and Weight"

page 165 "Sizes Detectable with Auto Paper Select"

3. Lower the ADF.

↓ Note

- When you place a thick book or three-dimensional original on the exposure glass and lower the ADF, the back side of the ADF rises up to accommodate the original.

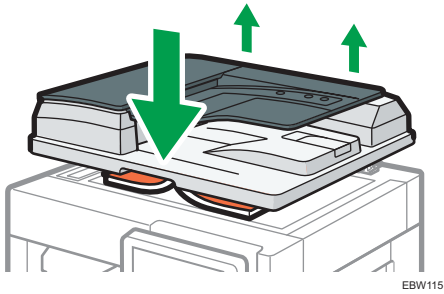

- Do not open or close the ADF with your hands placed in the space between the ADF and exposure glass.

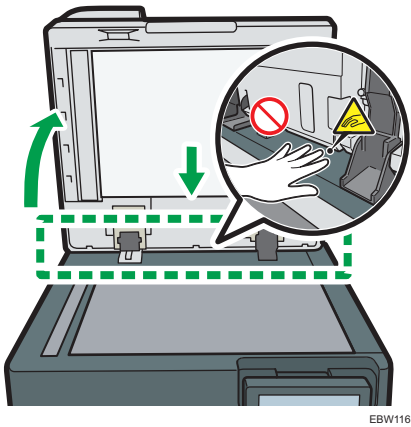

Placing an Original in the Auto Document Feeder (ADF)

1

The ADF automatically scans multiple sheets of originals or two-sided originals at one time. When scanning a two-sided original, the machine scans the front side of the original first, and then turns it over to scan the back side.

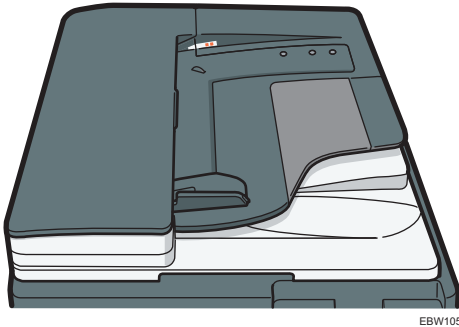

EBW105

- For details about the sizes of originals that you can place in the ADF, see the following:
 - page 164 "Recommended Original Size and Weight"
 - page 165 "Sizes Detectable with Auto Paper Select"
- If the originals described below are placed in the ADF, it may cause misfeeds, white lines, or black lines, or result in damage to the originals. Place these originals on the exposure glass.
 - Stapled or clipped originals
 - Perforated or torn originals
 - Curled, folded, or creased originals
 - Pasted originals
 - Originals with adhesive tape, glue or paste stuck to them
 - Originals with any kind of coating, such as thermal paper, art paper, aluminum foil, carbon paper, or conductive paper
 - Originals with perforated lines
 - Originals with indexes, tags, or other projecting parts
 - Sticky originals such as translucent paper
 - Thin or highly flexible originals
 - Thick originals
 - Bound originals such as books
 - Transparent originals such as transparencies or translucent paper

Note

- When loading an original written by pencil on the ADF, the original may be dirty from by being scraped.
- Correct an original that tends to curl before setting on the machine.
- Take care so that multiple originals do not stick to each other and are not fed at once.
- Do not set an original that is wet with correcting fluid or ink. The scanning glass will be stained and the stain will be scanned with the original.

Placing Originals in the ADF**Important**

- Do not block the sensors with your hand. Be sure to load the originals neatly and do not push them into the ADF forcibly. It may cause paper misfeeds or paper size error.

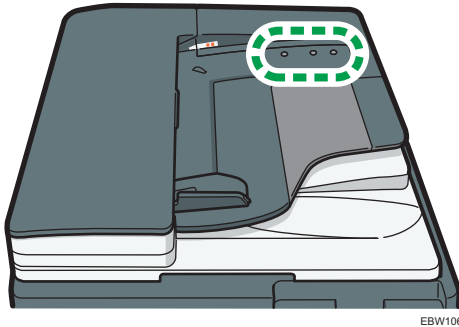

EBW106

1. Adjust the original guide to the original size.

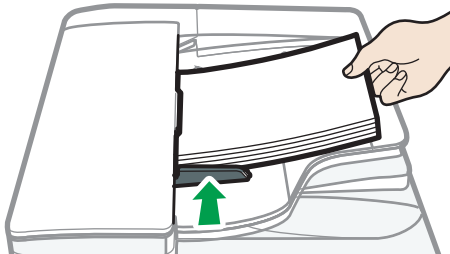

DZW107

2. Place the aligned originals squarely face up in the ADF.

Place the originals with the first page facing up.

Fan sheets before loading so that multiple papers do not stick to each other and are not fed at once.

Do not stack the originals beyond the limit mark.



Note

- To scan originals larger than B4 or $8\frac{1}{2} \times 14$ size, raise the ADF's extender on the ADF output tray.

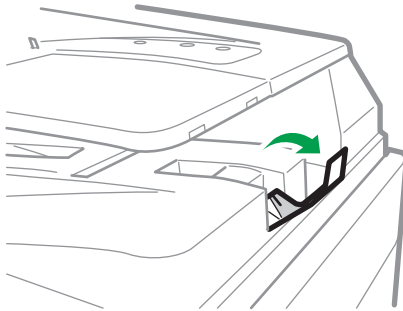

- When using the ADF to scan originals with a paper weight less than 42 g/m^2 (11 lb. Bond), move the slide tray on the original output tray to the left side. When the slide tray of the Auto Reversible Document Feeder (ADF) is in the left, the amount of output paper will be low. After scanning a thin original, return the slide tray to the previous position.

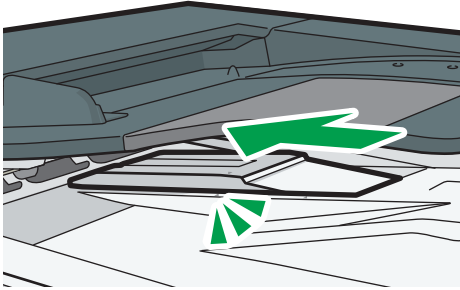

DZW109

2. Copy

Basic Procedure for Copying Documents

Set the original on the exposure glass or auto document feeder (ADF) to make a copy.

★ Important

- If the previous setting is still active, press [Reset] before copying.

1. Press [Copy] on the Home screen.

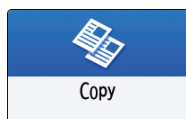

2. Place the original.

See "Placing an Original on the Scanner", User Guide (Full Version).

3. Press [+] or [-] in [Quantity] to specify the number of copies.

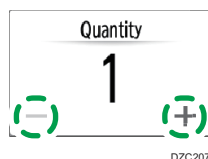

You can enter this using the keyboard after pressing [Quantity] or a number.

4. Press [Paper Select] and select the paper to use as necessary.

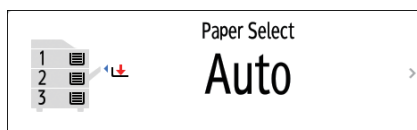

- When you select [Auto Paper Select], the paper suitable for the original is selected automatically. When the orientations of the original and paper in the paper tray do not match, the machine rotates the copied image 90 degrees automatically.
- If the size of the original is not detected properly or when you make a copy on paper of a special size, specify the paper tray in which the paper to use is loaded.

5. Press [Start].

- When the [Check the orientation of the original every time after pressing Start] check box is selected in [Select the original's orientation], the screen below is displayed. Select the original orientation as necessary. If you do not need to select this each time, clear the check box.

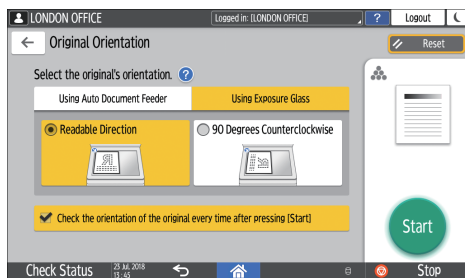

2

- When you place the original on the ADF, the process of copying the original starts.
- When you place the original on the exposure glass, the copy process starts according to the setting contents. To make a copy of the second page or back side of the original, place the original accordingly on the exposure glass, and then press [Start]. Press [Finish Scn] after scanning all originals if necessary according to the setting contents.
- Originals scanned when no paper is loaded or when an error has occurred will be copied automatically when the machine is ready to execute copying.

Making Enlarged or Reduced Copies

You can enlarge or reduce the original when copying with the following methods:

- Enlarging or reducing at a specified reduction ratio or into a specified size (Zoom/Reduce/Enlarge/Size Magnification)
- Enlarging or reducing according to the paper size (Auto Reduce/Enlarge)

Specifying a Copy Ratio or Size

1. Press [Copy] on the Home screen.

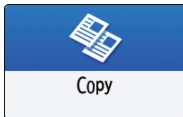

2. Place the original.

See "Placing an Original on the Scanner", User Guide (Full Version).

The base point of reduce/enlarge is different for the exposure glass and Auto Document Feeder (ADF) as shown in the following table:

Setting position	Base point	Enlarge	Reduce
Exposure glass	<p>Enlarged or reduced from the top left.</p>	 DZB224	 DZB225
Auto document feeder (ADF)	<p>Enlarged or reduced from the bottom left</p>	 DZB224	 DZB225

3. Press [Copy Ratio] and select a copy ratio or size.

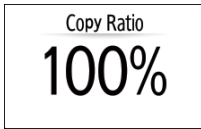

To specify a copy ratio or size other than the displayed setting, press [Others] and perform the following procedure.

Specifying a copy ratio (Zoom/Reduce/Enlarge)

Enter a value or select the copy ratio.

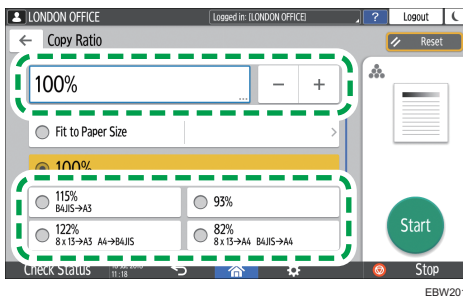

Specifying a size (Size Magnification)

Press [Specify Copy Size] and enter the length of the original and copied image.

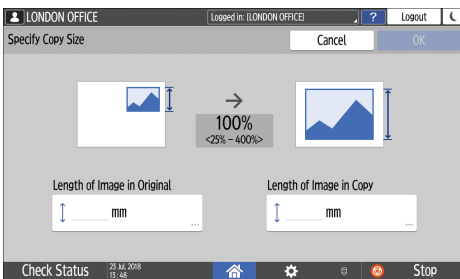

4. Press [Start].

Note

- You can change the options of the copy ratio that is displayed on the Copy screen when pressing [Copy Ratio]. You can also change the enlargement and reduction ratios that appear when [Copy Ratio] ► [Others] is pressed on the Copy screen.

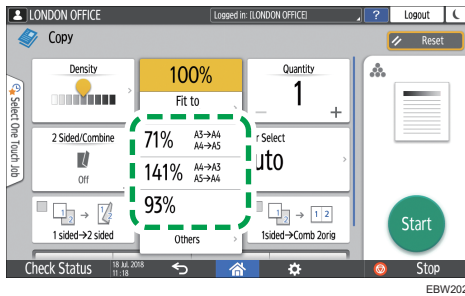

- See "Reproduction Ratio", User Guide (Full Version).

Enlarging or Reducing According to the Paper Size

The original is enlarged or reduced to fit on the specified paper size (Scale to Paper Size)

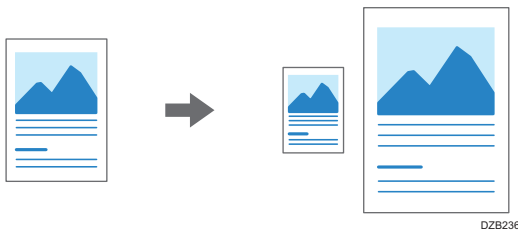

The document sizes that can be detected automatically are shown in the table below. To copy a document whose size is not listed in the table, specify [Original Size] on the Copy screen.

Original location	A3	B4 JIS	A4	B5 JIS	A5	B6 JIS
Exposure glass	✓	✓	✓	✓	✓	-
ADF	✓	✓	✓	✓	✓	✓*1

Original location	11 × 17	8 ¹ / ₂ × 11	8 ¹ / ₂ × 13
Exposure glass	-	-	✓
ADF	✓	✓	✓

*1 You cannot use the two-sided scanning mode.

1. Press [Copy] on the Home screen.

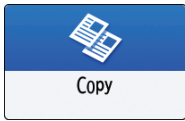

2. Place the original.

See "Placing an Original on the Scanner", User Guide (Full Version).

3. On the Copy screen, press [Copy Ratio] and [Fit to Paper Size].

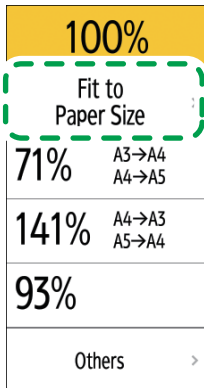

DZC237

4. Select the tray loaded with the paper to use.

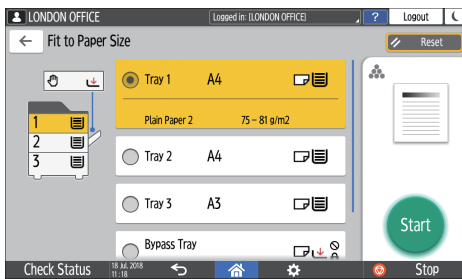

When the orientations of the original and paper in the paper tray do not match, the machine rotates the copied image automatically. To reduce an original of A3 (11 × 17) size to A4 (8 1/2 × 11) size, for example, you can select either A4 (8 1/2 × 11) or A4 (8 1/2 × 11).

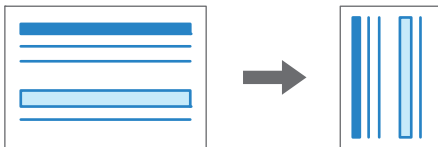

DZB240

5. Press [Start].

Duplex Copying

You can copy two 1-sided pages or one 2-sided page onto the front and back sides of a single sheet of paper.

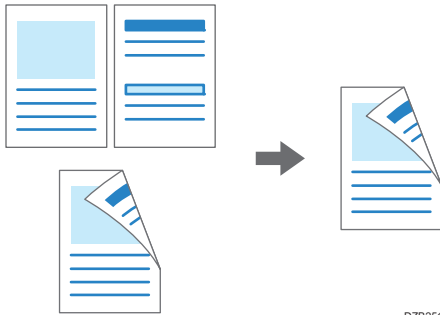

DZB251

The size of the original that can be copied differs from that of the 1-sided copy.
page 164 "Recommended Original Size and Weight"

1. Press [Copy] on the Home screen.

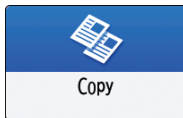

2. Press [1 sided→2 sided] or [2 sided→2 sided] on the Copy screen.



Duplex Copying with the Settings Other Than Those Displayed on the Keys

1. Press [2 Sided/Combine].

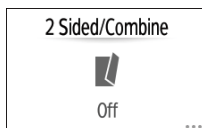

2. Specify the original and print side settings.

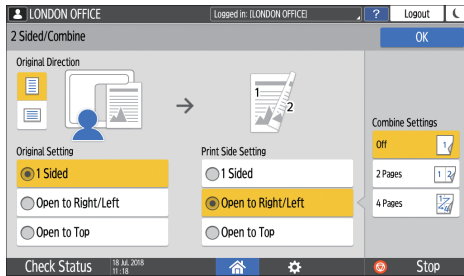

- Original Direction: Specify the orientation to place the originals.
- Original Setting: Specify the condition of the originals to copy (1 sided/2 sided (Page Opening Direction)).
- Print Side Setting: Select the finish from [Open to Right/Left] or [Open to Top].

3. Press [OK].

3. Place the original.

See "Placing an Original on the Scanner", User Guide (Full Version).

4. Press [Start].

- When placing the originals on the exposure glass, press [Finish Scn] after scanning all of the originals if necessary according to the setting contents and number of originals.

↓ Note

- You cannot perform Duplex Copy onto the following paper types:
 - Label paper (adhesive labels)
 - Transparency
 - Envelopes
 - Thin paper
 - Thick paper
- You can change the setting contents of the two-sided copy key on the Copy screen.
- See "General Features (Copier Settings)", User Guide (Full Version).
- Use the [Series] function to copy the front and back sides of a two-sided original onto one side of a sheet page by page.
- See "Copying Two-sided Original", User Guide (Full Version).





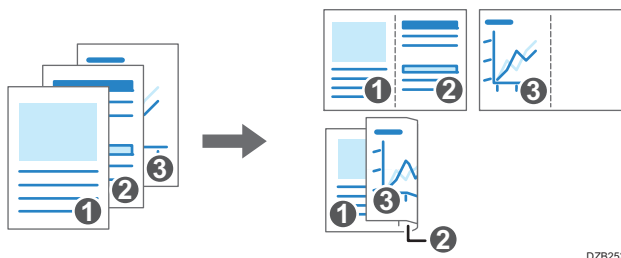

Combining and Copying a Multi-page Original onto a Single Sheet of Paper

You can copy multiple sheets in an original onto one side or both sides of a sheet of paper to save paper.



DZB253

The arrangement of copied pages and copy ratio varies depending on the original orientation and combined pages.

Original Orientation	Combine 2 pages	Combine 4 pages
 <p>DZB254</p>	 <p>DZB256</p>	 <p>DZB257</p>
 <p>DZB255</p>	 <p>DZB259</p>	 <p>DZB260</p>

1. Press [Copy] on the Home screen.

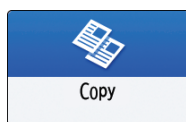

2. On the Copy screen, press [1 sided → Comb 2orig].

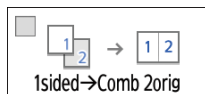

To combine with the settings other than those displayed on the keys

1. Press [2 Sided/Combine].

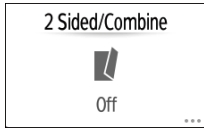

2. Specify about the original, print side, and combining.

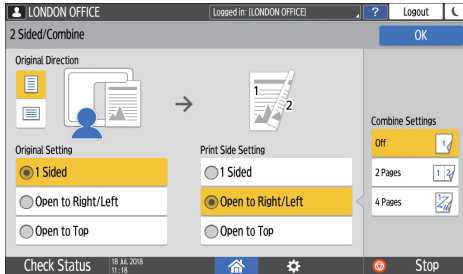

- Original Direction: Specify the orientation to place the originals.
- Original Setting: Specify the condition of the originals to copy (1 sided/2 sided (Page Opening Direction)).
- Print Side Setting: Specify the condition of the copied sheet (1 sided/2 sided (Page Opening Direction)).
- Combine Settings: Specify the number of pages to combine on one side of a sheet.

3. Press [Paper Select] and select the paper to copy onto.



4. Place an original.

See "Placing an Original on the Scanner", User Guide (Full Version).

To position the right-page first and then the left page when copying an original written longitudinally, place the original upside down in the ADF.

Example: Combining 2 Pages

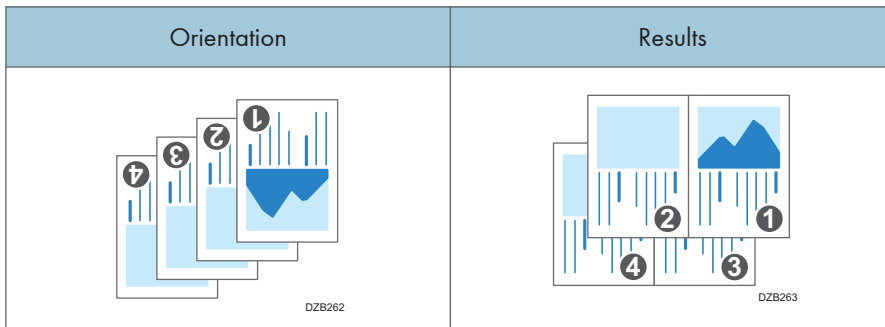

5. Press [Start].

When placing the originals on the exposure glass, press [Finish Scn] after scanning all of the originals if necessary according to the number of originals.

Note

- The minimum copy ratio in the Combine function is 25%. For example, if you copy an A3 (11 × 17)-size original onto A4 (8¹/₂ × 11)-size paper with [1 sided → Comb 4orig], the copy ratio becomes less than 25% and parts of the image might not be copied.
- You can change the setting contents of the Combine key on the Copy screen.
- See "General Features (Copier Settings)", User Guide (Full Version).

Copying Onto Envelopes

To copy onto envelopes, set them in the bypass tray.

★ Important

- The Duplex Copy function cannot be used for envelopes. If Duplex Copy is specified, press the [Reset] key to cancel the setting.

1. Press [Copy] on the Home screen.

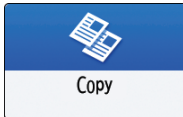

2. Set the envelope in the bypass tray with the copying side face down.

page 158 "Envelope Orientation and Recommended Status"

The "Bypass Tray Paper Settings" screen is displayed.

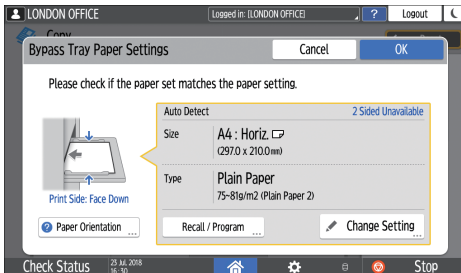

3. Press [Change Setting].

When envelopes are set in the bypass tray, the type and size are not detected automatically. Specify the type and size of the paper manually.

4. Select [Envelope], and then proceed to the next screen.

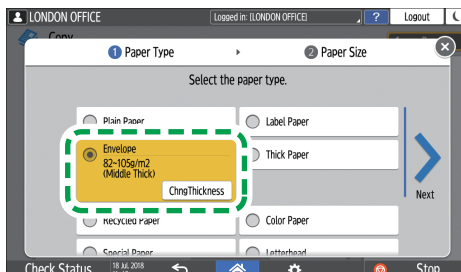

To change the envelope weight, press [ChngThickness] to specify the weight.

5. Check that the selected envelope size is correct, and then press [OK].

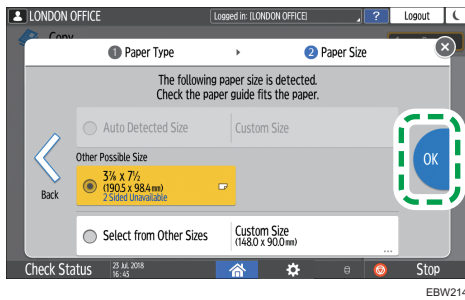

2

- If the selected envelope size is not the same as the actual size, select the correct envelope size.
- When you select [Custom Size], enter the envelope size. When the envelope is set with the flap opened, be sure to include the width of the flap.

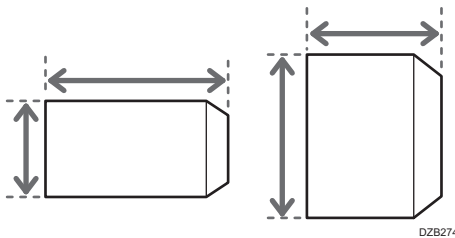

D2B274

6. Place the original on the exposure glass.

page 158 "Envelope Orientation and Recommended Status"

7. Press [Start].

Copying in Page Order or for Each Page Number

When copying two or more copies of multi-page originals, you can specify the page order as described below.

Sort

Copies in the order of the original.

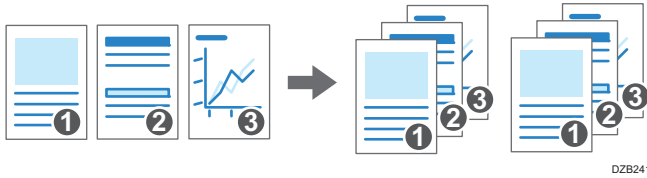

Rotate Sort

Copies in the order of the original and outputs by rotating each copy set. Each copy set is output lengthwise and breadthwise alternately to identify each set.

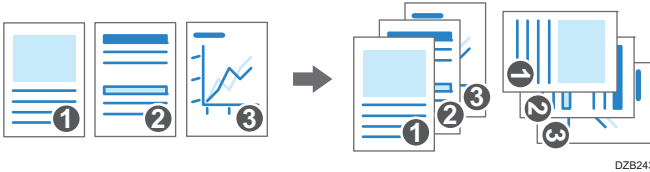

To specify rotate sort, use two paper trays and set the same size and type of paper in the trays in different orientations, vertically (☑) and horizontally (☑). When the paper cannot be set in vertical (☑) orientation, you cannot specify Rotate Sort.

1. Press [Copy] on the Home screen.

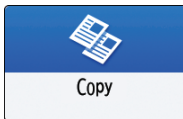

2. Place the original.

See "Placing an Original on the Scanner", User Guide (Full Version).

3. Press [Sort] on the Copy screen.

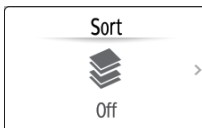

If the key is not displayed, select it from [Finishing].

4. Select the function to specify.

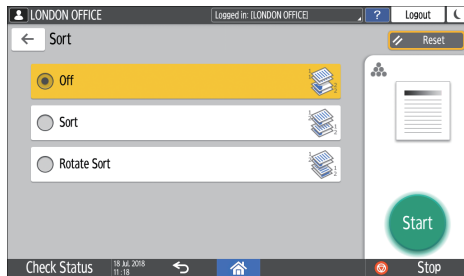

5. Press [Start].

- When selecting [Sort] or [Rotate Sort] and placing an original on the exposure glass, a single set of copies is made. After scanning all of the originals, press [Finish Scn] to copy the rest of the sets.

Note

- You can change the action to perform when paper or memory runs out during sorting under [Rotate Sort: Auto Paper Continue].
- See "Input / Output", User Guide (Full Version).

3. Fax

Basic Procedure for Transmitting Faxes

The machine scans an original to transmit it by fax into the machine's memory before establishing a communication with the destination (Memory Transmission).

1. Press [Fax] on the Home screen.

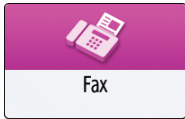

2. Place the original in the ADF or on the exposure glass.

See "Setting an Original to Send by Fax on the Scanner", User Guide (Full Version).

3. Press [Settings], and then specify the scan settings.

See "Sending a Fax at the Image Quality Suitable for the Original", User Guide (Full Version).

4. Specify the destination.

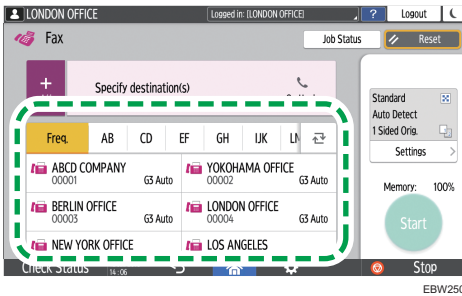

- To enter the fax number manually, select the destination from the destination history, or search for the destination in the address book, press , and specify the destination.

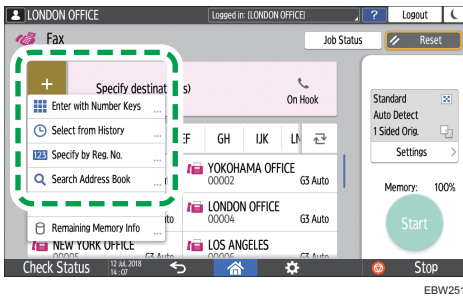

You can select only the destination entered using the numeric keypad from the history.

- To specify the destination again, press .

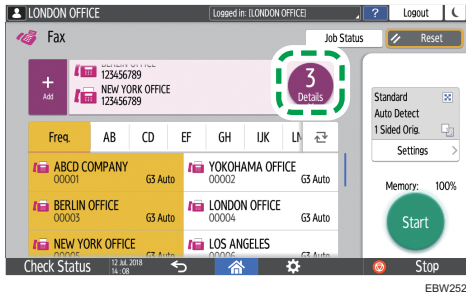

EBW252

3

5. Press [Start].

To cancel transmission after scanning the original, press [Stop] and operate in [Job Status] ► [Transmission Standby File].

See "Confirming and Handling a Document in the Fax Queue", User Guide (Full Version).

↓ Note

- If the telephone line you are connected to requires time to connect to the public line after you dial the external number, enter a [Pause] after entering the number to specify the time to wait before dialing the number. The machine pauses for about two seconds for each single [Pause] entered.
- To use tone-dialing in a pulse-dialing environment, press [Tone]. A tone signal is generated for every number you enter afterward.
- The communication that has been initiated first is displayed on the screen when performing three simultaneous communications.
- If an original jams in the ADF during scanning, sending of the fax is canceled.
- If the memory becomes full during scanning, sending of the fax is canceled and all pages of the original scanned into the memory are deleted from the memory.

Registering Fax Numbers in the Address Book

By registering the destinations to which you frequently send faxes together with the send conditions in the address book, you can easily send faxes.

Registering a Fax Number and Send Conditions

- 1. Press [Address Book] on the Home screen.

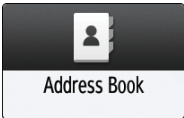

3

- 2. Press [Register] on the Address Book screen.

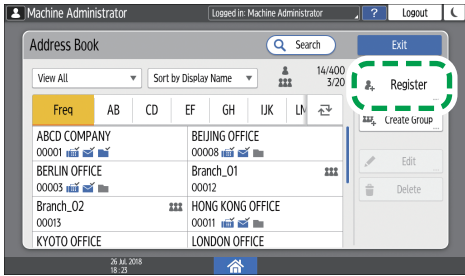

EBW698

- 3. Enter the information of the destination on the [Name] tab, and then select a title to classify it.

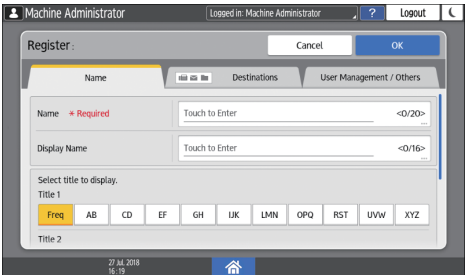

4. Press [Destinations] tab ▶ [Fax].

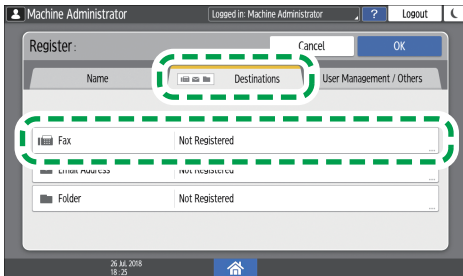

EBIW699

5. Specify the Fax Destinations and send conditions.

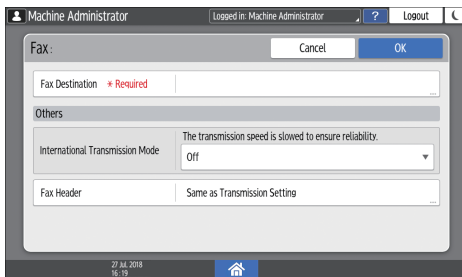

- International Transmission Mode: Specify whether to reduce errors occurring when sending abroad.
- Fax Header: Select the name of the sender printed on the reception sheet of the destination. Register the fax header in advance.

See "Printing the Fax Header on the Fax Received at the Destination", User Guide (Full Version).

6. Press the [User Management / Others] tab, and specify the required settings.

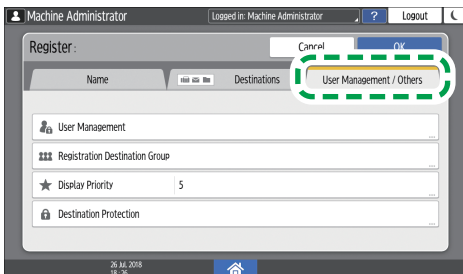

EBW700

- User Management: Enter the authentication information to login and use the machine.
- Registration Destination Group: Select a group to which this destination belongs as necessary. Register the group in advance.

See "Registering Groups in the Address Book", User Guide (Full Version).

- **Display Priority:** When the destinations are sorted in the order of priority, a destination with higher priority is displayed prior to that with lower priority. The destinations with the same priority are displayed in the order of registration.
- **Destination Protection:** Select this check box to require entering of the protection code to select the destination.

See "Using the Protection Function to Prevent the Misuse of Addresses", User Guide (Full Version).

7. Press [OK].

8. After completing the procedure, press [Home] (🏠).

Changing/Deleting the Registered Data Such as Fax Number

1. Press [Address Book] on the Home screen.

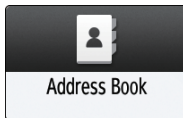

2. Select the destination to change or delete on the Address Book screen.

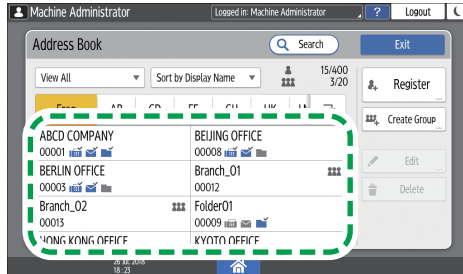

You can delete multiple destinations at one time.

3. Press [Edit] or [Delete] to change or delete the destination information.

4. When changing or deleting is complete, press [Home] (🏠).

Viewing the Transmission Result of Sent Faxes

You can check the result of a fax transmission on the fax screen, in various reports, or on the screen of a computer.

Communication Failure Report is printed when a fax could not be sent to all specified destinations by Memory Transmission.

↓ Note

- The fax transmission results can also be confirmed in Records.
- See "Viewing the History of Sent and Received Faxes", User Guide (Full Version).

3

Confirming the Information on the Fax Screen

Press [Job Status] ▶ [Transmission File Status] on the fax screen to view the information.

1. Press [Fax] on the Home screen.

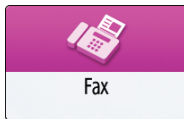

2. Press [Job Status] on the fax screen.

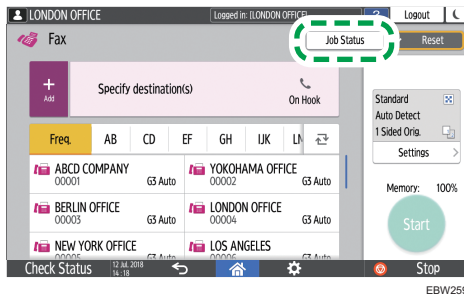

3. Press [Transmission Result].

4. Check the transmission results and press [Exit].

Date/Time	Destination	Dest.	Sender Name	Orig.	No.	Status
19 Dec 14:42	1234564854	1		1	0206	Completed
19 Dec 14:34	1234564854	1		1	0204	Completed
19 Dec 10:51	1234567854	1		1	0102	Completed
17 Dec 09:34	0000000013	1		5	0001	Completed
13 Dec 18:34	0000000031	1		1	0025	Completed
13 Dec	0000000055	1		1	0074	Completed

- The transmission results from among the total number of both transmission and reception results, which cannot exceed 60, are displayed.
- "--LAN-Fax -->" is shown as the result of transmission to the machine when you send a fax from your computer. For the result of transmission to the destination, refer to the transmission result of the same document number.
- The destination may be displayed as "*" depending on the security settings.
- In a field for an e-mail that was encrypted and forwarded, the encryption icon (🔒) is displayed.
- To display the result of the transmission that is completed while displaying the transmission results, close the transmission result screen and open it again.

↓ Note

- You cannot confirm or change an outgoing document in LAN-Fax, document waiting, or document whose status is "Trnsmtg".

Checking the Result in Communication Failure Report

This report is printed if the fax could not be sent to all specified destinations by Memory Transmission when Fax is not set to Auto Print (the factory default setting).

Confirming the Information in Web Image Monitor

In Web Image Monitor, you can view up to 60 of the latest total results of the transmission and reception history.

1. Log in to Web Image Monitor as the administrator.

See "Logging in to Web Image Monitor", User Guide (Full Version).

2. From the "Status/Information" menu, click [Job].

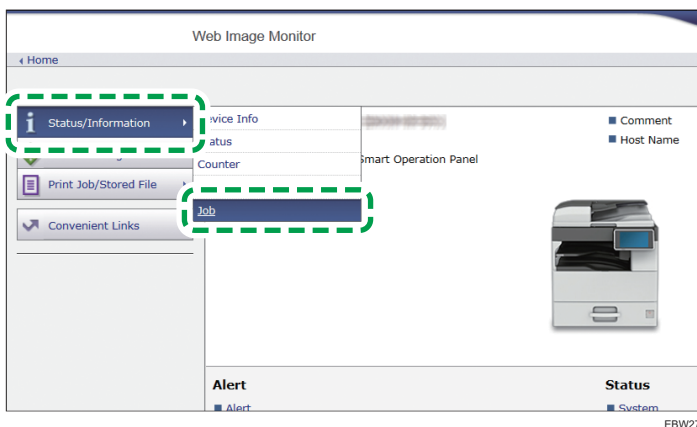

EBW274

3. Click [Transmission] under [Fax History].

4. Confirm the transmission history.

- Click [Details] to view the details.

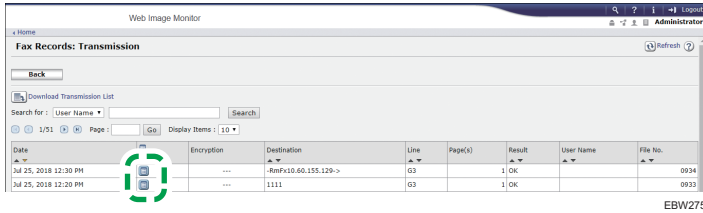

Web Image Monitor Administrator

Fax Records: Transmission

Back

Download Transmission List

Search for: User Name Search

1/21 Page: Go Display Items: 10

Date	Encryption	Destination	Line	Page(s)	Result	User Name	File No.
Jul 25, 2018 12:30 PM	---	-RmFx10.60.155.129->	63		1 OK		0934
Jul 25, 2018 12:20 PM	---	1111	63		1 OK		0933

EBW275

- To save the history as a list to a file in the CSV format, click [Download Transmission List].

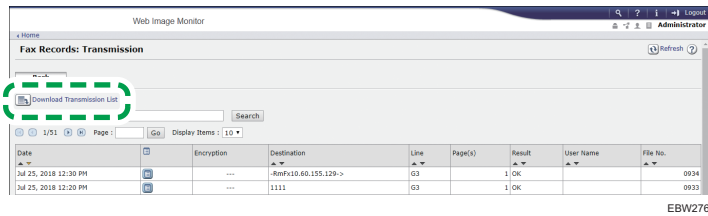

Web Image Monitor Administrator

Fax Records: Transmission

Download Transmission List

Search for: User Name Search

1/21 Page: Go Display Items: 10

Date	Encryption	Destination	Line	Page(s)	Result	User Name	File No.
Jul 25, 2018 12:30 PM	---	-RmFx10.60.155.129->	63		1 OK		0934
Jul 25, 2018 12:20 PM	---	1111	63		1 OK		0933

EBW276

5. Click [Logout] and then close the Web browser.

4. Print

Installing the Printer Driver by Using Device Software Manager Installer

Device Software Manager is a support utility for driver installation in Windows. Device Software Manager helps you to detect the latest driver via the internet automatically according to the computer you are using and install it with a simple procedure.

★ Important

- Device Software Manager supports Windows OS only. To install the printer driver on Mac OS, see the following sections:
- page 91 "Installing the Printer Driver for Network Connection (OS X/macOS)"
- See "Installing the Printer Driver for USB Connection (OS X/macOS)", User Guide (Full Version).
- Follow the instructions of the installer to connect the USB cable.

Installing Device Software Manager from the CD-ROM

1. Set the CD-ROM in the computer.

If the installer does not start automatically, double-click [Setup.exe] in the root directory of the CD-ROM.

2. Click [Install Online].

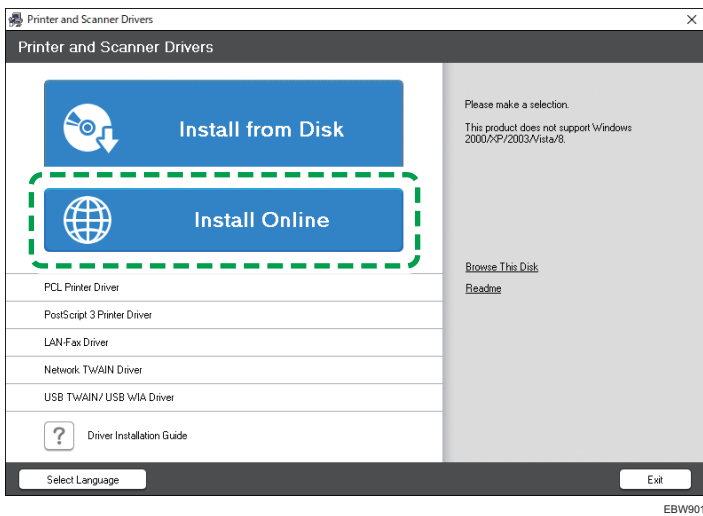

3. Select [I accept the agreement] on the "License Agreement" screen, and then click [Install].

4. On the "Quality Improvement Program" screen, select [I will participate in the Quality Improvement Program] or [I will not participate in the Quality Improvement Program], and then click [Next].
5. On the "Driver Update Notification Setting" screen, specify whether to display the message about the driver update, and then click [Next].

The process of installing Device Software Manager starts.

6. Select the connection between the machine and computer, and then click [Next].

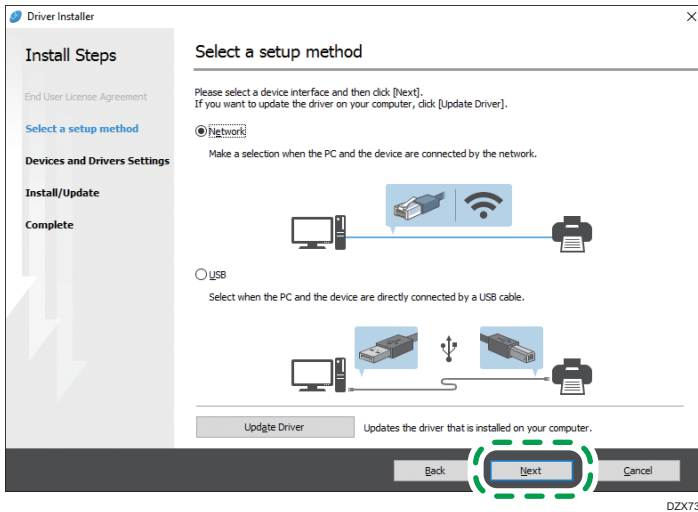

DZX730

- Network: Search for devices connected to the network.
- USB: Following the instructions on the "Connection with device" screen, connect the machine and the computer with the USB cable to search for the machine.

7. Select this machine from among the detected devices, and then click [Next].

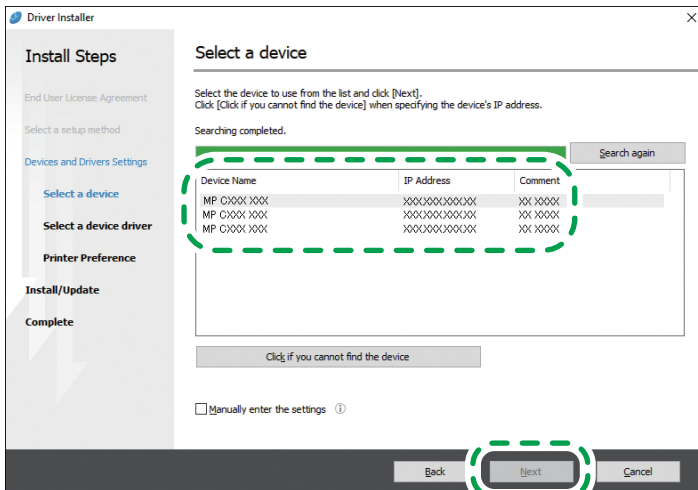

DZC086

The installation of the driver starts.

- If "Could not verify publisher" is displayed at the beginning of installation, continue the installation. There is no problem with the started installer that is downloaded from the manufacturer's website. Continue the installation.
- When you connect the machine and the computer with a USB cable, follow the instructions on the installer screen.

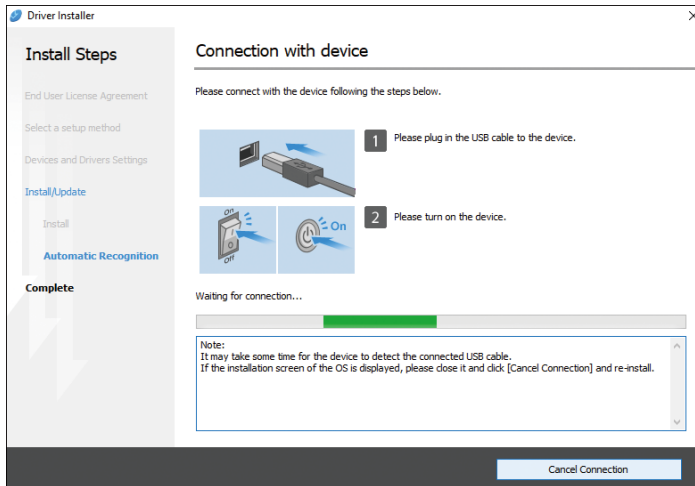

If the machine is not detected, click [Cancel Connection]. Even if the connection is canceled, the installation is complete. After the installer screen is closed, the machine is added automatically when it is connected to the computer with the USB cable.

8. When the installation is complete, click [Finish].

Note

- After completing the installation, Device Software Manager icon is created on the desktop screen.



- You can update the installed printer driver with Device Software Manager.
- See "Updating the Driver (Windows)", User Guide (Full Version).

Installing Device Software Manager from the Downloaded File

1. Double-click the downloaded file.
2. Select [I accept the agreement] on the "License Agreement" screen, and then click [Install].
3. Click [Next] on the "Welcome to the Device Software Manager Setup Wizard" screen.

4. On the "Quality Improvement Program" screen, select [I will participate in the Quality Improvement Program] or [I will not participate in the Quality Improvement Program], and then click [Next].
5. On the "Driver Update Notification Setting" screen, specify whether to display the message about the driver update, and then click [Next].

The process of installing Device Software Manager starts.

6. After completing the installation, select the [Run Device Software Manager] check box, and then click [Finish].

The installation of Install Online is complete. Next, install the printer driver.

7. On the "End User License Agreement" screen, select [Agree], and then click [Next].
8. Select the connection between the machine and computer, and then click [Next].

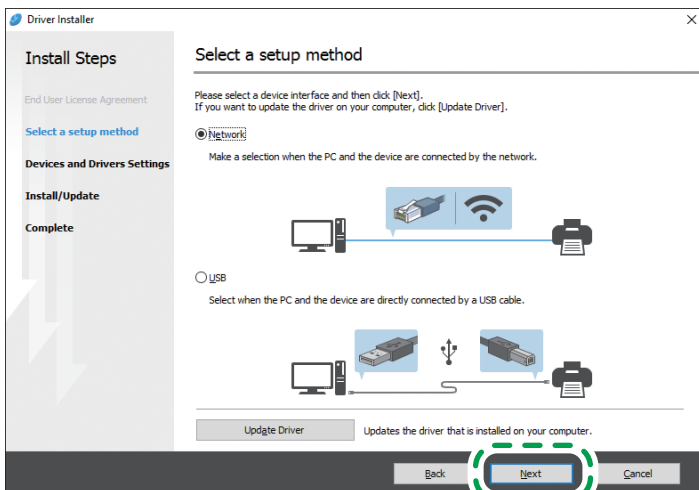

- Network: Search for devices connected to the network.
- USB: Following the instructions on the "Connection with device" screen, connect the machine and the computer with the USB cable to search for the machine.

9. Select this machine from among the detected devices, and then click [Next].

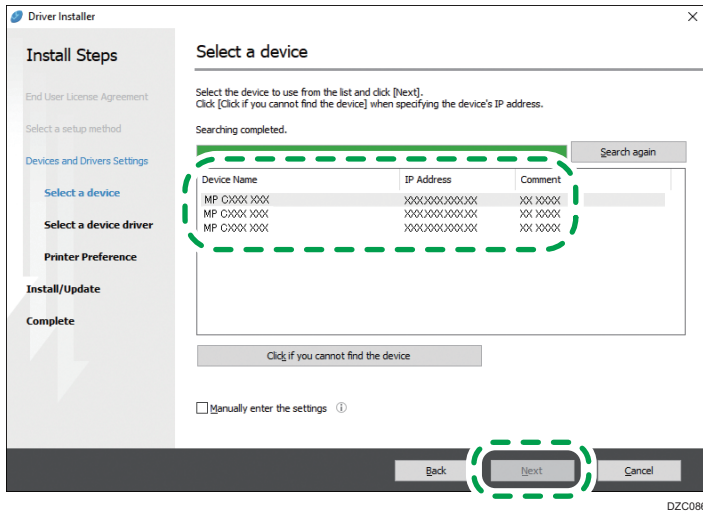

4

The installation of the driver starts.

- If "The publisher could not be verified" is displayed at the beginning of installation, continue the installation. There is no problem with the started installer that is downloaded from the manufacturer's website. Continue the installation.
- When you connect the machine and the computer with a USB cable, follow the instructions on the installer screen.

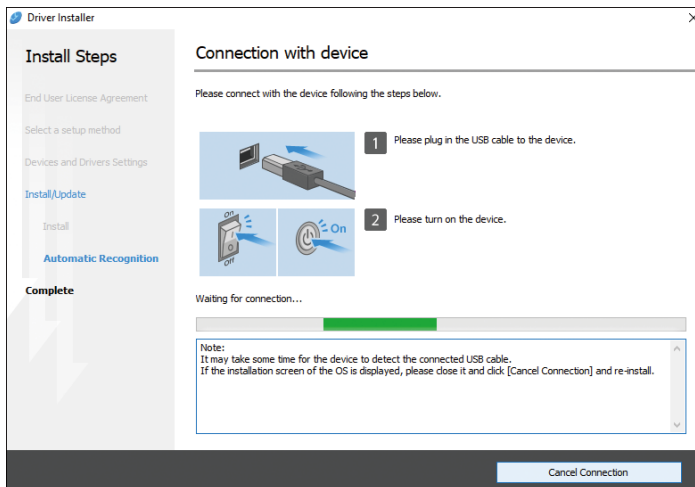

If the machine is not detected, click [Cancel Connection]. Even if the connection is canceled, the installation is complete. After the installer screen is closed, the machine is added automatically when it is connected to the computer with the USB cable.

10. When the installation is complete, click [Finish].

Note

- Double-click the Device Software Manager icon created on the Finder of the computer to update the printer driver.
- See "Updating the Driver (Windows)", User Guide (Full Version).



Installing the Printer Driver for Network Connection (Windows)

When the machine and the computer are connected to the same network, the installer searches for the machine to install the printer driver. If the installer cannot find the machine, specify the IP address or machine name to install the printer driver.

Installing the PCL 6 Printer Driver from the CD-ROM

1. Set the CD-ROM in the computer.

If the installer does not start automatically, double-click [Setup.exe] in the root directory of the CD-ROM.

2. Select a language, and then click [OK].

3. Click [Install from Disk].

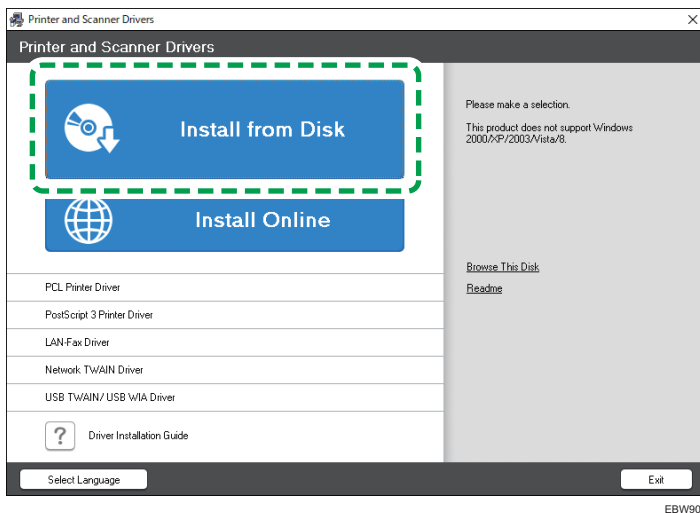

4. Click [Network Printer(s)].

5. On the "License Agreement" screen, select [I accept the agreement], and then click [Next].

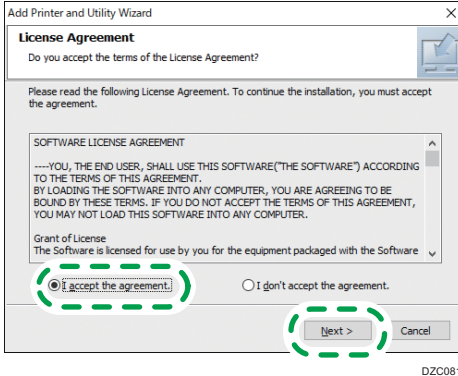

DZC081

6. Confirm the "Confirm Network Connection" screen, and then click [Next].
The search detects devices connected to the network.
7. Select this machine from among the devices, and then click [Install].

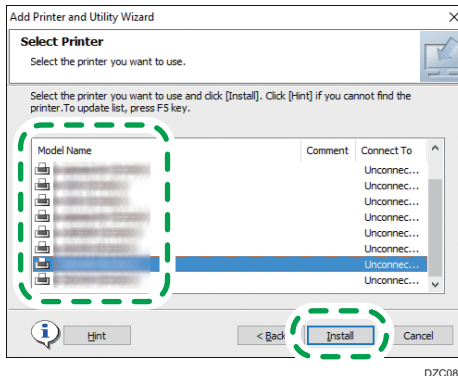

DZC080

8. If the "Set Port" screen is displayed, select the setting method of the port.
This screen is displayed when the computer cannot access the machine.

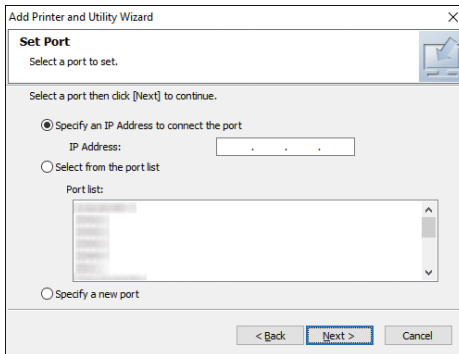

Specify the port to use for the connection between the computer and machine using one of the following methods:

To specify the IP address

1. Enter the IP address of the machine, and then click [Next].
2. Proceed to Step 9.

To select from the port list

1. Select the port to use for the connection between the computer and machine, and then click [Next].
2. Proceed to Step 9.

To create a new port

1. Select [Specify a new port], and then click [Next].
2. On the "Add Printer and Utility Wizard" screen, select [Standard TCP/IP Port] and click [Next].
3. On the "Add Standard TCP/IP Printer Port Wizard" screen, click [Next].
4. On the "Add port" screen, enter the printer name or IP address of the machine, and then click [Next].

The port name is automatically entered. You can change the port name.

5. When the "Additional port information required" screen is displayed, select [RICOH Network Printer C model], and then click [Next].
6. Click [Finish].

9. Specify the name of the printer to install, and whether to use it as the default printer.

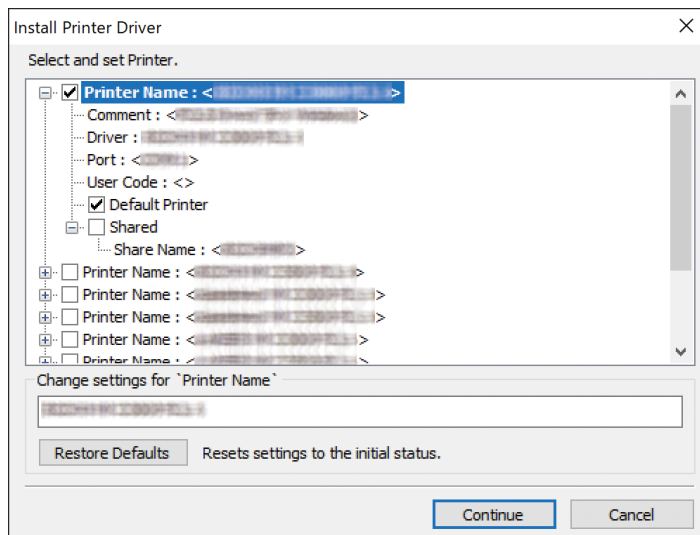

10. Click [Continue].

Printer driver installation starts.

11. Click [Finish].

When you are prompted to restart your computer, restart it by following the instructions that appear.

Installing the PostScript 3 Printer Driver from the CD-ROM

1. Set the CD-ROM in the computer.

If the installer does not start automatically, double-click [Setup.exe] in the root directory of the CD-ROM.

2. Select a language, and then click [OK].

3. Click [PostScript 3 Printer Driver].

4

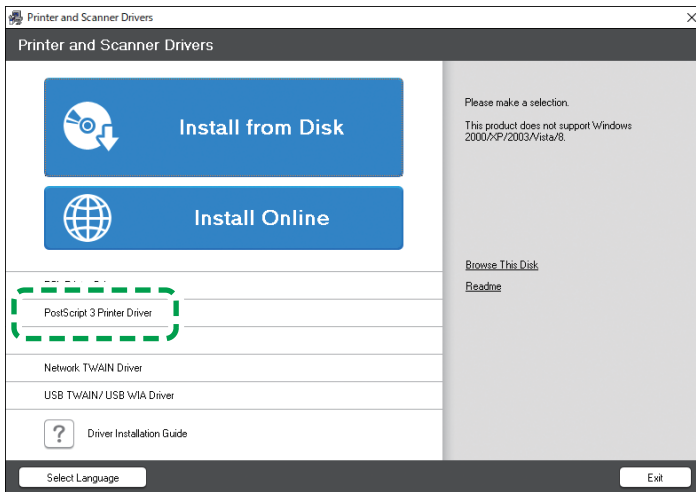

EBW903

4. On the "License Agreement" screen, select [I accept the agreement], and then click [Next].

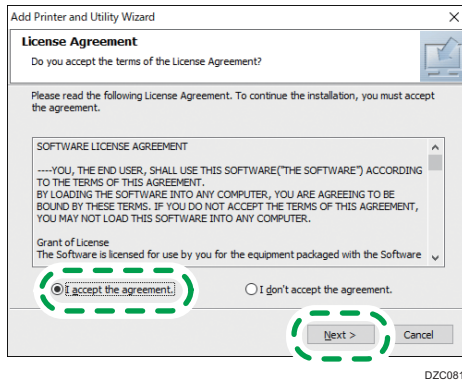

5. Click [Next].
6. Select a method to connect a port.

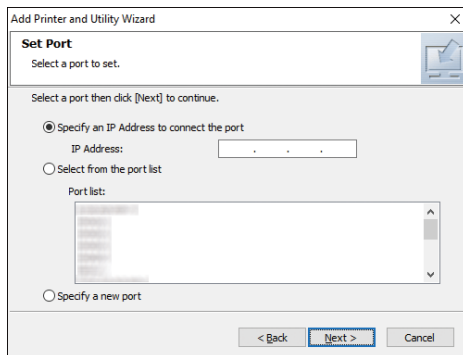

Specify the port to use for the connection between the computer and machine using one of the following methods:

To specify the IP address

1. Enter the IP address of the machine, and then click [Next].

To select from the port list

1. Select the port to use for the connection between the computer and machine, and then click [Next].

To create a new port

1. Select [Specify a new port], and then click [Next].
2. On the "Add Printer and Utility Wizard" screen, select [Standard TCP/IP Port] and click [Next].
3. On the "Add Standard TCP/IP Printer Port Wizard" screen, click [Next].

- On the "Add port" screen, enter the printer name or IP address of the machine, and then click [Next].

The port name is automatically entered. You can change the port name.

- When the "Additional port information required" screen is displayed, select [RICOH Network Printer C model], and then click [Next].
- Click [Finish].

7. Select the [Printer Name] of the machine to open the menu tree, and then specify the setting items.

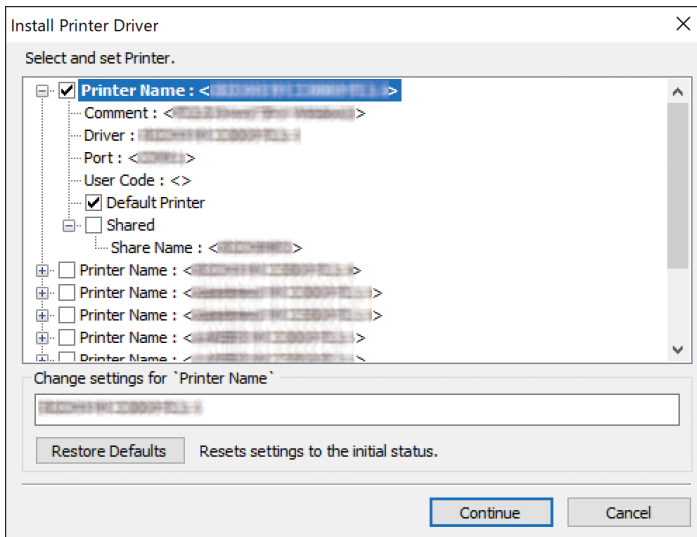

8. Click [Continue].

Printer driver installation starts.

9. Click [Finish].

When you are prompted to restart your computer, restart it by following the instructions that appear.

Installing the PCL 6/PostScript 3 Printer Driver from the Downloaded File

- Double-click the downloaded file.
- Confirm where to install, and then click [Extract] or [Install].
 - If the "Security Warning" screen is displayed, click [OK].
 - If the "User Account Control" screen is displayed, click [Yes] or [Allow].
- On the "End User License Agreement" screen, select [Agree], and then click [Next].

4. Select [Network], and then click [Next].

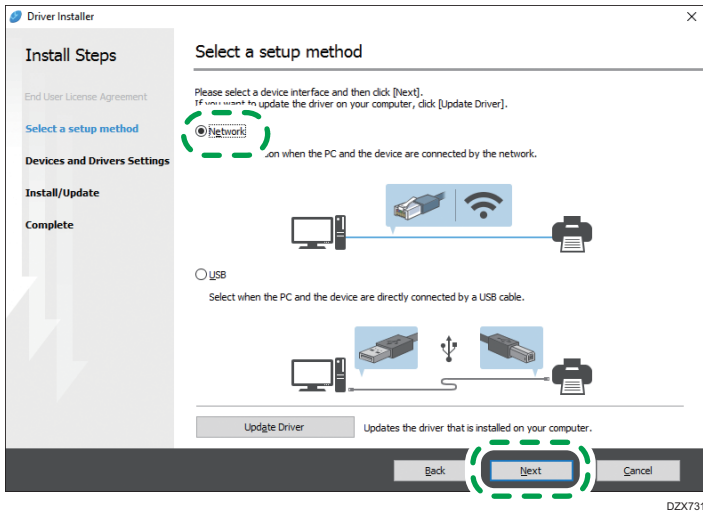

- The search detects devices connected to the network.
- If the error screen is displayed, see page 87 "If the Machine Cannot Be Found".

5. Select this machine from among the detected devices, and then click [Next].

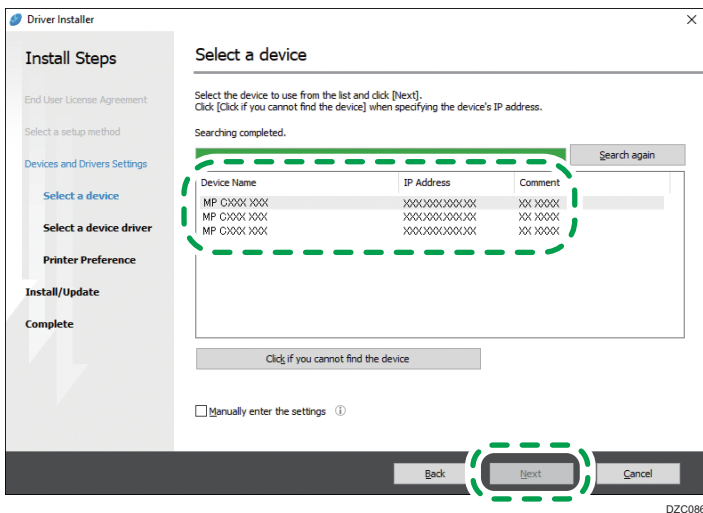

Printer driver installation starts.

6. When the installation is complete, click [Finish].

If the Machine Cannot Be Found

The "Network Connection Error" screen is displayed.

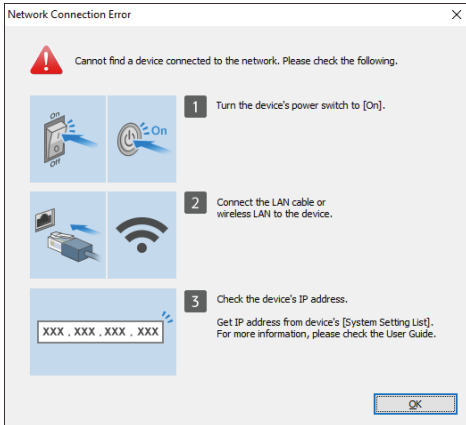

4

Confirm and perform **1** to **3**, and then click [OK]. If the machine still cannot be found, specify the IP address or machine name to install the printer driver.

1. Click [Click if you cannot find the device].

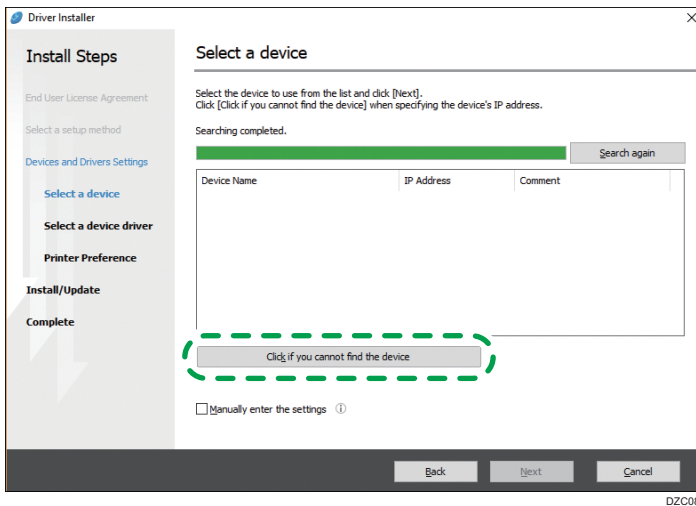

2. Select [Specify device IP address] or [Specify device name], and then click [Next].

When specify the machine IP address

1. Enter the IP address of the machine and click [Search].

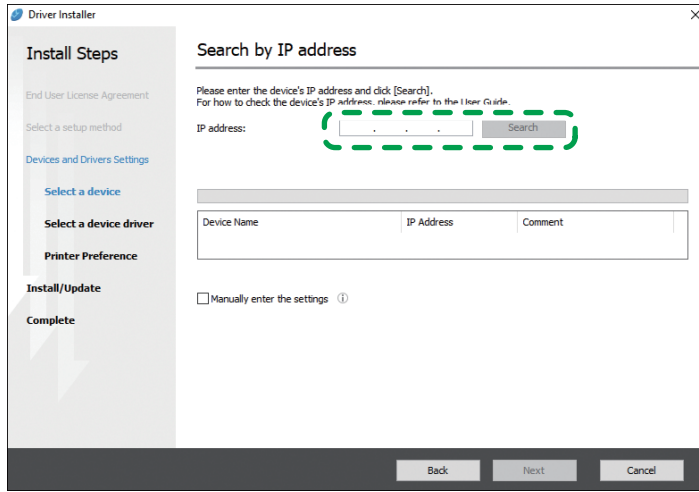

DZC091

2. When the machine is detected, click [Next].

Printer driver installation starts.

When specify the machine name

1. Select the machine to use, and then click [Next].

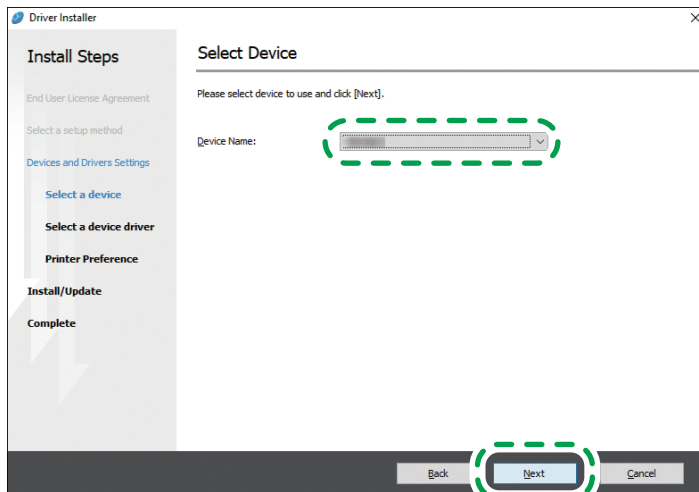

DZC094

2. On the "Printer Preference" screen, select one of the port names from among "Port Name", and then click [Next].

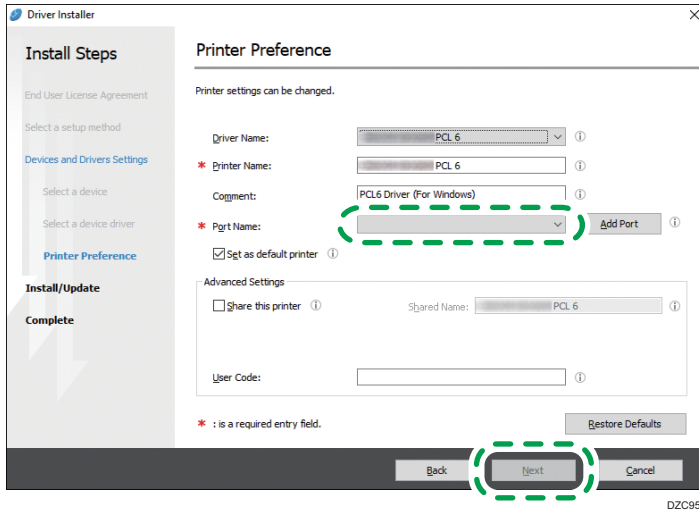

Printer driver installation starts.

For details about the procedure for specifying the IP address after installing the printer driver, see the following section:

See "When You Cannot Print a Document even if the Printer Driver is Installed", User Guide (Full Version).

3. When the installation is complete, click [Finish].

Installing the Printer Driver for Network Connection (OS X/macOS)

Install the PPD file (printer driver) under OS X/macOS, and then register the machine on the computer from the system preferences.

Installing the PPD file

1. Set the CD-ROM in the computer, and click [macOS] to display the [macOS PPD Installer] folder.

To install the driver from the downloaded file, display the folder that is the location of the downloaded file.

2. Double-click the package file.

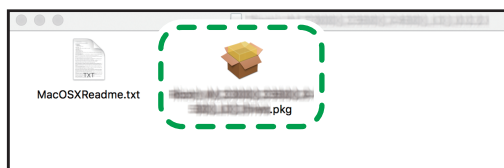

DZX684

- To install from the CD-ROM, double-click the package file in the [macOS] ► [macOS PPD Installer] folder.
 - When the install confirmation screen is displayed, click [Continue].
3. On the "Introduction" screen, click [Continue].
 4. On the "License" screen, click [Continue] and then click [Accept].
 - When prompted to select where to install the driver, specify the install location, and click [Continue].

5. Click [Install].

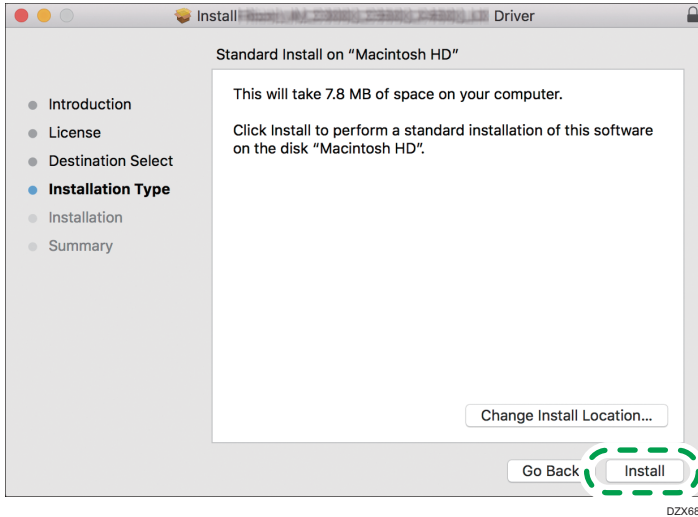

4

6. Enter the computer's user name and password, and then click [Install Software].

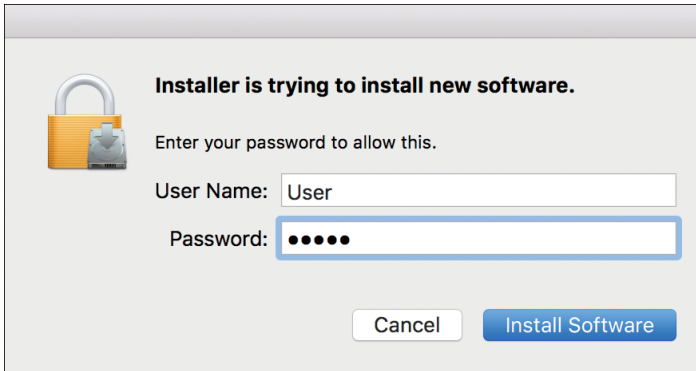

The installation of the PPD file starts.

7. When the installation is complete, click [Close].

Registering the Machine in [Print & Scan] or [Printers & Scanners]

Register the PPD file of the machine in the system preferences to enable printing.

1. Select [System Preferences...] from the Apple menu.
2. Click [Print & Scan] or [Printers & Scanners].

3. Click [+].

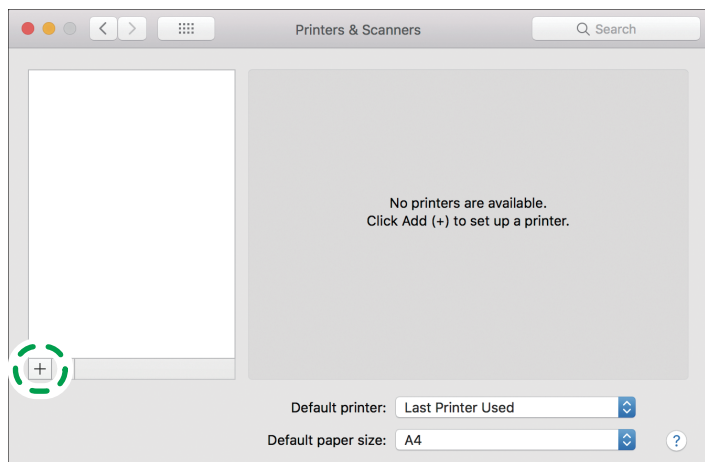

DZX689

4. Click [IP], and configure the information of the machine.

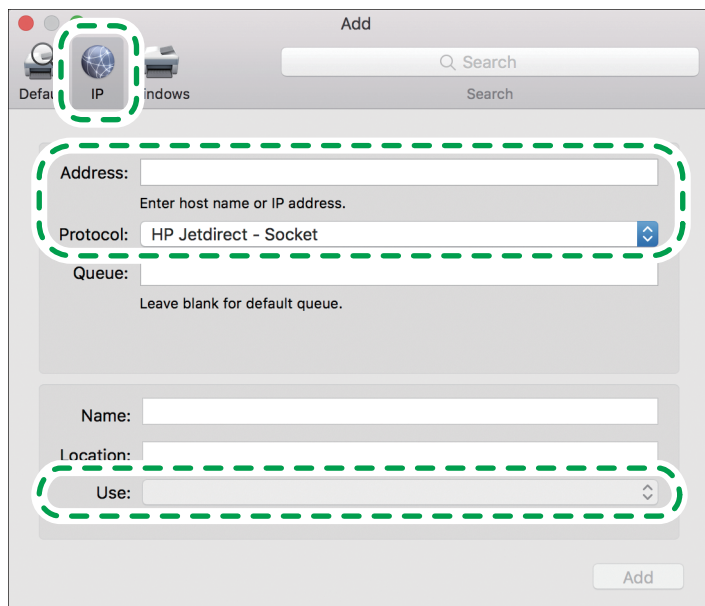

DZX690

- Address: Enter the IP address of the machine.
- Protocol: Select [LPD (Line Printer Daemon)]. If the printer takes time to perform operations when using the [LPD (Line Printer Daemon)] protocol, change the protocol to [HP Jetdirect - Socket].
- Use: Check that the machine name is displayed. If "Generic PostScript Printer" is displayed, the entered IP address may not be correct.

When "Generic PostScript Printer" is displayed even though the IP address is correct

Perform the following procedure to select the PPD file of the machine:

1. Select [Select Software...] on "Use".

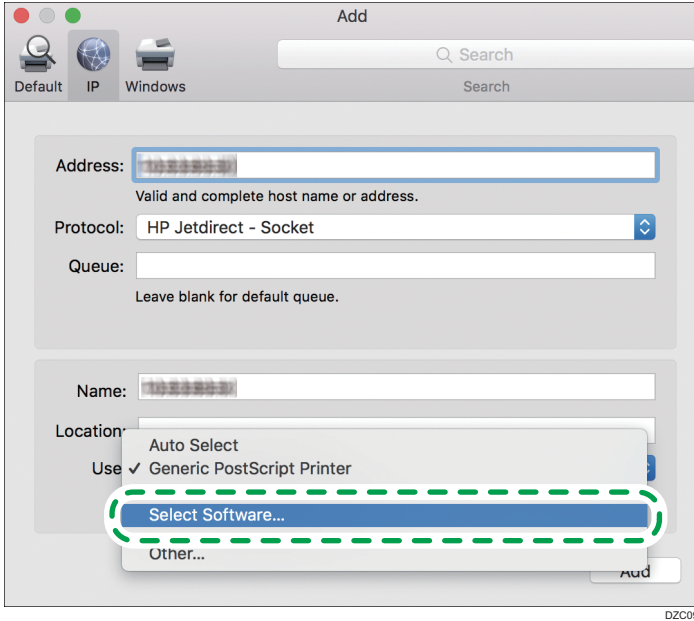

2. Select the machine on the "Printer Software" screen, and then click [OK].

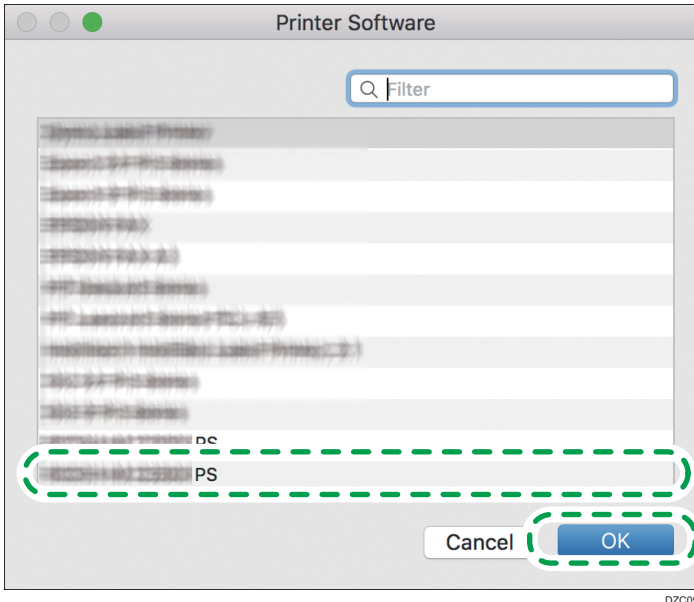

5. Click [Add].

The progress screen is displayed.

- If the progress screen does not close after a while, click [Configure...] or [Settings] and configure the option configuration of the printer. For the procedure of the option configuration, see page 95 "Specifying the Option Settings".

6. Check that the machine name is added to the [Print & Scan] or [Printers & Scanners] screen.

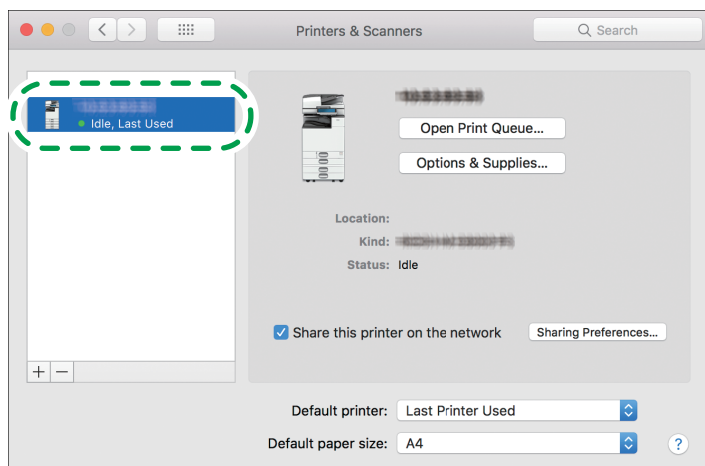

7. Close the system preferences screen.

Specifying the Option Settings

If the option configuration of the machine is not automatically reflected, select the option installed on the machine in [Print & Scan] or [Printers & Scanners].

1. Select [System Preferences...] from the Apple menu.
2. Click [Print & Scan] or [Printers & Scanners].

3. Select the machine from the list, and then click [Options & Supplies...].

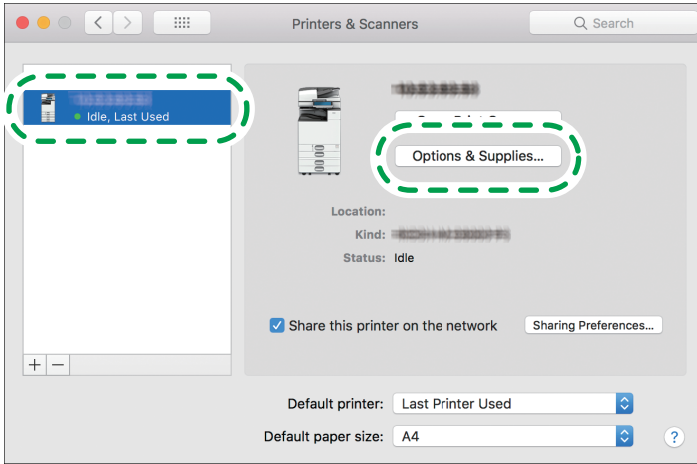

DZX693

4. Click [Driver] or [Options], select the option installed on the machine, and then click [OK].

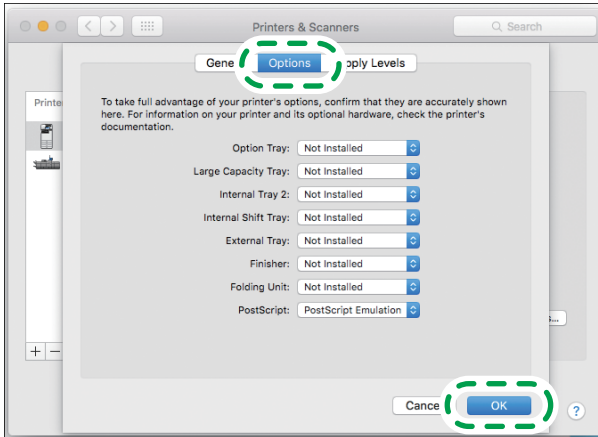

DZX694

- If the usable options are not displayed, the IP address has not been entered correctly or the PPD file has not been registered properly. To enter the IP address or register the PPD file, see page 92 "Registering the Machine in [Print & Scan] or [Printers & Scanners]".

5. Close the system preferences screen.

Basic Procedure for Printing Documents

Specify the printer driver and configure the Document Size, Paper Type, and other settings to print a document.

★ Important

- Duplex printing is selected as the default setting. If you want to print on only one side, select [Off] for the two-sided printing setting.
- If you send a print job via USB 2.0 while the machine is in Sleep mode, an error message may appear after the print job is completed. In this case, check whether the document was printed.

Printing a Document in Windows

4

1. Open a document to print on the computer, and display the setting screen of the printer driver from the print menu in the application.

The method to display a document varies depending on the applications.

For example in Microsoft Word/Excel, click [Print] on the [File] menu, select the device to use, and then click [Printer Properties].

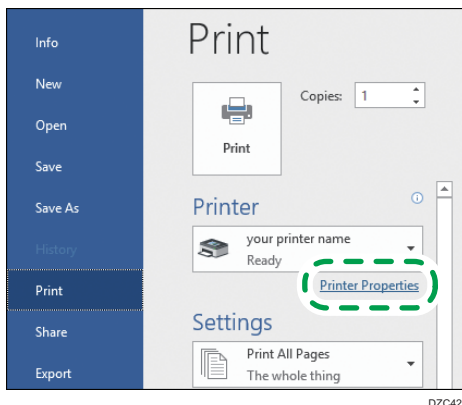

2. Specify the Document Size, Paper Type, Input Tray, and other settings.

You can specify the print settings on the [Frequently Used Settings] tab and [Detailed Settings] tab. Basic settings can be specified on the [Frequently Used Settings] tab, even if you do not use the [Detailed Settings] tab.

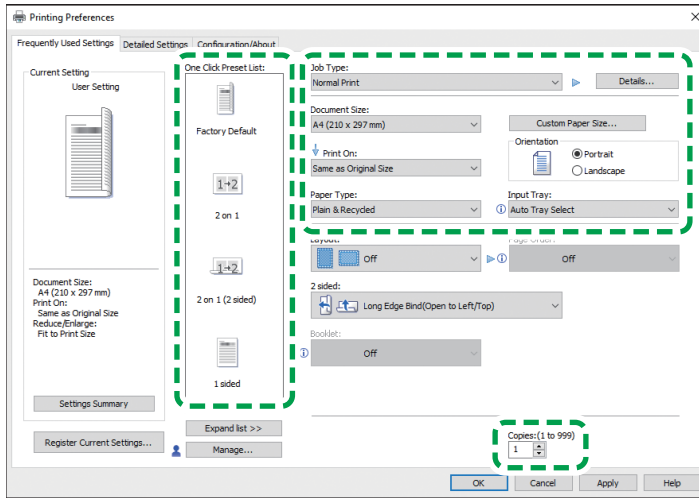

EBW360

- One Click Preset List: Some of the useful functions such as Combine or 2-sided are registered. Click the icon of the function to select. You can register frequently used print settings in One-click settings.

See "Registering Frequently Used Settings", User Guide (Full Version).

- Job Type: Select [Normal Print] to execute printing immediately.

You can store documents in the machine (Locked Print).

See "Storing a Locked Print File to the Machine", User Guide (Full Version).

- Document Size: Select the size of the document to print.
- Orientation: Specify the orientation of the document. Select Portrait or Landscape.
- Paper Type: Select the type of paper to use.
- Input Tray: Select the tray loaded with the paper to use. When you select [Auto Tray Select], a suitable paper tray is selected automatically according to the specified [Print On] and [Paper Type].
- Copies: Enter the print quantity.

On the [Detailed Settings] tab, you can configure the advanced settings. Change the menu and specify the setting items.

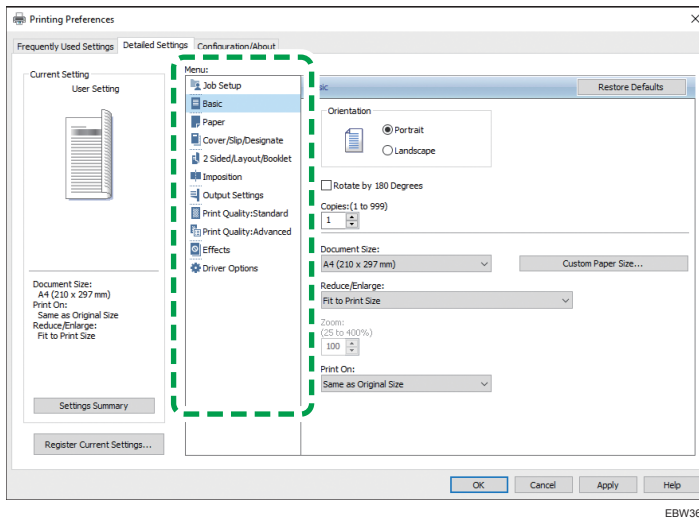

The caution icon (ⓘ) indicates that there are disabled items. Click the icon to check the cause.

3. After completing the configuration, click [OK] to print.

↓ Note

- On the [Devices and Printers] screen, right-click the printer icon of the machine, and then click [Print Settings] to change the default values of the printer settings.
- When you use the driver distributed from the print server, [Standard settings] specified in the print server are displayed as the default.

Printing a Document in OS X/macOS

In the following example procedure, OS X 10.13 is used. The procedure may vary for different versions.

1. Open a document to print on the computer, and click [Print] on the [File] menu.
2. Select the printer you use from "Printer:".

3. Specify Paper Size, Orientation, and other settings.

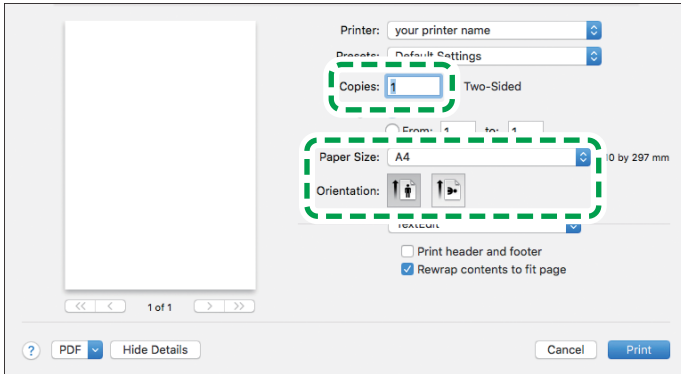

EBW382

- Copies: Enter the print quantity.
- Paper Size: Select the size of the document to print.
- Orientation: Specify the orientation of the document. Select Portrait or Landscape.

4. Select a category from the pop-up menu, and then specify the paper tray and paper type.

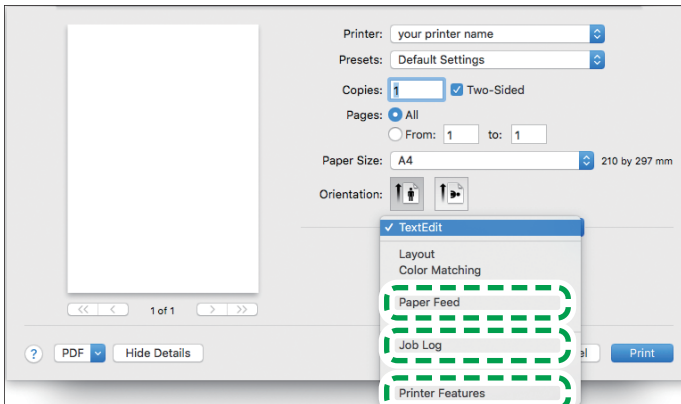

EBW383

Paper Feed

- All Pages From: Select the tray loaded with the paper to use. When you select [Auto Select], a suitable paper tray is selected automatically according to the specified paper size and paper type.

When the paper of the specified size is not loaded on the machine, printing is performed following the settings of the machine.

Job Log

- Job Type: Select [Normal Print] to execute printing immediately.

You can store documents in the machine (Locked Print).

See "Storing a Locked Print File to the Machine", User Guide (Full Version).

Printer Features

Select a category in "Feature Sets", and then specify the setting items.

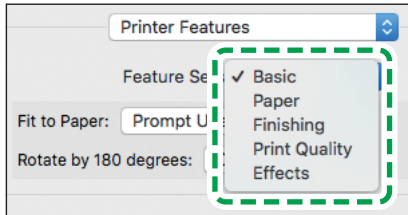

- Paper
 - Paper Type: Select the type of paper to use.

5. After completing the configuration, click [Print] to print.

Printing on Both Sides of Paper

Specify 2-sided Print in the printer driver.

Specifying 2-sided Print (Windows)

Specify 2-sided Print on the [Frequently Used Settings] tab.





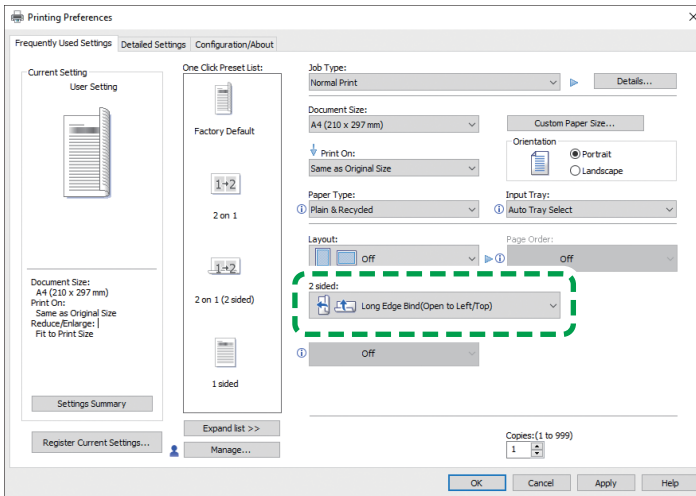

1. Open a document to print on the computer, and display the setting screen of the printer driver from the print menu in the application.
2. Specify Document Size, Paper Type, Orientation and others.
page 97 "Basic Procedure for Printing Documents"
3. On the [Frequently Used Settings] tab, click "2 sided" to specify the binding side and opening type of the paper.

4



EBW362

Orientation of the original and opening type

Orientation	Open to Left	Open to Top
Portrait 		
Landscape 		

4. After completing the configuration, click [OK] to print.

Specifying 2-sided Print (OS X/macOS)

Specify 2-sided Print on the [Layout] menu.

1. Open a document to print on the computer, and display the setting screen of the printer driver from the print menu in the application.
2. Specify Paper Size, Orientation, and other settings.
page 97 "Basic Procedure for Printing Documents"
3. Select the [Two-Sided] check box, and then select [Layout] to specify the binding side and opening type of the paper.

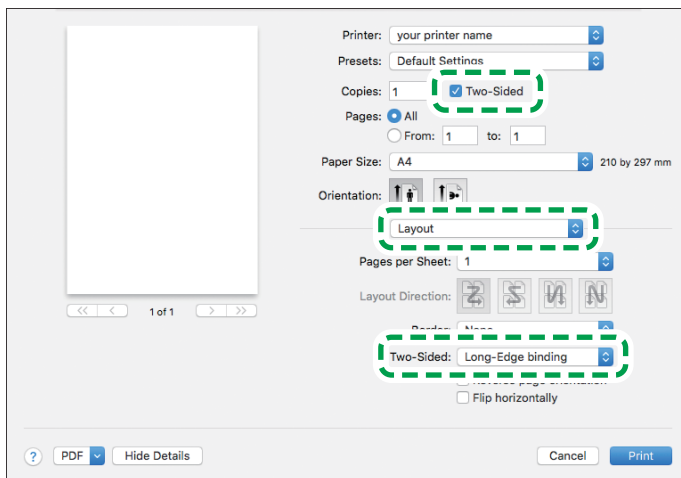

EBW385

Orientation of the original and opening type

Long edge



Short edge



DZC442

4. After completing the configuration, click [Print] to print.

Combining and Printing Multiple Pages on a Single Sheet of Paper

You can print multiple pages on a single sheet at a reduced size (Combine 2 Originals).

For example, you can reduce an original of A4 size to A5 size and print two pages on an A4 sheet. You can use the 2 Sided Print and Combine 2 Originals functions at the same time to economize on paper.

You can print up to 16 pages on a single sheet and specify the order to arrange the pages on the sheet.

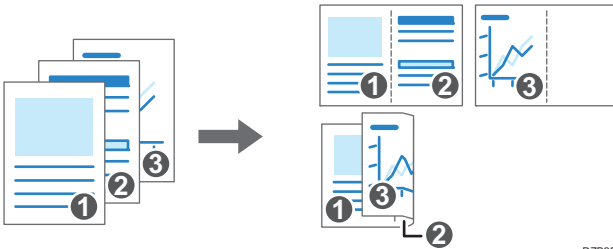

DZB253

Specifying the Combine 2 Originals Function (Windows)

Specify the Combine 2 Originals function on the [Frequently Used Settings] tab.

1. Open a document to print on the computer, and display the setting screen of the printer driver from the print menu in the application.
2. Specify Document Size, Paper Type, Orientation and other settings.
page 97 "Basic Procedure for Printing Documents"
3. Specify the number of pages to combine and the order of the pages.

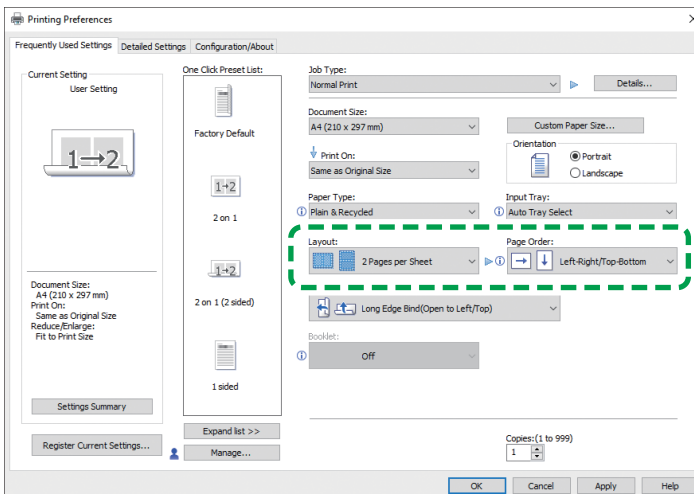

EBW363

- Layout: Select the number of pages to combine.
- Page Order: Select the order of the pages.
- Draw Frame Border: Select the Draw Frame Border check box on the [Detailed Settings] tab ► [2 Sided/Layout/Booklet] to draw a line between pages.

4. After completing the configuration, click [OK] to print.

When printing from an application that supports the same function as the machine, do not set the function in the application. If the setting in the application is enabled, the print result may not be as intended.

Specifying the Combine 2 Originals Function (OS X/macOS)

4

Specify the Combine 2 Originals function on the [Layout] menu.

1. Open a document to print on the computer, and display the setting screen of the printer driver from the print menu in the application.
2. Specify Paper Size, Orientation, and other settings.
page 97 "Basic Procedure for Printing Documents"
3. Select [Layout], and then specify the number of pages to combine and the order of the pages.

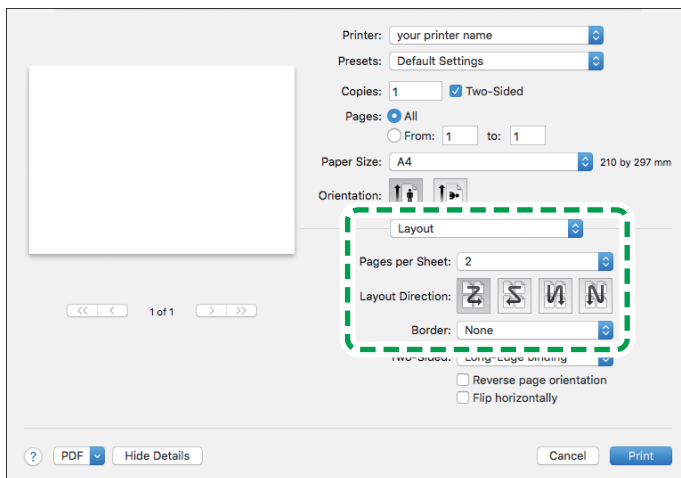

EBW386

- Pages per Sheet: Select the number of pages to combine.
- Layout Direction: Select the order of the pages.
- Border: Select a type of border line to draw between the pages.



4. After completing the configuration, click [Print] to print.

Printing on Envelopes

Load envelopes in the bypass tray or paper tray.

Load envelopes in the machine and change the Tray Paper Settings in the Control Panel.

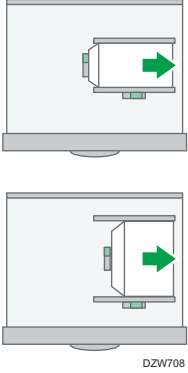
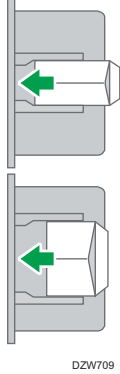
1. Load an envelope in the Bypass Tray or the Paper Tray.

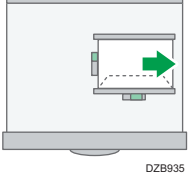
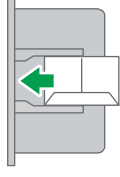
Types and orientations of envelopes	Tray 1 to 3	Bypass Tray
Side-opening envelopes 	 <p>Flap: open Bottom side of the envelope: right Printing surface: upper side</p>	 <p>Flap: open Bottom side of the envelope: left Printing surface: lower side</p>
Side-opening envelopes 	 <p>Flap: close Bottom side of the envelope: back Printing surface: upper side</p>	 <p>Flap: close Bottom side of the envelope: back Printing surface: lower side</p>

2. On the Home screen, press [Settings].

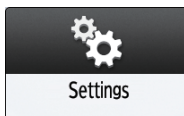

- Press [Tray Paper Settings] ► [Tray Paper Size] or [Printer Bypass Paper Size], and then select the size of the envelopes.

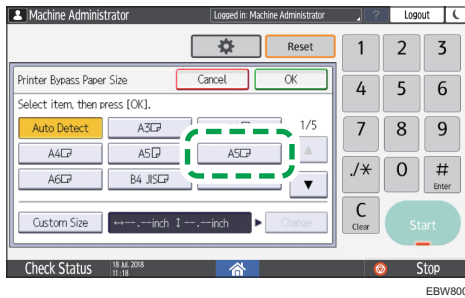

- If the size of the loaded envelope is not included in the list, select [Custom Size] and enter the value.

- Press [OK].
- Press "Paper Type" of the tray with loaded the envelopes, and then select [Envelope].

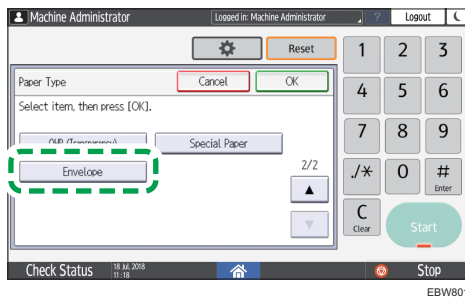

- After completing the configuration, press [Home] (🏠).
- Open a document to print in the computer, and display the setting screen of the printer driver from the print menu application.

8. Specify the paper size and paper type.

Windows

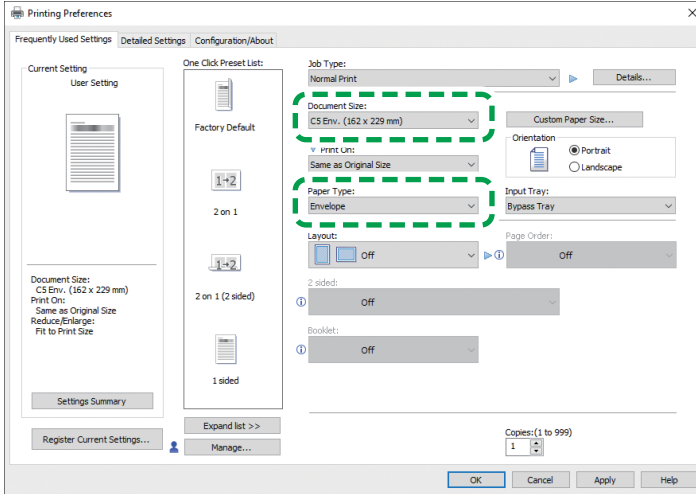

EBW365

- Document Size: Select the envelope size. If the envelope size is not included among the options, enter the value in [Custom Paper Size...].
- Paper Type: [Envelope]

You can specify a custom paper size, which is commonly used as the option of the Document Sizes.

See "Printing on Custom-sized Paper Loaded on the Bypass Tray", User Guide (Full Version).

OS X/macOS

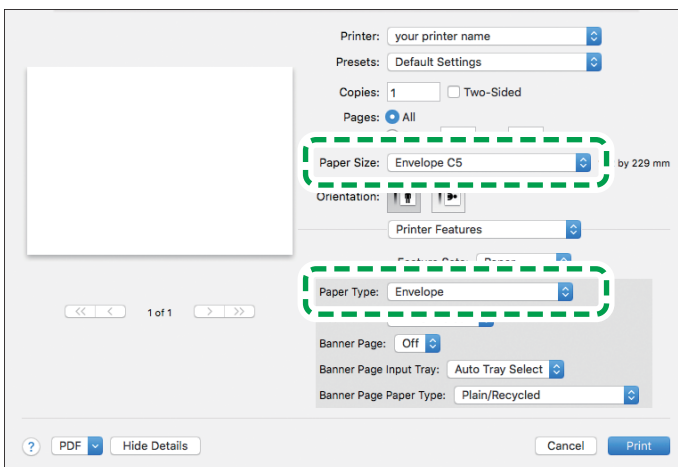

EBW388

- Paper Size: Select the envelope size. If the envelope size is not included among the options, select [Manage Custom Sizes] and enter the value.

- Paper Type: [Envelope]

9. Execute printing.

Printing a Locked Print File Using Quick Print Release

Using the Quick Print Release function, you can view the list of documents that are stored on the machine. From the list, any documents can be selected and printed.

★ Important

- The Locked Print document is deleted automatically after printing.

1. On the Home screen, press [Quick Print Release].



2. On the Quick Print Release screen, select the user ID used to store the document.

3. Enter the password for the documents, and then press [OK].

The list of documents that matches the entered password is displayed.

4. Select a document to print.

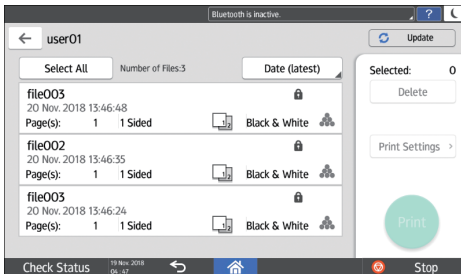

More than one document can be selected at one time.

You can perform the following operations on the selected documents:

- Delete
Deletes the selected documents.
See "Deleting a Locked Print File Stored in the Machine", User Guide (Full Version).
- Print Settings
You can change the number of copies.

5. Press [Print].

Printing from a USB Flash Memory Device or SD Card Directly

You can connect a memory storage device to the media slot of the machine and print the files stored on it. Use this to print external data easily.

CAUTION

- Keep SD cards and USB flash memory devices out of reach of children. If a child accidentally swallows an SD card or USB flash memory device, consult a doctor immediately.

Note

- USB flash memory device and SD cards are supported for direct printing. However, certain types of USB flash memory device and SD cards cannot be used.
- The machine cannot print a document over 1 GB.
- You can select up to 99 files within 1 GB total.
- If the print job of PDF file is canceled, execute printing from a PDF viewer such as Acrobat Reader while using the printer driver.

4

Printable File Formats

File format	Details
JPEG files	Exif version 1.0 or later
TIFF files	Uncompressed TIFF files TIFF files compressed using the MH, MR, or MMR method
PDF files	PDF version 1.7 (Acrobat 8.0 compatible) or earlier ^{*1}

*1 The machine does not support the following functions: Color Space of Crypt Filter or DeviceN (more than eight components), watermark note, optional contents (version 1.6), AcroForm

Note

- The PDF file of a custom size may not be printed.

Printing from a Memory Storage Device or Scan Application

1. On the Home screen, press [Print/Scan (Memory Storage Device)]



2. On the Print/Scan (Memory Storage Device) screen, press [Print from Storage Device]



3. Insert a memory storage device in the media slot on the side of the control panel.

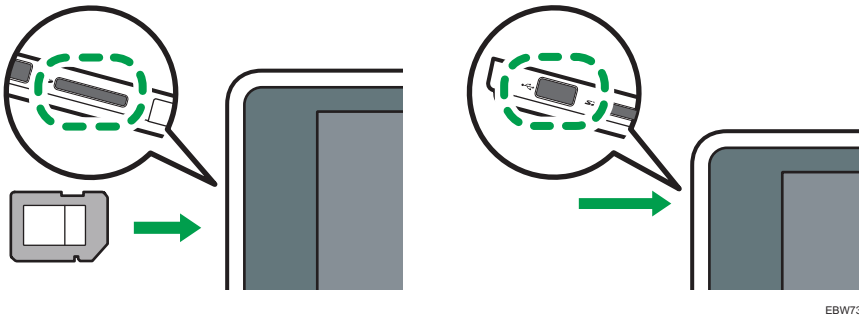

4. Press [USB] or [SD Card].

5. Select the file to print.

Files in the external media are displayed as icons or thumbnail images.

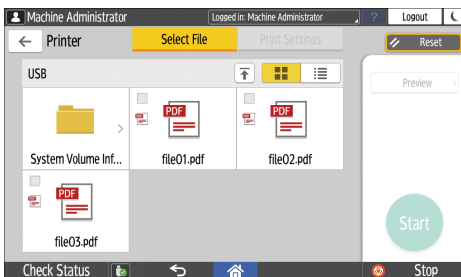

6. Press [Print Settings] to specify the settings of 2-Sided Print or Finishing as necessary.

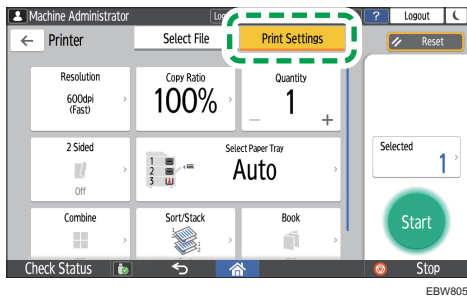

- Copy Ratio: Select whether to print in the original size or to reduce or enlarge to match the paper size.
- Quantity: Enter the print quantity.
- Resolution: Select the resolution of the image to print.
- Select Paper Tray: Select the paper tray.
- 2 Sided: Select the opening direction of the printed sheet.
- Combine: Select whether to combine multiple pages into a sheet.
- Sort/Stack: Select whether to print in ordered sets or in a batch page by page.
- Book: Select the opening direction of the Magazine binding. You can specify the setting of Magazine binding only when printing a file in the PDF format.

7. Press [Start] to start printing.

5. Scan

Scanning Documents and Sending the Scanned Data by E-mail

Scan a document and attach the scanned data to an e-mail and send it from the machine.

- Configure the SMTP server and network settings in advance.
See "Configuring the Settings to Send E-mails from the Machine", User Guide (Full Version).
- Register an e-mail address in the address book to select the address as the destination easily when sending an e-mail.
See "Registering E-mail Addresses in the Address Book", User Guide (Full Version).

5

Basic Procedure for Sending an E-mail

1. Press [Scanner] on the Home screen.

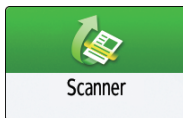

2. Select [Scan to Email] on the scanner screen.

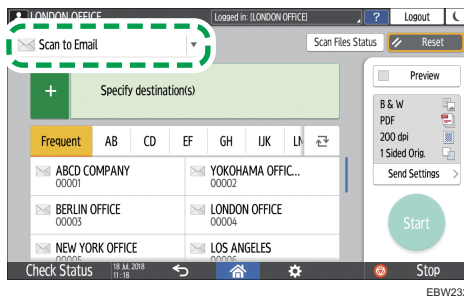

3. Place the original on the scanner.
See "Placing an Original to Scan", User Guide (Full Version).
4. Press [Send Settings] on the scanner screen.
5. Press [Sender] and specify the sender.
 - When a logged in user is operating the machine, the logged in user becomes the sender.
 - When [On] is specified in [System Settings] ► [File Transfer] ► [Auto Specify Sender Name], you can send an e-mail even when the sender is not specified. The administrator's e-mail address that is registered on the machine is used as the sender.

6. Specify the destination on the scanner screen.

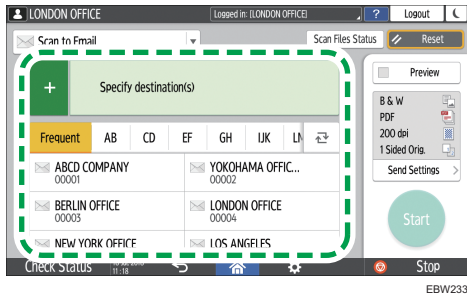

- To enter the e-mail address manually or search for the destination in the address book, press **+**, and specify the destination.

5

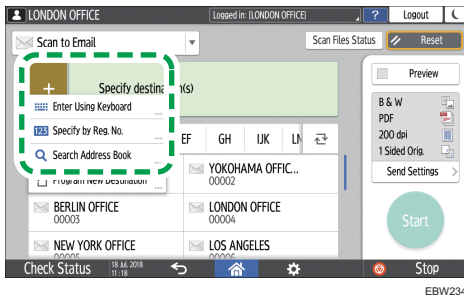

- Press **2** to specify the destination again or select [To], [Cc] or [Bcc].

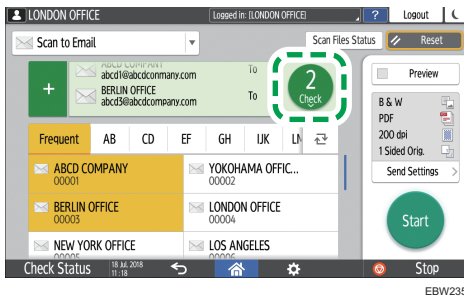

7. Specify the scan settings according to the purpose of the scanned data.

page 130 "Scanning an Original with Suitable Quality and Density"

page 132 "Specifying the File Type When Scanning a Document"

8. Press [Start].

Registering the E-mail Destination Specified When Sending an E-mail in the Address Book

When specifying an e-mail address by entering it manually, you can register the e-mail address in the address book before sending an e-mail.

1. Press [Scanner] on the Home screen.

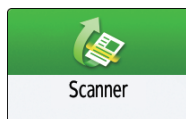

2. Select [Scan to Email] on the scanner screen.

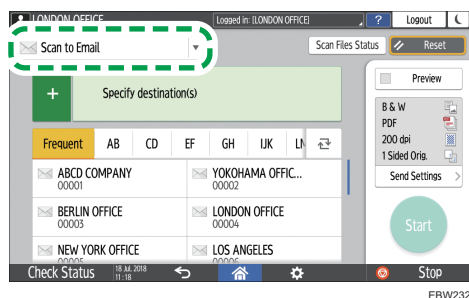

3. Place the original on the scanner.

See "Placing an Original to Scan", User Guide (Full Version).

4. Press [Send Settings] on the scanner screen and configure the scan settings according to the purpose of the scanned data.

page 130 "Scanning an Original with Suitable Quality and Density"

page 132 "Specifying the File Type When Scanning a Document"

5. Press **+** and then select [Enter Using Keyboard].

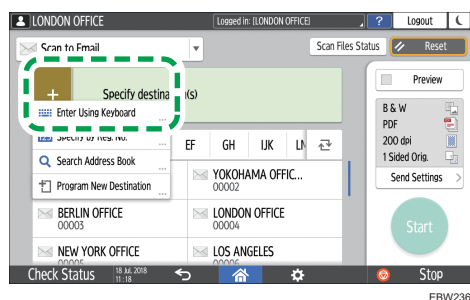

6. Enter the e-mail address, and press **1**.

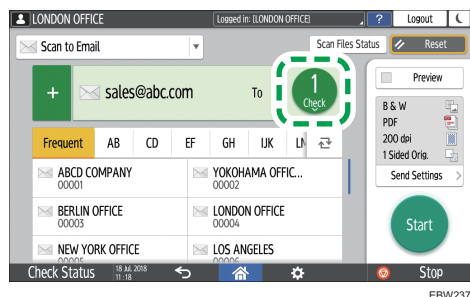

7. Specify the e-mail address that was entered manually and press [Reg. to Add. Book].

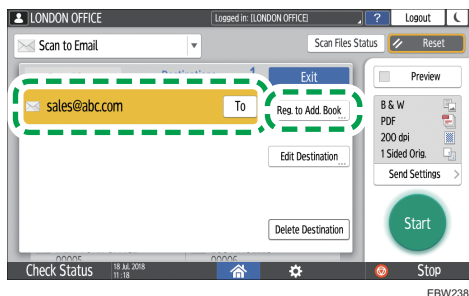

8. Enter the name and other additional information.
9. Press [OK] to close the address book screen after registering the information.
10. Press [Start] on the scanner screen.

Scanning Documents and Sending the Scanned Data to a Folder

To send the data of a scanned original to a shared folder on a computer, create the shared folder on the computer in advance and register the destination folder in the address book.

- You also need to configure the settings for connecting to the network from the machine.
See "Connecting to a Wired LAN" and "Connecting to a Wireless LAN", User Guide (Full Version).
- You can add a folder destination in the address book easily using Scan to Folder Helper.
See "Specifying the Destination of Send to Folder Using the Scan to Folder Helper App", User Guide (Full Version).

Note

- Using the SMB 3.0 protocol, you can save a file in the folder that was configured individually to apply encryption.

Printing the Check Sheet

Print the check sheet below to make a note of the setting values regarding the destination computer.

Check sheet		
No.	Items to check (example of the setting values)	Setting entry column
[1]	Computer name	
	DHCP server enable/disable setting	
	IP address	
[2]	Domain name/workgroup name	USERDNSDOMAIN: USERDOMAIN:
	Computer login user name	
[3]	Computer login password	

5. Check the domain name, workgroup name and login user name, and write down the information in [2] on the check sheet.

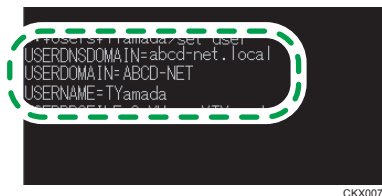

CKX007

When the screen shown above is displayed, fill in the sheet as follow:

[2]	Domain name/workgroup name	USERDNSDOMAIN [abcd-net.local] USERDOMAIN [ABCD-NET]
	Computer login user name	TYamada

DZC524

"USERDNSDOMAIN" is not displayed when the login user who executed the command is a local user.

6. Check the login password on the computer, and write down the information in [3] on the check sheet.

The required information on the computer is confirmed. Now create a shared folder on your computer and specify the access permissions of the folder.

Creating a Shared Folder (Windows)

Create a shared folder on the Windows Desktop and specify the access permissions of the folder.

1. Log on to Windows as a user with administrative privileges.
2. Create a new folder in Windows Explorer and write down the folder name in [4] on the check sheet.
3. Right-click the created folder, and then click [Properties].

4. On the [Sharing] tab, click [Advanced Sharing].

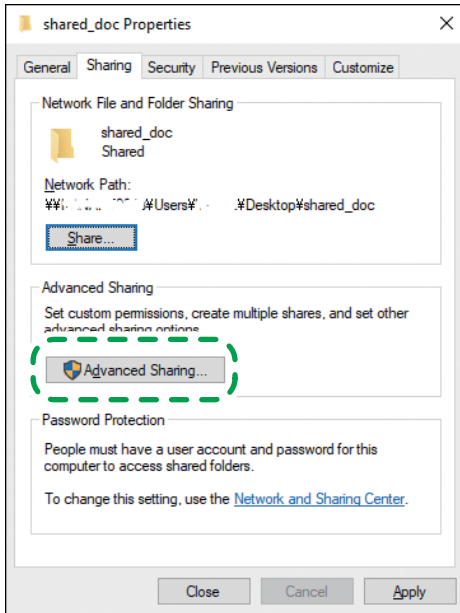

DZC318

5. Select the [Share this folder] check box, and then click [Permissions].

After completing the procedure, remove Everyone (unspecified user), and then add a user allowed access the folder. The user whose information is written down on the check sheet is used in the example shown below.

6. Select [Everyone] under [Group or user names], and then click [Remove].

7. Click [Add] ► [Advanced] ► [Object Types].

8. Select [Users], and then click [OK].

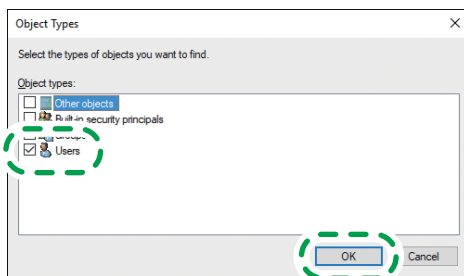

DZC319

9. Click [Locations], select the name of the domain or work group the user belongs to ([2] on the check sheet) and then click [OK].

10. Click [Advanced] ► [Find Now].

- From the Search Results, select the login user name of the computer to be added ([2] on the check sheet) and then click [OK].

When you cannot find a specific user, click [Columns], or right-click the [Search results] field, select [Select Column], and then select [Logon Name] from the [Available columns] list or [Pre-Windows 2000 Logon Name].

- Click [OK].
- Select the added user, and then select the [Allow] check box under [Permissions].

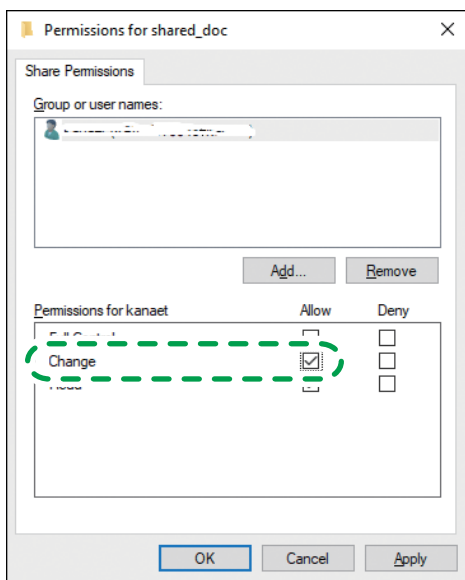

DZC320

- Click [OK] to close all windows.

The access permissions on the folder have been successfully configured. If you want to specify access permissions for the folder to allow other users or groups to access the folder, configure the folder as follows:

- Right-click the created folder and then click [Properties].
- Click [Edit...] on the [Security] tab.
- Click [Add] ► [Advanced].
- Select [Object Types] or [Locations] and click [Search].
- Select the user or group to assign permissions and click [OK].
- Click [OK].
- Select the added user, and then select the [Allow] check box under [Permissions].
- Click [OK] to close all windows.

Confirming the Computer Information (OS X/macOS)

Confirm the name of the computer used to create the shared folder, login user name and other settings and write down the information on the check list.

1. Log on to OS X/macOS as a user with administrative privileges.
2. Click the Apple menu.
3. Click [System Report].
4. Click [Software] on the left pane and write down the displayed computer name in [1] and the user name in [2] on the check sheet.

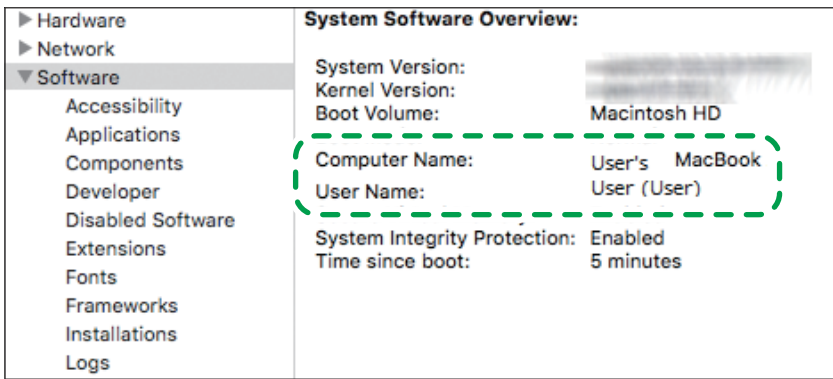

DZC525

When the screen shown above is displayed, fill in the sheet as follow:

[1]	Computer name	User's MacBook
[2]	Computer login user name	User

DZC526

5. Click the Apple menu and select [System Preferences].
6. In [Network], click [Ethernet] or [Wi-Fi] and write down the displayed IP address in [1] on the check sheet.

The required information on the computer is configured. Now create a shared folder.

Creating a Shared Folder (OS X/macOS)

Create a shared folder and specify the access permissions of the folder.

1. Create a new folder and write down the folder name in [4] on the check sheet.
2. Click the Apple menu and select [System Preferences].

3. Click [Sharing], select the [File Sharing] check box and then click [Options].

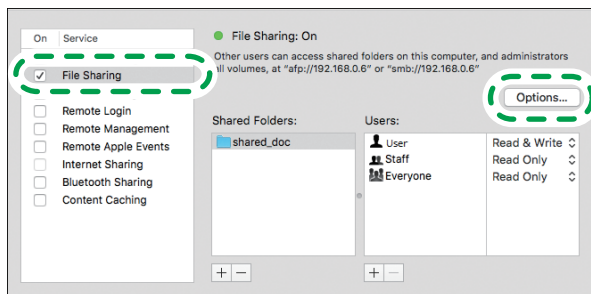

DZC527

4. Select the check boxes of [Share files and folders using SMB] and the user account to use for file sharing and then click [Done].

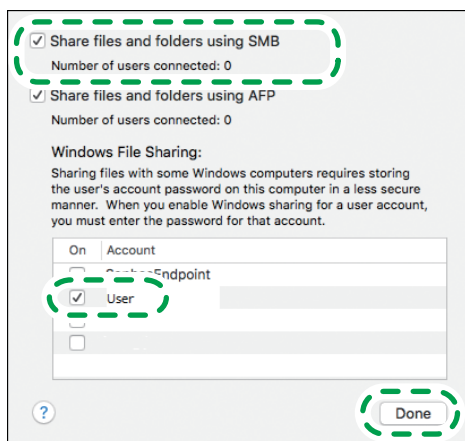

DZC528

When the [Authentication] screen is displayed, enter the password of the selected account and then click [Done].

5. Click [+] below [Shared Folders] on the [Sharing] screen.

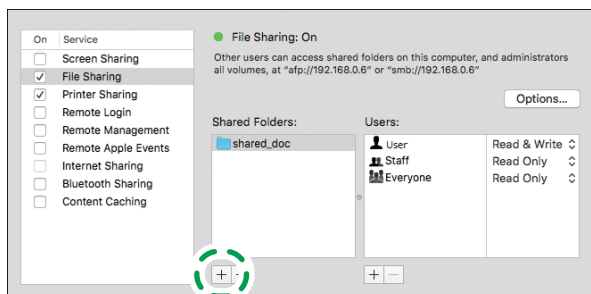

DZC529

6. Specify the folder created in Step 1 and click [Add].

7. Select the folder added in Step 6 and confirm that the permission of the user to access the folder is set to "Read & Write".

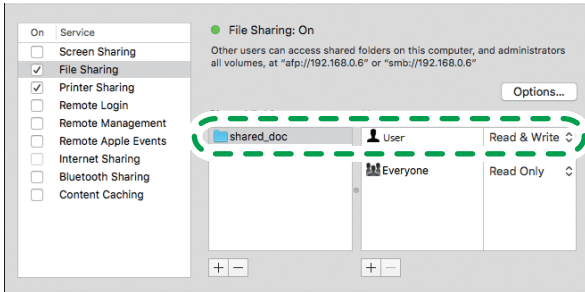

DZC530

Registering the Created Shared Folder in the Address Book

5

This section describes the procedure for registering a shared folder created in Windows using the information on the check sheet as an example.

1. Press [Address Book] on the Home screen.

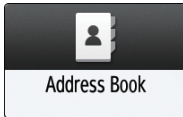

2. Press [Register] on the address book screen.

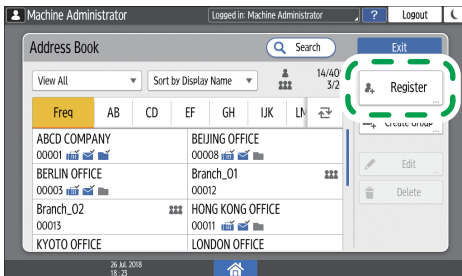

EBW239

3. Enter the information of the destination in the input boxes displayed on the [Name] tab, and select the title to classify the destination.

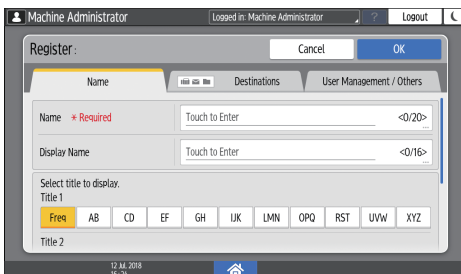

4. Press the [Destinations] tab, and then press [Folder].

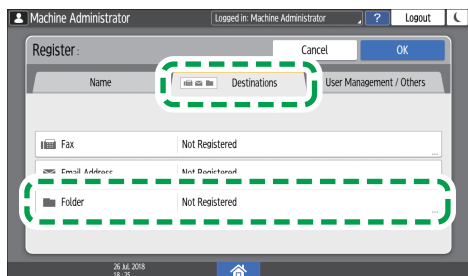

EBW294

5. Specify the network path to the shared folder in "Path".

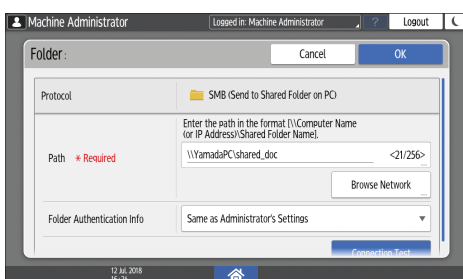

5

Entering the path name manually

If the computer name is "YamadaPC" ([1] on the check sheet) and the shared folder name is "shared_doc" ([4]), enter as follows:

```
\\YamadaPC\shared_doc
```

Selecting a folder from the list

Enter the IP address or host name of the computer on which to search for a shared folder, press [Browse Network], and then select the destination folder.

6. Under [Folder Authentication Info], select [Specify Other Authentication Information] and then enter the name and password of the login user who will access the shared folder.

7. Press Connection Test.

When no connection is established, check the message that appears.

page 195 "When a Message Is Displayed While Using the Scanner Function"

8. Press [OK].

9. Press the [User Management / Others] tab and specify the settings as required.

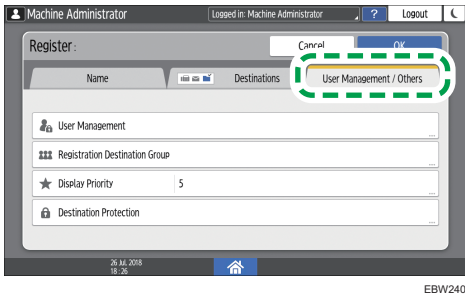

10. Press [OK].

11. Press [Home] (🏠) after specifying the settings.

Basic Procedure for Performing Send to Folder

1. Press [Scanner] on the Home screen.

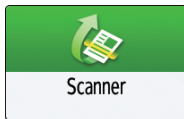

2. Select [To Folder] on the scanner screen.

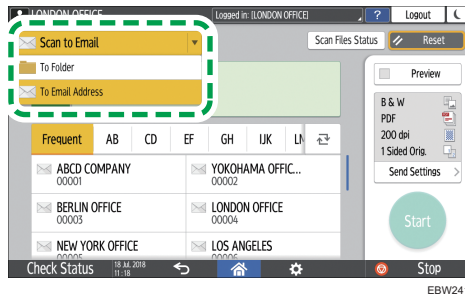

3. Place the original on the scanner.

See "Placing an Original to Scan", User Guide (Full Version).

4. Press [Send Settings] and configure the scan settings according to the purpose of the scanned data.

page 130 "Scanning an Original with Suitable Quality and Density"

page 132 "Specifying the File Type When Scanning a Document"

5. Press **+**, select **[Search Address Book]** or **[Specify by Reg. No.]** and then specify the shared folder that is registered in the address book.

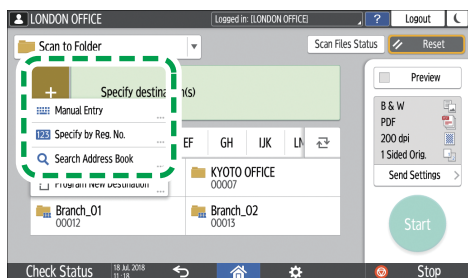

EBW242

- To enter the information manually, press **+**, and select **[Manual Entry]**. Enter the required information.
- To specify the destination again, press **2**.

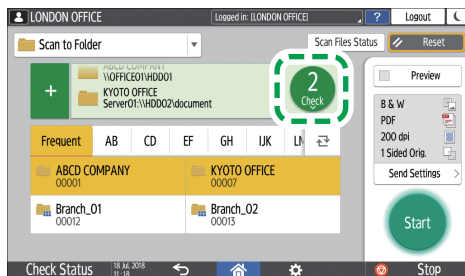

EBW243

6. Press **[Start]**.

Scanning an Original with Suitable Quality and Density

Specify the quality and density to scan on the [Send Settings] screen.

1. Press [Scanner] on the Home screen.

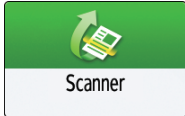

2. Place the original on the scanner.

See "Placing an Original to Scan", User Guide (Full Version).

3. Press [Send Settings] on the scanner screen and specify the original type (quality), density and resolution.

When specifying the original type



Original Type	Appropriate for
Black & White: Text	A document mainly composed of text in black and white. The original is scanned in two tones of black and white.
Black & White: Text/ Photo	A document with text and photos in black and white. The original is scanned in two tones of black and white.
Black & White: Photo	A document with figures and photos in black and white. The original is scanned in two tones of black and white.
Gray Scale	A document with figures and photos in black and white. The original is scanned as an image comprising many shades of gray.
Full Color: Text/Photo	A document mainly comprising text in color.
Full Color: Glossy Photo	An original in color such as silver-halide prints or pictures.

When adjusting the density

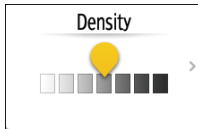

- Move  to the left or right to adjust the density. The colors in the scanned image darken as you move the slider to the right.
- Select the [Auto Density] check box to adjust the density automatically when scanning an original with a non-white background such as newspaper or a document that has show-through.
- You can specify the shading level of [Auto Density] in [Scanner Settings] ► [Scan Settings] ► [Background Density of ADS (Full Color)].
- See "Scan Settings (Scanner Settings)", User Guide (Full Version).

When specifying the resolution



Select the resolution to use for scanning the original. Image quality improves as the resolution increases, but the size of the scanned data also increases.

4. To send the scanned document to an e-mail address, press [Sender] and then specify the sender.
5. Specify the destination, and press [Start].

Specifying the File Type When Scanning a Document

Specify the settings in [Send Settings] on the scanner screen.

1. Press [Scanner] on the Home screen.

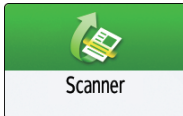

2. Place the original on the scanner.

See "Placing an Original to Scan", User Guide (Full Version).

3. Press [Send Settings] on the scanner screen.

4. Press [File Type], and select the file type to save the scanned document.

Press [Others] to display the detailed settings screen.

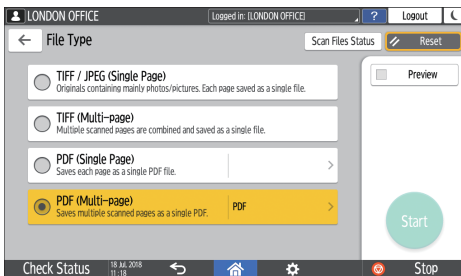

- TIFF/JPEG (Single Page): A separate image file is created for each single page.
 - When you specify Black & White in [Original Type], the scanned document will be sent in TIFF format.
 - When you specify Gray Scale or Full Color in [Original Type], the scanned document will be sent in JPEG format.
- TIFF (Multi-page): Multiple pages are combined into a single image file.
- PDF (Single Page): A PDF file is created for each single page.
- PDF (Multi-page): Multiple pages are combined into a single PDF file.

In addition to the normal PDF format, you can also specify [PDF/A] which conforms to the international standard and is suitable for long-term storage.

5. Specify the scan settings according to the purpose of the scanned data.

page 130 "Scanning an Original with Suitable Quality and Density"

6. Specify the destination to send the scanned document and then press [Start].

 **Note**

- You can also embed the security settings in the PDF file.
- See "Scanning an Original as a PDF with Security Setting Specified", User Guide (Full Version).

6. Web Image Monitor

Using Web Image Monitor

Web Image Monitor is a screen to confirm the machine status and settings on the computer.

When the machine and a computer can be connected to a network, you can access to Web Image Monitor by entering the IP address of the machine on the address bar of the Web browser.

Accessing to Web Image Monitor

1. Enter the IP address of the machine in the address bar of the Web browser.

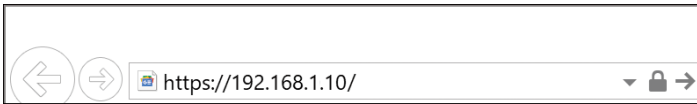

Example: when the IP address of the machine is "192.168.1.10"

- If SSL is specified
https://192.168.1.10/
- If SSL is not specified
http://192.168.1.10/

When you do not know whether SSL is specified on the machine, enter the address starting with https. When you fail the connection, enter the address starting with http.

When entering the IPv4 address, do not enter "0" for each segment. If "192.168.001.010" is entered, you cannot access the machine.

2. Confirming the machine status or settings on the top page of Web Image Monitor.

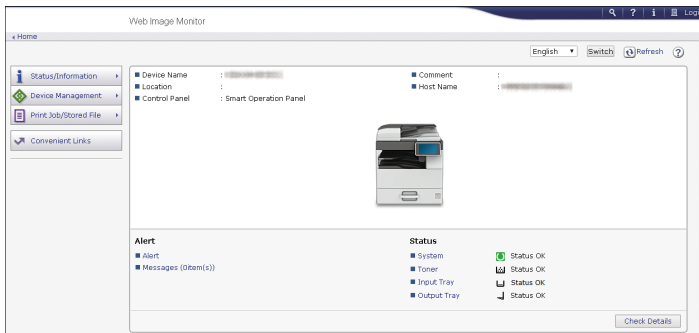

The machine status and remaining amount of consumables are displayed.

To change the settings, click [Login] at the top right on the screen and enter the User Name and Password.

Recommended Web Browser

Windows	OS X/macOS
Internet Explorer 11 or later	Safari 3.0 or later
Firefox 10, 15 or later	Firefox 10, 15 or later
Google Chrome version 19 or later	Google Chrome version 19 or later
Microsoft Edge 20 or later	-

- You can use the screen reader software JAWS 7.0 or later on Internet Explorer.

↓ Note

- When you use a DNS server or WINS server, you can use Host Name instead of IP address to connect the server.
- When the screen is distorted or the operation is unstable, confirm that "JavaScript" or "Use Cookies" is specified to Active on the computer.
- When using Host Name under Windows Server 2008 or later in the IPv6 environment, resolve Host Name in the external DNS server. You cannot use the host file.
- When specifying the settings from Web Image Monitor, do not log in to the machine from the control panel. The setting value may not be reflected.

What You Can Do on the Web Image Monitor

Items displayed on the Web Image Monitor and settings depend whether the machine is logged in.

- When not logged in

The machine status, settings, and job status are displayed. You can browse the settings of the machine but cannot change them.
- When logged in (as a user)

Log in as a user registered in the Address Book. The users can operate the jobs that they executed and change a part of settings of the machine.
- When logged in (as an Administrator)

The administrator can change all settings of the machine.

What you can do

Function	Not logged in	User	Administrator
Machine status	✓	✓	✓

Function	Not logged in	User	Administrator
Machine settings	✓*1	✓*1	✓
Machine setting change	-	✓*1	✓
Job list	✓	✓	✓
Job history	✓	✓	✓
Access to Address Book	-	✓	✓
Network settings	-	✓*1	✓
Network settings change	-	✓*1	✓
Cancel printing	-	-	✓
Security settings	-	-	✓

✓: Available -: Not available

*1 Depending on the Administrator settings

Web Image Monitor Screen

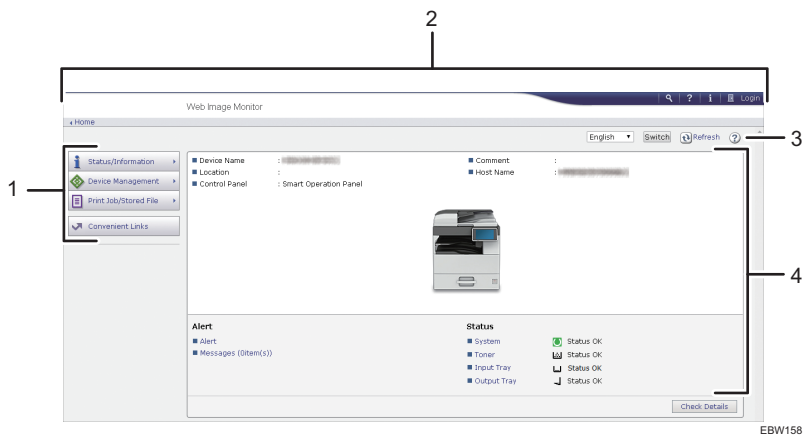

1. Menu

Menu items described below are displayed.

- Status/Information: Displays the machine status, option configuration, counter, and job status.
- Device Management: Manages the machine settings and Address Book.
- Print Job/Stored File: Operates the files stored in the printer driver.
- Convenient Links: Displays the link to the Favorite URL.

2. Header

An icon to link to the Login screen is placed at the top right on the screen. The Help, Version Information, and Keyword Search buttons are also displayed.

3. Refresh/Help

 (Refresh): Update the information in the work area.

 (Help): View or download Help file contents.

4. Main Area

The machine status and settings are displayed.



Specifying Web Image Monitor Help



Web Image Monitor has Help to describe the function of setting items. When you use Help for the first time, you can select to read online Help or to download Help file.



View Online Help Now

You can view the latest Web Image Monitor Help on the Internet.

Download Help File

You can download Web Image Monitor Help to the computer and view it. When you store the downloaded Help file in the Web server and assign to the Help button ( ), you can view the Help without connecting to the Internet.

To assign the downloaded Help file to the Help button ( ), specify the path to the Help file following the procedure below.

1. Log in to Web Image Monitor as an Administrator.
2. Click the Help button ( ) at the top right on the screen.

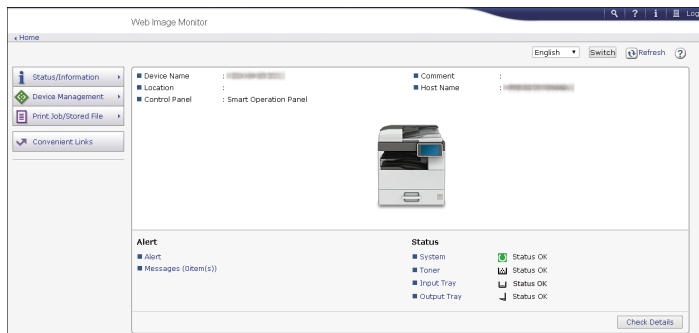

3. Select the operating system and displayed language, and then click [Download].
4. Unzip the downloaded zip file and store it in the Web server.
5. Click [Configuration] on the "Device Management" menu on Web Image Monitor.
6. Click [Webpage] under the "Webpage" category.

7. Enter the path to the Help file stored in the Web server in "URL" under "Set Help URL Target".

For example, when URL of the Help File is "http://a.b.c.d/HELP/EN/index.html", enter "http://a.b.c.d/HELP/".

8. Click [OK].

9. After completing the procedure, log out and finish Web Image Monitor.

7. Adding Paper and Toner

Loading Paper into the Paper Tray

The method of loading paper varies for each tray type.

⚠ CAUTION

- When loading paper, take care not to trap or injure your fingers.

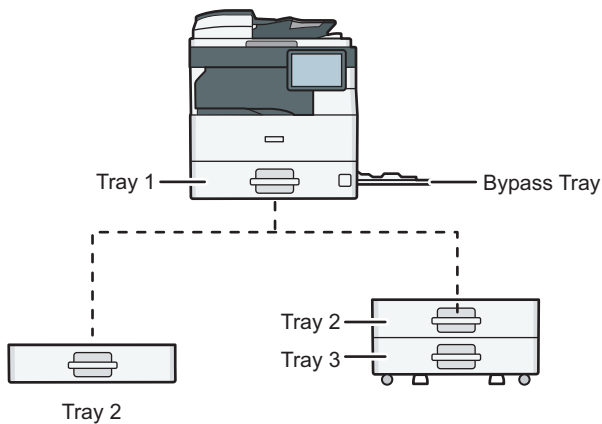

EBW153

- Before loading paper into a tray, check the paper size and type that can be loaded in the tray, and confirm the paper size that is automatically detected.
page 147 "Recommended Paper Sizes and Types"
- When loading paper of a size that is not automatically detected, specify the paper size in [Tray Paper Settings] of [Settings].
page 145 "Specifying the Paper Size That Is Not Automatically Detected"
- To load thin paper, thick paper or other special paper, specify the paper type or thickness in [Tray Paper Settings] of [Settings].
See "Tray Paper Settings", User Guide (Full Version).
- When loading paper on a tray which has a few sheets of paper, multiple sheets of paper may be fed at once from the tray. Take out all sheets, fan the sheets, and then load them again.
- You may hear the sound of rubbing paper. This is not a malfunction.

Loading Paper into Tray 1 to 3

Adjust the side and end fences according to the paper size.

★ Important

- Do not stack paper over the limit mark. If you load paper over the limit mark, the printed images may become slanted or a paper jam may occur.

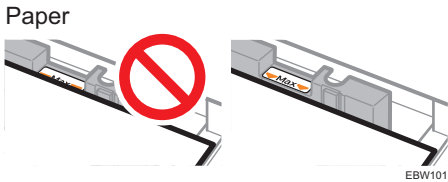

- Do not open an upper tray in a multi-level bank of trays while paper is being fed from a lower tray. Doing so will cause a paper jam.

Load paper into every tray in the same way. In the following example procedure, Tray 1 is used.

1. Pull the tray out carefully.

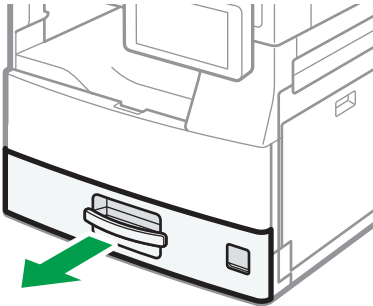

2. While pressing the release lever of the side fence, slide the side fences outward.

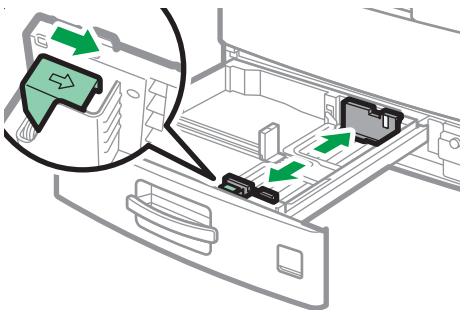

3. While pressing the release lever of the end fence, slide the end fence outward.

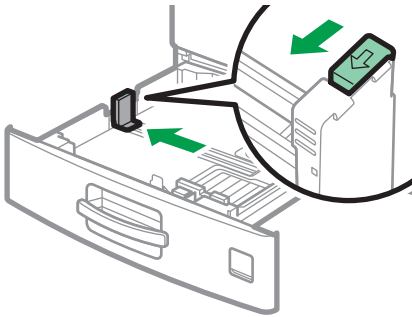

EBW103

4. Square the paper and load it with the print side facing up.

Fan sheets before loading so that multiple sheets of paper do not stick to each other and are not fed at once.

Do not stack paper over the limit mark.

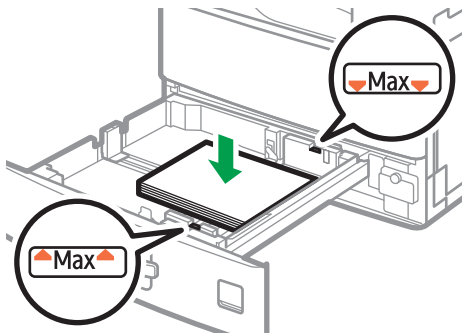

EBW749

5. While pressing the release lever, adjust the side and end fences to the paper size.

Do not leave spaces between the paper and fences.

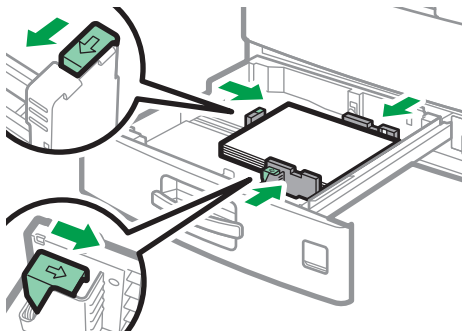

EBW750

6. Push the tray in the original position carefully.

To return the completely pulled out tray to the original position, push the tray straight in. If the paper tray is damaged, it may cause a paper jam. Also, if you push the tray forcibly, the side fence of the tray may be moved.

Loading Paper into the Bypass Tray

Use the bypass tray to load paper of a size that cannot be loaded into Tray 1 to 3, such as transparency film and label paper (adhesive labels).

The maximum number of sheets you can load into the bypass tray depends on the paper type.

page 147 "Recommended Paper Sizes and Types"

1. Open the bypass tray.

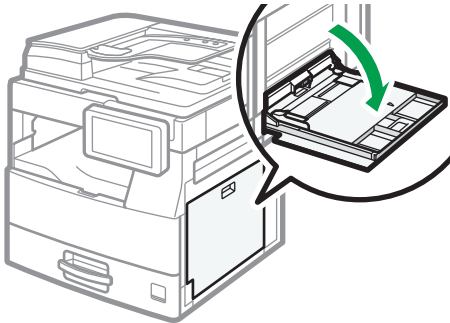

EBW009

When loading paper larger than the bypass tray (longer than A4 paper in landscape orientation), pull out the extender.

2. Load the paper with the print side down, and push it in lightly until you hear a beep.

Fan sheets before loading so that multiple sheets of paper do not stick to each other and are not fed at once.

When loading envelopes or letterhead paper, confirm the orientation, face and back, or location of flaps.

- page 158 "Envelope Orientation and Recommended Status"
- page 161 "Loading Orientation-fixed Paper or Two-sided Paper"

3. Align the paper guides to the paper size.

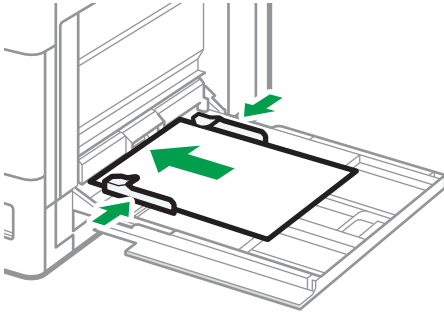

EBW104

Note

- To load paper on the bypass tray, it is better to orient it in the direction of .

Specifying the Paper Size That Is Not Automatically Detected

To load paper of a size that is not automatically detected into Tray 1 to 3, specify the paper size on the control panel.

1. On the Home screen, press [Settings].

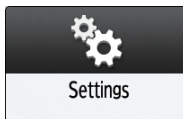

2. Press [Tray Paper Settings].

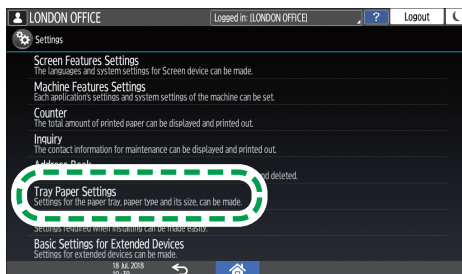

EBW695

3. Select the tray to which you loaded the paper: [Tray Paper Size: Tray 1] to [Tray Paper Size: Tray 3] or [Printer Bypass Paper Size].

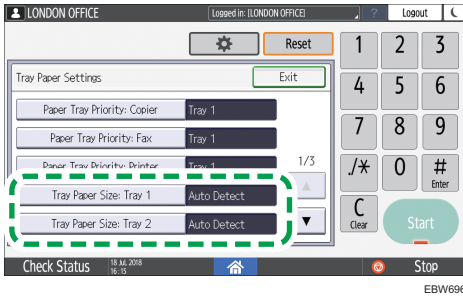

4. Select the size of the loaded paper.

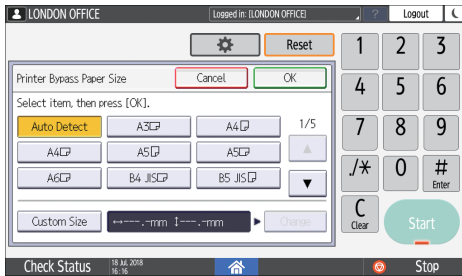

5. Press [OK].
6. After completing the configuration, press [Home] (Home icon).

Note

- To use paper that can be detected automatically after using paper that cannot be detected automatically, restore the setting of Auto Detect. To restore the setting of Auto Detect, load the paper again, operate steps 1 to 3, select [Auto Detect], and then press [OK].

Recommended Paper Sizes and Types

The recommended paper sizes and types for each tray are as described below.

↓ Note

- When performing multiple sheet feeding, fan sheets thoroughly or load sheets one by one from the bypass tray.
- When you load the following types of paper, you may hear a buzzing sound. This does not affect the performance.
 - Transparency film
 - Translucent paper
 - Postcards

Tray 1

Type	Size	Weight	Capacity
Thin Paper	Paper sizes that can be detected automatically: A3, A4, B4 JIS, B5 JIS, 8 1/2 × 11	52 to 105 g/m ² (14 to 28 lb.)	500 (80 g/m ² , 20 lb.)
Plain Paper 1			
Plain Paper 2			
Middle Thick Paper			
Recycled Paper			
Color Paper			
Special Paper			
Prepunched Paper			
Letterhead			
Bond Paper			
Cardstock			

Type	Size	Weight	Capacity
Thin Paper Plain Paper 1 Plain Paper 2 Middle Thick Paper Recycled Paper Color Paper Special Paper Prepunched Paper Letterhead Bond Paper Cardstock	Select the paper size using the Tray Paper Settings menu: A5, 11 × 17, 8 1/2 × 14, 8 1/2 × 13 2/5, 8 1/2 × 13, 8 1/2 × 11, 8 1/4 × 14, 8 1/4 × 13, 8 × 13, 8 × 10 1/2, 8 × 10, 7 1/4 × 10 1/2, 5 1/2 × 8 1/2, 8K, 16K, 11 × 15, 11 × 14, 10 × 15, 10 × 14	52 to 105 g/m ² (14 to 28 lb.)	500 (80 g/m ² , 20 lb.)
Thin Paper Plain Paper 1 Plain Paper 2 Middle Thick Paper Recycled Paper Color Paper Special Paper Prepunched Paper Letterhead Bond Paper Cardstock	Custom size *1: 139.7 to 297.0 mm in width, 148.0 to 432.0 mm in length (5.50 to 11.69 inches in width, 5.83 to 17.00 inches in length)	52 to 105 g/m ² (14 to 28 lb.)	500 (80 g/m ² , 20 lb.)

*1 When loading paper with a horizontal width of more than 279 mm (10.99 inches) in Tray 1, use paper that has a vertical length of 420 mm (16.53 inches) or less.

Lower Paper Trays (Trays 2, 3)

Type	Size	Weight	Capacity
Plain Paper 1 Plain Paper 2 Middle Thick Paper Recycled Paper Color Paper Special Paper Prepunched Paper Letterhead Bond Paper Cardstock	Paper sizes that can be detected automatically: A3, A4, B4 JIS, B5 JIS, 8 1/2 × 11	60 to 105 g/m ² (16 to 28 lb.)	500 (80 g/m ² , 20 lb.)
Plain Paper 1 Plain Paper 2 Middle Thick Paper Recycled Paper Color Paper Special Paper Prepunched Paper Letterhead Bond Paper Cardstock	Select the paper size using the Tray Paper Settings menu: A5, 11 × 17, 8 1/2 × 14 8 1/2 × 13 2/5, 8 1/2 × 13 8 1/2 × 11, 8 1/4 × 14 8 1/4 × 13, 8 × 13, 8 × 10 1/2, 8 × 10, 7 1/4 × 10 1/2, 5 1/2 × 8 1/2 8K, 16K, 11 × 15, 11 × 14, 10 × 15, 10 × 14	60 to 105 g/m ² (16 to 28 lb.)	500 (80 g/m ² , 20 lb.)

Type	Size	Weight	Capacity
Plain Paper 1	Custom size ^{* 1} :	60 to 105 g/m ²	500
Plain Paper 2	98 to 297.0 mm in width,	(16 to 28 lb.)	(80 g/m ² , 20 lb.)
Middle Thick Paper	192.0 to 432.0 mm in length		
Recycled Paper	(3.86 to 11.69 inches in width,		
Color Paper	7.56 to 17.00 inches in length)		
Special Paper			
Prepunched Paper			
Letterhead			
Bond Paper			
Cardstock			

* 1 When loading paper with a horizontal width of more than 279 mm (10.99 inches) in Trays 2–3, use paper that has a vertical length of 420 mm (16.53 inches) or less.

Bypass tray

Type	Size	Weight	Capacity
Thin Paper Plain Paper 1 Plain Paper 2 Middle Thick Paper Thick Paper 1 Thick Paper 2 Recycled Paper Color Paper Special Paper Prepunched Paper Letterhead Label Paper Bond Paper Cardstock OHP Envelope	Paper sizes that can be detected automatically: A3, A4, A5, B4 JIS, B5 JIS, B6 JIS	52 to 216 g/m ² (14 to 58 lb.)	100 (80 g/m ² , 20 lb.)

Type	Size	Weight	Capacity
Thin Paper	Select the paper size using the Tray Paper Settings menu: A6, 11 × 17, 8 1/2 × 14, 8 1/2 × 13 2/5, 8 1/2 × 13, 8 1/2 × 11, 8 1/4 × 14, 8 1/4 × 13, 8 × 13, 8 × 10 1/2, 8 × 10, 7 1/4 × 10 1/2, 5 1/2 × 8 1/2, 4 1/8 × 9 1/2, 3 7/8 × 7 1/2, C5 Env, C6 Env, DL Env, 8K, 16K, 12 × 18, 11 × 15, 11 × 14, 10 × 15, 10 × 14	52 to 216 g/m ² (14 to 58 lb.)	100 (80 g/m ² , 20 lb.)
Plain Paper 1			
Plain Paper 2			
Middle Thick Paper			
Thick Paper 1			
Thick Paper 2			
Recycled Paper			
Color Paper			
Special Paper			
Prepunched Paper			
Letterhead			
Label Paper			
Bond Paper			
Cardstock			
OHP			
Envelope			

Type	Size	Weight	Capacity
Thin Paper	Custom size:	52 to 216 g/m ²	100
Plain Paper 1	90 to 305.0 mm in width,	(14 to 58 lb.)	(80 g/m ² , 20 lb.)
Plain Paper 2	148.0 to 600.0 mm in length		
Middle Thick Paper	(3.54 to 12.00 inches in width,		
Thick Paper 1	5.83 to 23.62 inches in length)		
Thick Paper 2			
Recycled Paper			
Color Paper			
Special Paper			
Prepunched Paper			
Letterhead			
Label Paper			
Bond Paper			
Cardstock			
OHP			
Envelope			

Notes on Special Paper

Paper Type	Note
Setting thick paper	page 157 "Thick Paper Orientation and Recommended Status"
Setting envelopes	page 158 "Envelope Orientation and Recommended Status"
Setting letterhead paper	page 161 "Loading Orientation-fixed Paper or Two-sided Paper"
Setting label paper (adhesive labels)	We recommend that you use specified label paper. If paper other than the specified one is used, normal operation and quality cannot be guaranteed.

Paper Type	Note
Setting transparencies	When using transparencies, check their print sides carefully. Erroneous loading may cause problems. Remove copied or printed sheets one by one.
Setting translucent paper	<ul style="list-style-type: none"> • When loading translucent paper, always use long grain paper. • Remove copied or printed sheets one by one.

Paper Thickness for Each Paper Weight

Paper Thickness	Paper weight
Thin Paper	52–59 g/m ² (14–15 lb. Bond)
Plain Paper 1	60–74 g/m ² (16–20 lb. Bond)
Plain Paper 2	75–81 g/m ² (20 lb. Bond)
Middle Thick	82–105 g/m ² (20–28 lb. Bond)
Thick Paper 1	106–162 g/m ² (28 lb. Bond–90 lb. Index)
Thick Paper 2	163–216 g/m ² (60–80 lb. Cover)

Unusable Paper

CAUTION

- Do not use stapled sheets of paper, aluminum foil, carbon paper, or any kind of conductive paper. Doing so can result in fire.

Paper causing faults

Do not use any of the following kinds of treated paper. Doing so may cause faults.

- Paper for inkjet printers
- Thermal paper
- Art paper
- Aluminum foil
- Carbon paper
- Conductive paper

- Paper with perforated lines
- Hemmed-edge paper
- Window envelopes
- Tab stock
- Certain types of OHP transparencies for color printing

Do not copy or print onto sides that are already printed.

Paper causing paper jam

Do not use the following kinds of paper. It may cause a paper jam.

- Bent, folded, or creased paper
- Perforated paper (Excluding Prepunched Paper)
- Slippery paper
- Torn paper
- Rough paper
- Thin paper with little stiffness
- Paper with a dusty surface

Do not use the copied or printed paper again. It may cause paper jam.

If you use paper curled by humidity or drying, the paper or staple may jam.

Do not load sheets that have already been printed onto by another machine. Doing so may interfere with loading of paper because the powder for preventing offset may attach to the paper roller.

Note

- A paper jam may occur depending on the condition of the paper even when using the recommended paper.

Paper Storage

When storing paper, the following precautions should always be followed:

- Do not store paper where it will be exposed to direct sunlight.
- Store paper in a dry environment (humidity: 70% or less).
- Store on a flat surface.
- Do not store paper vertically.
- Once opened, store paper in a plastic bag.

Saving Printouts



- Prints will fade if exposed to strong light or dampness and humidity for extended periods of time. Preserve the quality of your copies by storing them in a binder in a dark, dry place.
- When folding prints, toner in the folds will come off.
- If the prints are stored in the conditions described below, toner may melt:
 - When a print and a half-dried print are put on top of each other
 - When solvent-type adhesive agents are used for pasting prints
 - When prints are placed on mats made of chlorinated plastic in locations of high temperature for long periods of time
 - When prints are placed in locations of extremely high temperatures, such as near a heater

Thick Paper Orientation and Recommended Status

When using thick paper of 106–216 g/m² (28 lb. Bond–80 lb. Cover), keep in mind the paper orientation or storage environment to prevent misfeeds and loss of image quality.

Paper Orientation

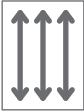
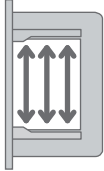
Thick paper has a paper direction according to its grain. Set the paper direction according to the grain, as shown in the following diagram:

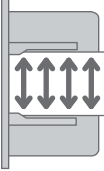
Direction of paper grain	Bypass Tray
	
	

Paper Storage

- Temperature: 20–25°C (68–77°F)
- Humidity: 30–65%.

Do not use together paper that has been stored in different environments.

Note

- After loading paper, position the side fences flush against the paper stack.
- When printing on thick, smooth paper, be sure to fan the paper thoroughly before loading. If you do not fan thick paper, jams and misfeeds can occur. If paper continues to become jammed or feed in together even after they are fanned, load them one by one from the bypass tray.
- Proper performance and quality may not be achieved under the recommended conditions depending on the paper.
- The printed sheet may curl. If the printed sheet curls, correct it.

Envelope Orientation and Recommended Status

The way to place an original on the exposure glass and load envelopes varies depending on the shape and orientation of the envelopes.

★ Important

- Do not print on the following envelopes:
 - Window envelopes
 - Envelopes with moisture

Before setting envelopes

- Before loading envelopes, press down on them to remove any air from inside and flatten out all four edges. If they are bent or curled, flatten their leading edges (the edge going into the machine) by running a pencil or ruler across them.

↓ Note

- For information about recommended envelopes, contact your local dealer.
- The Duplex function cannot be used with envelopes.
- Copied or printed sheets are delivered to the internal tray 1 even if you specified a different tray.
- An image may not be printed clearly on a sheet whose thickness is uneven. Print a few sheets and check the result.
- The printing result may not be adequate or the envelope may become wrinkled when the temperature or humidity is high.
- The printing result may not be adequate or output envelopes may become wrinkled depending on the printing environment even when using the recommended envelopes.
- When printing onto paper other than an envelope after printing onto several envelopes, you may have to wait about one minute until printing starts to allow the machine to make adjustments.

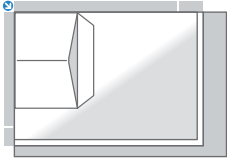
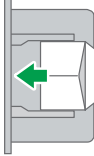
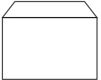
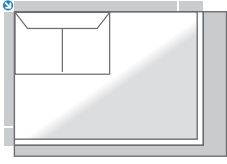
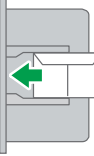

Using the Copy Function

Orientation of Envelopes	Exposure Glass	Bypass Tray
Side-opening envelopes 	 Flaps: open Side to be scanned: face down	 Flaps: open Side to be printed: face down
Side-opening envelopes 	 Flaps: closed Side to be scanned: face down	 Flaps: closed Side to be printed: face down

When loading envelopes, specify the envelope size and thickness.
 page 62 "Copying Onto Envelopes"

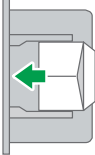
Using the Printer Function

Orientation of Envelopes	Bypass Tray
Side-opening envelopes 	 Flaps: open Side to be printed: face down

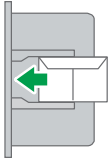
Orientation of Envelopes	Bypass Tray
<p data-bbox="262 309 536 344">Side-opening envelopes </p> 	 <p data-bbox="865 495 1002 525">Flaps: closed</p> <p data-bbox="780 540 1087 570">Side to be printed: face down</p>

Loading Orientation-fixed Paper or Two-sided Paper

To print onto letterhead paper or business letter paper on which logos or patterns are printed, confirm how to set the paper or the settings of this machine so that the original is printed onto the orientation-fixed (top to bottom) or two-sided paper correctly.

Copying onto Letterhead Paper

Specify the settings of this machine as described below, and then place an original and load the paper.

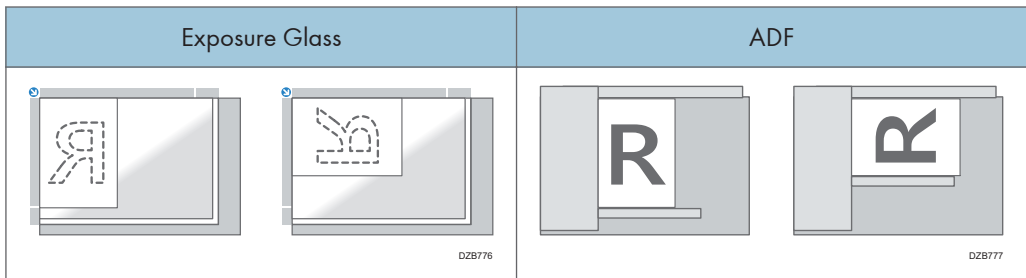

- [Copier Settings] ► [Input/Output] ► [Letterhead Setting] ► [On]

Original Orientation

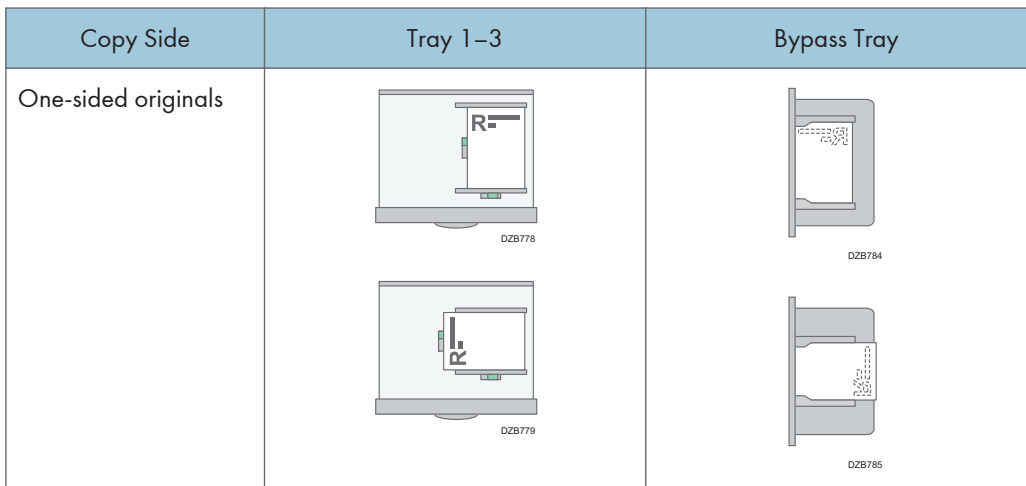

Paper Orientation

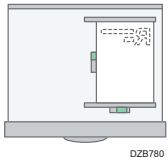
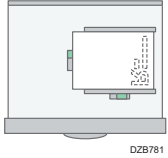

Copy Side	Tray 1-3	Bypass Tray
Two-sided originals * 1	 <p>DZB780</p>  <p>DZB781</p>	 <p>DZB786</p>  <p>DZB787</p>

* 1 When printing the first page onto the letterhead side

Printing onto Letterhead Paper Using the Printer Driver

Specify the settings of this machine as described below.

- [Printer Settings] ▶ [System] ▶ [Letterhead Setting] ▶ [Auto Detect]

Paper Orientation

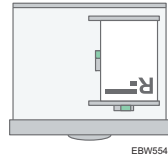
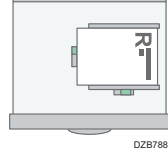
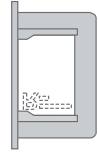
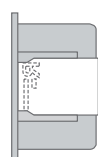
Copy Side	Tray 1-3	Bypass Tray
One-sided originals	 <p>EBW554</p>  <p>DZB788</p>	 <p>EBW555</p>  <p>DZB790</p>

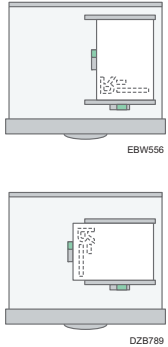
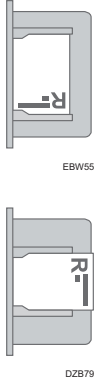
Copy Side	Tray 1-3	Bypass Tray
Two-sided originals	 <p>EBW556</p> <p>DZB789</p>	 <p>EBW557</p> <p>DZB791</p>

Note

- When you specify [Letterhead Setting] to [On (Always)], you can print onto letterhead paper without specifying the paper type in the printer driver's settings to [Letterhead].

Recommended Original Size and Weight

Original location		Original size	Original weight
Exposure glass		Up to A3	-
ADF	One-sided originals	A3–B6 JIS (Japanese Industrial Standard), 11 × 17–5 ¹ / ₂ × 8 ¹ / ₂ * ¹	40–128 g/m ² (11–34 lb. Bond)
	Two-sided originals	A3–A5, 11 × 17–5 ¹ / ₂ × 8 ¹ / ₂ * ¹	52–128 g/m ² (14–34 lb. Bond)
	Mixed Sizes mode	A3, B4 JIS, A4, B5 JIS, 11 × 17, 8 ¹ / ₂ × 13, 8 ¹ / ₂ × 11	52–81 g/m ² (14–20 lb. Bond)



*1 5¹/₂ × 8¹/₂ can be used only in the scanner function.

Note

- An original whose size is within the range of the maximum original scan area can be placed.
- page 217 "Specifications for the Main Unit"
- On all sides of the original, there is a missing image area. Even if you place originals on the exposure glass or in the ADF correctly, the missing image area on all four sides of the original might not be copied.
- page 217 "Specifications for the Main Unit"
- You can place originals of two different sizes only in Mixed Sizes mode.

Sizes Detectable with Auto Paper Select

Original location	A3 	B4 JIS 	A4 	B5 JIS 	A5 	A5 	B6 JIS 
Exposure glass	✓	✓	✓	✓	✓	-	-
ADF	✓	✓	✓	✓	✓	✓	✓*1

Original location	11 × 17 	8 1/2 × 11 
Exposure glass	-	-
ADF	✓	✓

✓: Detectable size, -: Undetectable size

*1 You cannot use the two-sided scanning mode.

Note

- If the original type is one of the following, the machine may not be able to detect the paper size automatically. Select the paper size manually.
 - Dark originals with a lot of text and drawings
 - Originals that partially contain a solid image
 - Originals that have solid images at their edges
 - Originals with indexes, tags, or other projecting parts
 - Transparent originals such as transparencies or translucent paper
 - Originals with glossy surfaces
 - Bound originals with a thickness of more than 10 mm (0.4 inches), such as books
- When the ADF scans an original of a size that cannot be detected automatically, the size of the scanned image will be different from the original.
- When loading an original of a size that is not automatically detected, specify the original size or select the paper tray that is the same size as the original. The output image may not be full size or it may be different from the intended one if the print settings are not specified properly.

Replacing the Toner

Toner is almost depleted when the "Check toner cartridge replacement(s)." message is displayed. Prepare a replacement print cartridge.

See "Contact Information", User Guide (Full Version).

See the video displayed on the control panel of the machine for the procedure to replace the toner.

★ Important

- Replace the toner after the message prompting replacement is displayed on the control panel.
- The machine may become damaged if you use toner of a different type.
- Do not turn off the power of the machine when replacing the toner. If you turn off the power when replenishing the toner, the specified settings are canceled, and printing will not resume afterwards.
- Store the toner in a dry environment away from direct sunlight and generally under the temperature below 35°C.
- Keep the toner horizontal when storing it.
- After removing the print cartridge from the machine, do not shake it while its opening is facing downward. The remaining toner may spill out.
- Do not pull out and put back the toner cartridge repeatedly. The remaining toner may leak.
- Follow the procedure displayed on the screen to replenish the toner.

1. Press [Watch Video].

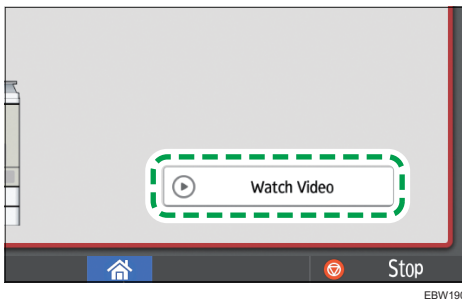

To display this screen again, press [Confirm] in the system message widget, or press [Check Status] and then press [Check] under "Mach. Status" on the [Mach./Applic. Stat] tab.

2. Press the play key.

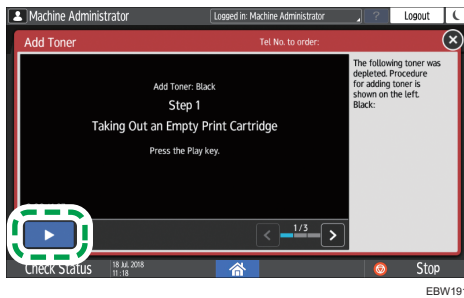

3. Replace the toner by following the procedure shown in the video.

Note

- You can transmit data in the fax or scanner function even after the toner runs out. However, you cannot transmit a fax when the number of times of reception and transmission performed in the fax function after the toner has run out and the number of times of communication not recorded in the Records exceeds a total of 200. Replace the toner earlier.
- While the message prompting you to replace the toner is displayed, Memory Storage Report for Memory Transmission will not be printed.

Precautions When Storing Toner

7

WARNING

- Do not store toner (new or used) or toner containers while toner is inside in a place with an open flame. The toner can ignite and result in burns or fire.

CAUTION

- Do not leave the following items in a place where children can reach them:
 - Toner (new or used)
 - Toner containers while toner is inside
 - Toner-attached parts

Precautions When Replacing the Toner

WARNING

- Do not dispose of the following items into a fire. Toner will ignite on contact with naked flame and burns can result.
 - Toner (new or used)
 - Toner containers while toner is inside
 - Toner-attached parts
-
- Do not absorb spilled toner (including used toner) using a vacuum cleaner. Absorbed toner may cause ignition or explosion due to electric contact sparks inside the vacuum cleaner. However, you can use a toner-compatible industrial vacuum cleaner. When toner is spilled, remove the spilled toner using a wet cloth so that the toner is not scattered.
-
- The following explains the warning messages on the plastic bag used in this product's packaging:
 - Do not leave the polythene materials (bags, etc.) supplied with this machine close to babies and small children. Suffocation can result if polythene materials are brought into contact with the mouth or nose.

7

CAUTION

- When removing jammed paper, replenishing or replacing toner (new or used), make sure not to inhale toner.
-
- When the following occurs while toner is handled, receive emergency measures first, and then consult a doctor if necessary.
 - When inhaling toner, gargle with a large amount of water and move into a fresh air environment.
 - When swallowing toner, dilute gastric contents with a large amount of water.
 - When getting toner into your eyes, flush them with a large amount of water.
-
- When removing jammed paper, replenishing or replacing toner (new or used), be careful not to have toner dirt your skin or clothes.

⚠ CAUTION

- If toner (new or used) comes into contact with your skin or clothes and smears them, take the following actions:
 - If toner comes into contact with your skin, wash the affected area thoroughly with soap and water.
 - If toner comes into contact with your clothes, wash the stained area with cold water. Heating the stained area by applying hot water will set the toner into the fabric and removing the stain may become impossible.
- When replacing a container with toner (including used toner) or consumables with toner, be careful that the toner does not splatter. After removing used consumables and shutting the lid of the container if the lid is available, put them in a bag.
- Do not open toner containers forcibly while toner is inside, crush or squeeze them. Toner spillage can cause accidental ingestion or dirtying of clothes, hands, or floor.

Disposing Exhausted Toners

You cannot reuse exhausted toners.

When disposing a depleted print cartridge, place the cartridge in a box or plastic bag while paying attention not to spill any toner powder.

If you want to discard your used toner container, please contact your local sales office. If you discard it by yourself, treat it as general plastic waste material.

Please see our local company website for information on the recycling of supply products, or you can recycle items according to the requirements of your local municipalities or private recyclers.

8. Troubleshooting

Alert Sounds

The machine notifies you with an alert sound when a paper jam occurs, the original is left on the machine, or another problem occurs. Listen to the alert sound for one of the patterns described below, and perform the required procedure accordingly.

Sound pattern *1	Condition	Solution
A short beep	[Notification Sound] (operation tone) [Login]/[Logout]	-
A short beep, followed by long beep	[Operation Invalid]	<ul style="list-style-type: none">• If you entered an incorrect password, enter the correct password.• If you hear this sound when touching an icon or key, you do not have permission to use the function or setting. Log in to the machine as a user with permission, or consult your user administrator.
A long beep	[Operation Completed] [Fax Printing Finished] [Fax Transmission Finished] [Fax Reception Finished]	Check the operation result.
Two long beeps	[Warm-up]	The machine is ready for use after the machine is turned on or recovers from the sleep mode.
Five long beeps (repeating four times)	[Sound of Less Urgent Level]	Check that an original is not left on the exposure glass and that paper is loaded in the paper tray.
Five short beeps (repeating five times)	[Sound of Urgent Level]	Check the message displayed on the screen, and resolve the problem by removing the jammed paper or original, or replacing the toner.

*1 The factory default sound pattern is used as an example in the table above.

Note

- You cannot pause an alert sound that has started. The machine continues to emit the sound until the preset sound pattern is completed.
- You can specify the volume and type of alert sound in [Settings] ► [Screen Features Settings] ► [Sound]. The type of sound can be specified for each condition described in the table above. You can also specify the volume of the sound emitted when using On-hook or Immediate Transmission to send a fax in [Settings] ► [Machine Features Settings] ► [Fax Settings] ► [General Settings] ► [Adjust Sound Volume]. Press [Home] (🏠) after specifying the settings.
- See "Setting the Sound Volume and Type", User Guide (Full Version).

Checking the Messages, Icons, and Indicators on the Control Panel

The machine notifies you of the machine condition or status of an application with the [Check Status] indicator or a message displayed on the control panel. Check the status and resolve the problem accordingly.

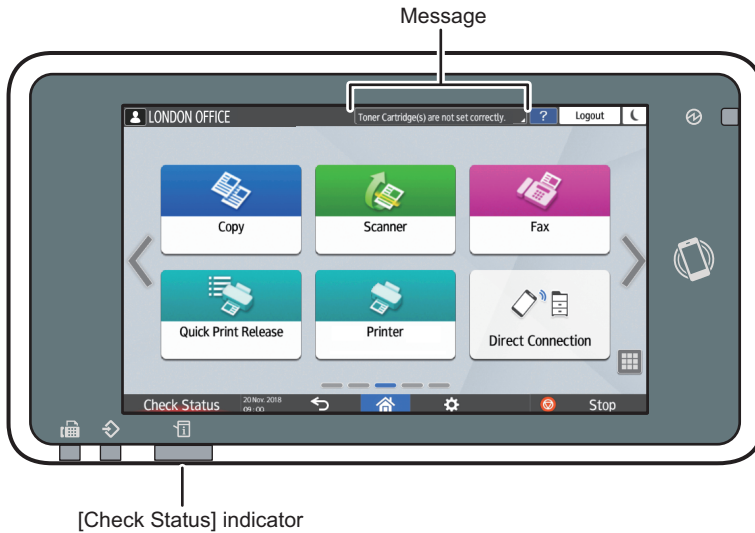





EBW601

- Message
 - Displays a message indicating the status of the machine or application. Press the message to display it in full text. You can also view more than one message as a list.
- [Check Status] indicator
 - If there is a problem such as a paper jam, the [Check Status] indicator lights up or flashes along with a message displayed on the screen. Press [Check Status] to check the status of the machine or application, and resolve the problem accordingly.

When an Icon is Displayed with a Message

When you need to resolve a problem such as a paper jam, an icon is displayed at the beginning of a message. See the table below for the meaning of each icon.

Icon	Condition	Solution and reference
	Maintenance or repair is required.	Prepare for maintenance or consider repairing the machine.

Icon	Condition	Solution and reference
	Paper is jammed.	See the animated illustration displayed on the control panel, and remove the jammed paper. See "When Paper or an Original Is Jammed", User Guide (Full Version).
	An original has jammed.	See the animated illustration displayed on the control panel, and remove the jammed original. See "When Paper or an Original Is Jammed", User Guide (Full Version).
	Paper has run out.	Load paper into the paper tray. page 141 "Loading Paper into the Paper Tray"
	Toner is almost depleted, or has run out.	Prepare a replacement toner. Replace the toner when it runs out. page 166 "Replacing the Toner"
	A cover is open.	Check that all covers of the machine and options are closed.

Note

- For the names and the contact information of consumables, check [Settings] ► [Inquiry]. Press [Home] () after completing the operation to close [Settings].
- See "Contact Information", User Guide (Full Version).

When the [Check Status] Indicator is Lit or Flashing

The [Check Status] indicator notifies the user when the machine requires immediate attention.

Flashing in red

The machine is unavailable for use. Press [Check Status] and resolve the problem as soon as possible.

Flashing in yellow

Maintenance on the machine needs to be performed soon. Perform the required procedure accordingly.

You can display the status confirmation screen with [Check Status]. On the screen, check the detailed status of the machine or application.

1. Press [Check Status].

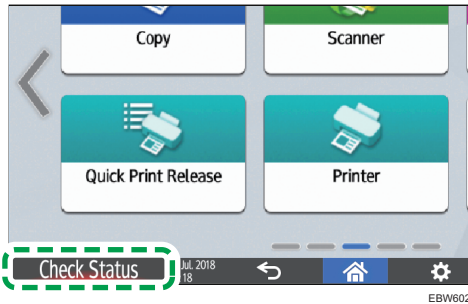

2. Press [Check] to check the details, and perform the required procedure.

See "When an Icon is Displayed with a Message" for details.

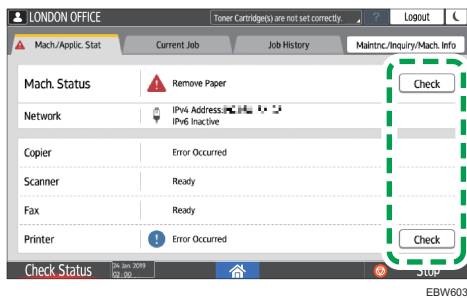

⚠: The machine cannot be used.

!: Some of the functions cannot be used, or the toner is almost depleted.

Note

- Depending on the machine condition, such as a paper jam or open cover, the status confirmation screen may be displayed automatically without pressing [Check Status].

When the Machine Cannot Be Operated

↓ Note

- If a message is displayed on the screen, check the message.
- page 181 "When a Message Is Displayed and the Machine Cannot Be Operated"
- When confirming or changing the settings in [Settings], press [Home] (🏠) after completing the operation to close [Settings].

When the Machine Does Not Respond Correctly to an Operation on the Control Panel

Condition	Cause	Solution and reference
The screen of the control panel is not lit.	The machine is in the sleep mode.	Touch the screen.
Nothing is displayed when you touch the screen.	The power of the machine is turned off.	Check that the main power indicator is not lit, and then turn on the main power of the machine. page 9 "Turning On and Off the Power"
The power of the machine does not come on.	The power cable is unplugged from the wall outlet.	Plug the power cable firmly into the wall outlet.
	The machine is connected to an extension cord.	You cannot use an extension cord. After checking that the screen is not lit when you touch it and the main power indicator is unlit, remove the extension cord and plug the power cable directly into the wall outlet.
	There may be a problem with the wall outlet.	After checking that the screen is not lit when you touch it and the main power indicator is unlit, plug the power cord into a confirmed operating wall outlet.
Only the copy icon is displayed when the machine is turned on.	The functions other than the copy function are starting up.	The time required for a function to start up varies depending on the function. Wait a while.

Condition	Cause	Solution and reference
Only some of the menu items are displayed when you press [Settings] after turning on the power of the machine.	The functions other than the copy function are starting up.	The time required for a function to start up varies depending on the function. More items on the menu in [Settings] are displayed as the functions start up. Wait a while.
The login screen is displayed.	Basic Authentication, Windows Authentication, or LDAP Authentication is specified.	Enter the login user name and password, and then press [Login]. For the login user name and password, consult the user administrator. page 38 "Logging In from the Control Panel"
The User Code entry screen is displayed.	User Code authentication is specified.	Enter the User Code, and press [OK]. Consult the user administrator for the user code.
A function is not executed, or you cannot perform an operation.	Another function that cannot be used with the specified function at the same time is being executed.	Wait for the function in progress to end, and then perform the next operation. For details about functions that cannot be used at the same time, see the following section: page 235 "Function Compatibility" When a backup of the address book is being created using Web Image Monitor or another method, the next function is executed after the backup is completed.
The key is unresponsive, or another key is activated.	A malfunction is temporarily occurring on the machine.	Turn off the power of the machine, wait for 10 seconds or more after confirming that the main power indicator is turned off, and then turn on the power again.
You cannot interrupt copying even after pressing [Stop] while the copy function is operating.		page 9 "Turning On and Off the Power"

Condition	Cause	Solution and reference
You cannot interrupt copying or scanning even after pressing [Stop], and the login screen is displayed.	Basic Authentication, Windows Authentication, or LDAP Authentication is specified, and the user who started the copying or scanning operation has logged out.	Log in to the machine as the user who started the copying or scanning operation or as the machine administrator, and press [Stop].
A strange noise is heard.	The consumable is not set correctly.	If you hear a strange noise after replacing a consumable, remove the consumable and set it again correctly.
	The paper tray is not set correctly.	Check that the paper tray is set correctly.
	The machine is not placed horizontally.	Check that the machine is placed horizontally. <ul style="list-style-type: none"> Place the machine on a flat and horizontal surface. The machine must be level within 5 mm (0.20 inches) front to rear and left to right.
Help is not displayed when you press [Help] (?).	The application that is currently in use does not support the help function, or ? is grayed out because "Paper Misfeed" or another message is being displayed.	The help function cannot be used when ? is grayed out. Close the application or message, and then try again.
	? is grayed out because the user does not have permission to use the browser function.	The help function cannot be used if the user does not have permission to use the browser function. If ? is always grayed out, consult the user administrator to check whether you have permission to use the browser function. The user administrator can change the access permissions in the address book. See "Confirming the Available Functions", User Guide (Full Version).

Condition	Cause	Solution and reference
The screen changes to Web Browser when you press [Help] (?), but the help content is not displayed.	The machine is not connected to the network correctly.	Check if you can display a web page in [Web Browser]. If a web page cannot be displayed, check that the machine is connected to the network correctly. See "Selecting the Network Connection Method", User Guide (Full Version).
	The browser is configured not to save cookies.	Check that the [Web Browser] ► [Menu] (⚙️) ► [Settings] ► [Privacy & security] ► [Accept cookies] check box is selected.
The screen remains turned on and the machine does not enter the sleep mode when you press [Energy Saving] (⏻).	The machine is in a condition that does not allow the machine to enter the sleep mode.	Check the conditions in which the machine does not enter the sleep mode. page 9 "Turning On and Off the Power"
The machine does not shut down when more than four minutes have passed after you press the main power switch.	The shutdown operation could not be performed normally.	Press the main power switch again.

When the Machine Does Not Respond Correctly to an Operation from a Computer

Condition	Cause	Solution and reference
When using the address book from Device Manager NX, an incorrect password error is displayed even when you enter the correct login user name and password.	A certificate is not installed on the computer when SSL/TLS is enabled on the machine.	Install the certificate on the computer. Consult your network administrator for the certificate.
	An item other than [Simple Encryption] is specified in [Extended Security].	Specify [Simple Encryption] in "Driver Encryption Key:Encryption Strength" in [Settings] ► [Machine Features Settings] ► [System Settings] ► [Administrator Tools] ► [Extended Security].

Condition	Cause	Solution and reference
<p>You cannot access the machine using Web Image Monitor.</p>	<p>There is a problem with the connection between the machine and the computer.</p>	<p>Check the cable connecting the machine and the computer, and disconnect and then connect the cable again. Also, check the connection to the hub or router, and turn off and on the power of the device if possible. Next, turn off the power of the machine, wait for 10 seconds or more after confirming that the main power indicator is turned off, and then turn on the power. page 9 "Turning On and Off the Power"</p>
	<p>A proxy server is not specified.</p>	<p>In the proxy setting of the Web browser, specify the IP address of the machine as an exception. You can check the IP address in [Check Status] ► "Network".</p>
<p>"There is a problem with this website's security certificate." is displayed and you cannot connect to the machine when accessing the machine using Web Image Monitor.</p>	<p>"Permit SSL/TLS Communication" is set to [Ciphertext Only].</p>	<ul style="list-style-type: none"> • Click [Continue to this website (not recommended)]. • To specify not to display the message, log in Web Image Monitor in the administrator mode, and specify [Ciphertext/Cleartext] in [SSL/TLS] ► "Permit SSL/TLS Communication" under [Device Management] ► [Configuration] ► "Security".
	<p>"https" is entered at the beginning of the URL.</p>	<p>Do not enter "s" after "http".</p>

When a Message Is Displayed and the Machine Cannot Be Operated

Message	Condition	Solution and reference
"Service Call" SCxxx-xx Contact Serial No. of Machine	The machine needs to be repaired.	Consider repairing the machine.
"Functional Problems" SCxxx-xx Contact Serial No. of Machine	A malfunction that requires maintenance or repair has occurred.	<p>Prepare for maintenance or consider repairing the machine.</p> <ul style="list-style-type: none"> If a message prompts you to turn the power of the machine off and then on, the problem may be resolved by turning off the power, waiting for 10 seconds or more after confirming that the main power indicator is turned off, and then turning on the power. page 9 "Turning On and Off the Power" When "Press [Cancel] to cancel functions." is displayed, you can continue using the machine except for the function in which the malfunction is occurring after pressing [Cancel].
"Please wait."	The machine is recovering from the sleep mode.	<p>Wait a while. Turn off the power of the machine if the message persists after four minutes, wait for 10 seconds or more after confirming that the main power indicator is turned off, and then turn on the power. page 9 "Turning On and Off the Power"</p>

Message	Condition	Solution and reference
"Please wait."	The machine is preparing to perform a function or executing the image stabilization process.	Wait a while and do not turn off the power of the machine.
	The ambient temperature is outside the temperature range specified for the machine operation.	<p>Check the room temperature and whether it satisfies the operational requirements of the machine. If the machine has just been moved to the current location, leave it be for some time and allow it to adapt to the environment before use.</p> <p>See "Installation Requirements After Moving the Machine", User Guide (Full Version).</p> <p>If the message persists after four minutes even when the room temperature is within the specifications, wait for 10 seconds or more after confirming that the main power indicator is turned off, and then turn on the power.</p> <p>page 9 "Turning On and Off the Power"</p>
"Please wait."	A consumable or supply such as the toner has been replenished.	<p>Wait a while and do not turn off the power of the machine. Turn off the power of the machine if the message persists after four minutes, wait for 10 seconds or more after confirming that the main power indicator is turned off, and then turn on the power.</p> <p>page 9 "Turning On and Off the Power"</p>
"Shutting down... Please wait. Main power will be turned off automatically. Maximum waiting time: 4 minute(s)"	The power of the machine was turned off while the machine was starting up or in the standby mode.	Wait until the power is turned off.

Note

- If the message persists even after you have performed the operations as instructed in the following message, a malfunction may temporarily occur on the machine. Turn off the power of the machine, wait for 10 seconds or more after confirming that the main power indicator is turned off, and then turn on the power.

- page 9 "Turning On and Off the Power"
 - "Cover Open"
 - "Add Toner"
 - "Original(s) left on exposure glass."
 - "No paper."

When a Message Appears While Using the Copy Function

Message	Condition	Solution and reference
"2 Sided Copy is not available with this paper size."	A paper size that is not supported in duplex copying is specified.	Check the paper size supported in duplex copying and load the supported paper. page 217 "List of Specifications"
"Cannot Detect Original Size"	An original is not placed correctly on the machine.	Place the original correctly. When you place an original on the exposure glass, the machine detects the original size by opening and closing the ADF. Open the ADF by more than 30 degrees when placing an original.
	An original with a difficult-to-detect size even in the regular size, such as a transparency or paper with sticky notes, is placed on the machine.	When scanning an original with a difficult-to-detect size, specify the paper tray in [Paper Select]. Also, when making an enlarged or reduced copy, select an item other than [Fit to Paper Size] page 165 "Sizes Detectable with Auto Paper Select"
	An original of a custom size is placed on the machine.	When scanning an original of a custom size, specify the original size in [Original Setting] ► [Original Size] ► [Custom Size].
"Exceeded the maximum number of sheets that can be used. Copying will be stopped."	When the copy volume use limitation is enabled, copying was canceled because the copy volume of the user exceeded the upper limit allotted for the user.	For details about the copy volume use limitation, consult the user administrator. The user administrator can change the limit on the copy volume use. See "Specifying Maximum Print Volume Use of Each User", User Guide (Full Version).
"Rotate Sort is not available with this paper size."	A paper size that is not supported in Rotate Sort mode is specified.	Use two paper trays and set the same size and type of paper in the trays in different orientations, vertically and horizontally.
"Set next original(s), then press [Start]."	Duplex copying is specified.	When not copying onto both sides of paper, clear the [1 sided→2 sided] and [2 sided→2 sided] check boxes.

When a Message Is Displayed While Using the Fax Function

Note

- When confirming or changing the settings in [Settings], press [Home] (🏠) after closing [Settings].

Messages Displayed During Operation or When Sending/Receiving a Fax Cannot Be Performed

Message	Condition	Solution and reference
"Cannot detect original size."	An original is not placed correctly on the machine.	Place the original correctly. When you place an original on the exposure glass, the machine detects the original size by opening and closing the ADF. Open the ADF by more than 30 degrees when placing an original.
	An original with a difficult-to-detect size, even in the regular size, such as a transparency or paper with sticky notes or a custom size original, is placed on the machine.	Specify [Scan Size] in [Settings].
"Error occurred, and transmission was cancelled."	An original had jammed while sending a fax.	Press [Confirm], remove the jammed original, and then send the fax again.
	An error occurred temporarily in the machine, or there was interference on the line such as excessive noise or cross-talk.	Press [Confirm] and send the fax again.
"Memory is full. Cannot scan more. Transmitting only scanned pages."	The memory is full.	Press [Confirm] to return to the stand-by state and start sending the pages that are already scanned and stored. Check the transmission result report for unsent pages, and send those pages later.

Message	Condition	Solution and reference
"Some invalid destination(s) contained. Do you want to select only valid destination(s)?"	A folder destination is included in the group.	When sending a fax to a destination other than a folder destination, press [Select].

When a Message Appears While Using the Printer Function

Note

- When confirming or changing the settings in [Settings], press [Home] () after closing [Settings].

Messages Displayed without Error Codes

Message	Cause	Solution and reference
"Address Book is currently in use by another function. Authentication has failed."	The address book is in use by another function, and authentication query is not possible.	Try again later.
"All the remaining print volume has been allocated to another central managed client(s). The job has been cancelled."	The job was canceled because the usage count information could not be obtained from the Central Management machine.	All job slots are occupied by other devices. Check the status of the client machine.
"An error occurred while processing an Unauthorized Copy Prevention job. The job was cancelled."	The settings in the printer driver are incorrect.	Check that the text to use for the background pattern in the unauthorized copy prevention function does not contain any characters other than space(s) in the printer driver.

Message	Cause	Solution and reference
"Auto-registration of user information has failed."	The maximum number of items that can be registered has been exceeded and the authentication information for LDAP authentication or Windows authentication cannot be registered automatically.	Delete a user that is no longer necessary from the address book.
"Cannot access the Memory Storage Device."	An SD card or USB flash memory device is unavailable for use.	<ul style="list-style-type: none"> • Check that the external media is formatted in FAT16 or FAT32, and write protection is not enabled on the media. • Check that the external media is not corrupted or damaged.
"Cannot perform 2 sided print, because the following paper tray is set for 1 sided print only."	The paper source tray is not specified for duplex printing.	Specify to use the paper tray for duplex printing in [Settings] ► [Tray Paper Settings] ► [Paper Type].
"Collate has been cancelled."	The sort function was canceled.	Turn off the power of the machine, wait for 10 seconds or more after confirming that the main power indicator is turned off, and then turn on the power. page 9 "Turning On and Off the Power"
"Command Error"	A problem occurred in the data because of the communication status or another reason.	Check that the machine can communicate with the computer properly.
	A printer driver that does not support the machine was used.	Use the printer driver for the machine. Obtain and install the latest version of the driver.

Message	Cause	Solution and reference
"Communication error with central management server has occurred. The job has been cancelled."	The job was canceled because a Central Management communication error occurred.	Check the status of the Central Management machine.
"Compressed Data Error."	Compressed data is corrupted.	<ul style="list-style-type: none"> • Check that the tool used for creating the compressed data is functioning properly. • Check that the machine can communicate with the computer properly.
"Connection with the machine has failed. Check the machine structure."	The machine is malfunctioning, and [Printer] cannot be used.	<ul style="list-style-type: none"> • Check whether a message is displayed on the control panel. • Turn off the power of the machine, wait for 10 seconds or more after confirming that the main power indicator is turned off, and then turn on the power. <p>page 9 "Turning On and Off the Power"</p>
"Duplex has been cancelled."	The paper source tray is not specified for duplex printing.	Specify to use the paper tray for duplex printing in [Settings] ► [Tray Paper Settings] ► [Paper Type].
"Error has occurred."	An error such as a syntactic error has occurred.	Check that the PDF file to print does not have an error.
"Error occurred while processing a Compulsory Security Stamp print job. The job was cancelled."	The job was canceled because an error occurred while applying Compulsory Security Stamp.	When feeding paper from the bypass tray, specify the correct paper size and do not enable [Auto Detect].
"Exceeded max. number of files to print for temporary / stored jobs."	The number of files exceeded the maximum number.	Erase documents that are no longer needed. See "Deleting a Locked Print File Stored in the Machine", User Guide (Full Version).

Message	Cause	Solution and reference
"Exceeded max. number of pages to print for temporary / stored jobs."	The number of pages exceeded the maximum number that can be printed.	Divide the data to print into smaller sections.
	The number of pages exceeded the maximum number that can be printed in Locked Print.	<ul style="list-style-type: none"> Reduce the number of pages to print. Erase documents that are no longer needed. See "Deleting a Locked Print File Stored in the Machine", User Guide (Full Version).
"Exceeded max. pages. Collate is incomplete."	The maximum number of sheets that can be sorted has been exceeded.	Reduce the number of pages to print.
"Exceeded the maximum unit count for Print Volume Use. The job has been cancelled."	When the print volume is limited, printing was canceled because the print volume of a user exceeded the upper limit allotted for the user.	For details about the print volume use limitation, consult the user administrator. The user administrator can clear the counter or change the limit on the print volume. See "Checking the Counter of the Machine" and "Specifying Maximum Print Volume Use of Each User", User Guide (Full Version).
"Hardware Problem: USB"	An error has occurred on the USB interface.	Turn off the power of the machine, wait for 10 seconds or more after confirming that the main power indicator is turned off, and then turn on the power.
"Hardware Problem: Ethernet"	An error has occurred in the Ethernet interface.	page 9 "Turning On and Off the Power" If the message persists even after you have turned the power off and then on, consider repairing the machine.
"Hardware Problem: Wireless Card"	An error has occurred in the Wireless LAN board.	Turn off the power of the machine, check that the Wireless LAN board is correctly installed in the machine, and then turn on the power. page 9 "Turning On and Off the Power" If the message persists even after you have turned the power off and then on, consider repairing the machine.

Message	Cause	Solution and reference
"I/O buffer overflow."	An overflow has occurred in the receive buffer.	<ul style="list-style-type: none"> Reduce the transmission data. Increase the value in [I/O Buffer] on the [Settings] ► [Machine Features Settings] ► [Printer Settings] ► [Host Interface].
"Information for user authentication is already registered for another user."	In LDAP authentication, the same name is registered under different IDs on different servers, and duplicate names (account names) occurred such as when switching the domain (server).	Consult the user administrator. User administrator: Delete the corresponding user from the address book, and register the user again after resolving the duplicate names on different servers.
"Insufficient Memory"	The amount of available memory is insufficient.	Reduce the transmission data.
"Memory Overflow"	The insufficient memory error has occurred while printing from the printer driver (PCL 6).	In the printer driver, change "Vector/Raster:" to [Raster] in the [Detailed Settings] tab ► [Print Quality:Advanced] menu.
"No response from the server. Authentication has failed."	In LDAP or Windows authentication, a timeout error occurred while submitting an authentication query to the server.	Consult the administrator of the authentication server.

Message	Cause	Solution and reference
"Out of paper in the following paper tray. Load paper. To force print, select another tray and press [Print] key."	The paper tray specified in the printer driver has no paper loaded.	<ul style="list-style-type: none"> To proceed with printing after changing the paper setting, select a tray and press [Print]. However, when Cover Sheet is specified, or when Duplex printing is specified on a paper tray that does not support the function, printing cannot be performed. When Sort is specified, only one copy of the document is printed. To proceed with printing on the specified paper, load the paper in the tray. page 141 "Loading Paper into the Paper Tray"
"Output tray has been changed."	The destination to deliver the output paper was changed because of the paper size limitation of the output destination.	Specify the correct destination to deliver the output paper.
"Printer font error."	There is a problem in the font file of the machine.	Consider repairing the machine.
"Receiving data failed."	Transmission of data was canceled.	Send the data again.
"The selected paper size is not supported. This job has been cancelled."	A paper size that cannot be fed on the machine was specified and printing was canceled by the auto job cancel function that was activated.	Print the document on paper of a size that can be fed on the machine.

Message	Cause	Solution and reference
"The selected paper type is not supported. This job has been cancelled."	A paper type that cannot be fed on the machine was specified and printing was canceled by the auto job cancel function that was activated.	Print the document on paper of a type that can be fed on the machine.
"There is no paper tray that matches the specified paper size/paper type. Change the tray settings to the following paper size/paper type, or select another tray and press [Print] key."	The paper tray loaded with paper of the size or type specified in the printer driver is not available.	<ul style="list-style-type: none"> To proceed with printing after changing the paper setting, select a tray and press [Print]. When Cover Sheet is specified, or when Duplex printing is specified on a paper tray that does not support the function, printing cannot be performed. When Sort is specified, only one copy of the document is printed. To proceed with printing on the specified paper, load the paper and then check that the paper size and type are correctly specified in [Settings] ► [Tray Paper Settings]. page 141 "Loading Paper into the Paper Tray"
"You do not have a privilege to use this function. This job has been cancelled."	Authentication information is not registered correctly in the printer driver.	Specify the authentication information in the printer driver. For the authentication information, consult the user administrator. See "Specifying Login Information in the Printer Driver", User Guide (Full Version).
	The user registered in the printer driver does not have permission to use the printer function.	Consult the user administrator. The user administrator can change the access permissions in the address book. See "Confirming the Available Functions", User Guide (Full Version).

Messages Displayed with Error Codes

Check the Configuration Page. The details of the error may also be printed in the list.

See "List / Test Print", User Guide (Full Version).

Message	Cause	Solution and reference
"84: Error"	The amount of available work area is insufficient for processing images.	Reduce the transmission data.
"86: Error"	The parameter in the control code is incorrect.	Specify the correct parameter.
"99: Error"	When printing a file from an SD card or USB flash memory device, the file to print is in an unsupported format or corrupt.	Check the data to print.

When a Message Is Displayed While Using the Scanner Function

Note

- When confirming or changing the settings in [Settings], press [Home] (🏠) after closing [Settings].

Messages Displayed on the Control Panel

Message	Cause	Solution and reference
"Authentication with the destination has failed. Check settings. To check the current status, press [Scan Files Status]."	The user name/ password of SMTP authentication specified when sending the e-mail are incorrect.	Select the destination in the address book, press [Edit], and check the setting in [Destinations] tab ► [Email Address].
	The user ID/password specified on the destination folder in Send to Folder are incorrect.	<ul style="list-style-type: none"> Select the forwarding destination in the address book, press [Edit], and check the information registered in [Destinations] tab ► [Folder] ► [Folder Authentication Info]. Adding "@domain-name" behind the user name may resolve the problem. When a login password is not specified on your computer, specify a login password on the computer and register it to the machine.
"Cannot access the Memory Storage Device."	An SD card or USB flash memory device is unavailable for use.	<ul style="list-style-type: none"> Check that the external media is formatted in FAT16 or FAT32, and write encryption or protection is not enabled on the media. Check that the external media is not corrupted or damaged.

Message	Cause	Solution and reference
"Cannot detect original size. Select scan size."	An original is not placed correctly on the machine.	Place the original correctly. When you place an original on the exposure glass, the machine detects the original size by opening and closing the ADF. Open the ADF by more than 30 degrees when placing an original.
	An original with a difficult-to-detect size even in the regular size is placed on the machine.	When scanning an original with a difficult-to-detect size, specify [Send Settings] ► [Scan Size]. page 165 "Sizes Detectable with Auto Paper Select"
	An original with a custom size is placed on the machine.	When scanning an original with a custom size, specify the original size in [Send Settings] ► [Scan Size] ► [Custom Size].
"Cannot find the specified path. Please check the settings."	The machine or the computer is not connected to the network correctly.	Check that the machine or the computer is connected to the network correctly. For details about your network environment, consult the network administrator.
	The computer name or folder name specified in the path name is incorrect.	Register the computer name and folder name again.
	The firewall function is enabled on the computer.	In the firewall function on the computer, register the machine IP address and the port to use for sending files as exceptions. You can check the IP address in [Check Status] ► "Network". For details about the ports, see the following: page 217 "List of Specifications"
"Check original's orientation."	The original is placed in the wrong orientation.	Depending on the combination of the specified settings, the orientation to set the original differs. Be sure to place the original in the correct orientation. See "Placing an Original to Scan", User Guide (Full Version).

Message	Cause	Solution and reference
"Connection with PC has failed. Check the settings."	The machine or the computer is not connected to the network correctly.	Check that the machine or the computer is connected to the network correctly. For details about your network environment, consult the network administrator.
	The computer name or folder name specified in the path name is incorrect.	Register the computer name and folder name again.
	The firewall function is enabled on the computer.	In the firewall function on the computer, register the machine IP address and the port to use for sending files as exceptions. You can check the IP address in [Check Status] ► "Network". For details about the ports, see the following: page 217 "List of Specifications"
"Exceeded max. data capacity. Check the scanning resolution, then XXX." (procedure described in place of XXX)	A large size original was scanned at a high resolution, and the resulting data size exceeds the limit.	Decrease [Send Settings] ► [Resolution].
"Exceeded max. email size. Sending email has been cancelled. Check [Max. Email Size] in Scanner Features."	The file size per page has exceeded the maximum e-mail size specified in [Max. Email Size].	<ul style="list-style-type: none"> Specify a lower value in [Send Settings] ► [Resolution]. You can change the [Max. Email Size] setting on the [Settings] ► [Machine Features Settings] ► [Scanner Settings] ► [Send Settings]. To divide an e-mail that exceeds the maximum size, specify [Yes (per Page)] or [Yes (per Max. Size)] in [Divide & Send Email].
"Exceeded max. number of alphanumeric characters."	The number of entered characters has exceeded the maximum.	Check the maximum number of characters. page 229 "The Setting Values of the Transmission Function"

Message	Cause	Solution and reference
"Insufficient memory in the memory storage device."	There is no free space available on the SD card or USB flash memory device, or the file could not be saved due to insufficient space on the media.	Change the external media. When scanning an original in the divide-document or single-page mode, the saved data may not contain all pages in the original. Change the external media and press [Retry] to resume saving the remaining data.
"Programmed. Cannot program the destination(s) that is not programmed in the address book."	A folder specified by Manual Entry is included among the programmed destinations.	Register the destination in the address book of the machine, and then register it to a program.
"Programmed. Cannot program the folder destination(s) with protection code(s)."	A destination specified with a protection code is included among the programmed destinations.	<ul style="list-style-type: none"> You cannot program a destination specified with a protection code. Specify this destination individually. To program this destination, cancel the protection code and then register the destination to a program. <p>See "Using the Protection Function to Prevent the Misuse of Addresses", User Guide (Full Version).</p>
"SMTP authentication email address and administrator email address mismatch."	The SMTP authentication e-mail address is not registered in the administrator e-mail address.	Register the SMTP authentication e-mail address in [Settings] ► [Machine Features Settings] ► [System Settings] ► [File Transfer] ► [Administrator's Email Address].
"Some invalid destination(s) contained. Do you want to select only valid destination(s)?"	The group contains an e-mail address.	When sending data to a destination other than an e-mail address, press [Yes].

Message	Cause	Solution and reference
"The program is recalled. Cannot recall the folder destination(s) with protection code(s)."	A folder destination specified with a protection code is included among the programmed destinations.	<ul style="list-style-type: none"> You cannot recall a destination specified with a protection code in a program. Specify this destination individually. To program this destination, cancel the protection code and then register the destination to a program. <p>See "Using the Protection Function to Prevent the Misuse of Addresses", User Guide (Full Version).</p>
"Transmission has failed. Insufficient memory in the destination hard disk. To check the current status, press [Scan Files Status]."	The amount of available hard disk space on the destination computer, SMTP server, or FTP server is insufficient.	Check that the amount of free space is sufficient.
"Transmission has failed. To check the current status, press [Scan Files Status]."	A network error occurred while transferring the data due to a busy network or another reason.	If the same message is displayed after scanning the original again, consult the administrator.

Messages Displayed on the Computer

Message	Cause	Solution and reference
"Any of Login User Name, Login Password or Driver Encryption Key is incorrect."	The login user name or password entered in [General User Authentication] is incorrect.	Enter the correct login user name and password in [General User Authentication] that is displayed after clicking [Scan]. For the login user name and password, consult the user administrator.
	The driver encryption key is not registered correctly in the TWAIN driver.	Register the driver encryption key on the [Details] ► [Authenticate] tab in the TWAIN driver. For the driver encryption key, consult the network administrator.

Message	Cause	Solution and reference
"Authentication password and/or authentication algorithm may be incorrect. Please check."	The SNMPv3 authentication information registered in Network Connection Tool does not match the information of the machine.	Consult the network administrator for the SNMPv3 authentication information, and change the information registered in Network Connection Tool. See "Installing the TWAIN Driver", User Guide (Full Version).
"Authentication succeeded. However, the access privileges for scanner function has been denied."	The logged-in user does not have access privileges to use the scanner function.	Consult the user administrator. The user administrator can change the access permissions in the address book. See "Confirming the Available Functions", User Guide (Full Version).
"Cannot add any more scanning mode."	The maximum number of scanning modes that can be registered exceeds the maximum number (100).	Delete scanning modes that are no longer necessary.
"Cannot connect to the scanner. Check the network Access Mask settings in User Tools."	An access mask is specified.	Consult your administrator.
"Cannot specify any more scanning area."	The maximum number of scanning areas that can be registered exceeds the maximum number (100).	Delete scanning areas that are no longer necessary.
"Communication error has occurred on the network."	A communication error has occurred on the network.	Check that the settings for the communication protocol (TCP/IP) are configured correctly on the computer.

Message	Cause	Solution and reference
"Entered User Code is not registered or you do not have access privileges to use the scanner function, please contact your administrator."	The correct user code is not registered in the TWAIN drive when User Code authentication is specified on the machine.	Register the User Code on the [Details] ► [Authenticate] tab in the TWAIN driver. For the User Code, consult the user administrator.
	The User Code registered in the TWAIN driver is not assigned with the privileges to use the scanner function.	Consult the user administrator. The user administrator can change the access permissions in the address book. See "Confirming the Available Functions", User Guide (Full Version).
"Error has occurred in the scanner."	The scan condition specified in the application exceeds the range that can be specified on the machine.	Specify the scan condition within the range that can be specified on the machine. page 217 "List of Specifications"
	A malfunction is occurring in the driver.	<ul style="list-style-type: none"> Restart the application, and perform scanning again. Install the TWAIN driver again.
	A malfunction is temporarily occurring on the machine.	Turn off the power of the machine, wait for 10 seconds or more after confirming that the main power indicator is turned off, and then turn on the power. page 9 "Turning On and Off the Power"
"Error has occurred in the scanner driver."	An error is occurring in the driver or operating system.	Restart the computer.
	There is a problem with the network environment.	Check that the computer is connected to the network correctly and in an environment where the TCP/IP protocol can be used.
"Fatal error has occurred in the scanner."	An unrecoverable error is occurring on the machine.	Consider repairing the machine.

Message	Cause	Solution and reference
"Insufficient memory. Close all other applications, then restart scanning."	Other applications are running on the computer, and the amount of free memory is insufficient.	<ul style="list-style-type: none"> • Close applications on the computer. • If the same message is displayed when no other applications are running after starting the computer, uninstall the TWAIN driver, restart the computer, and then install the TWAIN driver again.
"Insufficient memory. Reduce the scanning area."	The memory allocated for the scanner function is insufficient.	<ul style="list-style-type: none"> • Reduce the scan size or resolution. You may be able to resolve the error also by reducing the brightness value when Duotone (black and white) or a high resolution is specified. • Specify [No Compression] on the [Initial Settings] ► [Compression] tab in the TWAIN driver.
"Invalid Winsock version. Please use version 1.1 or higher."	Winsock is corrupted.	Restore Winsock on the computer.
"Scanner is not available. Check the scanner connection status."	The power of the machine is not turned on, or the machine is not connected to the network correctly.	Check that the machine is turned on, and connected to the network correctly.
	The firewall function is enabled on the computer.	Configure the firewall function of the computer to allow communication of the application used, or disable the firewall function.
	The IP address of the machine could not be resolved from the host name.	Check that the host name of the machine is configured in Network Connection Tool that is installed with the TWAIN driver. See "Installing the TWAIN Driver", User Guide (Full Version).
	The IPv6 address could not be obtained when only IPv6 is enabled on the machine.	Log in to Web Image Monitor in the administrator mode, and select [Active] in [IPv4] ► "LLMNR" under [Device Management] ► [Configuration] ► "Network".

Message	Cause	Solution and reference
"Scanner is not available on the specified device."	The TWAIN scanner function is disabled on the machine.	The TWAIN scanner function cannot be used.
"Scanner is not ready. Check the scanner and the options."	The ADF is open.	Close the ADF.
"The device's authentication service cannot be performed."	Authentication cannot be performed because the authentication service is starting up or busy.	<ul style="list-style-type: none"> • When User Code or Basic authentication is specified, wait a while until processing the machine address is completed. • When Windows or LDAP authentication is specified, wait a while until the server becomes ready for processing. If authentication is not possible even after waiting for a while, consult your administrator.
"There is no response from the scanner. There may be a number of reasons for this, e.g. the data between the computer and scanner has been lost because of an increase in network traffic, the firewall in the virus protection software may be activated, or there might be problems with the hardware etc. If you can not fix this problem, please call service."	The network is busy.	Wait a while.
	The firewall function is enabled on the computer.	Configure the firewall function of the computer to allow communication of the application used, or disable the firewall function.
	The machine or the computer is not connected to the network correctly.	Check that the machine or the computer is connected to the network correctly.

Message	Cause	Solution and reference
"User Authentication in SNMPv3 connection has failed."	The authentication information is registered incorrectly in Network Connection Tool when SNMPv3 encrypted communication is enabled on the machine.	Register the SNMPv3 authentication information in Network Connection Tool that is installed on the computer with the TWAIN driver. For the SNMPv3 authentication information, consult your network administrator. See "Installing the TWAIN Driver", User Guide (Full Version).

When Other Messages Are Displayed

Note

- When confirming or changing the settings in [Settings], press [Home] (🏠) after closing [Settings].

Message	Cause	Solution and reference
"Administrator Authentication for User Management must be set to on before this selection can be made."	The User Management privilege is disabled in the administrator authentication management.	When specifying Basic, Windows, or LDAP authentication, configure the User Management privilege in [Settings] ▶ [Machine Features Settings] ▶ [System Settings] ▶ [Administrator Tools] ▶ [Administrator Authentication Management]. See "Registering the Administrator Before Using the Machine", User Guide (Full Version).
"Currently printing at low speed due to low voltage power supply."	Printing has slowed down because the power supply voltage is low.	This is not a malfunction. You can continue printing although the printing speed is low.
"Destination list / machine settings are updated. Selected destinations or function settings have been cleared. Please re-select the settings."	A destination is being registered and devices are being configured using Web Image Monitor.	Wait until the message disappears and do not turn off the power of the machine. You may not be able to perform operations for a while depending on the number of destinations being registered.
"Failed to read the PDF file."	The user attempted to display a PDF file that is not supported by the Web browser of the machine.	The Web browser of the machine supports the PDF versions and encryption levels shown below. Other PDF files cannot be displayed. <ul style="list-style-type: none"> PDF version: 1.3-1.7 PDF encryption level: 128-bit AES, 256-bit AES
"Firmware update will start. Press [OK]. It will start automatically after 30 seconds have elapsed."	A firmware update is available, and the machine is about to perform an update.	It is recommended to apply the update, but you can stop the updating process by pressing [Stop] within 30 seconds after the message is displayed. Do not turn off the power of the machine while the updating process is in progress.

Message	Cause	Solution and reference
"Internal cooling fan is active."	The fan installed in the vent for cooling the interior of the machine became active after a large number of pages has been printed.	You may hear a rotating noise while the fan is active, but you can continue using the machine as usual.
"Printing has been stopped due to the power supply being low voltage. Turn the main power switch off then on."	Printing has stopped because the power supply voltage is low.	Turn off the power of the machine, wait for 10 seconds or more after confirming that the main power indicator is turned off, and then turn on the power. page 9 "Turning On and Off the Power"
"Problems with the wireless board. Please call service."	The Wireless LAN board can be accessed, but an error has been detected.	Turn off the power of the machine, check that the Wireless LAN board is correctly installed in the machine, and then turn on the power. page 9 "Turning On and Off the Power" If the message persists even after you have turned the power off and then on, consider repairing the machine.
"Updating the destination list... Please wait. Specified destination(s) or sender's name has been cleared."	A destination is being registered using Web Image Monitor.	Wait until the message disappears and do not turn off the power of the machine. You may not be able to perform operations for a while depending on the number of destinations being registered.
"Updating the destination list has failed. Try again?"	A network error occurred.	Check the connection between the machine and the computer.
	Anti-virus software or a firewall function is running on the computer.	Add the destination list program to the exception list in the anti-virus software on the computer, or register the machine IP address to the exception list in the firewall function. You can check the IP address in [Check Status] ► "Network".

Message	Cause	Solution and reference
"You do not have the privileges to use this function."	The logged-in user does not have the privileges to use the specified function.	Consult the user administrator. The user administrator can change the access permissions in the address book. See "Preventing Information Leaks", User Guide (Full Version).
	Changing the setting is not allowed under the administrative privileges granted to the logged-in user.	Check the administrative privilege required for changing the specified setting. See "Registering the Administrator Before Using the Machine", User Guide (Full Version).

Messages Displayed When Machine Login Fails

Check the error code displayed with the "Authentication has failed." message, and taken the necessary action.

Note

- The letter at the beginning of the error code indicates the type of authentication specified on the machine.
 - B: Basic authentication
 - W: Windows authentication
 - L: LDAP authentication

Message	Cause	Solution and reference
"Authentication has failed." B/W/L0103-000	An operation in the TWAIN supporting application was performed from the computer while a user was logged in to the machine or performing the login procedure.	Check whether another user is logged in to the machine, and then perform the operation.

Message	Cause	Solution and reference
"Authentication has failed." B/W/L0104-000	An incorrect password was entered.	Enter the correct password.
	The Driver Encryption Key is not registered correctly in the driver.	Consult the network administrator whether the Driver Encryption Key is required, and configure the driver accordingly. See "Specifying Login Information in the Printer Driver" and "Specifying Login Information in the LAN-Fax Driver", User Guide (Full Version). The network administrator can check the setting of "Driver Encryption Key" in [Settings] ► [Machine Features Settings] ► [System Settings] ► [Administrator Tools] ► [Extended Security].
"Authentication has failed." B/W/L0206-002	An incorrect login user name or password was entered.	Enter the correct login user name and password.
"Authentication has failed." B/W/L0206-003	":" or another character that cannot be used in a login user name was entered.	<ul style="list-style-type: none"> • Enter the correct login user name. • Change the user name if it contains a space, ":" or other unusable characters.
"Authentication has failed." B/W/L0207-001	Web Image Monitor or another method was used to edit or create a backup of the address book.	Wait a while.
"Authentication has failed." B/W/L0208-000 B/W/L0208-002	The account is locked because the number of failed login attempts has exceeded the limit.	Request the user administrator to unlock the account.
"Authentication has failed." L0307-001	Web Image Monitor or another method was used to edit or create a backup of the address book.	Try again later.

Message	Cause	Solution and reference
"Authentication has failed." W0400-102	Kerberos authentication has failed because the server was not responsive.	Check whether the server is operating normally.
"Authentication has failed." W0400-200	Available resources are insufficient due to too many authentication requests.	Try again later.
"Authentication has failed." W0400-202	sAMAccountName was used as the login user name when a user in the child domain logged in under a parent-child domain environment, and ldap_bind failed.	Use UserPrincipalName as the login user name.
	The SSL settings specified on the authentication server and the device do not match.	Check whether the SSL settings specified on the authentication server and the device match.
"Authentication has failed." L0400-210	The login name attribute is not specified, or an attribute on which the information cannot be obtained is specified.	Check whether [Login Name Attribute] is specified correctly. See "Verifying Users to Operate the Machine (User Authentication)", User Guide (Full Version).
"Authentication has failed." W/L0406-003	":" or other characters that cannot be used in a login user name was entered.	<ul style="list-style-type: none"> • Enter the correct login user name. • Change the user name if it contains a space, ":" or other unusable characters.
"Authentication has failed." W0406-101	Too many requests for authentication occurred at one time.	Try again later. If the problem persists, check whether the machine is under an authentication attack. The attack status can be checked by the screen message, in the system log, or in the e-mail notification sent to the administrator.

Message	Cause	Solution and reference
"Authentication has failed." W0406-107	A user group cannot be obtained.	Check whether the group name registered on the machine is correct and whether the DC settings are configured correctly.* ¹
	Kerberos Authentication has failed.	Check whether the realm name registered on the clock at the KDC (key distribution center) and the clock of the device are synchronized.* ³
	The domain name is incorrect or cannot be resolved.	Check whether the domain name registered on the machine is correct and whether the name can be resolved.* ²
	The login user name or password is incorrect.	Check the login user name and/or password of the user registered on the server.
"Authentication has failed." L0406-200	Too many requests for authentication occurred at one time.	Try again later. If the problem persists, check whether the machine is under an authentication attack. The attack status can be checked by the screen message, in the system log, or in the e-mail notification sent to the administrator.
"Authentication has failed." L0406-201	[Off] is specified in the authentication settings of the LDAP server.	Set "Authentication" to a setting other than [Off] in [Settings] ► [Machine Features Settings] ► [System Settings] ► [Administrator Tools] ► [Program/Change/Delete LDAP Server].

Message	Cause	Solution and reference
"Authentication has failed." L0406-202 L0406-203	The LDAP authentication settings or LDAP server settings are incorrect.	Check whether the LDAP authentication settings or LDAP server settings are correctly configured.* ⁴ Check whether the SSL settings are supported on the LDAP server.
	The login user name or password is incorrect.	Enter the correct login user name and password. Change the login user name if it exceeds 128 bytes in length or contains a space, ":" or other unusable character.
	The simplified authentication mode is incorrectly used.	Check whether the server name, login user name, password, and information entered into the search filter are correct. Note that authentication cannot be performed if obtaining DN of the login user name under the representative account fails in the simple authentication mode.
"Authentication has failed." L0406-204	Kerberos Authentication has failed.	Check whether the realm name registered on the clock at the KDC (key distribution center) and the clock of the device are synchronized.* ³
"Authentication has failed." W/L0409-000	There was no response returned from the authentication server, and an authentication timeout error occurred.	Check the status of the network and the server to use for authentication.
"Authentication has failed." W/L0511-000 W0517-000	The user registered on the machine has the same name as another user distinguished by the unique attribute of the authentication server.	<ul style="list-style-type: none"> Delete the older user that is redundant, or change the login name. If the message is displayed after switching the authentication server, delete the user on the old server.
"Authentication has failed." W/L0606-004	A user name that cannot be specified in the login user name was specified.	Do not use "other", "admin", "supervisor", or "HIDE*" in user account names.

Message	Cause	Solution and reference
"Authentication has failed." W/L0607-001	Web Image Monitor or another method was used to edit or create a backup of the address book.	Wait a while.
"Authentication has failed." W/L0612-005	The number of users registered in the address book has reached the upper limit, and auto-registration failed.	Ask the user administrator to delete users that are no longer needed from the address book.
"Authentication has failed." W/L0707-001	Web Image Monitor or another method was used to edit or create a backup of the address book.	Wait a while.
"Authentication has failed." B/W/L09XX-019	Auto-registration of a user on the server machine has failed when authentication was performed on the client machine using Central Management.	<ul style="list-style-type: none"> • Check the network communication between the client and server machines. • Registration cannot be performed while the address book of the server machine is being edited.

* 1 When obtaining user groups, check the following:

- The user account that can obtain user groups is sAMAccountName (user). Do not use UserPrincipalName (user@domain.xxx.co.jp) as the user name.
- Check whether the name in "Group" is correctly specified including the case-sensitivity in [Settings] ► [Machine Features Settings] ► [System Settings] ► [Administrator Tools] ► [User Authentication Management] ► [Windows Authentication].
- Select the user in the address book, press [Edit], and then check that [User Management / Others] tab ► [User Management] ► [Available Functions / Applications] is not selected.
- Check whether "Global Scope" is specified as the scope of the group in a property for the user group created in DC, and the group type specified in "Security". Also check whether an account is registered to the user group that has been created. If more than one DC exists, check whether a trust relationship between DCs is established.

* 2 To resolve the domain name, see the following:

- Check whether [Domain Name] and [DNS Configuration] is specified correctly in [Settings] ► [Machine Features Settings] ► [System Settings] ► [Interface Settings] ► [Network].
- Enter the IP address in [Domain Name] to check the connection. If authentication can be performed using the IP address, check [DNS Configuration] again.
- If authentication by IP address is not possible, check whether LM/NTLM is set to be denied in the domain controller security policy or domain security policy. Also check that the port is not closed in the firewall between the device and the domain controller or in the firewall settings of the domain controller. When the Windows firewall is enabled, create a new rule that allows communication on port 137 and port 139 in "Advanced" of the Windows firewall. Open the TCP/IP properties from the network connection properties, select the "Enable NetBIOS Over TCP/IP" check box on the [Advanced] ► [WINS] tab, and open port 137.

*3 For Kerberos authentication, check the following:

- Check that "Realm Name", "KDC Server Name", "Domain Name" are specified correctly in [Settings] ► [Machine Features Settings] ► [System Settings] ► [Administrator Tools] ► [Program/Change/Delete Realm]. Enter "Realm Name" in upper case.
- Configure the setting so that the difference in time between the clocks on KDC and device is less than five minutes. The clock on the machine can be adjusted in [Settings] ► [Machine Features Settings] ► [System Settings] ► [Timer Settings] ► [Set Time].
- Kerberos authentication fails if auto-obtaining of KDC in Windows authentication fails. When auto-obtaining cannot be activated, switch to manual.

*4 For LDAP settings, check the following:

- Check whether the LDAP server is correctly specified in [Settings] ► [Machine Features Settings] ► [System Settings] ► [Administrator Tools] ► [User Authentication Management] ► [LDAP Authentication] and Login Name Attribute is registered correctly.
- Check that the representative account is registered in "Authentication" ► "Kerberos Authentication" under [Settings] ► [Machine Features Settings] ► [System Settings] ► [Administrator Tools] ► [Program/Change/Delete LDAP Server], and then execute [Connection Test].
See "Programming the LDAP Server", User Guide (Full Version).
- If the connection test fails, check whether [Domain Name] and [DNS Configuration] is specified correctly on the [Settings] ► [Machine Features Settings] ► [System Settings] ► [Interface Settings] ► [Network].

Messages Displayed When Logging in to the Machine Using an IC Card Fails

Message	Cause	Solution and reference
"Authentication has failed." *0150-401	The card is locked because the number of times an incorrect PIN code was entered exceeds the limit.	Unlock the card.
"Authentication has failed." *0151-401	An incorrect PIN code was entered.	Enter the correct PIN.
"Authentication has failed." *0153-402	The card authentication device has been removed or is not connected properly.	Connect the card authentication device again.
"Authentication has failed." *0154-402	Reading of an IC card has failed.	Set the IC card on the authentication device correctly and for a longer duration.
"Authentication has failed." *0156-401	An incorrect user name or password was entered.	Enter the correct user name and password.
"The card authentication device is not connected."	A malfunction is temporarily occurring on the machine.	Turn off the power of the machine, wait for 10 seconds or more after confirming that the main power indicator is turned off, and then turn on the power. page 9 "Turning On and Off the Power"

Messages Displayed When the LDAP Server Is Unavailable

Message	Cause	Solution and reference
"Connection with LDAP server has failed. Check the server status."	The network is busy.	Try again.
	The setting information is incorrect.	Check the setting information of the [Settings] ► [Machine Features Settings] ► [System Settings] ► [Administrator Tools] ► [Program/Change/Delete LDAP Server]. See "Programming the LDAP Server", User Guide (Full Version).
"Exceeded time limit for LDAP server search. Check the server status."	The network is busy.	Try again.
	The setting information is incorrect.	Check the setting information of the [Settings] ► [Machine Features Settings] ► [System Settings] ► [Administrator Tools] ► [Program/Change/Delete LDAP Server]. See "Programming the LDAP Server", User Guide (Full Version).
"LDAP server authentication has failed. Check the settings."	The user name or password is incorrect.	Select the user in the address book, press [Edit], and specify the correct user name and password in [User Management / Others] tab ► [User Management] ► [LDAP Authentication Info]. See "Registering a User in the Address Book and Specifying the Login Information", User Guide (Full Version).

Messages Displayed When an Application Site Cannot Be Used

Message	Cause	Solution and reference
"A server error has occurred."	An unexpected error has occurred on the server.	<ul style="list-style-type: none"> • See the server maintenance information in [Information]. • Check whether the network settings ([DNS Configuration], [Proxy Settings]) are correctly configured.
"Cannot connect to server which installs applications. Check maintenance information on Information screen or network settings."	Cannot connect to the installation server.	
"Could not update the firmware."		
"Failed to download the application."		
"Failed to install the application because an error has occurred."		
"Could not restore the firmware because the required data does not exist."	The firmware from Application Site has not been updated.	The firmware cannot be recovered.
"JavaTM Platform has not been started. Install the application after JavaTM Platform has been started from Web Image Monitor."	JavaVM is not running.	Log in to Web Image Monitor in the administrator mode, and enable "JavaTM Platform" in [Device Management] ► [Configuration] ► "Extended Feature Settings".
"The specified page cannot be found."	An error has occurred in Application Site.	See the server maintenance information in [Information].

9. Specifications for The Machine

List of Specifications

Note

- We have licenses from the authors to use their software including open sources. Refer to the files in the Licenses folder included in the supplied CD-ROM for statements requested from the authors.

Specifications for the Main Unit

Item	Specifications
Configuration	Desktop
Memory	2 GB
Copy process	Laser electrostatic transfer
Warm-up time (23°C (73.4°F), rated voltage)	19 seconds
First copy time	6.5 seconds (A4 / 8 ¹ / ₂ × 11 ¹ / ₄ , exposure glass)
Copy/print speed (per minute)	<ul style="list-style-type: none">• One-sided 27 pages per minute• Two-sided 16 pages per minute
Maximum original size	A3 / 11×17

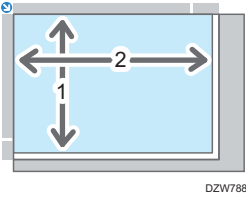
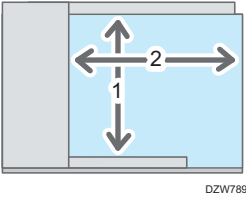
Item	Specifications
Original scanning area	<ul style="list-style-type: none"> • Exposure Glass <div data-bbox="540 368 783 564" style="text-align: center;">  <p style="text-align: right; font-size: small;">DZW788</p> </div> <ol style="list-style-type: none"> 1. Vertical: Up to 297 mm (11.7 inches) 2. Horizontal: Up to 432 mm (17.1 inches) • ADF <div data-bbox="540 740 783 936" style="text-align: center;">  <p style="text-align: right; font-size: small;">DZW789</p> </div> <ol style="list-style-type: none"> 1. Vertical: 128 to 297 mm (5.1 to 11.7 inches) 2. Horizontal <ul style="list-style-type: none"> • Copy function: 128 to 1,260 mm (5.1 to 49.7 inches) • Scanner function: 128 to 432 mm (5.1 to 17.1 inches) • Facsimile function: 128 to 1,200 mm (5.1 to 47.3 inches) * <p style="margin-left: 20px;">* Specify "Parameter Setting" under [Fax Settings] to use the long length original. See "List of Parameter Settings", User Guide (Full Version).</p>
Originals	Sheet, book, three-dimensional object

Item	Specifications
Copy size	<ul style="list-style-type: none"> • Tray 1–2, Bypass Tray: page 147 "Recommended Paper Sizes and Types" • Duplex: <ul style="list-style-type: none"> A3 □, A4, A5 □, B4 JIS □, B5 JIS □, 11 × 17 □, 8¹/₂ × 14 □, 8¹/₂ × 13 □, 8¹/₂ × 11, 8¹/₄ × 14 □, 8¹/₄ × 13 □, 8 × 13 □, 8 × 10¹/₂, 8 × 10 □, 7¹/₄ × 10¹/₂ □, 5¹/₂ × 8¹/₂ □, 8K □, 16K, 11 × 15 □, 10 × 14 □, SRA3 □, SRA4, 8¹/₂ × 13²/₅ □ • Duplex (Custom Size): <ul style="list-style-type: none"> Vertical: 105.0–297.0 mm (4.14-11.69 inches), Horizontal: 195.0–432.0 mm (7.68–17.00 inches)
Paper weight	<ul style="list-style-type: none"> • Trays 1–2, Bypass Tray: page 147 "Recommended Paper Sizes and Types" • Duplex: 60–105 g/m² (16–20 lb. Bond)
Missing image area (Copy)	<div style="text-align: center;"> <p style="text-align: right; font-size: small;">DZX710</p> </div> <ol style="list-style-type: none"> 1. Leading edge: 3.0 ± 2.0 mm (0.12 ± 0.08 inches) 2. Trailing edge: Approx. 5.0 mm (0.20 inches) 3. Left edge: 2.0 ± 1.5 mm (0.08 ± 0.06 inches) 4. Right edge: Approx. 2.0 mm (0.08 inches)

Item	Specifications
Preset reproduction ratio	Preset reproduction ratios (%): <ul style="list-style-type: none"> • Enlargement: 400, 200, 141, 122, 115 • Full size: 100 • Reduction: 93, 82, 75, 71, 65, 50, 25
Reproduction ratio (zoom)	From 25–400% in increments of 1%
Resolution (scanning originals)	600 × 600 dpi
Resolution (copying)	600 × 600 dpi
Paper capacity (80 g/m ² , 20 lb. Bond)	page 147 "Recommended Paper Sizes and Types"
Continuous copy run	1–999 sheets
Duplex	Standard
Power requirements	220–240 V, 8 A, 50/60 Hz
Power consumption (Main unit only)	Ready: 113 W During printing: 500 W Maximum: 1,550 W or less The power level when the main switch is turned off and the power cord is plugged into an outlet: 1 W or less
Power consumption (Complete system)	Maximum: 1,550 W or less <ul style="list-style-type: none"> • The complete system consists of the main unit, internal tray 2, two paper tray units, fax unit, and card reader.
Dimensions (W × D × H)	587 × 581 × 677 mm (23.11 × 22.87 × 26.65 inches)
Space for main unit (W × D)	944 × 627 mm (37.2 × 24.7 inches) (including the bypass tray)

Item	Specifications
Noise emission	<ul style="list-style-type: none"> • Sound power level: Main unit only Stand-by: 40.0 dB (A) Copying: 65.5 dB (A) • Sound power level: Complete system Stand-by: 40.0 dB (A) Copying: 69.5 dB (A) <p>Note</p> <ul style="list-style-type: none"> • Sound power levels and sound pressure levels are actual values measured in accordance with ISO 7779. • Sound pressure levels are measured from the position of the bystander. • The complete system consists of the main unit, internal tray 2, and two paper tray units.
Weight	Approx. 46 kg (101.4 lb.)



Specifications for Facsimile

This function may not be used depending on the telephone line or area status.

Note

- To connect the machine to the network, use a LAN cable supporting 1000BASE-T, 100BASE-TX, and 10BASE-T. The length of the usable cable is up to 100 m.

Fax Transmissions and Reception

Item	Specifications
Standard	G3
Resolution	Standard: 8 × 3.85 lines/mm, 200 × 100 dpi (Standard character), 8 × 7.7 lines/mm, 200 × 200 dpi (Detail character)
Transmission time	3 seconds at 28,800 bps, Standard resolution
Data compression method	MH, MR, MMR
Maximum original size	Standard: A3  or 11 × 17  Custom (w × h): 297 × 1,260 mm (11.7 × 49.6 inches)

Item	Specifications
Maximum scanning size	297 × 1,200 mm (11.7 × 47.3 inches)
Transmission speed	33,600 / 31,200 / 28,800 / 26,400 / 24,000 / 21,600 / 19,200 / 16,800 / 14,400 / 12,000 / 9,600 / 7,200 / 4,800 / 2,400 bps (auto shift down system)

Specifications for Printer

Note

- To connect the machine to the network, use a LAN cable supporting 1000BASE-T, 100BASE-TX, and 10BASE-T. The length of the usable cable is up to 100 m.

Item	Specifications
Printing speed	<ul style="list-style-type: none"> One-sided 27 pages per minute Two-sided 16 pages per minute
Resolution	200 dpi, 300 dpi, 400 dpi, 600 dpi
Printer language	PCL 5e/6, PostScript 3 Emulation, PDF, MediaPrint (JPEG, TIFF)
Interface	<ul style="list-style-type: none"> Ethernet. (10BASE-T/100BASE-TX/1000BASE-T) USB2.0 (Type B) port USB2.0 (Type A) port (on the control panel) SD card slot (on the control panel) IEEE 802.11a/b/g/n wireless LAN interface
Network protocol	TCP/IP (IPv4, IPv6)
USB interface	<ul style="list-style-type: none"> Transmission spec: USB 2.0 Standard Connectable device: Devices corresponding to USB 2.0 Standard

Item	Specifications
Operating system	<ul style="list-style-type: none"> Windows 7/8.1/10 Windows Server 2008/2008 R2/2012/2012 R2/2016/2019 OS X 10.11 or later
Fonts	<ul style="list-style-type: none"> PCL/PostScript 3/PDF: 93 Roman fonts Summary: Nimbus Sans 4 fonts, HGPAGothic 1 font

Specifications for Scanner

Note

- To connect the machine to the network, use a LAN cable supporting 1000BASE-T, 100BASE-TX, and 10BASE-T. The length of the usable cable is up to 100 m.

Scanning

Item	Specifications
Type	Full-color scanner
Scan method	Flatbed scanning
Image sensor type	CCD Image Sensor
Scan type	Sheet, book, three-dimensional object
Original sizes that can be scanned	<ul style="list-style-type: none"> Length: 10–297 mm (0.4–11 inches) Width: 10–432 mm (0.4–17 inches)
Scan sizes automatically detectable from the exposure glass	A3☐, A4, A5, B4 JIS☐, B5 JIS
Scan sizes automatically detectable from the ADF	A3☐, A4, A5, B4 JIS☐, B5 JIS, B6 JIS, 11 × 17☐, 8 ¹ / ₂ × 11

Item	Specifications
Scan speed (the machine equipped with the ARDF)	<ul style="list-style-type: none"> Black and white: 50 image per minute Resolution: 200 dpi, Original size: A4¹, Original Type: B & W two-value, Compression (MMR): Compressed, ITU-T No.1 Chart Full color: 50 image per minute Resolution: 200 dpi, Original size: A4¹, Original type: Text / Photo, Compression (Gray Scale / Full Color): Default, Original Chart <p>Scanning speed differs depending on the operating environment of the machine and computer, scan settings, and the content of originals.</p>
Tone	<ul style="list-style-type: none"> Black & White: 2 tones Full Color/Gray Scale: 256 tones
Basic scanning resolution:	200 dpi
Image compression type for black and white (two-value)	TIFF (MH, MR, MMR)
Image compression type for gray scale/full color	JPEG
Interface	<ul style="list-style-type: none"> Ethernet. (10BASE-T/100BASE-TX/1000BASE-T) USB2.0 (Type A) port (on the control panel) SD card slot (on the control panel) IEEE 802.11 a/b/g/n wireless LAN interface
Network protocol	TCP/IP

* 1 The function can be used only in Scanner (Classic).

E-mail transmission

Item	Specifications
Scanning resolution	100 dpi, 200 dpi, 300 dpi, 400 dpi, 600 dpi
Protocol* 1	POP, SMTP*2, IMAP4
Output format	TIFF, JPEG, PDF, PDF/A

* 1 Supporting Web mail transmission

*2 Supporting SMTP over SSL

↓ Note

- When you select [PDF] or [PDF/A] for the file format, you can attach a digital signature. You can also specify the security settings for [PDF].
- See "Scanning an Original as a PDF with Security Setting Specified", User Guide (Full Version).

Scan to Folder

Item	Specifications
Scanning resolution	100 dpi, 200 dpi, 300 dpi, 400 dpi, 600 dpi
Protocol	SMB <ul style="list-style-type: none"> • You can use SMB protocol (139/TCP, 137/UDP) or CIFS protocol (445/TCP) for sending folders with SMB. • The Scan to Folder function with SMB protocol (139/TCP, 137/UDP) is enabled under NetBIOS over TCP/IP environment only. • You cannot use the Scan to Folder function with SMB under NetBEUI.
Output format	TIFF, JPEG, PDF, PDF/A

↓ Note

- When you select [PDF] or [PDF/A] for the file format, you can attach a digital signature. You can also specify the security settings for [PDF].
- See "Scanning an Original as a PDF with Security Setting Specified", User Guide (Full Version).

Network TWAIN Scanner

Item	Specifications
Scanning resolution	100–1,200 dpi* ¹
Protocol	TCP/IP
Operating system	<ul style="list-style-type: none"> • Windows 7/8.1/10 • Windows Server 2008/2008 R2/2012/2012 R2/2016/2019 (TWAIN scanner runs in 32-bit compatible mode on a 64-bit operating system, so TWAIN scanner is not compatible with 64-bit applications. Use 32-bit applications. IC card Authentication System is not compatible with 64-bit operating system.)

*¹ The maximum resolution depends on the scan size.

WIA scanner

Item	Specifications
Scanning resolution (Main scanning × Sub-scanning)	100–1,200 dpi* ¹
Protocol	TCP/IP
Operating system	<ul style="list-style-type: none"> • Windows 7/8.1/10 • Windows Server 2008/2008 R2/2012/2012 R2/2016/2019 (WIA scanner can function under both 32- and 64-bit operating systems.)

* 1 The maximum resolution depends on the scan size.

Specifications for Auto Document Feeder (ADF)

Item	Specifications
Mode	Mixed Sizes mode, Custom Size originals mode, Original Orientation mode
Original Size	A3☐–A5, B4 JIS☐–B6 JIS, 11 × 17☐–8 ¹ / ₂ × 11 <ul style="list-style-type: none"> • You cannot scan two sides of B6 JIS originals.
Original weight	1 Sided: 40-128 g/m ² (11-34 lb. Bond) Two Sided: 52-128 g/m ² (14-34 lb. Bond)
Number of originals to be set	100 sheets (80 g/m ² , 20 lb. Bond)

Specifications for Internal Tray 2

Item	Specifications
Number of bins:	1

Item	Specifications
Paper size	A3, A4, A5, A6, B4 JIS, B5 JIS, B6 JIS, 11 × 17, 8 1/2 × 14, 8 1/2 × 13, 8 1/2 × 11, 8 1/4 × 14, 8 1/4 × 13, 8 × 13, 8 × 10 1/2, 8 × 10, 7 1/4 × 10 1/2, 5 1/2 × 8 1/2, 8K, 16K, 12 × 18, 11 × 15, 11 × 14, 10 × 15, 10 × 14, SRA3, SRA4, 8 1/2 × 13 2/5, custom size
Paper weight	60-105 g/m ² (16 lb. Bond- 28 lb. Bond)
Stack capacity (80 g/m ² , 20 lb. Bond)	50 sheets
Power requirements	Power is supplied from the main unit.
Maximum power consumption	9 W or less
Dimensions (W × D × H)	416 × 425 × 85 mm (16.38 × 16.73 × 3.35 inches)
Weight	Approx. 2 kg (4.4 lb.)

Specifications for Lower Paper Tray

Item	Specifications
Page size	page 147 "Recommended Paper Sizes and Types"
Paper capacity	page 147 "Recommended Paper Sizes and Types"
Paper weight	page 147 "Recommended Paper Sizes and Types"
Power requirements	Power is supplied from the main unit.
Maximum power consumption	18 W or less
Dimensions (W × D × H)	587 × 556.2 × 140 mm (23.11 × 21.89 × 5.51 inches)
Weight	Approx. 12 kg (26.5 lb.)

Specifications for Lower Paper Trays

Item	Specifications
Page size	page 147 "Recommended Paper Sizes and Types"
Paper capacity (80 g/m ² , 20 lb. Bond)	page 147 "Recommended Paper Sizes and Types"
Paper weight	page 147 "Recommended Paper Sizes and Types"
Power requirements	Power is supplied from the main unit.
Maximum power consumption	36 W or less
Dimensions (W × D × H)	587 × 556.2 × 340.6 mm (23.11 × 21.89 × 13.41 inches)
Weight	Approx. 30 kg (66.1 lb.)

The Setting Values of the Transmission Function

Note

- Depending on the type or settings of a document or original, you may not be able to specify or enter the maximum number of destinations or characters.

Send Email

Item	Value	Remarks
Maximum number of characters entered in an e-mail address	128 alphanumeric characters	An e-mail; address that has been searched from the LDAP server and exceeds 128 alphanumeric characters cannot be specified correctly as the destination.
Number of destinations that can be specified at one time	100	Up to 100 items can be specified when entering an item manually (including the items specified by LDAP search) For the rest, select up to 400 items from the registered destinations.
Size of a document that can be sent	Up to 30 MB per document	-
Number of pages that can be sent	Up to 100 pages per document	-

Send to Folder

Item	Value	Remarks
Maximum number of characters in a path name specified for the SMB protocol	256 characters	-
Maximum number of characters in a user name specified for the SMB protocol	64 characters	-

Item	Value	Remarks
Maximum number of characters in a password specified for the SMB protocol	64 characters	-
Number of destinations that can be specified at one time	32	Up to 32 items can be entered also when entering the items manually.
Size of a document that can be sent	46 MB per document	-

Broadcast Transmission

Item	Value	Remarks
Total number of destinations that can be specified for Send Email and Send to Folder	132	-
Number of destinations that can be specified when sending a document by Send Email	100	Up to 50 items can be specified when entering an item manually (including the items specified by LDAP search)
Number of destinations that can be specified when sending a document by Send to Folder	32	-

Printable Area and Margin

Tray 1–3

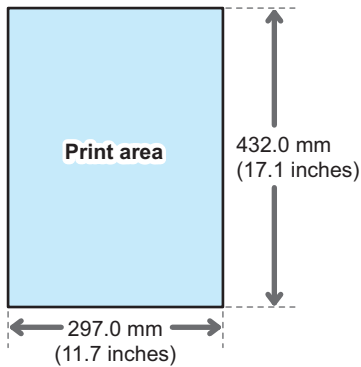

EBW564

Bypass Tray

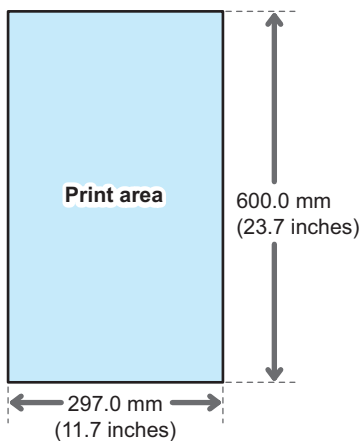

EBW565

Note

- The machine does not support margin-less printing. To minimize the margins, specify the maximum printable area with the settings on the printer driver.
- See "Maximizing the Printable Area When Printing", User Guide (Full Version).
- The maximum width of the printable area perpendicular to the feeding direction is 297 mm (11.7 inches). Printing starts from the upper left corner of the paper in relation to the feed direction. Accordingly, the right and bottom edges of an image will be cropped if the width of the image exceeds the maximum width of a printable area.

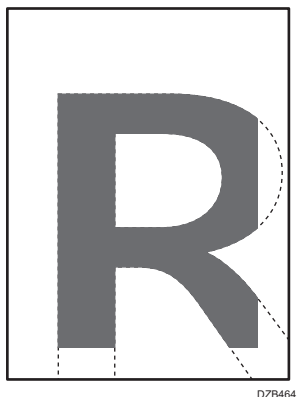

- The printable area may vary due to the paper size or settings of the printer driver.
- The outside of the printable area can be printed due to the settings of the printer driver or printing condition; however, the print result may be different from the intended one or the paper may not be fed correctly.

Machine Options

Guide to Functions of the Machine's External Options

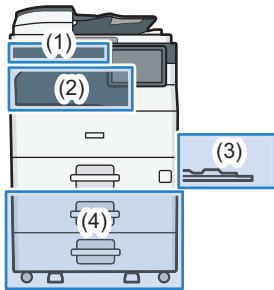

EBW562

(1) Options Mounted on the Machine's Front Panel



EBW563

No.	Option	Description
1	Card reader	Pass an IC card over the card reader to log in to the machine. page 38 "Logging In from the Control Panel"

(2) Options Mounted to the Machine's Paper Output Section

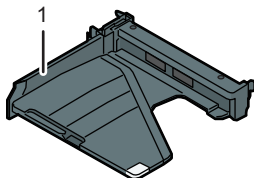

EBW559

No.	Option	Description
1	Internal Tray 2	Specify the output tray for the function, such as Copy or Fax, added to the Internal Tray 1. Copied/printed paper or fax messages are delivered here face down.

(3) Options Mounted on the Machine's Side Panel

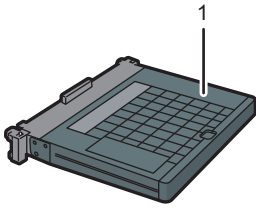

EBW560

No.	Option	Description
1	Bypass Tray Cover	Attach this cover to the bypass tray to keep dust out.

(4) Options Mounted on the Machine's Bottom

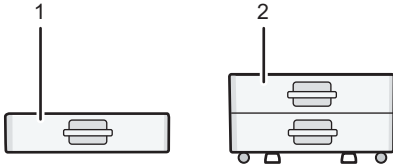

EBW561

No.	Option	Description
1	Lower Paper Tray	Paper is loaded here. You can load up to 500 sheets of paper.
2	Lower Paper Trays	Consists of two paper trays. You can load up to 1000 sheets of paper.

Guide to Functions of the Machine's Internal Options

- Fax unit
Allows you to use the facsimile function.

Function Compatibility

Function Compatibility

The chart shows Function Compatibility when [Interleave Priority] is set to [Switch Every Specified No.].

○ : Simultaneous operations are possible.

● : Operation is enabled when the relevant function key is pressed and remote switching (of the scanner/external extension) is done.

▲ : Operation is performed automatically once the preceding operation ends.

✕ : Simultaneous operations are not possible. The operation must be started once the preceding operation ends.

Mode before you select		Copy		Fax						Printer			Scanner		TWAIN	Web Document Server	
		Operations for Copying	Sort	Transmission Operation/ Manual Reception Operation	Scanning an Original for Memory Transmission	Memory Transmission	Memory Reception	Printing Received Data (LAN/USB)	Printing Received Data (LAN/USB)	Data Reception	Printing	Stapling	Operation for Scanning	Scanning	Scanning	Printing	
Copy	Operations for Copying	✕	✕	●	●	○	○	○	○	○	○	○	●	●	●	●	
	Sort	✕	✕	●	● ^{*1}	○	○	○	○	○	○ ^{*2}	○ ^{*2}	●	● ^{*1}	● ^{*1}	○	
Fax	Transmission Operation/ Manual Reception Operation	●	●	✕	✕	○	○	○	○	○	○	○	○	○	○	○	
	Scanning an Original for Memory Transmission	✕	✕	✕	✕	○	○	○	○	○	○ ^{*2}	○ ^{*2}	✕	✕	✕	○	
	Memory Transmission	○	○	○	○	✕	✕	○	○	○	○	○	○	○	○	○	
	Memory Reception	○	○	○	○	✕	✕	○	○	○	○	○	○	○	○	○	
Printer	Reception	○	○	○	○	○	○	▲	▲	○	○ ^{*2}	○ ^{*2}	○	○	○	○	
	Data Reception	○	○	○	○	○	○	○	▲	▲	▲	○	○	○	○	○	
	Print	○	○ ^{*2}	○	○ ^{*2}	○	○	○	○ ^{*2}	✕	○	▲	▲	○	○	○	○ ^{*2}
Scanner	Printing	○	○ ^{*2}	○	○ ^{*2}	○	○	○	○ ^{*2}	✕	○	▲	▲	○	○	○	○ ^{*3}
	Stapling	○	○ ^{*2}	○	○ ^{*2}	○	○	○	○ ^{*2}	✕	○	▲	▲	○	○	○	○ ^{*3}
TWAIN	Operations for Scanning	●	●	●	●	○	○	○	○	○	○	○	✕	✕	●	○	
	Scanning	●	● ^{*1}	●	● ^{*1}	○	○	○	○	○	○	○	✕	✕	✕	○	
Web Document Server	Scanning	✕	✕	✕	✕	○	○	○	○	○	○	○	✕	✕	✕	○	
Web Document Server	Printing	○	○ ^{*2}	○	○ ^{*2}	○	○	○	○ ^{*2}	✕	○	○	○	○	○	○	○ ^{*2}

^{*1} You can scan a document after the preceding job documents are all scanned.

^{*2} When you print an image that is A3 size and 4800 x 1200 dpi or bigger, printing may not start until the current print job is complete. (Type A and B models only)

^{*3} During stapling, printing automatically starts after the current job.

Note

- The scanning speed may become slower when scanning an original with another function while executing printing.

9. Specifications for The Machine

Copy Function Compatibility

Blank: These modes can be used together.

- : These modes cannot be used together. The second mode selected will be the mode you are working in.
- x : These modes cannot be used together. The first mode selected will be the mode you are working in.

	Function selected second																	
	Mixed Sizes	Regular Size Originals	Custom Size Originals	Original Orientation	Image Density (Manual)	Black & White	Auto Paper Select	Paper Select	Bypass Tray	Auto Reduce / Enlarge	Reduce / Enlarge	2 Sided Original	2 Sided	Combine	ID Card Copy	Stamp ¹	Sort	Rotate Sort
Mixed Sizes		x	x															
Regular Size Originals	x		•															
Custom Size Originals	x	•				x												
Original Orientation																		
Image Density (Manual)																		
Black & White																		
Auto Paper Select			•				•	•	•						•			
Paper Select							•		•									
Bypass Tray							•	•								x		x
Auto Reduce / Enlarge							•			•					•			
Reduce / Enlarge										•								
2 Sided Original																x		
2 Sided															•	x		
Combine														•		x		
ID Card Copy						x			x		x	x	x					
Stamp ¹									x									
Sort																		•
Rotate Sort								x									•	

¹ Stamps include Date Stamp, Page Numbering, and Stamp Text.

10. Legal and Contact Information

Environmental Regulations

Energy Saving Functions

To reduce its power consumption, this machine has the following functions:

Low Power mode

- If this machine remains idle for a specified period, it automatically reduces its electrical consumption.
- The default period the machine waits before entering Low Power mode is 1 minute. This default time can be changed.

Sleep mode

- If this machine remains idle for a specified period or when [Energy Saver] () is pressed, it enters Sleep mode to further reduce its electrical consumption.
- The default delay time the machine waits before entering Sleep mode is 1 minute. This default time can be changed.
- The machine can print jobs from computers and receive faxes while in Sleep mode.

Specifications

Reduced Electrical Consumption by Low Power Mode	55 W
Time of Switch into Low Power Mode	1 minutes
Reduced Electrical Consumption by Sleep Mode	4.0 W
Time of Switch into Sleep Mode	1 minutes
Time of Switch out from Sleep Mode	13 seconds
Duplex Function	Standard

Note

- You can change the amount of time that the machine waits before entering Sleep mode under [Sleep Mode Timer].
- See "Timer Settings", User Guide (Full Version)

- It may take longer than the specified time to enter Sleep mode according to the type of Embedded Software Architecture application installed in the machine.

User Information on Electrical and Electronic Equipment

Users in the countries where this symbol shown in this section has been specified in national law on collection and treatment of E-waste

Our Products contain high quality components and are designed to facilitate recycling.

Our products or product packaging are marked with the symbol below.



The symbol indicates that the product must not be treated as municipal waste. It must be disposed of separately via the appropriate return and collection systems available. By following these instructions you ensure that this product is treated correctly and help to reduce potential impacts on the environment and human health, which could otherwise result from inappropriate handling. Recycling of products helps to conserve natural resources and protect the environment.

For more detailed information on collection and recycling systems for this product, please contact the shop where you purchased it, your local dealer or sales/service representatives.

All Other Users

If you wish to discard this product, please contact your local authorities, the shop where you bought this product, your local dealer or sales/service representatives.

For Turkey only

AEEE Yönetmeliğine Uygundur.
Bu sistem sarf malzemeleri ve yedek parçaları da dahil olmak üzere AEEE Yönetmeliğine Uygundur.

Üretici:

Ricoh Company, Ltd.

3-6, Nakamagome 1-chome,
Ohta-ku, Tokyo 143-8555 Japan

+81-3-3777-8111(English only/Sadece İngilizce)

Note for the Battery and/or Accumulator Symbol (For EU countries only)



In accordance with the Battery Directive 2006/66/EC Article 20 Information for end-users Annex II, the above symbol is printed on batteries and accumulators.

This symbol means that in the European Union, used batteries and accumulators should be disposed of separately from your household waste.

In the EU, there are separate collection systems for not only used electrical and electronic products but also batteries and accumulators.

Please dispose of them correctly at your local community waste collection/recycling centre.

Contact your sales or service representative to change the battery.

Environmental Advice for Users

Users in the EU, Switzerland and Norway

Consumables yield

Please refer to either the User's Manual for this information or the packaging of the consumable.

Recycled paper

The machine can use recycled paper which is produced in accordance with European standard EN 12281:2002 or DIN 19309. For products using EP printing technology, the machine can print on 64 g/m² paper, which contains less raw materials and represents a significant resource reduction.

Duplex printing (if applicable)

Duplex printing enables both sides of a sheet of paper to be used. This saves paper and reduces the size of printed documents so that fewer sheets are used. We recommend that this feature is enabled whenever you print.

Toner and ink cartridge return program

Toner and ink cartridge for recycling will be accepted free of charge from users in accordance with local regulations.

For details about the return program, please refer to the Web page below or consult your service person.

<https://www.ricoh-return.com/>

Energy efficiency

The amount of electricity a machine consumes depends as much on its specifications as it does on the way you use it. The machine is designed to allow you to reduce electricity costs by switching to Ready mode after it prints the last page. If required, it can immediately print again from this mode. If no additional prints are required and a specified period of time passes, the device switches to an energy saving mode.

In these modes, the machine consumes less power (watts). If the machine is to print again, it needs a little longer to return from an energy saving mode than from Ready mode.

For maximum energy savings, we recommend that the default setting for power management is used.

Products that comply with the Energy Star requirement are always energy efficient.

Trademarks (User Guide)

Adobe, Acrobat, PostScript, and PostScript 3 are either registered trademarks or trademarks of Adobe Systems Incorporated in the United States and/or other countries.

The Bluetooth® word mark and logos are registered trademarks owned by Bluetooth SIG, Inc. and any use of such marks by Ricoh Company, Ltd. is under license.

Firefox is registered trademarks of the Mozilla Foundation.

Dropbox is a registered trademark or trademark of Dropbox, Inc.

Google, Android, Google Drive, and Chrome are trademarks of Google Inc.

Java is a registered trademark of Oracle and/or its affiliates.

Kerberos is a trademark of the Massachusetts Institute of Technology (MIT).

macOS, OS X, Bonjour, and Safari are trademarks of Apple Inc., registered in the U.S. and other countries.

Microsoft, Windows, Windows Server, and Internet Explorer are either registered trademarks or trademarks of Microsoft Corp. in the United States and/or other countries.

QR Code is a registered trademark of DENSO WAVE INCORPORATED in Japan and in other countries.

The SD and SD logo are trademarks of SD-3C, LLC.

The proper names of Internet Explorer 11 is as follows:

- Internet Explorer® 11

The proper names of the Windows operating systems are as follows:

- The product names of Windows 7 are as follows:

Microsoft® Windows® 7 Home Premium

Microsoft® Windows® 7 Professional

Microsoft® Windows® 7 Ultimate

Microsoft® Windows® 7 Enterprise

- The product names of Windows 8.1 are as follows:

Microsoft® Windows® 8.1

Microsoft® Windows® 8.1 Pro

Microsoft® Windows® 8.1 Enterprise

- The product names of Windows 10 are as follows:

Microsoft® Windows® 10 Home Premium

Microsoft® Windows® 10 Pro

Microsoft® Windows® 10 Enterprise

Microsoft® Windows® 10 Education

- The product names of Windows Server 2003 are as follows:
Microsoft® Windows Server® 2003 Standard Edition
Microsoft® Windows Server® 2003 Enterprise Edition
- The product names of Windows Server 2003 R2 are as follows:
Microsoft® Windows Server® 2003 R2 Standard Edition
Microsoft® Windows Server® 2003 R2 Enterprise Edition
- The product names of Windows Server 2008 are as follows:
Microsoft® Windows Server® 2008 Standard
Microsoft® Windows Server® 2008 Enterprise
- The product names of Windows Server 2008 R2 are as follows:
Microsoft® Windows Server® 2008 R2 Standard
Microsoft® Windows Server® 2008 R2 Enterprise
- The product names of Windows Server 2012 are as follows:
Microsoft® Windows Server® 2012 Foundation
Microsoft® Windows Server® 2012 Essentials
Microsoft® Windows Server® 2012 Standard
- The product names of Windows Server 2012 R2 are as follows:
Microsoft® Windows Server® 2012 R2 Foundation
Microsoft® Windows Server® 2012 R2 Essentials
Microsoft® Windows Server® 2012 R2 Standard
- The product names of Windows Server 2016 are as follows:
Microsoft® Windows Server® 2016 Essentials
Microsoft® Windows Server® 2016 Standard
- The product names of Windows Server 2019 are as follows:
Microsoft® Windows Server® 2019 Standard
Microsoft® Windows Server® 2019 Essentials
Microsoft® Windows Server® 2019 Datacenter

Wi-Fi® and Wi-Fi Direct® are registered trademarks of Wi-Fi Alliance.

Other product names used herein are for identification purposes only and might be trademarks of their respective companies. We disclaim any and all rights to those marks.

Microsoft product screen shots reprinted with permission from Microsoft Corporation.

MEMO

MEMO

