



LBP325x

User's Guide

Contents

Important Safety Instructions	2
Installation	3
Power Supply	5
Handling	6
Maintenance and Inspections	9
Consumables	10
Basic Operations	14
Main Functions	16
Parts and Their Functions	17
Front Side	18
Back Side	20
Interior	22
Multi-Purpose Tray	23
Paper Drawer	24
Operation Panel	25
Display	28
Using the Operation Panel	30
Entering Text	33
Turning ON/OFF the Power	35
Performing a Quick Start of the Machine	37
Loading Paper	39
Loading Paper in the Paper Drawer	41
Loading Paper in the Multi-Purpose Tray	46
Loading Envelopes or Postcards	49
Loading Preprinted Paper	53
Specifying Paper Size and Type	57
Specifying Paper Size and Type in the Paper Drawer	58
Specifying Paper Size and Type in the Multi-Purpose Tray	60
Saving Energy	62
Entering Sleep Mode	63
Setting Auto Shutdown Time	65
Printing a Document	69
Printing from a Computer	70
Canceling Prints	73
Various Printing Methods	75
Printing from USB Memory (USB Direct Print)	77
Changing Default USB Print Settings	86
Printing a Document Secured by a PIN (Secured Print)	88
Using the Encrypted Secured Print	91

Printing a Document Stored in the Machine (Stored Job Print)	92
Deleting a Document Stored in the Machine	96
Setting a Name or PIN to a Box	99
Printing without Opening a File (Direct Print)	101
Print Settings for Direct Print	104
Printing Received E-mail (E-Mail Print)	111

Can Be Used Conveniently with a Mobile Device 118

Connecting to a Mobile Device	119
Utilizing the Machine through Applications	120
Using AirPrint	121
Printing with AirPrint	125
If AirPrint Cannot Be Used	127
Using Google Cloud Print	128
Managing the Machine Remotely	132

Network 134

Connecting to a Network	135
Connecting to a Wired LAN	137
Setting IP Addresses	139
Setting IPv4 Address	140
Setting IPv6 Addresses	144
Configuring the Machine for Printing from a Computer	148
Configuring Printing Protocols and WSD Functions	149
Enabling IPP/IPPS	155
Configuring Printer Ports	161
Setting Up Print Server	164
Configuring the Machine for Your Network Environment	168
Configuring Ethernet Settings	169
Setting a Wait Time for Connecting to a Network	171
Configuring DNS	172
Configuring WINS	178
Configuring SNMP	181
Monitoring and Controlling the Machine with SNMP	184
Configuring Settings for Device Management Software	190
Configuring SMB	194
Configuring Settings on the Computer for Printing	197

Security 200

Protecting the Machine from Unauthorized Access	201
Preventing Unauthorized Access	202
Setting Access Privileges	204
Setting the System Manager Password	205
Setting the Department ID Management	208
Setting a Remote UI PIN	215

Restricting Communication by Using Firewalls	216
Specifying IP Addresses for Firewall Rules	217
Specifying MAC Addresses for Firewall Rules	223
Setting a Proxy	226
Restricting the Machine's Functions	229
Restricting the Printing Operations	230
Restricting USB Functions	234
Restricting Operation Panel Functions	237
Disabling HTTP Communication	240
Disabling Remote UI	241
Disabling the LAN Port	242
Hiding the Print Job History	243
Implementing Robust Security Features	245
Using TLS for Encrypted Communications	246
Configuring IPSec Settings	251
Configuring IEEE 802.1X Authentication	261
Configuring Settings for Key Pairs and Digital Certificates	267
Generating Key Pairs	268
Using CA-issued Key Pairs and Digital Certificates	277
Verifying Key Pairs and Digital Certificates	280
Using Remote UI	283
Starting Remote UI	284
Remote UI Screens	287
Managing Documents and Checking the Machine Status	293
Enabling End Users to Operate Documents	298
Setting Up Menu Options from Remote UI	301
Saving/Loading Registered Data	303
Saving Registered Data	304
Loading Registered Data	306
Setting Menu List	309
Setup Menu	310
Control Menu	311
Paper Source	325
Network	326
Layout	347
Print Quality	351
Interface	355
User Maintenance	358
Print Mode	371
Settings Specific to Print Mode	373
UFR II	374
PCL	375
Imaging	381

XPS	387
PDF	391
PS	395
MEAP Settings	398
Check Counter	400
Initialize Menu	401
Utility Menu	402
Job Menu	406
Reset Menu	408
Select Feeder Menu	410

Troubleshooting (FAQ) 418

Maintenance 420

Cleaning the Machine	422
Exterior	423
Fixing Unit	424
Replacing the Toner Cartridges	425
Relocating the Machine	431
Maintaining and Improving Print Quality	433
Adjusting Print Density	434
Adjusting Print Position	436
Printing Reports and Lists	441
Viewing the Counter Value	450
Checking Consumables	453
Initializing Settings	455
Initializing Menu	456
Initializing the Network Settings	457

Appendix 459

Third Party Software	460
Feature Highlights	461
Going Green and Saving Money	462
Improving Efficiency	463
So Much More	465
Specifications	467
Main Unit	468
Available Paper	470
Paper Feeder PF-C	474
Printer Functions	475
Management Functions	479
System Environment	483
Network Environment	484
Consumables	485

Options	487
Optional Equipment	488
System Options	489
Installing the ROM	491
Installing an SD Card	495
Manuals and Their Contents	500
Using User's Guide	501
Screen Layout of User's Guide	502
Viewing User's Guide	505
Managing MEAP Applications	507
Using FTP Clients	508
Preparing for Using the FTP Server	509
Printing via FTP Client (FTP Print)	512
Specifying Settings via FTP Client	514
Others	521
Basic Windows Operations	522
Font Samples	530
Notice	535

Important Safety Instructions

Important Safety Instructions	2
Installation	3
Power Supply	5
Handling	6
Maintenance and Inspections	9
Consumables	10

Important Safety Instructions

51W4-000

The content described in this chapter is for the prevention of damage to property and injury to users of the machine and others. Before using this machine, read this chapter and follow the instructions to properly use this machine. Do not perform any operations not described in this manual. Canon will not be responsible for any damages resulting from use not described in this manual, improper use, or repair/changes not performed by Canon or a third party authorized by Canon.

Installation

51W4-001

To use this machine safely and comfortably, carefully read the following precautions and install the machine in an appropriate location.

WARNING

Do not install in a location that may result in a fire or electrical shock

- A location where the ventilation slots are blocked (too close to walls, beds, sofas, rugs, or similar objects)
- A damp or dusty location
- A location exposed to direct sunlight or outdoors
- A location subject to high temperatures
- A location exposed to open flames
- Near alcohol, paint thinners or other flammable substances

Other warnings

- Do not connect unapproved cables to this machine. Doing so may result in a fire or electrical shock.
- Do not place necklaces and other metal objects or containers filled with liquid on the machine. If foreign substances come in contact with electrical parts inside the machine, it may result in a fire or electrical shock.
- When installing and removing the optional accessories, be sure to turn OFF the power, unplug the power plug, and then disconnect all the interface cables and power cord from the machine. Otherwise, the power cord or interface cables may be damaged, resulting in a fire or electrical shock.
- If any foreign substance falls into this machine, unplug the power plug from the AC power outlet and contact your local authorized Canon dealer.

CAUTION

Do not install in the following locations

The machine may drop or fall, resulting in injury.

- An unstable location
- A location exposed to vibrations



Other cautions

- When carrying this machine, follow the instructions in this manual. If carried improperly, it may fall, resulting in injury.
- When installing this machine, be careful not to get your hands caught between the machine and the floor or walls. Doing so may result in injury.

CAUTION

Avoid poorly ventilated locations

- This machine generates a slight amount of ozone and other emissions during normal use. These emissions are not harmful to health. However, they may be noticeable during extended use or long production runs in poorly ventilated rooms. To maintain a comfortable working environment, it is recommended that the room where the machine operates be appropriately ventilated. Also avoid locations where people would be exposed to emissions from the machine.

IMPORTANT

Do not install in the following locations that may result in damage

- A location subject to dramatic changes in temperature or humidity
- A location near equipment that generates magnetic or electromagnetic waves
- A laboratory or location where chemical reactions occur
- A location exposed to corrosive or toxic gases
- A location that may warp from the weight of the machine or where the machine is liable to sink (a carpet, etc.)



Do not install in a location where condensation occurs

- Water droplets (condensation) may form inside the machine when the room where the machine is installed is heated rapidly, and when the machine is moved from a cool or dry location to a hot or humid location. Using the machine under these conditions may result in paper jams, poor print quality, or damage to the machine. Let the machine adjust to the ambient temperature and humidity for at least 2 hours before use.

In altitudes of above sea level 3,000 m or higher

- Machines with a hard disk may not operate properly when used at high altitudes of about 3,000 meters above sea level, or higher.

Power Supply

51W4-002



WARNING

- Use only a power supply that meets the specified voltage requirements. Failure to do so may result in a fire or electrical shock.
- The machine must be connected to a socket-outlet with grounding connection by the provided power cord.
- Do not use power cords other than the one provided, as this may result in a fire or electrical shock.
- The provided power cord is intended for use with this machine. Do not connect the power cord to other devices.
- Do not modify, pull, forcibly bend, or perform any other act that may damage the power cord. Do not place heavy objects on the power cord. Damaging the power cord may result in a fire or electrical shock.
- Do not plug in or unplug the power plug with wet hands, as this may result in an electrical shock.
- Do not use extension cords or multi-plug power strips with the machine. Doing so may result in a fire or electrical shock.
- Do not wrap the power cord or tie it in a knot, as this may result in a fire or electrical shock.
- Insert the power plug completely into the AC power outlet. Failure to do so may result in a fire or electrical shock.
- Remove the power plug completely from the AC power outlet during a thunder storm. Failure to do so may result in a fire, electrical shock, or damage to the machine.



CAUTION

- Install this machine near the power outlet and leave sufficient space around the power plug so that it can be unplugged easily in an emergency.

IMPORTANT

When connecting power

- Do not connect the power cord to an uninterruptible power source. Doing so may result in malfunction of or damage to the machine at power failure.
- If you plug this machine into an AC power outlet with multiple sockets, do not use the remaining sockets to connect other devices.
- Do not connect the power cord to the auxiliary AC power outlet on a computer.

Other precautions

- Electrical noise may cause this machine to malfunction or lose data.

Handling

51W4-003

WARNING

- Immediately unplug the power plug from the AC power outlet and contact an authorized Canon dealer if the machine makes an unusual noise, emits an unusual smell, or emits smoke or excessive heat. Continued use may result in a fire or electrical shock.
- Do not disassemble or modify this machine. There are high-voltage and high-temperature components inside the machine which may result in a fire or electrical shock.



- Place the machine where children will not come in contact with the power cord and other cables or internal and electrical parts. Failure to do so may result in unexpected accidents.
- Do not use flammable sprays near this machine. If flammable substances come into contact with electrical parts inside this machine, it may result in a fire or electrical shock.
- When moving this machine, be sure to turn OFF the power of this machine and your computer, and then unplug the power plug and interface cables. Failure to do so may damage the power cord or interface cables, resulting in a fire or electrical shock.
- When plugging or unplugging a USB cable when the power plug is plugged into an AC power outlet, do not touch the metal part of the connector, as this may result in an electrical shock.

If you are using a cardiac pacemaker

- This machine generates a low level magnetic flux and ultrasonic waves. If you use a cardiac pacemaker and feel abnormalities, please move away from this machine and consult your physician immediately.

CAUTION

- Do not place heavy objects on this machine as they may fall, resulting in injury.
- For your safety, please unplug the power cord if the machine will not be used for a long period of time.
- Use caution when opening and closing covers to avoid injury to your hands.
- Keep hands and clothing away from the rollers in the output area. If the rollers catch your hands or clothing, this may result in personal injury.
- The inside of the machine and the output slot are very hot during and immediately after use. Avoid contact with these areas to prevent burns. Also, printed paper may be hot immediately after being output, so use caution when handling it. Failure to do so may result in burns.

CAUTION

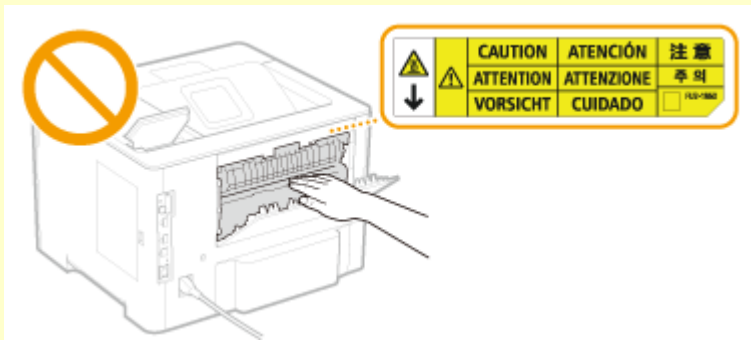

- Do not carry the machine with any of the paper drawer or optional paper feeder installed. Otherwise, they may fall, resulting in injury.

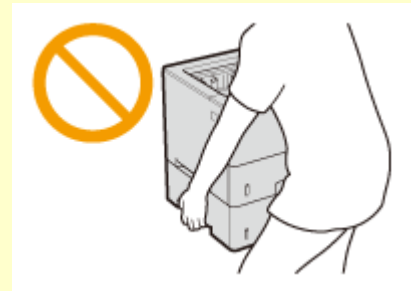

Laser beam

- If the laser beam should escape and enter your eyes, exposure may cause damage to your eyes.

IMPORTANT

When transporting the machine

To prevent damage to the machine during transport, perform the following.

- Remove the toner cartridge.
- Securely pack the machine in the original box with packing materials.

If the operating noise concerns you

- Depending on the use environment and operating mode, if the operating noise is of concern, it is recommended that the machine be installed in a place other than the office.

Other precautions

- Follow the caution instructions on labels and the like found on this machine.
- Avoid shaking or applying shock to this machine.
- Do not forcibly open and close doors, covers, and other parts. Doing so may result in damage to the machine.
- Do not touch the contacts () inside the machine. Doing so may result in damage to the machine.

Important Safety Instructions

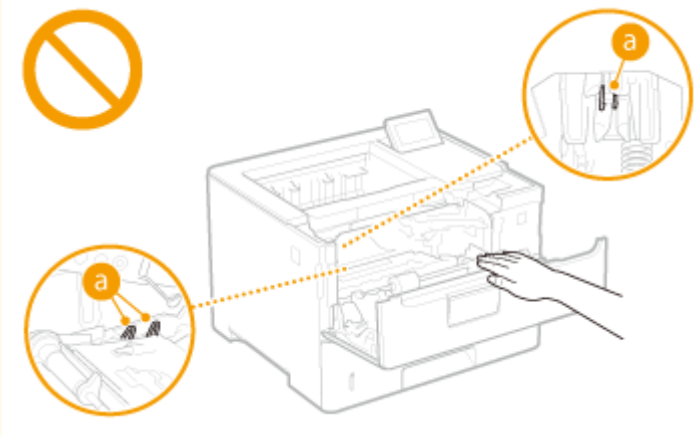

- To prevent a paper jam, do not turn OFF the power, open/close the covers, and load/unload the paper when printing.

Maintenance and Inspections

51W4-004

Clean this machine periodically. If dust accumulates, the machine may not operate properly. When cleaning, be sure to observe the following. If a problem occurs during operation, see Troubleshooting.



WARNING

- Before cleaning, turn OFF the power and unplug the power plug from the AC power outlet. Failure to do so may result in a fire or electrical shock.
- Unplug the power plug periodically and clean with a dry cloth to remove dust and grime. Accumulated dust may absorb humidity in the air and may result in a fire if it comes into contact with electricity.
- Use a damp, well wrung-out cloth to clean the machine. Dampen cleaning cloths with water only. Do not use alcohol, benzine, paint thinner, or other flammable substances. Do not use tissue paper or paper towels. If these substances come into contact with electrical parts inside the machine, they may generate static electricity or result in a fire or electrical shock.
- Check the power cord and plug periodically for damage. Check the machine for rust, dents, scratches, cracks, or excessive heat generation. Use of poorly-maintained equipment may result in a fire or electrical shock.



CAUTION

- The inside of the machine has high-temperature and high-voltage components. Touching these components may result in burns. Do not touch any part of the machine that is not indicated in the manual.
- When loading paper or removing jammed paper, be careful not to cut your hands with the edges of the paper.

IMPORTANT

- When removing jammed paper or replacing toner cartridges or the like, be careful not to get any toner on your hands or clothing. If toner gets on your hands or clothing, wash them immediately with cold water.

Consumables

51W4-005

WARNING

- Do not dispose of used toner cartridges or the like in open flames. Also, do not store toner cartridges or paper in a location exposed to open flames. This may cause the toner to ignite, and result in burns or fire.
- If you accidentally spill or scatter toner, carefully gather the toner particles together or wipe them up with a soft, damp cloth in a way that prevents inhalation. Never use a vacuum cleaner that does not have safeguards against dust explosions to clean up spilled toner. Doing so may cause a malfunction in the vacuum cleaner, or result in a dust explosion due to static discharge.

If you are using a cardiac pacemaker

- The toner cartridge generates a low level magnetic flux. If you are using a cardiac pacemaker and feel abnormalities, please move away from the toner cartridge and consult your physician immediately.

CAUTION

- Use caution not to inhale any toner. If you should inhale toner, consult a physician immediately.
- Use caution so that toner does not get into your eyes or mouth. If toner should get into your eyes or mouth, immediately wash with cold water and consult a physician.
- Use caution so that toner does not come into contact with your skin. If it should, wash with soap and cold water. If there is any irritation on your skin, consult a physician immediately.
- Keep the toner cartridges and other consumables out of the reach of small children. If toner is ingested, consult a physician or poison control center immediately.
- Do not disassemble or modify the toner cartridge or the like. Doing so may cause the toner to scatter.
- When removing the sealing tape from the toner cartridge, pull it out completely but without using excessive force. Doing otherwise may cause the toner to scatter.

IMPORTANT

Handling the toner cartridge

- Be sure to hold the toner cartridge using the handle.

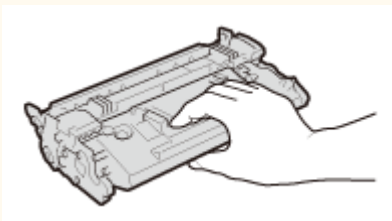

- Do not touch the toner cartridge memory (a) or the electrical contacts (b). To avoid scratching the surface of the drum inside the machine or exposing it to light, do not open the drum protective shutter (c).

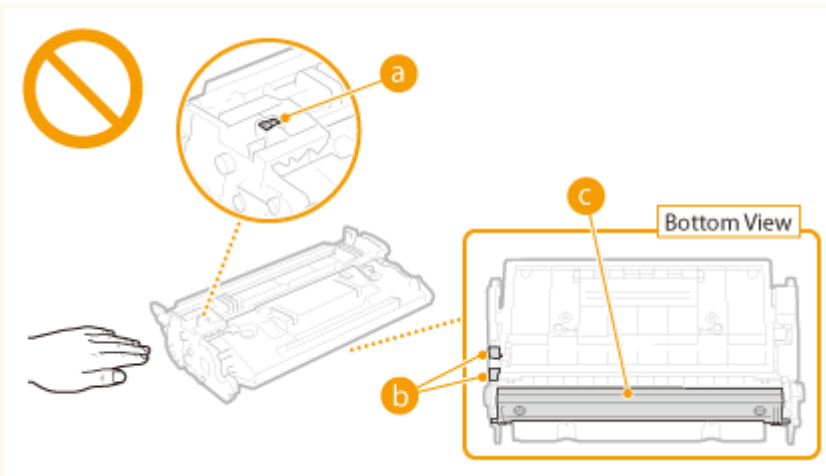

- Except when necessary, do not take out the toner cartridge from the packing material or from this machine.
- The toner cartridge is a magnetic product. Do not move it close to products susceptible to magnetism including floppy disks and disk drives. Doing so may result in data corruption.

Storing the toner cartridge

- Store in the following environment to ensure safe and satisfactory use.
Storage temperature range: 0 °C to 35 °C
Storage humidity range: 35 % to 85 % RH (relative humidity/no condensation)*
- Store without opening until the toner cartridge is to be used.
- When removing the toner cartridge from this machine for storage, place the removed toner cartridge in the original packing material.
- When storing the toner cartridge, do not store it upright or upside down. The toner will solidify and may not return to its original condition even if it is shaken.

* Even within the storable humidity range, water droplets (condensation) may develop inside the toner cartridge if there is a difference of temperature inside and outside the toner cartridge. Condensation will adversely affect the print quality of toner cartridges.

Do not store the toner cartridge in the following locations

- Locations exposed to open flames
- Locations exposed to direct sunlight or bright light for five minutes or more
- Locations exposed to excessive salty air
- Locations where there are corrosive gases (i.e. aerosol sprays and ammonia)
- Locations subject to high temperature and high humidity
- Locations subject to dramatic changes in temperature and humidity where condensation may easily occur
- Locations with a large amount of dust
- Locations within the reach of children

Be careful of counterfeit toner cartridges

- Please be aware that there are counterfeit Canon toner cartridges in the marketplace. Use of counterfeit toner cartridge may result in poor print quality or machine performance. Canon is not responsible for any malfunction, accident or damage caused by the use of counterfeit toner cartridge.
For more information, see global.canon/ctc.

Availability period of repairing parts and toner cartridges and the like

- The repairing parts and toner cartridges and the like for the machine will be available for at least seven (7) years after production of this machine model has been discontinued.

Toner cartridge packing materials

- Save the packing materials for the toner cartridge. They are required when transporting this machine.
- The packing materials may be changed in form or placement, or may be added or removed without notice.

Important Safety Instructions

- After you pull out the sealing tape from the toner cartridge, dispose of it in accordance with the applicable local regulations.

When disposing of a used toner cartridge or the like

- When discarding a toner cartridge or the like, place it in the original packing material to prevent toner from scattering from inside, and dispose of it in accordance with the applicable local regulations.

Basic Operations

Basic Operations	14
Main Functions	16
Parts and Their Functions	17
Front Side	18
Back Side	20
Interior	22
Multi-Purpose Tray	23
Paper Drawer	24
Operation Panel	25
Display	28
Using the Operation Panel	30
Entering Text	33
Turning ON/OFF the Power	35
Performing a Quick Start of the Machine	37
Loading Paper	39
Loading Paper in the Paper Drawer	41
Loading Paper in the Multi-Purpose Tray	46
Loading Envelopes or Postcards	49
Loading Preprinted Paper	53
Specifying Paper Size and Type	57
Specifying Paper Size and Type in the Paper Drawer	58
Specifying Paper Size and Type in the Multi-Purpose Tray	60
Saving Energy	62
Entering Sleep Mode	63
Setting Auto Shutdown Time	65

Basic Operations

51W4-006

This chapter describes basic operations, such as how to use the operation panel or how to load the paper, that are frequently performed to use the functions of the machine.

■ Parts and Their Functions

This section describes the exterior and interior parts of the machine and their functions, as well as how to use the keys on the operation panel and how to view the display. ▶ **Parts and Their Functions(P. 17)**



■ Using the Operation Panel

This section describes how to use the keys on the operation panel to perform various operations, such as adjusting and checking the settings. ▶ **Using the Operation Panel(P. 30)**



■ Turning ON/OFF the Power

This section describes how to turn ON/OFF the power. ▶ **Turning ON/OFF the Power(P. 35)**



■ Loading Paper

This section describes how to load the paper into the paper drawer and multi-purpose tray. ▶ **Loading Paper(P. 39)**



■ Saving Energy

This section describes how to reduce power consumption. ▶ **Saving Energy(P. 62)**



Main Functions

51W4-08E

This manual covers all the functions of the model series you purchased. Before getting started, check which functions are available on the model you purchased.

✓ : With function — : Without function

Function	LBP325x
Print	✓
2-sided printing	✓
Wired LAN connection	✓
Wireless LAN connection	—
USB connection	✓
Remote UI	✓
Keys and Certificates	✓
Linking with Mobile Devices	Black and white LCD
Display	✓
Department ID Management	✓
Paper Feeder PF-C	Optional
Barcode Printing Kit	Optional
PCL International Font Set	Optional
SD CARD	Optional

NOTE

- For the available driver types, see the User Software CD-ROM/DVD-ROM supplied with the machine, or see the Canon website (<https://global.canon/>).

LINKS

▶ **Viewing User's Guide(P. 505)**

Parts and Their Functions

51W4-007

This section describes the parts of the machine (exterior, front and back side, and interior) and how they function. In addition to describing the parts of the machine used for such basic operations as loading paper and replacing the toner cartridges, this section also describes the keys on the operation panel and display. Read this section for tips on how to use the machine properly.



- ▶ **Front Side(P. 18)**
- ▶ **Back Side(P. 20)**
- ▶ **Interior(P. 22)**
- ▶ **Multi-Purpose Tray(P. 23)**
- ▶ **Paper Drawer(P. 24)**
- ▶ **Operation Panel(P. 25)**

Front Side

51W4-008

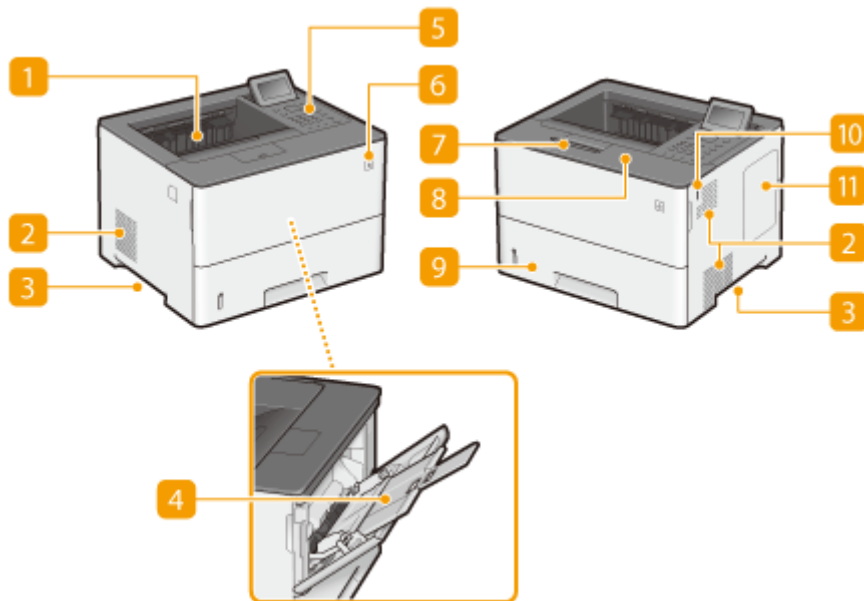

1 Output tray

Printed paper is output to the output tray.

2 Ventilation slots

Air from inside the machine is vented out to cool down the inside of the machine. Note that placing objects in front of the ventilation slots prevents ventilation. ▶ **Installation(P. 3)**

3 Lift handles

Hold the lift handles when carrying the machine. ▶ **Relocating the Machine(P. 431)**

4 Multi-purpose tray

Load the paper into the multi-purpose tray when you want to temporarily use a type of paper different from that which is loaded in the paper drawer. ▶ **Loading Paper in the Multi-Purpose Tray(P. 46)**

5 Operation panel

The operation panel consists of numeric keys, a display, status indicators, etc. You can perform all the operations and specify settings from the operation panel. ▶ **Operation Panel(P. 25)** ▶ **Display(P. 28)**

6 Power switch

Press the power switch to turn ON the power. When turning OFF the power, do not use this switch, but follow the procedures shown in ▶ **Turning OFF the Power (Performing a Shutdown)(P. 35)** .

7 Paper stopper

Open the paper stopper to prevent paper in the output tray from falling.

8 Front cover

Open the front cover when replacing toner cartridges or removing jammed paper from inside the machine.

▶ **Replacing the Toner Cartridges(P. 425)**

▶ **Interior(P. 22)**

9 Paper drawer

Load the type of paper you frequently use into the paper drawer. ▶ **Loading Paper in the Paper Drawer(P. 41)**

10 USB memory port (For USB memory)

You can connect a USB memory device to the machine and directly print the data from the USB memory device. You can directly print the data in the USB memory device without using a computer. (▶ **Printing from USB Memory (USB Direct Print)(P. 77)**). Also, connect a USB memory device when exporting or importing the settings of the machine (▶ **Import/Export Set.(P. 368)**).

11 Right cover

Open the right cover to install the optional ROM. ▶ **Installing the ROM(P. 491)**

Back Side

51W4-009

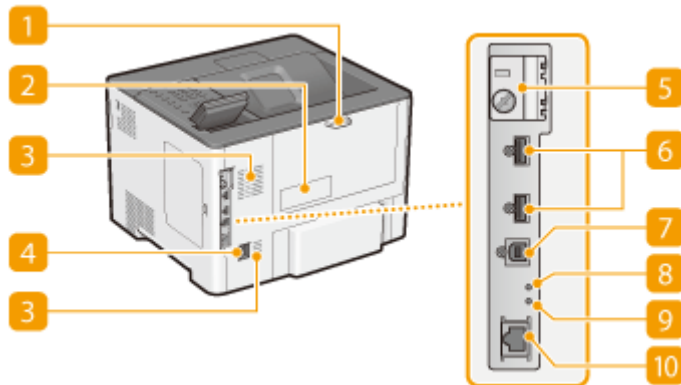

1 Back cover

Open the back cover when clearing paper jams. For more information, see "Troubleshooting (FAQ)" on the online manual website.

2 Rating label

The label shows the serial number, which is needed when making inquiries about the machine. For more information, see "Troubleshooting (FAQ)" on the online manual website.

3 Ventilation slots

Air from inside the machine is vented out to cool down the inside of the machine. Note that placing objects in front of the ventilation slots prevents ventilation. **▶Installation(P. 3)**

4 Power socket

Connect the power cord.

5 SD card slot cover

Open the SD card slot cover when installing the optional SD card. **▶Installing an SD Card(P. 495)**

6 USB port (for USB device connection)

Connect a USB device that is used with MEAP applications. Also, connect a USB memory device when exporting or importing the settings of the machine (**▶Import/Export Set.(P. 368)**).

7 USB port (for computer connection)

Connect a USB cable when connecting the machine and a computer.

8 ACT indicator

The ACT indicator blinks while data is being sent or received.

9 LNK indicator

The LNK indicator blinks green when the machine is properly connected to a network.

10 LAN port

Connect a LAN cable when connecting the machine to a wired LAN router, etc. ▶ **Connecting to a Wired LAN(P. 137)**

Interior

51W4-00A

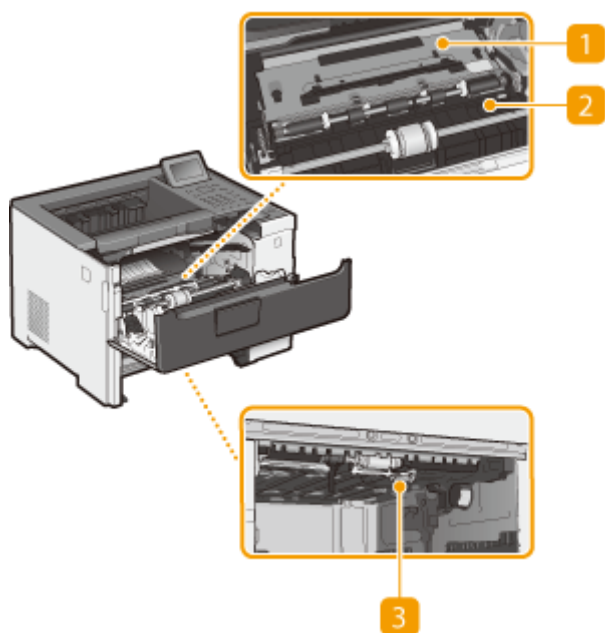

1 Transport guide (at the back)

If there is a paper jam inside the machine, raise the transport guide toward the front of the machine to remove the jammed paper. For more information, see "Troubleshooting (FAQ)" on the online manual website.

2 Transport guide (at the front)

If there is a paper jam inside the machine, raise the transport guide toward the back of the machine to remove the jammed paper. For more information, see "Troubleshooting (FAQ)" on the online manual website.

3 Duplex transport guide

If paper has jammed during 2-sided printing, lower the duplex transport guide to remove the jammed paper. For more information, see "Troubleshooting (FAQ)" on the online manual website.

Multi-Purpose Tray

51W4-00C

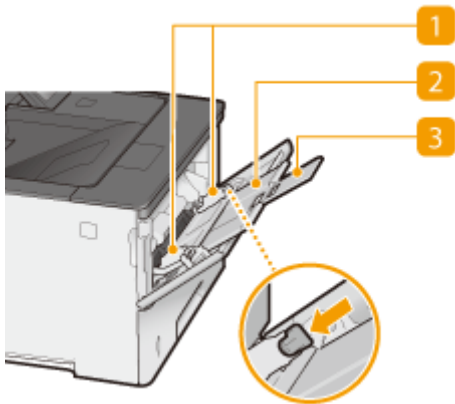

1 Paper guides

Adjust the paper guides to exactly the width of the loaded paper to ensure that paper is fed straight into the machine. Press the lock release lever that is marked with arrow in the illustration to release the lock and slide the paper guides.

2 Paper tray

Pull out the paper tray when loading paper.

3 Tray extension

Open the tray extension when loading large paper.

LINKS

▶ **Loading Paper in the Multi-Purpose Tray(P. 46)**

Paper Drawer

51W4-00E

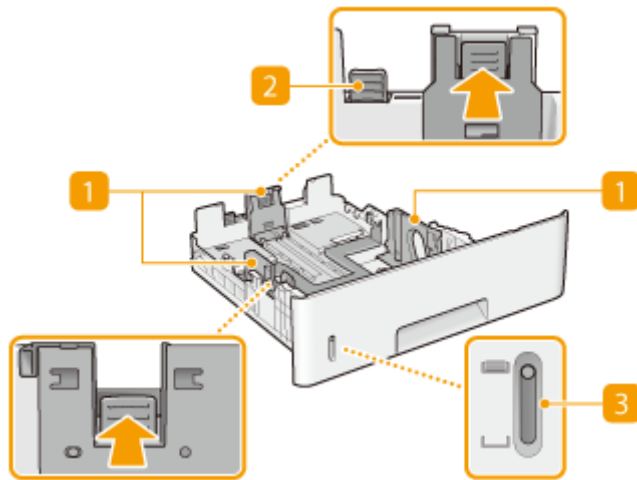

1 Paper guides

Adjust the paper guides to exactly the size of the loaded paper to ensure that paper is fed straight into the machine. Press the lock release levers that are marked with arrows in the illustrations to release the locks and slide the paper guides.

2 Lock release lever (for extending the paper drawer)

When loading Legal size paper, the paper drawer needs to be extended. Press this lever to release the lock and extend the length of the paper drawer.

3 Paper level indicator

Indicates the remaining amount of paper. The mark moves downward as the remaining amount of paper decreases.

LINKS

▶ [Loading Paper in the Paper Drawer\(P. 41\)](#)

Operation Panel

51W4-00F

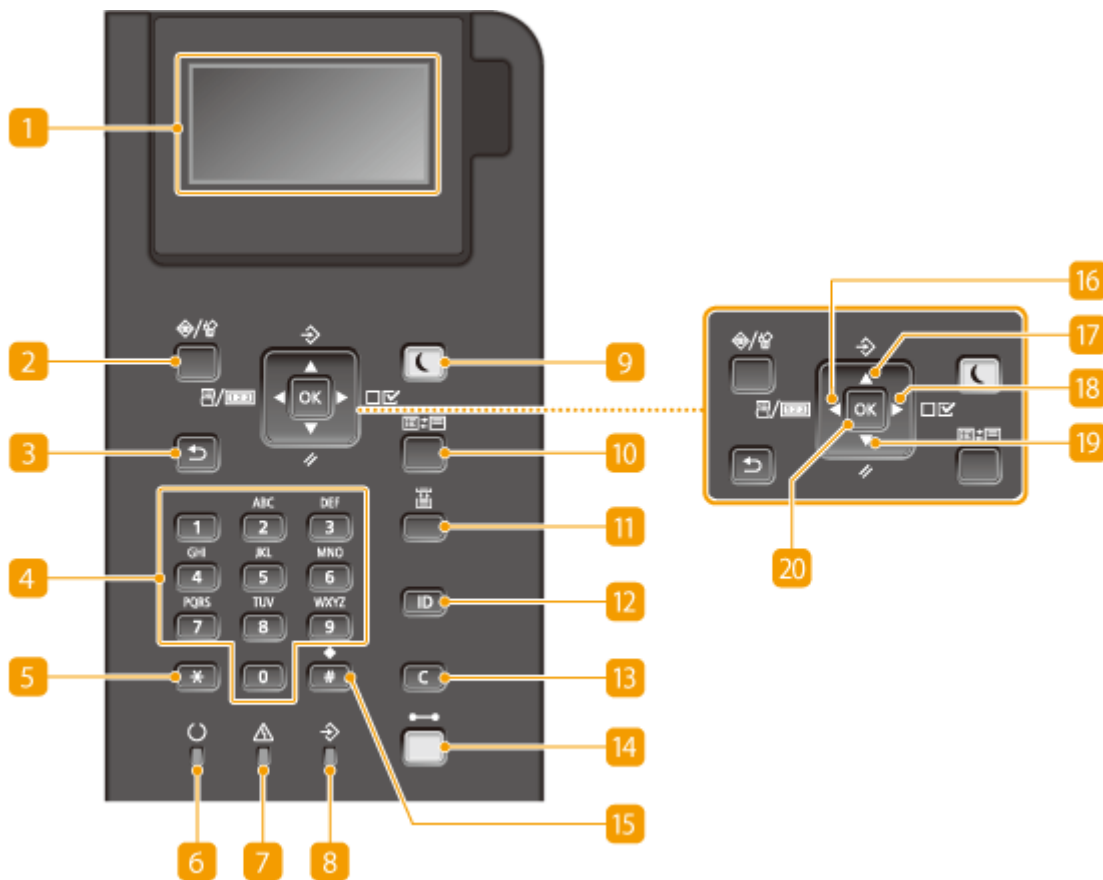

1 Display

Displays the current printing or other operation status, error information, toner cartridge status, etc. ▶ **Display(P. 28)**

2 Job Status/Cancel key

If you press this key when the [↔] indicator is lit or blinking, a document being printed and documents waiting to be printed are listed. You can select the document from the list and cancel printing of the document. ▶ **From the Operation Panel(P. 74)**

3 Back key

Press to return to the previous screen. If you press this key when specifying settings, for example, the settings are not applied and the display returns to the previous screen.

4 Numeric keys ([0]-[9] keys)

Press to enter numbers and text. ▶ **Entering Text(P. 33)**

5 [*] key

Press to switch the type of text that is entered.

6 Ready indicator

Lights up when the machine is ready for printing or otherwise blinks.

7 Message indicator

- Lights up when a problem occurs to disable printing. For more information, see "Troubleshooting (FAQ)" on the online manual website.
- Lights up if the machine enters sleep mode while being off line.

8 Job indicator

Lights up when the machine is receiving print data or any print data remains in the memory of the machine. Blinks when print data is being processed.

9 Energy Saver key

Press to put the machine into sleep mode. This key lights up in green when the machine is in sleep mode. Press the key again to exit sleep mode. **▶ Entering Sleep Mode(P. 63)**

10 Application key

Each press of this key cycles through the functions in the order of: Print Screen ▶ MEAP1 ▶ MEAP2 ▶ ... ▶ MEAP8 ▶ USB Direct Print ▶ Print Screen. Select the function you want to use. If you press this key without logging on when department ID management is enabled, the authentication screen is displayed.

11 Select Feeder key

Press to select the paper source or specify the paper size. **▶ Select Feeder Menu(P. 410)**

12 [ID] key

Displays the login screen for using the MEAP function. After you finish using the machine, press this key again to log off.

13 Clear key

Press to delete the entered numbers and text.

14 Online key

Switches between online mode (printing jobs are accepted) and offline mode (no printing job is accepted). This key lights up green when the machine is online and goes off when the machine is offline. Usually, keep the machine online, but set it to offline when specifying settings of **▶ User Maintenance(P. 358)** in the setting menu.

NOTE:

- If you do not operate the key for a length of time when the machine is offline and the **▶ Main Screen(P. 28)** is displayed, the machine automatically becomes online. You can select <Auto Reset Time> to change this time value (**▶ Auto Reset Time(P. 313)**).

15 [#] key

Press to enter symbols such as "@" or "/".

16 Utility key/[◀] key

- Displays the Utility menu. You can display the total number of printed pages and print internal system information for checking. **▶Utility Menu(P. 402)**
- When specifying settings, press to return to the previous screen. When entering text, press to move the cursor to the left.

17 Job key/[▲] key

- Displays the Job menu. You can check the print logs. **▶Job Menu(P. 406)**
- When specifying settings, press to select the item immediately above the currently selected item. When changing setting values, press to increase a value.

18 Settings key/[▶] key

- Displays the Setup menu. You can specify settings of the machine. **▶Setup Menu(P. 310)**
- When specifying settings, press to proceed to the next screen. When entering text, press to move the cursor to the right.

19 Reset key/[▼] key

- Displays the Reset menu. You can cancel all processes, delete data in memory, and turn OFF the power. **▶Reset Menu(P. 408)**
- When specifying settings, press to select the item immediately below the currently selected item. When changing setting values, press to decrease a value.

20 [OK] key

Press to apply settings or specified details.

LINKS

▶Using the Operation Panel(P. 30)

Display

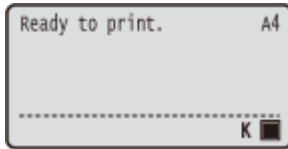

The display shows the printing status and the screens for specifying settings. It also shows error messages and toner cartridge status.

Main Screen

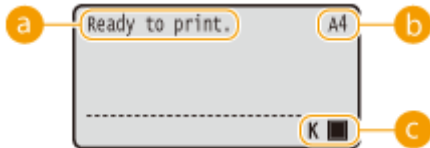

a Status indication

Displays the current status or operation mode of the machine.

b Paper size indication

Displays the currently selected paper size.

NOTE:

The following paper sizes are shown in an abbreviated form.

- Legal: LG
- Letter:LT
- Statement: ST
- Executive: EX
- Foolscap: FC
- Index Card: IC
- Indian Legal: ILG
- Postcard: PD
- Reply Postcard: P2
- 4 on 1 Postcard: P4
- Envelope NAGAGATA 3: N3
- Envelope YOUNGATANAGA 3: YN3
- Envelope No. 10 (COM10): CO
- Envelope Monarch: MO
- Envelope ISO-C5: EC5
- Envelope DL: DL
- Free Size: FR
- Custom Paper Size Landscape: 80
- Custom Paper Size Portrait: 80R

c Toner cartridge status indication

Displays the status of toner cartridges.

Menu Screen

Press ◀ (📄/🔑), ▲ (↶), ▶ (☑), ▼ (⚡), or 🖨️ (🖨️) to display the corresponding menu screen. The screen displayed when ▶ (☑) is pressed is shown below as an example.

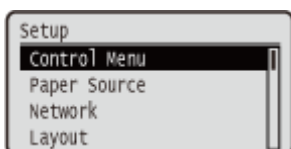

▶ **Setting Menu List(P. 309)**

When an Error Occurs

In some cases when an error occurs, instructions on how to respond to the error are displayed. Follow the on-screen instructions to solve the problem. The screen displayed when a paper jam occurs is shown below as an example. For more information about the displayed messages, see "Troubleshooting (FAQ)" on the online manual website.

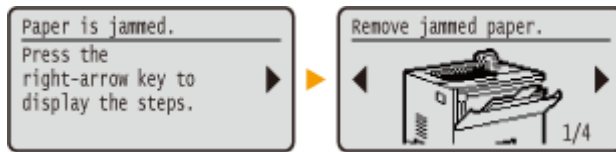

LINKS

▶ **Using the Operation Panel(P. 30)**

Using the Operation Panel

51W4-00J

Use the keys shown below to specify settings and adjust values.



Using ▲ / ▼

■ Scrolling the Screen

The scroll bar is displayed on the right side of the screen when not all of the information fits on one screen. If the scroll bar is displayed, use ▲ / ▼ to scroll up or down. The text and background colors of an item are inverted when it is selected.

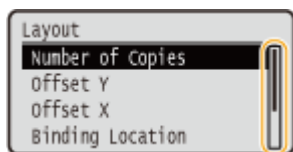

■ Changing a Setting Value

Use ▲ / ▼ to enter values.

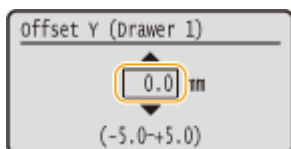

NOTE:

- Values in () displayed below the entry box are the enterable value range.



Using ◀ / ▶

■ Proceeding to the Next Screen/Returning to the Previous Screen

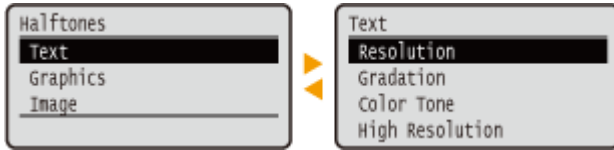
Press ▶ to proceed to the next screen. Press ◀ to return to the previous screen.



NOTE:

- You can also proceed to the next screen by pressing , and return to the previous screen by pressing .

■ Moving the Cursor

Use ◀ / ▶ to enter text and values.  **Entering Text(P. 33)**

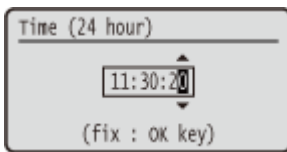

Using

Press  to apply a setting.

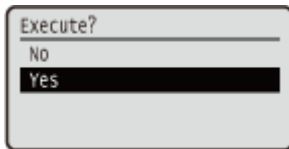

Using (●—●)

To return to the main screen after exiting the setting menu, press  (●—●).



Using the Numeric Keys

Use the numeric keys to enter text and values.  **Entering Text(P. 33)**

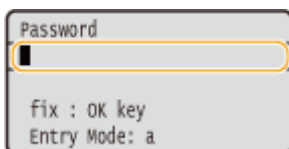

NOTE:

- Depending on the screen, you cannot use the numeric keys to enter values. In that case, enter with ▲ / ▼.

TIPS

- You can specify a variety of display-related settings, such as the screen adjustment and display language, by using <Control Menu> in the setting menu of the operation panel. ▶ **Control Menu(P. 311)**

Entering Text

51W4-00K

Use the numeric keys to enter text and values.



Switching the Type of Text

Press ***** to switch the type of text that is entered.

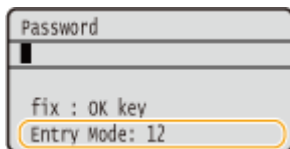

Types of Text That Can Be Entered

Text that can be entered is listed below.

Key	A	a	12
1	(Not available)		1
2	ABC	abc	2
3	DEF	def	3
4	GHI	ghi	4
5	JKL	jkl	5
6	MNO	mno	6

	PQRS	pqrs	7
	TUV	tuv	8
	WXYZ	wxyz	9
	(Not available)		0
	(space) @./-!_?&\$%#()[]{}<>*+=";:'^` \		(Not available)

NOTE

- Press when the type of text that is entered is <A> or <a> to display enterable symbols in the screen. Use / / / to select the symbol you want to enter, and press .

Deleting Text

One character is deleted each time is pressed. Press and hold to delete all of the entered text.

Moving the Cursor

Press or to move the cursor.

Entering a Space

Press , and press .

Example of Entering Text and Numbers

Example: "Canon 1"

- 1 Press repeatedly until <A> is selected.
- 2 Press repeatedly until the letter "C" is selected.
- 3 Press repeatedly until <a> is selected.
- 4 Press repeatedly until the letter "a" is selected.
- 5 Press repeatedly until the letter "n" is selected.
- 6 Press repeatedly until the letter "o" is selected.
- 7 Press repeatedly until the letter "n" is selected.
- 8 Press , and press .
- 9 Press repeatedly until <12> is selected.
- 10 Press .
- 11 Press .

Turning ON/OFF the Power

51W4-00L

The power switch is used to turn ON the machine. However, when turning OFF the machine, be sure to shut down the machine from the operation panel without using the power switch. This procedure is the same as that for turning ON/OFF a computer.

▶ **Turning ON the Power(P. 35)**

▶ **Turning OFF the Power (Performing a Shutdown)(P. 35)**

Turning ON the Power

Press the power switch of the machine. When the main screen appears on the display of the operation panel after self-diagnosis is performed, the machine is ready for printing.

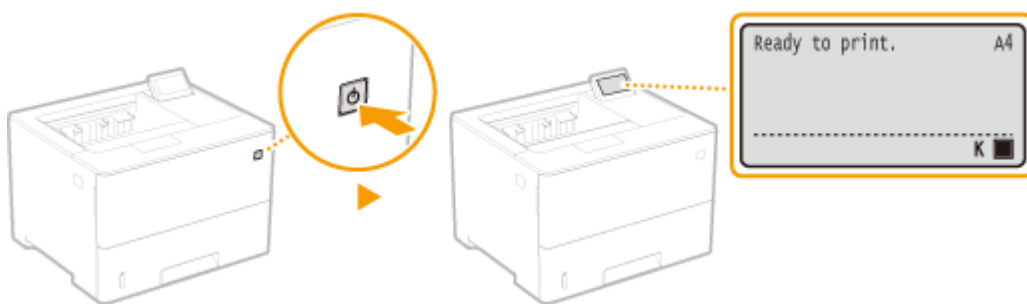

NOTE

- A message may be displayed after the self-diagnosis. For more information, see "Troubleshooting (FAQ)" on the online manual website.
- If you specify the quick startup settings, you can reduce a waiting time after the power is turned on. ▶ **Performing a Quick Start of the Machine(P. 37)**

Turning OFF the Power (Performing a Shutdown)

When turning OFF the machine, shut down the machine from the operation panel.

IMPORTANT

Performing a Shutdown without Using the Power Switch

- If you press the power switch to turn OFF the power, an unexpected error may occur. Follow the procedure below to properly turn OFF the power.

NOTE

- If you have enabled the quick start function, you can press the power switch to turn OFF the power. ▶ **Performing a Quick Start of the Machine(P. 37)**

1 Press ▼ (//).

2 Use ▲ / ▼ to select <Shut Down>, and press .



3 Select <Yes>, and press .

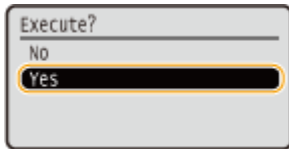

⇒ After the message below appears, the power is automatically turned OFF.



IMPORTANT:

When <Could not execute.> appears

- There is remaining print data. Delete the data ( **Reset Menu(P. 408)**), and retry the operation. To cancel the operation, press  ( — ).

NOTE:

- It may take some time for the machine to completely shut down. Do not unplug the power cord until the display turns off.

NOTE

Do not turn ON the power immediately after turning OFF the power

- Wait for 10 seconds or more, and then turn ON the power.

Power consumption after power OFF

- The machine slightly consumes power even after the power is turned OFF. To completely eliminate power consumption, unplug the power plug from the AC power outlet.

LINKS

 **Performing a Quick Start of the Machine(P. 37)**

Performing a Quick Start of the Machine

51W4-00R

If you specify the quick startup settings, you can reduce the time from when the power switch is pressed until the screens become operable. The way of turning OFF the power to perform a quick start of the machine is called "quick turn-OFF."

- ▶ **Configuring Quick Startup Settings(P. 37)**
- ▶ **Turning OFF the Power (Performing a Quick Turn-OFF)(P. 38)**

NOTE

When you are using a network

- If any of the settings below is <On>, the quick start function is disabled.
 - RARP, BOOTP, IPv6 ▶ **Network(P. 134)**
 - IPSec ▶ **Configuring IPSec Settings(P. 251)**

When you are using the MEAP function

- Check whether the currently installed MEAP applications support the quick start function.

Configuring Quick Startup Settings

- 1** Press **▶** ().
- 2** Use **▲ / ▼** to select <Control Menu>, and press **OK**.
- 3** Select <Main Pwr Quick Start>, and press **OK**.
- 4** Select <Off> or <On>, and press **OK**.



- a** <Off>
Disables the Quick Start function.
- b** <On>
Enables the Quick Start function.

- 5** Perform a hard reset. ▶ **Performing a Hard Reset(P. 408)**

⇒ The settings are enabled after the hard reset is performed.

Turning OFF the Power (Performing a Quick Turn-OFF)

If you press the power switch to turn OFF the power when the quick start function is enabled, a quick start of the machine is performed when the machine is turned ON next time (quick turn-OFF).

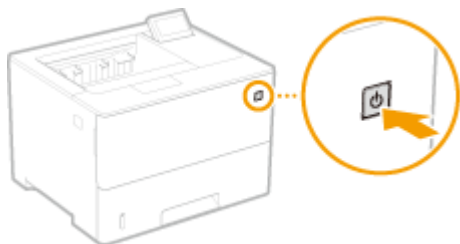

IMPORTANT

Do not unplug the power plug from the AC power outlet after performing a quick turn-OFF

- Do not unplug the power plug from the AC power outlet after turning OFF the power by performing a quick turn-OFF. Doing so may damage the internal components of the machine. Before you unplug the power plug when relocating the machine, turn ON the power, and then perform a shutdown. **▶Turning OFF the Power (Performing a Shutdown)(P. 35)**

NOTE

- When the machine is performing a job or is in an error state or after you change any setting using the operation panel or Remote UI, pressing the power switch does not trigger a quick turn-OFF, but triggers a shutdown instead.
- If the power is turned OFF by a shutdown operation even when the quick start function is enabled, the machine starts as usual when it is turned ON next time.
- If you perform the auto shutdown timer function when the quick start function is enabled, a quick turn-OFF is performed. **▶Setting Auto Shutdown Time(P. 65)**
- If you turn ON the power immediately after performing a quick turn-OFF, it may take some time for the machine to start up.

Loading Paper

51W4-00S

You can load paper into the paper drawer and multi-purpose tray. Load the paper you usually use into the paper drawer. The paper drawer is convenient when using large amounts of paper. Use the multi-purpose tray when you temporarily use size or type of paper that is not loaded in the paper drawer. See **Available Paper(P. 470)** for available paper sizes and types.

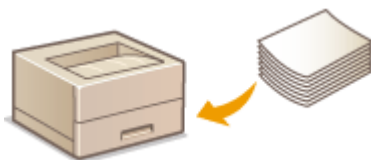

About Paper

- ▶ **Precautions for Paper(P. 39)**
- ▶ **Storing the Paper Printed with the Machine(P. 40)**

How to Load Paper

- ▶ **Loading Paper in the Paper Drawer(P. 41)**
- ▶ **Loading Paper in the Multi-Purpose Tray(P. 46)**
- ▶ **Loading Envelopes or Postcards(P. 49)**
- ▶ **Loading Preprinted Paper(P. 53)**

Configuring the Settings for the Loaded Paper

- ▶ **Specifying Paper Size and Type(P. 57)**

Precautions for Paper

IMPORTANT

Do not use the following types of paper:

- A paper jam or printing error may occur.
 - Wrinkled or creased paper
 - Curled or rolled paper
 - Torn paper
 - Damp paper
 - Very thin paper
 - Thin coarse paper
 - Paper printed by a thermal transfer printer
 - Back side of paper printed by a thermal transfer printer
 - Highly textured paper
 - Glossy paper

Notes on use of paper

- Only use paper that has fully acclimatized to the environment in which the machine is installed. Using paper that has been stored under different temperature or humidity conditions may cause paper jams or result in poor print quality.

Paper handling and storage

- It is recommended that you use paper as soon as possible after unwrapping. Paper remaining unused should be covered with the original wrapping paper and stored on a flat surface.
- Keep the paper wrapped in its original package to protect the paper from moisture or dryness.
- Do not store the paper in such a way that may cause it to curl or fold.
- Do not store the paper vertically or do not stack too much paper.
- Do not store the paper in direct sunlight, or in a place subject to high humidity, dryness, or drastic changes in temperature or humidity.

NOTE

When printing on paper that has absorbed moisture

- Steam may emit from the paper output area, or water droplets may form on and around the paper output area. There is nothing unusual about any of these occurrences, which occur when the heat generated from fixing toner on the paper causes moisture in the paper to evaporate (most likely to occur at low room temperatures).

Storing the Paper Printed with the Machine

When handling/storing the paper printed with the machine, take the following precautions.

■ How to Store the Printed Paper

- Store on a flat surface.
- Do not store together with articles made of PVC (polyvinyl chloride) such as clear folders. Toner may melt, resulting in the paper's sticking to PVC articles.
- Take care that the paper does not get folded or creased. Toner may peel off.
- To store over a long period of time (two years or longer), store in binders or equivalent.
- When the paper is stored over a long period of time, it may become discolored and thus the print may seem to have undergone a change of color.
- Do not store in a place where the temperature is high.

■ Precautions When Applying Adhesive

- Always use insoluble adhesive.
- Before applying adhesive, perform a test using a printout no longer required.
- When putting adhesive-applied paper sheets one over another, make sure that the adhesive is completely dried out.

Loading Paper in the Paper Drawer

51W4-00U



Load the paper that you usually use in the paper drawer. When you want to print on paper that is not loaded in the paper drawer, load the paper in the multi-purpose tray. **Loading Paper in the Multi-Purpose Tray(P. 46)**

Loading Standard Size Paper(P. 41)

Loading a Custom Size Paper(P. 43)

Paper Orientation

See the table below to load available paper in correct orientation.

Paper	Orientation
A4, B5, A5 (portrait), A6, Legal, Letter, Statement, Executive, Foolscap, 16K, Indian Legal, Custom (portrait)	
A5 (landscape), Custom (landscape)	

NOTE

- Follow the procedure below when loading paper into the optional paper feeder.

Loading Standard Size Paper

To load paper whose size is found in the paper size markings on the paper drawer, use the following procedure. For paper whose size is not found in the paper size markings, see **Loading a Custom Size Paper(P. 43)** .

1 Pull out the paper drawer until it stops, and remove it while lifting the front side.

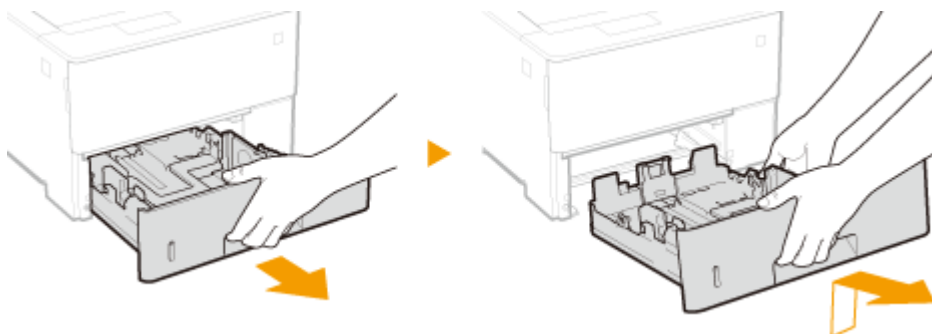

2 Adjust the positions of the paper guides to the paper size you want to use.

- Press the lock release lever (**a**) to align the projection (**b**) to the appropriate paper size marking.

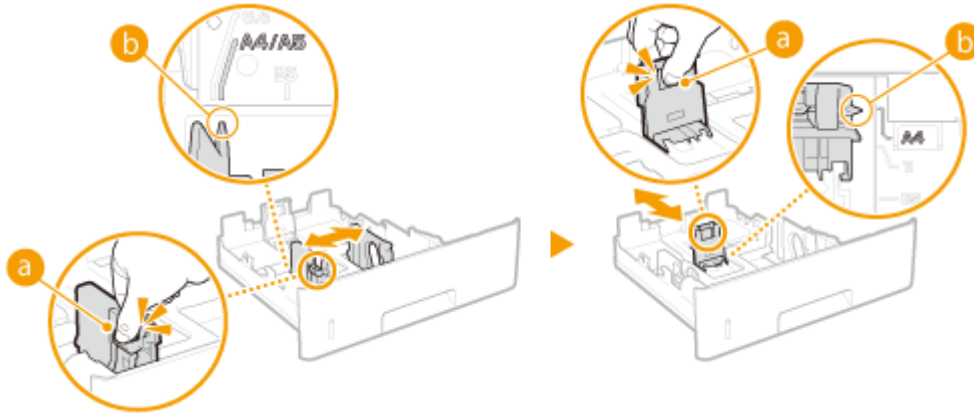

NOTE:

When loading Legal size paper

- Press the lock release lever, and extend the paper drawer.

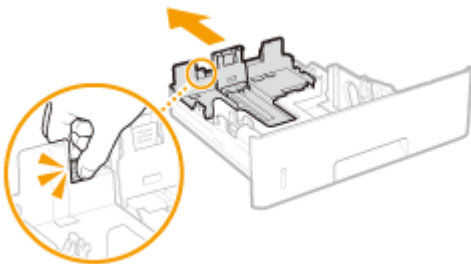

3 Load the paper so that the edge of the paper stack is aligned against the paper guide on the rear side of the paper drawer.

- Insert the paper with the print side face down.
- Fan the paper stack well, and tap it on a flat surface to align the edges.

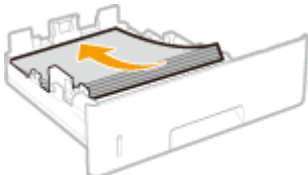

IMPORTANT:

Do not exceed the load limit line when loading paper

- Make sure that the paper stack does not exceed the load limit line (a). Loading too much paper can cause paper jams.

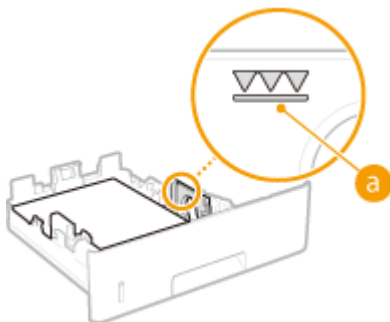

NOTE:

- When loading paper with a logo, see **▶ Loading Preprinted Paper(P. 53)** .

4 Set the paper drawer.

» Continue to **▶ Specifying Paper Size and Type in the Paper Drawer(P. 58)**

IMPORTANT:

When changing the paper size or type

- When you have changed the paper size or paper type, always check the setting. If the loaded paper and the configured paper settings do not match, printing is not performed properly.

NOTE

- To print from an OS not supporting printer drivers or from a mobile device or other device not supporting paper size and type settings, specify <Standard Paper Size> and <Default Paper Type>. **▶ Select Feeder Menu(P. 410)**

Printing on the Back Side of Printed Paper (Manual 2-Sided Printing)

You can print on the back side of printed paper. Flatten any curls on the printed paper and insert it into the multi-purpose tray (**▶ Loading Paper in the Multi-Purpose Tray(P. 46)**), with the side to print face up (previously printed side face down).

- When you want to print on the back side of the paper that is already printed, set <Manual 2-Sided (MP)> to <2nd Side> in the setting menu of the operation panel. **▶ Manual 2-Sided (MP)(P. 415)**
- Load one sheet of paper each time you print.
- You can use only the paper printed with this machine.
- You cannot print on the side that has previously been printed on.

Loading a Custom Size Paper

To load custom size paper or other paper whose size is not found in the paper size markings on the paper drawer, use the following procedure.

1 Pull out the paper drawer until it stops, and remove it while lifting the front side.

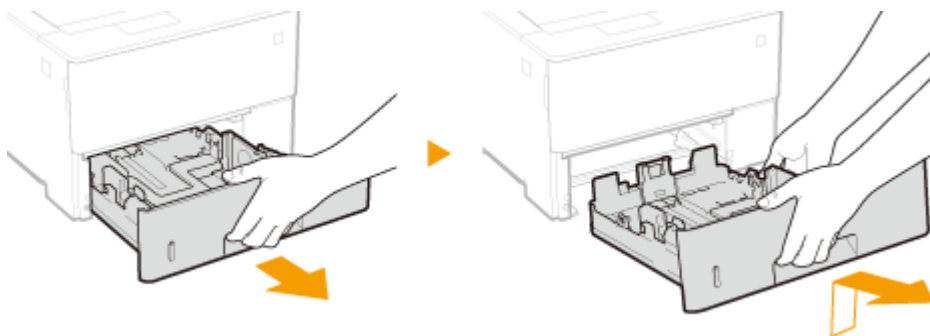

2 Slide the paper guides apart.

- Press the lock release lever to slide the paper guides outward.

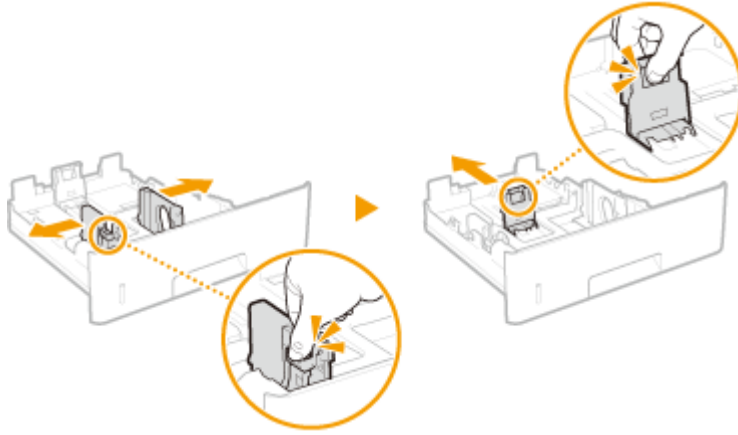

NOTE:

When loading paper that is longer than A4

- Press the lock release lever, and extend the paper drawer.

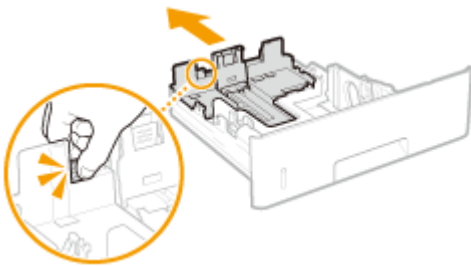

3 Load the paper so that the edge of the paper stack is aligned against the front side of the paper drawer.

- Place the paper stack with the print side face down.
- Fan the paper stack well, and tap it on a flat surface to align the edges.

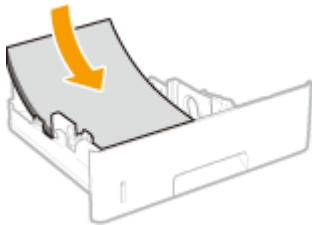

IMPORTANT:

Do not exceed the load limit line when loading paper

- Make sure that the paper stack does not exceed the load limit line (a). Loading too much paper can cause paper jams.

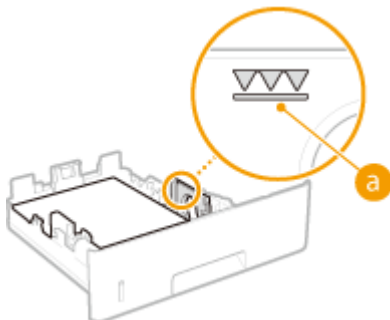

NOTE:

- When loading paper with a logo, see **▶ Loading Preprinted Paper(P. 53)** .

4 Align the paper guides against the edges of the paper.

- Press the lock release lever and slide the paper guides inward until they are aligned securely against the edges of the paper.

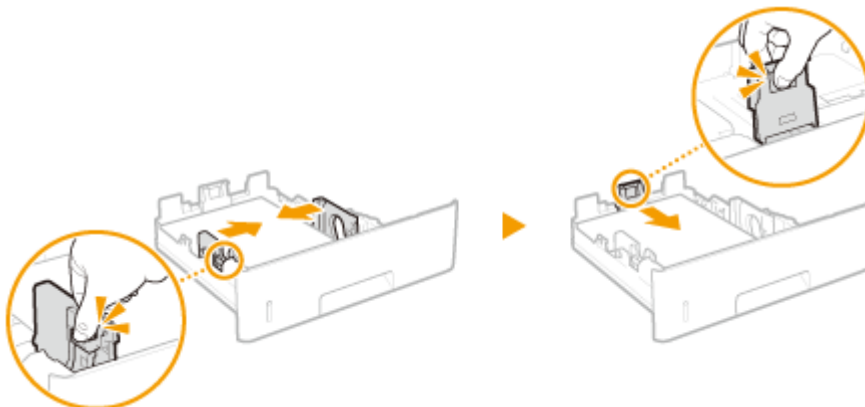

IMPORTANT:

Align the paper guides securely against the edges of the paper

- Paper guides that are too loose or too tight can cause misfeeds or paper jams.

5 Insert the paper drawer into the machine.

» Continue to [▶Specifying Paper Size and Type in the Paper Drawer\(P. 58\)](#)

IMPORTANT:

When changing the paper size or type

- When you have changed the paper size or paper type, always check the setting. If the loaded paper and the configured paper settings do not match, printing is not performed properly.

NOTE

- To print from an OS not supporting printer drivers or from a mobile device or other device not supporting paper size and type settings, specify <Standard Paper Size> and <Default Paper Type>. [▶Select Feeder Menu\(P. 410\)](#)

Printing on the Back Side of Printed Paper (Manual 2-Sided Printing)

You can print on the back side of printed paper. Flatten any curls on the printed paper and insert it into the multi-purpose tray ([▶Loading Paper in the Multi-Purpose Tray\(P. 46\)](#)), with the side to print face up (previously printed side face down).

- When you want to print on the back side of the paper that is already printed, set <Manual 2-Sided (MP)> to <2nd Side> in the setting menu of the operation panel. [▶Manual 2-Sided \(MP\)\(P. 415\)](#)
- Load one sheet of paper each time you print.
- You can use only the paper printed with this machine.
- You cannot print on the side that has previously been printed on.

LINKS

[▶Available Paper\(P. 470\)](#)



Loading Paper in the Multi-Purpose Tray

51W4-00W

When you want to print on paper that is not loaded in the paper drawer, load the paper in the multi-purpose tray. Load the paper that you usually use in the paper drawer. **Loading Paper in the Paper Drawer(P. 41)**

Paper Orientation

See the table below to load available paper in correct orientation.

Paper	Orientation
A4, B5, A5 (portrait), A6, Legal, Letter, Statement, Executive, Foolscap, 16K, Index Card, Indian Legal, Custom (portrait), Postcard, Reply Postcard, 4 on 1 Postcard, Envelope	
A5 (landscape), Custom (landscape)	

1 Open the cover.

- Hold the left and right side handles, and open the cover.

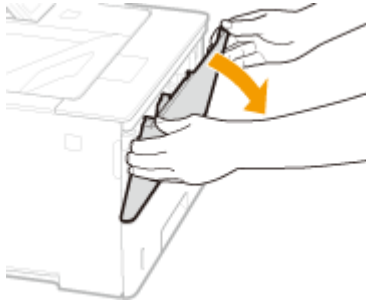

2 Pull out the paper tray and the tray extension.

- Pull out the tray extension when loading large paper.

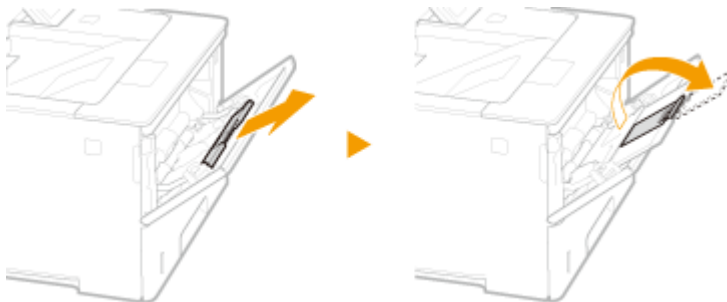

3 Spread the paper guides apart.

- Press the lock release lever to slide the paper guides outward.

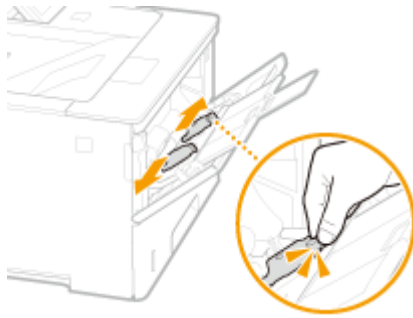

4 Insert the paper into the multi-purpose tray until the paper stops.

- Insert the paper with the print side face up.
- Fan the paper stack well, and tap it on a flat surface to align the edges.

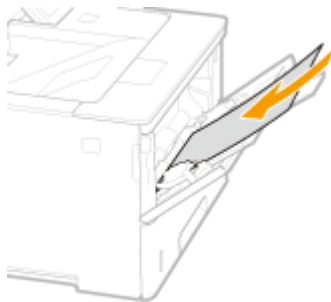

IMPORTANT:

Do not exceed the load limit guide when loading paper

- Make sure that the paper stack does not exceed the load limit guide (a). Loading too much paper can cause paper jams.

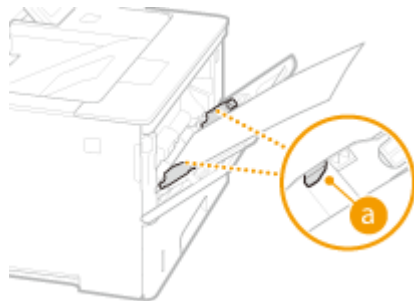

NOTE:

- When loading envelopes or paper with a logo, see ▶ Loading Envelopes or Postcards(P. 49) or ▶ Loading Preprinted Paper(P. 53) .

5 Align the paper guides against the edges of the paper.

- Press the lock release lever and slide the paper guides inward until they are aligned securely against the edges of the paper.

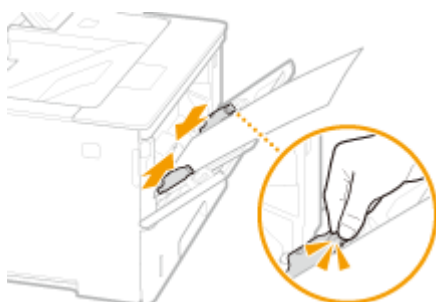

IMPORTANT:**Align the paper guides securely against the edges of the paper**

- Paper guides that are too loose or too tight can cause misfeeds or paper jams.

» Continue to **▶ Specifying Paper Size and Type in the Multi-Purpose Tray(P. 60)**

IMPORTANT:**When changing the paper size or type**

- When you have changed the paper size or paper type, always check the setting. If the loaded paper and the configured paper settings do not match, printing is not performed properly.

NOTE

- To print from an OS not supporting printer drivers or from a mobile device or other device not supporting paper size and type settings, specify <Standard Paper Size> and <Default Paper Type>. **▶ Select Feeder Menu(P. 410)**

Printing on the Back Side of Printed Paper (Manual 2-Sided Printing)

You can print on the back side of printed paper. Flatten any curls on the printed paper and insert it into the multi-purpose tray, with the side to print face up (previously printed side face down).

- When you want to print on the back side of the paper that is already printed, set <Manual 2-Sided (MP)> to <2nd Side> in the setting menu of the operation panel. **▶ Manual 2-Sided (MP)(P. 415)**
- Load one sheet of paper each time you print.
- You can use only the paper printed with this machine.
- You cannot print on the side that has previously been printed on.

LINKS

- **▶ Available Paper(P. 470)**

Loading Envelopes or Postcards

51W4-00X

Before loading envelopes or postcards, make some preparations such as flattening any curls on them. Also pay attention to the orientation of envelopes or postcards and which side is face up. Note that neither envelopes nor postcards can be loaded in the paper drawer.

▶ **Loading Envelopes(P. 49)**

▶ **Loading Postcards(P. 51)**

NOTE

- This section describes how to load envelopes in the orientation you want, as well as procedures that you need to complete before loading envelopes or postcards. For the general procedure for loading envelopes or postcards in the multi-purpose, see ▶ **Loading Paper in the Multi-Purpose Tray(P. 46)** .

Loading Envelopes

■ Before Loading Envelopes

Follow the procedure below to prepare the envelopes before loading.

1 Close the flap of each envelope.



2 Flatten them to release any remaining air, and make sure that the edges are pressed tightly.



3 Loosen any stiff corners of the envelopes and flatten any curls.

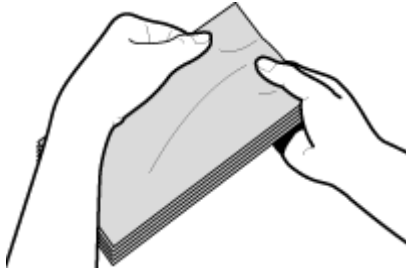

4 Align the edges of the envelope on a flat surface.

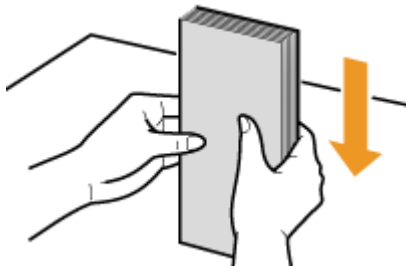

■ **Loading Envelopes in the Multi-Purpose Tray**

Load the envelopes in portrait orientation (with the short edge toward the machine), with the non-glued side (front side) face down. You cannot print on the reverse side of envelopes.

Envelopes YUGATANAGA 3, ISO-C5, Monarch, No. 10 (COM10), or DL

Load the envelope so that the edge with the flap is toward the left side as shown in the illustration.

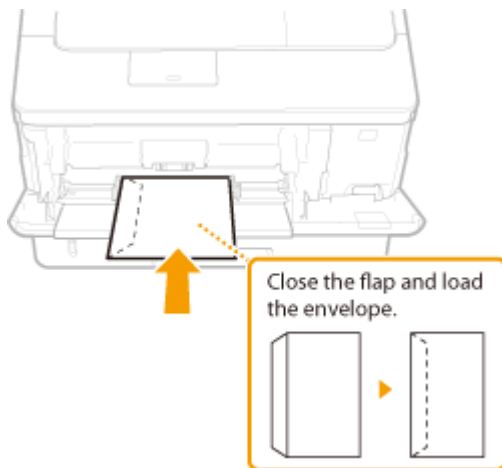

Envelope NAGAGATA 3

Insert the envelope with the flap toward you.

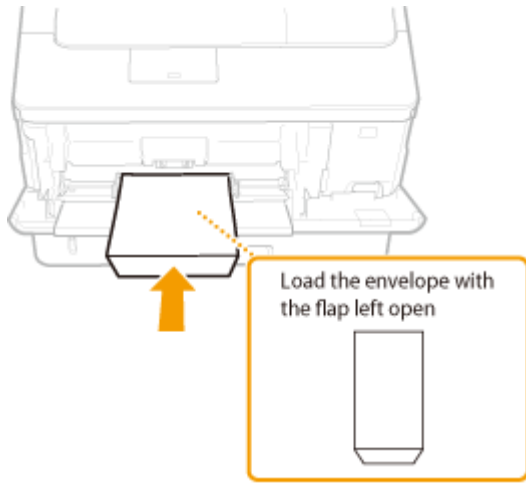

Loading Postcards

IMPORTANT

- For postcards, automatic 2-sided printing is impossible. If you want to print on both sides of the postcard, first print on one side and then print on the other side.
- Before loading the postcards, flatten any curls on them. With curls remaining, printouts may be skewed or images may be printed distorted.

■ Loading Postcards in the Multi-Purpose Tray

Insert the postcard with the print side face up and with the short edge toward the machine if the type of postcard is regular or 4-on-1 or the long edge toward the machine if the type of postcard is reply.

Postcard

Insert the postcard with the upper end toward the machine.

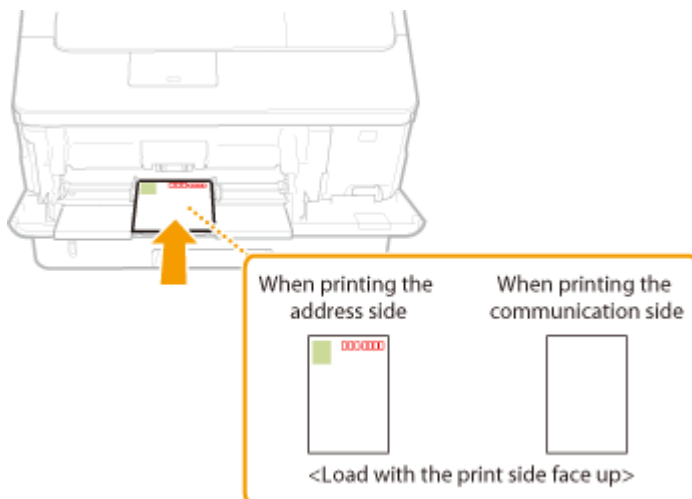

Reply Postcard

Unfold the postcard and insert it with the upper end toward the machine.

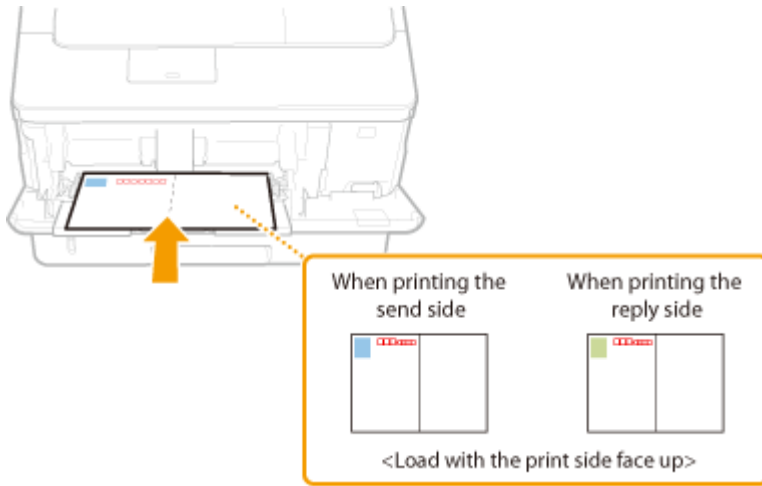

4 on 1 Postcard

Insert the postcard with the upper end toward the machine.

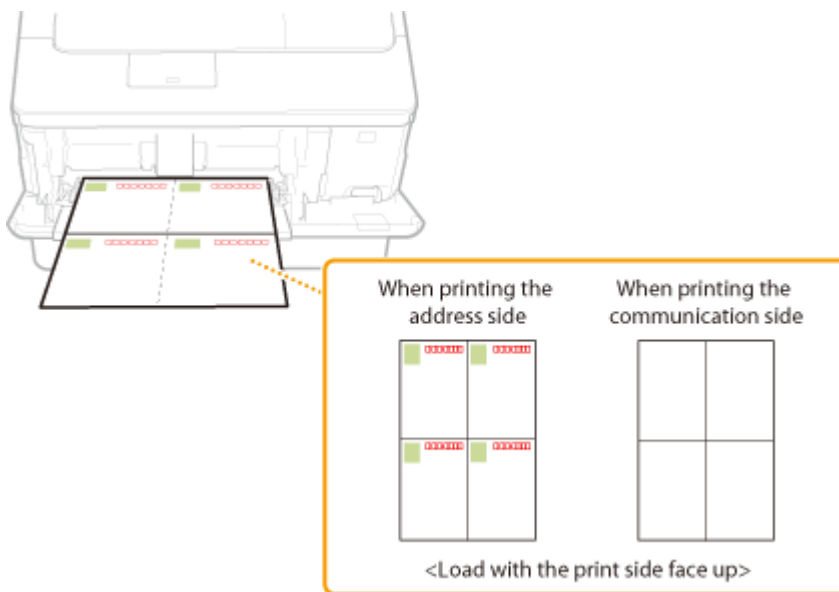

Loading Preprinted Paper

51W4-00Y

When you use paper that has been preprinted with a logo, pay attention to the orientation of the paper when loading. Load the paper properly so that printing is performed on the correct side of the paper with a logo.



▶ **Making 1-Sided Printouts on Paper with Logos(P. 53)**

▶ **Making 2-Sided Printouts on Paper with Logos(P. 55)**

NOTE

- This section mainly describes how to load preprinted paper with the proper facing and orientation. For the general procedure for loading paper in the paper drawer or multi-purpose tray, see the following.
 - ▶ **Loading Paper in the Paper Drawer(P. 41)**
 - ▶ **Loading Paper in the Multi-Purpose Tray(P. 46)**

Making 1-Sided Printouts on Paper with Logos

Printing on Paper with Logos in Portrait Orientation

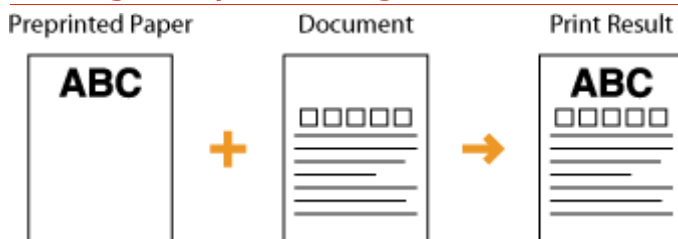

When loading paper in the paper drawer

Load the paper with the logo side (the side to print the document) face down.

Loading Orientation

Portrait



Landscape



When loading paper in the multi-purpose tray

Load the paper with the logo side (the side to print the document) face up.

Loading Orientation

Portrait

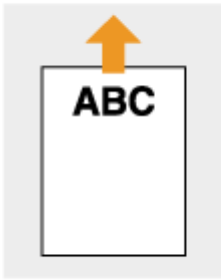

Landscape

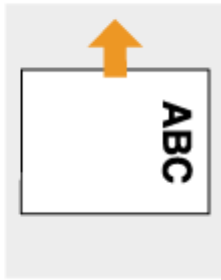

Printing on Paper with Logos in Landscape Orientation

Preprinted Paper

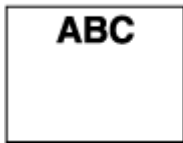

+

Document



→

Print Result



When loading paper in the paper drawer

Load the paper with the logo side (the side to print the document) face down.

Loading Orientation

Portrait



Landscape



When loading paper in the multi-purpose tray

Load the paper with the logo side (the side to print the document) face up.

Loading Orientation

Portrait

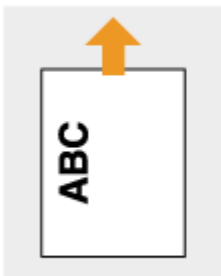

Landscape

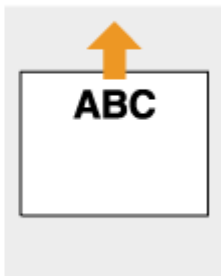

Making 2-Sided Printouts on Paper with Logos

When a document to print consists of an odd number of pages, set <Alternative Method> to <Off> in the setting menu of the operation panel. **Alternative Method(P. 350)**

Printing on Paper with Logos in Portrait Orientation

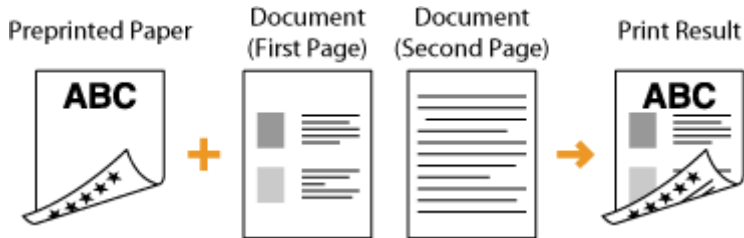

When loading paper in the paper drawer

Load the paper with the front logo side (the side to print the first page of the document) face up.

Loading Orientation

Portrait



Landscape

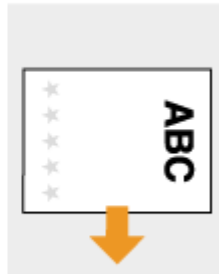

When loading paper in the multi-purpose tray

Load the paper with the front logo side (the side to print the first page of the document) face down.

Loading Orientation

Portrait



Landscape



Printing on Paper with Logos in Landscape Orientation



When loading paper in the paper drawer

Load the paper with the front logo side (the side to print the first page of the document) face up.

Loading Orientation

Portrait



Landscape



When loading paper in the multi-purpose tray

Load the paper with the front logo side (the side to print the first page of the document) face down.

Loading Orientation

Portrait

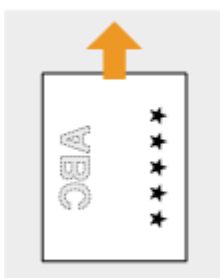

Landscape



NOTE

The <Paper Feed Method> setting

- When you print on preprinted paper, you need to change the facing of the paper to load each time you switch between 1-sided and 2-sided printing. However, if <Paper Feed Method> is set to <Print Side Priority>, the facing that you use for loading preprinted paper for 2-sided printing (logo side face up for paper drawer or down for multi-purpose tray) can also be used for 1-sided printing. This setting is especially useful if you frequently perform both 1-sided and 2-sided printing. [▶ Paper Feed Method\(P. 366\)](#)

Specifying Paper Size and Type

51W4-010

You must specify the paper size and type settings to match the paper that is loaded. Make sure to change the paper settings when you load the paper that is different from the previously loaded paper.

IMPORTANT



- If the setting does not match the size and type of loaded paper, a paper jam or printing error may occur.

Specifying Paper Size and Type in the Paper Drawer

51W4-011

Specify the paper size and type as necessary depending on the paper you load in the paper drawer.

1 Press  ().

2 Use  /  to select one of <Drawer 1 Paper Size> to <Drawer 4 Paper Size>, and press .

- <Drawer 2 Paper Size> to <Drawer 4 Paper Size> are displayed when the optional paper feeder is installed.

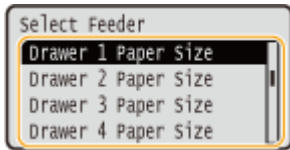



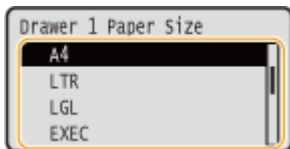





3 Select the paper size, and press .



NOTE:

For A5 size/custom size paper

- A5 size or custom size paper can be loaded in either portrait or landscape orientation. See the table below to select the setting according to the orientation of the paper.

Paper size	Orientation	Setting
A5	 *1	<  A5R >
		<  A5 >
Custom size paper	 *2	<  Custom Size R >
		<  Custom Size >

*1When using the Canon Generic Plus UFR II printer driver, select the [Feed Standard Paper Sizes Vertically] check box in the [Paper Source] tab before printing.

*2When using the Canon Generic Plus UFR II printer driver, select the [Feed Custom Paper Vertically] check box in the [Paper Source] tab before printing.

About <Free Size>

- If you frequently change sizes of paper to load, you can specify <Free Size>, which saves you the trouble of changing the paper size setting each time you print. However, take note that this setting lets the machine

print even if there is mismatch between the paper size setting in the printer driver and the paper size actually loaded in the machine.

- If you select <Free Size>, the print speed will be slower.

4 Select one of <Drawer 1 Paper Type> to <Drawer 4 Paper Type>, and press .

- <Drawer 2 Paper Type> to <Drawer 4 Paper Type> are displayed when the optional paper feeder is installed.

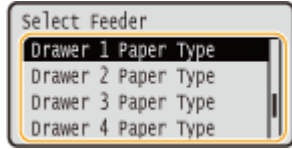

5 Select the paper type, and press .

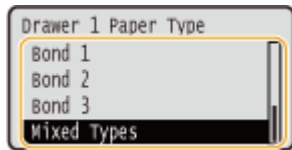

About <Mixed Types>

- If you frequently change sizes of paper to load, you can specify <Mixed Types>, which saves you the trouble of changing the paper type setting each time you print. However, take note that this setting lets the machine print even if there is mismatch between the paper type setting in the printer driver and the paper type actually loaded in the machine.

LINKS

- ▶ [Loading Paper in the Paper Drawer\(P. 41\)](#)
- ▶ [Available Paper\(P. 470\)](#)

Specifying Paper Size and Type in the Multi-Purpose Tray

51W4-012

1 Press  ().

2 Use  /  to select <MP Tray Paper Size>, and press  .

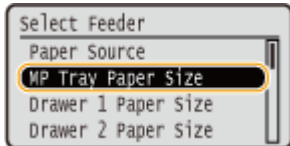



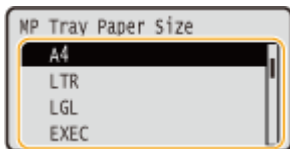





3 Select the paper size, and press  .



NOTE:

For A5 size/custom size paper

- A5 size or custom size paper can be loaded in either portrait or landscape orientation. See the table below to select the setting according to the orientation of the paper.

Paper size	Orientation	Setting
A5	 *1	<  A5R >
		<  A5 >
Custom size paper	 *2	<  Custom Size R >
		<  Custom Size >

*1When using the Canon Generic Plus UFR II printer driver, select the [Feed Standard Paper Sizes Vertically] check box in the [Paper Source] tab before printing.

*2When using the Canon Generic Plus UFR II printer driver, select the [Feed Custom Paper Vertically] check box in the [Paper Source] tab before printing.

About <Free Size>

- If you frequently change sizes of paper to load, you can specify <Free Size>, which saves you the trouble of changing the paper size setting each time you print. However, take note that this setting lets the machine print even if there is mismatch between the paper size setting in the printer driver and the paper size actually loaded in the machine.

- If you select <Free Size>, the print speed will be slower.

4 Select <MP Tray Paper Type>, and press .

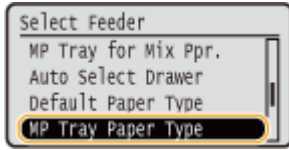

5 Select the paper type, and press .

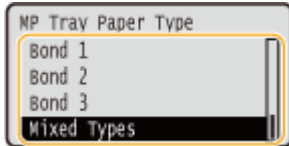

About <Mixed Types>

- If you frequently change sizes of paper to load, you can specify <Mixed Types>, which saves you the trouble of changing the paper type setting each time you print. However, take note that this setting lets the machine print even if there is mismatch between the paper type setting in the printer driver and the paper type actually loaded in the machine.

LINKS

- ▶ [Loading Paper in the Multi-Purpose Tray\(P. 46\)](#)
- ▶ [Available Paper\(P. 470\)](#)

Saving Energy

51W4-013

You can save energy by making a setting so that the machine automatically enters the power saving state (sleep mode) or automatically turns OFF if no operation is performed for a certain period of time or that the machine is automatically turned OFF at a fixed time on each day of the week.



- ▶ **Entering Sleep Mode(P. 63)**
- ▶ **Setting Auto Shutdown Time(P. 65)**

Entering Sleep Mode

51W4-014

The sleep mode function reduces the amount of power consumed by the machine by disabling power flow to the operation panel. If no operations will be performed on the machine for a while, such as during a lunch break, you can save power simply by pressing  on the operation panel. You can also use the Auto Sleep Time setting to automatically put the machine into sleep mode if it remains idle for a specified length of time. You can specify settings to change the interval at which the auto sleep function is performed or put the machine in sleep mode at a specified time.

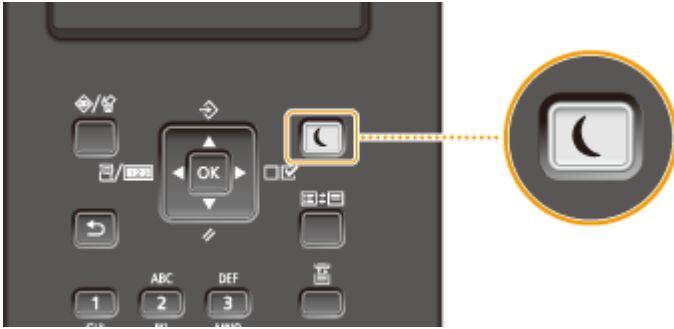

NOTE

When in sleep mode

- When the machine is in sleep mode,  lights in green.

Situations in which the machine does not enter sleep mode

- The machine does not enter sleep mode when it is receiving data from or sending data to a computer, any of the covers is opened, or no toner cartridge is installed.

Selecting the Sleep Mode Level

The degree of energy consumption reduction effect of sleep mode differs with the selected level of the mode ( **Sleep Mode(P. 311)**). To effectively save the power, we recommend that you use the machine with the factory default setting for sleep mode level. If you want to change the setting, follow the procedure below.

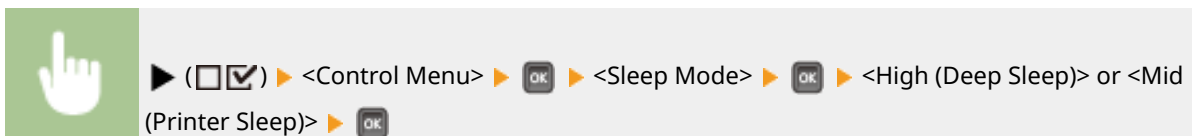

Changing Auto Sleep Time

The machine automatically enters sleep mode if it remains idle for a specified length of time. We recommend using the factory default settings ( **Auto Sleep Time(P. 312)**) to save the most power. If you want to change the amount of time that elapses before Auto Sleep is performed, follow the procedure below.

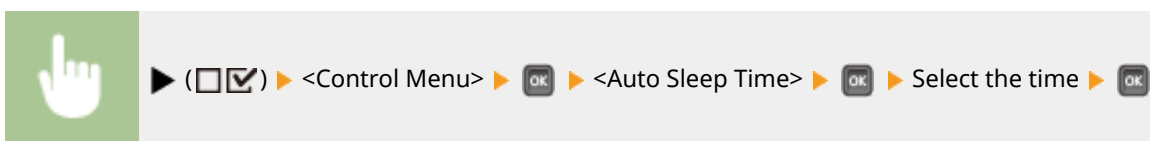

NOTE

- Immediately after the machine is turned ON, the length of time to elapse before the machine enters sleep mode may be longer than specified in the menu.

Automatically Entering/Exiting Sleep Mode at Specified Time

You can set the machine to enter sleep mode at a specified time. You can also set the machine to exit sleep mode at a specified time.

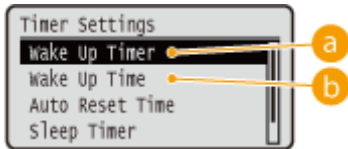
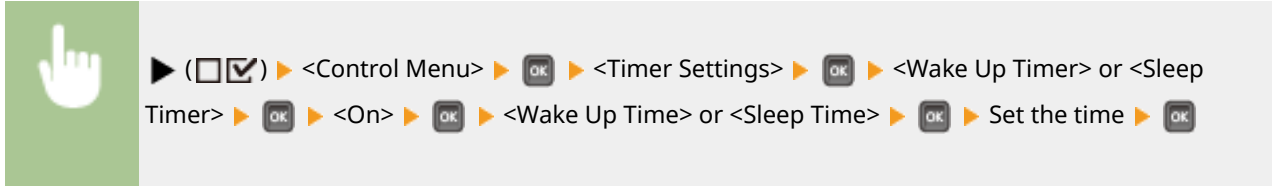

a <Wake Up Timer>

Select <On> to automatically exit sleep mode at a specified time.

b <Wake Up Time>

Set the time to automatically exit sleep mode.

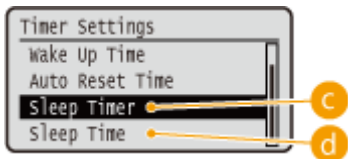

c <Sleep Timer>

Select <On> to automatically enter sleep mode at a specified time.

d <Sleep Time>

Set the time to automatically enter sleep mode.

When You Want to Prevent the Machine from Entering Sleep Mode if an Error Occurs

You can specify settings so that the machine will not enter sleep mode when an error occurs. **Sleep Even if Error(P. 312)**

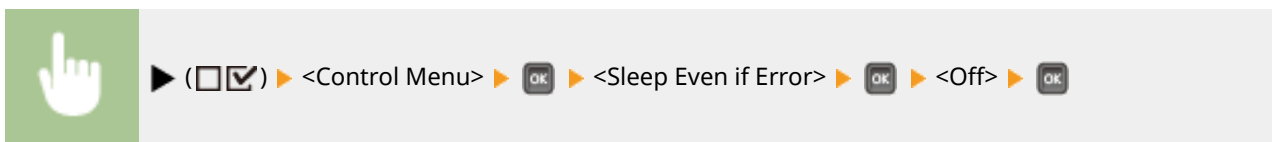

Exiting Sleep Mode

Press .

Setting Auto Shutdown Time

51W4-015

You can configure the machine to be automatically turned OFF when it is not operated for a long time. You can also configure the machine to be turned OFF at a specified time. These functions allow you to avoid useless power consumption that occurs due to failure to turn OFF the power. By factory default, this function is enabled.

1 Start the Remote UI and log on in Management Mode. ▶ Starting Remote UI(P. 284)

2 Click [Settings/Registration].

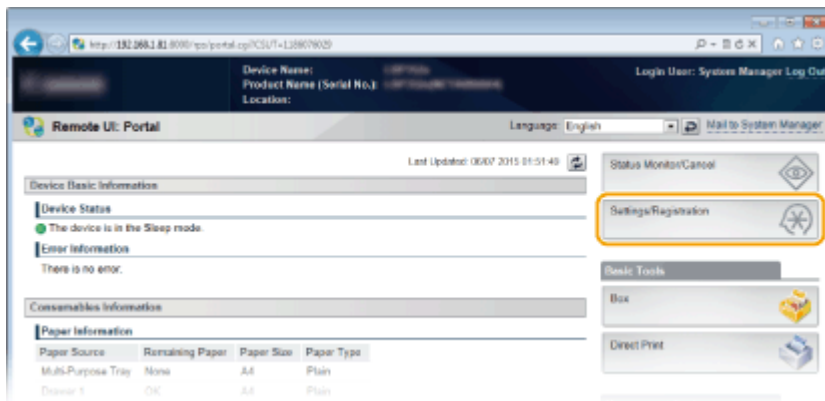

3 Click [Control Menu] ▶ [Edit].

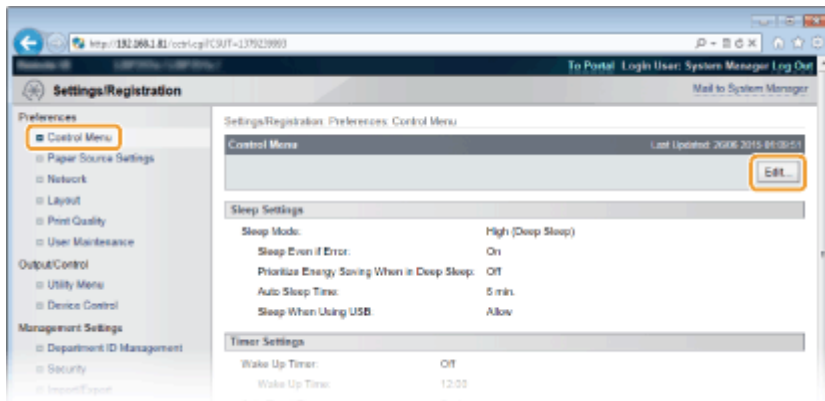

4 Configure auto shutdown timer settings.

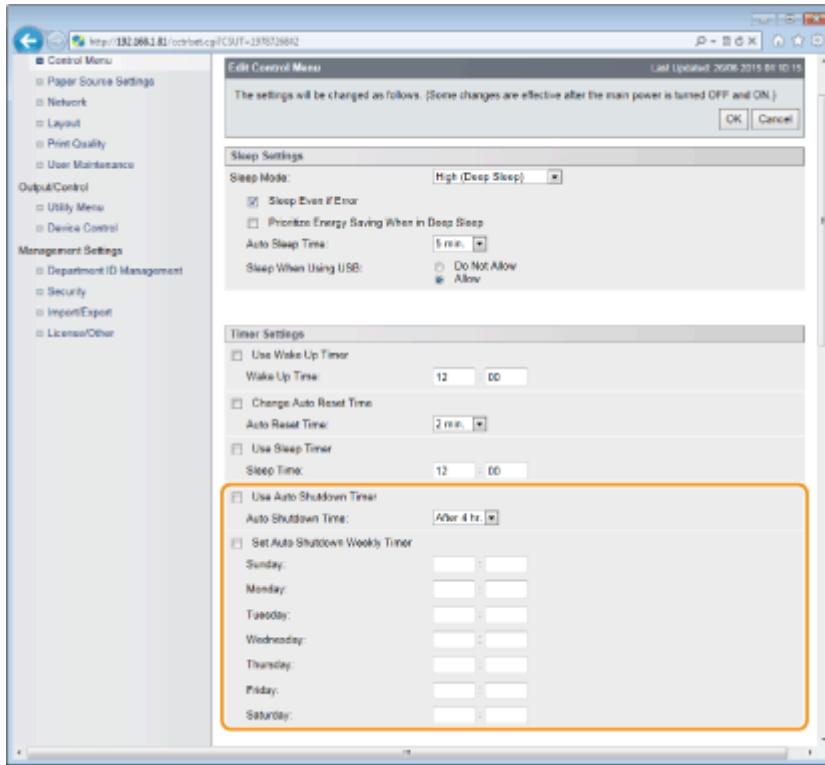

[Use Auto Shutdown Timer]

Select the check box to turn OFF the power when the time set in [Auto Shutdown Time] elapses.

[Auto Shutdown Time]

Specify after how many hours the machine should be turned OFF since it has entered sleep mode.

[Set Auto Shutdown Weekly Timer]

Select the check box to set the auto shutdown time for each day of the week.

[Sunday] to [Saturday]

Enter the time to turn OFF the power. If no time is specified, the auto shutdown time is not set for the day of the week.

5 Click [OK].

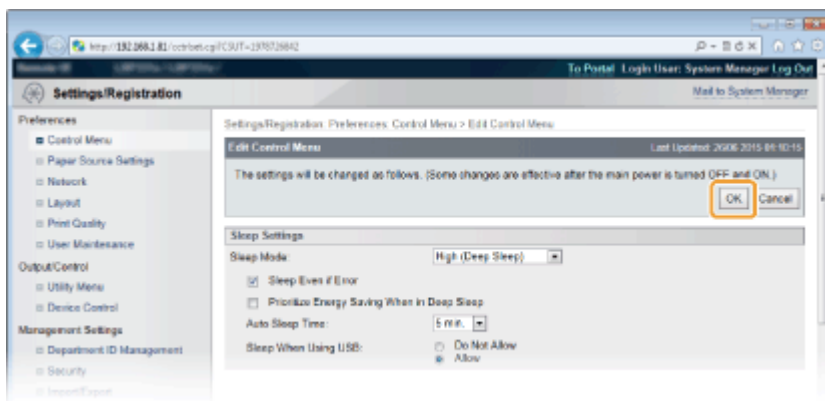

NOTE

If shutdown does not seem to be finished

- It may take some time for the machine to completely shut down. Do not unplug the power cord until the display turns off.

Situations that may be responsible for failure to turn OFF the power automatically at the specified time

- You are making some operation on the machine.
- The machine is in the process of printing, cleaning, or some other operation.
- An error message is displayed.

If the power cannot be turned OFF automatically at the specified time, a retry will be performed up to 10 times at intervals of 1 minute. If the power cannot be turned OFF even after ten retries, auto shutdown will be impossible for that day.

Printing a Document

Printing a Document	69
Printing from a Computer	70
Canceling Prints	73
Various Printing Methods	75
Printing from USB Memory (USB Direct Print)	77
Changing Default USB Print Settings	86
Printing a Document Secured by a PIN (Secured Print)	88
Using the Encrypted Secured Print	91
Printing a Document Stored in the Machine (Stored Job Print)	92
Deleting a Document Stored in the Machine	96
Setting a Name or PIN to a Box	99
Printing without Opening a File (Direct Print)	101
Print Settings for Direct Print	104
Printing Received E-mail (E-Mail Print)	111

Printing a Document

51W4-016

This section describes how to print documents made on your computer, print files saved in a USB memory device, and print documents by entering a PIN from the operation panel.

■ Printing from a Computer

You can print a document made on your computer by using the printer driver. ▶ **Printing from a Computer(P. 70)**

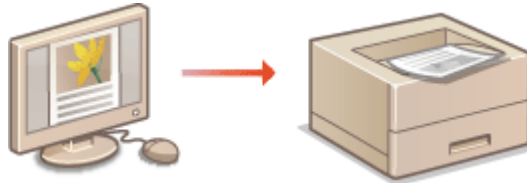

■ Using Useful Print Functions

You can use the print functions to print files stored in a USB memory device by connecting it directly to the machine without using a computer and to set a requirement that a PIN must be entered before any printing can start. ▶ **Various Printing Methods(P. 75)**



Printing from a Computer

51W4-017

You can print a document made with an application on your computer by using the printer driver. There are useful settings on the printer driver, such as enlarging/reducing and 2-sided printing, that enable you to print your documents in various ways. Before you can use this function, you need to complete some procedures, such as installing the printer driver on your computer. For more information, see the manuals for the relevant drivers on the online manual website.

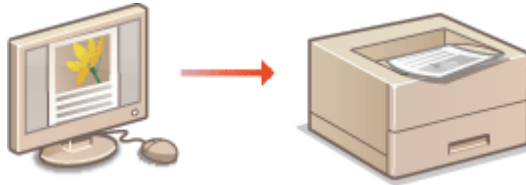

- ▶ **About the Printer Driver Help(P. 70)**
- ▶ **To Use Optional Accessories(P. 70)**
- ▶ **Basic Printing Operations(P. 71)**

About the Printer Driver Help

Clicking [Help] on the printer driver screen displays the Help screen. On this screen, you can see the detailed descriptions that are not in the User's Guide.

To Use Optional Accessories

If the optional paper feeder is attached to the machine, perform the following operation on the printer driver.

IMPORTANT

- To perform the following procedure, log on to your computer with an administrator account.



Open the printer folder (▶ **Displaying the Printer Folder(P. 522)**) ▶ Right-click the printer driver icon for this machine ▶ [Printer properties] or [Properties] ▶ [Device Settings] tab ▶ [Paper Source] ▶ Select the paper feeder in [Optional Drawer/Cassette] ▶ [OK] ▶ [OK]

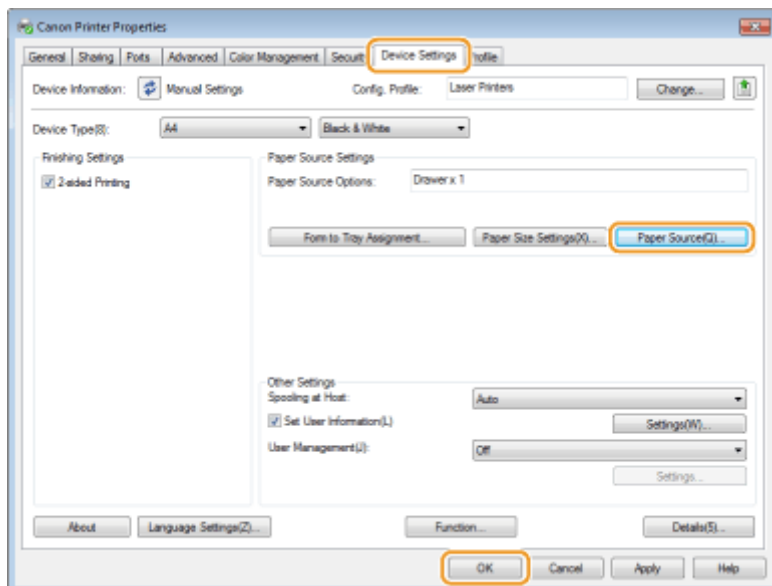

Basic Printing Operations

This section describes how to print a document on your computer by using the printer driver.

NOTE

Paper settings on the machine

- Normally, it is necessary to specify the paper size and type for the paper loaded in each paper source before proceeding to printing.

1 Open a document in an application and display the print dialog box.

2 Select your printer, and click [Preferences] or [Properties].

3 Specify the print settings as necessary, and click [OK].

- Switch the tab according to the settings.

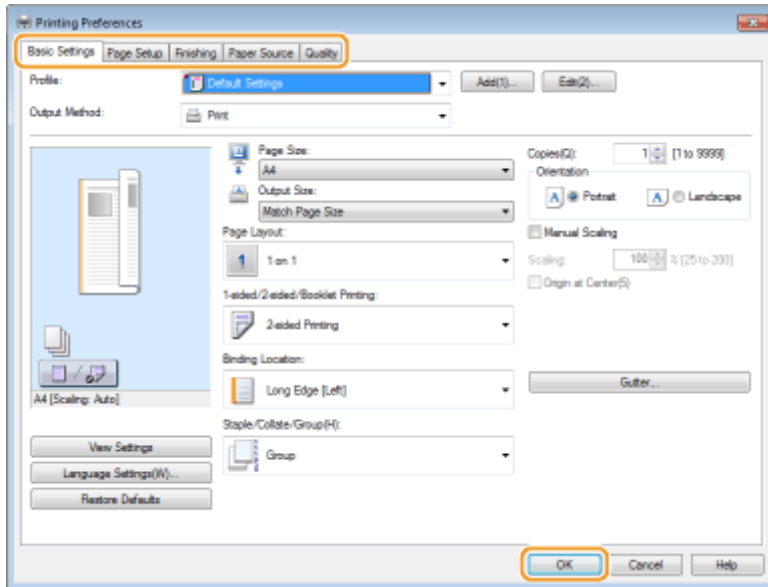

4 Click [Print] or [OK].

⇒ Printing starts.

- If you want to cancel printing, see [Canceling Prints\(P. 73\)](#) .

Canceling Prints

51W4-019

You can cancel printing from your computer or on the operation panel of the machine.

- ▶ From a Computer(P. 73)
- ▶ From the Operation Panel(P. 74)

From a Computer

You can cancel printing from the printer icon displayed on the system tray on the desktop.

1 Double-click the printer icon.



NOTE:

When the printer icon is not displayed

- Open the printer folder (▶ **Displaying the Printer Folder(P. 522)**), right-click the printer driver icon for this machine, and click [See what's printing] (or double-click the icon of the printer driver for the machine).

2 Select the document you want to cancel, and click [Document] ▶ [Cancel].

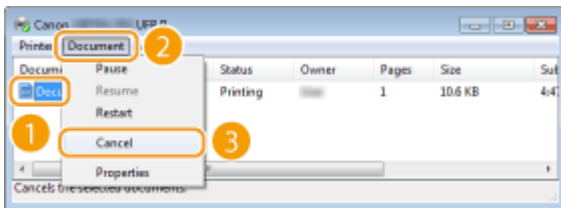

3 Click [Yes].

⇒ Printing of the selected document is canceled.

NOTE

- Several pages may be output after you cancel printing.

TIPS

Canceling from the Remote UI

- You can cancel printing from the [Job Status] page on the Remote UI: ▶ **Checking Current Status of Print Documents(P. 293)**

Canceling from an application

- On some applications, a screen like shown below appears. You can cancel printing by clicking [Cancel].

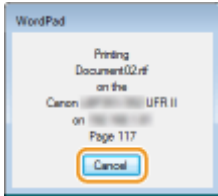

From the Operation Panel

When the print data is sent to the machine from a computer, the [↔] indicator lights up (or blinks). You can cancel printing from the operation panel while the indicator is lit or blinking.

1 Press (⏹).

2 Use ▲ / ▼ to select the document to cancel, and press .

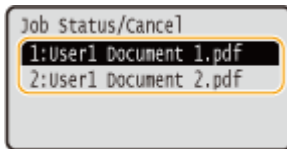

3 Select <Yes>, and press .

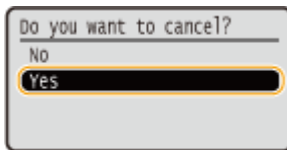

⇒ The <Canceling jobs> message is displayed and the selected print job is canceled.

NOTE

- Several pages may be output after you cancel printing.

LINKS

- ▶ [Printing from a Computer\(P. 70\)](#)
- ▶ [Managing Documents and Checking the Machine Status\(P. 293\)](#)

Various Printing Methods

51W4-023

You can use a variety of useful print functions as well as performing the basic print operations with the printer driver.

■ Printing from USB Memory (USB Direct Print)

You can print PDF files and image files stored in a USB memory device by connecting it directly to the machine. Using this function, you can print without using a computer. **▶Printing from USB Memory (USB Direct Print)(P. 77)**

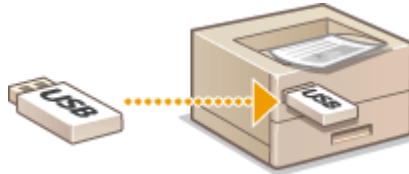

■ Printing a Document Secured by a PIN (Secured Print)

By setting a PIN to data that is sent to the machine from a computer, the data is not printed until the correct PIN is entered on the operation panel of the machine. This function is useful when printing confidential documents. **▶ Printing a Document Secured by a PIN (Secured Print)(P. 88)**

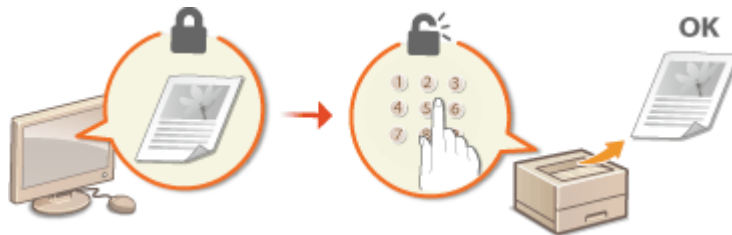

■ Printing a Document Stored in the Machine (Stored Job Print)

You can save print data sent from a computer onto an SD card. The stored data can be printed as many times as you want. **▶Printing a Document Stored in the Machine (Stored Job Print)(P. 92)**

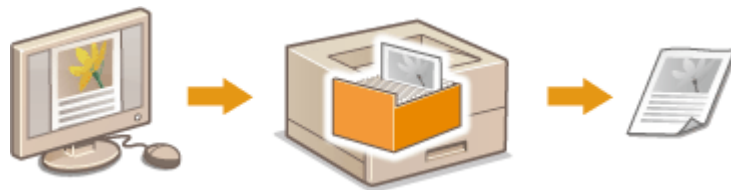

■ Printing without Opening a File (Direct Print)

You can print files (PDF, JPEG, etc.) stored in your computer by sending them to the machine via a Web browser. No specific application is needed. **▶Printing without Opening a File (Direct Print)(P. 101)**



■ **Printing Received E-mail (E-Mail Print)**

You can directly print e-mail messages and their attached files received in the machine without using a computer. ▶
Printing Received E-mail (E-Mail Print)(P. 111)

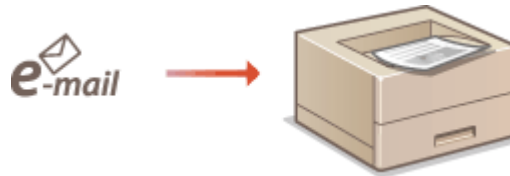

Printing from USB Memory (USB Direct Print)

51W4-024

You can print files directly by connecting a USB memory device to the machine. Using this function, you can print without using a computer.

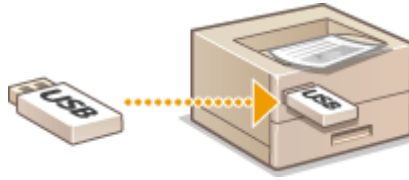

Available USB Memory Devices

You can use FAT32 formatted USB memory devices.

IMPORTANT

- Do not use non-standard USB memory devices. You may not be able to print the files properly depending on the USB memory device.
- Do not connect anything other than a USB memory device. USB memory devices cannot be connected via a USB hub or an extension cable.
- Do not use USB memory devices with special functions such as built-in security functions.

1 Connect a USB memory device to the USB port on the right side of the machine.

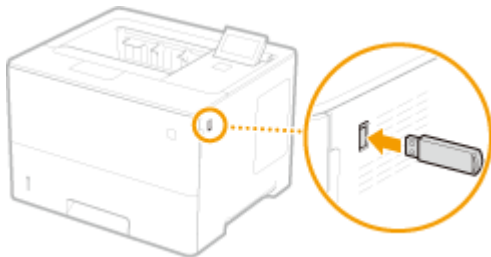

⇒ The following screen is automatically displayed.



- If the screen is not displayed, press ().

IMPORTANT:

- Do not shock or shake the USB memory device or the machine while the device is connected to the machine.

2 Use ▲ / ▼ to select <Select File(s)>, and press .

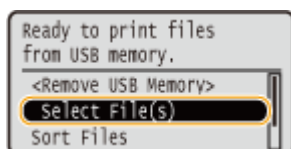







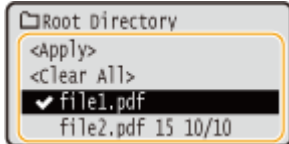

3 Select the type of the file to print, and press .



4 Select the file to print, and press .

- You can select multiple files.



- To clear a selection, select the file you have selected (marked with ) , and press  . To clear all selections, select <Clear All>, and press  .
- To display the contents of a folder, select a folder, and press  or  . To return to the folder in the upper level, press  or  .

NOTE:

- Folders and files in lower levels or with longer names may not be displayed.
- When you move to another folder, the previous file selections will be cleared.

5 Select <Apply>, and press .

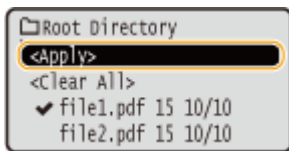

■When printing an XPS Document Using a Print Ticket

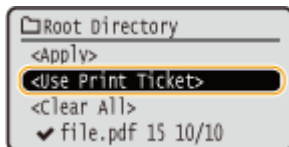

When a file to print is in XPS format, it can be printed according to the print ticket (print settings) attached to the file.

1 Select <Use Print Ticket>, and press .

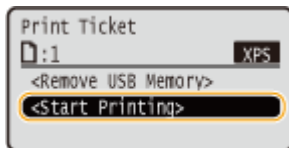

2 Select <Start Printing>, and press .



 Printing starts. When the printing is finished, remove the USB memory device from the machine.  **Disconnect the USB memory device.(P. 85)**

6 Specify the print settings as necessary.

- Select the desired setting item, press **OK**, and specify the setting.

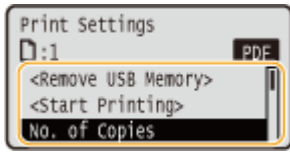

NOTE:

Icons* in the description

PDF	Settings for printing PDF files
XPS	Settings for printing XPS files
JPEG	Settings for printing JPEG files
TIFF	Settings for printing TIFF files

*Icons are omitted for the settings that are displayed regardless of the file format.

<No. of Copies>

Specify the number of copies. Use the numeric keys to enter a quantity, and press **OK**.

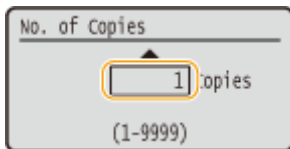

<Print Range>/<Print Range (TIFF)>

PDF **XPS** **TIFF**

Specify the range (pages) to print. Use **▲** / **▼** to select <Designation Method> **▶** **OK** **▶** select the method to designate the print range **▶** **OK**.

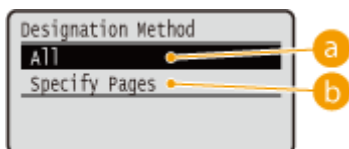

a <All>

Prints all pages.

b <Specify Pages>

Prints only the specified pages. To specify the pages, select <Page Range> **▶** **OK** **▶** enter <First Page> and <Last Page> using the numeric keys **▶** select <Apply> **▶** **OK**.

<Resolution>

Specify the resolution for processing print data. Use **▲** / **▼** to select the resolution, and press **OK**.

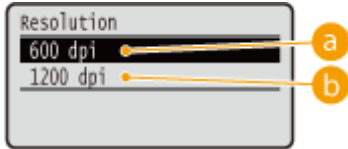

a <600 dpi>

This print mode is suitable for printing at a high speed.

b <1200 dpi>

Edges of characters and graphics can be clearly reproduced at high resolution. This print mode is suitable for printing data that contains many small characters.

<2-Sided Printing>

Select whether to print on both sides of paper. Use ▲/▼ to select the setting, and press **OK**.

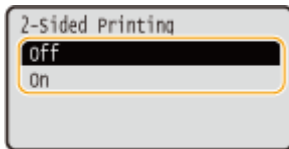

NOTE:

- <2-Sided Printing> may not be available with some sizes or types of paper. ▶ **Available Paper(P. 470)**

<Binding Location>

Specify whether to bind the long edge or short edge of the 2-sided printouts with a binding tool such as a stapler. Use ▲/▼ to select the binding position, and press **OK**.

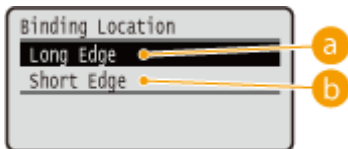

a <Long Edge>

Binds the printouts on the long edge.



b <Short Edge>

Binds the printouts on the short edge.



<Select Paper>

Select the paper source in which the paper to print is already loaded. Use ▲ / ▼ to select the paper source, and press **OK**.

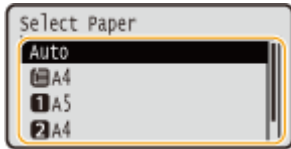

NOTE:

- When you want to print a PDF file or XPS file, specify <Auto> to automatically select the optimum paper source.
- A paper source with custom size paper loaded cannot be selected.

<Halftones>

You can select the method to reproduce halftones (the intermediate range between the lighter and darker areas of an image).

■ PDF files and XPS files

Halftones can be specified for each image data type in a single document. Use ▲ / ▼ to select the image data type ► **OK** ► select the method to reproduce halftones ► **OK**.

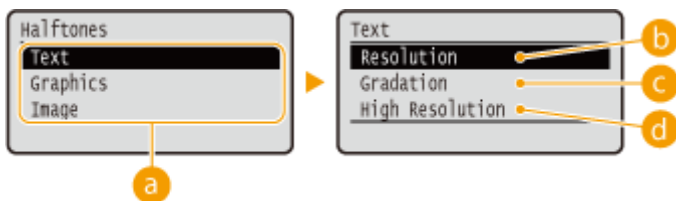

■ JPEG files and TIFF files

Use ▲ / ▼ to select the method to reproduce halftones, and press **OK**.

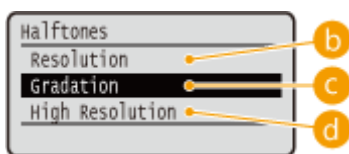

a Image data type

Select the image data type for which you want to change the settings. Select <Text> for characters, <Graphics> for lines and figures, or <Image> for images such as photos.

b <Resolution>

Performs fine printing by sharply reproducing the edges of characters. This print mode is suitable for printing data of characters and thin lines with a clear finish.

c <Gradation>

Prints gradation and lines with a smooth finish. This print mode is suitable for printing figures and charts with gradation.

d <High Resolution>

Implements higher definition printing than the <Resolution> setting, but is slightly inferior in stability of texture. This print mode is suitable for sharply printing edges of data such as characters, thin lines, and CAD data.

<Match Paper Size>

PDF XPS

Automatically makes enlarged or reduced printouts according to the printable area of the paper. The printouts are enlarged or reduced with the original's aspect ratio kept. Use ▲/▼ to select the setting, and press **OK**.

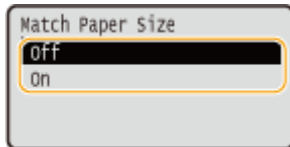

NOTE:

- This setting is not available if <Auto> is set in <Select Paper>.

<Zoom>

JPEG TIFF

Enable or disable enlarging/reducing images. The printouts are enlarged or reduced with the image's aspect ratio kept. Use ▲/▼ to select the setting, and press **OK**.



a <Off>

When the image is within the printable area of the paper, it is printed with the size as is. When an image is larger than the printable area, printouts are reduced.

b <Auto>

Makes enlarged or reduced printouts according to the printable area.

<Enlarge Print Area>

Specify whether or not to print the image by extending the printable area fully to the paper size. Use ▲/▼ to select the setting, and press **OK**.

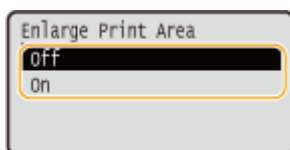

NOTE:

- If you select <On>, some portions of the image may be missing near the edge of the paper or the paper may be partly tainted depending on the original.

<N on 1>

PDF XPS

Select whether to print multiple pages onto a single sheet by sequentially allocating them from the top left. For example, to print four pages onto a single sheet, select <4 on 1>. Use ▲ / ▼ to select the setting, and press .

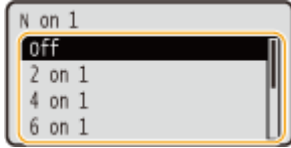

NOTE:

- This setting is not available if <Auto> is set in <Select Paper>.

<Finishing>

PDF XPS

Specify the method to collate the printouts when printing multiple-page documents. Use ▲ / ▼ to select whether or not to collate the printouts, and press .

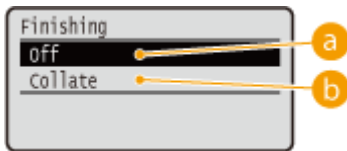

a <Off>

The printouts are not collated. The specified number of copies are printed for each page. For example, if you are printing three copies of a four-page document, the printouts will be arranged in the following page order: 1, 1, 1, 2, 2, 2, 3, 3, 3, 4, 4, 4.



b <Collate>

The printouts are grouped into complete sets in sequential page order. For example, if you are printing three copies of a four-page document, the printouts will be arranged in the following page order: 1, 2, 3, 4, 1, 2, 3, 4, 1, 2, 3, 4.



<Image Orientation>

JPEG TIFF

Specify the print orientation of an image. Use ▲ / ▼ to select the print orientation, and press .



a <Auto>

Automatically determines the print orientation based on the width and height of the image.

b <Vertical>

Select when printing a vertically-long image.

c <Horizontal>

Select when printing a horizontally-long image.

NOTE:

- If the specified setting of <Vertical> or <Horizontal> does not match the orientation of the image, the reduced image is printed.

<Print Position>



Specify the position to print the image. Use ▲ / ▼ to select the print position, and press **OK**.

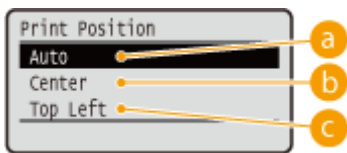

a <Auto>

If the TIFF data contains the information that specifies the print position, the image is printed according to the information, otherwise, it is printed at the center of paper. JPEG data is always printed at the center of paper.

b <Center>

Images are printed at the center of paper.

c <Top Left>

Images are printed at the top left.

7 Select <Start Printing>, and press **OK.**

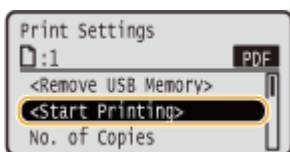

⇒ Printing starts.

- To cancel printing, use the operation panel. ▶ **Canceling Prints(P. 73)**

8 Disconnect the USB memory device.

1 Select <Remove USB Memory>, and press .

2 Select <Yes>, and press .

▶▶ Wait until the message shown below appears.



3 Disconnect the USB memory device.

NOTE

- If you select <Sort Files> on the screen in step 1, you can change the order of displaying files when you select the file to print.

TIPS

If you always want to print with the same settings: [▶ Changing Default USB Print Settings\(P. 86\)](#)

Changing Default USB Print Settings

51W4-025

The settings that are initially displayed for specifying print settings are called the default settings. If you change these default settings to match the operations that you perform frequently, you can eliminate the need to specify the same settings every time you make prints.

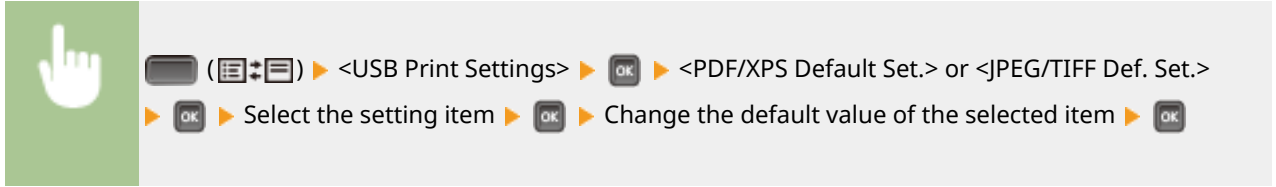

PDF/XPS

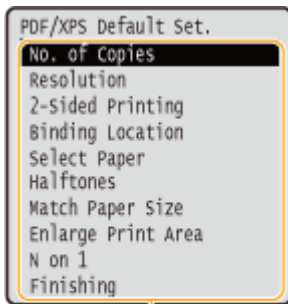

JPEG/TIFF

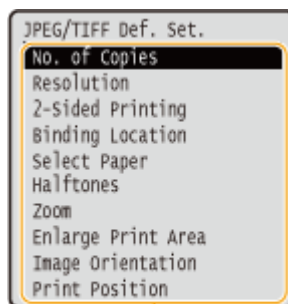

a Setting items

Select the item you want to set, and change the default value.

■ Setting the Order of Displaying Files to Print

You can set the order in which files to print from a USB memory device are displayed for selection.

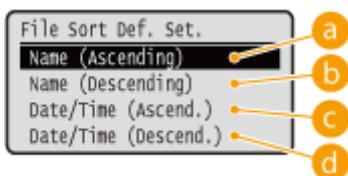
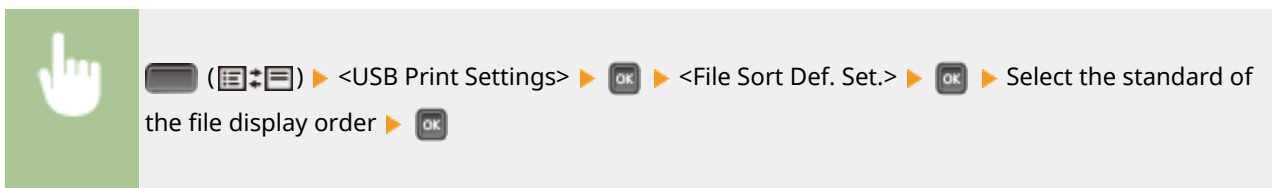

a <Name (Ascending)>

Displays the files in ascending order by name.

b <Name (Descending)>

Displays the files in descending order by name.

c **<Date/Time (Ascend.)>**

Displays the files in ascending order by date/time.

d **<Date/Time (Descend.)>**

Displays the files in descending order by date/time.

LINKS

▶ Printing from USB Memory (USB Direct Print)(P. 77)

Printing a Document Secured by a PIN (Secured Print)

51W4-026

By setting a PIN to a document when printing from a computer, the document is held in an optional SD card installed on the machine, and is not printed until the correct PIN is entered on the operation panel of the machine. This function is called "Secured Print," and the document that is protected by a PIN is called a "secured document." Using Secured Print keeps printouts of confidential documents from being left unattended. Before you can use this function, you need to install an optional SD card on the machine ([▶Installing an SD Card\(P. 495\)](#)).

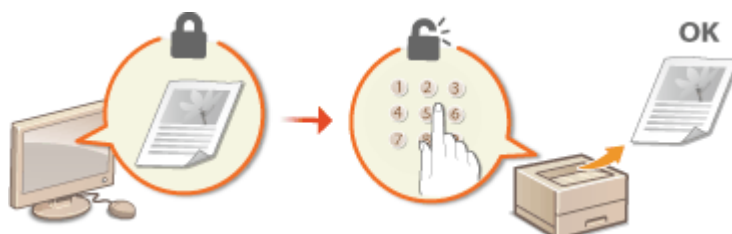

- ▶ [Sending a Secured Document from a Computer to the Machine\(P. 88\)](#)
- ▶ [Printing Out Secured Documents\(P. 89\)](#)
- ▶ [Changing the Valid Time Period for Secured Documents\(P. 90\)](#)

Sending a Secured Document from a Computer to the Machine

Follow the procedure below. You can send a document protected by a PIN.

1 Open a document in an application and display the print dialog box.

2 Select this machine, and click [Preferences] or [Properties].

3 Select [Secure Print] in [Output Method].

⇒ The [Information] pop-up screen is displayed. Check the message, and click [Yes] or [No].

4 Specify the print settings as necessary, and click [OK].

- Switch the tab according to the settings.

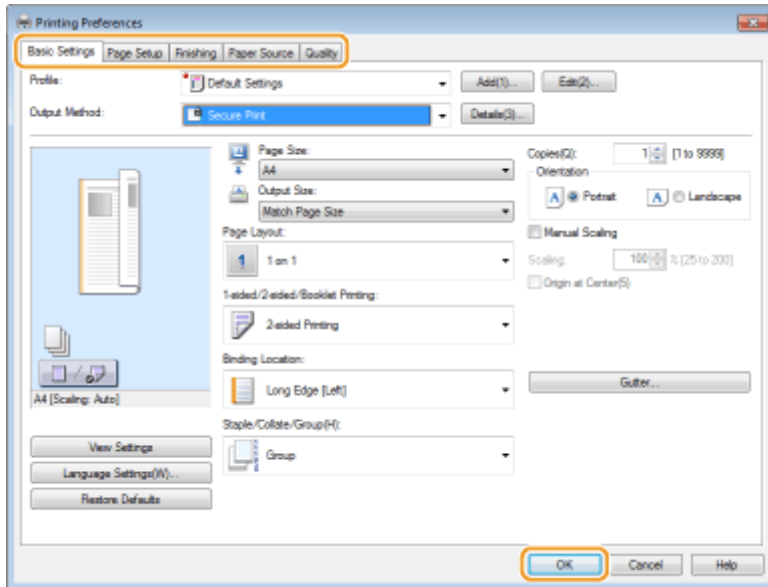

5 Click [Print] or [OK].

⇒ After the secured document is sent to the machine, it is held in the SD card waiting to be printed.

NOTE

- You can also use the encrypted print function with enhanced security. ▶ **Using the Encrypted Secured Print(P. 91)**

Printing Out Secured Documents

Prints secured documents sent to the machine. After a valid time period (▶ **Changing the Valid Time Period for Secured Documents(P. 90)**) has elapsed, the secured document will be deleted from the memory of the machine and can no longer be printed.

1 Press ▲ (↔).

2 Use ▲ / ▼ to select <Secured Print>, and press **OK**.

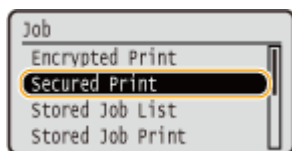

3 Select the secured document to print, and press **OK**.

- If the SD card contains only one secured document, this screen is not displayed.

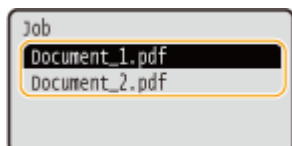

NOTE:

If the user name is displayed

- If secured documents from two or more users are being held in the SD card, the user selection screen as shown below is displayed prior to the screen shown above. Select your user name, and press **OK**.

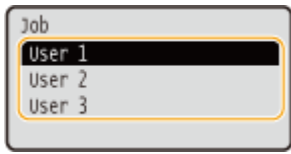

4 Enter the PIN, and press **OK.**

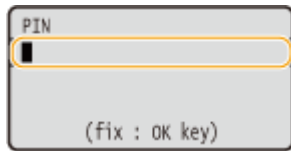

⇒ Printing starts.

- To cancel print jobs, use the operation panel. **▶Canceling Prints(P. 73)**

Changing the Valid Time Period for Secured Documents

You can change the valid time period from the time secured document data is sent to the machine until the time it is deleted within a certain period of time.

1 Press **▶ ().**

2 Use **▲ / **▼** select <Control Menu>, and press **OK**.**

3 Select <Sec. Print Del. Time>, and press **OK.**

4 Select how long the SD card holds secured documents, and press **OK.**

- The secured document is erased from the SD card when the time selected here elapses.

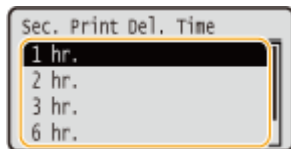

LINKS

- ▶ **Using the Encrypted Secured Print(P. 91)**
- ▶ **Installing an SD Card(P. 495)**

Using the Encrypted Secured Print

51W4-027

Print data is encrypted before being sent to the machine, enhancing security more than the regular secured print function.

■ Activating the Encrypted Print function

To use the encrypted print function, perform the following operation in advance.



Open the printer folder ([▶ Displaying the Printer Folder\(P. 522\)](#)) ▶ Right-click the printer driver icon for this machine ▶ [Printer properties] or [Properties] ▶ [Device Settings] tab ▶ [Details] ▶ [Other Settings] tab ▶ Enable [Encrypted Secure Print] ▶ [OK] ▶ [OK]

■ Sending an Encrypted Secured Document from a Computer to the Machine

See Help. You can view Help from the printer driver.





Open the printer folder ([▶ Displaying the Printer Folder\(P. 522\)](#)) ▶ Right-click the printer driver icon for this machine ▶ [Printer properties] or [Properties] ▶ [Encrypted-P] tab ▶ [Help]

■ Printing Out Encrypted Secured Documents

After you send an encrypted document to the machine, print it out. Encrypted documents will be deleted automatically when the retention time has elapsed ([▶ Changing the Valid Time Period for Secured Documents\(P. 90\)](#)), and can no longer be printed. The retention time setting method is common to secured documents and encrypted documents.



▲ (↔) ▶ <Encrypted Print> ▶  ▶ Select the encrypted secured document to print ▶  ▶ Enter the PIN using the numeric keys ▶ 

NOTE

If you are using alphanumeric characters or symbols in your PIN

- The Encrypted Secured Print function allows you to use alphabetic characters and symbols as well as numbers when specifying a PIN in the printer driver. However, if you use an alphabetic character or symbol in the PIN, you cannot print an encrypted secured document from the operation panel of the machine. Use [Job Status] of the Remote UI to print an encrypted document. [▶ Checking Current Status of Print Documents\(P. 293\)](#)

Printing a Document Stored in the Machine (Stored Job Print)

51W4-028

The data printed from a computer can be saved on the SD card installed on the machine. Since the saved data can be directly printed from the machine, you can eliminate the need to operate the computer every time you print. It is convenient to save a document that will be printed many times such as a fax cover sheet. **▶Installing an SD Card(P. 495)**

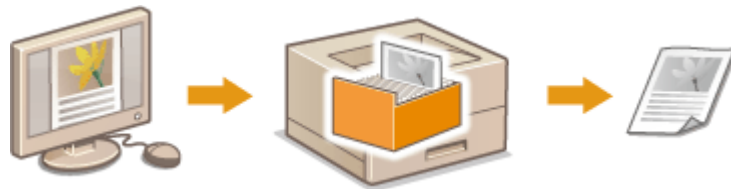

▶Storing a Document in the Machine(P. 92)

▶Printing a Document Stored in the Machine(P. 94)

NOTE

- The data saved on the SD card will not be deleted even when the power is turned OFF, but it will be deleted automatically when the set retention time has elapsed, and can no longer be printed. When you want to change the data storage period or prevent the data from being automatically deleted, change the applicable settings from the Remote UI (**▶Changing the Storage Period for Documents(P. 96)**). The saved data can also be deleted manually (**▶Manually Deleting Documents(P. 97)**).

Storing a Document in the Machine

- 1** Open a document in an application and display the print dialog box.
- 2** Select this machine, and click [Preferences] or [Properties].
- 3** Select [Store] in [Output Method], and click [Yes].

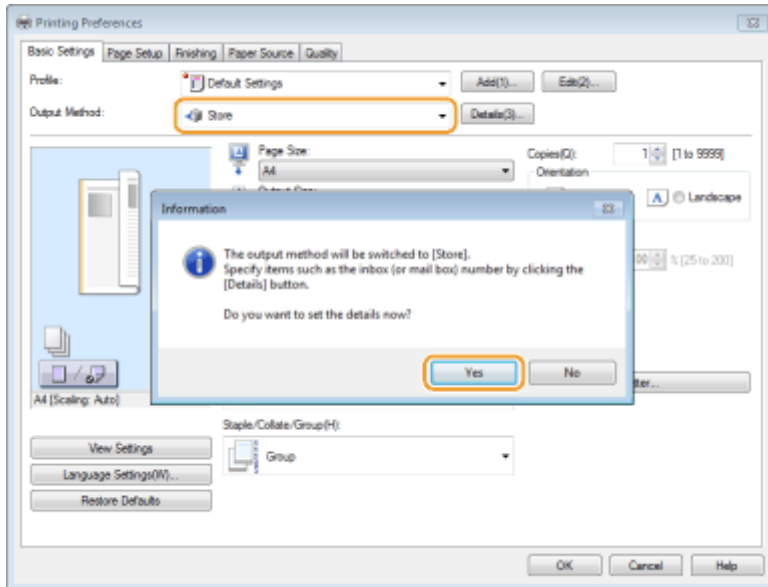

4 Specify the settings for storing documents, and click [OK].

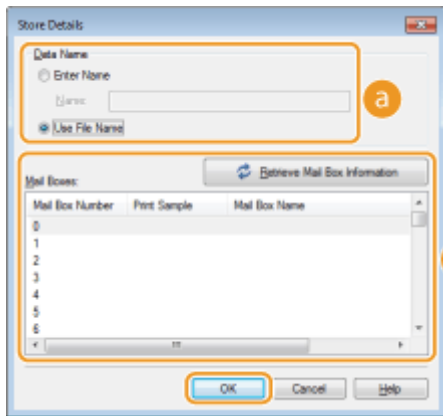

a [Data Name]

Assign a name to print data to store in the SD card.

[Enter Name]	Manually set a name. Specify a friendly name that can be easily identified on the display of the machine.
[Use File Name]	A name is automatically set based on the file name of print data to store and the information of an application that you are using.

b [Mail Boxes]

A place used to store print data in the SD card is called a box. Select the number of the box to store the document. You can assign a name to the box to facilitate identification of the box. **Setting a Name or PIN to a Box(P. 99)**

5 Specify the print settings as necessary, and click [OK].

- Switch the tab according to the settings.
- The settings changed here are stored with the document. When the document is printed next time, it is printed with the stored settings.

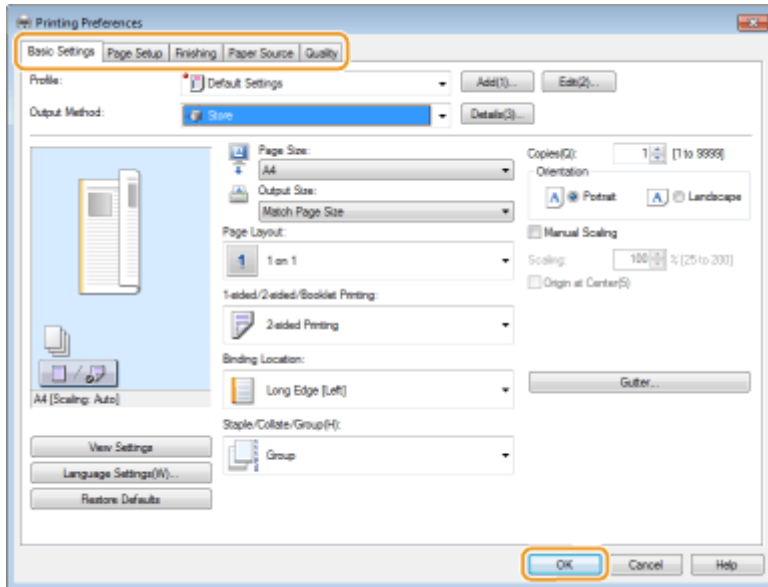

6 Click [Print] or [OK].

⇒ The document is sent to the machine and stored in the specified box.

Printing a Document Stored in the Machine

1 Press ▲ (↕).

- When the machine is offline, it does not operate even if you press ▲ (↕). Set the machine to Online. ▶ **Online key (P. 26)**

2 Use ▲ / ▼ to select <Stored Job Print>, and press [OK].

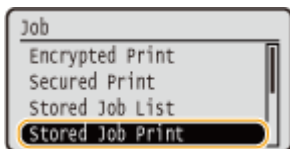

3 Select the box number of the document to print, and press [OK].

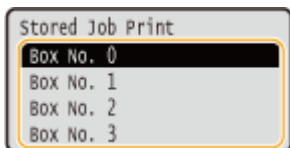

NOTE:

If the box is protected by a PIN

- When the PIN input screen is displayed, enter the PIN and press [OK]. If you are unsure of the PIN, contact the administrator of the machine.



4 Select the document to print, and press .

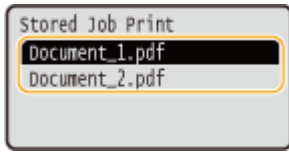

⇒ Printing starts.

- To cancel printing, use the operation panel. [▶Canceling Prints\(P. 73\)](#)

NOTE

- Documents saved on the SD card can also be printed from the [Box] page of the Remote UI ([▶\[Box\] Page\(P. 290\)](#)). Open the box in which documents are saved, select the check box for a document to print, and click [Print].

LINKS

- ▶[Deleting a Document Stored in the Machine\(P. 96\)](#)
- ▶[Setting a Name or PIN to a Box\(P. 99\)](#)
- ▶[Installing an SD Card\(P. 495\)](#)

Deleting a Document Stored in the Machine

51W4-029

By factory default, the data you save on an SD card will be automatically deleted when a certain length of time has elapsed, and can no longer be printed. If you want to change how long the SD card holds documents or prevent the documents from being automatically deleted, change the settings from the Remote UI. The saved documents can also be deleted manually.

- ▶ **Changing the Storage Period for Documents(P. 96)**
- ▶ **Manually Deleting Documents(P. 97)**

Changing the Storage Period for Documents

- 1 Start the Remote UI and log on in Management Mode. ▶ Starting Remote UI(P. 284)**
- 2 Click [Settings/Registration].**

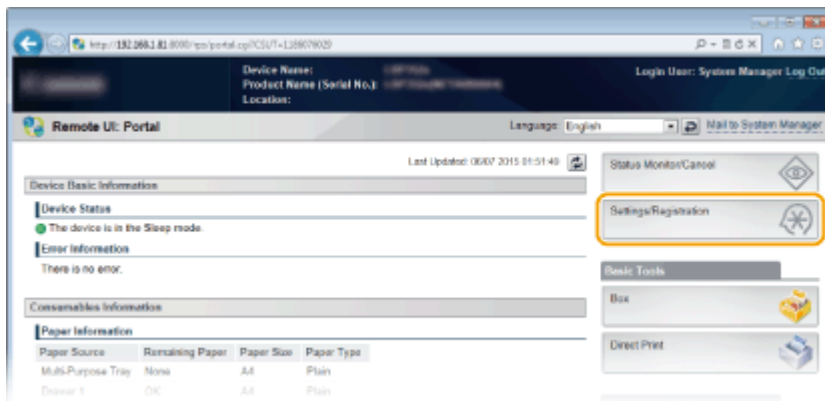

- 3 Click [Control Menu] ▶ [Edit].**

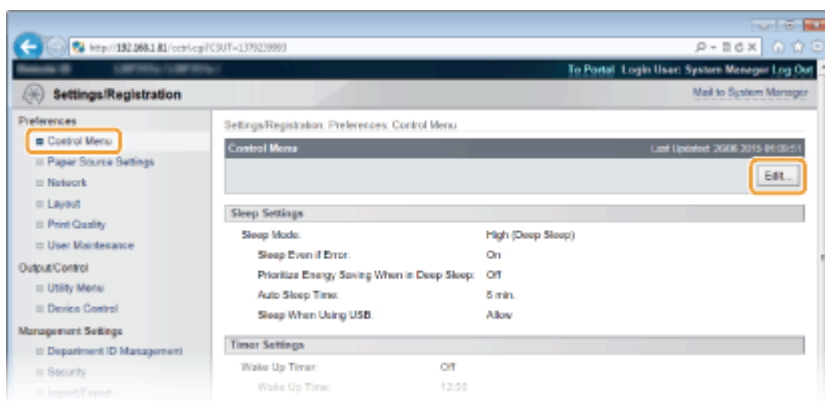

- 4 Change the storage period.**
 - To prevent documents from being automatically deleted, select [Off].

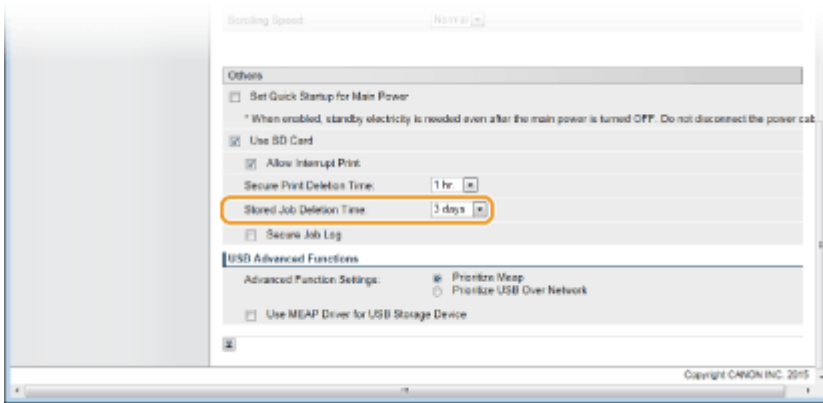

5 Click [OK].

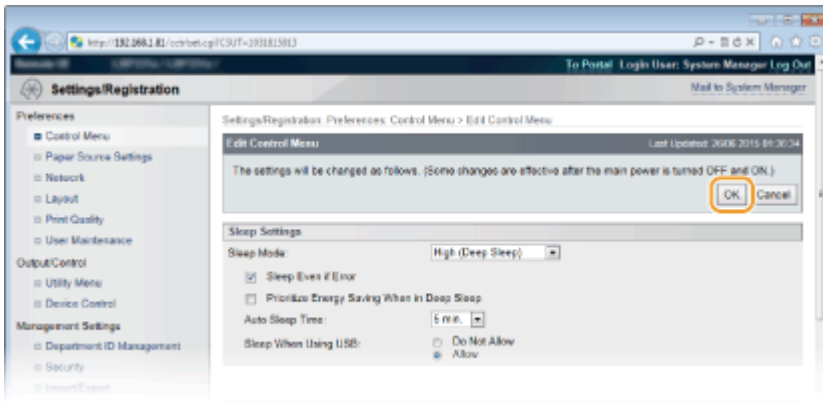

Manually Deleting Documents

1 Start the Remote UI and log on. ▶ Starting Remote UI(P. 284)

NOTE:

If you logged on in General User Mode

- By default, the machine is configured so that no users (general users) other than the administrator can delete the documents. To allow end users to operate documents, you must change the settings. ▶ Enabling End Users to Operate Documents(P. 298)
- You can delete only the document of which user name matches the one that was used to log on to the Remote UI.

2 Click [Box].

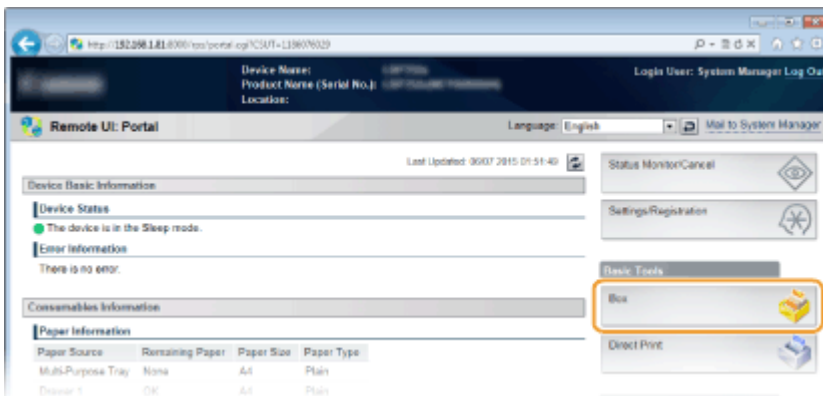

3 Click the number of the box where the document to delete is stored.

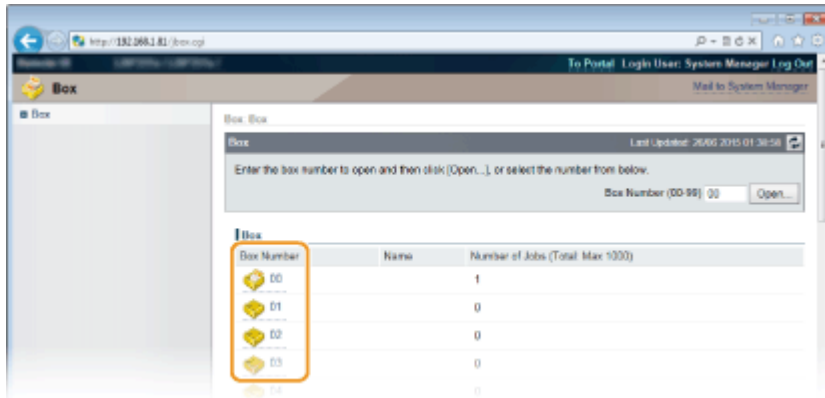

NOTE:

If the box is protected by a PIN

- When the screen shown below is displayed, enter the PIN and click [OK].



4 Select the check box of the document to delete, and click [Delete].

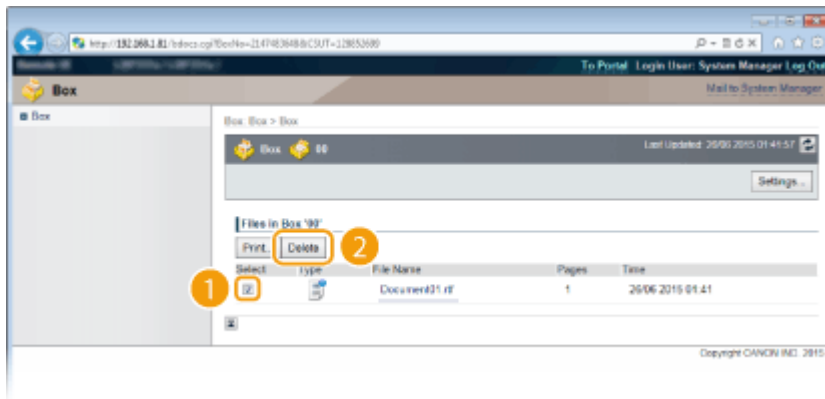

⇒ The selected document is deleted.

NOTE:

- You can click the text link under [File Name] to check the details of the document.

NOTE

- It may take some time until the free space of the SD card is increased because the stored data is erased in the background.

Setting a Name or PIN to a Box

51W4-02A

You can set a name for a box and a PIN to open the box. If you set a friendly name for the box, you can easily identify the box when selecting the place to store documents by using the printer driver. If you set a PIN, the stored documents can be accessed by only limited users, enhancing the security.

1 Start the Remote UI and log on in Management Mode. ▶ Starting Remote UI(P. 284)

2 Click [Box].

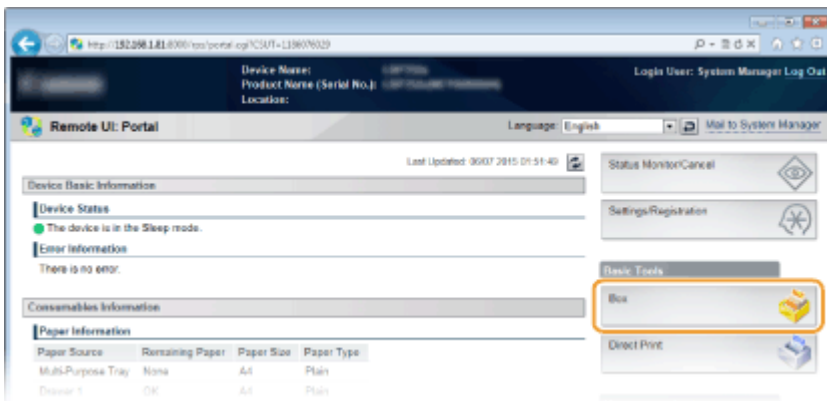

3 Click the number of the box for which you want to specify the settings.

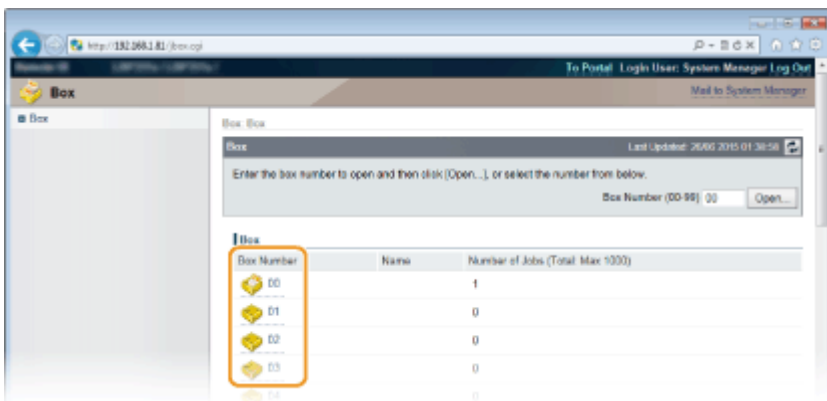

NOTE:

If the box is protected by a PIN

- When the screen shown below is displayed, enter the PIN and click [OK].



4 [Settings].

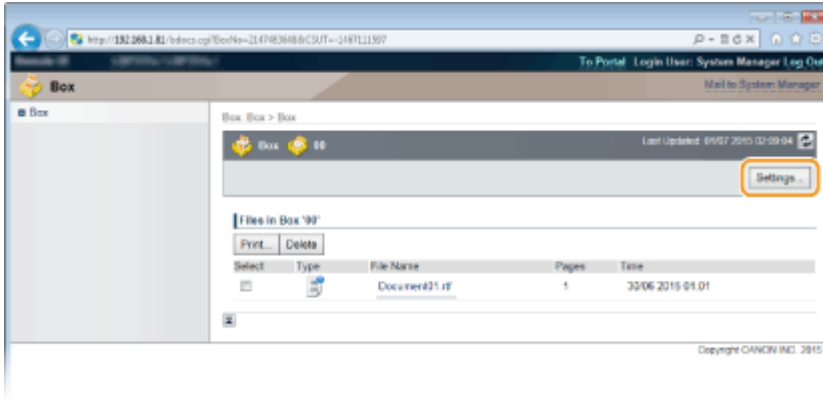

5 Set a name and PIN.

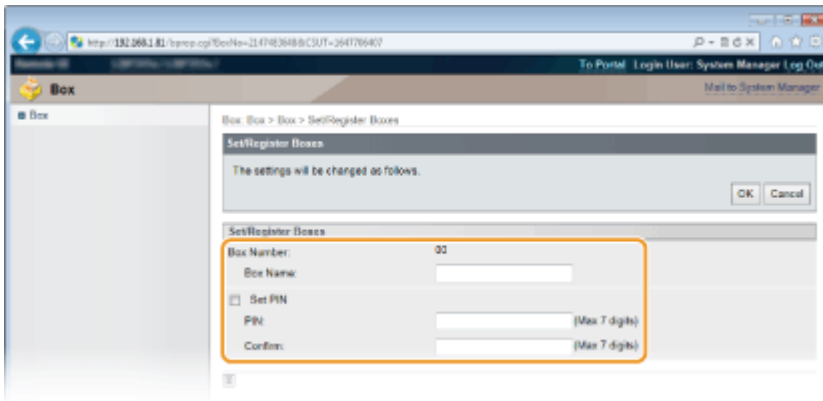

[Box Name]

To set a name for the box, enter the necessary characters.

[Set PIN]

To set a PIN, select the [Set PIN] check box and enter a number for the PIN in the [PIN] text box. For confirmation, enter the same number in the [Confirm] text box.

NOTE:

- You cannot use "0" as the first digit of the PIN. A number with "0" removed from the first digit will be set as the PIN.

6 Click [OK].

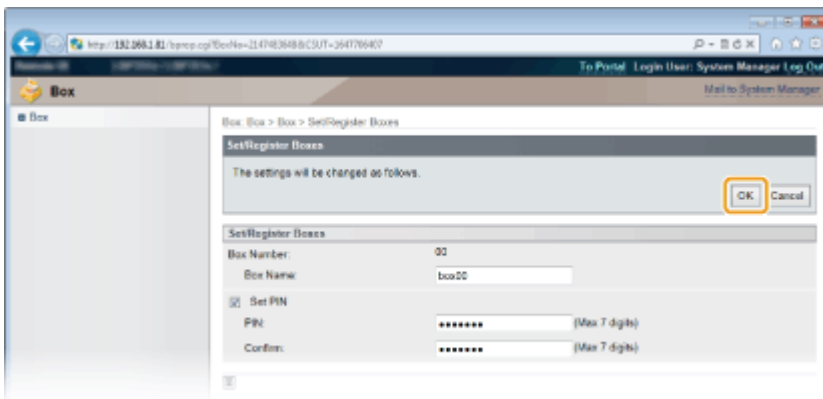

Printing without Opening a File (Direct Print)

51W4-02C

You can print a file from a Web browser (Remote UI) without opening the file. In addition, you can also print a PDF file on the Web by only specifying the URL.



1 Start the Remote UI and log on. Starting Remote UI(P. 284)

2 Click [Direct Print].

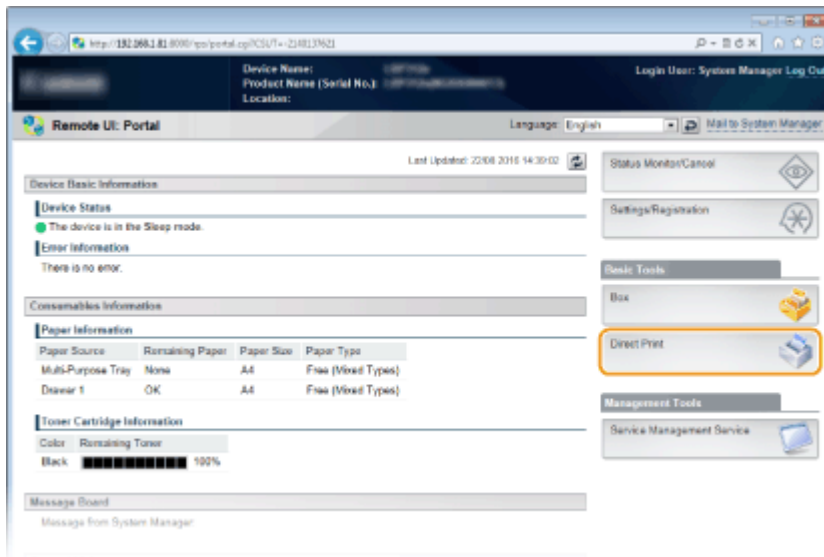

3 Click the type of the file to print.

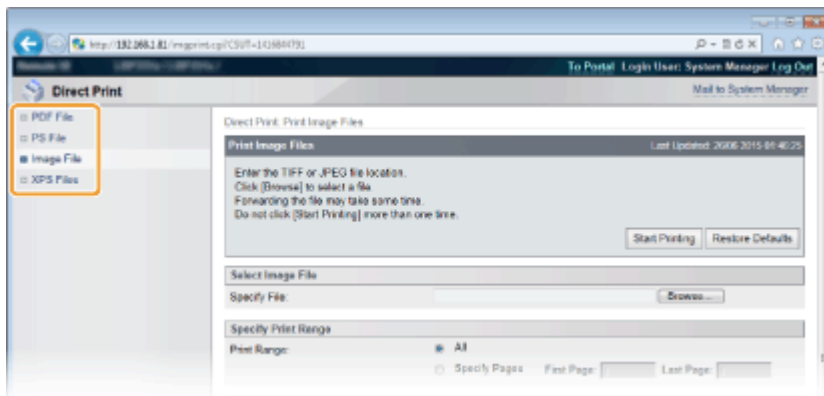

[PDF File]

Click to print a PDF file.

[PS File]

Click to print a PS or EPS file.

[Image File]

Click to print a JPEG or TIFF file.

[XPS Files]

Click to print an XPS file.

4 Click [Browse].

- When the dialog box for selecting the file appears, select the file to print and click [Open].
- When you print a PDF file, select [File Path].

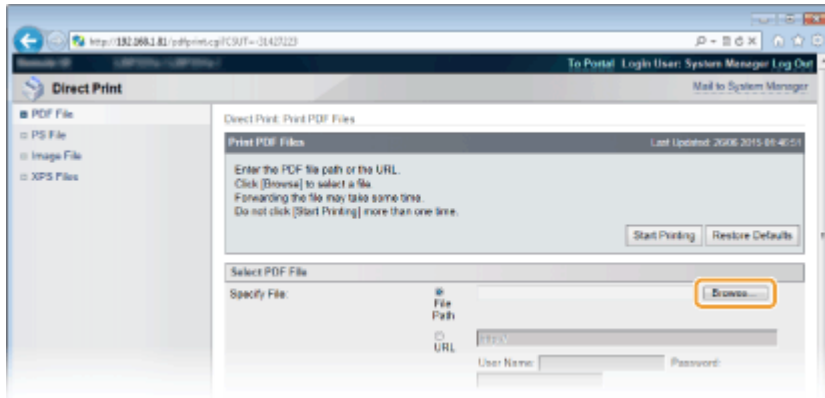

NOTE:

When you print a PDF file on the Web

- Select [URL], and enter the URL of the PDF file. If the user authentication is performed, enter the user name and password.

When the PDF file is password-protected

- Enter the password in [Document Password].

When you print a PDF file linked to a policy server

- Specify the [Policy Server User Name] and [Policy Server Password] settings.

5 Specify the print settings as necessary. ▶ Print Settings for Direct Print(P. 104)

6 Click [Start Printing].

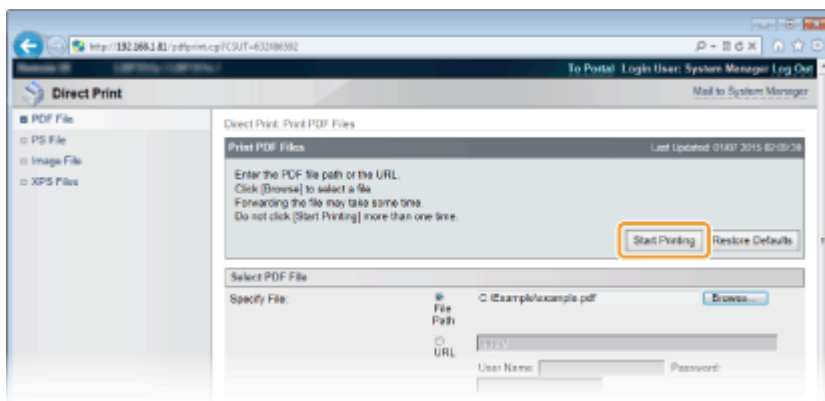

➡ The screen shown below is displayed and printing starts.

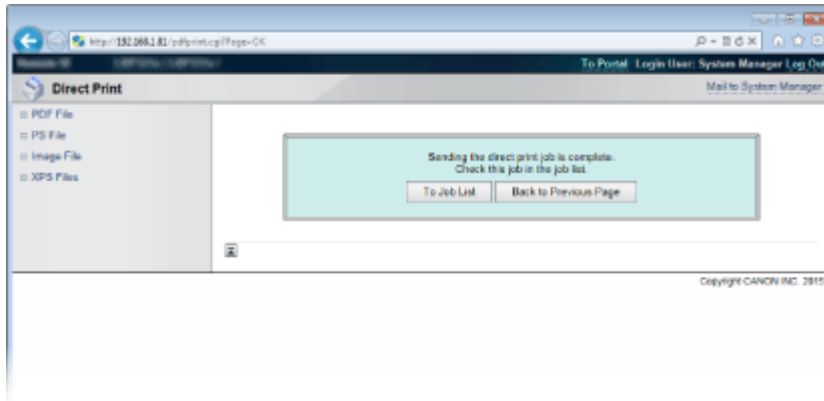

- If you click [To Job List], the [Job Status] page is displayed to show the print status. ▶ **Checking Current Status of Print Documents(P. 293)**

IMPORTANT:

- It may take some time until printing starts.

LINKS

- ▶ **Using Remote UI(P. 283)**

Print Settings for Direct Print

51W4-02E

When you want to change the settings for Direct Print according to the document to print, specify the following settings.

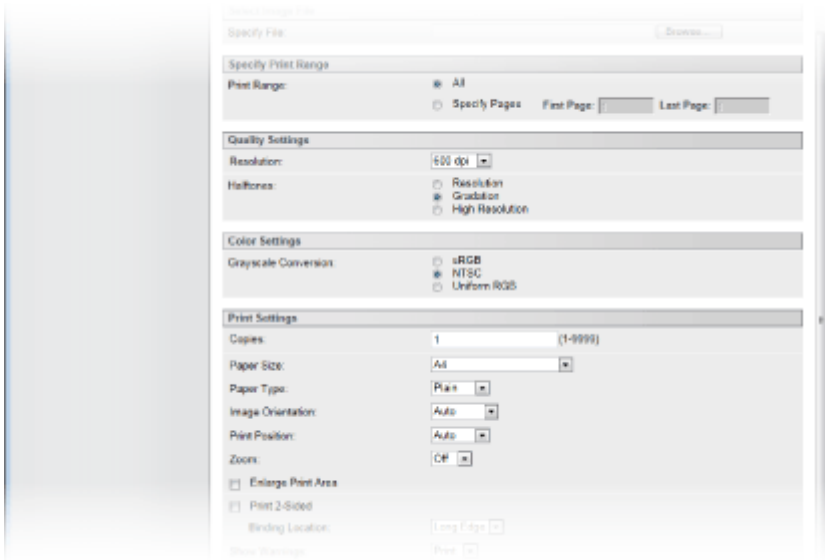

IMPORTANT

When you specify the print settings for XPS files

- Clear the [Prioritize Print Ticket] check box. If the check box is selected, some items are unavailable.

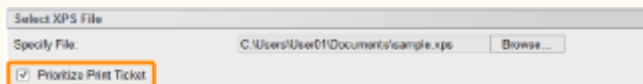

NOTE

Icons* in the description

- PDF** Settings for printing PDF files
- PS** Settings for printing PS/EPS files
- JPEG** Settings for printing JPEG files
- TIFF** Settings for printing TIFF files
- XPS** Settings for printing XPS files

*Icons are omitted for the settings that are displayed regardless of the file format.

[Specify Print Range]

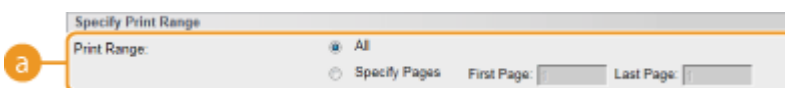

a [Print Range] PDF JPEG TIFF XPS

Specify the range (pages) to print.

[All]	Select to print all pages.
[Specify Pages]	Select to specify the print range. This setting is unavailable for JPEG files.

[Quality Settings]

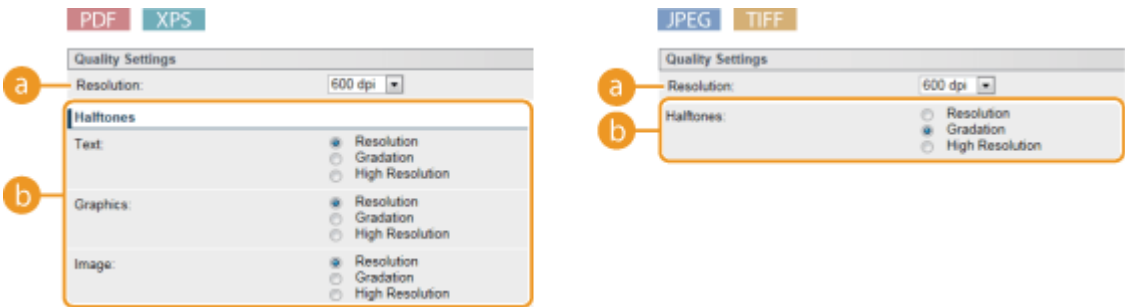

a [Resolution]

Specify the resolution of data to print.

[1200 dpi]	Edges of characters and graphics can be clearly reproduced at high resolution. This print mode is suitable for printing data that contains many small characters.
[600 dpi]	This print mode is suitable for printing at a high speed.

b [Halftones] PDF JPEG TIFF XPS

You can select the printing method to reproduce halftones (the intermediate range between the lighter and darker areas of an image). For PDF files and XPS files, you can specify the halftones for each image data type: [Text], [Graphics], and [Image].

[Resolution]	Performs fine printing by sharply reproducing the edges of characters. This print mode is suitable for printing data of characters and thin lines with a clear finish.
[Gradation]	Prints gradation and lines with a smooth finish. This print mode is suitable for printing figures and charts with gradation.
[High Resolution]	Implements higher definition printing than the [Resolution] setting, but is slightly inferior in stability of texture. This print mode is suitable for sharply printing edges of data such as characters, thin lines, and CAD data.

[Color Settings]

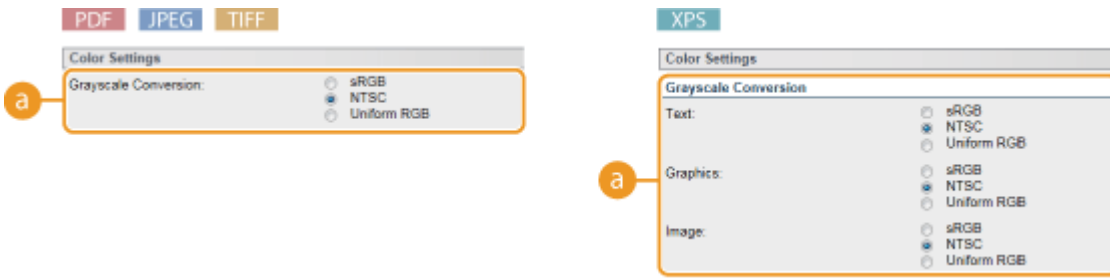

a [Grayscale Conversion]

You can select the method to convert color print data to black-and-white data. For XPS files, you can specify the conversion method for each image data type: [Text], [Graphics], and [Image].

[sRGB]	Color data is converted to black-and-white data to generate color-conscious smooth gradation.
[NTSC]	Color data is converted to black-and-white data to generate appearances equivalent to television pictures (NTSC).
[Uniform RGB]	Color data is converted to black-and-white data to equalize all RGB levels based on the brightness only.

[Print Settings]



a [Copies]

Specify the number of copies.

b [Paper Size] PDF JPEG TIFF XPS

Specify the size of the paper to print on.

NOTE:

- When you want to print a PDF file or XPS file, specify [Auto] to automatically select the optimum paper size. If no optimum size is found, the paper size set in <Standard Paper Size> is selected (**Standard Paper Size(P. 411)**).

c [Paper Type] PDF JPEG TIFF XPS

Specify the type of the paper to print on.

d [Manual Feed] PDF XPS

If you select the check box, a document is printed only on the paper loaded in the multi-purpose tray.

e [Enlarge/Reduce to Fit Paper Size] PDF XPS

If you select the check box, printouts are enlarged or reduced printouts according to the printable area of the paper. The printouts are enlarged or reduced with the original aspect ratio kept.

NOTE:

- If [Paper Size] is set to [Auto], this item is unavailable.

f [Image Orientation] JPEG TIFF

Specify the print orientation of an image.

[Auto]	Automatically determines the print orientation based on the width and height of the image.
[Vertical]	Select when printing a vertically-long image.
[Horizontal]	Select when printing a horizontally-long image.

NOTE:

- If the specified setting of [Vertical] or [Horizontal] does not match the orientation of the image, the reduced image is printed.

g [Print Position] JPEG TIFF

Specify the position to print the image.

[Auto]	If the TIFF data contains the information that specifies the print position, the image is printed according to the information, otherwise, it is printed at the center of paper. JPEG data is always printed at the center of paper.
[Center]	Images are printed at the center of paper.
[Top Left]	Images are printed at the top left.

h [Zoom] JPEG TIFF

Enable or disable enlarging/reducing images. The printouts are enlarged or reduced with the image aspect ratio kept.

[Off]	When the image is within the printable area of the paper, it is printed with the size as is. When an image is larger than the printable area, printouts are reduced.
[Auto]	Makes enlarged or reduced printouts according to the printable area of the paper.

i [Enlarge Print Area] PDF JPEG TIFF XPS

If you select the check box, the image is printed by extending the printable area fully to the paper size. However, a part of the image may be missing near the edge of the paper or the paper may be partly tainted depending on the original.

j [Print 2-Sided]

Select the check box to print on both sides of the paper.

k [Binding Location]

Select whether to bind the long edge or short edge of the printouts with a binding tool such as a stapler. Printing orientation will be changed depending on the specified binding position. You can also specify the binding margin ( **Gutter(P. 349)**).

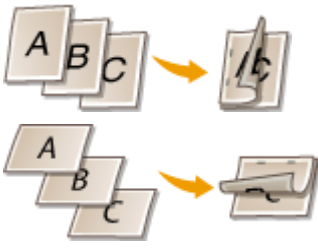
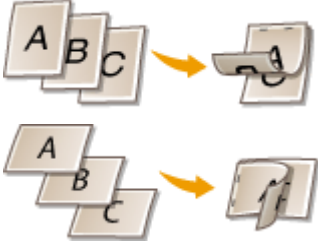
[Long Edge]	<p>Binds the printouts on the long edge.</p> 
[Short Edge]	<p>Binds the printouts on the short edge.</p> 

l [Show Warnings] JPEG TIFF

You can specify how the machine should behave if an error occurs.

[Print]	Error information is printed and no image is printed.
[Panel]	No image is printed and an error message is displayed on the operation panel.
[Off]	No image is printed and no error is displayed.

m [N on 1] PDF XPS

Specify whether or not to print multiple pages onto a single sheet by sequentially allocating them. For example, to print four pages onto a single sheet, select [4 on 1].



NOTE:

- If [Paper Size] is set to [Auto], this item is unavailable.



n [Page Order] PDF XPS

Select a page distribution layout.



o [Finishing] PDF XPS

Specify the method to collate the printouts when printing multiple-page documents. This item is displayed when the SD card is installed.

[Off]	<p>The printouts are not collated. The specified number of copies are printed for each page. For example, if you are printing three copies of a four-page document, the printouts will be arranged in the following page order: 1, 1, 1, 2, 2, 2, 3, 3, 3, 4, 4, 4.</p> 
[Collate]	<p>The printouts are grouped into complete sets in sequential page order. For example, if you are printing three copies of a four-page document, the printouts will be arranged in the following page order: 1, 2, 3, 4, 1, 2, 3, 4, 1, 2, 3, 4.</p> 

p [Comment Print] PDF

Select whether to print comments.

[Auto]	Prints comments in the PDF file.
[Off]	Prints no comments.

q [Store in Box] PDF PS XPS

You can store a document in the SD card installed on the machine without making printouts. Select the check box to store the document in a box specified in [Box Number (00-99)]. You can print the documents in the box from the operation panel as many times as you want. For how to print a document, see **Printing a Document Stored in the Machine(P. 94)** . This item is displayed when the SD card is installed.

LINKS

▶ **Printing without Opening a File (Direct Print)(P. 101)**

Printing Received E-mail (E-Mail Print)

51W4-02F

E-Mail Print allows you to print the message and attached image files of an e-mail received from the POP3 mail server without using a computer. E-mails can be manually received as well as being automatically received at regular intervals. When the SMTP protocol is used, e-mails directly sent to the machine via no mail server are printed.

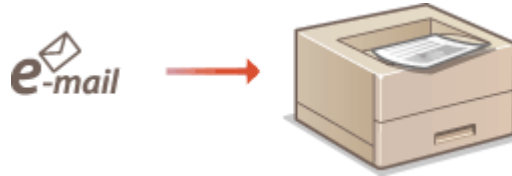

- ▶ **Configuring E-Mail Print Settings(P. 111)**
- ▶ **Manually Receiving E-Mails(P. 115)**

NOTE

- When you set <TIFF Spooler> in the Setup menu to <On>, the received data is temporarily stored in the machine or SD card before printed. This reduces the occurrence of errors. ▶ **TIFF Spooler(P. 383)**

Configuring E-Mail Print Settings

This section describes how to specify the settings for receiving and printing e-mails on this machine. Use a computer to specify the settings for receiving e-mails and the operation panel of the machine to specify the settings for printing e-mails.

From a Computer

- 1 Start the Remote UI and log on in Management Mode. ▶ Starting Remote UI(P. 284)**
- 2 Click [Settings/Registration].**

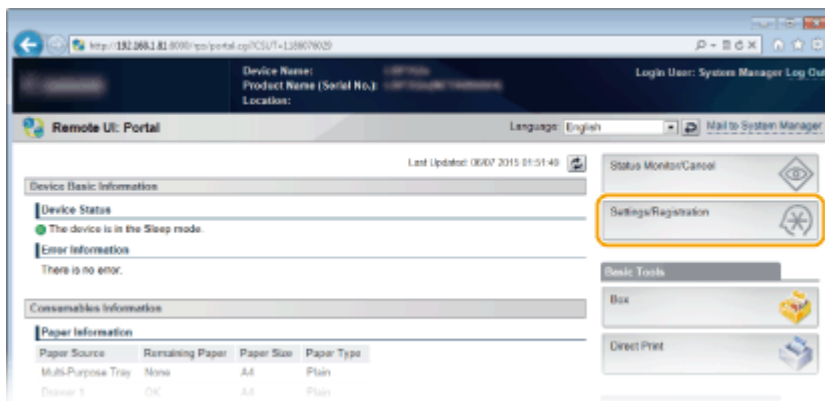

- 3 Click [Network] ▶ [E-Mail Print Settings].**

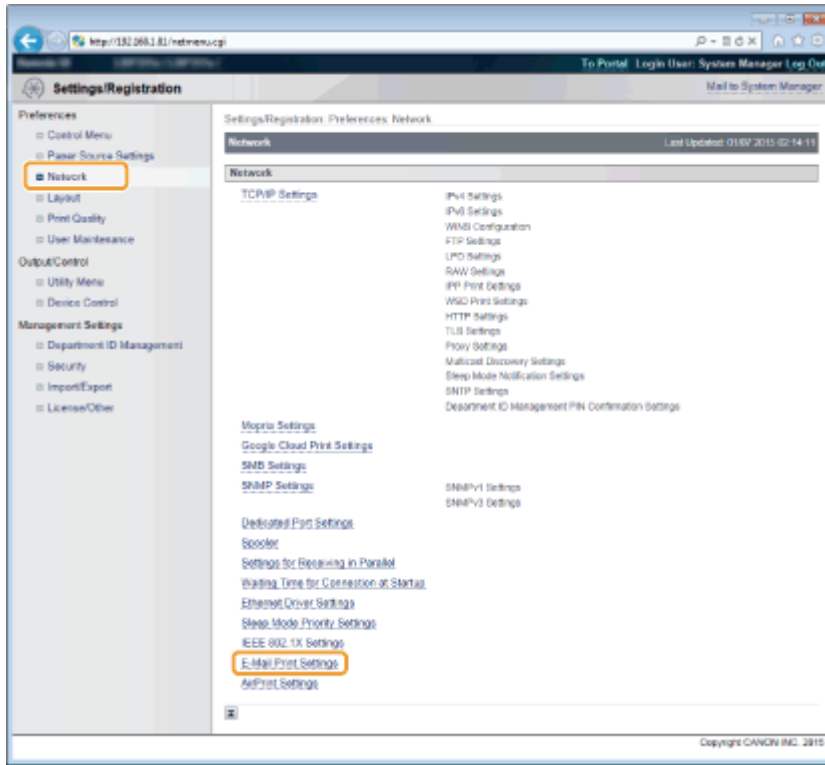

4 Click [Edit].

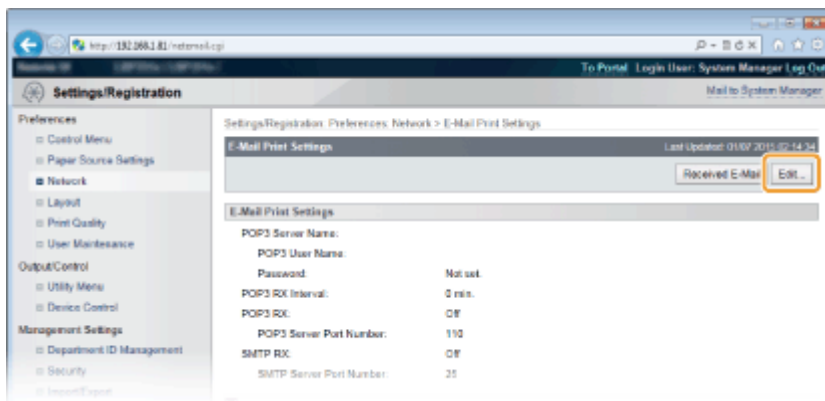

5 Specify the settings for E-Mail Print.

■ When performing E-Mail Print from POP3 mail server

When the e-mail receiving starts, all e-mails stored in the mailbox of the mail server are printed. If you send e-mails that you want to print to the machine in advance, you can automatically print the e-mails at regular time intervals or print all stored e-mails in an arbitrary timing.

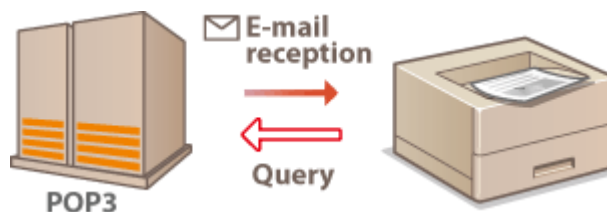

IMPORTANT:

- We recommend using the mail address exclusively for E-Mail Print because all e-mails received into the machine are deleted from the mail server.

Conditions of use for POP3 protocol

- The POP3 mail server must support the UIDL command. For details, contact your network administrator or server administrator.

[POP3 Server Name]

Enter the mail server name or IP address for receiving e-mails.

[POP3 User Name]

Enter alphanumeric characters for the user name used to connect to the mail server.

[Set/Change Password]

To set the password for connecting to the mail server, select the check box and enter alphanumeric characters for the password in the [Password] text box. For confirmation, enter the same password in the [Confirm] text box.

[POP3 RX Interval]

Specify the interval for automatically connecting to the mail server in minutes. New e-mails in the mailbox of the mail server are automatically received and printed at the specified time intervals. You can also specify this setting by using <POP3 RX Interval> in the setting menu of the operation panel (**▶POP3 RX Interval(P. 344)**).

NOTE:

Preventing E-mails from Being Automatically Received

- Set [POP3 RX Interval] to [0]. If you set [0], you must manually receive e-mails. **▶Manually Receiving E-Mails(P. 115)**

[POP3 RX]

Select the check box to enable E-Mail Print from the POP3 mail server. You can also specify this setting by using <POP3 RX> in the setting menu of the operation panel (**▶POP3 RX(P. 345)**).

[POP3 Server Port Number]

Specify the port number of the mail server that receives e-mails.

■When performing E-Mail Print by using SMTP protocol

If e-mails are sent to the machine via SMTP, the machine prints the e-mails immediately after receiving them. Enable this function when you want to forward fax documents from Canon multifunction printers to this machine and print them on the machine (**▶To forward fax documents from Canon multifunction printers(P. 115)**).



[SMTP RX]

Select the check box to enable E-Mail Print by using the SMTP protocol. You can also specify this setting by using <SMTP RX> in the setting menu of the operation panel (**▶SMTP RX(P. 345)**).

[SMTP Server Port Number]

Specify the port number of the SMTP server for receiving e-mails.

6 Click [OK].

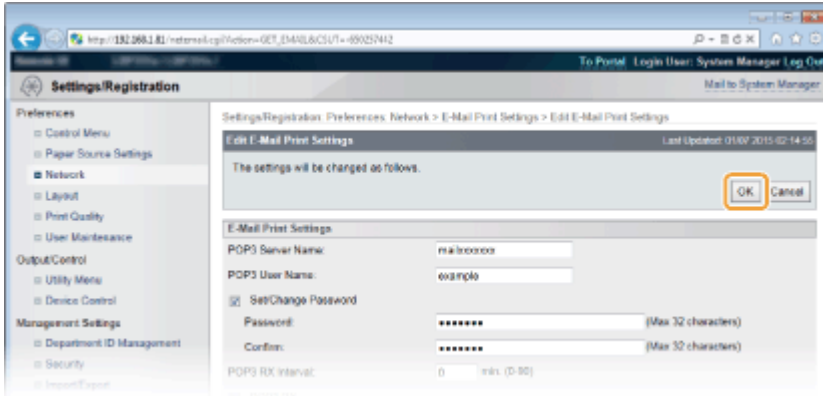

7 Perform a hard reset.

- Click [Device Control], select [Hard Reset], and then click [Execute].

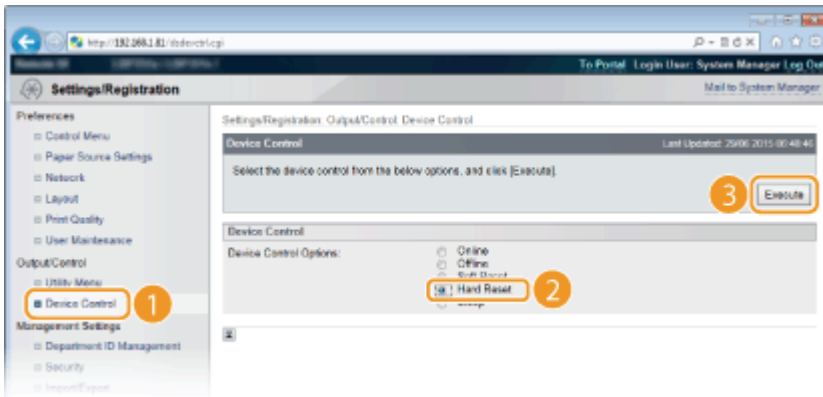

⇒ The settings are enabled after the hard reset is performed.

From the Operation Panel

8 Specify other settings for E-Mail Print as necessary.

- **Specify whether or not to print the e-mail message.**
 - ▶ **Print E-Mail Text(P. 384)**
- **You can limit the number of pages to print the e-mail message.**
 - ▶ **Limit E-Mail Print(P. 384)**
- **You can specify the settings for printing attached image files.**
 - ▶ **Image Orientation(P. 381)**
 - ▶ **Zoom(P. 382)**

- ▶ **Print Position(P. 382)**
- ▶ **TIFF Spooler(P. 383)**
- ▶ **Show Warnings(P. 383)**
- ▶ **Enlarge Print Area(P. 385)**
- ▶ **Halftones(P. 385)**
- ▶ **Grayscale Conversion(P. 386)**

■ **Specify whether or not to display an E-Mail Print error.**

- ▶ **Show Warnings(P. 315)**

Manually Receiving E-Mails

If e-mail printing from the POP3 mail server is enabled, you can manually receive and print e-mails as well. When you want to connect to the mail server before automatically receiving e-mails or the machine is configured to prevent e-mails from being automatically received, follow the procedure below to manually receive the e-mails.

1 Press ◀ (⏪/⏩).

- When the machine is offline, it does not operate even if ◀ (⏪/⏩) is pressed. Set the machine to Online.
▶ **Online key(P. 26)**

2 Use ▲ / ▼ **to select** <E-Mail Print Utility>, **and press** OK.

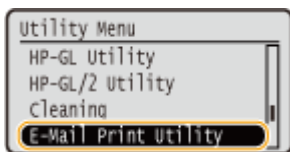

3 Select <Received E-Mail>, **and press** OK.

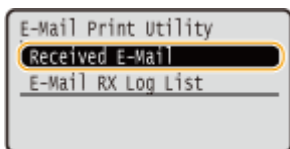

4 Select <Yes>, **and press** OK.

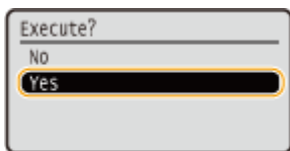

⇒ The machine is connected to the mail server. E-Mail Print is started for new e-mails in the mailbox of the mail server if any.

To forward fax documents from Canon multifunction printers

Enable SMTP RX on this machine, and then specify the IP address of the machine as the Internet Fax (I Fax) Address on the source multifunction printer. Forwarded fax documents are printed immediately when received.

- Attached files can only be printed if they are in TIFF format. Only one TIFF file can be printed for each fax document.

- When the toner cartridge is nearly empty, no fax documents can be received. The fax documents that could not be received on this machine are printed on the source multifunction printer.
- When the optional SD card is installed on the machine, the maximum size of a printable TIFF file is limited to 100 MB.

LINKS

▶ **Checking History of Documents(P. 294)**

▶ **E-Mail RX Log List(P. 443)**

Can Be Used Conveniently with a Mobile Device

Can Be Used Conveniently with a Mobile Device	118
Connecting to a Mobile Device	119
Utilizing the Machine through Applications	120
Using AirPrint	121
Printing with AirPrint	125
If AirPrint Cannot Be Used	127
Using Google Cloud Print	128
Managing the Machine Remotely	132

Can Be Used Conveniently with a Mobile Device

51W4-02H

Combining the machine with a mobile device such as a smartphone or tablet enables you to use an appropriate application to perform printing with ease. You can also use a mobile device to operate the machine remotely, check the printing status, and change machine's settings.



- ▶ **Connecting to a Mobile Device(P. 119)**
- ▶ **Utilizing the Machine through Applications(P. 120)**
- ▶ **Managing the Machine Remotely(P. 132)**

Connecting to a Mobile Device

51W4-02J

Connect a mobile device and the machine via a wireless LAN router. For how to set and operate your wireless LAN router and mobile devices, see the instruction manuals for the devices or contact your manufacturers.



NOTE

- The machine does not come with a wireless LAN router. Have one ready as necessary.

Utilizing the Machine through Applications

51W4-02K

Perform printing and other operations from the mobile device connected to the machine using applications. Various applications including those exclusive to Canon are supported. Use properly in accordance with your device, the application, and the situation.

■ Using Canon PRINT Business

This application is used to perform printing and other operations from mobile devices that support iOS/Android. When printing, it is not necessary to perform operations on the machine. For more information on supported operating systems, detailed setting methods, and operations, see the application's Help or the Canon website (<https://global.canon/gomp/>).

IMPORTANT

- You can download Canon PRINT Business for free, but you will be charged the Internet connection fee.

■ Printing with Canon Print Service

You can easily print from the menu of applications that support the Android print subsystem. For more information on supported operating systems and detailed settings and procedures, see the Canon website (<https://global.canon/>).

■ Printing by Mopria®

The machine also supports Mopria®. Using Mopria® enables you to print from mobile devices that support Android using common operations and settings, even if manufacturers and models differ. For example, if you are using printers supporting Mopria® made by multiple manufacturers or a printer supporting Mopria® that is located in a place you are visiting, you can print without installing an application exclusive for each manufacturer or model. For more information on supporting models or operation environments, see <http://www.mopria.org>.



Confirming Mopria® Settings



Log on to the Remote UI in Management Mode (**▶ Starting Remote UI (P. 284)**) ▶ [Settings/Registration] ▶ [Network] ▶ [Mopria Settings] ▶ [Edit] ▶ Check that the [Use Mopria] check box is selected ▶ [OK]

■ Printing with Google Cloud Print

You can use applications and services which support Google Cloud Print to print from a computer or mobile device without using a printer driver. **▶ Using Google Cloud Print (P. 128)**

Using AirPrint

51W4-02L

You can print without using printer driver by sending print data from Apple devices.



AirPrint settings

- ▶ **Configuring AirPrint Settings(P. 121)**
- ▶ **Displaying the Screen for AirPrint(P. 123)**

Functions of the AirPrint

- ▶ **Printing with AirPrint(P. 125)**

Troubleshooting

- ▶ **If AirPrint Cannot Be Used(P. 127)**

Configuring AirPrint Settings

You can register information, including the name of the machine and installation location, that is used for identifying the machine. You can also disable the AirPrint function of the machine. Use the Remote UI to change these settings.

1 Start the Remote UI and log on in Management Mode. ▶ Starting Remote UI(P. 284)

2 Click [Settings/Registration].

- If you are using a mobile device, such as iPad, iPhone, or iPod touch, read "click" as "tap" in this section.

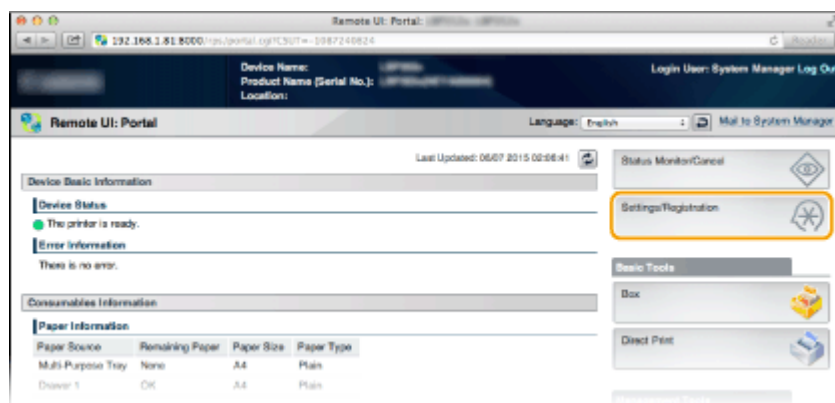

3 Click [Network] ▶ [AirPrint Settings].

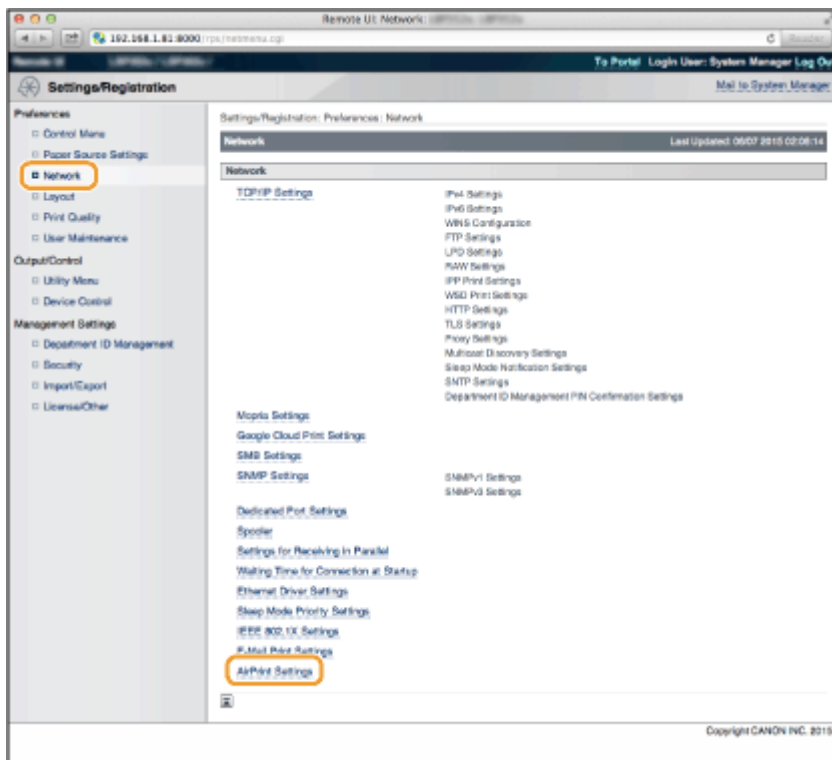

4 Click [Edit].

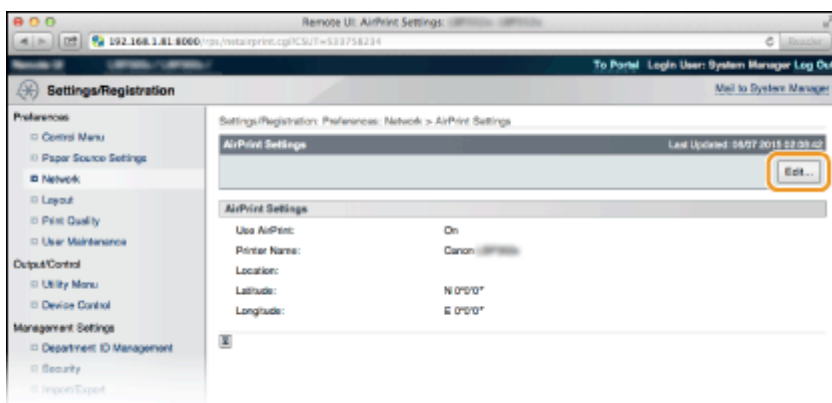

5 Specify the required settings, and click [OK].

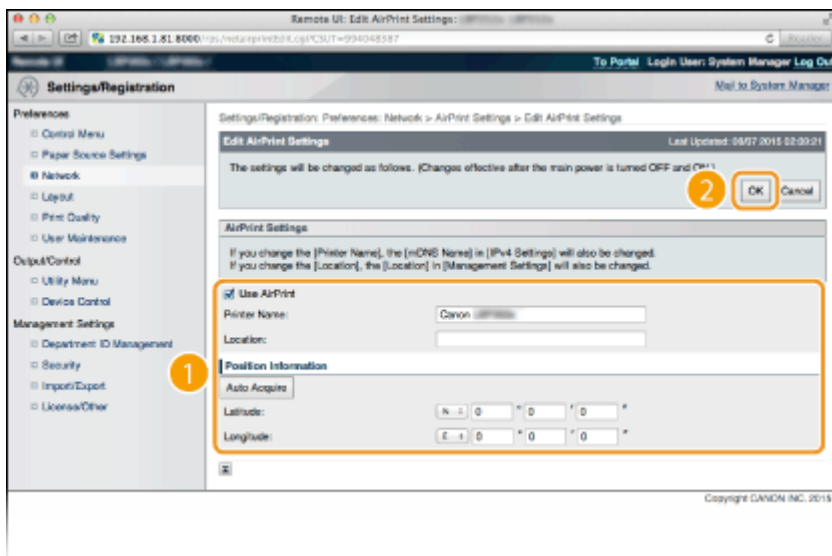

[Use AirPrint]

Select the check box to enable AirPrint. To disable AirPrint, clear the check box.

[Printer Name]/[Location]/[Latitude]/[Longitude]

Enter the name and the installation location information to help you identify this machine when operating your Apple device. This information is useful if you have more than one AirPrint printer.

NOTE:

If you select the [Use AirPrint] check box

The following items are also set to <On> automatically.

- <mDNS Settings> in IPv4 and IPv6 (▶ **Configuring DNS(P. 172)**)
- <HTTP> (▶ **Disabling HTTP Communication(P. 240)**)
- <IPP Print> (▶ **Configuring Printing Protocols and WSD Functions(P. 149)**)

If you change [Printer Name]

- If you change [Printer Name] that you have once specified, you may be unable to print any more from the Mac that has been able to be used for printing so far. This phenomenon occurs because <mDNS Name> (▶ **Configuring DNS(P. 172)**) of IPv4 is also changed automatically. In this case, add the machine to the Mac again.

NOTE

Using the operation panel

- You can also enable or disable AirPrint from the setting menu of the operation panel.

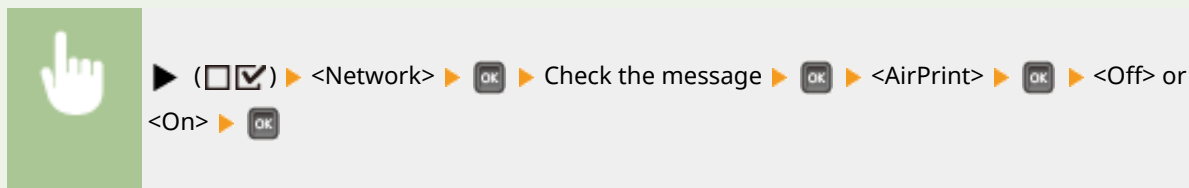

Displaying the Screen for AirPrint

You can display the screen for AirPrint, on which you can not only access the AirPrint Settings but also view information about consumables, such as paper and toner cartridge. Further, you can configure security function settings (▶ **Using TLS for Encrypted Communications(P. 246)**).

- 1** Click [System Preferences] in the Dock on the desktop ▶ [Printers & Scanners].
- 2** Select your printer and click [Options & Supplies].
- 3** Click [Show Printer Webpage].
- 4** Log on to the Remote UI.
 - To change AirPrint settings, log on in Management Mode.

⇒ The page dedicated for AirPrint is displayed.

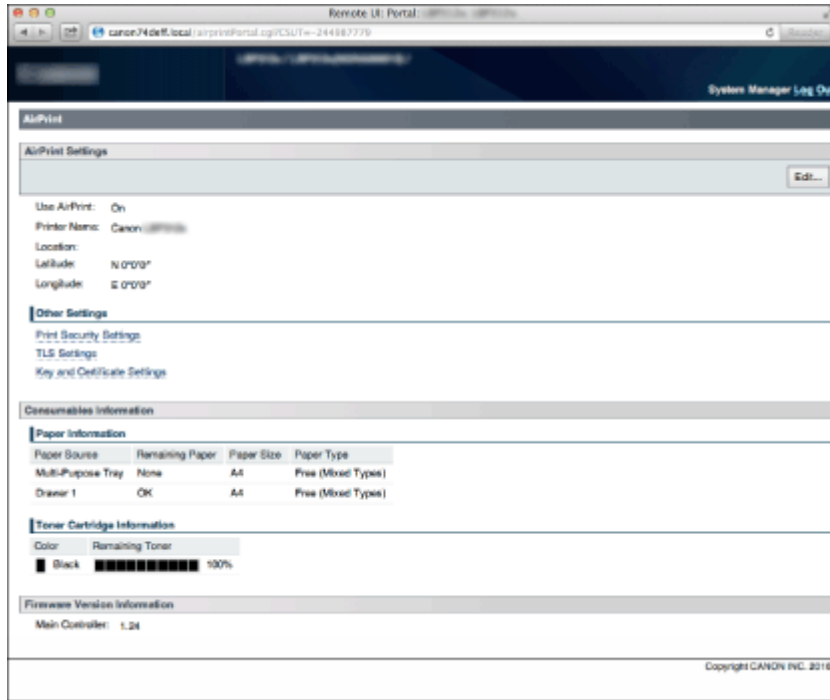

Trademarks

Apple, Bonjour, iPad, iPhone, iPod touch, Mac, macOS, OS X and Safari are trademarks of Apple Inc., registered in the U.S. and other countries. AirPrint and the AirPrint logo are trademarks of Apple Inc.

Printing with AirPrint

51W4-02R

You do not necessarily need to use a computer for printing e-mails, photos, Web pages, and other documents. AirPrint enables you to print directly from Apple devices such as iPad, iPhone, and iPod touch.

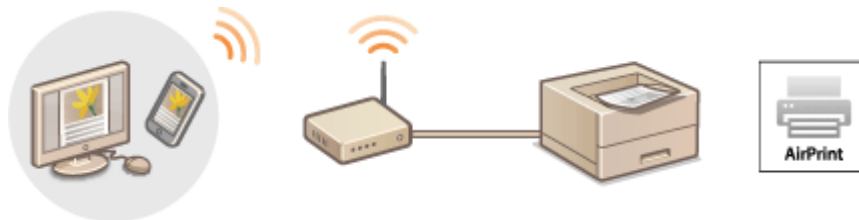

▶ **Printing from iPad, iPhone, or iPod touch(P. 125)**

▶ **Printing from Mac(P. 126)**

System Requirements

To print with AirPrint, you need one of the following Apple devices.

- iPad (all models)
- iPhone (3GS or later)
- iPod touch (3rd generation or later)
- Mac (Mac OS X 10.7 or later)*

*OS X 10.9 or later when you use USB connection.

Network Environment

You need one of the following environments.

- The Apple device and the machine are connected to the same LAN.
- The Mac and the machine are connected via USB.

NOTE:

When using USB connection

- Set <USB-Connected PC OS> to <Mac OS>. ▶ **USB-Connected PC OS(P. 320)**

Printing from iPad, iPhone, or iPod touch

1 Make sure that the machine is turned ON and that it is connected to your Apple device.

- For how to make sure of this, see "Getting Started." ▶ **Manuals and Their Contents(P. 500)**

2 From the application on your Apple device, tap  to display the menu options.

3 From the drop-down list, tap [Print].

4 Select this machine from [Printer] in [Printer Options].

- The printers connected to the network are displayed. Select this machine in this step.

IMPORTANT:

- [Printer Options] is not displayed on applications that do not support AirPrint. You cannot print by using those applications.

5 Specify the print settings as necessary.

NOTE:

- The available settings and paper sizes differ depending on the application you are using.

6 Tap [Print].

⇒ Printing starts.

NOTE:

Checking the print status

- During printing, press the Home button of the Apple device twice ► tap [Print].

Printing from Mac

1 Make sure that the machine is turned ON and that it is connected to your Mac.

- For how to make sure of this, see "Getting Started." ► [Manuals and Their Contents\(P. 500\)](#)

2 Add the machine to the Mac from [System Preferences] ► [Printers & Scanners].

3 Open a document in an application and display the print dialog box.

- How to display the print dialog box differs for each application. For more information, see the instruction manual for the application you are using.

4 Select this machine in the print dialog box.

- The printers connected to the Mac are displayed. Select this machine in this step.

5 Specify the print settings as necessary.

NOTE:

- The available settings and paper sizes differ depending on the application you are using.

6 Click [Print].

⇒ Printing starts.

If AirPrint Cannot Be Used

51W4-02S

If AirPrint cannot be used, try taking the following solutions.

- Make sure that the machine is turned ON. If the machine is turned ON, first turn it OFF, then wait for at least 10 seconds and then turn it back ON to check if the problem is solved.
- Make sure that no error messages are displayed on the machine.
- Make sure that Apple devices and the machine are connected to the same LAN. If the machine is turned ON, it may take several minutes before the machine is ready for communication.
- Make sure that Bonjour on your Apple device is enabled.
- Make sure that the machine is configured to enable printing from a computer even when no department ID and password are entered. ▶ **Blocking Jobs When Department ID Is Unknown(P. 213)**
- Make sure that the paper is loaded in the machine and the machine has sufficient toner cartridge remaining. ▶ **Displaying the Screen for AirPrint(P. 123)**

Using Google Cloud Print

51W4-02U

Google Cloud Print is a service that enables a user with a Google account to print from a smartphone, tablet, or computer connected to the Internet using applications compatible with Google Cloud Print. Unlike conventional printing from a computer, it does not require a printer driver.



- ▶ **Checking the Machine Settings(P. 128)**
- ▶ **Changing Google Cloud Print Settings(P. 128)**
- ▶ **Registering the Machine with Google Cloud Print(P. 129)**

IMPORTANT

- When registering the machine or when using Google Cloud Print to print documents, you must be able to connect the machine to the Internet. You are also responsible for paying all Internet connection fees.
- You may not be able to use this function in some countries or regions.
- Google Cloud Print does not support printing from IPv6 addresses.

NOTE

- To use Google Cloud Print, a Google account is required. If you do not have one, access Google Web site to create your account.

Checking the Machine Settings

Before setting up Google Cloud Print, check the following:

- Make sure that the machine is assigned an IPv4 address and connected to a computer over a network. ▶ **Connecting to a Wired LAN(P. 137)**
- Make sure that the date and time settings are correct. ▶ **Date/Time Settings(P. 316)**
- If the Department ID Management is enabled, make sure that the machine is configured to enable printing from a computer even when no Department ID and PIN are entered. ▶ **Blocking Jobs When Department ID Is Unknown(P. 213)**

Changing Google Cloud Print Settings

Enable the Google Cloud Print function of the machine. You can also disable the Google Cloud Print function of the machine.

1 Press ▶ (□☑).

2 Use ▲ / ▼ to select <Network>, and press **OK**.

- When a message appears, press **OK**.

3 Select <Google Cloud Print>, and press **OK**.

4 Select <Use Cloud Print>, and press **OK**.

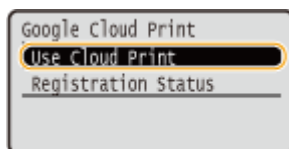

5 Select <Off> or <On>, and press **OK**.

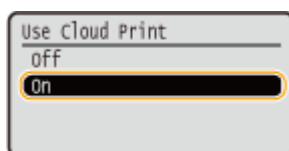

Registering the Machine with Google Cloud Print

Registering the machine with Google Cloud Print allows you to print from anywhere.

1 Start the Remote UI and log on in Management Mode. ▶ Starting Remote UI(P. 284)

2 Click [Settings/Registration].

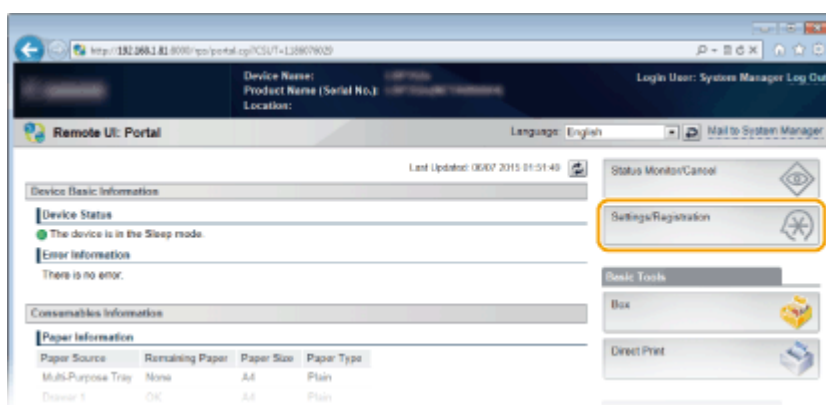

3 Click [Network] ▶ [Google Cloud Print Settings].

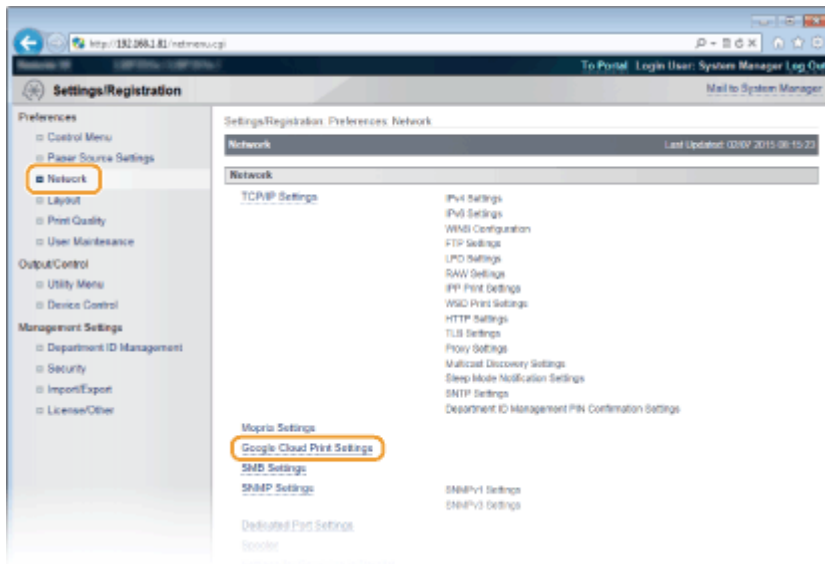

4 Click [Register] in [Registration Status].

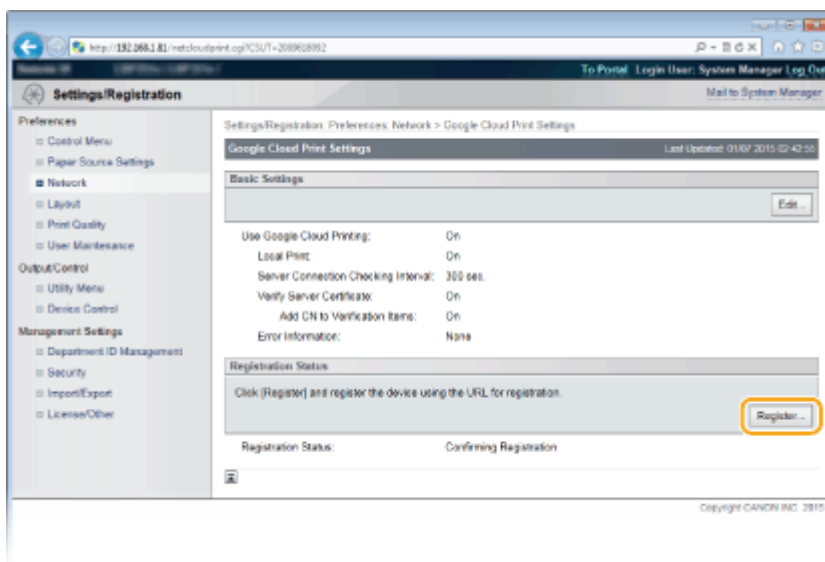

NOTE:

If [Register] is unavailable

- You need to enable Google Cloud Print. Click [Edit], select the [Use Google Cloud Print] check box, and then click [OK].

To reregister the machine

- To reregister the machine if the owner of the machine has changed or for other reasons, unregister the machine and register it again.

5 Click the link of the URL displayed for [URL for Registration].

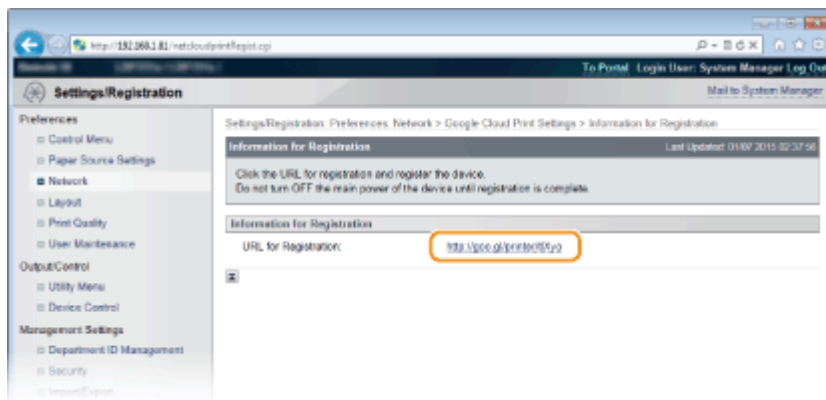

6 Follow the on-screen instructions to register the machine.

- ▶ Printing can now be performed from applications that support Google Cloud Print, such as Google Chrome™.

NOTE:

- Access the Google Cloud Print Web site for information about the latest applications that support Google Cloud Print.

NOTE

Registering from a mobile device or Google Chrome

You can also register the machine from a mobile device or Google Chrome. The machine's display shows the following confirmation screen before completion of the registration. Perform **OK** ▶ **<Yes>** ▶ **OK** to complete the registration.

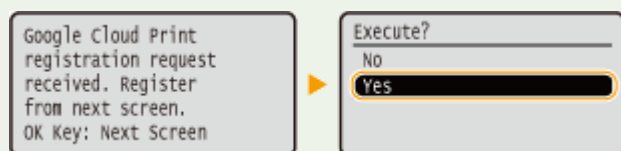

- To perform the registration, the main screen need to be displayed. Press **OK** (●—●) to display the main screen and then proceed to the registration.
- For the registration procedure, see the instruction manual for your mobile device or the Google Cloud Print Web site.

Managing the Machine Remotely

51W4-02W

You can use the Remote UI from a Web browser installed on your mobile device. This allows you to check the machine's status and specify machine's settings from your mobile device. Note that the Remote UI screen may not be displayed properly for some devices and environments.



Starting Remote UI with a Mobile Device

Enter the IP address of the machine into the Web browser and start the Remote UI. Check the IP address set to the machine in advance ([▶Network Status Print\(P. 441\)](#)). If you have any questions, ask your Network Administrator.

1 Start the Web browser on your mobile device.

2 Enter "http://(the IP address of the machine)/" in the address field.

- If you want to use an IPv6 address, enclose the IPv6 address with brackets (example: http://[fe80::2e9e:fcff:fe4e:dbce]/).

LINKS

[▶Using Remote UI\(P. 283\)](#)

Network

Network	134
Connecting to a Network	135
Connecting to a Wired LAN	137
Setting IP Addresses	139
Setting IPv4 Address	140
Setting IPv6 Addresses	144
Configuring the Machine for Printing from a Computer	148
Configuring Printing Protocols and WSD Functions	149
Enabling IPP/IPPS	155
Configuring Printer Ports	161
Setting Up Print Server	164
Configuring the Machine for Your Network Environment	168
Configuring Ethernet Settings	169
Setting a Wait Time for Connecting to a Network	171
Configuring DNS	172
Configuring WINS	178
Configuring SNTP	181
Monitoring and Controlling the Machine with SNMP	184
Configuring Settings for Device Management Software	190
Configuring SMB	194
Configuring Settings on the Computer for Printing	197

Network

51W4-02X

The machine has been designed for flexibility of use across a variety of environments, and it includes advanced technologies in addition to basic network features. Do not worry if you are not a network expert, because the machine has also been designed for convenience and ease of use. Relax and proceed with the network setup one step at a time.

■ Connecting to a Computer/Viewing the Machine's Network Settings

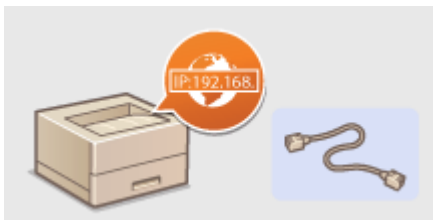

▶ Connecting to a Network(P. 135)

■ Configuring for Printing



▶ Configuring the Machine for Printing from a Computer(P. 148)

■ Customizing the Machine for More Convenient Network Experience

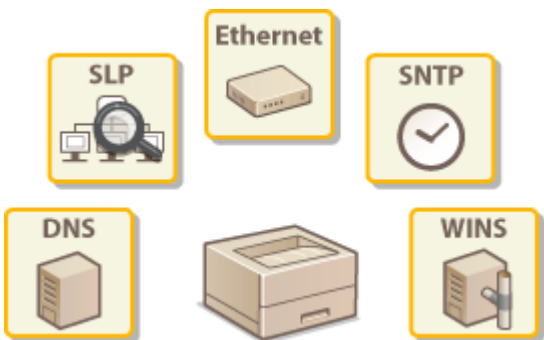

▶ Configuring the Machine for Your Network Environment(P. 168)

Connecting to a Network

51W4-02Y

The machine can be connected to a network via wired LAN, requiring a unique network IP address. For specific IP address settings, contact your Internet service provider or network administrator.

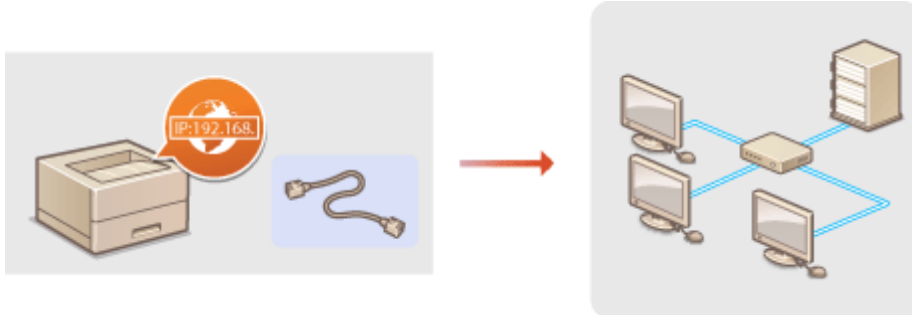

IMPORTANT

- If the machine is connected to an unsecured network, your personal information might be leaked to a third party.

NOTE

- The machine does not come with a LAN cable or router. Have them ready as necessary.

■ Before You Start

Follow these steps to connect the machine to a network.



Check your computer settings.

- Make sure that the computer is correctly connected to the network. For more information, see the instruction manuals for the devices you are using, or contact the device manufacturers.
- Make sure that the network settings have been completed on the computer. If the network has not been set up properly, you will not be able to use the machine on the network, even if you perform the rest of the procedure below.

NOTE:

- Depending on the network, you may need to change settings for the communication method (half-duplex/full-duplex) or the Ethernet type (10BASE-T/100BASE-TX/1000BASE-T) ([▶Configuring Ethernet Settings\(P. 169\)](#)). For more information, contact your Internet service provider or Network Administrator.
- To check the MAC address of the machine.
[▶MAC Address\(P. 344\)](#)
- To connect to an IEEE 802.1X network, see [▶Configuring IEEE 802.1X Authentication\(P. 261\)](#) .





Connect to a wired LAN.

▶ **Connecting to a Wired LAN(P. 137)**

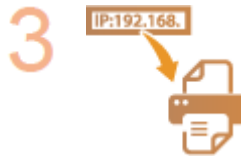

Set the IP address.

- At the time of purchase, the Auto IP function is activated to automatically acquire an IP address. However, this function may not be used depending on the network environment. In that case, set an IP address manually or configure to automatically acquire an IP address via the DHCP or other protocol.

▶ **Setting IP Addresses(P. 139)**

Connecting to a Wired LAN

51W4-030

Connect the machine to a computer via a router. Use a LAN cable to connect the machine to the router.

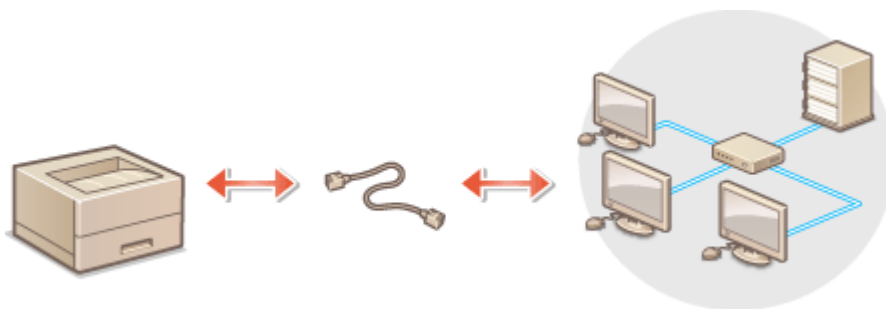

1 Connect a LAN cable.

- Connect the machine to a router by using a LAN cable.
- Push the connector in until it clicks into place.

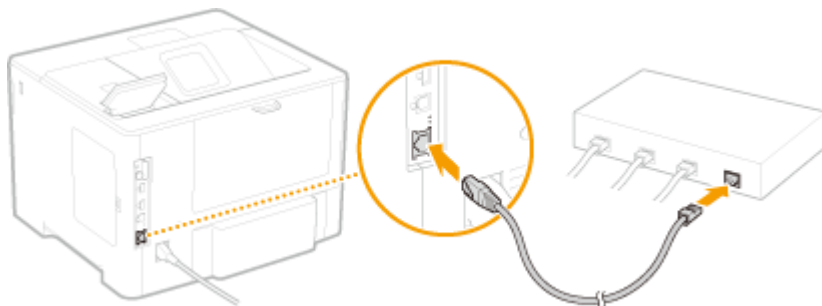

2 Check that the LNK indicator (a) is lit.

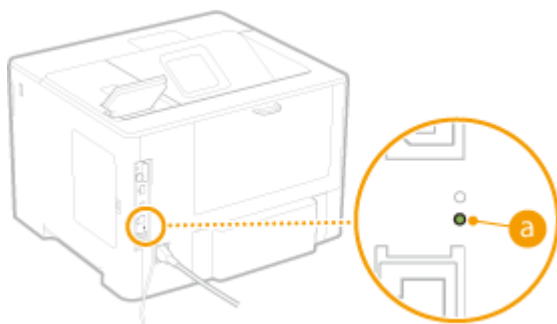

NOTE:

- When the LNK indicator does not light up, some problem with the wired LAN connection may have occurred. For more information, see "Troubleshooting (FAQ)" on the online manual website.

3 Set the IP address. ▶ Setting IP Addresses(P. 139)

- At the time of purchase, the Auto IP function is activated to automatically acquire an IP address. However, this function may not be used depending on the network environment. In that case, set an IP address manually or configure to automatically acquire an IP address via the DHCP or other protocol.

LINKS

▶ **Connecting to a Network(P. 135)**

Setting IP Addresses

51W4-031

Connecting the machine to a network requires a unique network IP address. Two versions of IP addresses are available: IPv4 and IPv6. Configure these settings depending on the network environment. To use IPv6 addresses, you need to properly configure the IPv4 address settings.

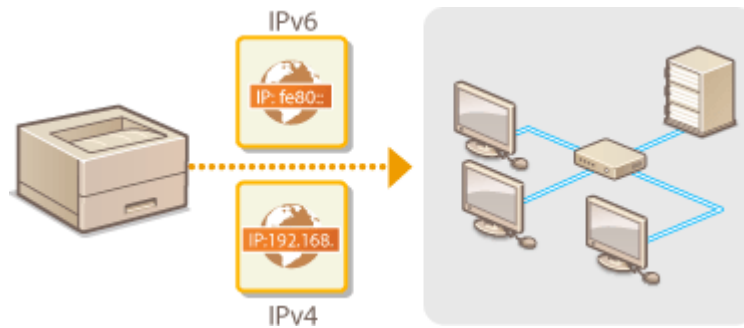

Setting IPv4 Address

51W4-032



The machine's IPv4 address can be either assigned automatically by a dynamic IP addressing protocol, such as DHCP, or entered manually. When connecting the machine to a wired LAN, make sure that the connectors of the LAN cable are firmly inserted into the ports (**Connecting to a Wired LAN(P. 137)**).

Setting IPv4 Address

- 1 Press **▶** ().
- 2 Use **▲ / ▼** to select **<Network>**, and press **OK**.
 - When a message appears, press **OK**.
- 3 Select **<TCP/IP Settings>** **▶** **<IPv4 Settings>** **▶** **<IP Mode>**.
- 4 Configure IP address settings.



a **<Auto>**

Select to automatically assign an IP address via a protocol such as DHCP.

b **<Manual>**

Select to configure the IP address settings by manually entering an IP address.

■ Automatically assigning an IP address

- 1 Select **<Auto>**, and press **OK**.

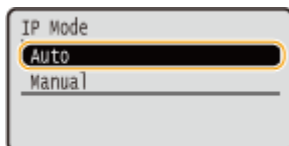

- 2 Select **<Protocol>**, and press **OK**.

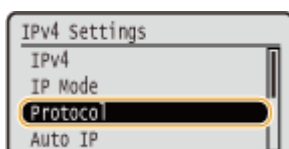

3 Select <Use DHCP>, <Use BOOTP>, or <Use RARP>, and press .

- You can use only one of the protocols DHCP, BOOTP, and RARP. If the selected protocol is set to <On>, the other two protocols are automatically set to <Off>.

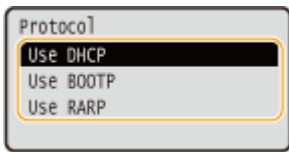

4 Select <On>, and press .

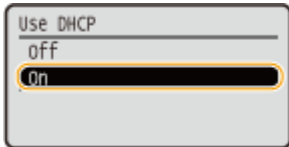

5 Press .

6 Select <Auto IP>, and press .

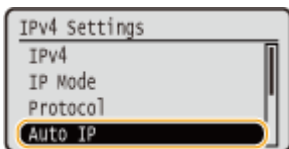

7 Select <On>, and press .

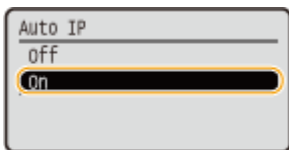

NOTE:

When using DHCP

If you turn OFF the power and ON again, an IP address differing from the current one will be assigned. This may disable printing. To use DHCP, specify one of the following settings after consulting the network administrator.

- Configuring the DNS Dynamic Update Function  **Configuring DNS(P. 172)**
- Specifying Settings for the DHCP Server to Constantly Assign the Same IP Address

If you do not want to use DHCP/BOOTP/RARP to assign an IP address

- Set all the protocols to <Off>. If you set <Use DHCP>, <Use BOOTP>, or <Use RARP> to <On> when the DHCP/BOOTP/RARP servers are unavailable, the machine will waste time and communication resources in searching the network for available services.

IP addresses that are given precedence

- IP addresses assigned via DHCP/BOOTP/RARP override the address obtained via Auto IP.

■ Manually entering an IP address

1 Select <Manual>, and press .

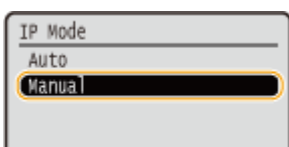

2 Select <IP Address Settings>, and press .

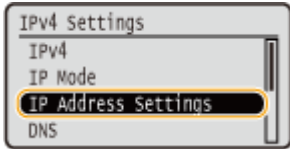

3 Specify the IP address, subnet mask, and gateway address (or default gateway).

- Select the item to set, press **OK**, enter an address, and press **OK**.

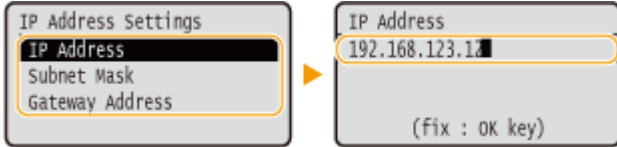

NOTE:

How to enter addresses

- Use **◀ / ▶** to move to the target field (a period-delimited input area), and use the numeric keys to increase/decrease the value.

When you are unsure of the IP address to input

- The IP address can be determined from the router settings of the network. **▶Determining the IP Address to Assign to the Machine(P. 142)**

5 Perform a hard reset. ▶Performing a Hard Reset(P. 408)

⇒ The settings are enabled after the hard reset is performed.

NOTE

Checking whether the settings are correct

- Make sure that the Remote UI screen can be displayed with your computer. **▶Starting Remote UI(P. 284)**

If you have changed the IP address after installing the printer driver

- You need to add a new port. **▶Configuring Printer Ports(P. 161)**

Determining the IP Address to Assign to the Machine

When you want to use a fixed IP address for the machine, you can determine the IP address as shown below.

■ To Determine the IP Address

An IP address consists of four numbers delimited by a period (.) (example: 192.168.1.45). Each number must be in the range from 0 to 255. In general, set the first three numbers to be the same as those for the router because they are common in the network. Determine the last number (for example, 45 in 192.168.1.45) that is different from that for other devices.



■ Checking the Router Settings

When you want to use a fixed IP address, check the settings of the DHCP that functions to automatically assign an IP address in a network. To avoid duplication of the IP address, you need to set an IP address outside the range of IP addresses assigned by DHCP. Since a router often functions as a DHCP server, check the router settings.

NOTE

- For how to display the setting screen of the router, see the instruction manual of your router.

1 Display the setting screen of the router.

2 Check the range of IP addresses assigned by DHCP.

- The range of IP addresses assigned by DHCP is set according to your router.

Example DHCP setting screen of the router:

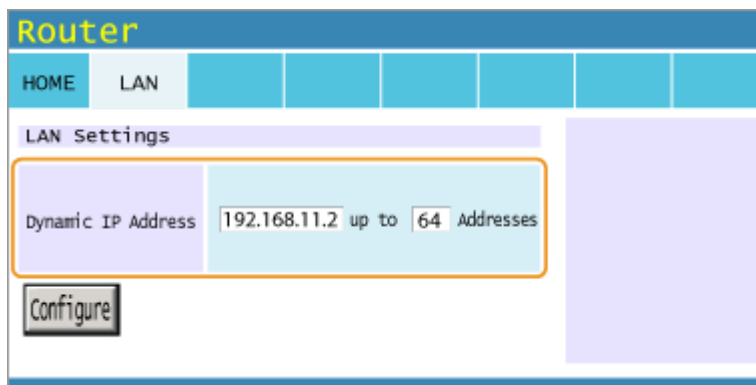

3 Determine the IP address of the machine.

- In the example screen shown in step 2, assign an IP address in the range of 192.168.11.66 to 192.168.11.254 to the machine because an IP address that the router assigns by DHCP is in the range of 192.168.11.2 to 192.168.11.65.

LINKS

- ▶ [Setting IPv6 Addresses\(P. 144\)](#)
- ▶ [Network Status Print\(P. 441\)](#)
- ▶ [Configuring WINS\(P. 178\)](#)

Setting IPv6 Addresses

51W4-033



The IPv6 addresses of the machine can be configured via the Remote UI. Before setting IPv6 addresses, check the IPv4 address settings ([▶Setting IPv4 Address\(P. 140\)](#)). You need to set the correct IPv4 settings to use IPv6 addresses. The machine can use the following multiple IPv6 addresses:

Type	Description
Link-local address	An address that is only valid within a subnet or link and cannot be used to communicate with devices beyond a router. A link-local address is automatically set when the IPv6 function of the machine is enabled.
Manual address	An address that is entered manually. When using this address, specify the prefix length and default router address.
Stateless address	An address that is generated automatically using the MAC address of the machine and the network prefix that is advertised by the router. Stateless addresses are discarded when the machine is restarted (or turned ON).
Stateful address	An address obtained from a DHCP server using DHCPv6.

- 1 Start the Remote UI and log on in Management Mode. [▶Starting Remote UI\(P. 284\)](#)
- 2 Click [Settings/Registration].

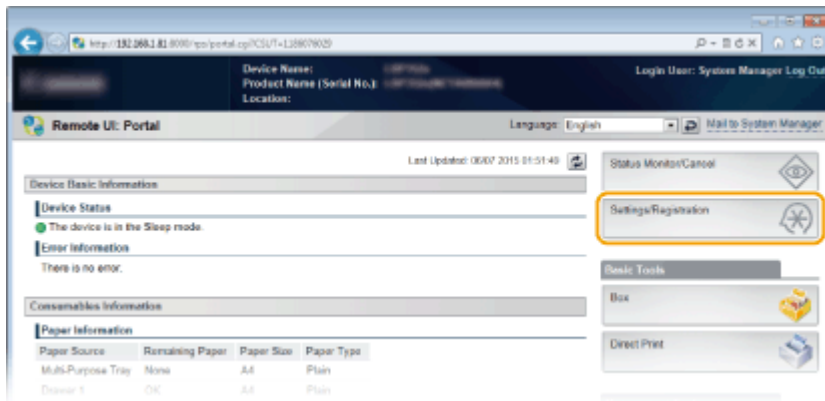

- 3 Click [Network] ▶ [TCP/IP Settings].

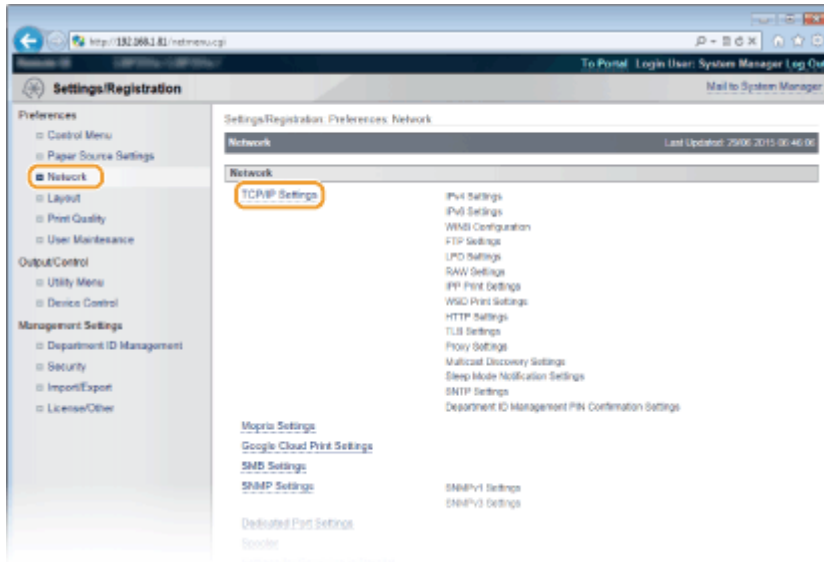

4 Click [Edit] in [IPv6 Settings].

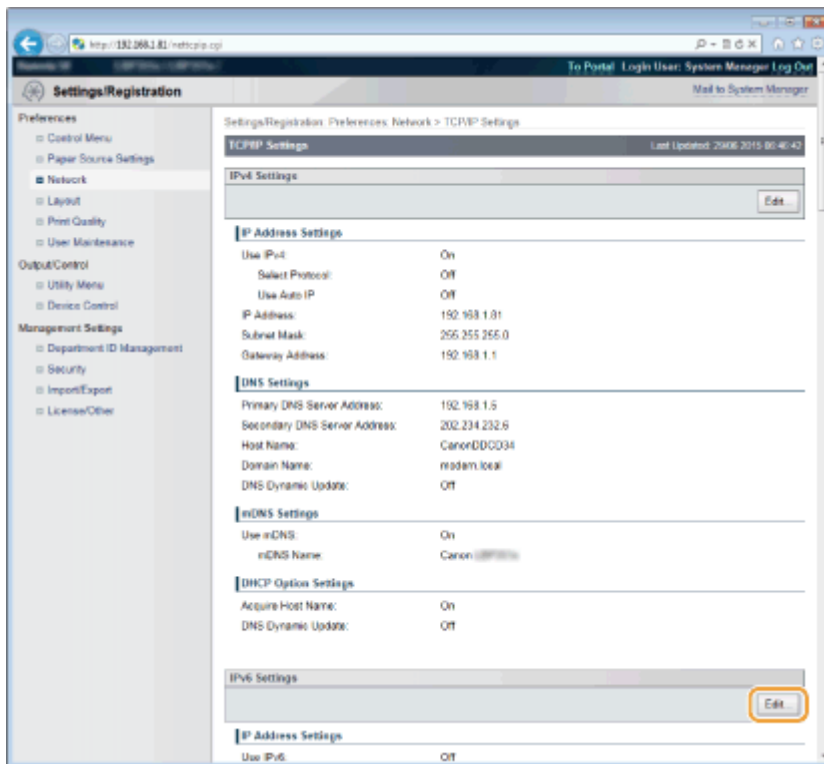

5 Select the [Use IPv6] check box and configure the required settings.

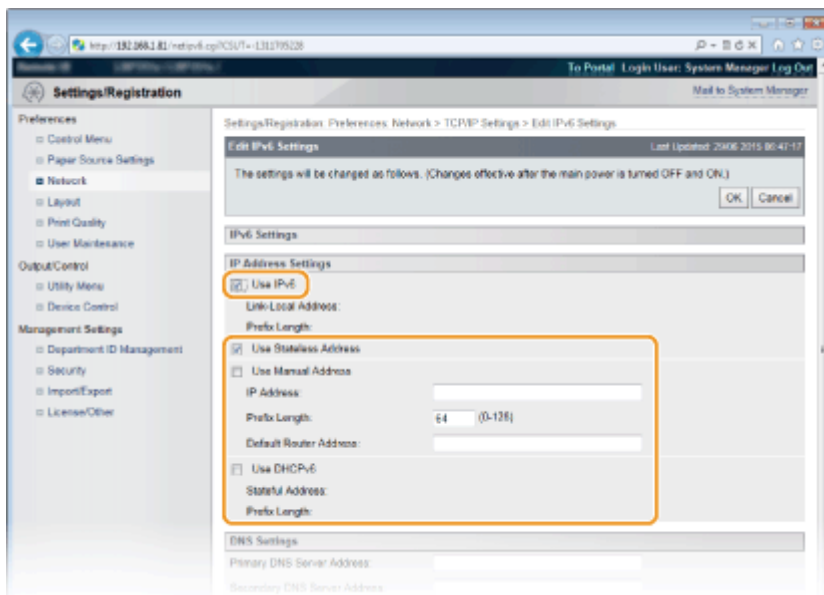
**[Use IPv6]**

Select the check box to enable IPv6 on the machine. When not using IPv6, clear the check box.

[Use Stateless Address]

Select the check box when using a stateless address. When not using a stateless address, clear the check box.

[Use Manual Address]

When you want to manually enter an IPv6 address, select the check box and enter the IP address, prefix length, and default router address in the corresponding text boxes.

[IP Address]

Enter an IPv6 address. You cannot enter an address that starts with "ff" (or multicast address), the address of "0000::0000" (all zeros), or an address that starts with "0:0:0:0:ffff" or "0:0:0:0:0."

[Prefix Length]

Enter a number that indicates how many bits are available for the network address.

[Default Router Address]

Specify the IPv6 address of the default router as necessary. You cannot enter an address that starts with "ff" (or multicast address), the address of "0000::0000" (all zeros), or an address that starts with "0:0:0:0:ffff" or "0:0:0:0:0."

[Use DHCPv6]

Select the check box when using a stateful address. When not using DHCPv6, clear the check box.

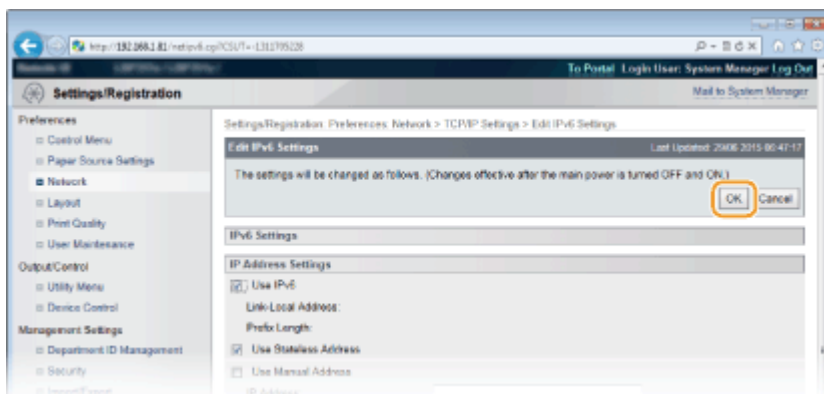
6 Click [OK].**7 Perform a hard reset.**

- Click [Device Control], select [Hard Reset], and then click [Execute].

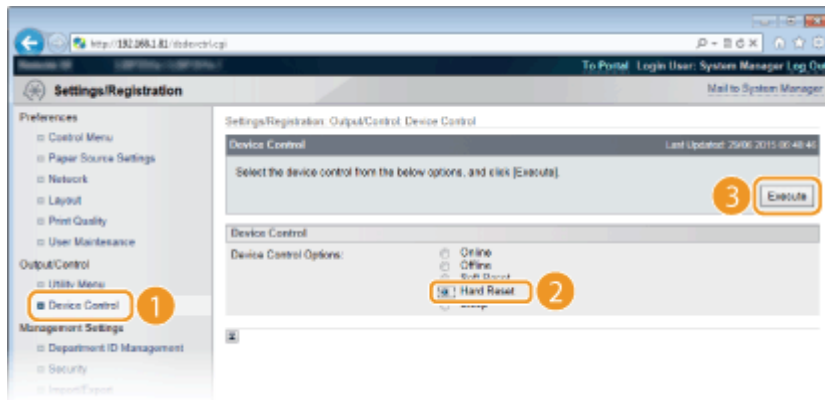

⇒ The settings are enabled after the hard reset is performed.

NOTE

Checking whether the settings are correct

- Make sure that the Remote UI screen can be displayed with your computer by using the IPv6 address of the machine. ▶ **Starting Remote UI(P. 284)**

Selecting settings from the operation panel

- You can also enable or disable IPv6 addresses from the setting menu of the operation panel. ▶ **IPv6 Settings(P. 329)**

If you have changed the IP address after installing the printer driver

- You need to add a new port. ▶ **Configuring Printer Ports(P. 161)**

LINKS

- ▶ **Setting IPv4 Address(P. 140)**
- ▶ **Network Status Print(P. 441)**

Configuring the Machine for Printing from a Computer

51W4-034

When using the machine as a network printer, you can configure the protocols and ports used for printing and create a print server for the machine. Before configuring the machine for printing from a computer, perform the basic setup procedures, including the printer driver installation. For more information, see the manuals for the relevant drivers on the online manual website.

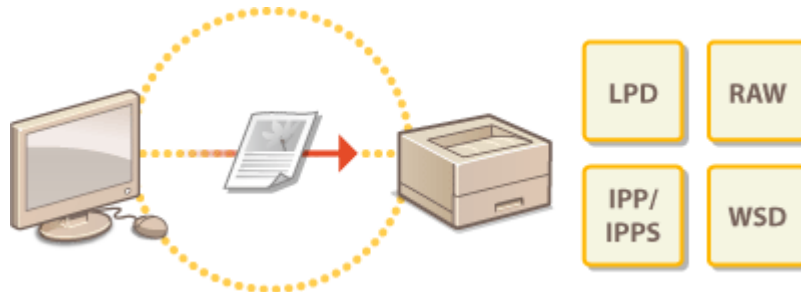

NOTE

- Printing protocols are rules for delivering document data created on a computer to the machine, and can be selected according to the printing purpose or the network environment.
- Ports are gateways for passing document data from a computer to the printer. Incorrect port settings are often the cause when documents cannot be printed from a network computer.

Configuring Printing Protocols and WSD Functions

51W4-035

Configure the protocols that are used for printing documents from a networked computer. For the print protocols supported by the machine, see **▶Network Environment(P. 484)** . This section describes the settings of LPD, RAW, IPP/IPPS, and WSD.

NOTE

To use FTP

- On how to configure settings, see the item below.
 - ▶Using FTP Clients(P. 508)**

- 1 Start the Remote UI and log on in Management Mode. ▶Starting Remote UI(P. 284)**
- 2 Click [Settings/Registration].**

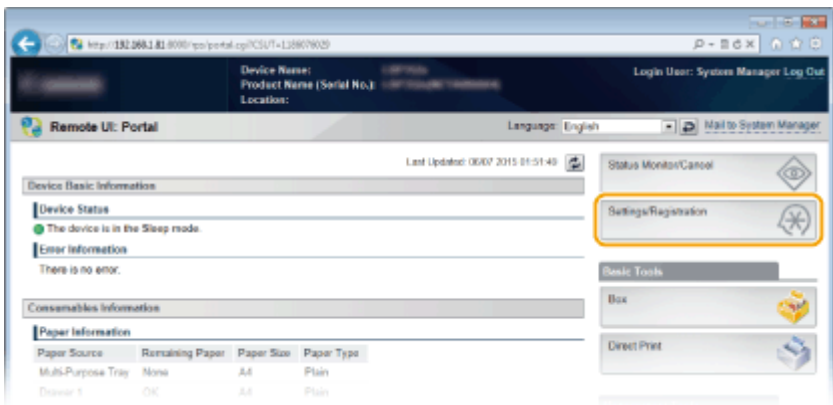

- 3 Click [Network] ▶ [TCP/IP Settings].**

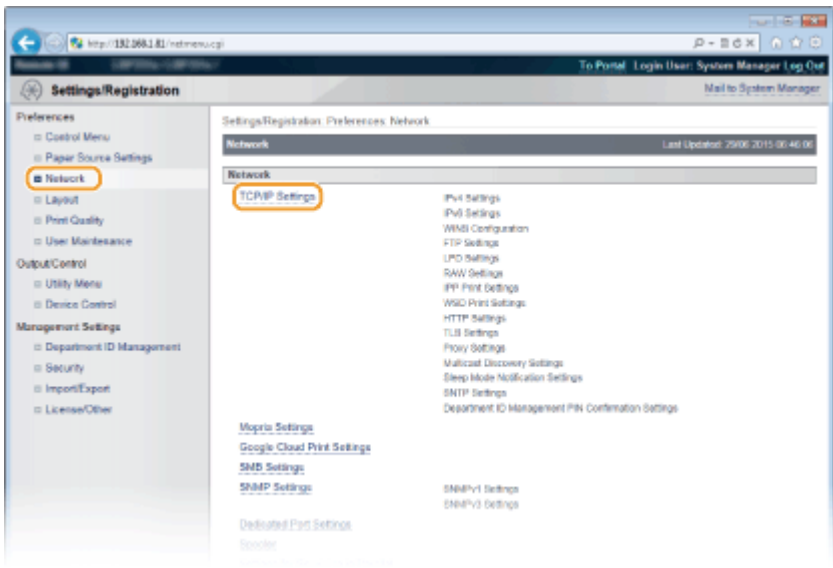

- 4 Configure printing protocols.**

■ Configuring LPD settings

- 1 Click [Edit] in [LPD Settings].

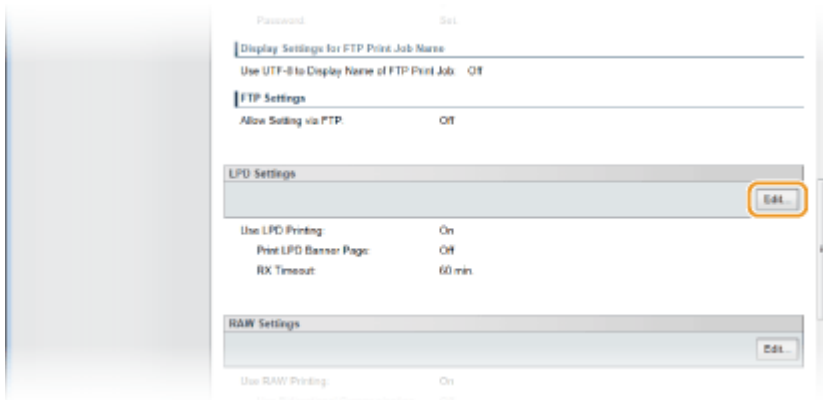

- 2 Configure the settings as necessary.

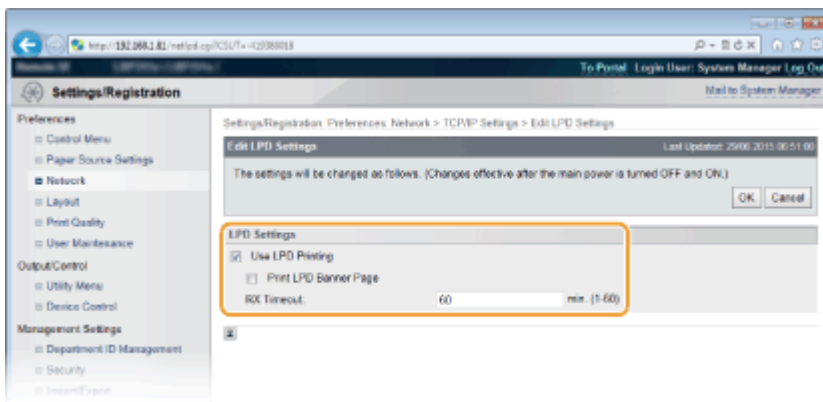

[Use LPD Printing]

When using LPD for printing, select the check box. When not using, clear the check box.

[Print LPD Banner Page]

Select the check box to include the information such as user names and file names on printouts. When not printing the information, clear the check box.

[RX Timeout]

Set the time period after which the print job automatically ends when print data cannot be received due to a communication error or some other problem.

- 3 Click [OK].

■ Configuring RAW settings

- 1 Click [Edit] in [RAW Settings].



2 Configure the settings as necessary.

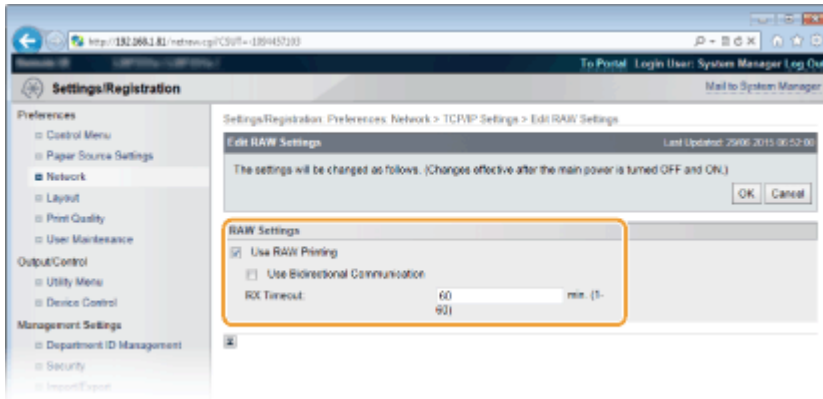

[Use RAW Printing]

When using RAW for printing, select the check box. When not using, clear the check box.

[Use Bidirectional Communication]

When using bidirectional communication to notify the computer of machine status and print completion, select the check box. When not using, clear the check box.

[RX Timeout]

Set the time period after which the print job automatically ends when print data cannot be received due to a communication error or some other problem.

3 Click [OK].

■ Configuring IPP/IPPS settings

1 Click [Edit] in [IPP Print Settings].

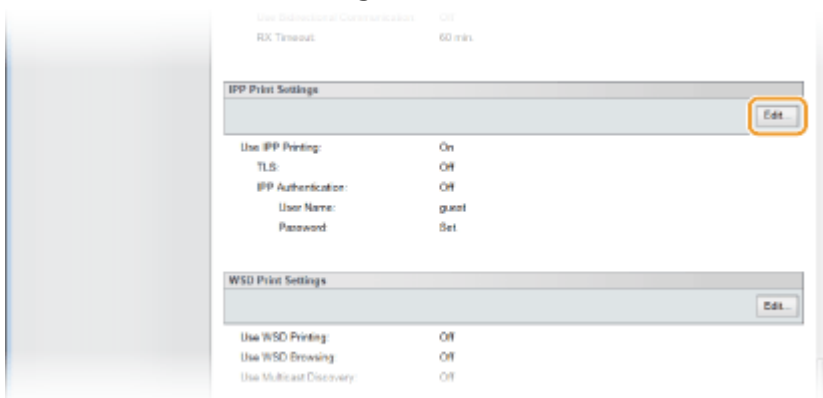

2 Configure the settings as necessary.

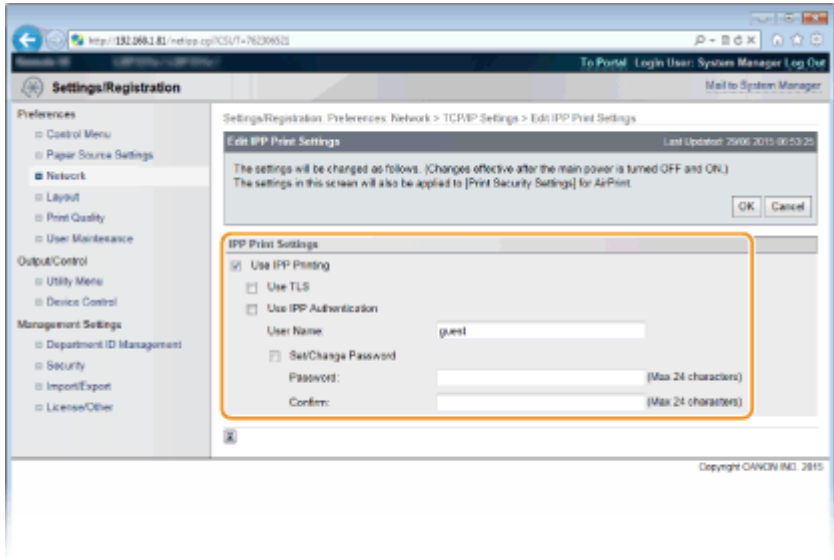

[Use IPP Printing]

When using IPP/IPPS for printing, select the check box. When not using, clear the check box.

[Use TLS]

When using IPPS (IPP Print with TLS encrypted communication), select the check box. When not using, clear the check box.

IMPORTANT:

- When using IPPS, enable the TLS encrypted communication function. **▶ Using TLS for Encrypted Communications(P. 246)**

NOTE:

- If you select [RSA] for [Key Algorithm] when generating the key to use for network communication, set a key length of [1024 bit] or longer. IPPS printing may not be able to be performed correctly if a key length of [512 bit] is set, depending on the operating system you are using.

[Use IPP Authentication]

When using the user authentication function for IPP Print, select the check box and set the user name and password. When not using, clear the check box.

[User Name]

Enter alphanumeric characters for the user name used in IPP authentication.

[Set/Change Password]

To set or change the password, select the check box and enter alphanumeric characters for the password in the [Password] text box. For confirmation, enter the same password in the [Confirm] text box.

3 Click [OK].

■ Configuring WSD settings

1 Click [Edit] in [WSD Print Settings].

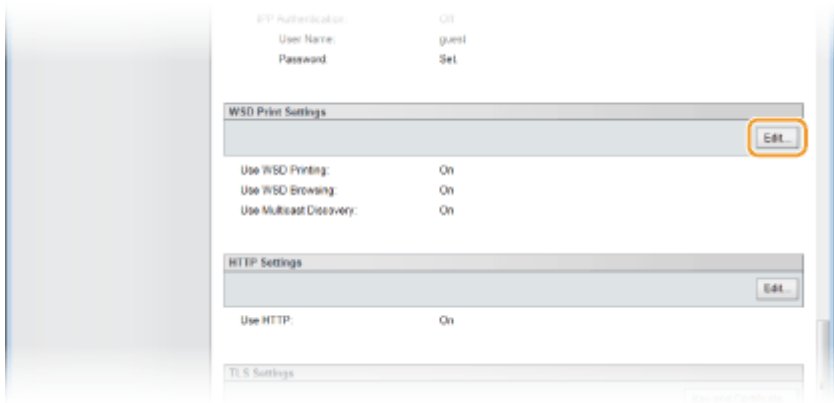

2 Configure the settings as necessary.

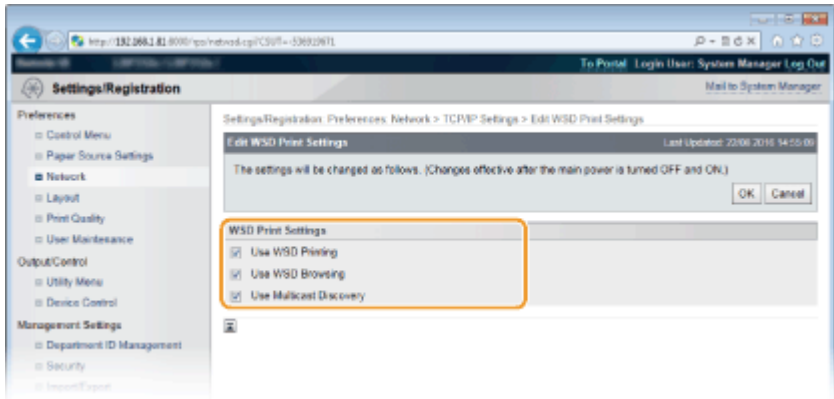

[Use WSD Printing]

When using WSD for printing, select the check box. When not using, clear the check box.

[Use WSD Browsing]

Select the check box to obtain information about the machine from a computer via WSD. This check box is automatically selected when the [Use WSD Printing] check box is selected.

[Use Multicast Discovery]

Select the check box to set the machine to reply to multicast discovery messages. If the check box is cleared, the machine stays in sleep mode even when multicast discovery messages are flowing on the network.

3 Click [OK].

5 Perform a hard reset.

- Click [Device Control], select [Hard Reset], and then click [Execute].

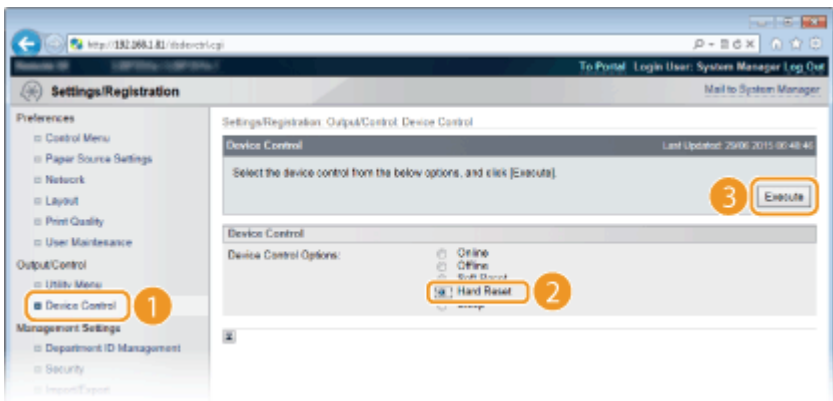

⇒ The settings are enabled after the hard reset is performed.

NOTE

Using the operation panel

- You can also enable or disable LPD print, RAW print, and IPP print from the setting menu of the operation panel.
 - ▶ **LPD Settings(P. 331)**
 - ▶ **RAW Settings(P. 331)**
 - ▶ **IPP Print(P. 332)**
- WSD settings can also be accessed from the setting menu of the operation panel. ▶ **WSD(P. 332)**

Setup procedures on your computer

After the setting in the machine is completed, you may need to configure settings or install applications on your computer as well. Configure settings in your computer as necessary.

- **Configuring printer ports**

Printing errors can occur when the IP address of the machine has been changed, or when a printer has been added via the Windows printer folder. These errors are typically caused by incorrect printer port settings. For example, an incorrect port number or port type may have been specified in the computer. In this case, you need to configure the printer port settings. ▶ **Configuring Printer Ports(P. 161)**
- **Setting up WSD network devices on Windows Vista/7/8/10**

Use the WSD port to install the printer driver. For more information, see the manuals for the relevant drivers on the online manual website.
- **Enabling IPP/IPPS**

Install the printer drivers by specifying the IPP port. ▶ **Enabling IPP/IPPS(P. 155)**

LINKS

- ▶ **Setting Up Print Server(P. 164)**

Enabling IPP/IPPS

51W4-036

To set the printing protocol to IPP or IPPS, install the printer driver by using the procedure shown below that suits the operating system of your computer. The printer driver is included on the User Software CD-ROM/DVD-ROM that comes with the machine. Insert the User Software CD-ROM/DVD-ROM into the drive on the computer before starting the procedure.

IMPORTANT

- To perform the following procedure, log on to your computer with an administrator account.

NOTE

- Configure the IPP print settings by using the Remote UI before starting the procedure.
 - ▶ **Configuring Printing Protocols and WSD Functions(P. 149)**
- Close the setup screen that is displayed when the CD-ROM/DVD-ROM is inserted.

1 Open the Printer Folder. ▶ **Displaying the Printer Folder(P. 522)**

2 Click [Add a printer].

3 If you are using Windows 7/Server 2008, click [Add a network, wireless or Bluetooth printer].

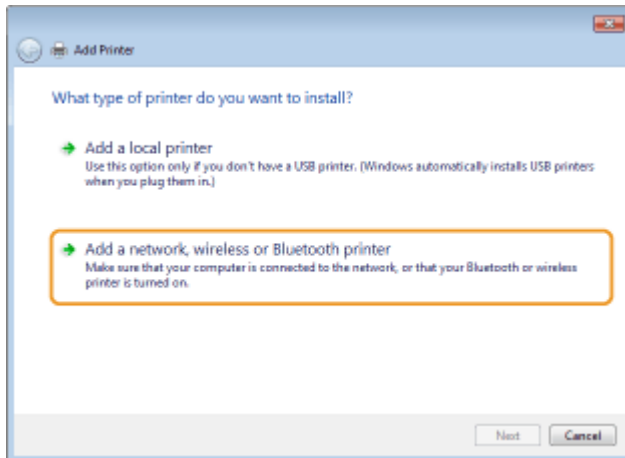

4 Click [The printer that I want isn't listed].

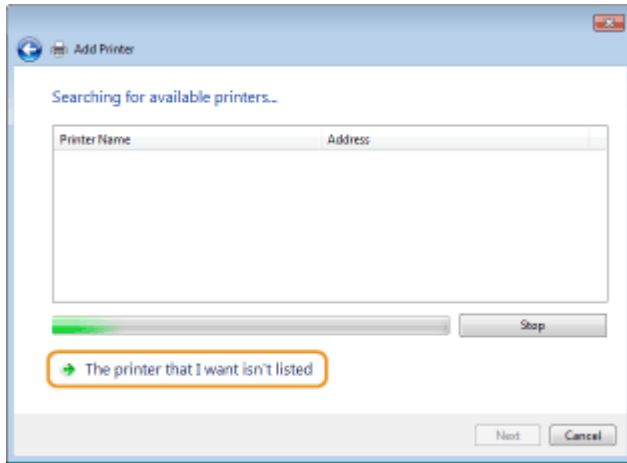

5 Select [Select a shared printer by name], enter a connection destination, and click [Next].

- To use IPP, enter "http://<IP address of the machine>/ipp" for the connection destination.
Example: http://192.168.1.81/ipp
- To use IPPS, enter "https://<IP address of the machine>/ipp" for the connection destination.
Example: https://192.168.1.81/ipp

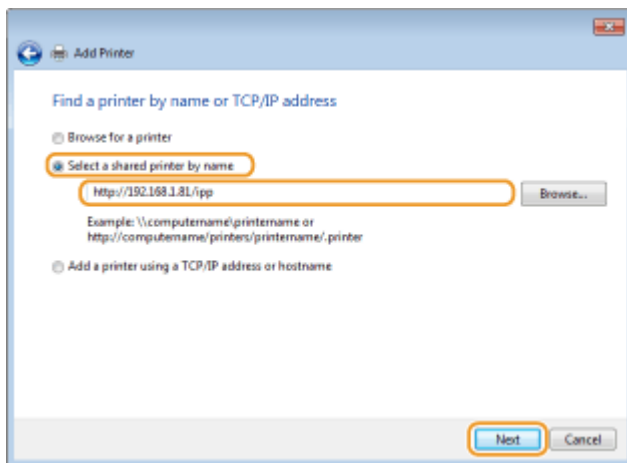

IMPORTANT:

- When you are using a DNS server, enter "<host name of the machine>.<domain name>" instead of "IP address of the machine" (example: https://my_printer.example.com/ipp).

6 Click [Have Disk].

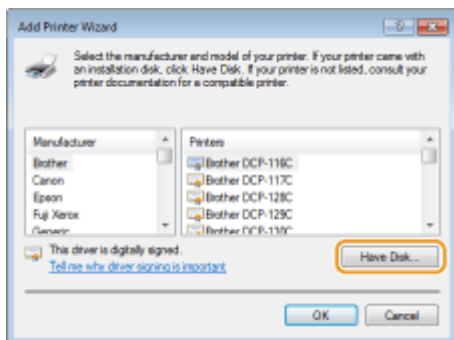

7 Click [Browse].

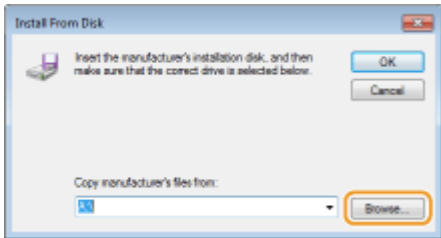

8 Specify the folder where the printer drivers are contained, select the INF file, and then click [Open].

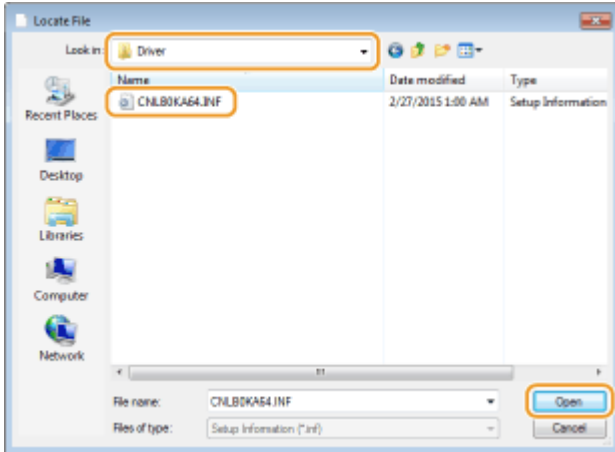

- Specify the folder as shown below according to the operating system of your computer. If you are not sure whether the operating system of your computer is a 32-bit or 64-bit version, see **▶Checking the Bit Architecture(P. 525)** .

32-bit operating systems

Select [UFR II]-your language-[32BIT]-[Driver] folder on the User Software CD-ROM/DVD-ROM.

64-bit operating systems

Select [UFR II]-your language-[x64]-[Driver] folder on the User Software CD-ROM/DVD-ROM.

NOTE:

If using the IPP authentication function

- When you are prompted to enter the password, enter the user name and password, and click [OK]. **▶ Configuring Printing Protocols and WSD Functions(P. 149)**

9 Proceed with the setting procedure by following the on-screen instructions.

⇒ The printer driver is installed. To use IPPS, install public keys of the machine in the computer.

■ Installing Public Keys of the Machine

Using IPPS additionally requires installing the public keys of the machine on the computer.

IMPORTANT

- The [Common Name] of key pairs must be set in advance to be the "IP address" or "<host name>.<domain name>" used when connecting to the machine. **▶Generating Key Pairs(P. 268)**

1 Start the Web browser.

2 Enter "https://<IP address of the machine>/" in the address field, and press the [ENTER] key.

- Example: https://192.168.1.81/

IMPORTANT:

- When you are using a DNS server, enter "<host name of the machine>.<domain name>" instead of "IP address of the machine" (example: https://my_printer.example.com/).

3 Click [Continue to this website (not recommended)].

⇒ Login Page is displayed.

4 Click [Tools] ► [Internet options].

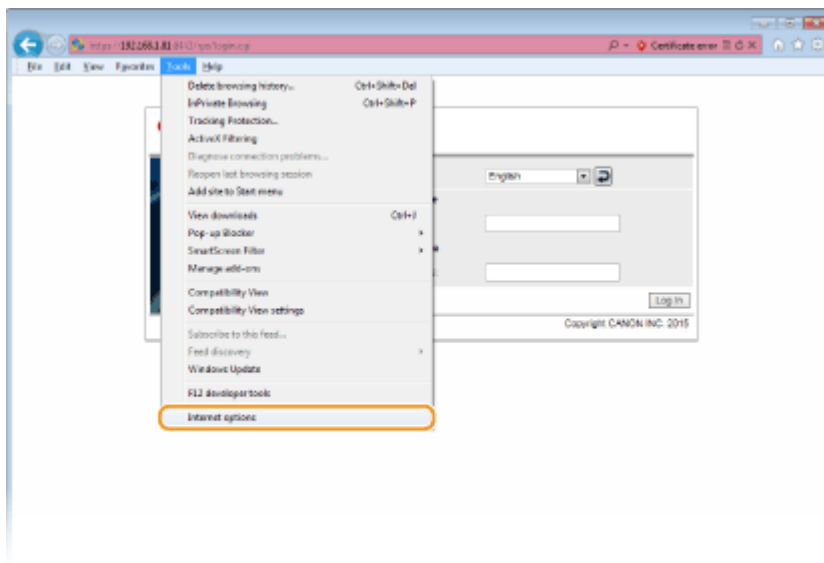

5 Select [Trusted Sites] in the [Security] tab, and click [Sites].

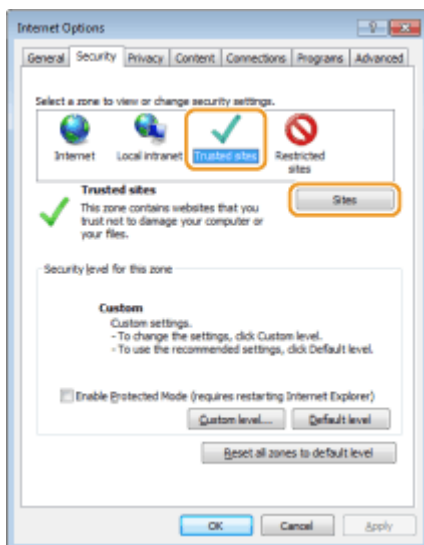

6 Make sure that "https://<IP address of the machine> or <host name of the machine>.<domain name>/" is displayed, and click [Add] ► [Close].

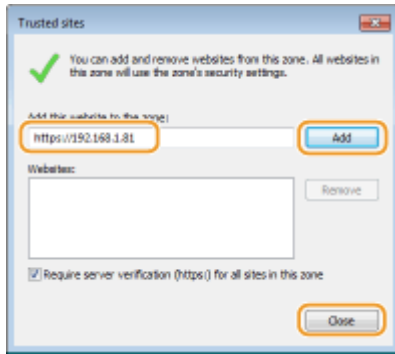

7 Clear the [Enable Protected Mode (requires restarting Internet Explorer)] check box when it is selected.

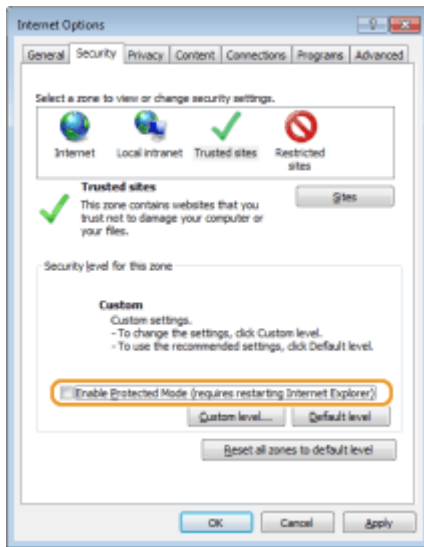

8 Click [OK].

⇒ The screen returns to the Remote UI screen.

9 Exit the Web browser.

10 Repeat steps 1 to 3 to start the Remote UI.

11 Click [Certificate error] ► [View certificates] in the right of the address field.

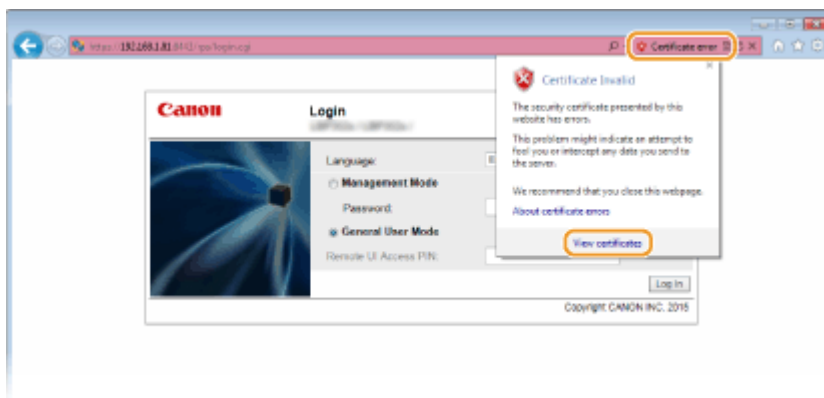

12 Click [Install Certificate].

13 Click [Next].

14 Select [Place all certificates in the following store] and click [Browse].

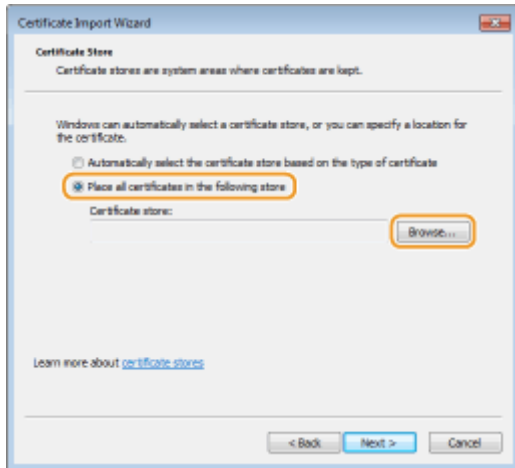

15 Select [Trusted Root Certification Authorities], and follow the on-screen instructions to complete the certificate import wizard.

16 If you have cleared the [Enable Protected Mode (requires restarting Internet Explorer)] check box in step 7, select the check box.

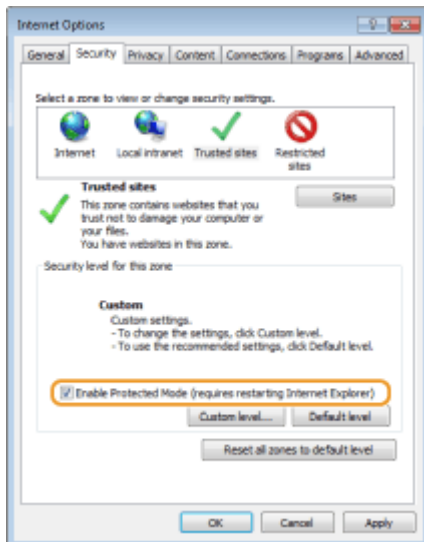

LINKS

🔗 **Setting Up Print Server(P. 164)**

Configuring Printer Ports

51W4-08U

Printing errors can occur when the IP address of the machine has been changed, or when a printer has been added via the Windows printer folder. These errors are typically caused by incorrect printer port settings. For example, an incorrect port type may have been specified. In such situations, your attempt to print fails because the document data cannot reach the machine. To fix this type of problem, configure the printer port settings on the computer.

IMPORTANT

- To perform the following procedure, log in to your computer with an administrator account.

- 1 Open the printer folder. ▶ **Displaying the Printer Folder(P. 522)**
- 2 Right-click the driver icon for this machine, and click [Printer properties] or [Properties].
- 3 Click the [Ports] tab and configure the required settings.

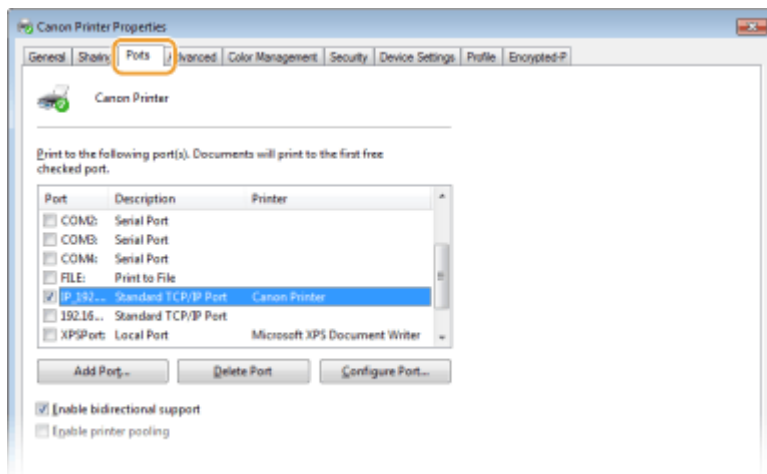

■ Adding a port

If you have changed the IP address of the machine or you have selected an incorrect port while installing drivers, add a new port.

- 1 Click [Add Port].
- 2 Select [Standard TCP/IP Port] in [Available port types] and click [New Port].
- 3 Click [Next].
- 4 Enter the IP address or the DNS name of the machine, and click [Next].
 - The [Port Name] is entered automatically. If necessary, you can change it.

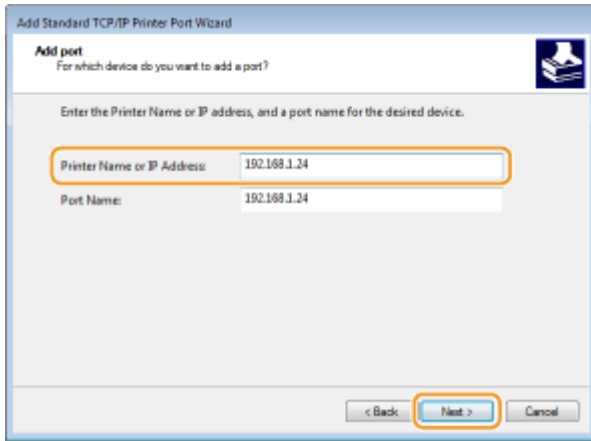

NOTE:

- When the next screen is displayed, follow the instructions on the screen.

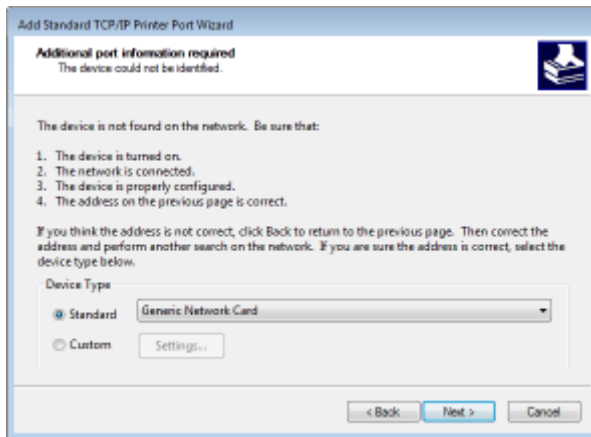

*When you select the [Device Type], select [Canon Network Printing Device with P9100] under [Standard].

- 5 Click [Finish].
- 6 Click [Close].

■ Changing the port type

If the printing protocol (LPD or RAW) has been changed on the machine side or the port number has been changed, the corresponding settings on the computer must also be configured. This operation is not needed for WSD ports.

- 1 Click [Configure Port].
- 2 Under [Protocol], select [Raw] or [LPR].
 - If you selected [Raw], change the [Port Number].
 - If you selected [LPR], enter "lp" in [Queue Name].
- 3 Click [OK].

NOTE:

- To set the printing protocol to IPP or IPPS, you must specify the port for IPP before installing the printer driver. ▶ **Enabling IPP/IPPS(P. 155)**
- Changing the printing protocol settings on the machine. ▶ **Configuring Printing Protocols and WSD Functions(P. 149)**

■ Deleting ports

- 1 Select the port you want to delete, and click [Delete Port].

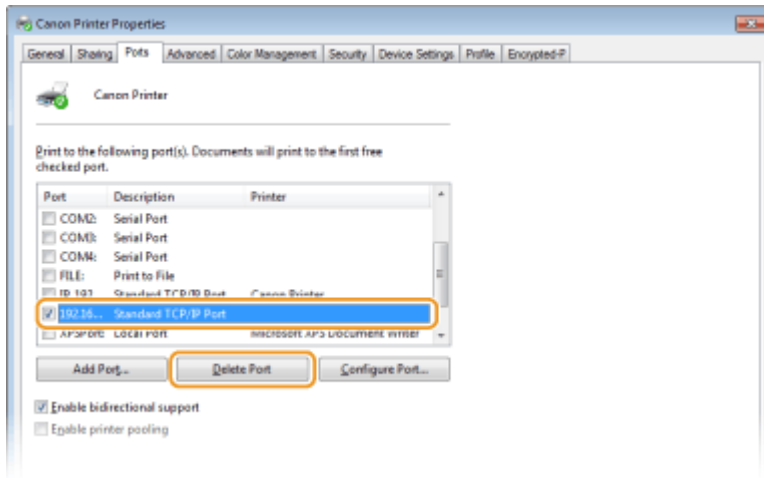

NOTE:

- You cannot delete a port currently configured as the printer port. To delete this port, select a different port and click [Apply] to configure it as the new printer port, and then delete the original port.

- 2 Click [OK].

- 4 Click [Close].

LINKS

- 🔗 [Setting Up Print Server\(P. 164\)](#)

Setting Up Print Server

51W4-037

With a print server, you can reduce the load on the computer that you print from. The print server also enables each computer to install printer drivers over the network, which saves you the trouble of installing printer drivers on each computer by using the CD-ROM/DVD-ROM. To set up a computer on the network as a print server, configure the settings for sharing the printer.

IMPORTANT

- To perform the following procedure, log on to your computer with an administrator account.
- You may be unable to install printer drivers over the network depending on the operating system and the bit architecture (32-bit or 64-bit) of the print server and client computers.
- When implementing a print server in a domain environment, consult your Network Administrator.

NOTE

To carry out Department ID Management when using a print server

- Canon Driver Information Assist Service must be added during the printer driver installation. For more information, see the manuals for the relevant drivers on the online manual website.

1 Open the printer folder. ▶ **Displaying the Printer Folder(P. 522)**

2 Right-click the printer driver icon for this machine and click **[Printer properties]** or **[Properties]**.

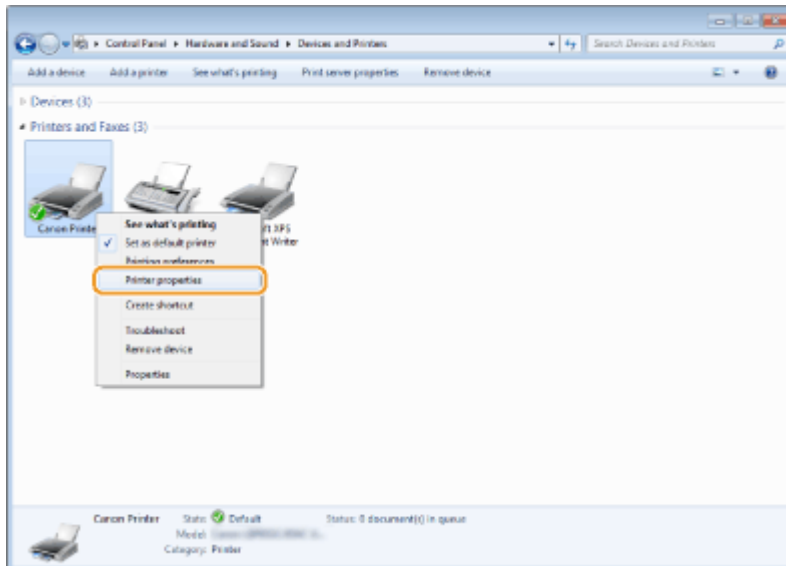

3 Click the **[Sharing]** tab, select **[Share this printer]**, and enter the share name of the machine.

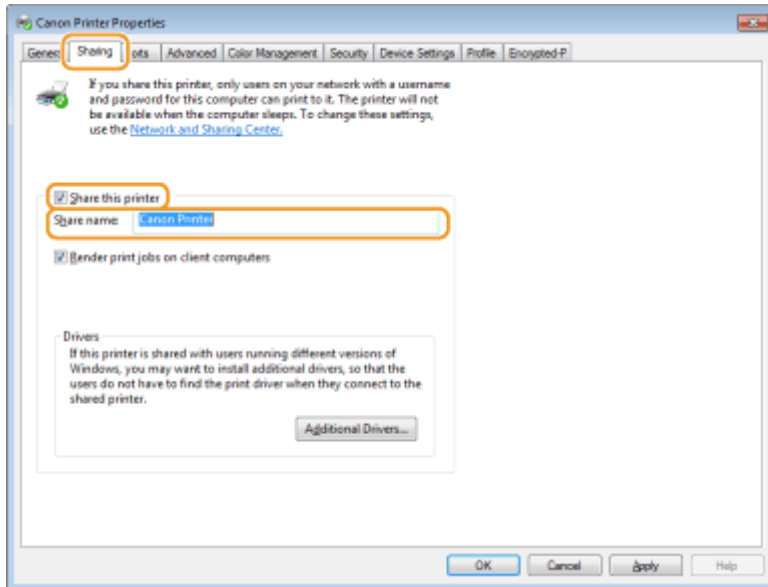
**NOTE:****When [Change Sharing Options] is displayed**

- Click [Change Sharing Options].

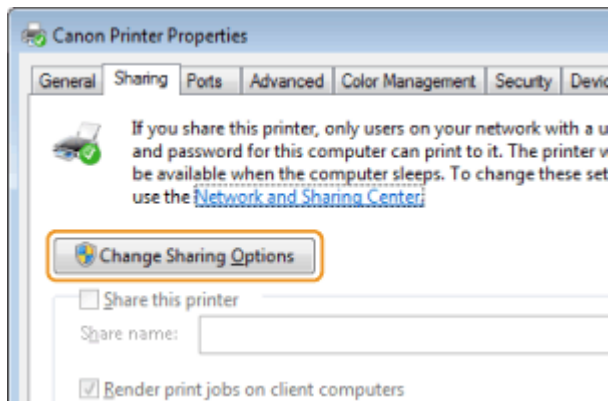
**4 Install additional drivers as necessary.**

- This operation is required if you want to install printer drivers in other computers running a different bit architecture via the print server.

- 1 Click [Additional Drivers].
- 2 Select the check box for the bit architecture that other computers are running, and click [OK].

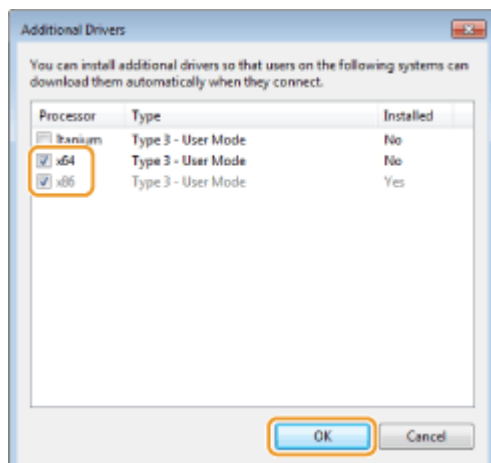

- Select additional drivers from the following, according to the operating system of the print server.

Print server	Select the check box for
32-bit operating systems	[x64]
64-bit operating systems	[x86] under [Processor]

NOTE:

- If you do not know whether your Windows operating system is a 32-bit or 64-bit version, see **Checking the Bit Architecture(P. 525)** .

- 3 Insert the User Software CD-ROM/DVD-ROM into the drive on the computer, and click [Browse].
- 4 Specify the folder that contains additional drivers, select the INF file, and then click [Open].

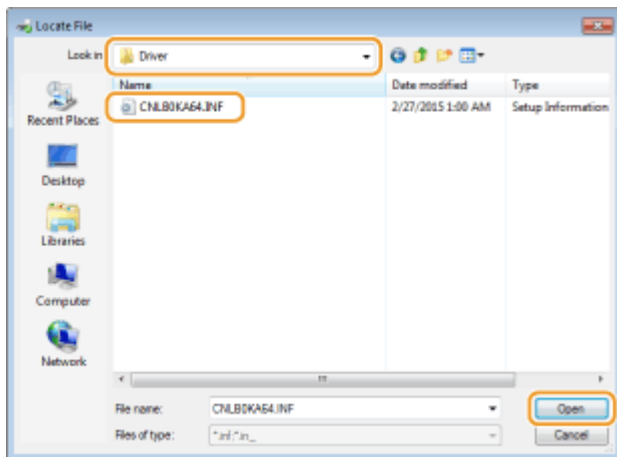

- Select the folder as shown below according to the operating system of the print server.

If the print server runs a 32-bit operating system

Select [UFR II]-your language-[x64]-[Driver] folder on the User Software CD-ROM/DVD-ROM.

If the print server runs a 64-bit operating system

Select [UFR II]-your language-[32BIT]-[Driver] folder on the User Software CD-ROM/DVD-ROM.

- 5 Click [OK].
- Installation of the additional drivers starts. Wait until the [Sharing] tab is displayed back.

NOTE:

When [User Account Control] is displayed

- Click [Yes].

5 Click [OK].

■ Installing Printer Drivers on a Computer via the Print Server

1 Locate the shared printer in the print server. ▶ Displaying Shared Printers in the Print Server(P. 523)

2 Double-click the shared printer.

3 Follow the on-screen instructions to install the printer drivers.

LINKS

▶ **Printing from a Computer(P. 70)**

Configuring the Machine for Your Network Environment

51W4-038

The configuration of a network varies depending on the purpose of the network. The machine has been designed to be compatible with as many network configurations as possible, and it is equipped with a variety of technologies. Consult your Network Administrator and set a configuration to suit your network environment.

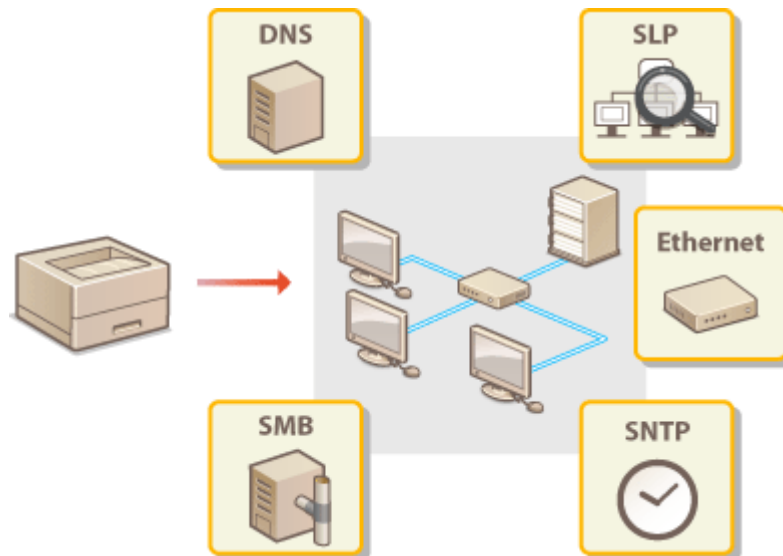

Configuring Ethernet Settings

51W4-039

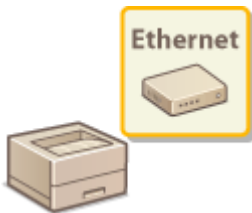

Ethernet is a standard for communicating data in a local area network (LAN). You can set the communication mode and the Ethernet type. In general, the machine can be used without changing the defaults (▶ **Ethernet Driver(P. 342)**), but you can change these settings to suit your network environment.

- 1 Press ▶ (□☑).
- 2 Use ▲ / ▼ to select <Network>, and press **OK**.

- When a message appears, press **OK**.

- 3 Select <Ethernet Driver> ▶ <Auto Detect>.

- 4 Select whether to configure Ethernet settings automatically or manually.

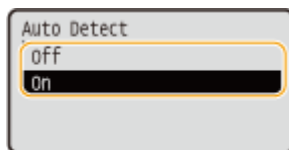

■ Configuring Ethernet settings automatically

Select <On> and press **OK**. The machine detects and automatically sets the communication mode and the Ethernet type that can be used.

■ Configuring Ethernet settings manually

- 1 Select <Off>, and press **OK**.
- 2 Select the communication mode.
 - Select <Communication Mode> ▶ **OK** ▶ Select <Half Duplex> or <Full Duplex> ▶ **OK**



a <Half Duplex>

Alternately sends and receives communication data. Select when the machine is connected to a networking device using half duplex.

b <Full Duplex>

Simultaneously sends and receives communication data. Use this setting for most environments.

3 Select the Ethernet type.

- Select <Ethernet Type> ▶  ▶ Select the Ethernet type ▶ 

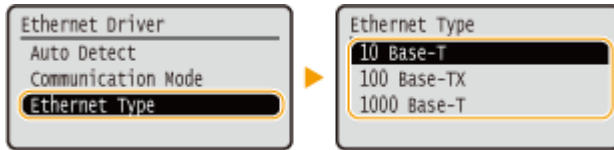
**NOTE:**

- When you select <1000 Base-T>, the setting for <Communication Mode> is changed to <Full Duplex>.

5 Perform a hard reset. ▶ Performing a Hard Reset(P. 408)

⇒ The settings are enabled after the hard reset is performed.

LINKS

▶ **Setting a Wait Time for Connecting to a Network(P. 171)**

Setting a Wait Time for Connecting to a Network

51W4-03A

When a network is designed to enjoy redundant connectivity with multiple switching hubs or bridges, it must have a mechanism to prevent packets from looping. One effective solution is to define the role of each switch port. However, communication may still be disrupted for several tens of seconds immediately after you change the way that network devices are connected, or if you add a new device. If this type of problem occurs, set a wait time for connecting to the network.

- 1 Press **▶** ().
- 2 Use **▲** / **▼** to select **<Network>**, and press **OK**.
 - When a message appears, press **OK**.
- 3 Select **<Wait Time at Startup>**, and press **OK**.
- 4 Enter the wait time in seconds, and press **OK**.

- Use the numeric keys to enter the time.



- 5 Perform a hard reset. [▶Performing a Hard Reset\(P. 408\)](#)

⇒ The settings are enabled after the hard reset is performed.

LINKS

- [▶Configuring Ethernet Settings\(P. 169\)](#)

Configuring DNS

51W4-03C

DNS (Domain Name System) provides a service for name resolution that associates a host (or domain) name with an IP address. Configure the DNS, mDNS or DHCP option settings as necessary. Note that the procedures for configuring DNS are different for IPv4 and IPv6.

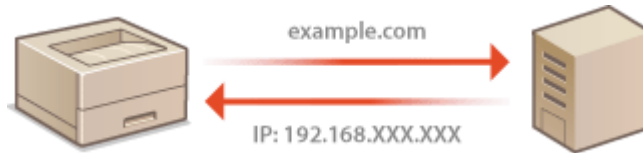

1 Start the Remote UI and log on in Management Mode. ▶ Starting Remote UI(P. 284)

2 Click [Settings/Registration].

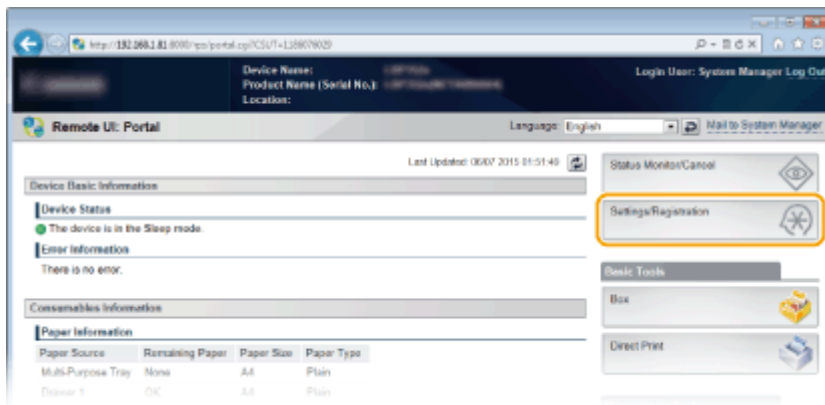

3 Click [Network] ▶ [TCP/IP Settings].

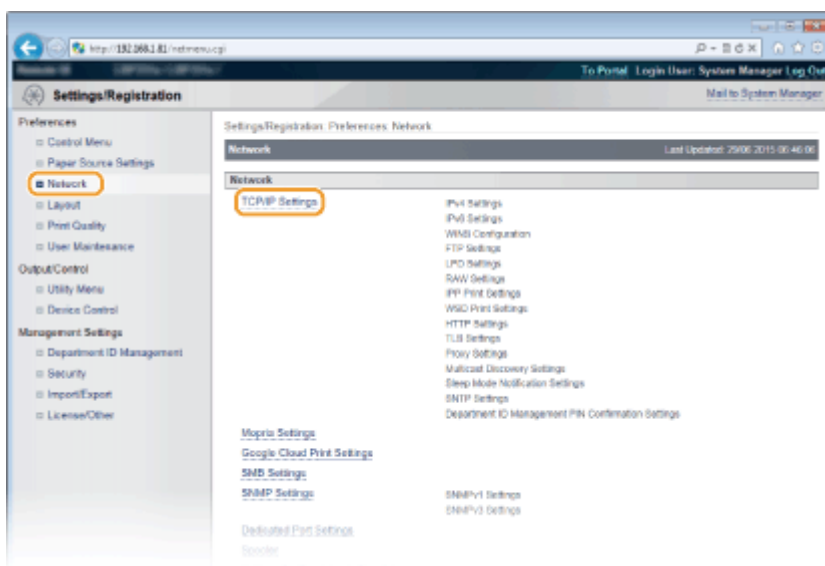

4 Configure DNS settings.

■ Configuring IPv4 DNS

1 Click [Edit] in [IPv4 Settings].



2 Configure IPv4 DNS settings.

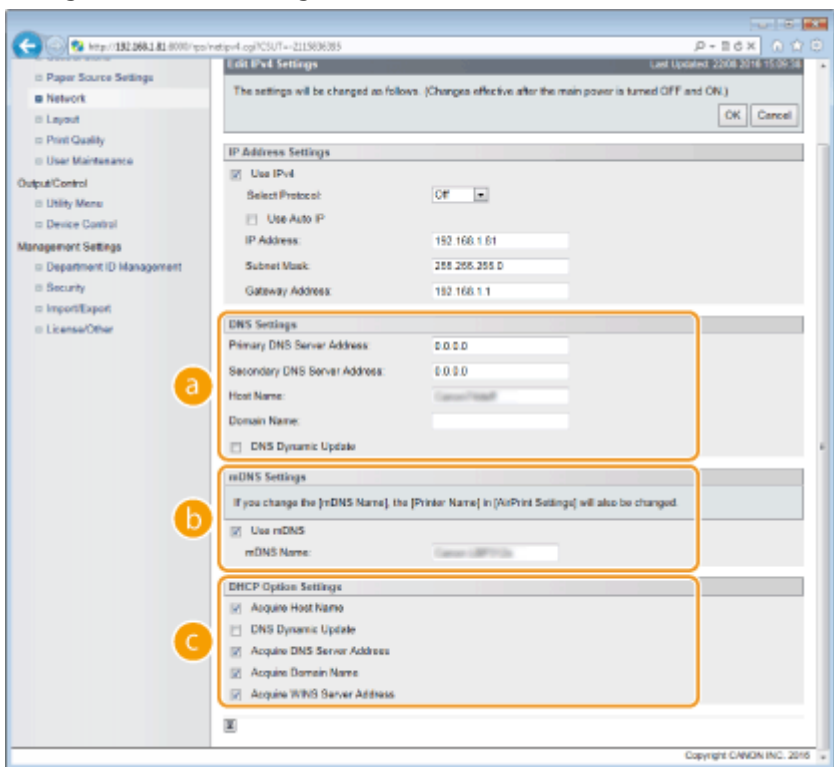

a [DNS Settings]

[Primary DNS Server Address]

Enter the IP address of a DNS server. You can also set the IP address from the operation panel ( **IPv4 Settings(P. 326)**).

[Secondary DNS Server Address]

Enter the IP address of a secondary DNS server, if any. You can also set the IP address from the operation panel ( **IPv4 Settings(P. 326)**).

[Host Name]

Enter alphanumeric characters for the host name of the machine that is to be registered to the DNS server.

[Domain Name]

Enter alphanumeric characters for the name of the domain the machine belongs to, such as "example.com."

[DNS Dynamic Update]

Select the check box to dynamically update the DNS records whenever the machine's IP address is changed.

b [mDNS Settings]

[Use mDNS]

Adopted by Bonjour, mDNS (multicast DNS) is a protocol for associating a host name with an IP address without using DNS. Select the check box to enable mDNS and enter the mDNS name in the [mDNS Name] text box. This check box can only be selected when the [Use IPv4] check box is selected.

c [DHCP Option Settings]

[Acquire Host Name]

Select the check box to enable Option 12 to obtain the host name from the DHCP server. You can also specify whether to obtain a host name from the operation panel (▶ **IPv4 Settings(P. 326)**).

[DNS Dynamic Update]

Select the check box to enable Option 81 to dynamically update the DNS records through the DHCP server. You can also specify whether to perform DNS dynamic update from the operation panel (▶ **IPv4 Settings(P. 326)**).

[Acquire DNS Server Address]

Select the check box to enable Option 6 to obtain a DNS server address from the DHCP server.

[Acquire Domain Name]

Select the check box to enable Option 15 to obtain a domain name from the DHCP server.

[Acquire WINS Server Address]

Select the check box to enable Option 44 to obtain a WINS server address from the DHCP server.

3 Click [OK].

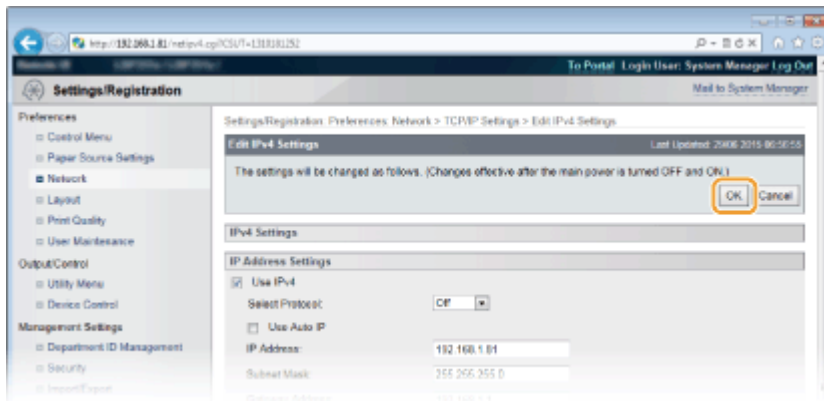

■ Configuring IPv6 DNS

1 Click [Edit] in [IPv6 Settings].

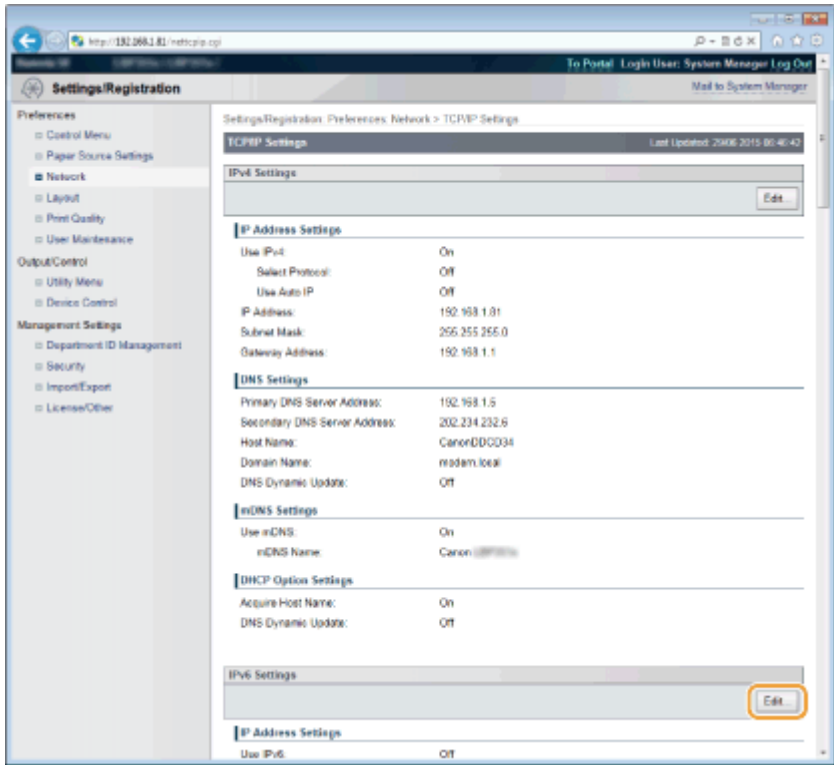

2 Configure IPv6 DNS settings.

- The [Use IPv6] check box must be selected to configure the settings. **▶Setting IPv6 Addresses(P. 144)**

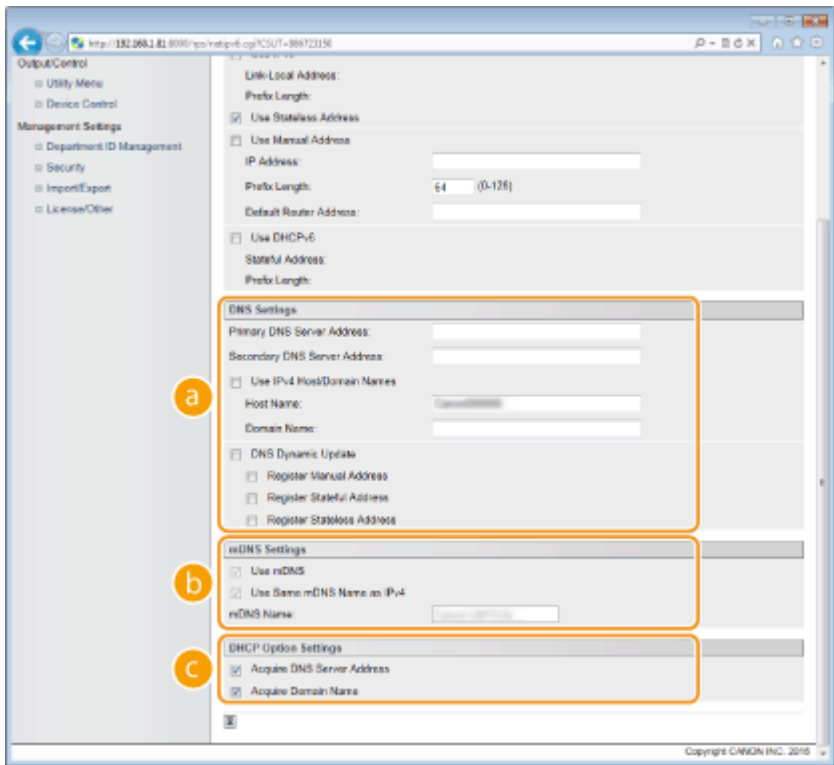

a [DNS Settings]

[Primary DNS Server Address]

Enter the IP address of a DNS server. You cannot enter an address that starts with "ff" (or multicast address), the address of "0000::0000" (all zeros), or an address that starts with "0:0:0:0:ffff" or "0:0:0:0:0".

[Secondary DNS Server Address]

Enter the IP address of a secondary DNS server, if any. You cannot enter an address that starts with "ff" (or multicast address), the address of "0000::0000" (all zeros), or an address that starts with "0:0:0:0:0:ffff" or "0:0:0:0:0:0".

[Use IPv4 Host/Domain Names]

Select the check box to use the same host and domain names as in IPv4.

[Host Name]

Enter alphanumeric characters for the host name of the machine that is to be registered to the DNS server.

[Domain Name]

Enter alphanumeric characters for the name of the domain the machine belongs to, such as "example.com."

[DNS Dynamic Update]

Select the check box to dynamically update the DNS records whenever the machine's IP address is changed. To specify the type(s) of addresses you want to register to the DNS server, select the check box for [Register Manual Address], [Register Stateful Address], or [Register Stateless Address].

b [mDNS Settings]

[Use mDNS]

Adopted by Bonjour, mDNS (multicast DNS) is a protocol for associating a host name with an IP address without using DNS. Select the check box to enable mDNS. This check box can only be selected when the [Use IPv6] check box is selected.

[Use Same mDNS Name as IPv4]

Select the check box to use the same mDNS name as that set in IPv4. To set a different name, clear the check box and enter the mDNS name in the [mDNS Name] text box.

c [DHCP Option Settings]

[Acquire DNS Server Address]

Select the check box to enable Option 23 to obtain a DNS server address from the DHCP server.

[Acquire Domain Name]

Select the check box to enable Option 24 to obtain a domain name from the DHCP server.

3 Click [OK].

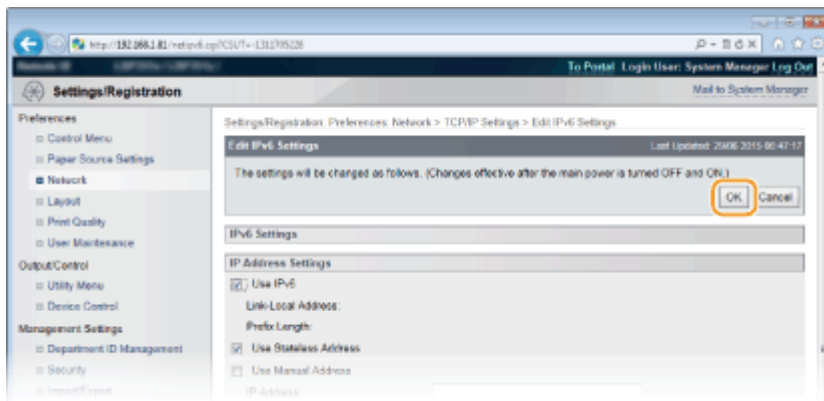

5 Perform a hard reset.

- Click [Device Control], select [Hard Reset], and then click [Execute].

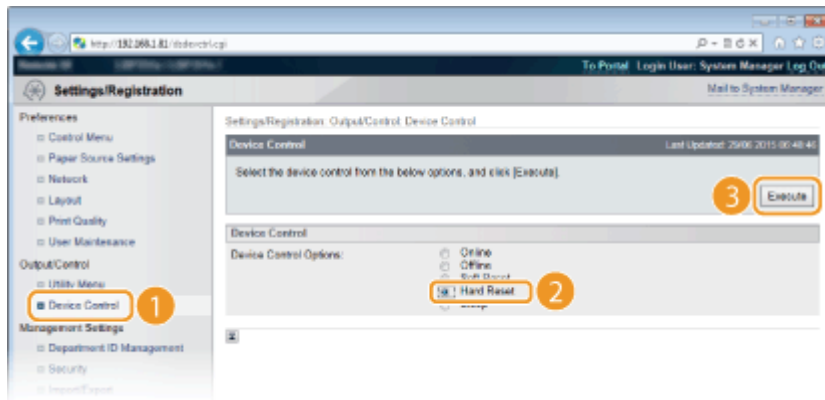

⇒ The settings are enabled after the hard reset is performed.

LINKS

- ▶ [Setting IPv4 Address\(P. 140\)](#)
- ▶ [Setting IPv6 Addresses\(P. 144\)](#)
- ▶ [Network Status Print\(P. 441\)](#)

Configuring WINS

51W4-03E

Windows Internet Name Service (WINS) is a name resolution service that associates a NetBIOS name (a computer or printer name in an SMB network) with an IP address. To enable WINS, the WINS server must be specified.

IMPORTANT

- The function is not available in an IPv6 network.

1 Start the Remote UI and log on in Management Mode. ▶ Starting Remote UI(P. 284)

2 Click [Settings/Registration].

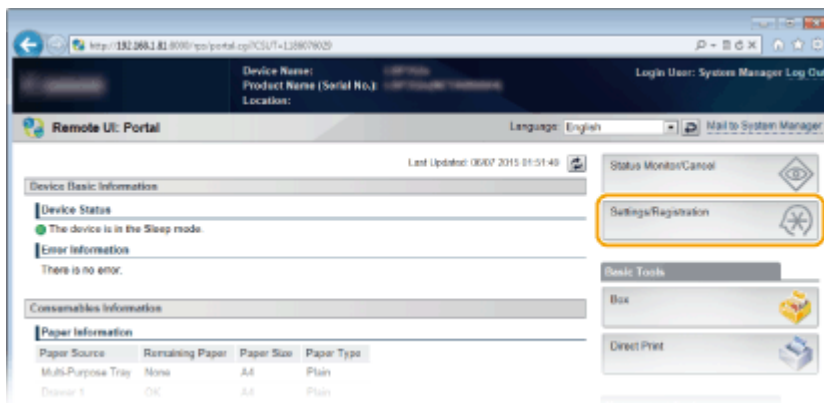

3 Click [Network] ▶ [TCP/IP Settings].

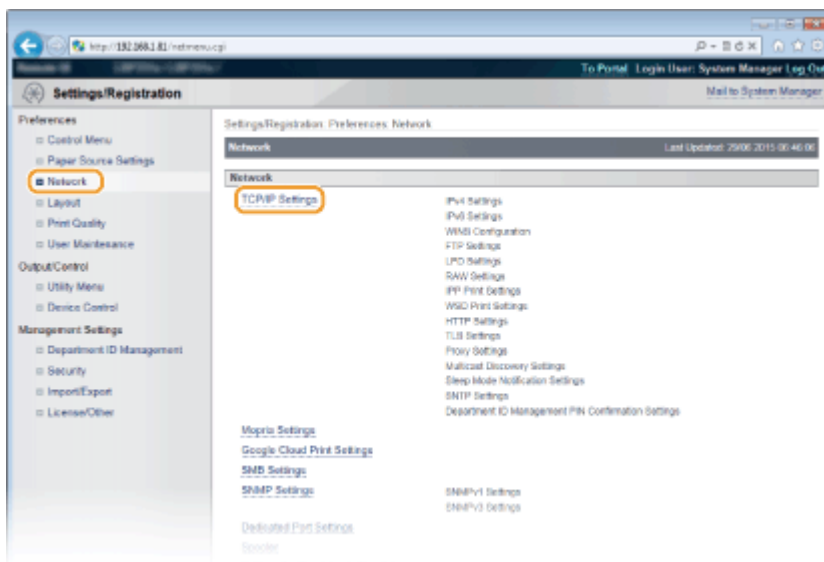

4 Click [Edit] in [WINS Configuration].

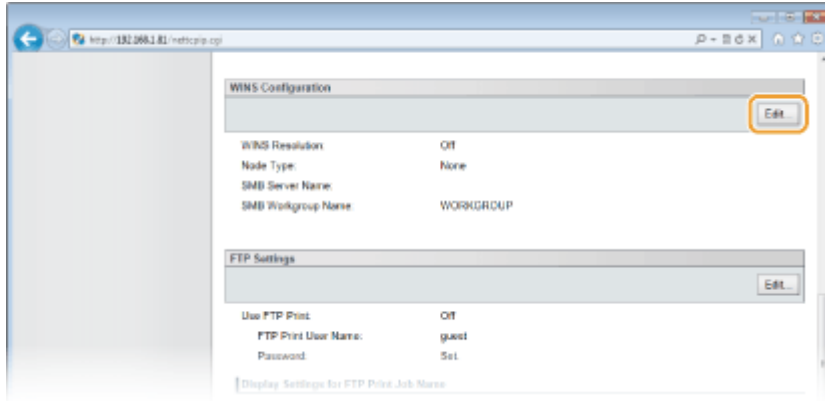

5 Select the [WINS Resolution] check box, specify the required settings, and click [OK].

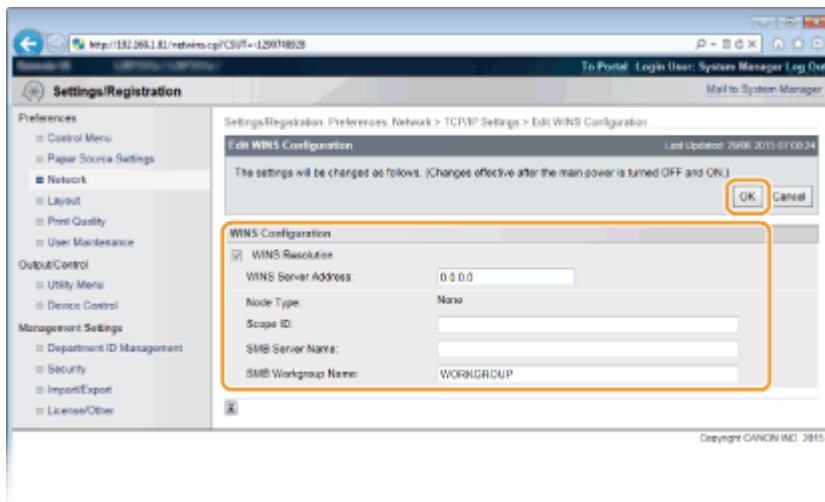

[WINS Resolution]

Select the check box to use WINS for name resolution. When not using WINS, clear the check box.

[WINS Server Address]

Enter the IP address of the WINS server.

IMPORTANT:

- If the IP address of the WINS server is obtained from a DHCP server, the obtained IP address overrides the IP address entered in the [WINS Server Address] text box.

[Scope ID]

When dividing the network into several groups with scope IDs (identifiers for groups of devices in the network), enter the scope ID for your computer. Leave the text box blank if there is no scope ID set for your computer.

[SMB Server Name]

When registering the machine on the WINS server, specify the server name to be used in the SMB network.

NOTE:

- You cannot use spaces.
- A server name set in [Server Name] under [SMB Settings] is automatically used for [SMB Server Name], if any. A change to the server name in [SMB Server Name] is also applied to [Server Name] under [SMB Settings].

[SMB Workgroup Name]

When registering the machine on the WINS server, specify the name of the workgroup to which the machine belongs in the SMB network.

NOTE:

- You cannot use spaces.

- A workgroup name set in [Workgroup Name] under [SMB Settings] is automatically used for [SMB Workgroup Name], if any. A change to the workgroup name in [SMB Workgroup Name] is also applied to [Workgroup Name] under [SMB Settings].

6 Perform a hard reset.

- Click [Device Control], select [Hard Reset], and then click [Execute].

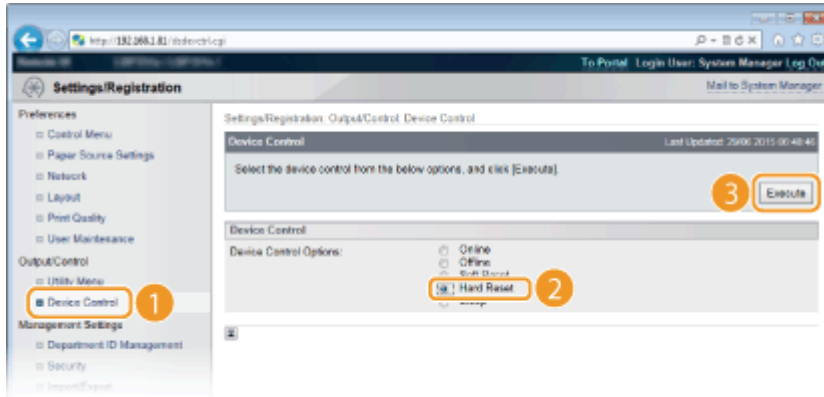

⇒ The settings are enabled after the hard reset is performed.

NOTE

Selecting settings from the operation panel

- You can also enable or disable the WINS settings from the setting menu of the operation panel. **▶WINS Resolution(P. 330)**

LINKS

- ▶Configuring SMB(P. 194)

Configuring SNTP

51W4-03F



Simple Network Time Protocol (SNTP) enables you to adjust the system clock by using the time server on the network. When you use SNTP, the system checks the time server periodically, so that the system clock is always accurate.

NOTE

- The SNTP of the machine supports both NTP (version 3) and SNTP (versions 3 and 4) servers.

1 Start the Remote UI and log on in Management Mode. ▶ Starting Remote UI(P. 284)

2 Click [Settings/Registration].

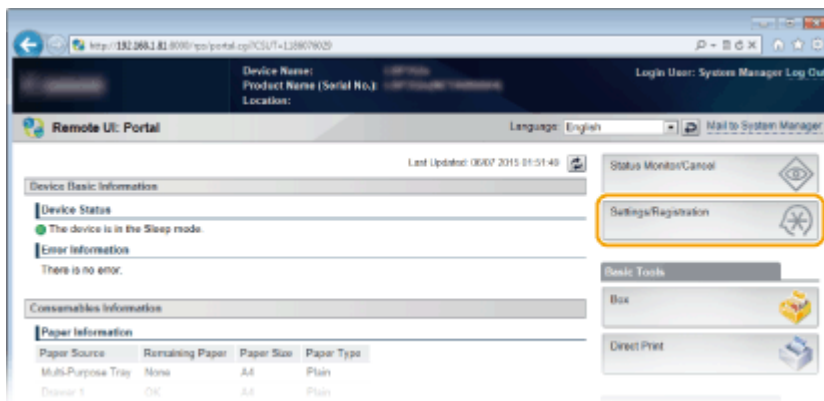

3 Click [Network] ▶ [TCP/IP Settings].

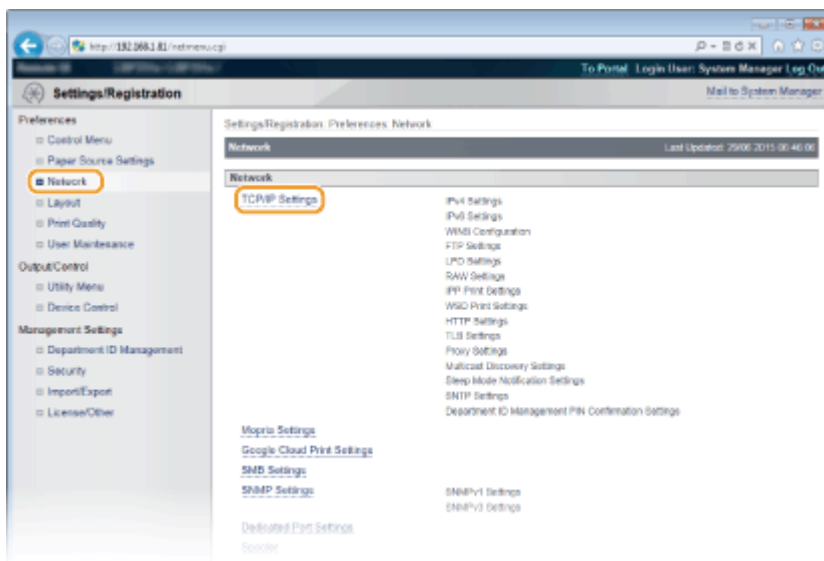

4 Click [Edit] in [SNTP Settings].

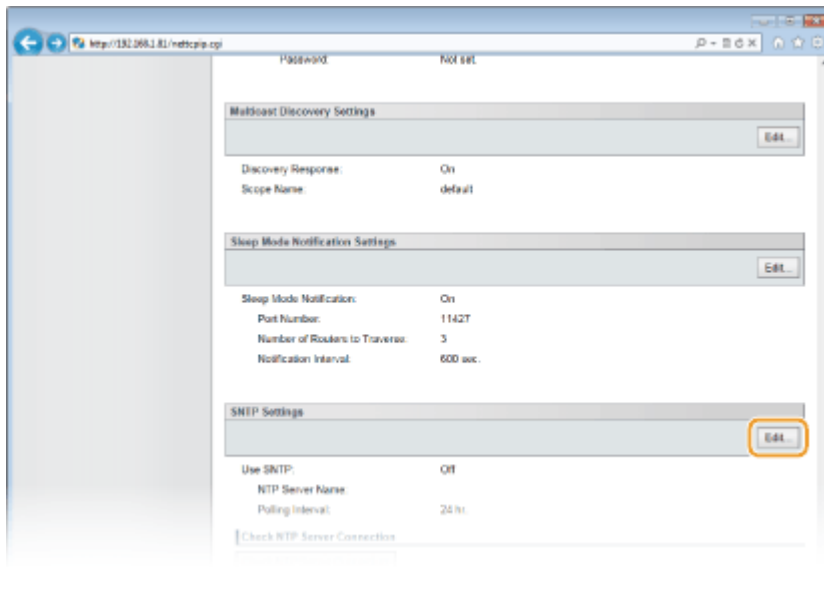

5 Select the [Use SNTP] check box and specify the required settings.

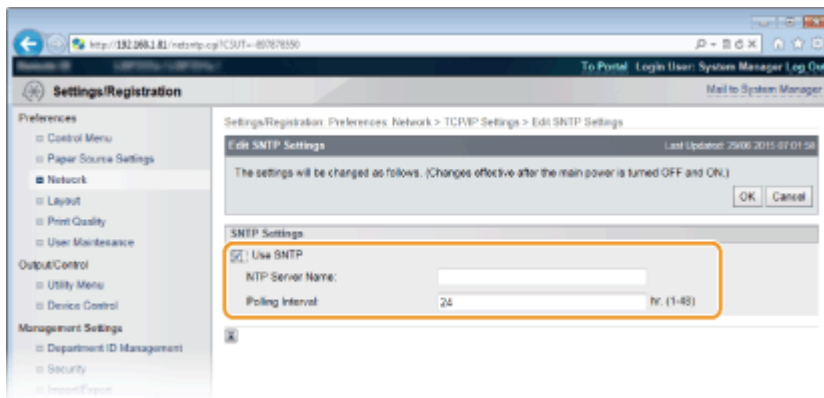

[Use SNTP]

Select the check box to use SNTP for synchronization. If you do not want to use SNTP, clear the check box.

[NTP Server Name]

Enter the IP address of the NTP or the SNTP server. If DNS is available on the network, you can enter "<host name>.<domain name>" (or FQDN) using alphanumeric characters instead (example: ntp.example.com).

[Polling Interval]

Specify the interval between one synchronization and the next.

6 Click [OK].

7 Perform a hard reset.

- Click [Device Control], select [Hard Reset], and then click [Execute].

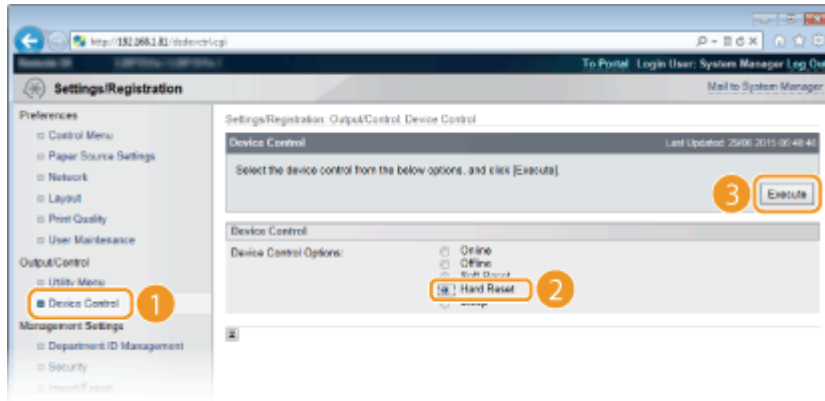

⇒ The settings are enabled after the hard reset is performed.

NOTE

Testing communication with the NTP/SNTP server

- You can view communication status with the registered server by clicking [Settings/Registration] ▶ [Network] ▶ [TCP/IP Settings] and then clicking [Check NTP Server Connection] in [SNTP Settings] that appears. If a proper connection has been established, the result is displayed as shown below. Note that this operation does not adjust the system clock.

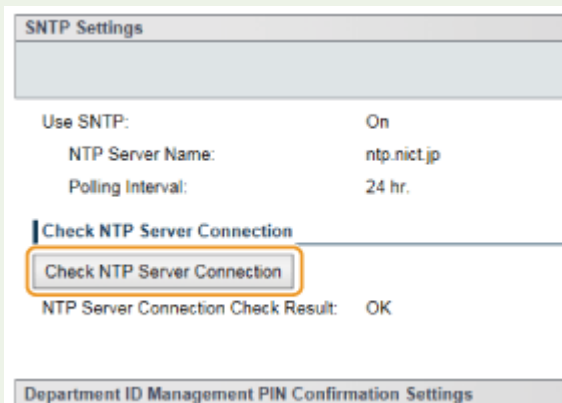

Selecting settings from the operation panel

- You can also enable or disable the SNTP settings from the setting menu of the operation panel. ▶
SNTP(P. 335)

Monitoring and Controlling the Machine with SNMP

51W4-03H

Simple Network Management Protocol (SNMP) is a protocol for monitoring and controlling communication devices in a network by using Management Information Base (MIB). The machine supports SNMPv1 and security-enhanced SNMPv3. You can check the status of the machine from a computer when you print documents or use the Remote UI. You can enable either SNMPv1 or SNMPv3, or both at the same time. Specify the settings for each version to suit your network environment and the purpose of use.

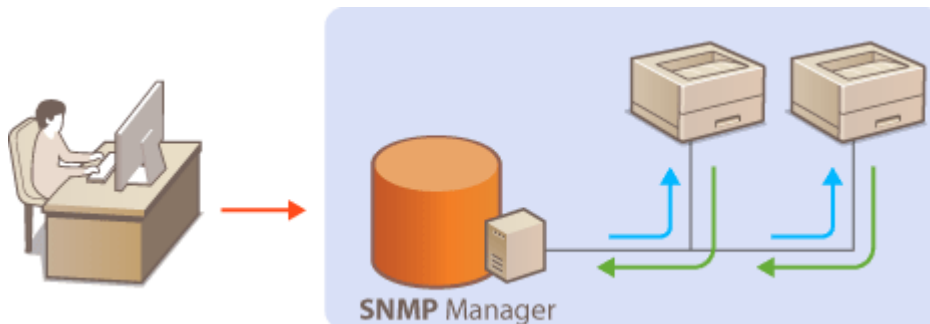

SNMPv1

SNMPv1 uses information called "community" to define the scope of SNMP communication. Because this information is exposed to the network in plain text, your network will be vulnerable to attacks. If you want to ensure network security, disable SNMPv1 and use SNMPv3.

SNMPv3

With SNMPv3, you can implement network device management that is protected by robust security features. Note that TLS must be enabled for the Remote UI before configuring SNMPv3 ([▶Using TLS for Encrypted Communications\(P. 246\)](#)).

NOTE

- The machine does not support the trap notification feature of SNMP.
- SNMP management software, when installed on a computer on the network, enables you to configure, monitor, and control the machine remotely from the computer. For more information, see the instruction manuals for your management software.

1 Start the Remote UI and log on in Management Mode. [▶Starting Remote UI\(P. 284\)](#)

2 Click [Settings/Registration].

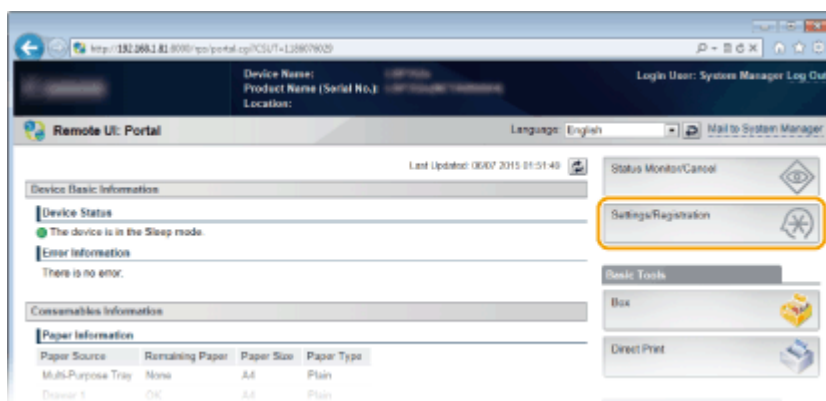

3 Click [Network] ► [SNMP Settings].

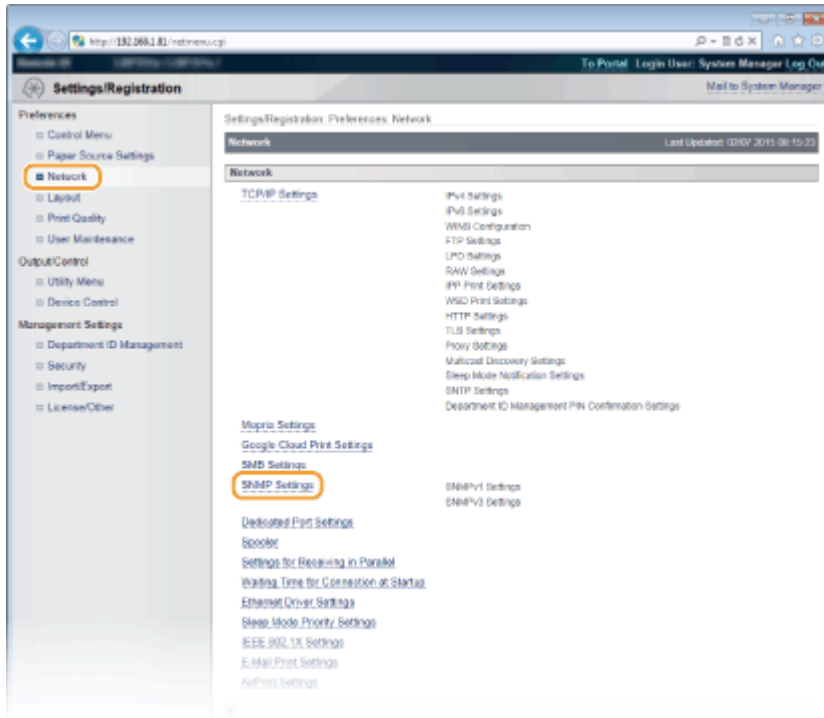

4 Click [Edit].



5 Specify SNMPv1 settings.

- If you do not need to change SNMPv1 settings, proceed to the next step.

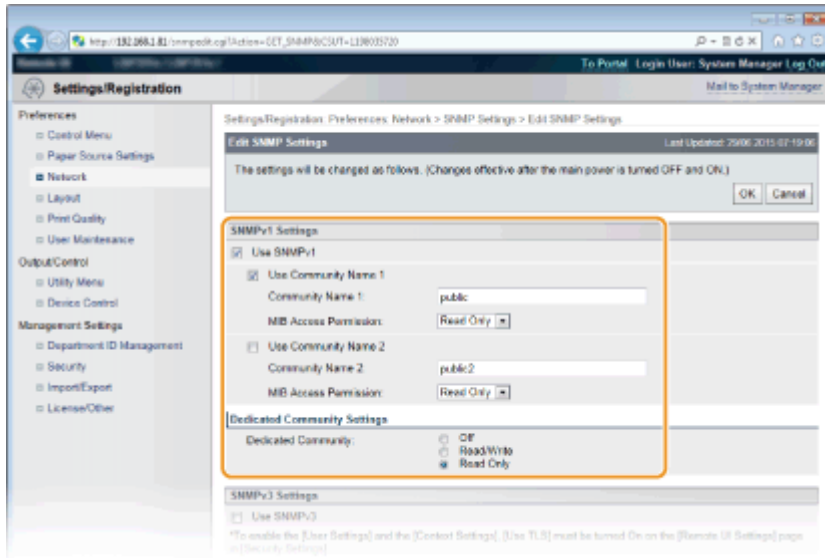

[Use SNMPv1]

Select the check box to enable SNMPv1. You can specify the rest of SNMPv1 settings only when this check box is selected.

[Use Community Name 1]/[Use Community Name 2]

Select the check box to specify a community name. If you do not need to specify a community name, clear the check box.

[Community Name 1]/[Community Name 2]

Enter alphanumeric characters for the name of the community.

[MIB Access Permission]

For each community, select [Read/Write] or [Read Only] for the access privileges to MIB objects.

[Read/Write]	Permits both viewing and changing the values of MIB objects.
[Read Only]	Permits only viewing the values of MIB objects.

[Dedicated Community]

Dedicated Community is a preset community, intended exclusively for administrators using Canon software, such as iW Management Console. Select [Off], [Read/Write], or [Read Only] for the access privileges to MIB objects.

[Off]	Does not use Dedicated Community.
[Read/Write]	Permits both viewing and changing the values of MIB objects by using Dedicated Community.
[Read Only]	Permits only viewing the values of MIB objects by using Dedicated Community.

6 Specify SNMPv3 settings.

- If you do not need to change SNMPv3 settings, proceed to the next step.

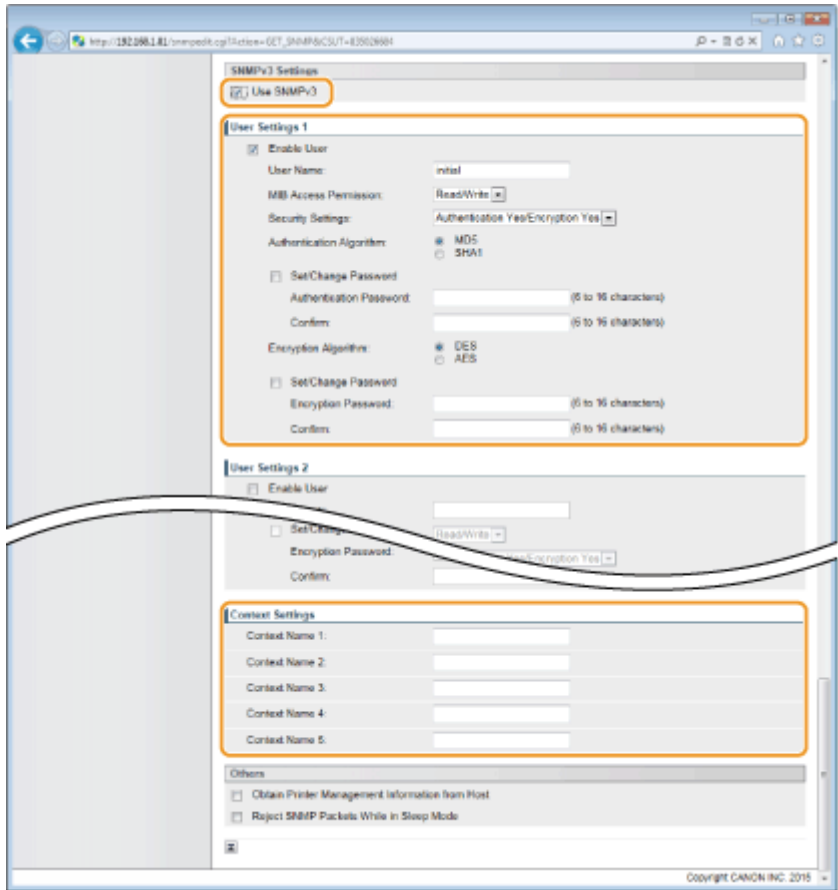

[Use SNMPv3]

Select the check box to enable SNMPv3. You can specify the rest of SNMPv3 settings only when this check box is selected.

[Enable User]

Select the check box to enable [User Settings 1] to [User Settings 5]. To disable user settings, clear the corresponding check box.

[User Name]

Enter alphanumeric characters for the user name.

[MIB Access Permission]

Select [Read/Write] or [Read Only] for the access privileges to MIB objects.

[Read/Write]	Permits both viewing and changing the values of MIB objects.
[Read Only]	Permits only viewing the values of MIB objects.

[Security Settings]

Select [Authentication Yes/Encryption Yes], [Authentication Yes/Encryption No], or [Authentication No/Encryption No] for the desired combination of authentication and encryption settings.

[Authentication Algorithm]

Click the [Authentication Yes/Encryption Yes] or [Authentication Yes/Encryption No] for [Security Settings] for the algorithm that corresponds to your environment.

[Encryption Algorithm]

Click the [Authentication Yes/Encryption Yes] for [Security Settings] for the algorithm that corresponds to your environment.

[Set/Change Password]

To set or change the password, select the check box and enter alphanumeric characters for the password in the [Authentication Password] or [Encryption Password] text box. For confirmation, enter the same password in the [Confirm] text box. Passwords can be set independently for authentication and encryption algorithms.

[Context Name 1] to [Context Name 5]

Enter alphanumeric characters for the context name.

7 Specify Printer Management Information Acquisition Settings.

- With SNMP, the printer management information, such as printing protocols and printer ports, can be monitored and obtained regularly from a computer on the network.

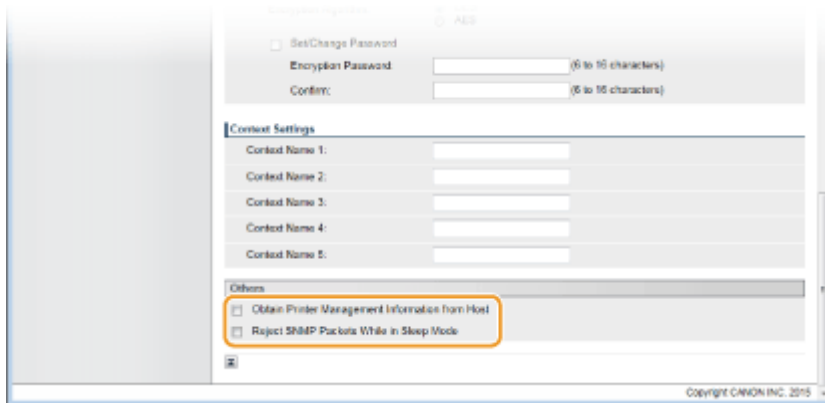

[Obtain Printer Management Information from Host]

Select the check box to enable monitoring of the printer management information of the machine via SNMP. To disable monitoring of the printer management information, clear the check box.

[Reject SNMP Packets While in Sleep Mode]

Select the check box to discard SNMP packets received during sleep mode. If you do not want to discard the packets, clear the check box.

NOTE:

- If you select the check box, applications that use the SNMP protocol, such as Canon software imageWARE Series, may be disabled to access the machine.

8 Click [OK].

9 Perform a hard reset.

- Click [Device Control], select [Hard Reset], and then click [Execute].

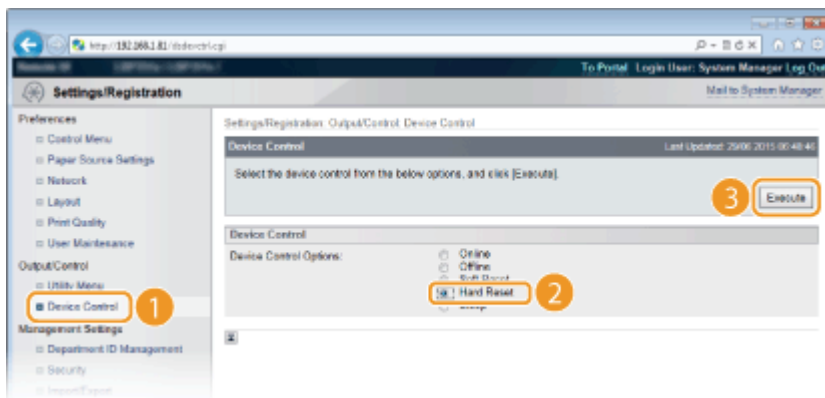

⇒ The settings are enabled after the hard reset is performed.

NOTE

Disabling SNMPv1

- If SNMPv1 is disabled, some of the functions of the machine become unavailable, such as obtaining machine information via the printer driver.

Using the operation panel

- SNMP settings can also be accessed from the setting menu of the operation panel. [▶SNMP Settings\(P. 339\)](#)

Enabling Both SNMPv1 and SNMPv3

- If both versions of SNMP are enabled, it is recommended that MIB access permission in SNMPv1 be set to [Read Only]. MIB access permission can be set independently in SNMPv1 and SNMPv3 (and for each user in SNMPv3). Selecting [Read/Write] (full access permission) in SNMPv1 negates the robust security features that characterize SNMPv3 because most of the machine settings can then be controlled with SNMPv1.

LINKS

- [▶Using TLS for Encrypted Communications\(P. 246\)](#)

Configuring Settings for Device Management Software

51W4-03J

You can facilitate the collection and management of various information about networked devices by implementing device management software, such as iW Management Console, into the network. Information such as device settings and error logs is retrieved and distributed via the server computer. If the machine is connected to such a network, iW Management Console searches the network for the machine by using protocols such as Service Location Protocol (SLP) to gather information from the machine, including the power status. SLP settings can be specified via the Remote UI.

1 Start the Remote UI and log on in Management Mode. ▶Starting Remote UI(P. 284)

2 Click [Settings/Registration].

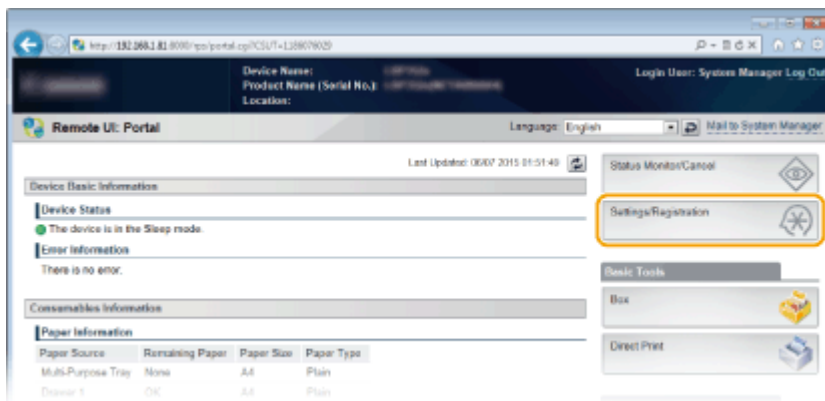

3 Click [Network] ▶ [TCP/IP Settings].

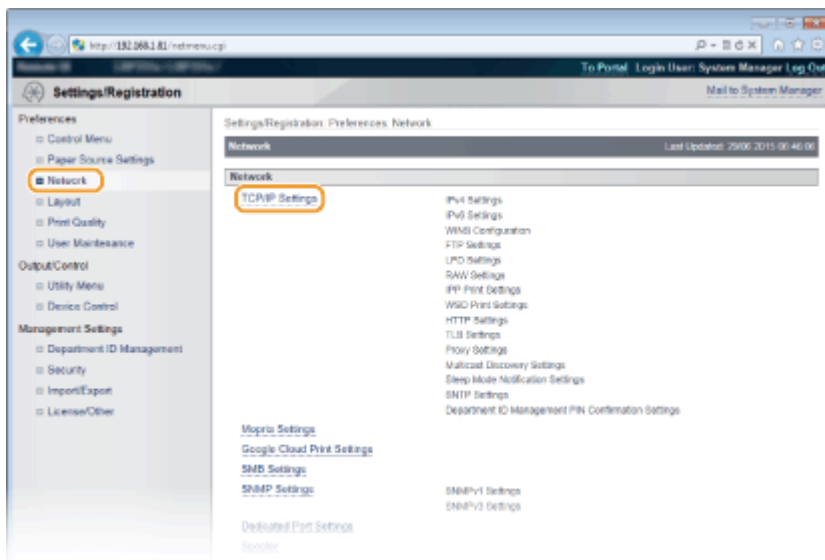

4 Specify SLP settings.

■Specifying multicast device discovery

1 Click [Edit] in [Multicast Discovery Settings].

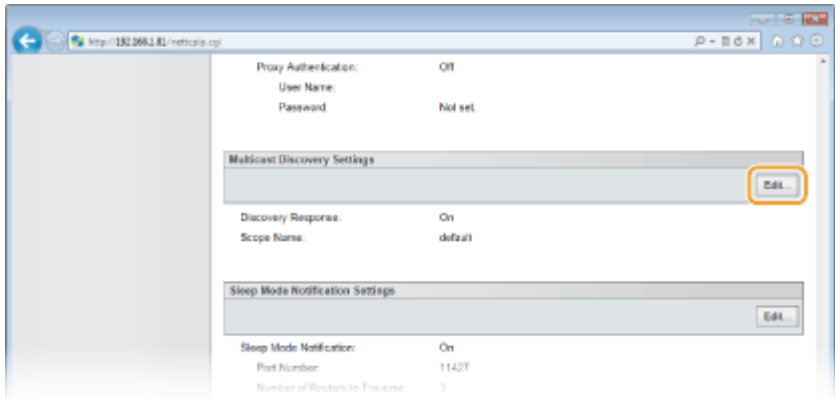

2 Select the [Respond to Discovery] check box and specify the required settings.

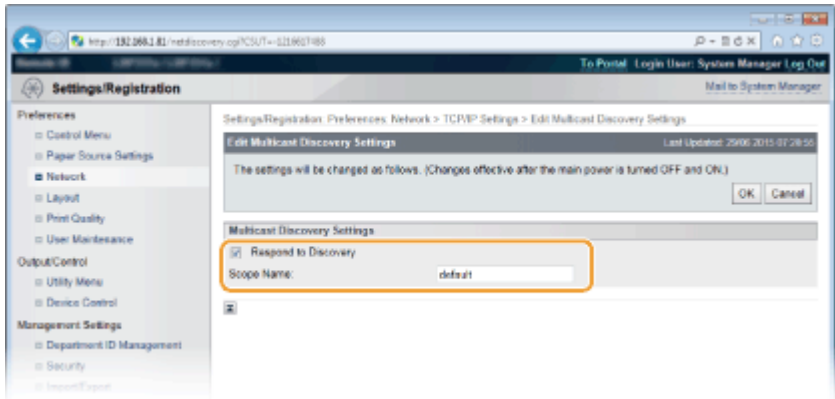

[Respond to Discovery]

Select the check box to set the machine to respond to device management software multicast discovery packets and enable monitoring by device management software. If you do not want to set the machine to respond, clear the check box.

[Scope Name]

To include the machine into a specific scope, enter characters for the scope name.

3 Click [OK].

■ Notifying a device management software of the power status of the machine

1 Click [Edit] in [Sleep Mode Notification Settings].

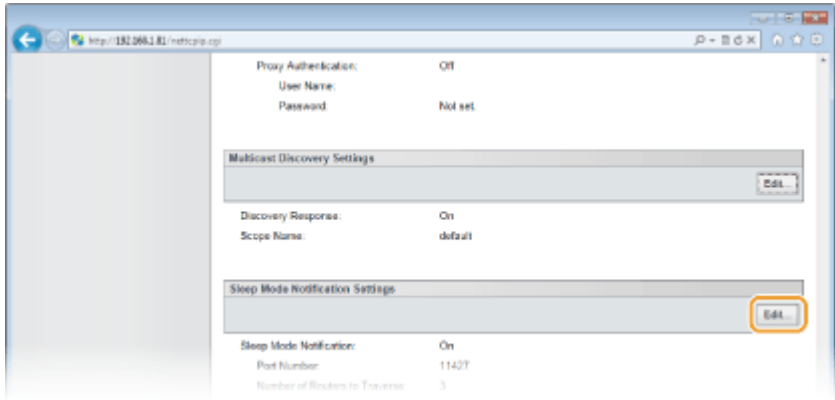

2 Select the [Notify] check box and specify the required settings.

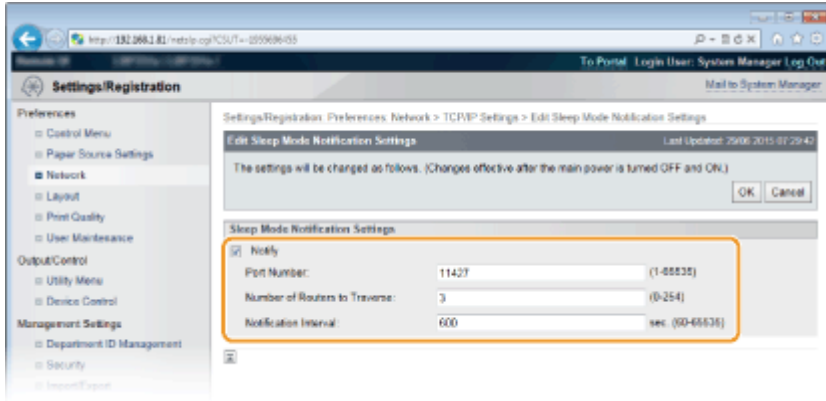

[Notify]

Select the check box to notify a device management software of the power status of the machine. When [Notify] is selected, you can expect the machine to avoid unnecessary communication during sleep mode and reduce the total power consumption.

[Port Number]

Change the port number for this function according to the network environment.

[Number of Routers to Traverse]

Specify how many routers the notification packets can pass.

[Notification Interval]

Specify how often the machine notifies a device management software of its power status.

3 Click [OK].

5 Perform a hard reset.

- Click [Device Control], select [Hard Reset], and then click [Execute].

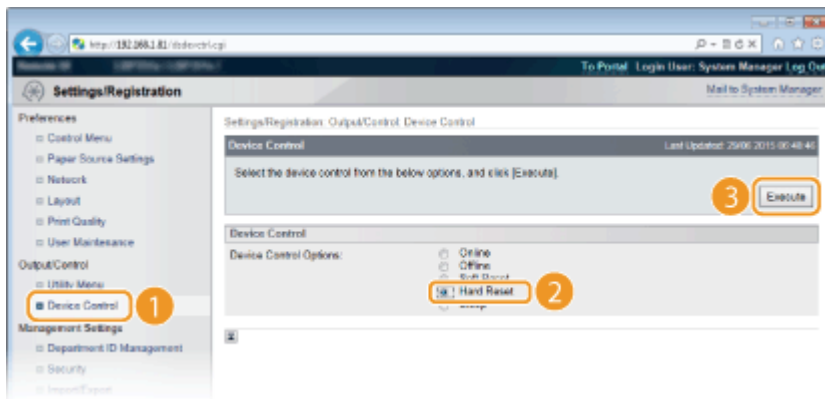

⇒ The settings are enabled after the hard reset is performed.

NOTE

Using the operation panel

- You can also enable or disable discovery response from the setting menu of the operation panel. ▶ **Discovery Response(P. 336)**
- Power status notification settings can also be accessed from the setting menu of the operation panel. ▶ **Sleep Notif. Set.(P. 336)**

LINKS

▶ **Entering Sleep Mode(P. 63)**

Configuring SMB

51W4-03K

Server Message Block (SMB) is a protocol for sharing resources, such as files and printers, with more than one device in a network and used to register the machine as a shared printer on the SMB network.

NOTE

- SMB supports only NetBIOS over TCP/IP and does not support NetBEUI. Configure the IP address before configuring the SMB settings. ▶ **Setting IP Addresses(P. 139)**
- SMB is enabled only when the optional SD card is installed in the machine.

1 Start the Remote UI and log on in Management Mode. ▶ Starting Remote UI(P. 284)

2 Click [Settings/Registration].

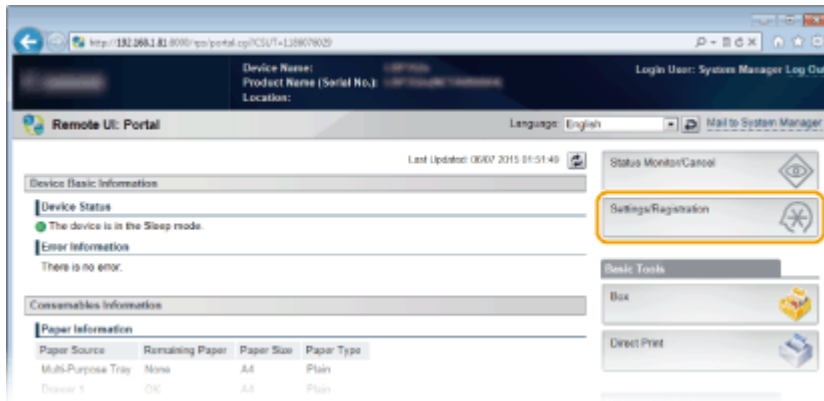

3 Click [Network] ▶ [SMB Settings].

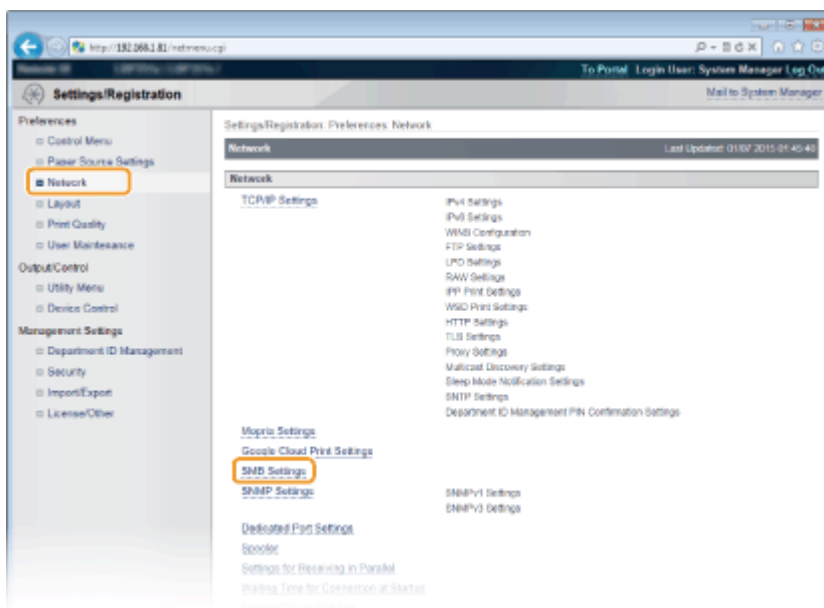

4 Click [Edit].

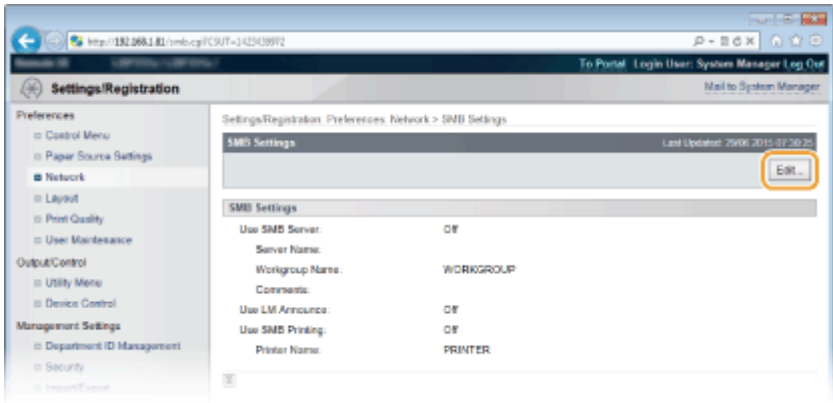

5 Select the [Use SMB Server] check box and specify the required settings.

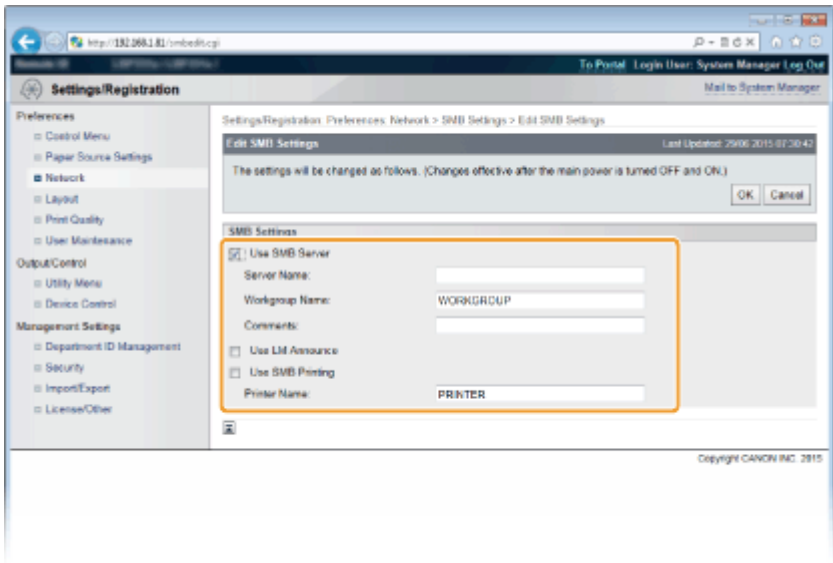

[Use SMB Server]

If you select the check box, the computer is indicated as an SMB server on the SMB network.

[Server Name]

Specify the server name that is to be displayed on the SMB network. The name must be different from the names of any other computers and printers on the network.

NOTE:

- You cannot use spaces.
- A server name set in [SMB Server Name] under [WINS Configuration] is automatically used for [Server Name], if any. A change to the server name in [Server Name] is also applied to [SMB Server Name] under [WINS Configuration].

[Workgroup Name]

Enter the name of the workgroup to which the machine belongs. If there is no workgroup in your network environment, create a workgroup on Windows and enter the name of the workgroup.

NOTE:

- You cannot use spaces.
- A workgroup name set in [SMB Workgroup Name] under [WINS Configuration] is automatically used for [Workgroup Name], if any. A change to the server name in [Workgroup Name] is also applied to [SMB Workgroup Name] under [WINS Configuration].

[Comments]

Enter comments on the machine as necessary.

[Use LM Announce]

Select the check box to notify the LAN Manager of existence of the machine. If you do not need to notify, clear the check box, reducing a network load.

[Use SMB Printing]

When using SMB printing with the machine, select the check box.

[Printer Name]

Specify the name of the machine.

NOTE:

- You cannot use spaces.

6 Click [OK].**7 Perform a hard reset.**

- Click [Device Control], select [Hard Reset], and then click [Execute].

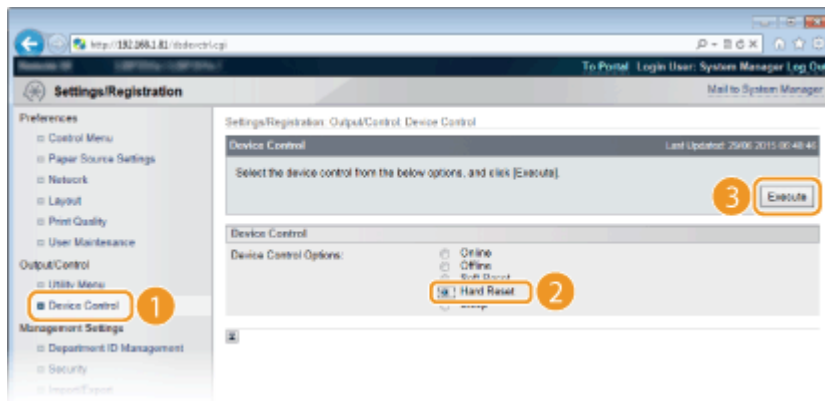

⇒ The settings are enabled after the hard reset is performed.

» Continue to [▶ Configuring Settings on the Computer for Printing\(P. 197\)](#) .

NOTE**Using the operation panel**

- You can also enable or disable the SMB server from the setting menu of the operation panel. [▶SMB\(P. 338\)](#)
- You can also enable or disable SMB print from the setting menu of the operation panel. [▶SMB\(P. 338\)](#)

LINKS

[▶Configuring WINS\(P. 178\)](#)

Configuring Settings on the Computer for Printing

51W4-03L

Configure the connection settings and install the printer driver on the computer so that printing can be performed with the machine from the computer via SMB network.

- ▶ Connecting to the SMB Network(P. 197)
- ▶ Installing the Printer Driver(P. 198)

Connecting to the SMB Network

- 1 Display [Local Area Connection Properties].
- 2 Select the [Client for Microsoft Networks] check box.

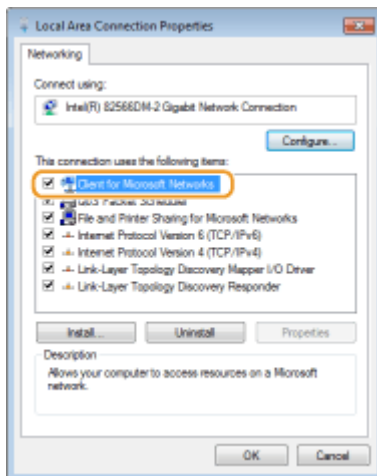

- 3 Select the [Internet Protocol Version 4 (TCP/IPv4)] or [Internet Protocol] check box and click [Properties].

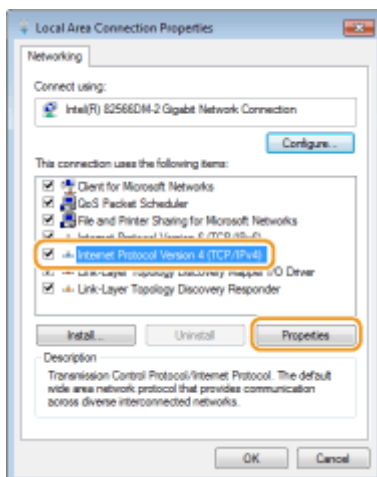

- 4 Click the [General] tab ▶ [Advanced].

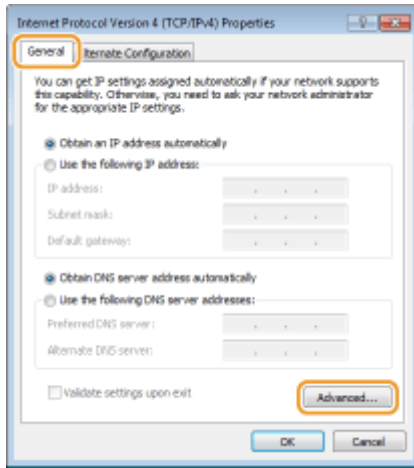

5 Click the [WINS] tab, select [Enable NetBIOS over TCP/IP], and then click [OK].

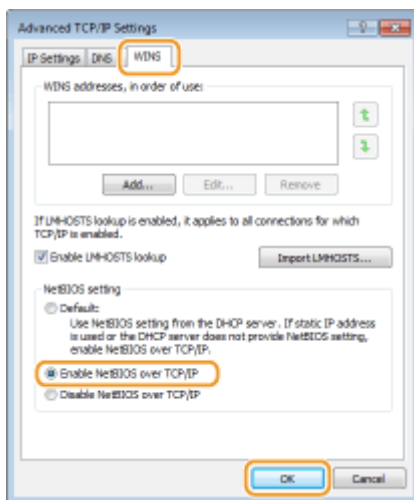

6 Click [OK] until all dialog boxes are closed.

NOTE:

- Restart the computer if you are prompted to do so.

Installing the Printer Driver

For more information about the installation procedure, see the manuals for the relevant drivers on the online manual website.

NOTE

When a port selection screen appears during installation

- Follow the procedure below.

- 1** Click [Add Port].
- 2** Select [Network] and click [OK].
- 3** From the list, select "Workgroup Name," "Server Name," and "Printer Name" that were specified in the SMB protocol settings in this order. ➤ **Configuring SMB(P. 194)**

Security

Security	200
Protecting the Machine from Unauthorized Access	201
Preventing Unauthorized Access	202
Setting Access Privileges	204
Setting the System Manager Password	205
Setting the Department ID Management	208
Setting a Remote UI PIN	215
Restricting Communication by Using Firewalls	216
Specifying IP Addresses for Firewall Rules	217
Specifying MAC Addresses for Firewall Rules	223
Setting a Proxy	226
Restricting the Machine's Functions	229
Restricting the Printing Operations	230
Restricting USB Functions	234
Restricting Operation Panel Functions	237
Disabling HTTP Communication	240
Disabling Remote UI	241
Disabling the LAN Port	242
Hiding the Print Job History	243
Implementing Robust Security Features	245
Using TLS for Encrypted Communications	246
Configuring IPSec Settings	251
Configuring IEEE 802.1X Authentication	261
Configuring Settings for Key Pairs and Digital Certificates	267
Generating Key Pairs	268
Using CA-issued Key Pairs and Digital Certificates	277
Verifying Key Pairs and Digital Certificates	280

Security

51W4-03R

Confidential information is handled by information devices everywhere, including computers and printers, and any of these devices may become a target for malicious third parties at anytime. Attackers may directly gain unauthorized access to your devices, or indirectly take advantage of negligence or improper use. Either way, you may incur unanticipated losses when your confidential information is leaked. To counter these risks, the machine is equipped with a variety of security functions. Set the necessary configuration depending on your network environment.

NOTE

You can configure the best security system by building an environment that inhibits access to printers on your in-house network via the Internet and using such environment together with the machine's security features. ▶

Preventing Unauthorized Access(P. 202)

■ Establishing the Basics of Information Security

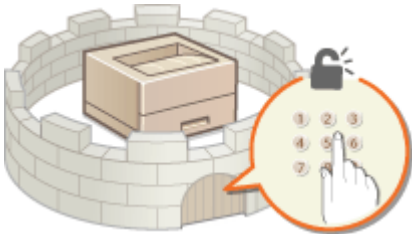

▶ Protecting the Machine from Unauthorized Access(P. 201)

■ Preparing for Risks from Negligence or Misuse

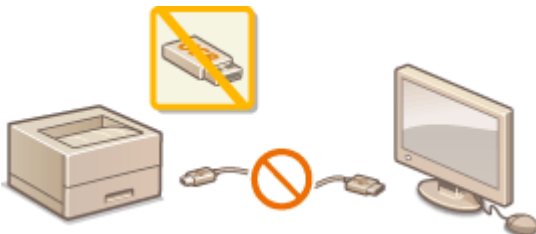

▶ Restricting the Machine's Functions(P. 229)



▶ Printing a Document Secured by a PIN (Secured Print) (P. 88)

■ Implementing Robust Security Features



▶ Implementing Robust Security Features(P. 245)

Protecting the Machine from Unauthorized Access

51W4-03S

Prevent unauthorized third parties from accessing and using the machine. You can implement multiple security measures, such as managing user access privileges and using firewalls.

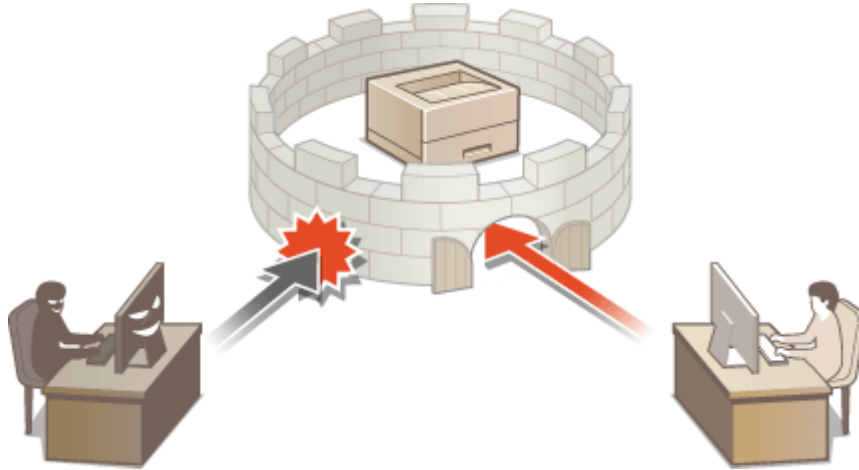

Preventing Unauthorized Access

51W4-03U

This section describes the security measures on how to prevent unauthorized access from the external network. This is a must-read for all users and administrators before using this machine, other printers, and multifunction machines connected to the network. In recent years, a printer/multifunction machine connected to the network can offer you a variety of useful functions, such as printing from a computer, operating from a computer using the remote function, and sending scanned documents via the Internet. On the other hand, it is essential to take security measures to reduce the security risk for information leakage, as a printer/multifunction machine has become more exposed to threats, such as unauthorized access and theft, when it is connected to the network. This section explains necessary settings you need to specify to prevent unauthorized access before using a printer/multifunction machine connected to the network.

Security Measures to Prevent Unauthorized Access from the External Network

- ▶ **Assigning a Private IP Address(P. 202)**
- ▶ **Using Firewall to Restrict Transmission(P. 203)**
- ▶ **Specifying the TLS Encrypted Communication (P. 203)**
- ▶ **Setting PIN to Manage Information Stored in the Printer(P. 203)**

Assigning a Private IP Address

An IP address is a numerical label assigned to each device participating in a computer network. A "global IP address" is used for the communication connecting to the Internet, and a "private IP address" is used for the communication within a local area network, such as a LAN in the company. If a global IP address is assigned, your printer/multifunction machine is open to the public and can be accessed via the Internet. Thus, the risk of information leakage due to unauthorized access from external network increases. On the other hand, if a private IP address is assigned, your printer/multifunction machine is closed to a local area network and can be accessed by only users on your local area network, such as a LAN in the company.

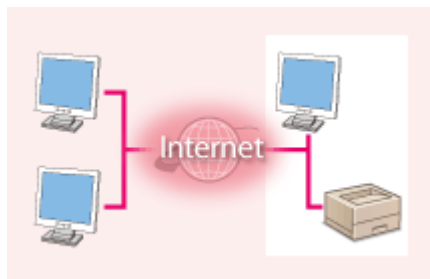

Global IP Address

Can be accessed from the external network

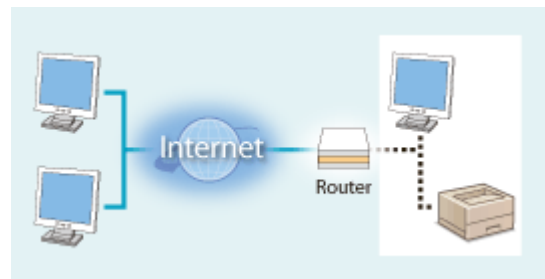

Private IP Address

Can be accessed from the users within a local area network

Basically, assign a private IP address to your printer/multifunction machine. Make sure to confirm the IP address, assigned to the printer/multifunction machine you are using, is a private IP address or not. A private IP address is found in one of the following ranges.

■ Ranges for Private IP addresses

- From 10.0.0.0 to 10.255.255.255
- From 172.16.0.0 to 172.31.255.255
- From 192.168.0.0 to 192.168.255.255

For information on how to confirm the IP address, see ▶ **Setting IPv4 Address(P. 140)** .

NOTE

- If a global IP address is assigned to a printer/multifunction machine, you can create a network environment to reduce the risk of unauthorized access by installing security software, such as a firewall that prevents

access from the external networks. If you want to assign a global IP address to and use a printer/multifunction machine, contact your network administrator.

Using Firewall to Restrict Transmission

A firewall is a system that prevents unauthorized access from the external networks and protects against attacks/intrusions to a local area network. You can use a firewall on your network environment to block access from the external network that appears to be dangerous, by restricting communication from specified IP address of the external network. The function installed to a Canon printer/multifunction machine enables you to set up the IP address filter. For information on how to set up an IP address filter, see [▶Specifying IP Addresses for Firewall Rules\(P. 217\)](#) .

Specifying the TLS Encrypted Communication

For information on the TLS Encrypted Communication, see [▶Implementing Robust Security Features\(P. 245\)](#) , and on the procedures to specify, see [▶Using TLS for Encrypted Communications\(P. 246\)](#) .

Setting PIN to Manage Information Stored in the Printer

If a malicious third party attempts to gain unauthorized access to a printer/multifunction machine, setting PIN to information stored in the machine will reduce the risk of information leakage. Canon printer/multifunction machine enables you to protect various type of information by setting PIN.

■Setting PIN to Each Function

- Setting PIN for Using Remote UI
For more information, see [▶Setting a Remote UI PIN\(P. 215\)](#) .
- Setting the password for the System Manager
For more information, see [▶Setting the System Manager Password\(P. 205\)](#) .

Listed above are some examples of security measures for preventing unauthorized access. For more information on the other security measures, see [▶Security\(P. 200\)](#) and take necessary security measures for preventing unauthorized access to suit your environment.

Setting Access Privileges

51W4-03W

Protect the machine from unauthorized access by only allowing users with access privileges to use the machine. Access privileges are set separately for the System Manager password, an account called "Department ID," and the Remote UI. When privileges are set, the user must enter an ID and PIN to print or change settings.

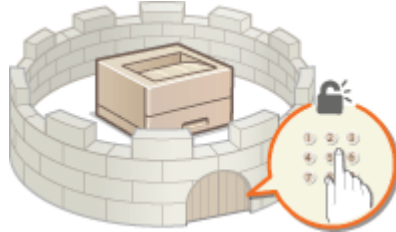

The System Manager password is intended exclusively for administrators while the Department ID is for general users. Both are specified by System Managers. And by setting a Remote UI Access PIN, you can restrict use of the Remote UI.

System Manager Password

Specifying the settings for the machine from the Remote UI requires the System Manager password. The password is set to "7654321" by default, and can be changed to allow only specific administrators to change the settings.

▶ Setting the System Manager Password (P. 205)

Department ID (Department ID Management)

Department ID is an account for managing printing jobs. You can register multiple Department IDs to specify access privileges for a user (or group of users). If a user tries to print a document when Department IDs are enabled, the screen for entering a Department ID is displayed, and the user must enter his/her own Department ID. Information for each Department ID can be viewed, such as how many pages have been printed.

▶ Setting the Department ID Management (P. 208)

Remote UI PIN (Remote UI Access PIN)

This is a PIN for using the Remote UI. Only users who know the PIN can access the Remote UI.

▶ Setting a Remote UI PIN (P. 215)

Setting the System Manager Password

51W4-03X

Changing the settings configured in the machine from the Remote UI requires administrative privileges. Follow the procedure shown below to change the System Manager password. The System Manager password settings information is critical to the security of the machine, so make sure that only Administrators know the System Manager password.

1 Start the Remote UI and log on in Management Mode. ▶ Starting Remote UI(P. 284)

2 Click [Settings/Registration].

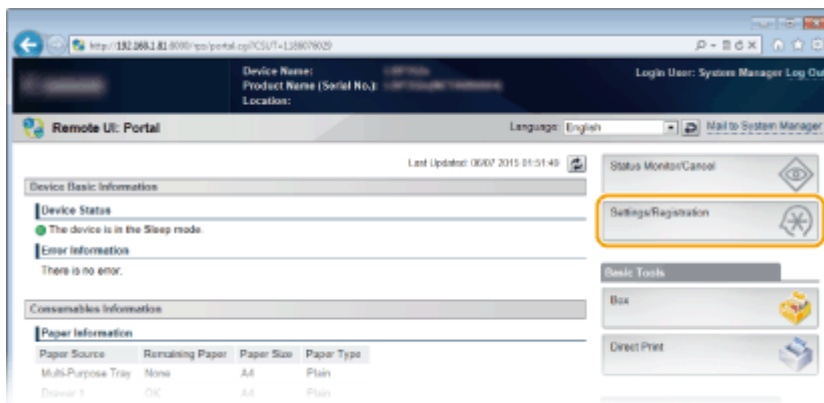

3 Click [Security] ▶ [Management Settings].

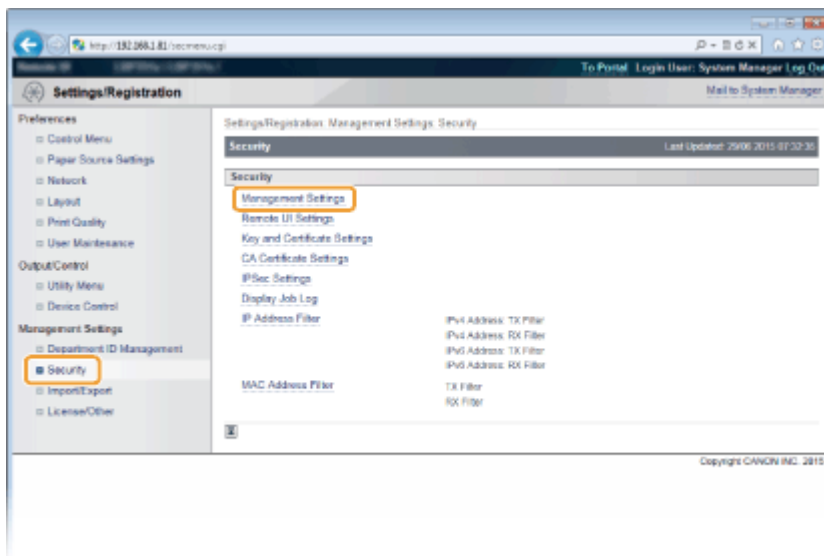

4 Click [Edit].

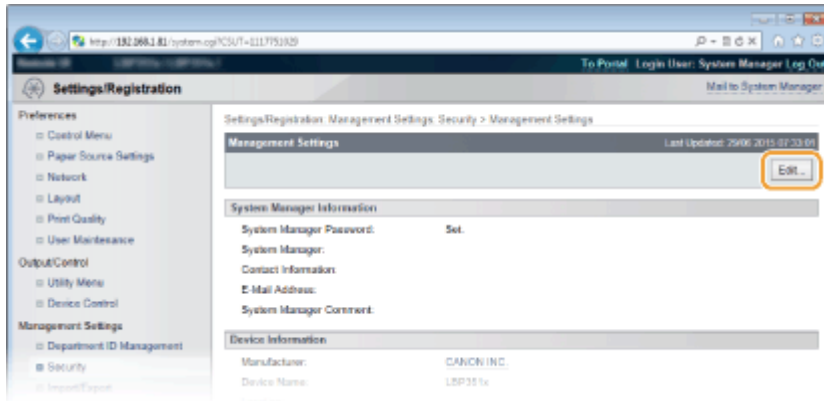

5 Enter the current password in [Current System Manager Password].

- The default password is "7654321".

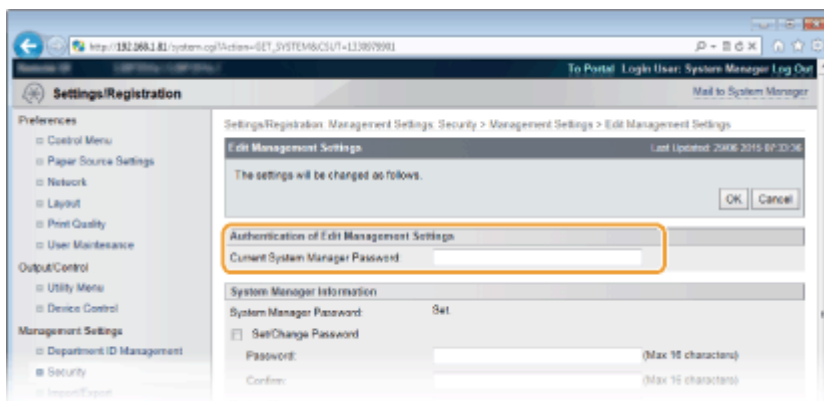

6 Enter a new password.

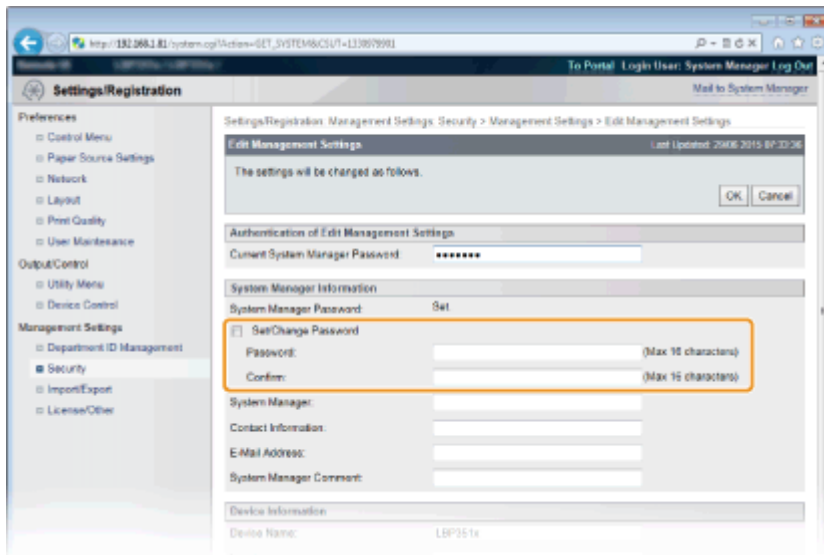

[Set/Change Password]

To set or change the password, select the check box and enter alphanumeric characters for the password in the [Password] text box. For confirmation, enter the same password in the [Confirm] text box.

NOTE:

- If you click [OK] with the check box selected and the [Password] and [Confirm] text boxes left blank, the currently set password is deleted.

7 Enter the System Manager name and contact information as necessary, and click [OK].

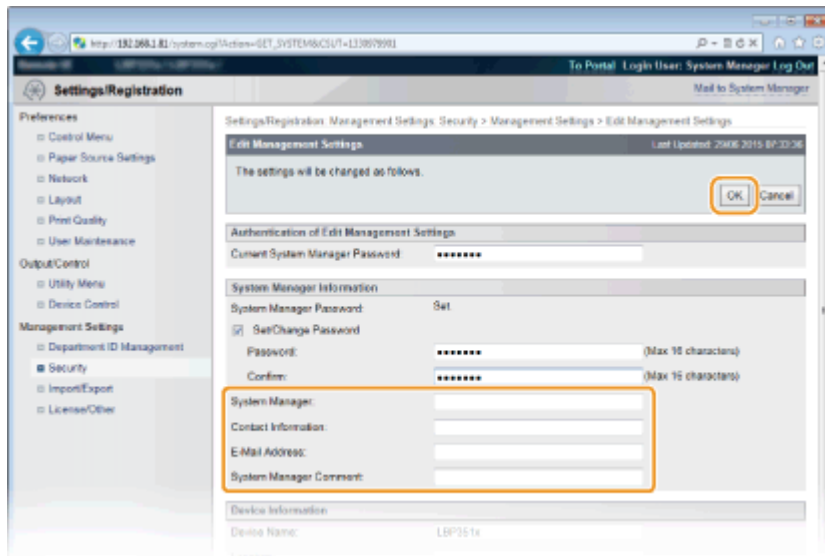

[System Manager]

Enter the name of an administrator.

[Contact Information]

Enter the contact information of the administrator.

[E-Mail Address]

Enter alphanumeric characters for the e-mail address of the administrator.

[System Manager Comment]

Enter comments of the administrator.

IMPORTANT

- Be sure to remember the password that you have set. If you have forgotten the password, contact your local authorized Canon dealer or the Canon help line.

LINKS

- ◀ [Setting Access Privileges\(P. 204\)](#)
- ◀ [Checking System Manager Information\(P. 296\)](#)

Setting the Department ID Management

51W4-03Y

You can control access to the machine by using multiple IDs for multiple users or groups. If a user tries to operate the machine when Department ID Management is enabled, a logon screen is displayed, and the user must enter their own Department ID and PIN to use the machine. Department ID Management provides recorded details of the past use of the machine for each Department ID. To configure Department ID Management, register department IDs as necessary and then enable Department ID Management function. Additional settings are required if you want to enable Department ID Management for printing from a computer.

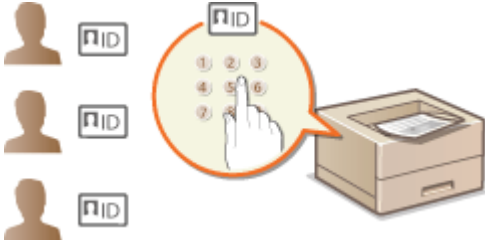

- ▶ **Registering/Editing Department ID and PIN(P. 208)**
- ▶ **Enabling the Department ID Management(P. 209)**
- ▶ **Setting the Department ID Management for Printing from the Computer(P. 212)**
- ▶ **Blocking Jobs When Department ID Is Unknown(P. 213)**

NOTE

To manage the print status of each department

- ▶ **Checking the Number of Pages Printed for Each Department(P. 450)**

Registering/Editing Department ID and PIN

Register a Department ID and set a PIN for it. Register all the department IDs to be managed.

- 1 Start the Remote UI and log on in Management Mode. ▶ Starting Remote UI(P. 284)**
- 2 Click [Settings/Registration].**

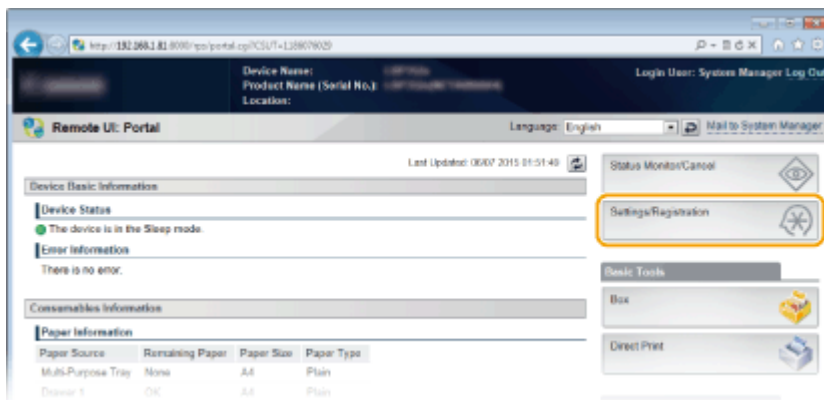

- 3 Click [Department ID Management] and register or edit Department IDs.**

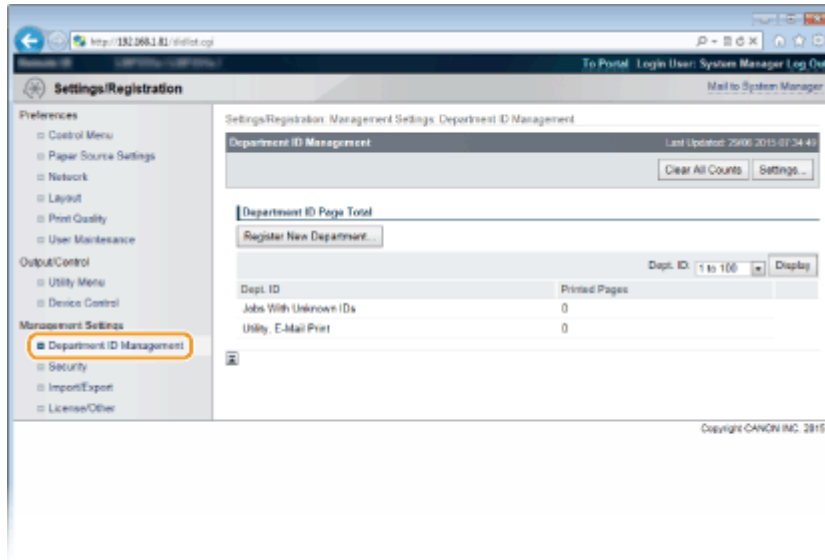

■ Registering a Department ID

- 1 Click [Register New Department].
- 2 Specify the required settings and click [OK].

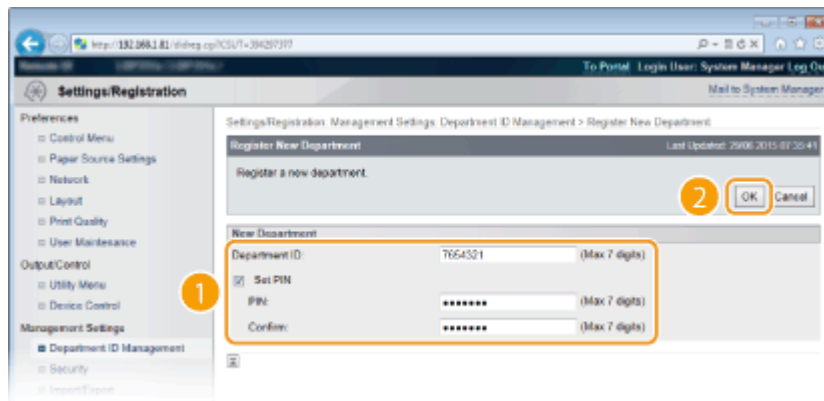

[Department ID]

Enter the Department ID number to be registered.

[Set PIN]

To set a PIN, select the check box and enter the same number both in the [PIN] and [Confirm] text boxes.

■ Editing the settings of the registered Department ID

- 1 Click the corresponding text link under [Department ID] to edit.
- 2 Change the settings as necessary and click [OK].

NOTE:

Deleting a Department ID

- Click [Delete] on the right of the Department ID you want to delete ► click [OK].

Enabling the Department ID Management

After you register as many Department IDs as necessary, enable Department ID Management.

1 Start the Remote UI and log on in Management Mode. ▶ Starting Remote UI(P. 284)

2 Click [Settings/Registration].

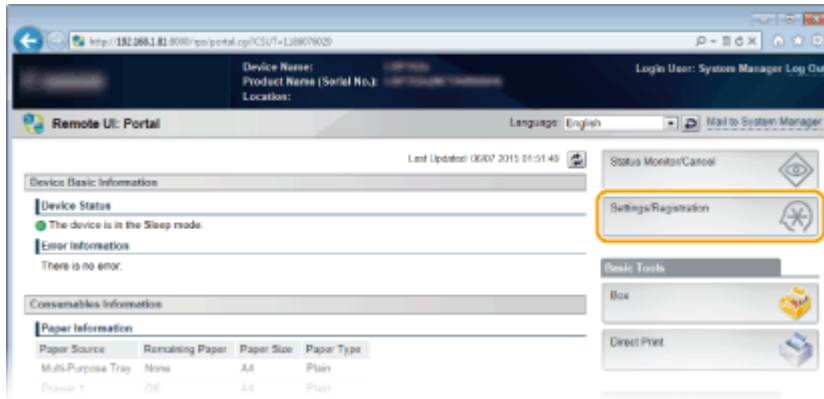

3 Click [Department ID Management] ▶ [Settings].

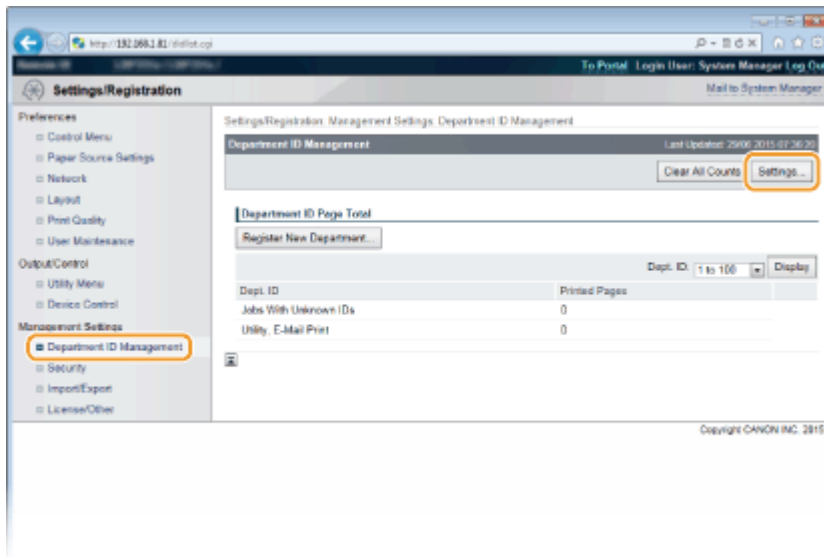

4 Select the [Enable Department ID Management] check box and click [OK].

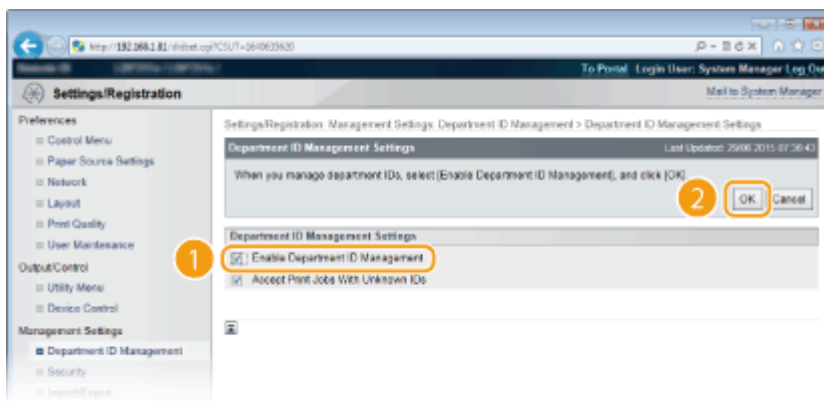

[Enable Department ID Management]

Select the check box to enable Department ID Management. If you do not want to use Department ID Management, clear the check box.

NOTE:

- For information on the [Accept Print Jobs With Unknown IDs] check box, see **Blocking Jobs When Department ID Is Unknown(P. 213)** .

NOTE

If Department ID Management is enabled

- When users try to print a file in the USB memory device or a document stored on the SD card from the operation panel, the authentication screen is displayed. Enter the Department ID and PIN, select <Log In>, and press **OK** .



- To log on to the Remote UI in General User Mode, you must enter the Department ID and PIN. **Starting Remote UI(P. 284)**

■ When the XPS Printer Driver Is Used

If you want to use Department ID Management when the XPS printer driver is used, set key pairs for TLS encrypted communication (**Using TLS for Encrypted Communications(P. 246)**). After completing the settings of key pairs, configure the settings shown below.



Log on to the Remote UI in Management Mode (**Starting Remote UI(P. 284)**) ▶ [Settings/Registration] ▶ [Network] ▶ [TCP/IP Settings] ▶ [Edit] in [Department ID Management PIN Confirmation Settings] ▶ Select the [Use Department ID Management PIN Confirmation] check box ▶ [OK]

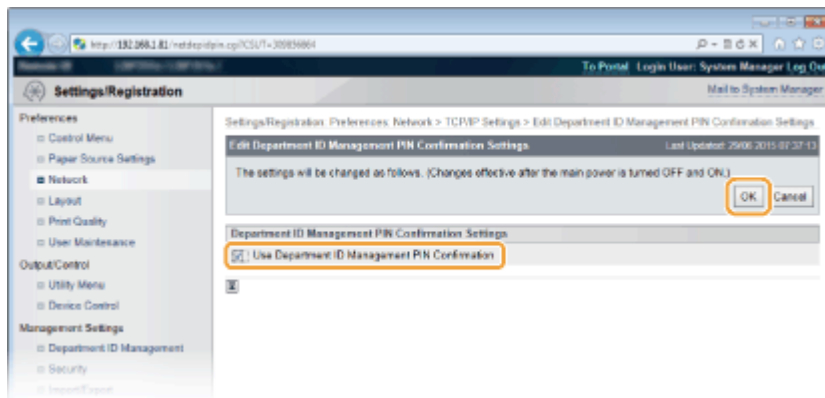

[Use Department ID Management PIN Confirmation]

If you select the check box, Department ID Management will be enabled for printing with the XPS printer driver. If you do not want to use Department ID Management, clear the check box.

IMPORTANT:

- If any key pair is not set in the machine, you cannot enable [Use Department ID Management PIN Confirmation]. **Configuring Settings for Key Pairs and Digital Certificates(P. 267)**

Setting the Department ID Management for Printing from the Computer

If you want to enable Department ID Management for printing from a computer, you need to specify settings by using the printer driver you already installed on the computer. Specify the Department ID and PIN as necessary.

IMPORTANT

- To perform the following procedure, log on to your computer with an administrator account.

1 Open the printer folder. ▶ **Displaying the Printer Folder(P. 522)**

2 Right-click the printer driver icon for this machine and click [Printer properties] or [Properties].

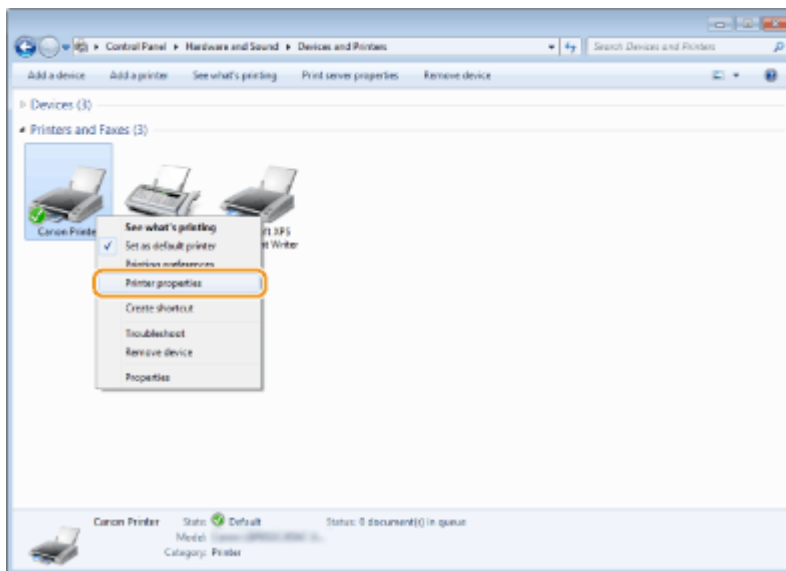

3 Click the [Device Settings] tab and specify the required settings.

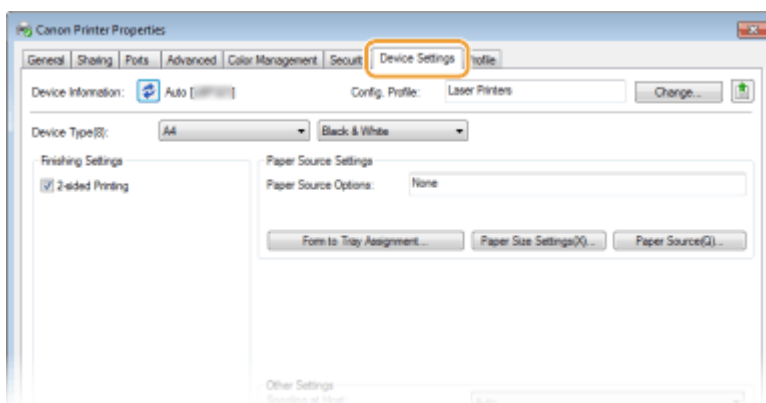

- Select [Department ID Management] in [User Management], and then click [Settings] located below.
- Specify the settings as necessary and click [OK].

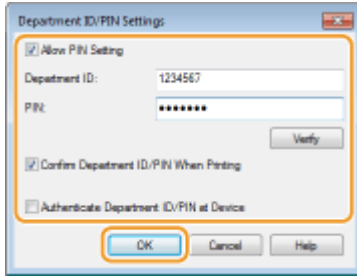
**[Allow PIN Setting]**

Select the check box to enable the PIN setting.

[Department ID]

Enter the Department ID number.

[PIN]

Enter the PIN corresponding to the Department ID as necessary.

[Verify]

Click to verify that the correct ID and PIN are entered. This function is not available if the machine and the computer are connected via a USB or WSD (Web Services on Devices) port.

[Confirm Department ID/PIN When Printing]

Select the check box to display the [Confirm Department ID/PIN] pop-up screen each time you print from a computer.

[Authenticate Department ID/PIN at Device]

Select the check box if the machine and the computer are connected via a USB or WSD port.

3 Click [OK].

NOTE

Logging on to the machine

- When you try to print from a computer when Department ID Management is enabled, the following pop-up screen is displayed (unless the [Confirm Department ID/PIN When Printing] check box is cleared):



Blocking Jobs When Department ID Is Unknown

The factory default settings are such that even when Department ID Management is enabled, you can print from a computer without entering an ID and PIN. If you want to change this so that printing is not possible unless an ID and PIN are entered, use the following procedure.

- 1 Start the Remote UI and log on in Management Mode. ▶ Starting Remote UI(P. 284)**
- 2 Click [Settings/Registration].**

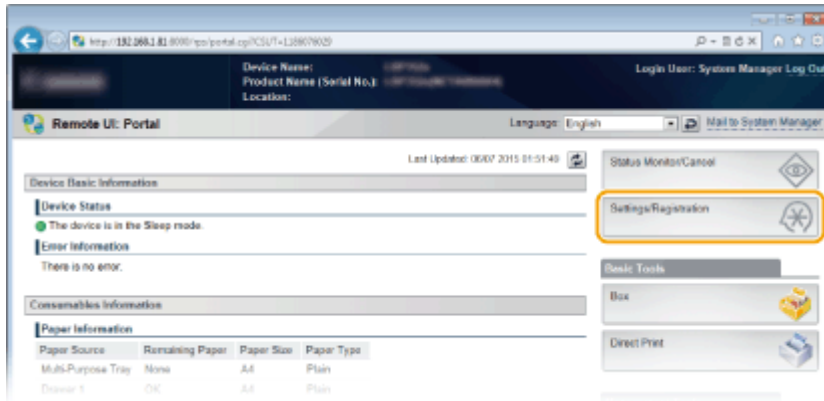

3 Click [Department ID Management] ► [Settings].

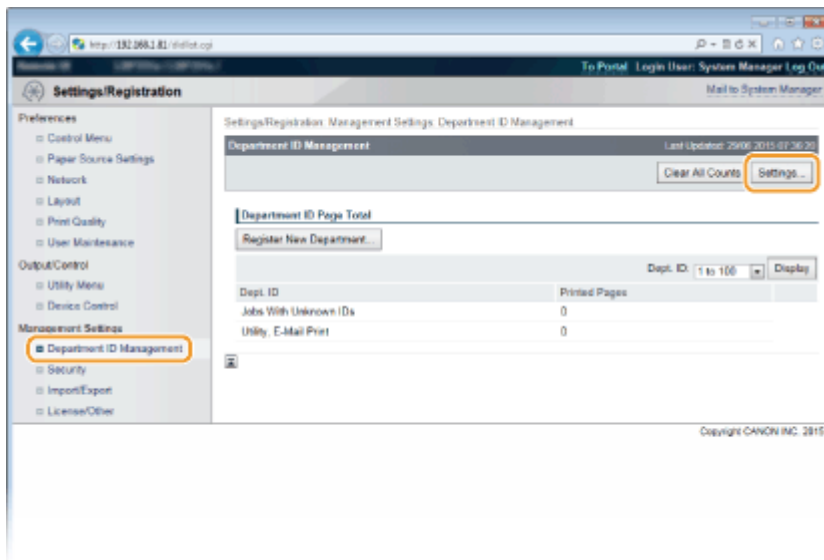

4 Clear the [Accept Print Jobs With Unknown IDs] check box and click [OK].

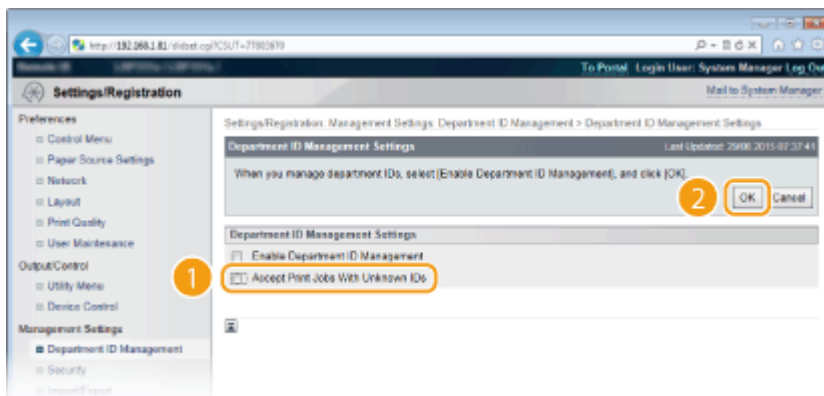

IMPORTANT:

- If you clear the check box, users cannot print by a method that is not supported by Department ID Management or perform Direct Print from the Remote UI that the users log on in Management Mode.

LINKS

- ◉ **Setting Access Privileges(P. 204)**
- ◉ **Setting the System Manager Password(P. 205)**

Setting a Remote UI PIN

You can set a PIN for access to the Remote UI. All users use a common PIN.

NOTE

- When Department ID Management is enabled, setting here is not required. [▶Setting the Department ID Management\(P. 208\)](#)

- 1 Press **▶** ().
- 2 Use **▲ / ▼** to select <Network>, and press **OK**.
 - When a message appears, press **OK**.
- 3 Select <Remote UI Settings> **▶** <RUI Access Sec. Set.>.
- 4 Select <On>, and press **OK**.

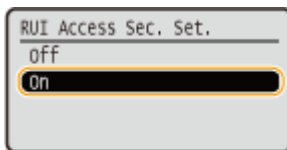

5 Set a PIN.

- Enter a number for the PIN and press **OK**.
- As <Confirm PIN> is displayed for confirmation, enter again the same PIN digits.



NOTE

If Remote UI settings are initialized

- The Remote UI Access PIN is also initialized. After an initialization, reset the PIN. [▶Initializing Menu\(P. 456\)](#)

LINKS

- [▶Setting Access Privileges\(P. 204\)](#)
- [▶Setting the System Manager Password\(P. 205\)](#)

Restricting Communication by Using Firewalls

51W4-041

Without proper security, unauthorized third parties can access computers and other communication devices that are connected to a network. To prevent this unauthorized access, specify the settings for packet filter, a feature that restricts communication to devices with specified IP addresses or MAC addresses.

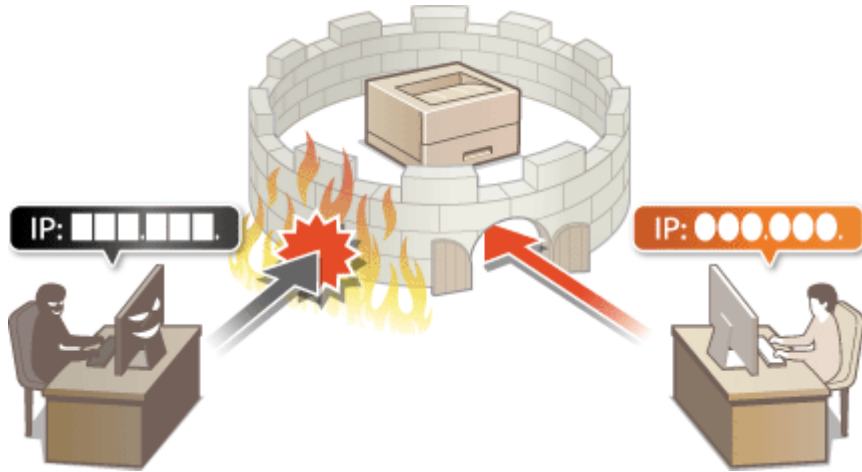

Specifying IP Addresses for Firewall Rules

51W4-042

You can either limit communication to only devices with specified IP addresses, or block devices with specified IP addresses but permit other communications. You can specify a single IP address or a range of IP addresses. For data reception, you can specify IP addresses by specifying port numbers.

1 Start the Remote UI and log on in Management Mode. ▶ Starting Remote UI(P. 284)

2 Click [Settings/Registration].

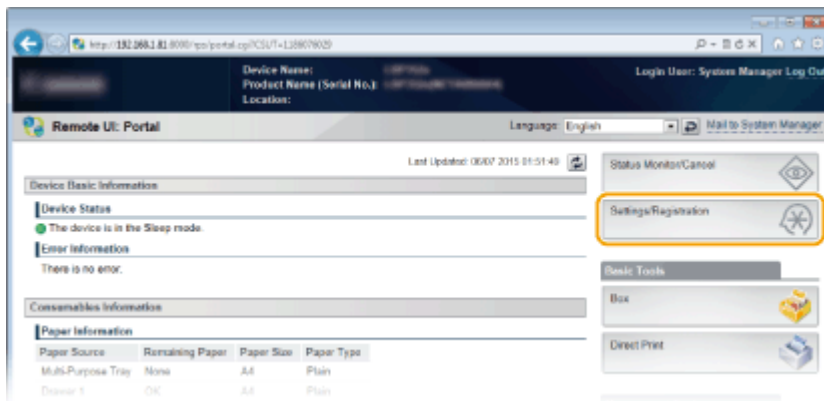

3 Click [Security] ▶ [IP Address Filter].

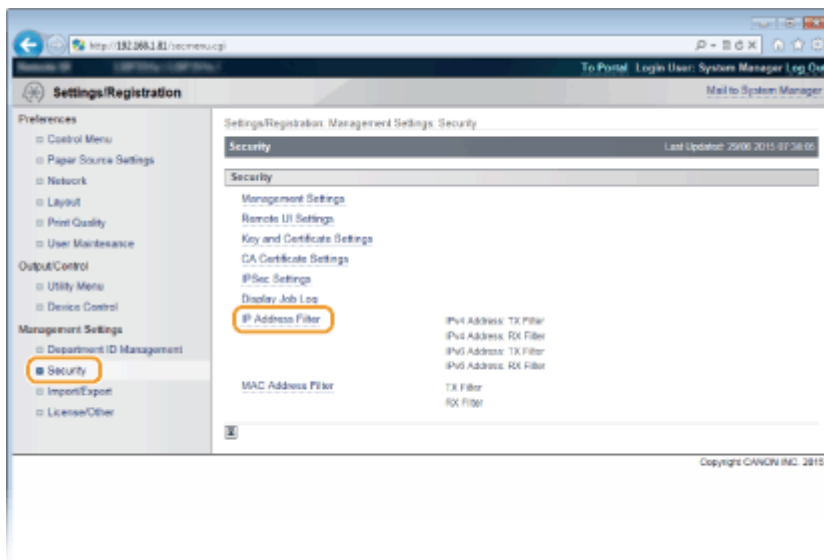

4 Click [Edit] for the filter type that you want to use.

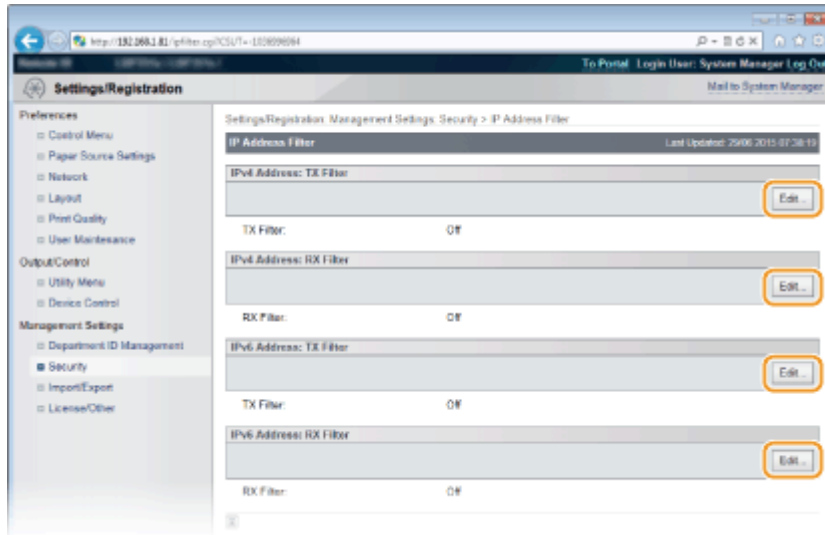

[IPv4 Address: TX Filter]

Select to restrict sending data from the machine to a computer by specifying IPv4 addresses.

[IPv4 Address: RX Filter]

Select to restrict receiving data from the machine to a computer by specifying IPv4 addresses and the port number.

[IPv6 Address: TX Filter]

Select to restrict sending data from the machine to a computer by specifying IPv6 addresses.

[IPv6 Address: RX Filter]

Select to restrict receiving data from the machine to a computer by specifying IPv6 addresses and the port number.

5 Specify the settings for packet filtering.

■ For TX Filter

Select the default policy to allow or reject the communication of other devices with the machine, and then specify IP addresses for exceptions.

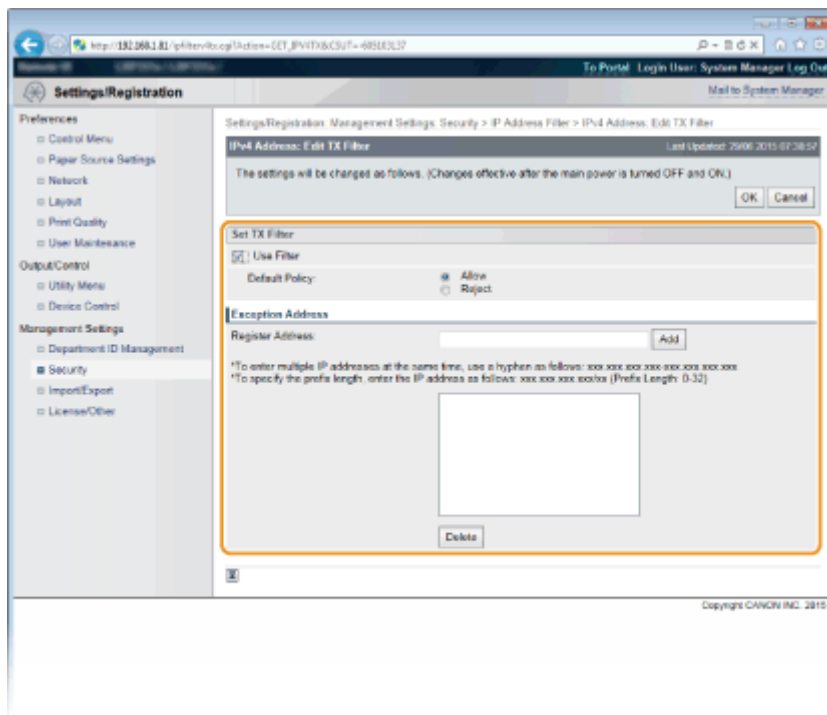

1 Select the [Use Filter] check box and click the [Reject] or [Allow] radio button for the [Default Policy].

[Use Filter]

Select the check box to restrict communication. Clear the check box to disable the restriction.

[Default Policy]

Select the precondition to allow or reject the communication of other devices with the machine.

[Allow]	Select to block communication packets when they are sent to or received from devices whose IP addresses are entered in [Exception Addresses]. Communications with other devices are permitted.
[Reject]	Select to pass communication packets only when they are sent to or received from devices whose IP addresses are entered in [Exception Addresses]. Communications with other devices are prohibited.

2 Specify address exceptions.

- Enter the IP address (or the range of IP addresses) in [Register Address] and click [Add].

IMPORTANT:

Check for entry errors

- If IP addresses are incorrectly entered, you may be unable to access the machine from the Remote UI, in which case you need to set <Address Filter> to <Off>. **Address Filter(P. 344)**

NOTE:

When you have selected [Reject] under [Default Policy]

- Loopback, multicast, and broadcast packets cannot be filtered.

Deleting an IP address from exceptions

- Select an IP address and click [Delete].



3 Click [OK].

■ For RX Filter

When selecting [Allow] under [Default Policy], specify the IP addresses of devices whose communication with the machine should be blocked. When selecting [Reject] under [Default Policy], specify the IP addresses of devices that should be able to communicate with the machine.

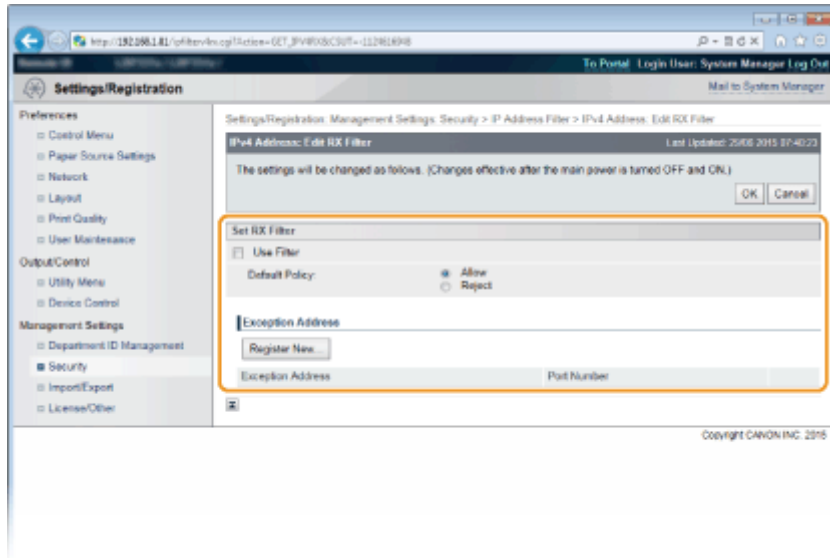

1 Click [Register New].

2 Specify address exceptions.

- Enter the IP address (or the range of IP addresses) in [Register Address].
- To specify a port number, select the [Specify Port Number] check box, enter a port number in [Port Number], and click [Add].

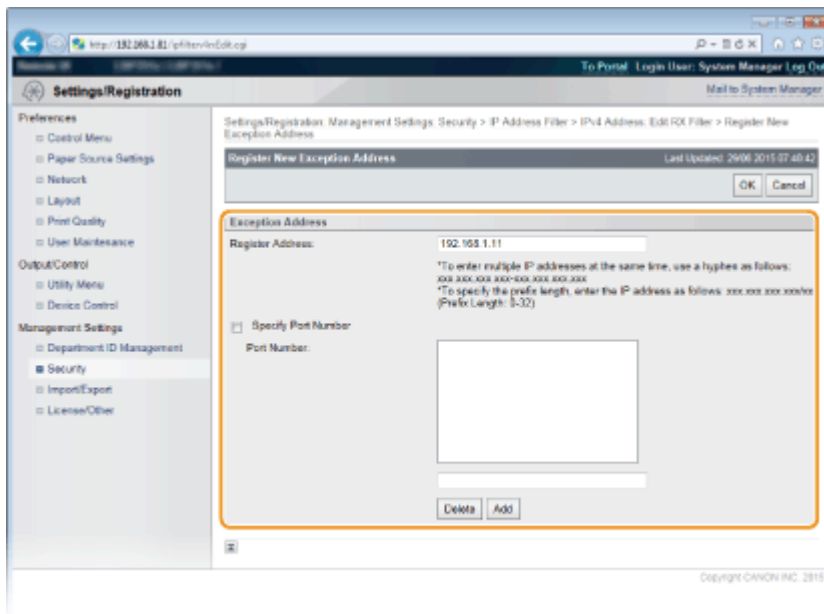

IMPORTANT:

Check for entry errors

- If IP addresses or the port numbers are incorrectly entered, you may be unable to access the machine from the Remote UI, in which case you need to set <Address Filter> to <Off>. **▶Address Filter(P. 344)**

NOTE:

To delete a set port number

- Select the port number to delete, and click [Delete].

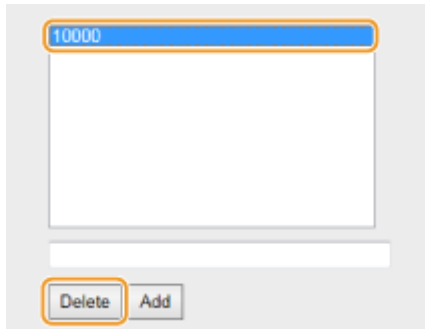

- 3 Click [OK].
- 4 Select the [Use Filter] check box and click the [Reject] or [Allow] radio button for the [Default Policy].

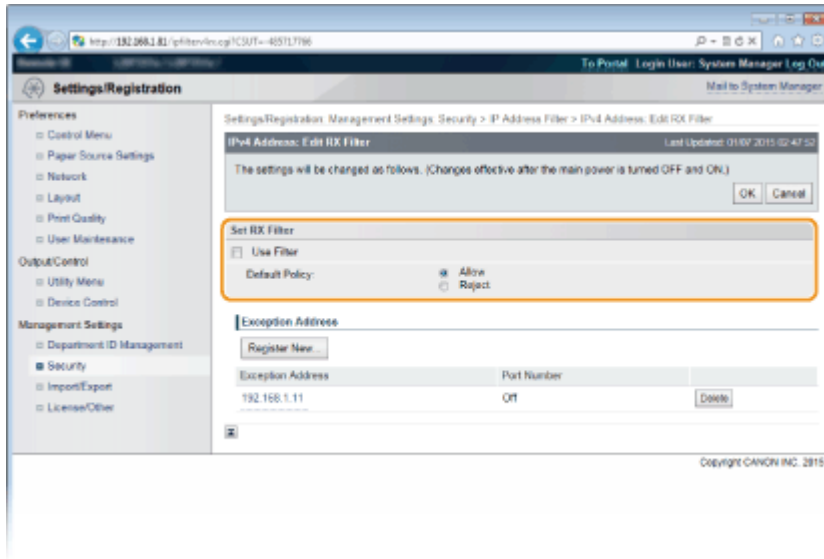

[Use Filter]

Select the check box to restrict communication. Clear the check box to disable the restriction.

[Default Policy]

Select the precondition to allow or reject the communication of other devices with the machine.

[Allow]	Select to block communication packets when they are sent to or received from devices whose IP addresses are entered in [Exception Addresses]. Communications with other devices are permitted.
[Reject]	Select to pass communication packets only when they are sent to or received from devices whose IP addresses are entered in [Exception Addresses]. Communications with other devices are prohibited.

NOTE:

Editing a set IP address from exceptions

- Click the corresponding text link under [Exception Addresses], in the screen that has been displayed change settings as necessary, and click [OK].

Deleting an IP address from exceptions

- Select an IP address to delete, and click [Delete].

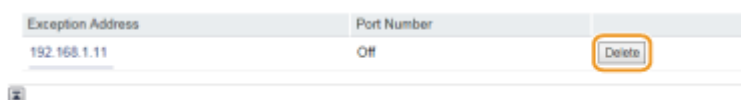

5 Click [OK].

6 Perform a hard reset.

- Click [Device Control], select [Hard Reset], and then click [Execute].

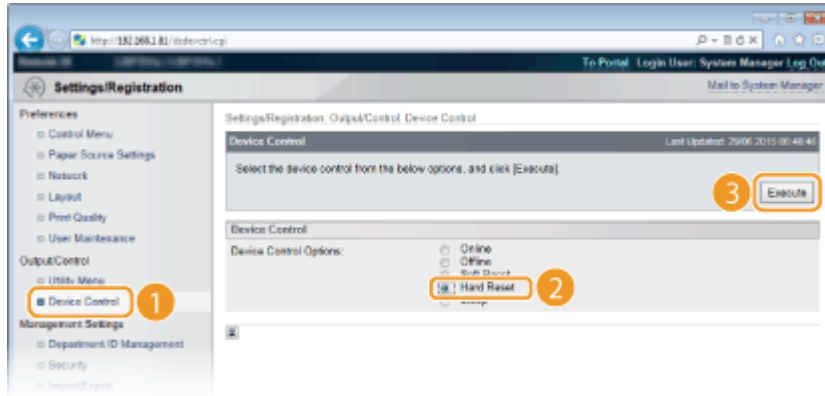

⇒ The settings are enabled after the hard reset is performed.

NOTE

Using the operation panel

- You can also enable or disable IP address filtering from the Setting menu of the operation panel. ▶ **Address Filter(P. 344)**

LINKS

▶ **Specifying MAC Addresses for Firewall Rules(P. 223)**

Specifying MAC Addresses for Firewall Rules

51W4-043

You can limit communication to only devices with specified MAC addresses, or block devices with specified MAC addresses but permit other communications.

1 Start the Remote UI and log on in Management Mode. ▶ Starting Remote UI(P. 284)

2 Click [Settings/Registration].

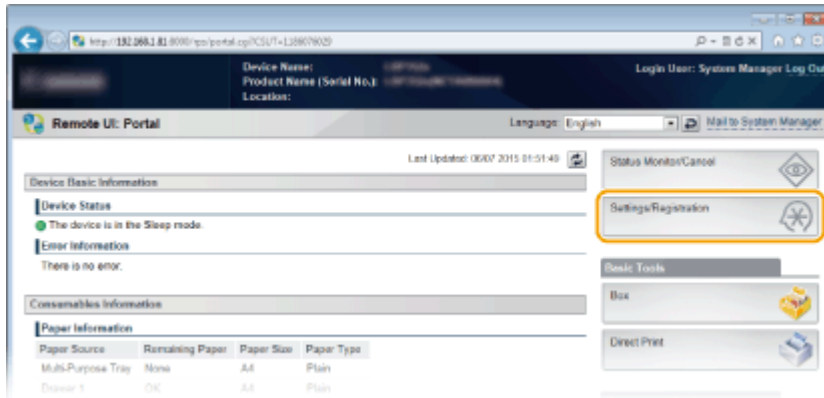

3 Click [Security] ▶ [MAC Address Filter].

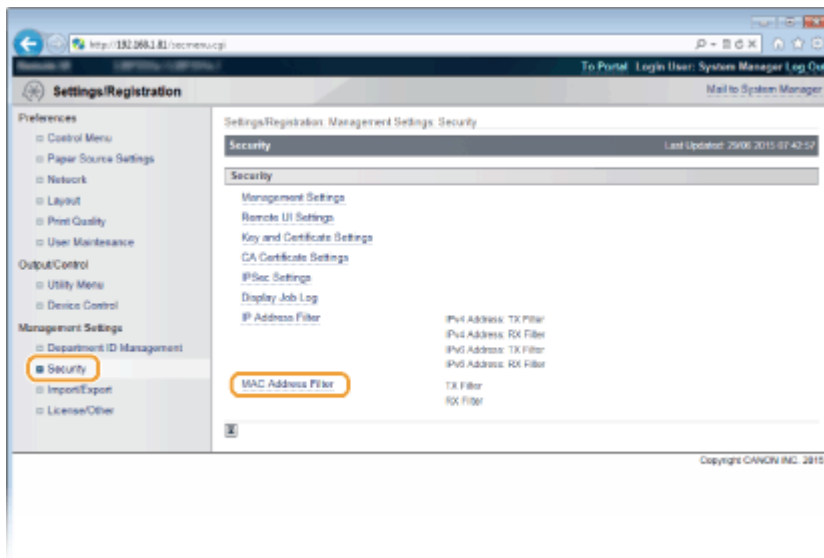

4 Click [Edit] for a filter type.

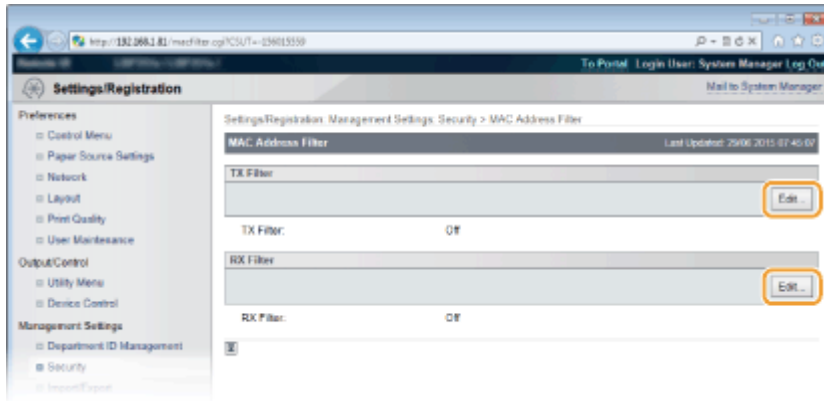

[TX Filter]

Select to restrict sending data from the machine to a computer by specifying MAC addresses.

[RX Filter]

Select to restrict receiving data from the machine to a computer by specifying MAC addresses.

5 Specify the settings for packet filtering.

- Select the precondition (default policy) to allow or reject the communication of other devices with the machine, and then specify MAC addresses for exceptions.

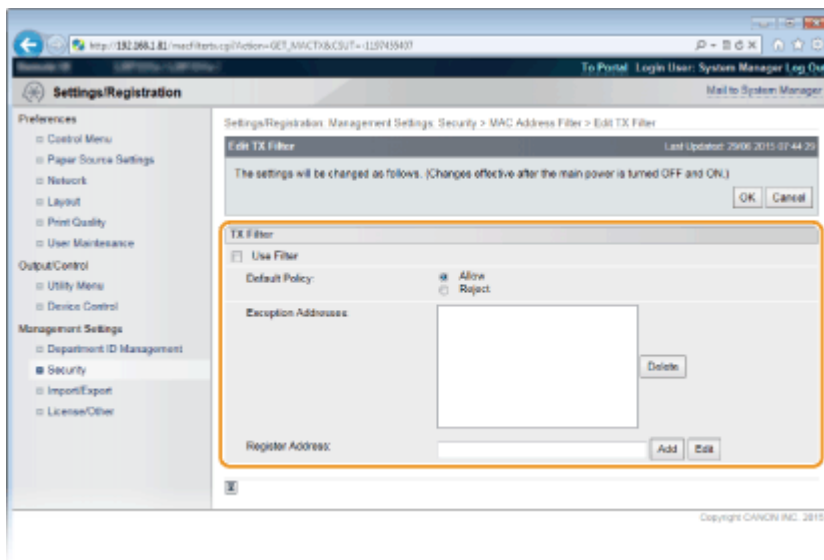

- 1 Select the [Use Filter] check box and click the [Allow] or [Reject] radio button for the [Default Policy].

[Use Filter]

Select the check box to restrict communication. Clear the check box to disable the restriction.

[Default Policy]

Select the precondition to allow or reject other devices to communicate with the machine.

[Allow]	Select to block communication packets when they are sent to or received from devices whose MAC addresses are entered in [Exception Addresses]. Communications with other devices are permitted.
[Reject]	Select to pass communication packets only when they are sent to or received from devices whose MAC addresses are entered in [Exception Addresses]. Communications with other devices are prohibited.

- 2 Specify address exceptions.

- Enter the MAC address in the [Register Address] text box and click [Add].

- You do not need to delimit the address with hyphens or colons.

IMPORTANT:**Check for entry errors**

- If MAC addresses are incorrectly entered, you may become unable to access the machine from the Remote UI, in which case you need to set <Address Filter> to <Off>. ▶ **Address Filter(P. 344)**

NOTE:**When you have selected [Reject] under [Default Policy]**

- Outgoing multicast and broadcast packets cannot be filtered.

Deleting a MAC address from exceptions

- Select a MAC address and click [Delete].

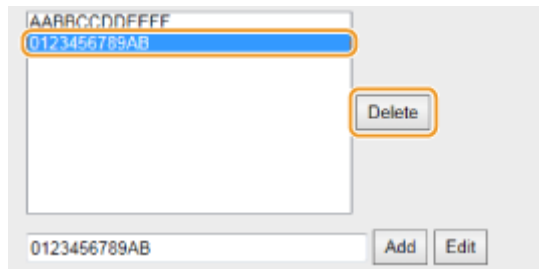

- 3 Click [OK].

6 Perform a hard reset.

- Click [Device Control], select [Hard Reset], and then click [Execute].

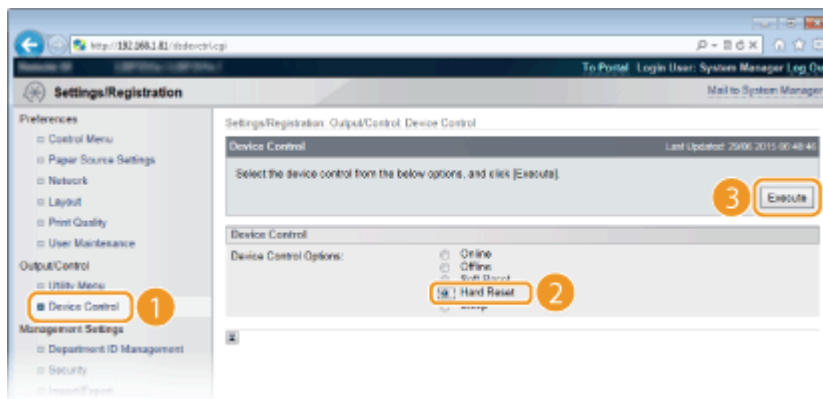

⇒ The settings are enabled after the hard reset is performed.

NOTE**Using the operation panel**

- You can also enable or disable MAC address filtering from the setting menu of the operation panel. ▶ **Address Filter(P. 344)**

LINKS

- ▶ **Specifying IP Addresses for Firewall Rules(P. 217)**

Setting a Proxy

51W4-044

A proxy (or HTTP proxy server) refers to a computer or software that carries out HTTP communication for other devices, especially when communicating with resources outside the network, such as when browsing Web sites. The client devices connect to the outside network through the proxy server, and do not communicate directly to the resources outside. Setting a proxy not only facilitates management of traffic between in-house and outside networks but also blocks unauthorized access and consolidates anti-virus protection for enhanced security. When you use Google Cloud Print to print over the Internet, you can enhance security by setting a proxy. When setting a proxy, make sure that you have the necessary proxy information, including the IP address, port number, and a user name and password for authentication.

1 Start the Remote UI and log on in Management Mode. ▶ Starting Remote UI(P. 284)

2 Click [Settings/Registration].

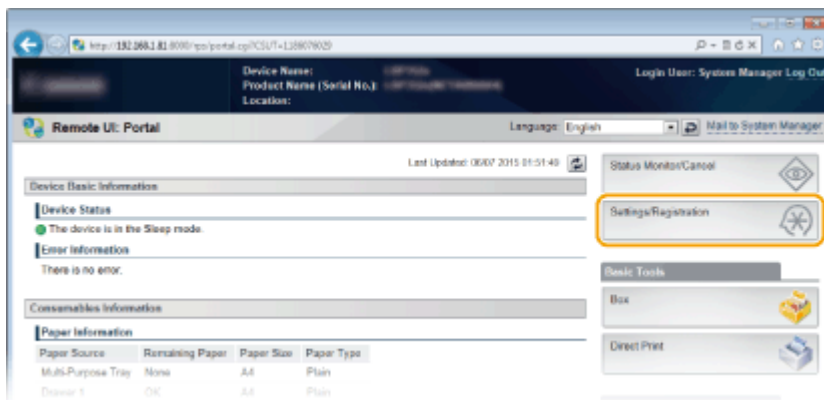

3 Click [Network] ▶ [TCP/IP Settings].

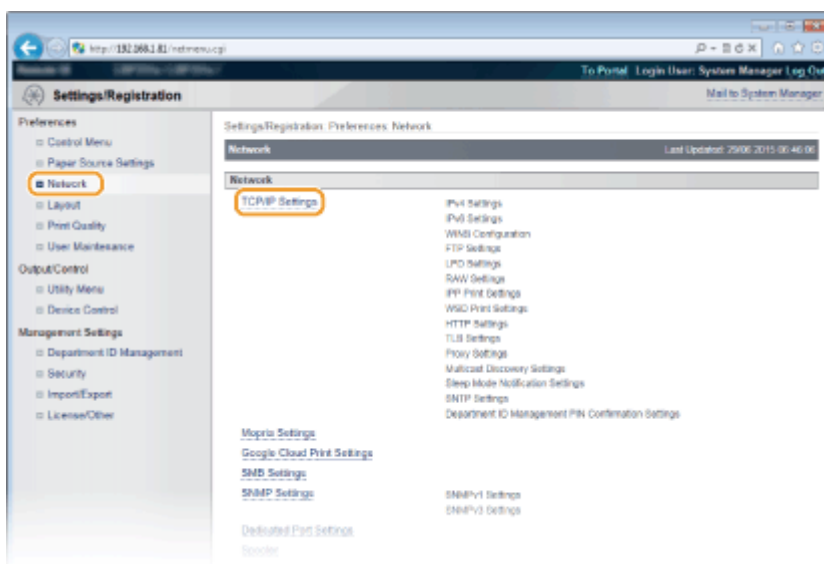

4 Click [Edit] in [Proxy Settings].

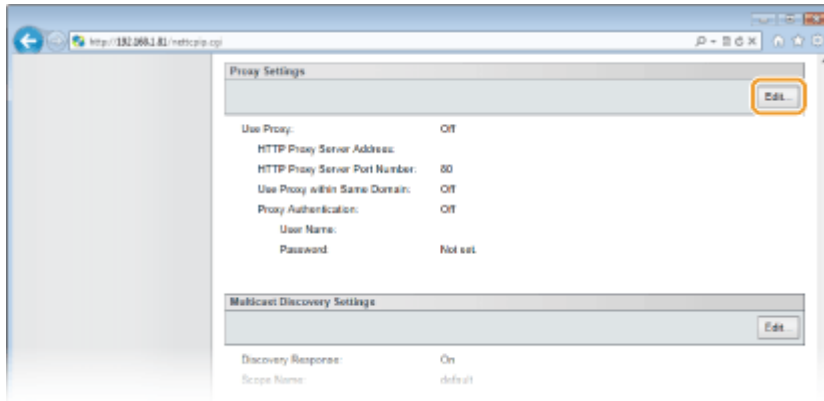

5 Select the [Use Proxy] check box and specify the required settings.

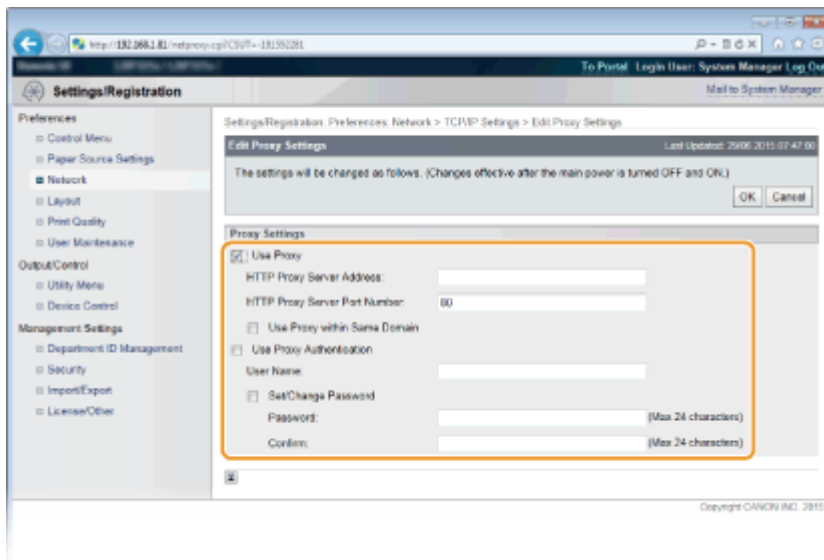

[Use Proxy]

Select the check box to use the specified proxy server when communicating with an HTTP server.

[HTTP Proxy Server Address]

Enter the address of the proxy server. Specify the IP address or host name depending on the environment.

[HTTP Proxy Server Port Number]

Change the port number as necessary.

[Use Proxy within Same Domain]

Select the check box to also use the specified proxy server for communication with devices in the same domain.

[Use Proxy Authentication]

To enable authentication by the proxy server, select the check box and enter alphanumeric characters for the user name in the [User Name] text box.

[Set/Change Password]

To set or change the password for the proxy authentication, when it is enabled, select the check box and enter alphanumeric characters for the new password in the [Password] text box. For confirmation, enter the same password in the [Confirm] text box.

6 Click [OK].

7 Perform a hard reset.

- Click [Device Control], select [Hard Reset], and then click [Execute].

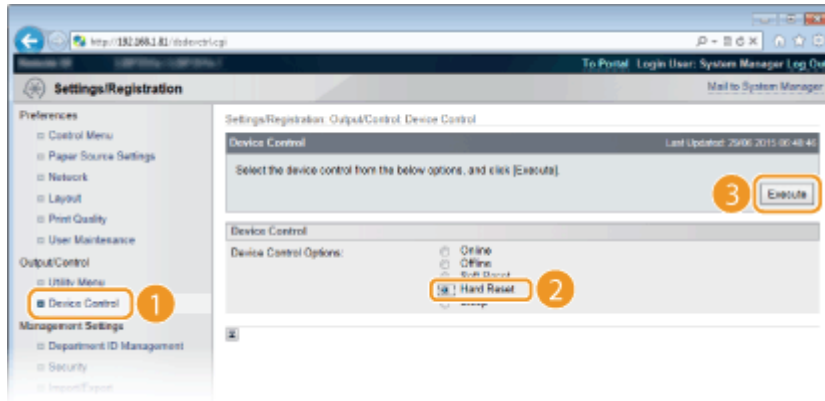

⇒ The settings are enabled after the hard reset is performed.

NOTE

Using the operation panel

- Proxy settings can also be accessed from the setting menu of the operation panel. ▶ [Proxy Settings\(P. 333\)](#)

LINKS

- ▶ [Using Google Cloud Print\(P. 128\)](#)

Restricting the Machine's Functions

51W4-045

Some of the functions of the machine may rarely be used or provide opportunities for misuse. For security purposes, the machine can be set to limit its capabilities by partially or completely disabling these functions.

Restricting the Printing Functions



▶ Restricting the Printing Operations(P. 230)

Restricting USB Functions

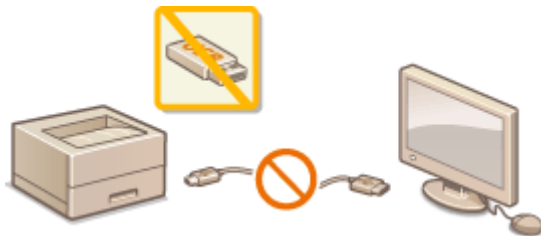

▶ Restricting USB Functions(P. 234)

Restricting Operation Panel Functions

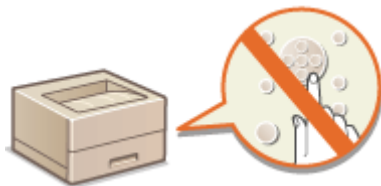

▶ Restricting Operation Panel Functions(P. 237)

Restricting Network Functions Including HTTP Communications



▶ Disabling HTTP Communication(P. 240)

▶ Disabling Remote UI(P. 241)

▶ Disabling the LAN Port(P. 242)

Hiding the Print Job History



▶ Hiding the Print Job History(P. 243)

Restricting the Printing Operations

51W4-046

You can specify settings to prevent received print data from being automatically printed, reducing wasteful use of paper and disabling third parties to use the machine. To use this function, you must install an optional SD card. [▶ Installing an SD Card\(P. 495\)](#)



NOTE

- Even when the printing operations are restricted, settings lists and reports can be printed. [▶ Printing Reports and Lists\(P. 441\)](#)

1 Start the Remote UI and log on in Management Mode. [▶ Starting Remote UI\(P. 284\)](#)

2 Click [Settings/Registration].

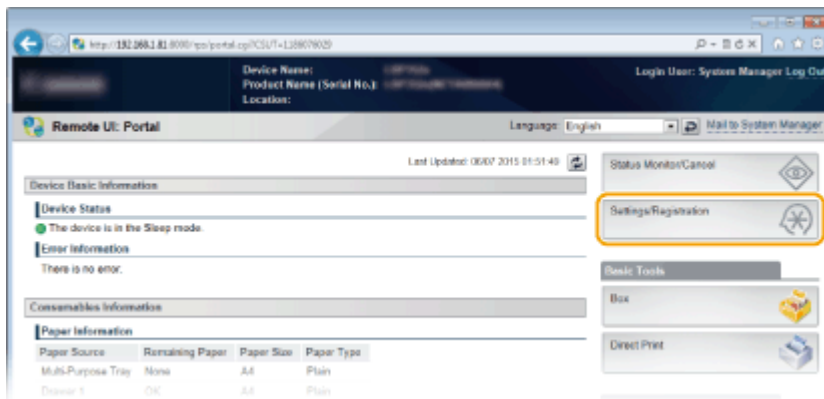

3 Click [Security] ▶ [Management Settings].

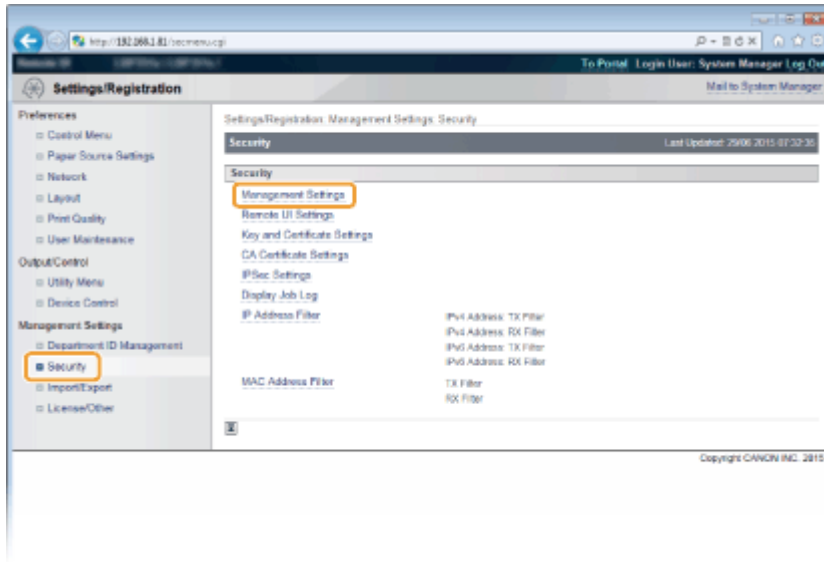

4 Click [Edit].

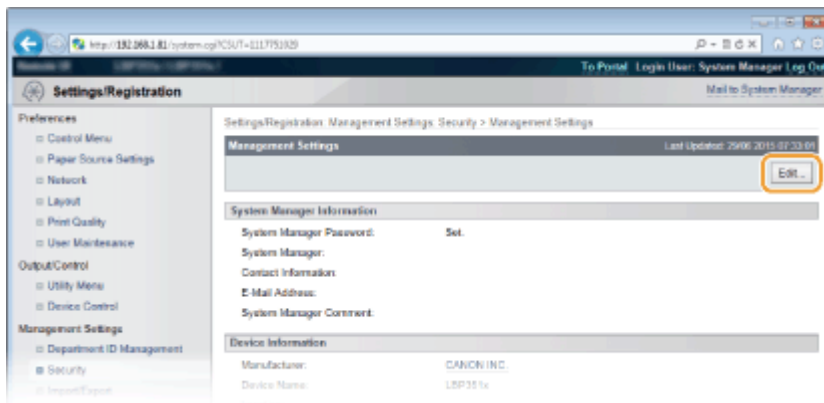

5 Enter the System Manager password in [Current System Manager Password].

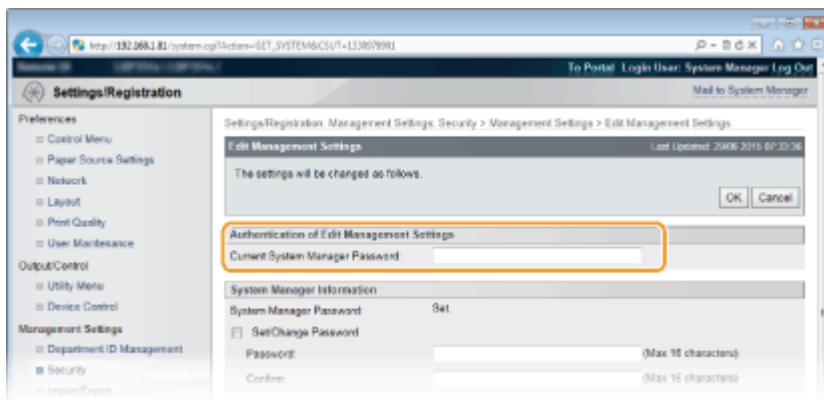

6 Select the [Restrict Printer Jobs] check box and click [OK].

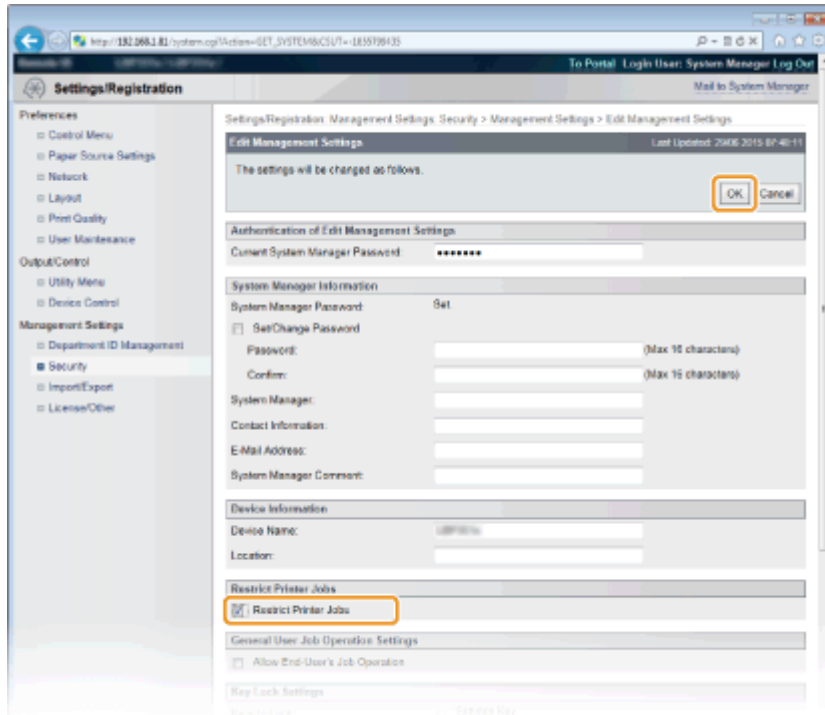

[Restrict Printer Jobs]

Select the check box to restrict the printing operations of the machine. Clear the check box to disable the restriction.

7 Perform a hard reset.

- Click [Device Control], select [Hard Reset], and then click [Execute].

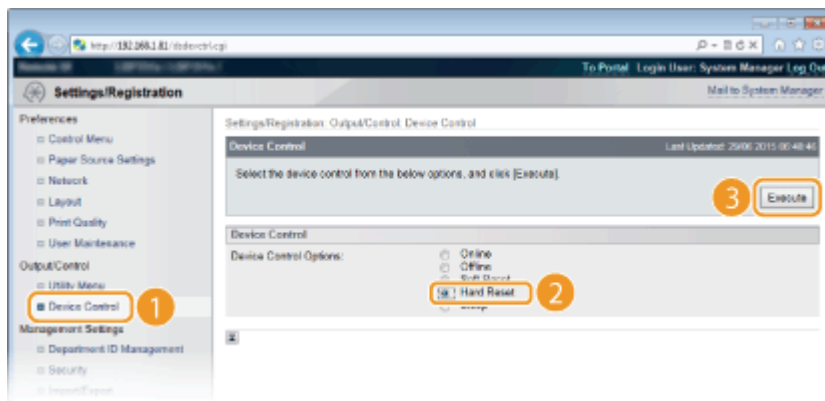

⇒ The settings are enabled after the hard reset is performed.

NOTE

When the printing operations are restricted

- Only Stored Job Print can be performed from the printer drivers. ▶ **Printing a Document Stored in the Machine (Stored Job Print)(P. 92)**
- Only PDF, PS, EPS, and XPS files stored in boxes can be printed from the Remote UI. ▶ **Printing without Opening a File (Direct Print)(P. 101)**
- USB Direct Print from the USB memory device and E-mail Print are not available.

▶ **Printing a Document Stored in the Machine (Stored Job Print)(P. 92)**

Restricting USB Functions

51W4-047

USB is a convenient way of connecting peripheral devices and storing or relocating data, but USB can also be a source of information leakage if it is not properly managed. Be especially careful when handling USB memory devices. This section describes how to restrict connection via the USB port of the machine and how to prohibit use of USB memory devices.

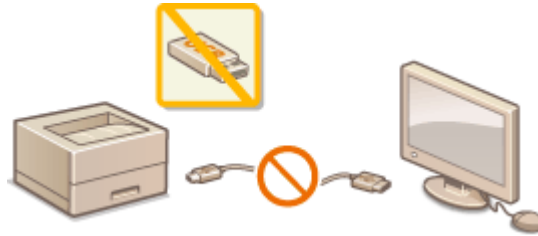

- ▶ **Restricting the USB Connection with a Computer(P. 234)**
- ▶ **Restricting the USB Direct Print Function(P. 235)**

Restricting the USB Connection with a Computer

You can disable the USB port, for connecting a computer, located on the back side of the machine. Connection to a computer via USB will be disabled, but a USB memory device can be connected to the USB port on the right side of the machine.

- 1** Press **▶** ().
- 2** Use **▲ / ▼** to select **<Interface>**, and press **OK**.
- 3** Select **<Interface Selection>** and press **OK**.
 - When a message appears, press **OK**.
- 4** Select **<USB>** and press **OK**.
- 5** Select **<Off>** and press **OK**.



a **<Off>**

Disables the USB port located on the back side of the machine.

b **<On>**

Enables the USB port located on the back side of the machine.

6 Perform a hard reset. ▶ Performing a Hard Reset(P. 408)

⇒ The settings are enabled after the hard reset is performed.

Restricting the USB Direct Print Function

You can disable printing data from a USB memory device. This makes it impossible to print data stored in the USB memory.

1 Start the Remote UI and log on in Management Mode. ▶ Starting Remote UI(P. 284)

2 Click [Settings/Registration].

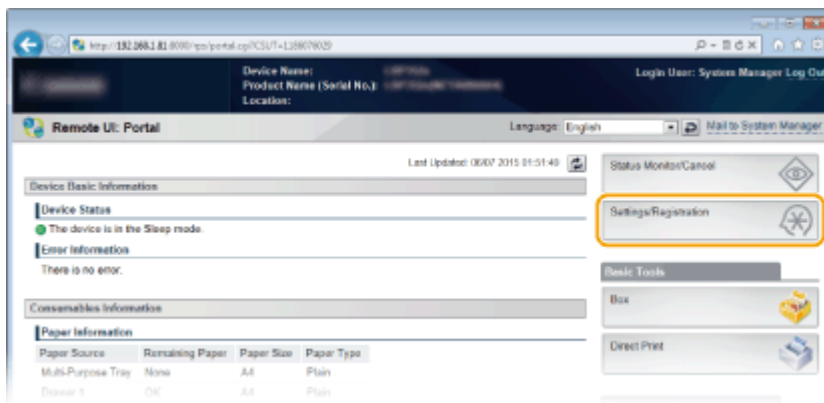

3 Click [Security] ▶ [Management Settings].

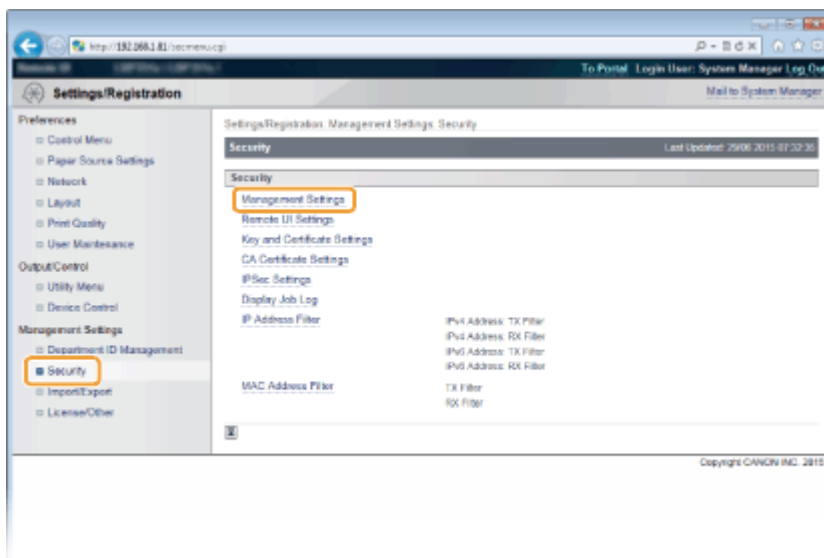

4 Click [Edit].

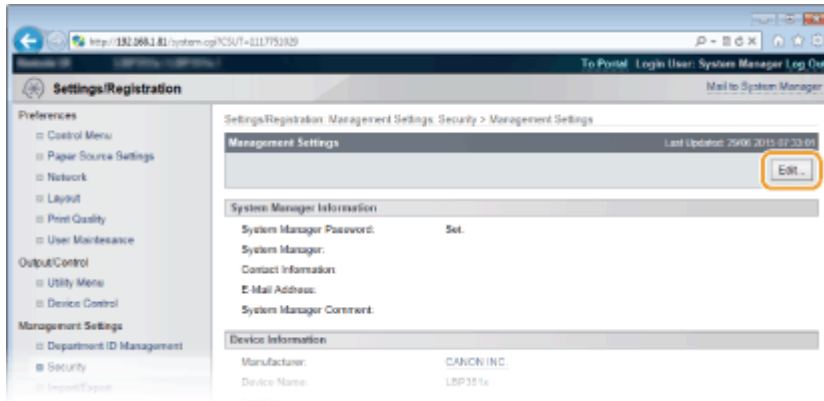

5 Enter the System Manager password in [Current System Manager Password].

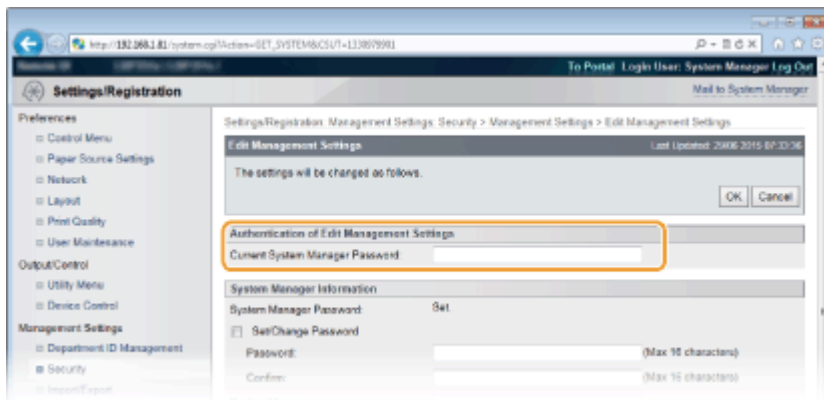

6 Clear the [USB Direct Print] check box and click [OK].

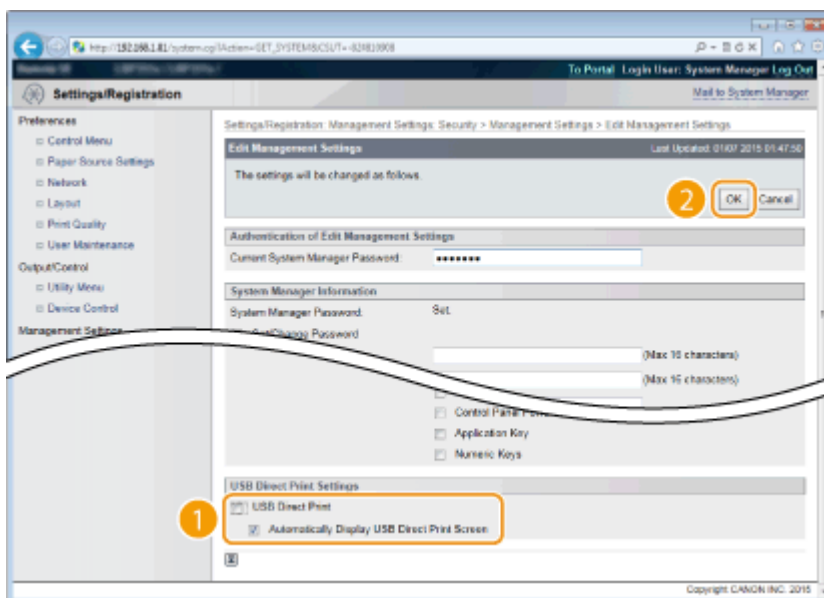

[USB Direct Print]

Clear the check box to disable direct printing from a USB memory device. Select the check box to enable printing from a USB memory device. If you also select the [Automatically Display USB Direct Print Screen] check box, the USB Direct Print screen will be automatically displayed when a USB memory device is attached to the machine.

LINKS

▶ **Printing from USB Memory (USB Direct Print)(P. 77)**

Restricting Operation Panel Functions

51W4-048

You can restrict the use of the keys on the operation panel to prevent the settings of the machine from being carelessly changed.



1 Start the Remote UI and log on in Management Mode. ▶ Starting Remote UI(P. 284)

2 Click [Settings/Registration].

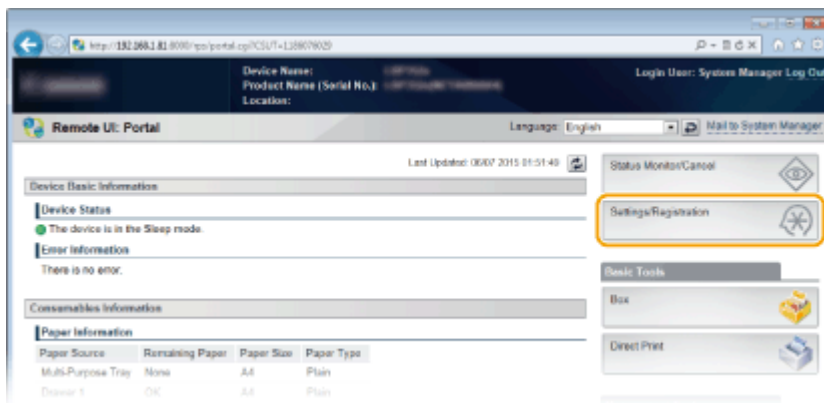

3 Click [Security] ▶ [Management Settings].

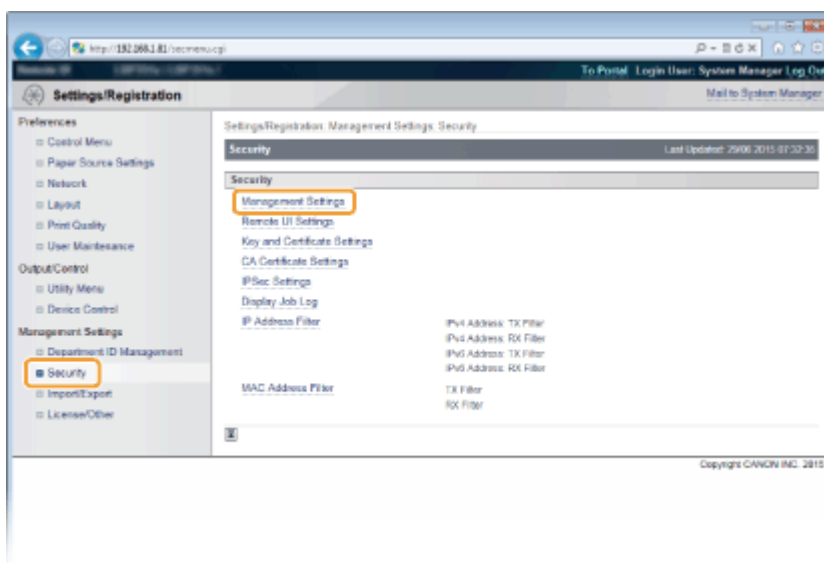

4 Click [Edit].

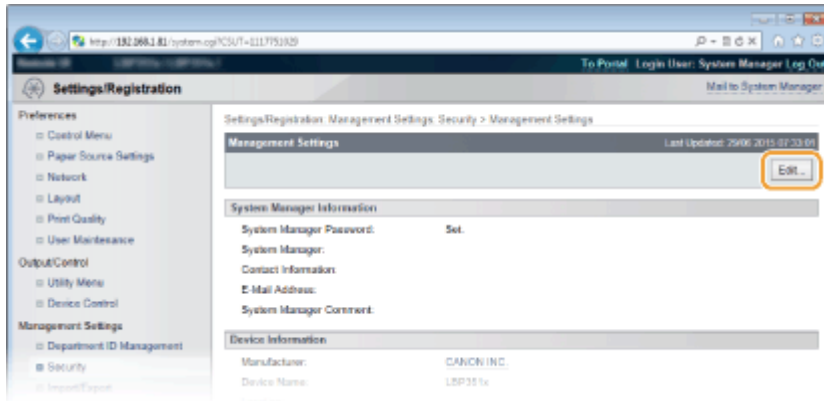

5 Enter the System Manager password in [Current System Manager Password].

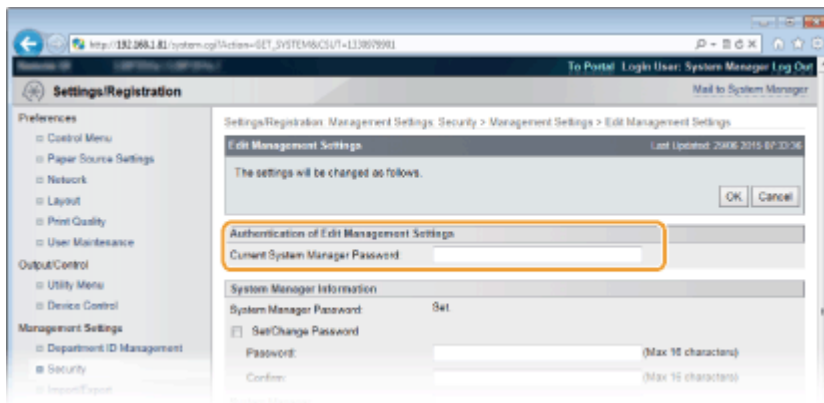

6 Select the check box of the key to restrict and click [OK].

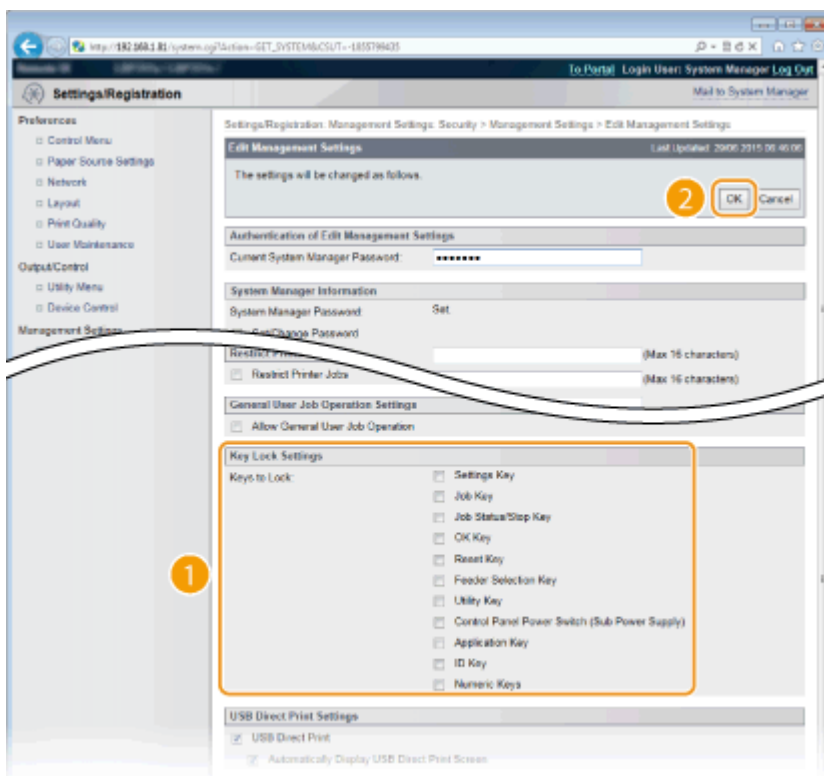

[Keys to Lock]

You can select the check box to lock the corresponding key even when it is pressed on the operation panel. Clear the check box to unlock the key. You can also lock the Setup key from the operation panel (**Mng. Settings(P. 320)**).

NOTE:

- Functions of the Keys ▶ **Operation Panel(P. 25)**

Disabling HTTP Communication

51W4-049

HTTP is used for communications over the network, such as when you access the machine via the Remote UI. If you are using a USB connection or are otherwise not using HTTP, you can disable HTTP to block malicious third-party intrusions via the unused HTTP port.

IMPORTANT

Disabling HTTP disables some of the network capabilities, such as the Remote UI, WSD printing., and printing with Google Cloud Print.

1 Press **▶** ().

2 Use **▲** / **▼** to select **<Network>**, and press **OK**.

- When a message appears, press **OK**.

3 Select **<TCP/IP Settings>** **▶** **<HTTP>**.

4 Select **<Off>**, and press **OK**.



a **<Off>**

Disables HTTP communication.

b **<On>**

Enables HTTP communication.

5 Perform a hard reset. **▶ Performing a Hard Reset(P. 408)**

⇒ The settings are enabled after the hard reset is performed.

LINKS

- ▶ **Using Remote UI(P. 283)**
- ▶ **Configuring Printing Protocols and WSD Functions(P. 149)**
- ▶ **Using Google Cloud Print(P. 128)**
- ▶ **When the XPS Printer Driver Is Used(P. 211)**

Disabling Remote UI

51W4-04A

The Remote UI is useful because the machine settings can be specified by using a Web browser on a computer. To use the Remote UI, the machine must be connected to a computer over the network. If the machine is connected to a computer via USB, or if you do not need to use the Remote UI, you might want to disable the Remote UI to reduce the risk of having your machine controlled remotely over the network by malicious third parties.



- 1 Press **▶** ().
- 2 Use **▲ / ▼** to select **<Network>**, and press **OK**.

- When a message appears, press **OK**.

- 3 Select **<Remote UI Settings>** **▶** **<Remote UI>**.

- 4 Select **<Off>**, and press **OK**.



- a** **<Off>**

Disables the Remote UI.

- b** **<On>**

Enables the Remote UI.

- 5 Perform a hard reset. **▶ Performing a Hard Reset(P. 408)**

⇒ The settings are enabled after the hard reset is performed.

LINKS

- ▶ **Using Remote UI(P. 283)**
- ▶ **Disabling HTTP Communication(P. 240)**

Disabling the LAN Port

51W4-04C

A LAN port is an interface that connects a LAN cable for using a network. When you are using the machine via USB, you can disable the LAN port to completely shut down the network, blocking malicious third-party intrusions via the LAN port.



- 1 Press **▶** ().
- 2 Use **▲** / **▼** to select <Interface>, and press **OK**.
- 3 Select <Interface Selection> and press **OK**.
 - When a message appears, press **OK**.
- 4 Select <Network> and press **OK**.
- 5 Select <Off> and press **OK**.



a <Off>

Disables the LAN port.

b <On>

Enables the LAN port.

- 6 Perform a hard reset. **▶ Performing a Hard Reset(P. 408)**

⇒ The settings are enabled after the hard reset is performed.

Hiding the Print Job History

51W4-04E

To protect the privacy of users, you can specify settings to disable displaying the print job history on the Remote UI screen and printing the print history list. The print job history is updated and maintained even if it is set to be hidden, so that administrators can view the history as necessary.



1 Start the Remote UI and log on in Management Mode. ▶ Starting Remote UI(P. 284)

2 Click [Settings/Registration].

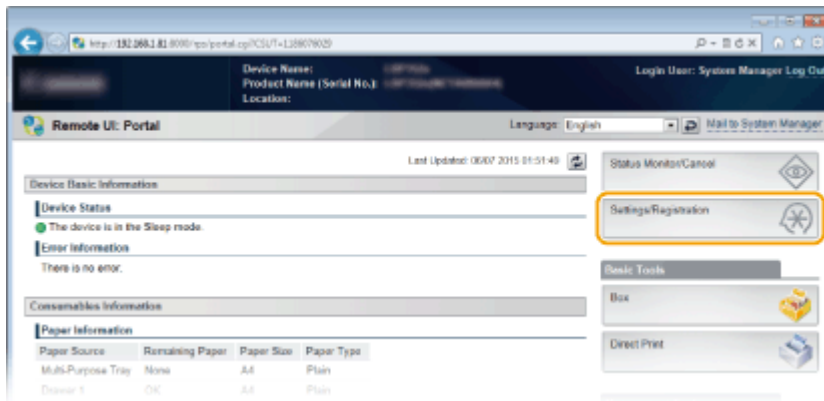

3 Click [Security] ▶ [Display Job Log].

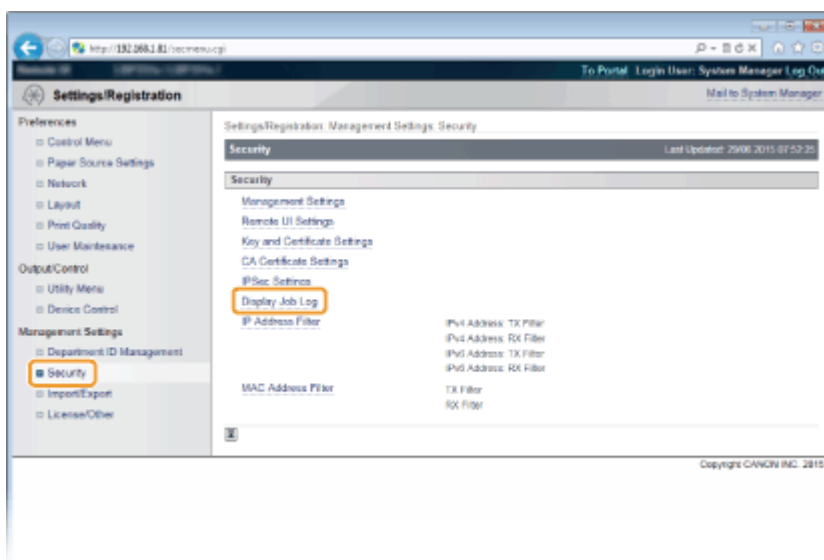

4 Click [Edit].

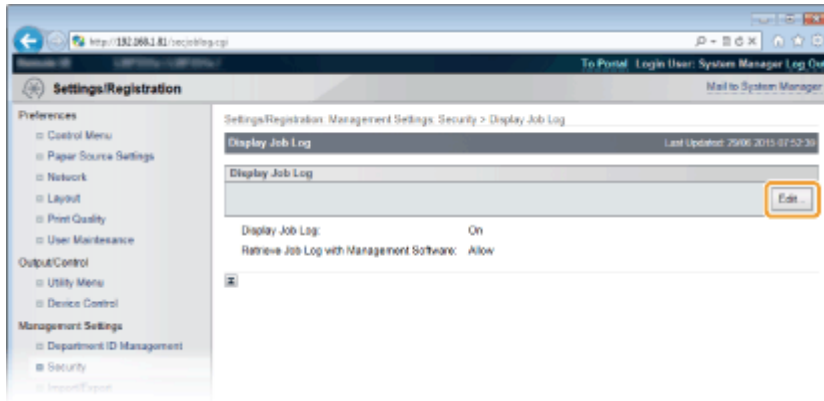

5 Clear the [Display Job Log] check box and click [OK].

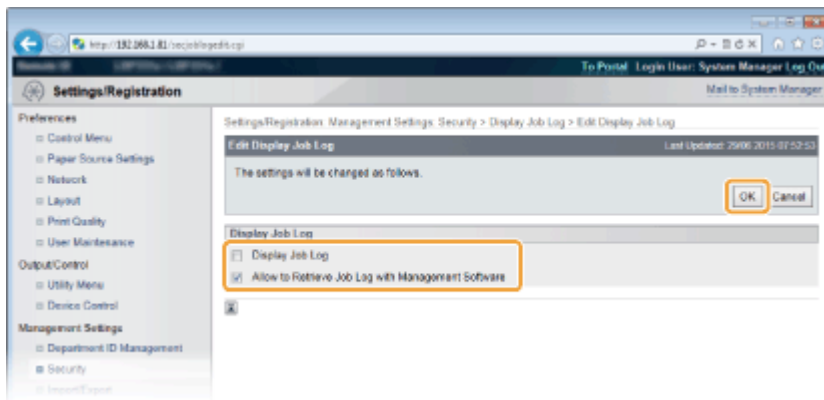

[Display Job Log]

If you clear the check box, the print job history will not be displayed on the Remote UI screen and the print history list cannot be printed, either. To display the job history, select the check box.

[Allow to Retrieve Job Log with Management Software]

If you select the check box, device management software such as iW Management Console can be used to obtain a print job history. Clear the check box to disable the management software to obtain the print job history. This function is automatically enabled when the [Display Job Log] check box is selected.

LINKS

- ▶ [Checking History of Documents\(P. 294\)](#)
- ▶ [Job Menu\(P. 406\)](#)

Implementing Robust Security Features

51W4-04F

Authorized users may incur unanticipated losses from attacks by malicious third parties, such as sniffing, spoofing, and tampering of data as it flows over a network. To protect your important and valuable information from these attacks, the machine supports the following features to enhance security and secrecy.

TLS Encrypted Communication

TLS is a protocol for encryption for data sent over a network and is often used for communication via a Web browser or an e-mail application. TLS enables secure network communication when you access the machine from a computer via the Remote UI. [Using TLS for Encrypted Communications\(P. 246\)](#)



IPSec Communication

While TLS only encrypts data used on a specific application, such as a Web browser or an e-mail application, IPSec encrypts the whole (or payloads of) IP packets. This enables IPSec to offer a more versatile security system than TLS. [Configuring IPSec Settings\(P. 251\)](#)



IEEE 802.1X Authentication

IEEE 802.1X is a standard and mechanism for blocking unauthorized access to the network by collectively managing user authentication information. If a device tries to connect to the 802.1X network, the device must go through user authentication in order to prove that the connection is made by an authorized user. Authentication information is sent to and checked by a RADIUS server, which permits or rejects communication to the network depending on the authentication result. If authentication fails, a LAN switch blocks access from the outside of the network. The machine can connect to an 802.1X network as a client device. [Configuring IEEE 802.1X Authentication\(P. 261\)](#)

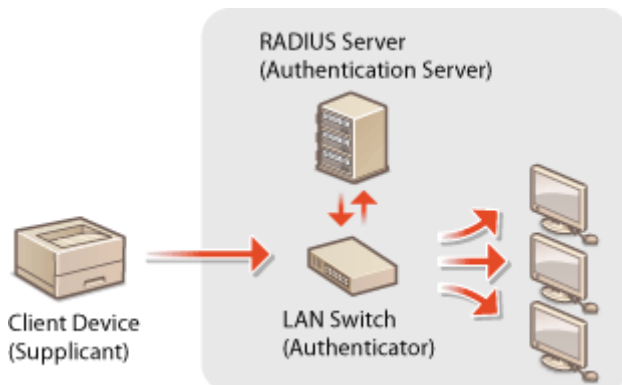

LINKS

[Configuring Settings for Key Pairs and Digital Certificates\(P. 267\)](#)

Using TLS for Encrypted Communications

51W4-04H

You can encrypt communication between the machine and a Web browser on the computer and the IPP Print data to print via Internet by using Transport Layer Security (TLS). TLS is a mechanism for encrypting data sent or received over the network. TLS must be enabled when the Remote UI is used for specifying settings for IPSec (Pre-Shared Key Method), IEEE 802.1X authentication (TTLS/PEAP), or SNMPv3. To use TLS encrypted communication, you need to set a key pair and enable the TLS function. Have a key pair to use ready ([▶Configuring Settings for Key Pairs and Digital Certificates\(P. 267\)](#)).



- 1 Start the Remote UI and log on in Management Mode. [▶Starting Remote UI\(P. 284\)](#)
- 2 Click [Settings/Registration].

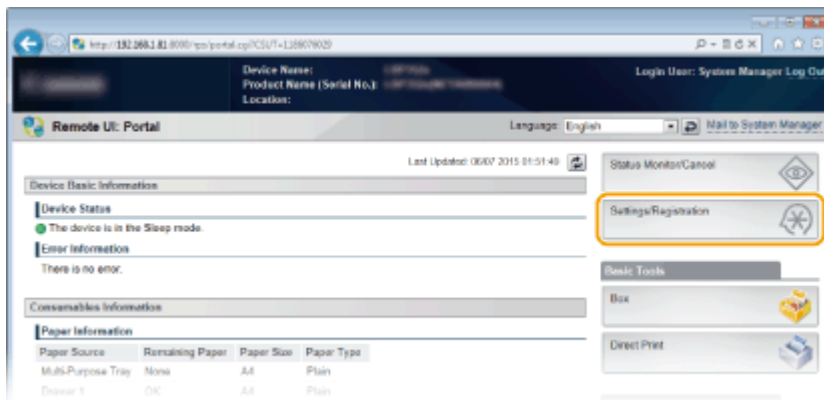

- 3 Click [Network] ▶ [TCP/IP Settings].

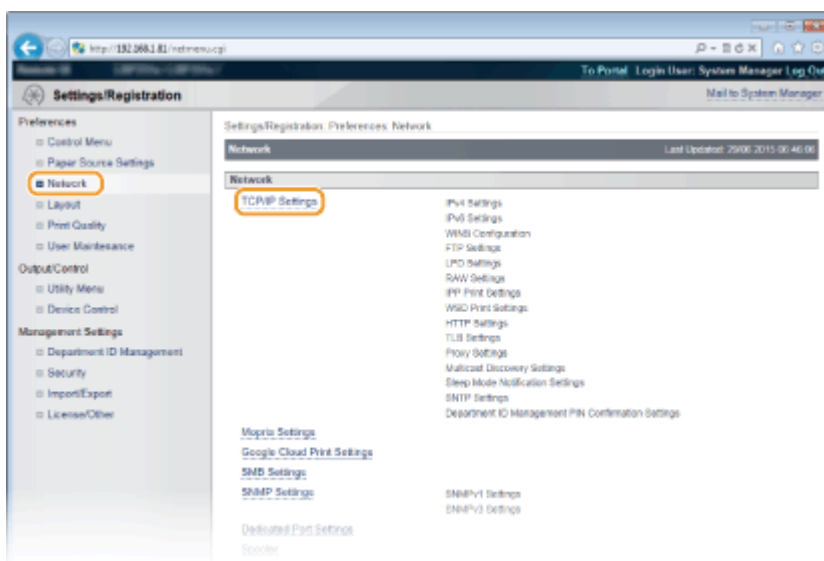

4 Click [Edit] in [TLS Settings].

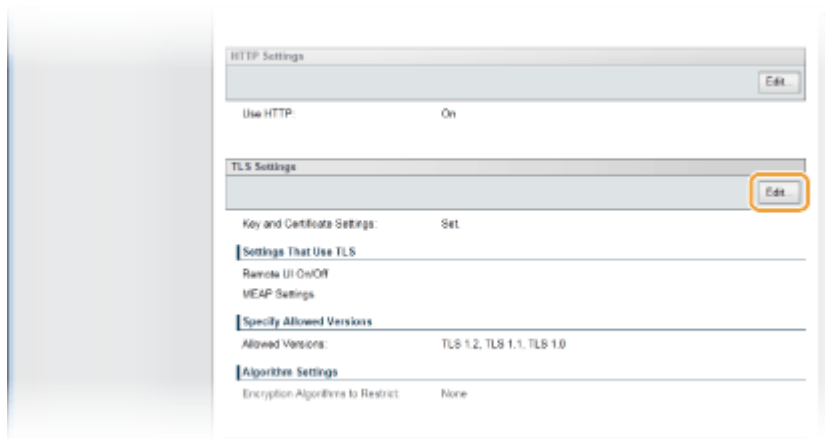

5 Edit TLS Settings.

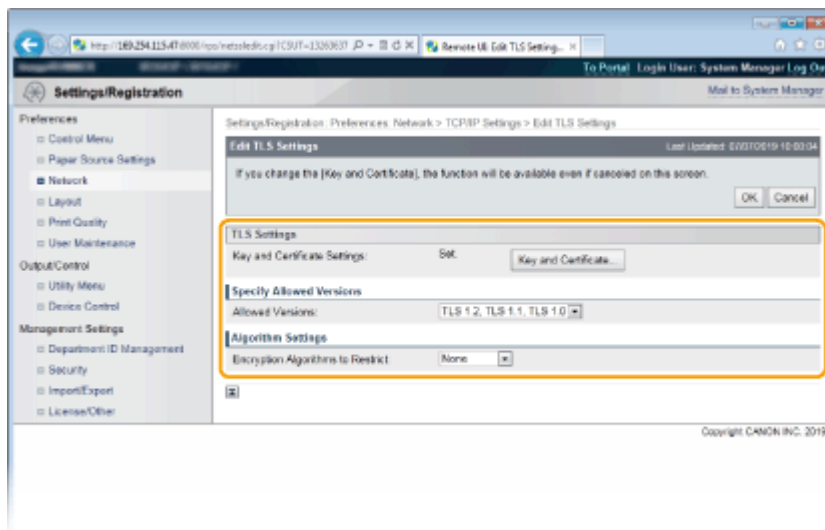

[Key and Certificate Settings]

Select a key from the list of keys and certificates.

- Select a key from the list of keys and certificates, and click [Default Key Settings].

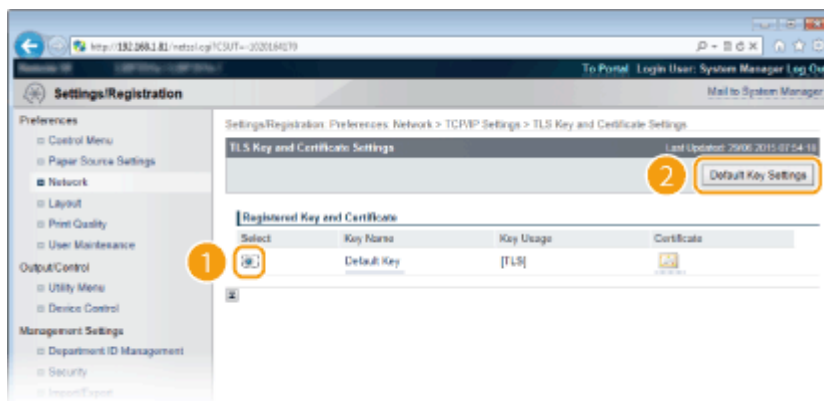

NOTE:

Viewing details of a certificate

- You can check the details of the certificate or verify the certificate by clicking the corresponding text link under [Key Name], or the certificate icon. **Verifying Key Pairs and Digital Certificates(P. 280)**

If [Default Key Settings] is not displayed

- When TLS is already enabled by [Remote UI Settings] or [IPP Print Settings], [Default Key Settings] is not displayed. To change the key to use, refer to step 6 and clear the [Use TLS] check boxes under [Remote UI Settings] or [IPP Print Settings], respectively.

[Allowed Versions]

Select the allowed versions for TLS.

[Encryption Algorithms to Restrict]

Select the encryption algorithms to be restricted against use for TLS. If you make no restriction, select [None].

6 Enable TLS for the Remote UI.**■ Using TLS for communication with the Remote UI**

- 1 Click [Security] ► [Remote UI Settings].

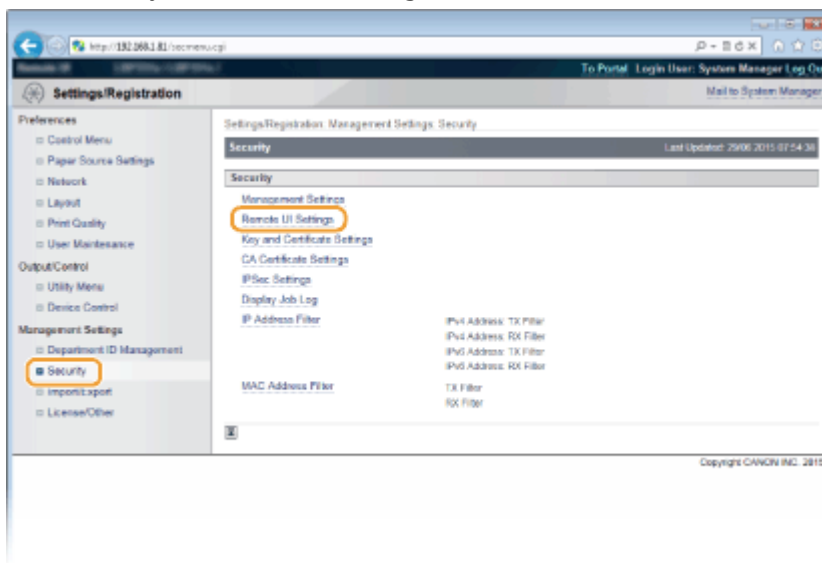

- 2 Click [Edit].

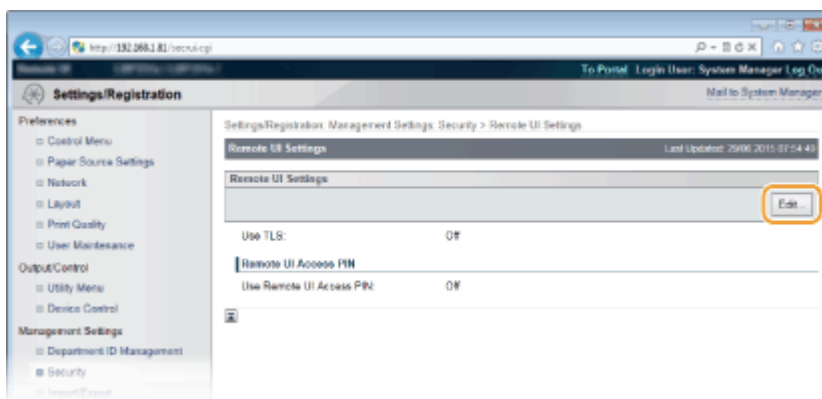

- 3 Select the [Use TLS] check box and click [OK].

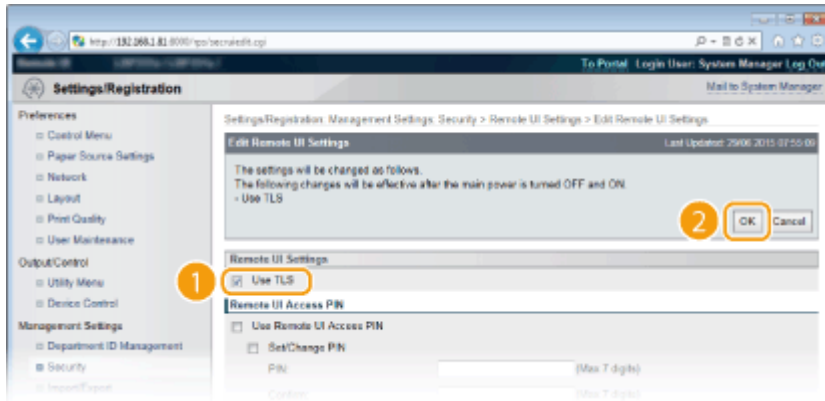

[Use TLS]

When using TLS for Remote UI communication, select the check box. When not using, clear the check box.

■ Using TLS for a function that is compatible with encrypted communication

Using TLS for IPP printing

Make the following setting to perform IPP printing using TLS. For other IPP print settings, see [▶Configuring Printing Protocols and WSD Functions\(P. 149\)](#) .



[Network] ▶ [TCP/IP Settings] ▶ [Edit] in [IPP Print Settings] ▶ Select the [Use TLS] check box ▶ [OK]

7 Perform a hard reset.

- Click [Device Control], select [Hard Reset], and then click [Execute].

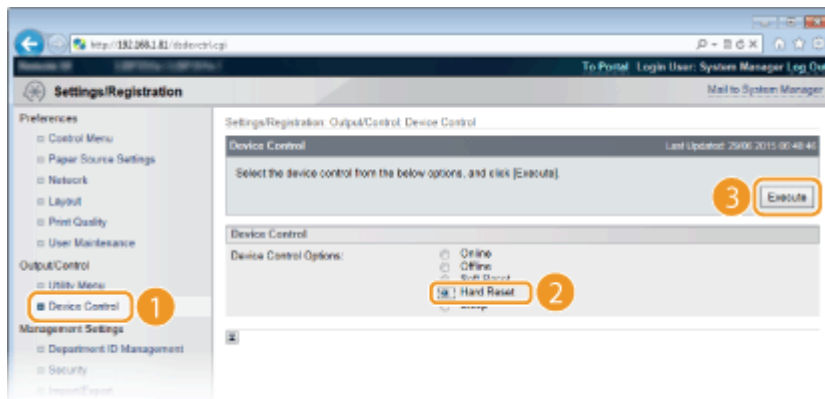

⇒ The settings are enabled after the hard reset is performed.

NOTE

Using the operation panel

- You can also enable or disable TLS encrypted communication from the setting menu of the operation panel.
 - ▶[Remote UI Settings\(P. 341\)](#)

Starting the Remote UI with TLS

- If you try to start the Remote UI when TLS is enabled, a security alert may be displayed regarding the security certificate. In this case, check that the correct URL is entered in the address field, and then proceed to display the Remote UI screen. [▶Starting Remote UI\(P. 284\)](#)

LINKS

- ▶[Generating Key Pairs\(P. 268\)](#)
- ▶[Using CA-issued Key Pairs and Digital Certificates\(P. 277\)](#)
- ▶[Configuring IPsec Settings\(P. 251\)](#)
- ▶[Configuring IEEE 802.1X Authentication\(P. 261\)](#)
- ▶[Monitoring and Controlling the Machine with SNMP\(P. 184\)](#)

Configuring IPsec Settings

51W4-04J

Internet Protocol Security (IPsec or IPsec) is a protocol suite for encrypting data transported over a network, including Internet networks. While TLS only encrypts data used on a specific application, such as a Web browser or an e-mail application, IPsec encrypts either whole IP packets or the payloads of IP packets, offering a more versatile security system. The IPsec of the machine works in transport mode, in which the payloads of IP packets are encrypted. With this feature, the machine can connect directly to a computer that is in the same virtual private network (VPN). Check the system requirements and set the necessary configuration on the computer before you configure the machine. [▶ Management Functions\(P. 479\)](#)

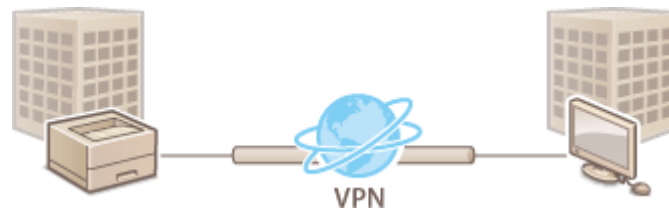

[▶ Registering Security Policies\(P. 251\)](#)

[▶ Enabling IPsec Communication\(P. 258\)](#)

NOTE

Using IPsec with IP address filter

- The IPsec settings are applied before the IP address filter settings during packet reception while the IP address settings are applied before the IPsec settings during packet transmission. [▶ Specifying IP Addresses for Firewall Rules\(P. 217\)](#)

Registering Security Policies

To use IPsec for encrypted communication, you need to register security policies (SP) before enabling the IPsec settings ([▶ Enabling IPsec Communication\(P. 258\)](#)). A security policy consists of the groups of settings described below. You can register multiple policies according to a combination of the IP address and the port number. After registering policies, specify the order in which they are applied.

Selector

Selector defines conditions for IP packets to apply IPsec communication. Selectable conditions include IP addresses and port numbers of the machine and the devices to communicate with.

IKE

IKE configures the IKEv1 that is used for key exchange protocol. Note that instructions vary depending on the authentication method selected.

[Pre-Shared Key Method]

A key of alphanumeric characters can be shared with the other devices. Enable TLS for the Remote UI in advance ([▶ Using TLS for Encrypted Communications\(P. 246\)](#)).

[Digital Signature Method]

The machine and the other devices authenticate each other by mutually verifying their digital signatures. Have a key pair to use ready ([▶ Using CA-issued Key Pairs and Digital Certificates\(P. 277\)](#)).

Setting Protocols and Options

Specify the settings for ESP and AH, which are added to packets during IPsec communication. ESP and AH cannot be used at the same time. You can also select whether or not to enable PFS for tighter security.

1 Start the Remote UI and log on in Management Mode. ▶ Starting Remote UI(P. 284)

2 Click [Settings/Registration].

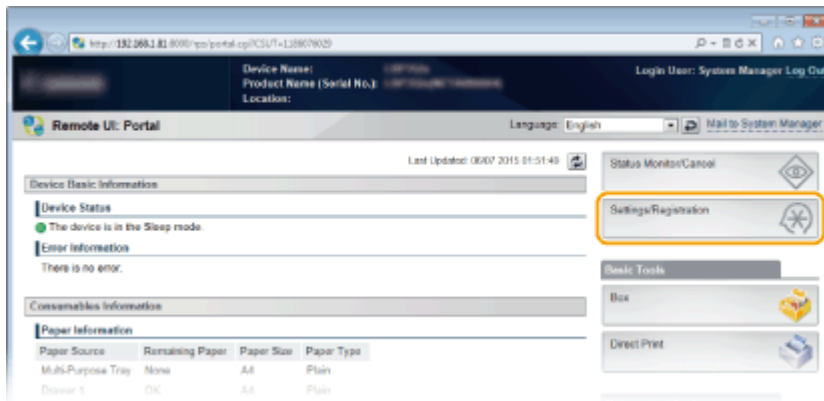

3 Click [Security] ▶ [IPSec Settings].

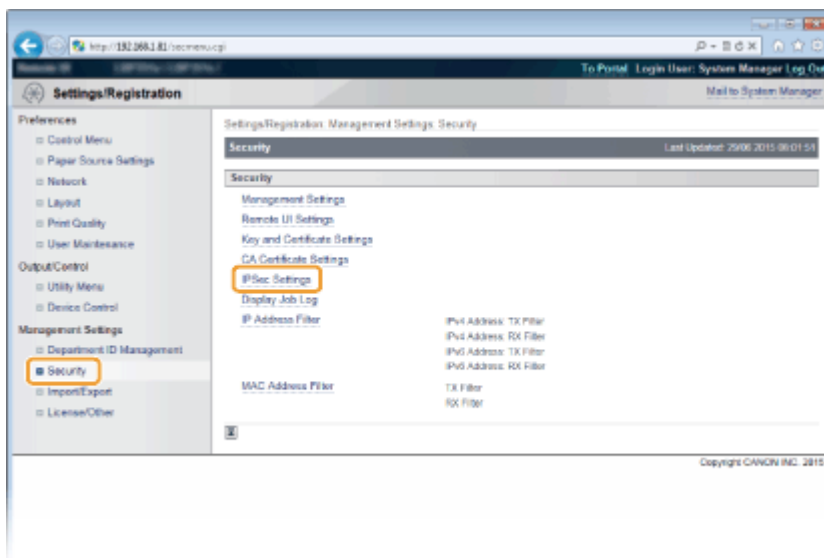

4 Click [IPSec Policy List].

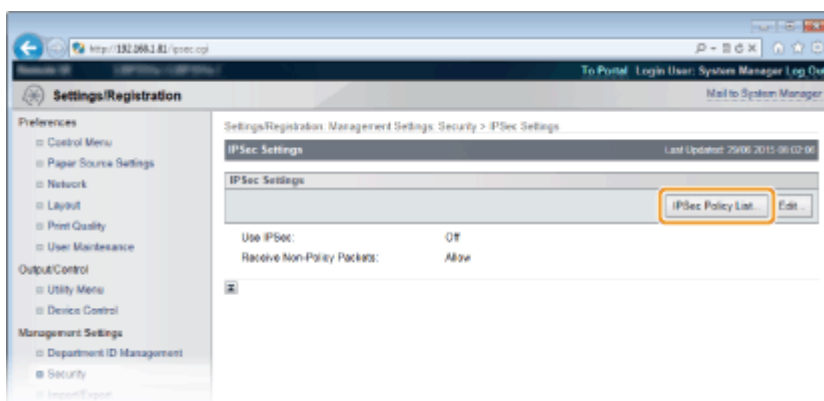

5 Click [Register IPSec Policy].

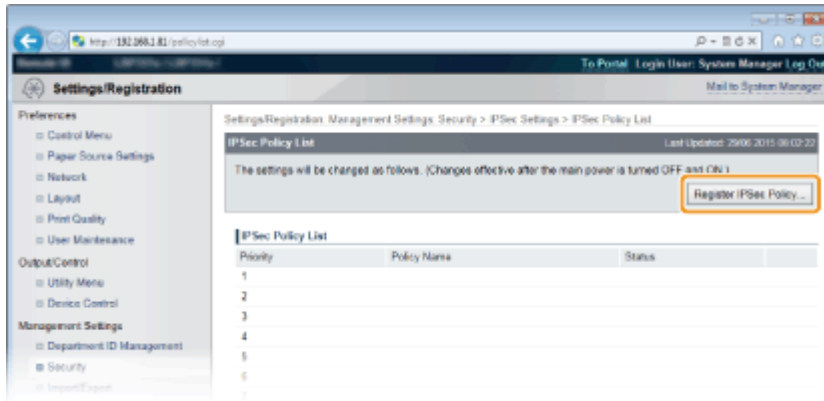

6 Enter a policy name in [Policy Name], and select the [Enable Policy] check box.

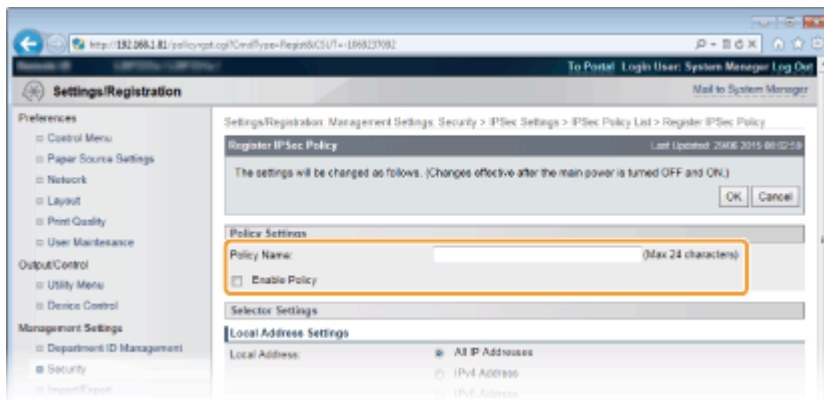

[Policy Name]

Enter alphanumeric characters for a name that is used for identifying the policy.

[Enable Policy]

Select the check box to enable the policy. When not using the policy, clear the check box.

7 Specify the selector settings.

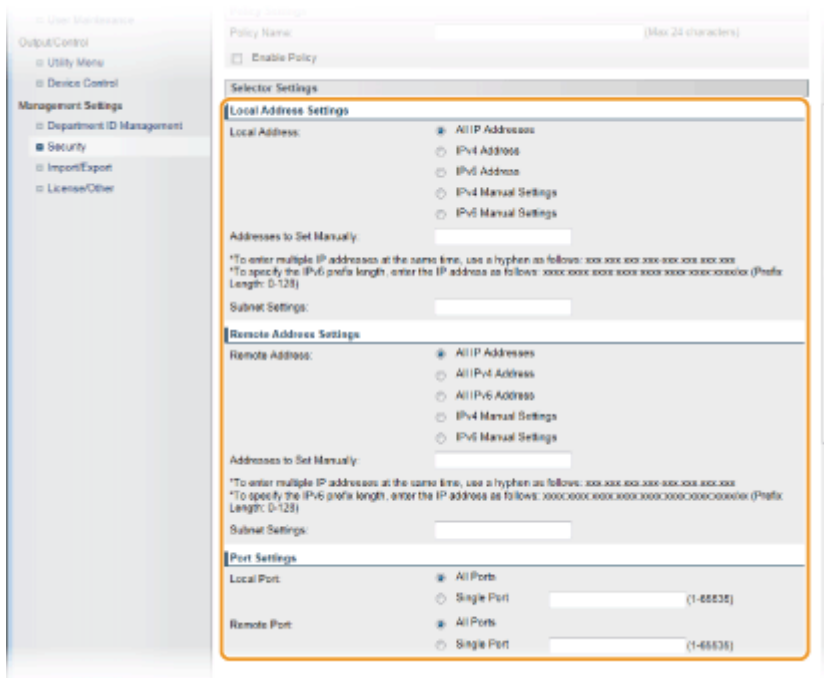

[Local Address]

Select the type of the IP address of the machine to apply the policy from the following list.

[All IP Addresses]	Select to use IPSec for all IP packets.
[IPv4 Address]	Select to use IPSec for all IP packets that are sent to or from the IPv4 address of the machine.
[IPv6 Address]	Select to use IPSec for all IP packets that are sent to or from an IPv6 address of the machine.
[IPv4 Manual Settings]	Select to specify a single IPv4 address or a range of IPv4 addresses to apply IPSec. Enter the IPv4 address (or the range) in the [Addresses to Set Manually] text box.
[IPv6 Manual Settings]	Select to specify a single IPv6 address or a range of IPv6 addresses to apply IPSec. Enter the IPv6 address (or the range) in the [Addresses to Set Manually] text box.

[Addresses to Set Manually]

If [IPv4 Manual Settings] or [IPv6 Manual Settings] is selected for [Local Address], enter the IP address to apply the policy.

[Subnet Settings]

When manually specifying IPv4 addresses, you can express the range by using the subnet mask. Enter the subnet mask using periods to delimit numbers (example:"255.255.255.240").

[Remote Address]

Select the type of IP address of the other devices to apply the policy from the list shown below.

[All IP Addresses]	Select to use IPSec for all IP packets.
[All IPv4 Address]	Select to use IPSec for all IP packets that are sent to or from an IPv4 address.
[All IPv6 Address]	Select to use IPSec for all IP packets that are sent to or from an IPv6 address.
[IPv4 Manual Settings]	Select to specify a single IPv4 address or a range of IPv4 addresses to apply IPSec. Enter the IPv4 address (or the range) in the [Addresses to Set Manually] text box.
[IPv6 Manual Settings]	Select to specify a single IPv6 address or a range of IPv6 addresses to apply IPSec. Enter the IPv6 address (or the range) in the [Addresses to Set Manually] text box.

[Addresses to Set Manually]

If [IPv4 Manual Settings] or [IPv6 Manual Settings] is selected for [Remote Address], enter the IP address to apply the policy.

[Subnet Settings]

When manually specifying IPv4 addresses, you can express the range by using the subnet mask. Enter the subnet mask using periods to delimit numbers (example:"255.255.255.240").

[Local Port]/[Remote Port]

If you want to create separate policies for each protocol, such as HTTP or SMTP, enter the appropriate port number for the protocol to determine whether to use IPSec.

IMPORTANT:

- IPSec is not applied to the packets that have a specified multicast or broadcast address.

8 Specify the IKE Settings.

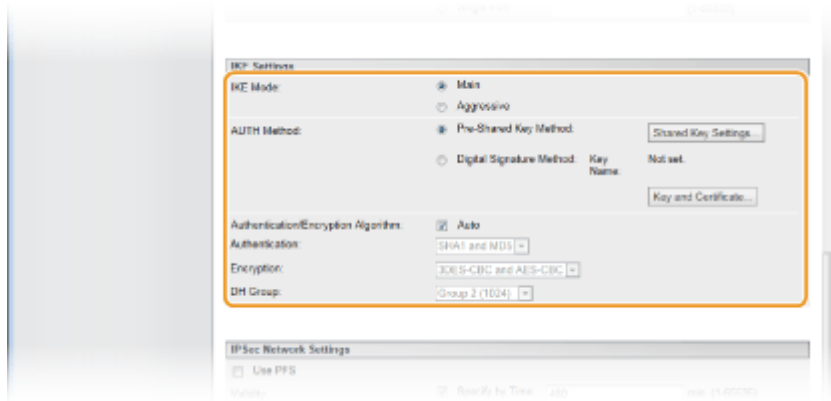

[IKE Mode]

The mode used for the key exchange protocol is displayed. Normally select the main mode.

NOTE:

- Select the aggressive mode when the IP address is not fixed. Note that security is lower in the aggressive mode than in the main mode.

[AUTH Method]

Select [Pre-Shared Key Method] or [Digital Signature Method] for the method used when authenticating the machine.

IMPORTANT:

- When the aggressive mode is selected in [IKE Mode], the [Pre-Shared Key Method] setting does not encrypt the shared key.

[Authentication/Encryption Algorithm]

To automatically set the algorithm that is used for key exchange, select the [Auto] check box. If you select the check box, the algorithm is set as shown below.

[Authentication]	[SHA1 and MD5]
[Encryption]	[3DES-CBC and AES-CBC]
[DH Group]	[Group 2 (1024)]

To manually set the algorithm, clear the check box and select the algorithm.

[Authentication]	Select the hash algorithm.
[Encryption]	Select the encryption algorithm.
[DH Group]	Select the Diffie-Hellman group, which determines the key strength.

■ Using [Pre-Shared Key Method] for authentication

- 1** Select [Pre-Shared Key Method] for [AUTH Method] and click [Shared Key Settings].
- 2** Enter alphanumeric characters for the pre-shared key and click [OK].

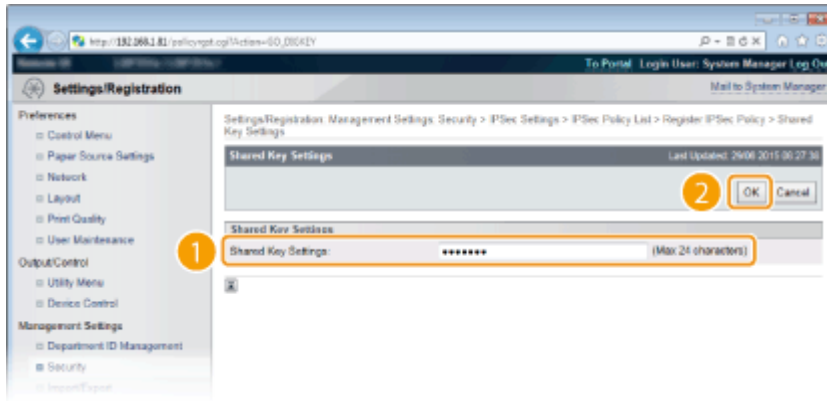

■ Using [Digital Signature Method] for authentication

- 1 Select [Digital Signature Method] for [AUTH Method] and click [Key and Certificate].
- 2 Select the key pair you want to use, and click [Default Key Settings].

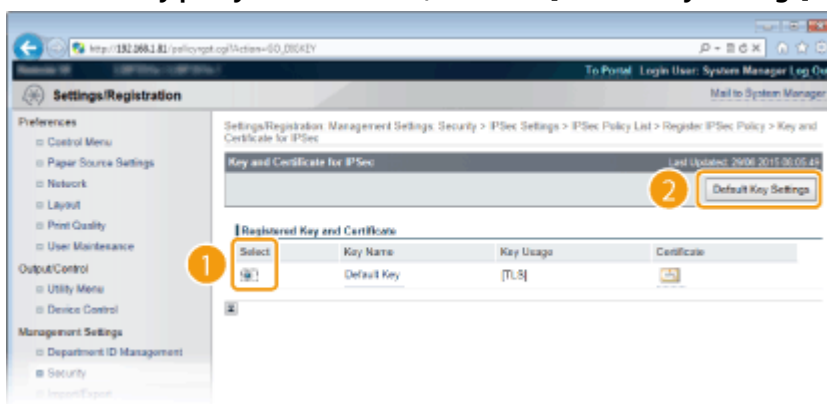

NOTE:

Viewing details of a key pair or certificate

- You can check the details of the certificate or verify the certificate by clicking the corresponding text link under [Key Name], or the certificate icon. **▶ Verifying Key Pairs and Digital Certificates(P. 280)**

9 Specify the IPsec Network Settings.

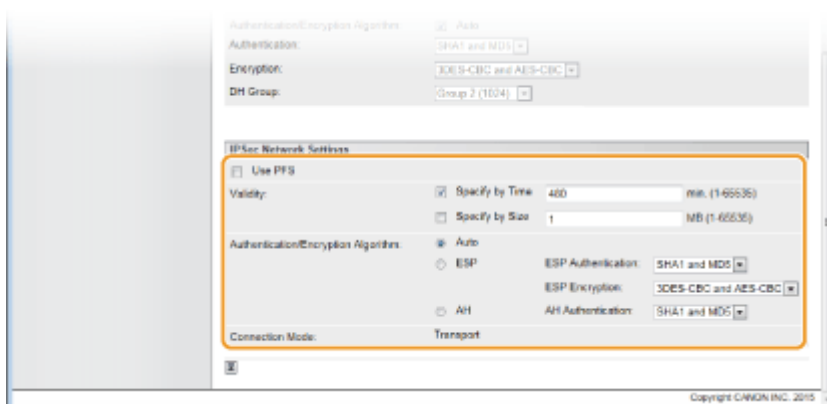

[Use PFS]

Select the check box to enable Perfect Forward Secrecy (PFS) for IPsec session keys. Enabling PFS enhances the security while increasing the load on the communication. Make sure that PFS is also enabled for the other devices. When not using PFS, clear the check box.

[Validity]

Specify how long SA is used as a communication tunnel. Select the [Specify by Time] or [Specify by Size] check box or both check boxes as necessary. If both check boxes are selected, the IPsec SA session is terminated when either of the conditions has been satisfied.

[Specify by Time]	Enter a time in minutes to specify how long a session lasts. The entered time is applied to both IPsec SA and IKE SA.
[Specify by Size]	Enter a size in megabytes to specify how much data can be transported in a session. The entered size is applied to IPsec SA only.

NOTE:

If you have selected the [Specify by Size] check box only

- The IKE SA validity cannot be specified by size, so that the initial value (480 minutes) of [Specify by Time] is applied.

[Authentication/Encryption Algorithm]

Select the protocol and algorithm to use for IPsec communication.

■ Automatically setting up connection

Select [Auto].

[ESP Authentication]	ESP is enabled and the authentication algorithm is set to [SHA1 and MD5].
[ESP Encryption]	ESP is enabled and the encryption algorithm is set to [3DES-CBC and AES-CBC].

■ Using ESP

Choose [ESP] and select the authentication algorithm and encryption algorithm.

[ESP Authentication]	Select the hash algorithm to use for ESP authentication.
[ESP Encryption]	Select the encryption algorithm for ESP.

■ Using AH

Choose [AH], and select the hash algorithm to use for AH authentication from [AH Authentication].

[Connection Mode]

The connection mode of IPsec is displayed. The machine supports transport mode, in which the payloads of IP packets are encrypted. Tunnel mode, in which whole IP packets (headers and payloads) are encapsulated is not available.

10 Click [OK].

- If you need to register an additional security policy, return to step 5.

11 Arrange the order of policies listed under [IPsec Policy List].

- Policies are applied from one at the highest position to the lowest. Click [Raise Priority] or [Lower Priority] to move a policy up or down the order.

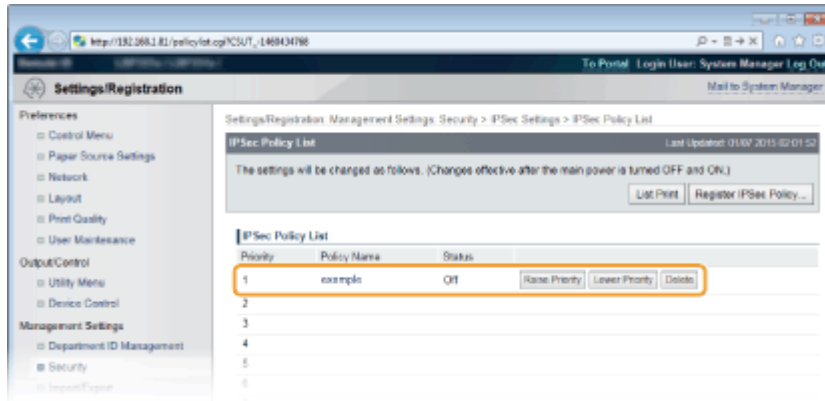
**NOTE:****Editing a policy**

- You can click the text link under [Policy Name] to edit the settings.

Deleting a policy

- Click [Delete] on the right of the policy that you want to delete.

12 Perform a hard reset.

- Click [Device Control], select [Hard Reset], and then click [Execute].

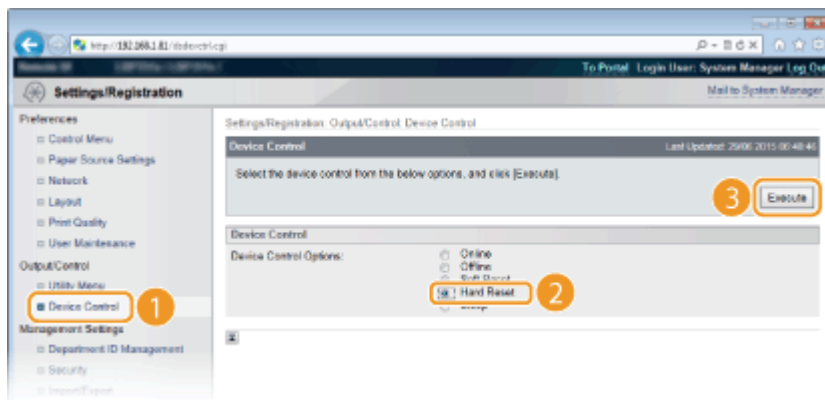

⇒ The settings are enabled after a hard reset is performed.

Enabling IPsec Communication

After completion of registering security policies, enable the IPsec communication.

1 Start the Remote UI and log on in Management Mode. ▶ Starting Remote UI(P. 284)

2 Click [Settings/Registration].

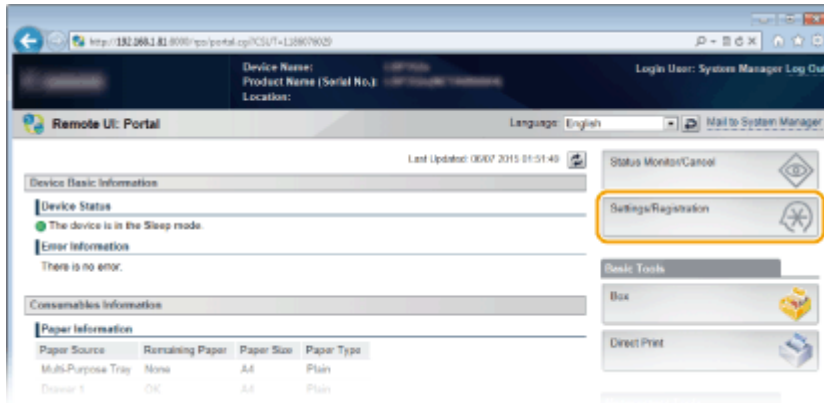

3 Click [Security] ► [IPSec Settings].

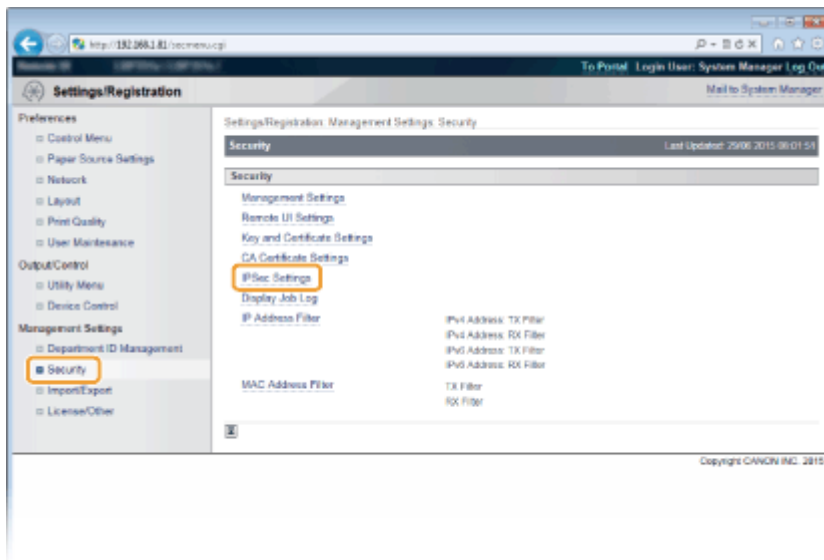

4 Click [Edit].

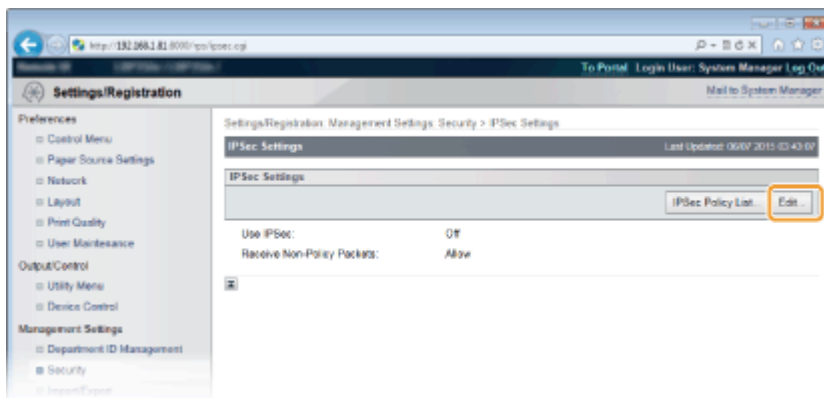

5 Select the [Use IPSec] check box and click [OK].

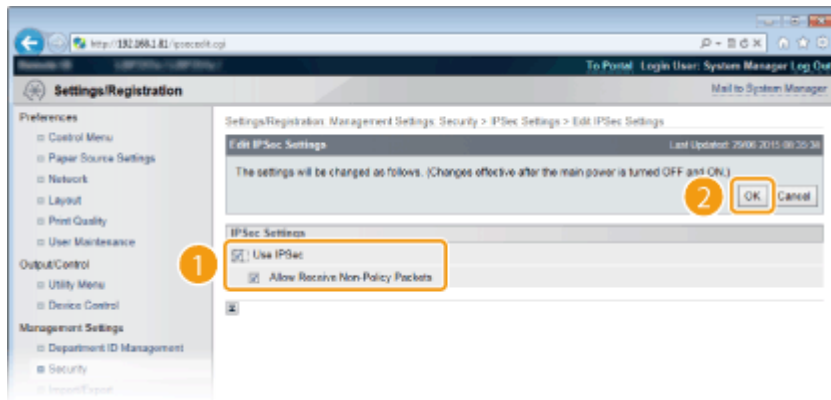

[Use IPsec]

When using IPsec in the machine, select the check box. When not using, clear the check box.

[Allow Receive Non-Policy Packets]

If you select the check box when using IPsec, packets that are not available for the registered policies are also sent/received. To disable sending/receiving the packets that are not available for the policies, clear the check box.

6 Perform a hard reset.

- Click [Device Control], select [Hard Reset], and then click [Execute].

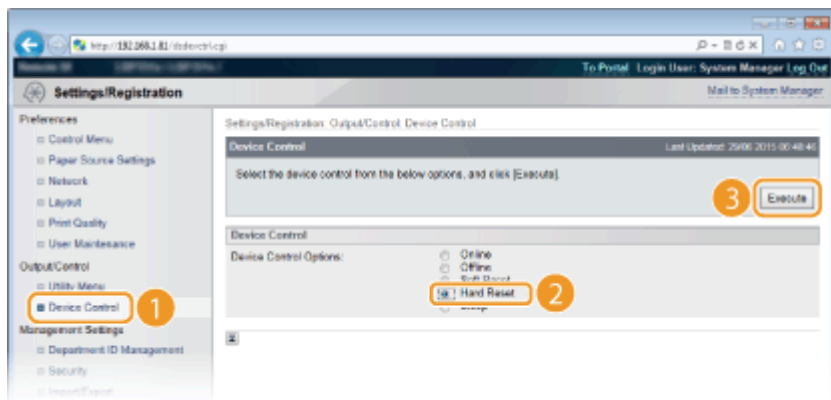

⇒ The settings are enabled after the hard reset is performed.

NOTE

Using the operation panel

- You can also enable or disable IPsec communication from the setting menu of the operation panel. ▶
IPsec(P. 336)

LINKS

- ▶ **Configuring Settings for Key Pairs and Digital Certificates(P. 267)**
- ▶ **IPsec Policy List(P. 403)**

Configuring IEEE 802.1X Authentication

51W4-04K

The machine can connect to an 802.1X network as a client device. A typical 802.1X network consists of a RADIUS server (authentication server), LAN switch (authenticator), and client devices with authentication software (supplicants). If a device tries to connect to the 802.1X network, the device must go through user authentication in order to prove that the connection is made by an authorized user. Authentication information is sent to and checked by a RADIUS server, which permits or rejects communication to the network depending on the authentication result. If authentication fails, a LAN switch (or an access point) blocks access from the outside of the network.

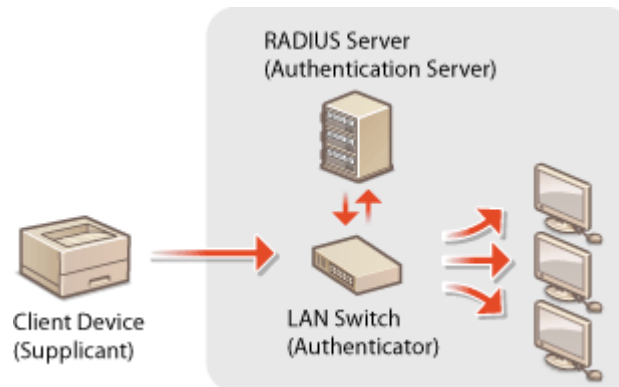

Select the authentication method from the options below. If necessary, install or register a key pair or CA certificate before configuring IEEE 802.1X authentication ([Using CA-issued Key Pairs and Digital Certificates\(P. 277\)](#)).

TLS

The machine and the authentication server authenticate each other by mutually verifying their certificates. A key pair issued by a certification authority (CA) is required for the client authentication (when authenticating the machine). For the server authentication, a CA certificate installed via the Remote UI can be used in addition to a CA certificate preinstalled in the machine.

TTLS

This authentication method uses a user name and password for the client authentication and a CA certificate for the server authentication. MSCHAPv2 or PAP can be selected as the internal protocol. TTLS can be used with PEAP at the same time. Enable TLS for the Remote UI before configuring this authentication method ([Using TLS for Encrypted Communications\(P. 246\)](#)).

PEAP

The required settings are almost the same as those of TTLS. MS-CHAPv2 is used as the internal protocol. Enable TLS for the Remote UI before configuring this authentication method ([Using TLS for Encrypted Communications\(P. 246\)](#)).

- 1 Start the Remote UI and log on in Management Mode. [Starting Remote UI\(P. 284\)](#)
- 2 Click [Settings/Registration].

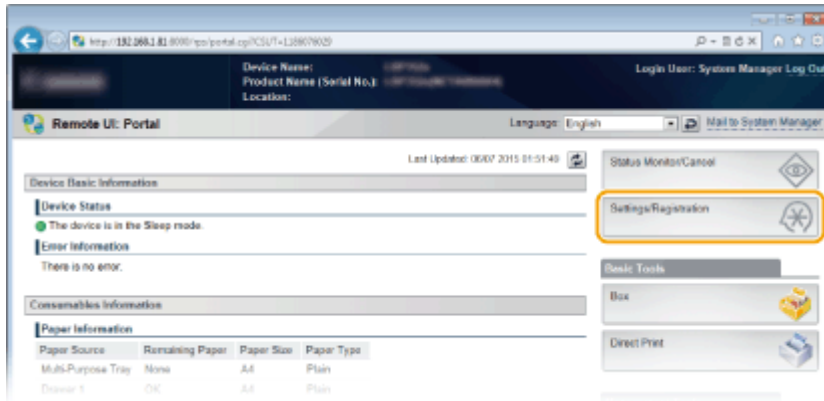

3 Click [Network] ► [IEEE 802.1X Settings].

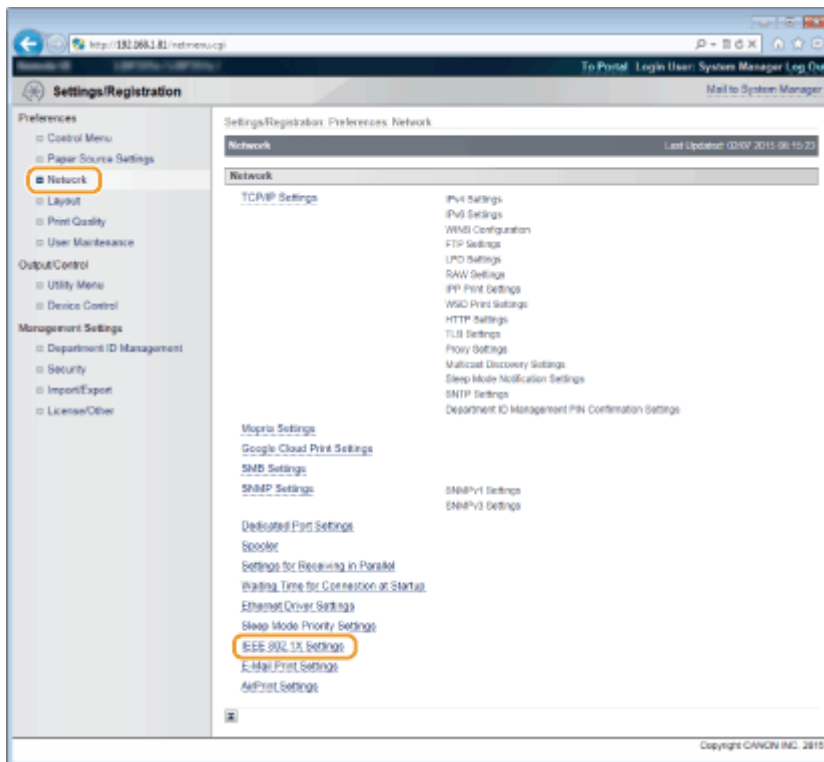

4 Click [Edit].

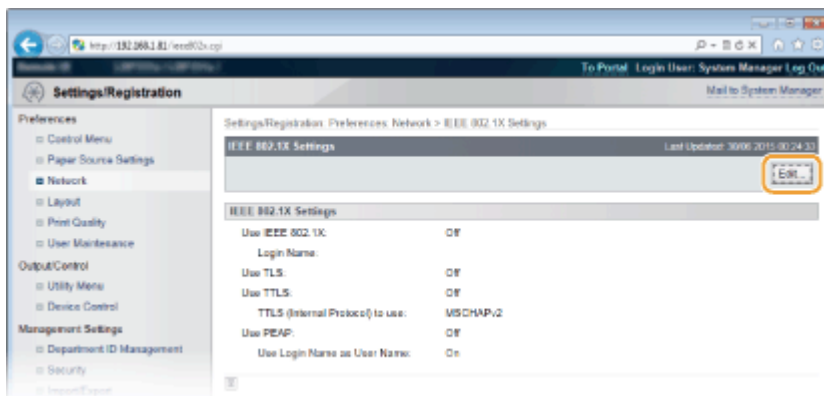

5 Select the [Use IEEE 802.1X] check box, enter the login name in the [Login Name] text box, and specify the required settings.

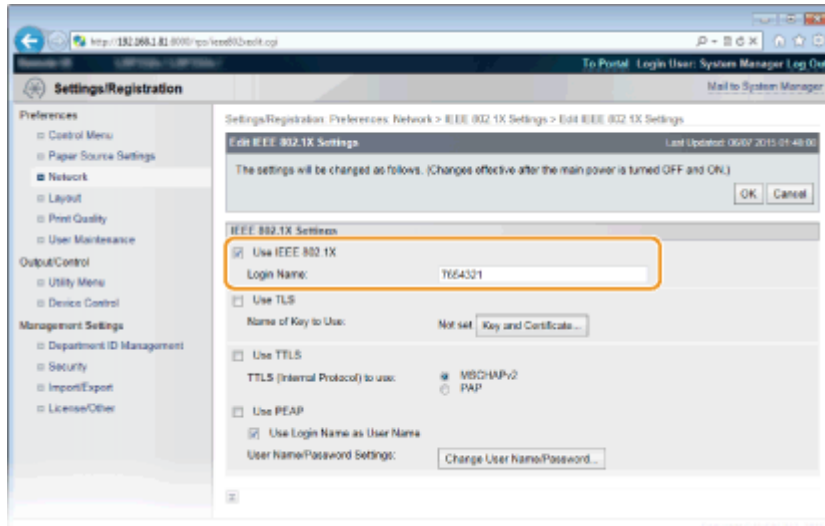

[Use IEEE 802.1X]

Select the check box to enable IEEE 802.1X authentication.

[Login Name]

Enter alphanumeric characters for a name (EAP identity) that is used for identifying the user.

■ Setting TLS

- 1 Select the [Use TLS] check box and click [Key and Certificate].
 - You cannot use TLS with TTLS or PEAP.
- 2 Select a key from the list of keys and certificates, and click [Default Key Settings].

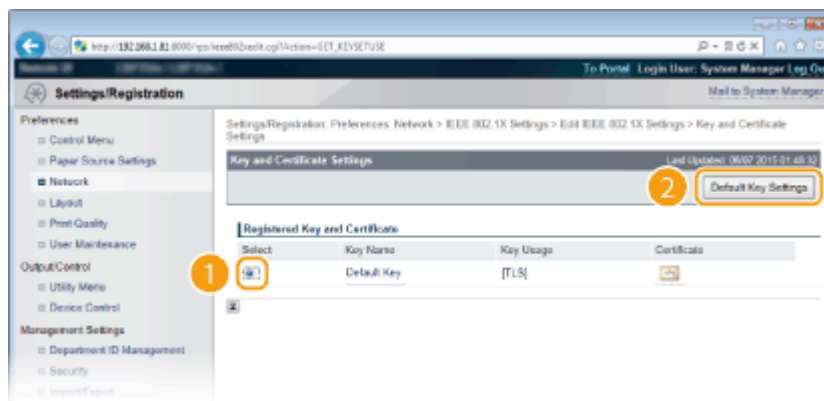

NOTE:

Viewing details of a key pair or certificate

- You can check the details of the certificate or verify the certificate by clicking the corresponding text link under [Key Name], or the certificate icon. [Verifying Key Pairs and Digital Certificates\(P. 280\)](#)

■ Setting TTLS/PEAP

- 1 Select the [Use TTLS] or [Use PEAP] check box.

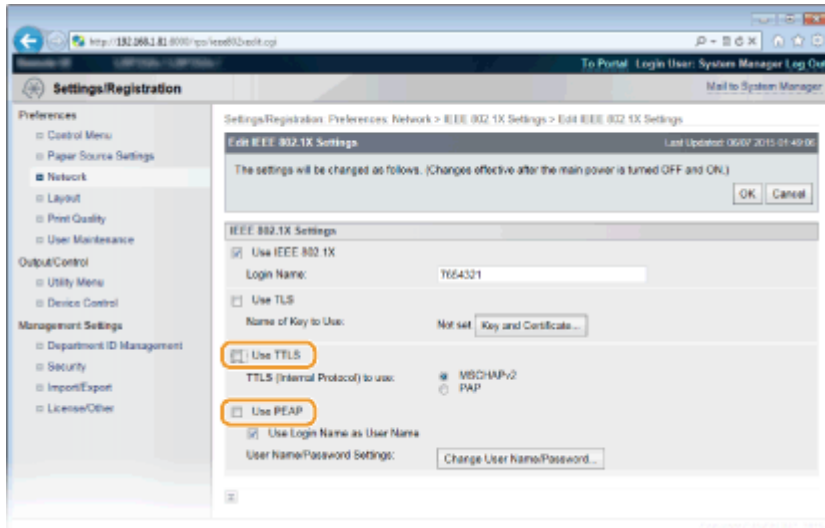
**NOTE:****Internal protocol for TTLS**

- You can select MSCHAPv2 or PAP. If you want to use PAP, click the [PAP] radio button.

**2** Click [Change User Name/Password].

- To specify a user name other than the login name, clear the [Use Login Name as User Name] check box. Select the check box if you want to use the login name as the user name.

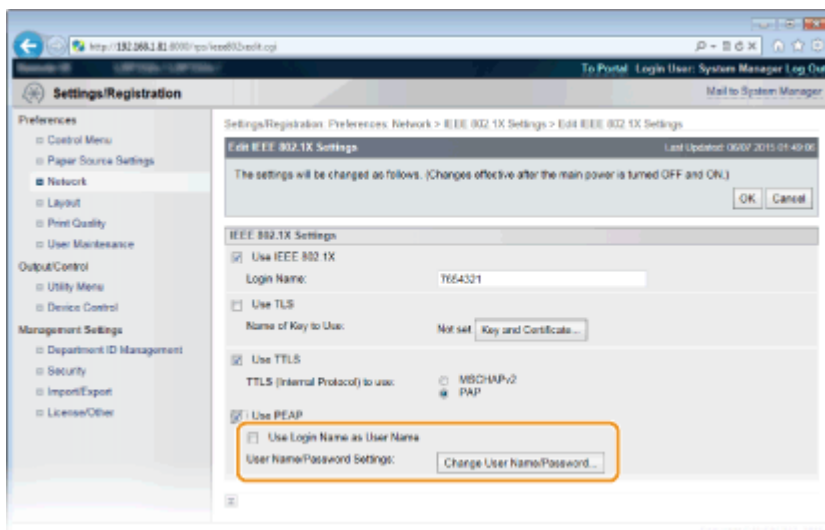
**3** Set the user name/password and click [OK].

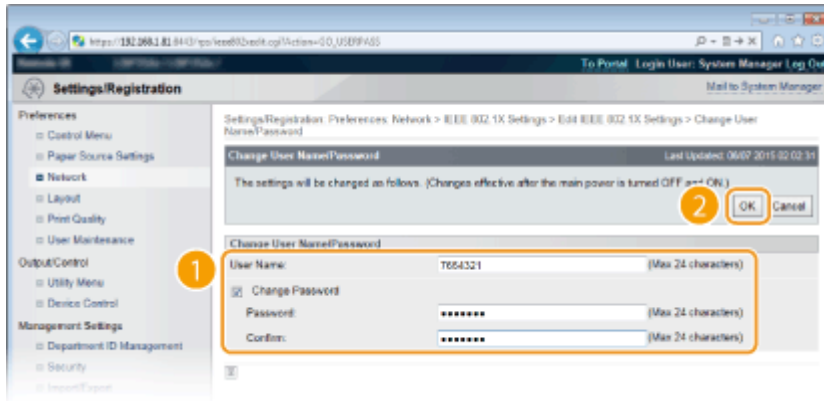

[User Name]

Enter alphanumeric characters for the user name.

[Change Password]

To set or change the password, select the check box and enter alphanumeric characters for the new password both in the [Password] and [Confirm] text boxes.

6 Click [OK].

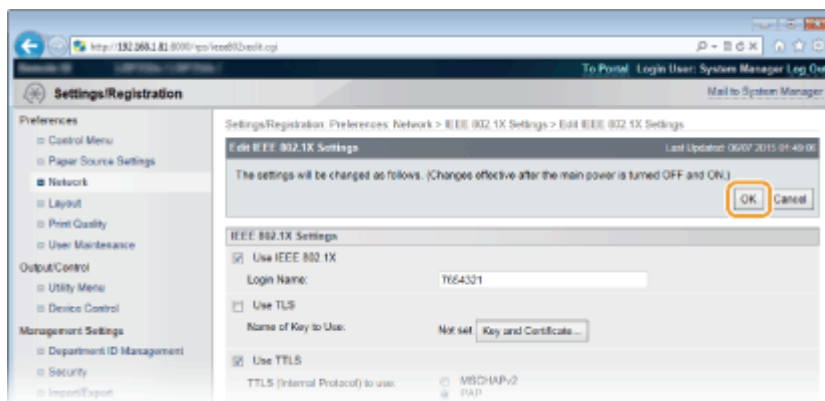

7 Perform a hard reset.

- Click [Device Control], select [Hard Reset], and then click [Execute].

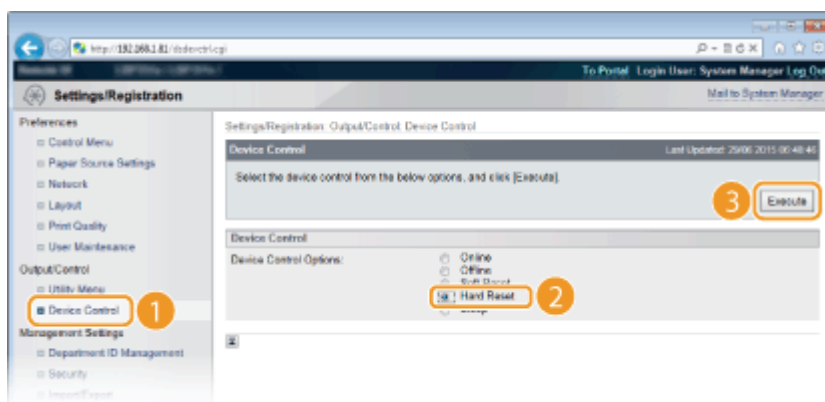

⇒ The settings are enabled after the hard reset is performed.

NOTE

Using the operation panel

- You can also enable or disable IEEE 802.1X authentication from the setting menu of the operation panel. 
IEEE802.1X(P. 343)

LINKS

- ** Configuring Settings for Key Pairs and Digital Certificates(P. 267)**

Configuring Settings for Key Pairs and Digital Certificates

51W4-04L

In order to encrypt communication with a remote device, an encryption key must be sent and received over an unsecured network beforehand. This problem is solved by public-key cryptography. Public-key cryptography ensures secure communication by protecting important and valuable information from attacks, such as sniffing, spoofing, and tampering of data as it flows over a network.

Key Pair



A key pair consists of a public key and a secret key, both of which are required for encrypting or decrypting data. Because data that has been encrypted with one of the key pair cannot be returned to its original data form without the other, public-key cryptography ensures secure communication of data over the network. Up to eight key pairs, including the preinstalled pairs, can be registered ([▶Using CA-issued Key Pairs and Digital Certificates\(P. 277\)](#)). For TLS encrypted communication, a key pair can be generated for the machine ([▶Generating Key Pairs\(P. 268\)](#)).

CA Certificate



Digital certificates including CA certificates are similar to other forms of identification, such as driver's licenses. A digital certificate contains a digital signature, which enables the machine to detect any spoofing or tampering of data. It is extremely difficult for third parties to abuse digital certificates. A digital certificate that contains a public key of a certification authority (CA) is referred to as a CA certificate. CA certificates are used for verifying the device the machine is communicating with for features such as printing with Google Cloud Print or IEEE 802.1X authentication. Up to 150 CA certificates can be registered, including the 72 certificates that are preinstalled in the machine ([▶Using CA-issued Key Pairs and Digital Certificates\(P. 277\)](#)).

Generating Key Pairs

51W4-04R

A key pair can be generated with the machine when it is required for encrypted communication via Transport Layer Security (TLS). You can use TLS when accessing the machine via the Remote UI or performing IPP Print. Up to eight key pairs, including the preinstalled pairs, can be registered. Self-signed certificates are used with key pairs generated in "Network Communication". With a "Key and Certificate Signing Request (CSR)", you can apply for a CA-issued digital certificate for the key pair generated by the machine.

- ▶ **Generate Network Communication Key(P. 268)**
- ▶ **Generate Key and Certificate Signing Request (CSR)(P. 271)**

Generate Network Communication Key

1 Start the Remote UI and log on in Management Mode. ▶ Starting Remote UI(P. 284)

2 Click [Settings/Registration].

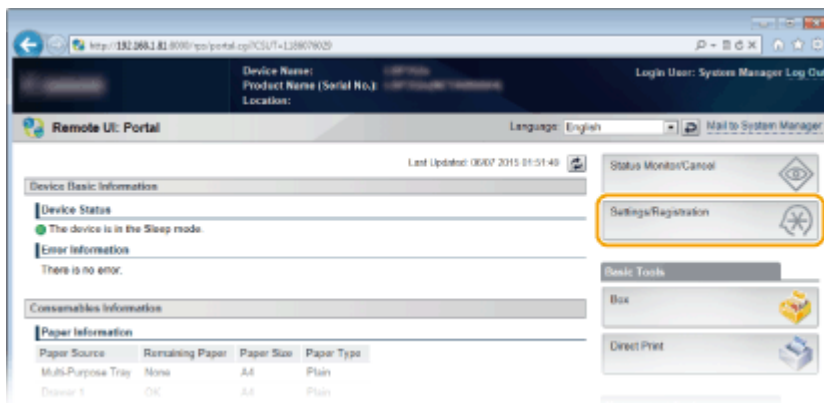

3 Click [Security] ▶ [Key and Certificate Settings].

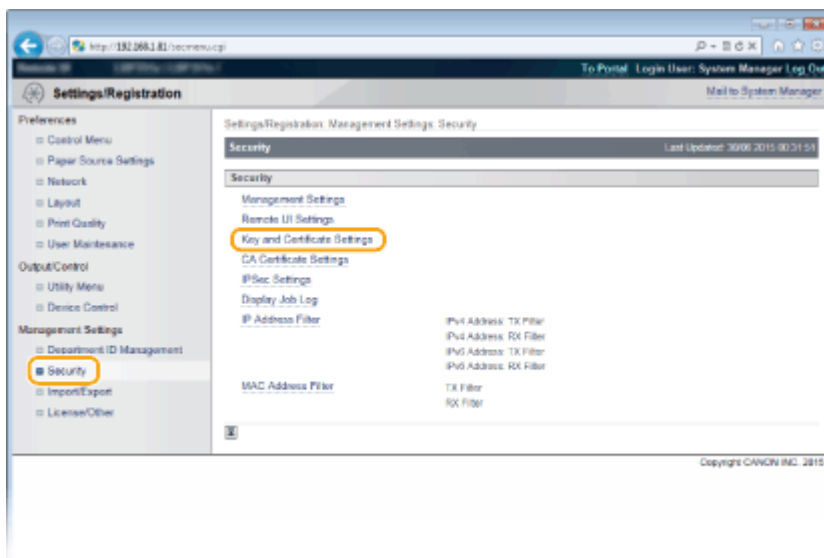

4 Click [Generate Key].

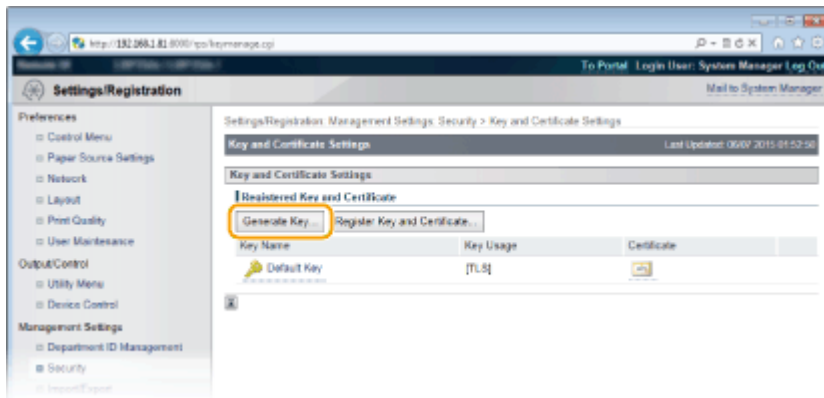

NOTE:

Deleting a registered key pair

- Click [Delete] on the right of the key pair you want to delete ► click [OK].
- A key pair cannot be deleted if it is currently used for some purpose, such as when "TLS" or "IEEE 802.1X", is displayed under [Key Usage]. In this case, disable the function or replace the key pair before deleting it.

5 Select [Network Communication] and click [OK].

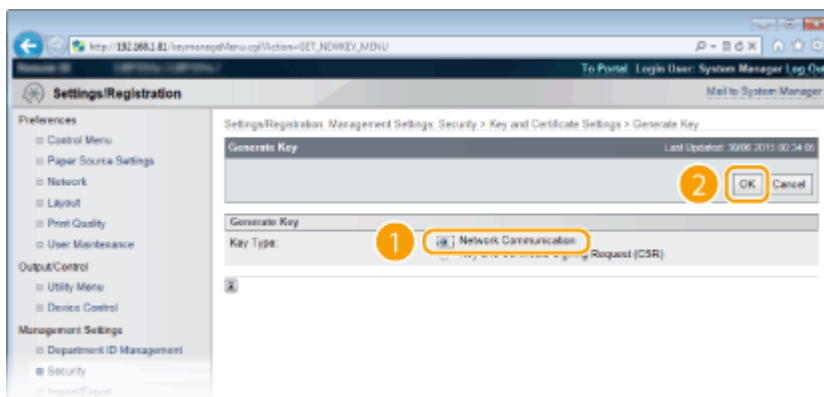

6 Specify settings for the key and certificate.

a [Key Settings]

[Key Name]

Enter alphanumeric characters for naming the key pair. Set a name that will be easy for you to find later in a list.

[Signature Algorithm]

Select the signature algorithm from the drop-down list.

[Key Algorithm]

RSA or ECDSA is used for generating a key pair. Select the key length from the drop-down list. The larger the number for the key length, the slower the communication. However, the security is tighter.

NOTE:

- [512 bit] cannot be selected for the key length of RSA, if [SHA384] or [SHA512] is selected for [Signature Algorithm].

b [Certificate Settings]

[Validity Start Date (dd/mm yyyy)]

Enter the validity start date of the certificate.

[Validity End Date (dd/mm yyyy)]

Enter the validity end date of the certificate. A date earlier than [Validity Start Date (dd/mm yyyy)] cannot be set.

[Country/Region]

Enter characters for the Internet country code.

[State]/[City]

Enter alphanumeric characters for the location as necessary.

[Organization]/[Organization Unit]

Enter alphanumeric characters for the organization name as necessary.

[Common Name]

Enter alphanumeric characters for the common name of the certificate as necessary. "Common Name" is often abbreviated as "CN."

IMPORTANT:

To perform IPPS Print, the "IP address" or "<host name>.<domain name>" that is used for connection via IPPS must be entered in [Common Name].

- Enter the "IP address" when it is fixed.
- Enter "<host name>.<domain name>" when the DNS server is used. ▶ **Enabling IPP/ IPPS(P. 155)**

7 Click [OK].

- Keys for network communication may take approximately 10 to 15 minutes to generate.
- After a key pair is generated, it is automatically registered to the machine.

Generate Key and Certificate Signing Request (CSR)

1 Start the Remote UI and log on in Management Mode.

▶ **Starting Remote UI(P. 284)**

2 Click [Settings/Registration].

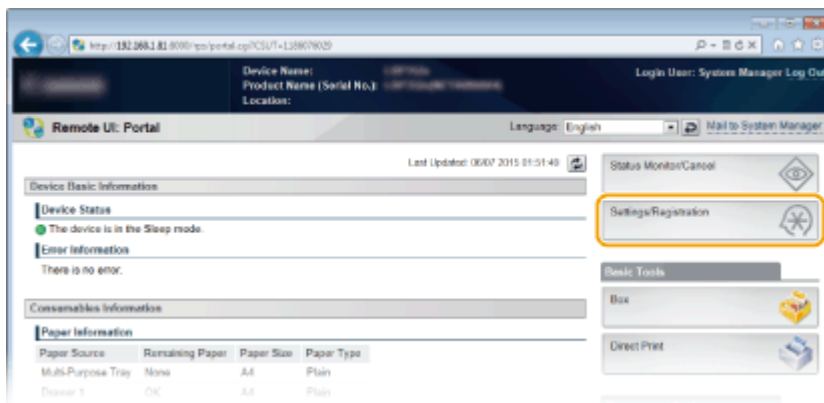

3 Click [Security] ▶ [Key and Certificate Settings].

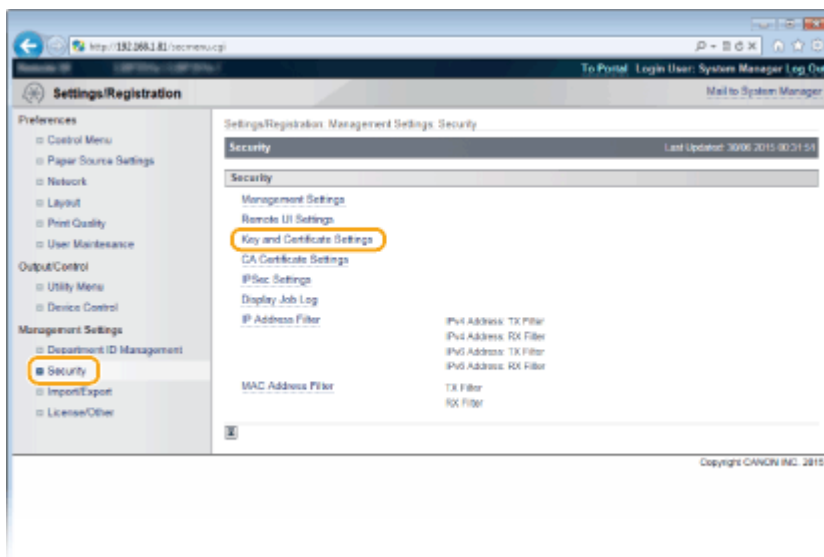

4 Click [Generate Key].

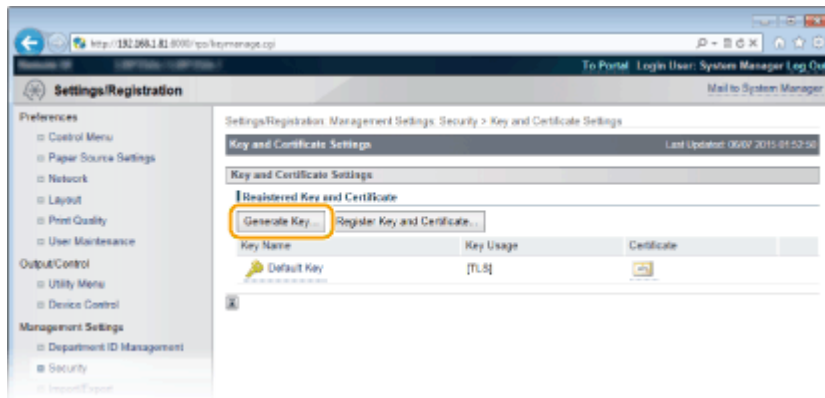

NOTE:

Deleting a registered key pair

- Click [Delete] on the right of the key pair you want to delete ► click [OK].
- A key pair cannot be deleted if it is currently used for some purpose, such as when "TLS" or "IEEE 802.1X", is displayed under [Key Usage]. In this case, disable the function or replace the key pair before deleting it.

5 Select [Key and Certificate Signing Request (CSR)] and click [OK].

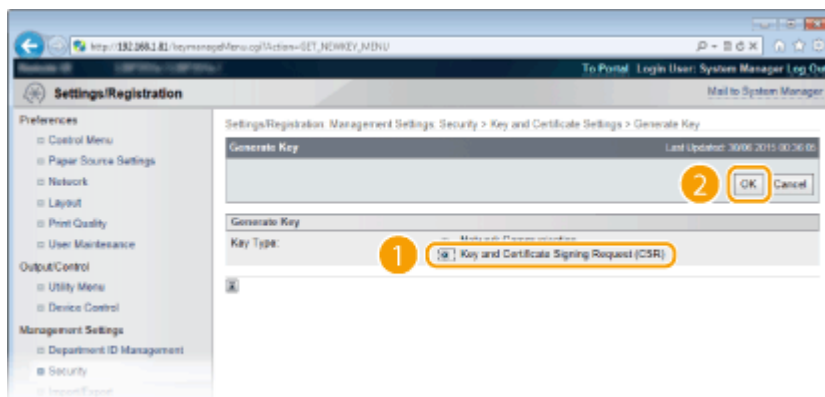

6 Specify settings for the key and certificate.

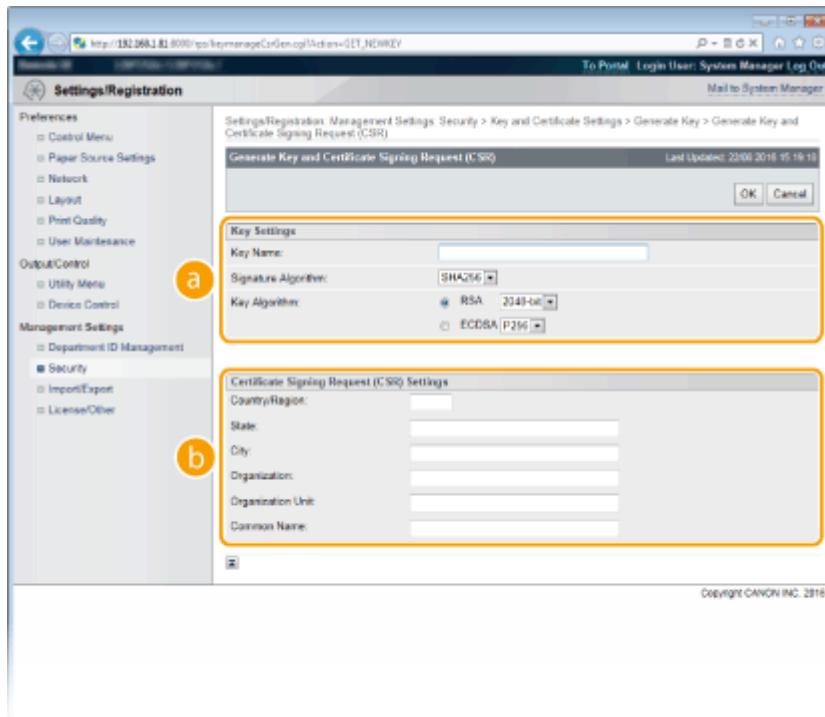

a [Key Settings]

[Key Name]

Enter alphanumeric characters for naming the key pair. Set a name that will be easy for you to find later in a list.

[Signature Algorithm]

Select the signature algorithm from the drop-down list.

[Key Algorithm]

RSA or ECDSA is used for generating a key pair. Select the key length from the drop-down list. The larger the number for the key length, the slower the communication. However, the security is tighter.

NOTE:

- [512 bit] cannot be selected for the key length of RSA, if [SHA384] or [SHA512] is selected for [Signature Algorithm].

b [Certificate Signing Request (CSR) Settings]

[Country/Region]

Enter characters for the Internet country code.

[State]/[City]

Enter alphanumeric characters for the location as necessary.

[Organization]/[Organization Unit]

Enter alphanumeric characters for the organization name as necessary.

[Common Name]

Enter alphanumeric characters for the common name of the certificate as necessary. "Common Name" is often abbreviated as "CN."

IMPORTANT:

To perform IPPS Print, the "IP address" or "<host name>.<domain name>" that is used for connection via IPPS must be entered in [Common Name].

- Enter the "IP address" when it is fixed.
- Enter "<host name>.<domain name>" when the DNS server is used. ▶ **Enabling IPP/ IPPS(P. 155)**

7 Click [OK].

- Key and Certificate Signing Request (CSR) may take approximately 10 to 15 minutes to generate.

8 Click [Store in File].

- A dialog box for storing the file appears. Choose where to store the file and click [Save].

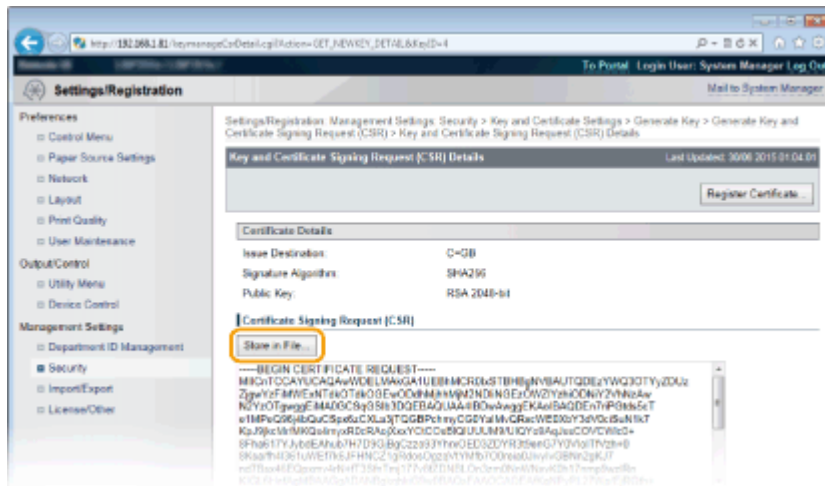

⇒ The Key and Certificate Signing Request (CSR) file is stored on the computer.

9 Attach the stored file and submit the application to the certification authority.

■ Register the digital certificate issued by the certification authority.

You cannot use the key pair generated by the Certificate Signing Request (CSR) until the certificate is registered. Once the certification authority has issued the digital certificate, register it using the procedure below.

1 Start the Remote UI and log on in Management Mode. ▶ Starting Remote UI(P. 284)

2 Click [Settings/Registration].

3 Click [Security] ▶ [Key and Certificate Settings].

4 Click [Key Name] or [Certificate] for the certificate to be registered.

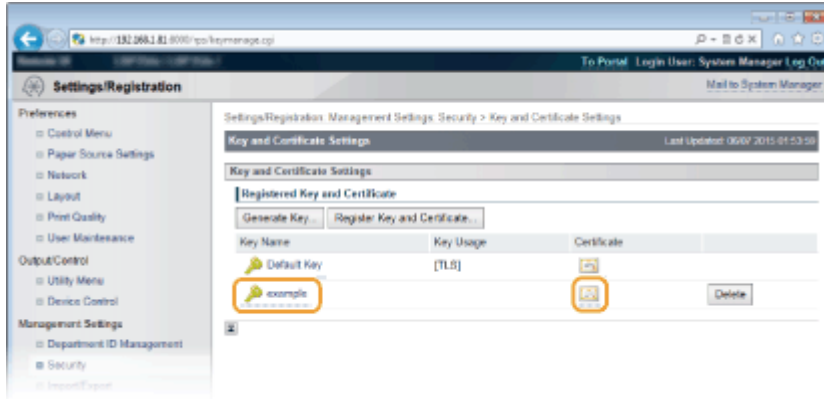

5 Click [Register Certificate].

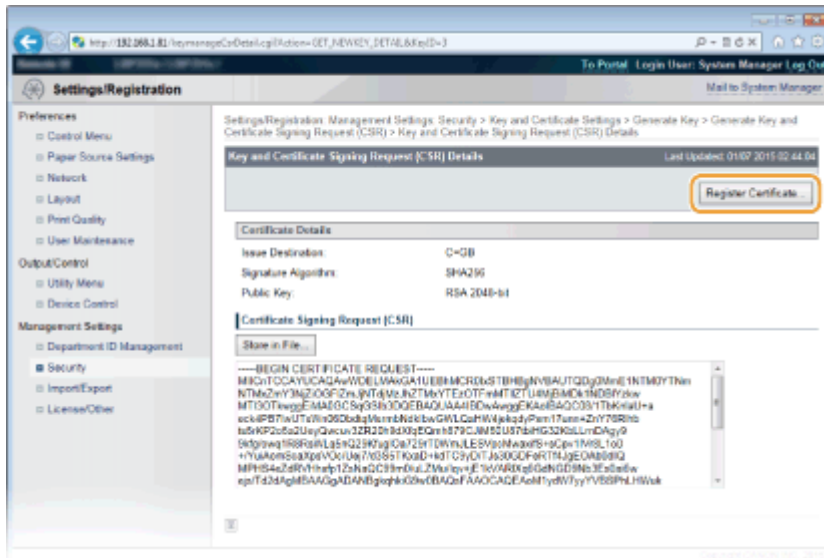

6 Click [Browse] in [File Path], specify the file for the certificate signing request, and click [Register].

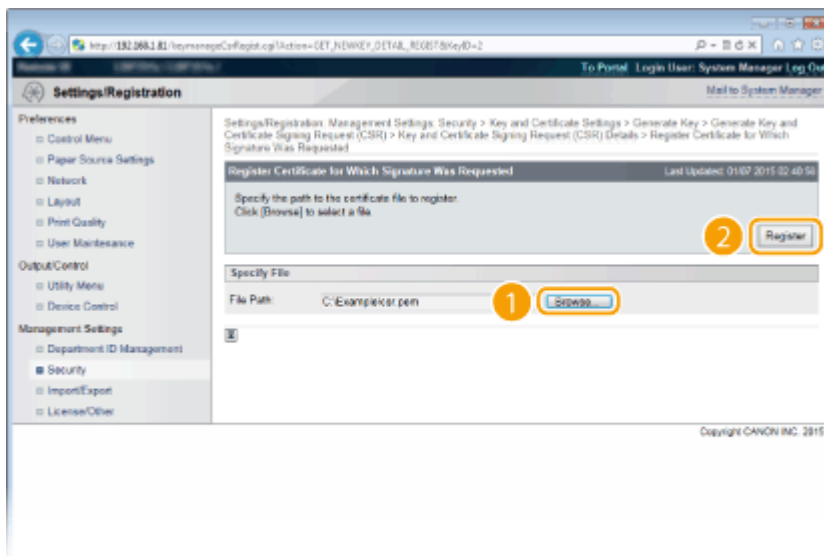

LINKS

- ▶ Using CA-issued Key Pairs and Digital Certificates(P. 277)
- ▶ Verifying Key Pairs and Digital Certificates(P. 280)

- ▶ **Using TLS for Encrypted Communications(P. 246)**
- ▶ **Configuring IPSec Settings(P. 251)**

Using CA-issued Key Pairs and Digital Certificates

51W4-04S

Key pairs and digital certificates can be obtained from a certification authority (CA) for use with the machine. You can store and then register these files by using the Remote UI. Make sure that the key pair and the certificate satisfy the requirements of the machine ([▶Registration of Keys and Certificates\(P. 480\)](#)). Up to 8 key pairs (including the preinstalled ones) can be registered, and up to 150 CA certificates (including the 72 preinstalled ones) can be registered.



1 Start the Remote UI and log on in Management Mode. [▶Starting Remote UI\(P. 284\)](#)

2 Click [Settings/Registration].

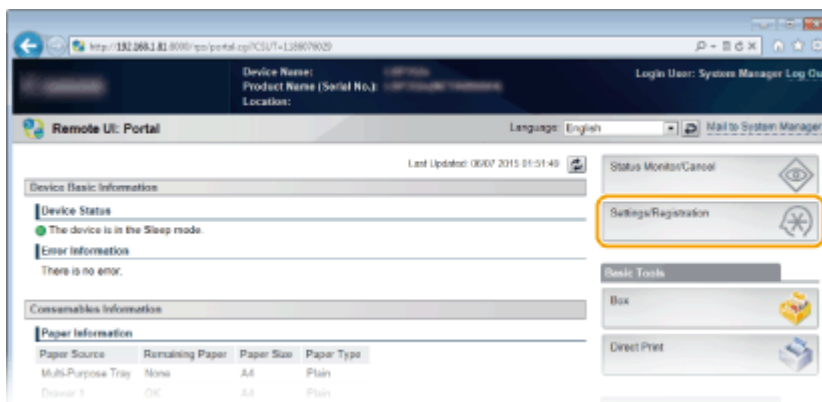

3 Click [Security] ▶ [Key and Certificate Settings] or [CA Certificate Settings].

- Click [Key and Certificate Settings] to install a key pair, or [CA Certificate Settings] to install a CA certificate.

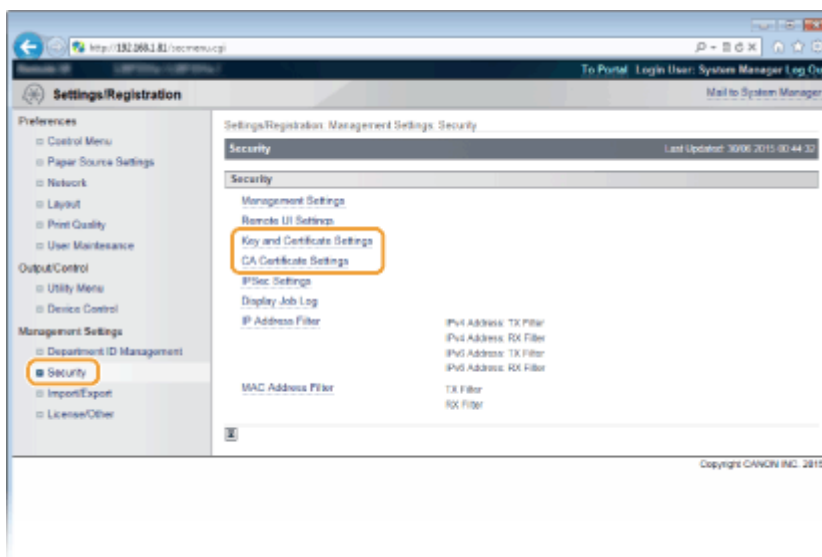

4 Click [Register Key and Certificate] or [Register CA Certificate].

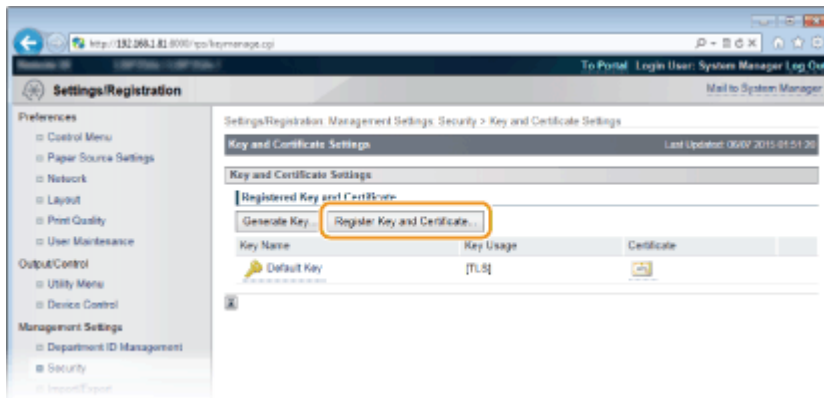

NOTE:

Deleting a registered key pair or CA certificate

- Click [Delete] on the right of the key pair or CA certificate you want to delete ► click [OK].
- A key pair cannot be deleted if it is currently used for some purpose, such as when "[TLS]" or "[IEEE 802.1X]" is displayed under [Key Usage]. In this case, disable the function or replace the key pair before deleting it. The preinstalled CA certificate cannot be deleted.

5 Click [Install].

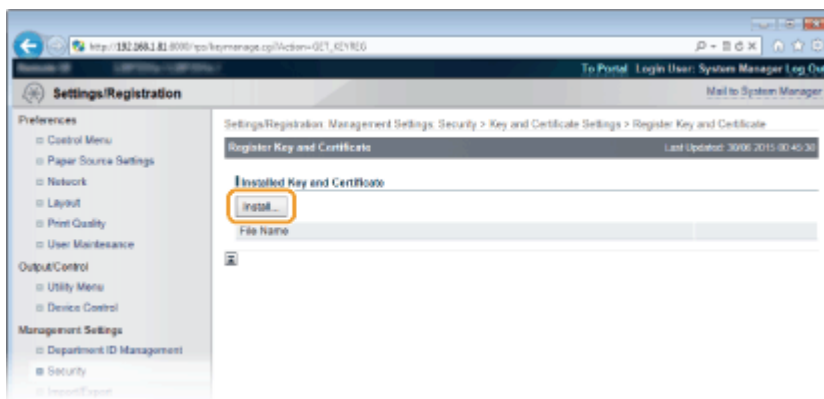

NOTE:

Deleting a key pair or CA certificate

- Click [Delete] on the right of the file you want to delete, and then click [OK].

6 Click [Browse], specify the file to install, and click [Start Installation].

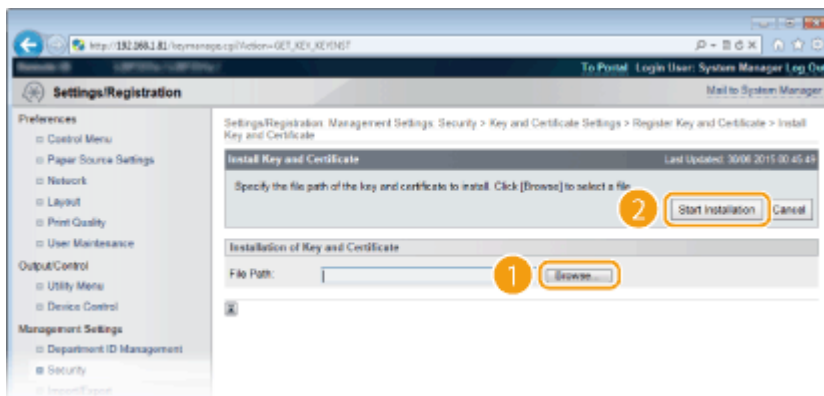

- The key pair or CA certificate is installed in the machine.

7 Register the key pair or CA certificate.

■ Registering a key pair

- 1 Click [Register] on the right of the key pair you want to register.
- 2 Enter the name of the key pair and password, and then click [OK].

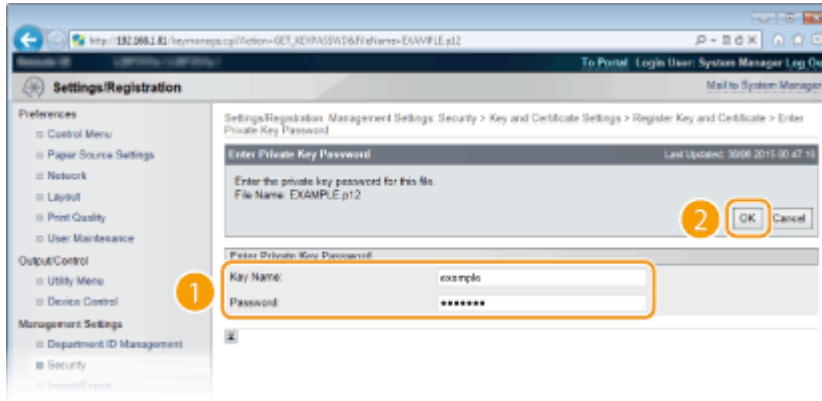

[Key Name]

Enter alphanumeric characters for the name of the key pair to be registered.

[Password]

Enter alphanumeric characters for the password of the private key set for the file to be registered.

■ Registering a CA certificate

Click [Register] on the right of the CA certificate you want to register.

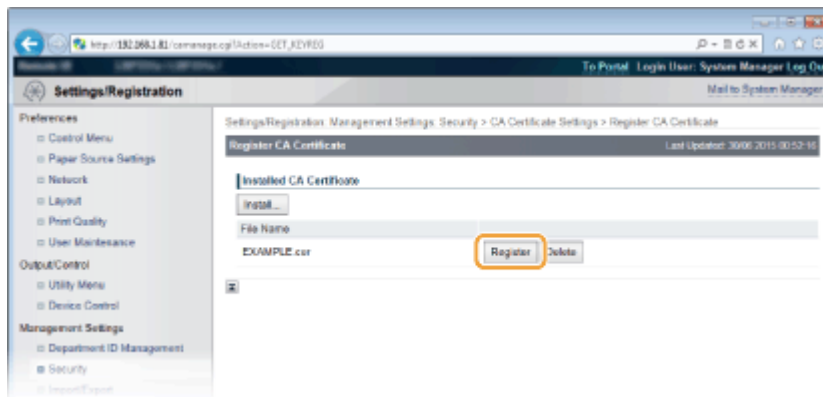

LINKS

- ▶ [Generating Key Pairs\(P. 268\)](#)
- ▶ [Verifying Key Pairs and Digital Certificates\(P. 280\)](#)
- ▶ [Using TLS for Encrypted Communications\(P. 246\)](#)
- ▶ [Configuring IPsec Settings\(P. 251\)](#)
- ▶ [Configuring IEEE 802.1X Authentication\(P. 261\)](#)

Verifying Key Pairs and Digital Certificates

51W4-04U

Once key pairs and CA certificates are registered, you can view their detailed information or verify them for validity and signature.

1 Start the Remote UI and log on in Management Mode. ▶ Starting Remote UI(P. 284)

2 Click [Settings/Registration].

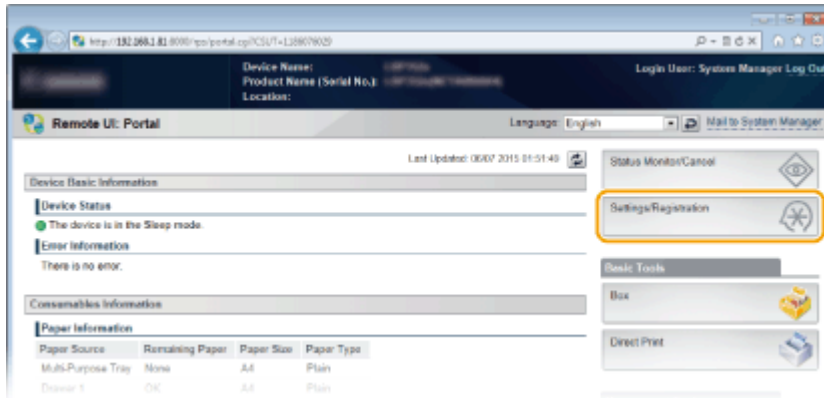

3 Click [Security] ▶ [Key and Certificate Settings] or [CA Certificate Settings].

- Click [Key and Certificate Settings] to verify a key pair, or [CA Certificate Settings] to verify a CA certificate.

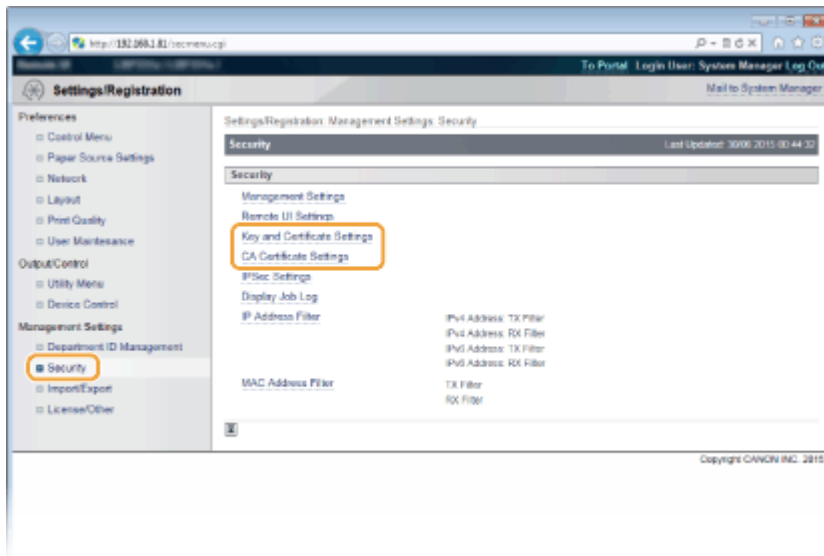

4 Click the icon for the key pair or certificate that you want to verify.

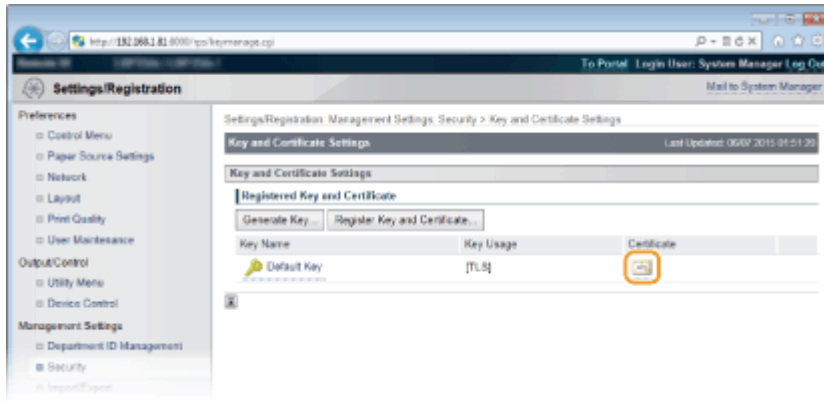

- Certificate details can be viewed on this screen.

5 Check the details of the certificate, and click [Certificate Verification].

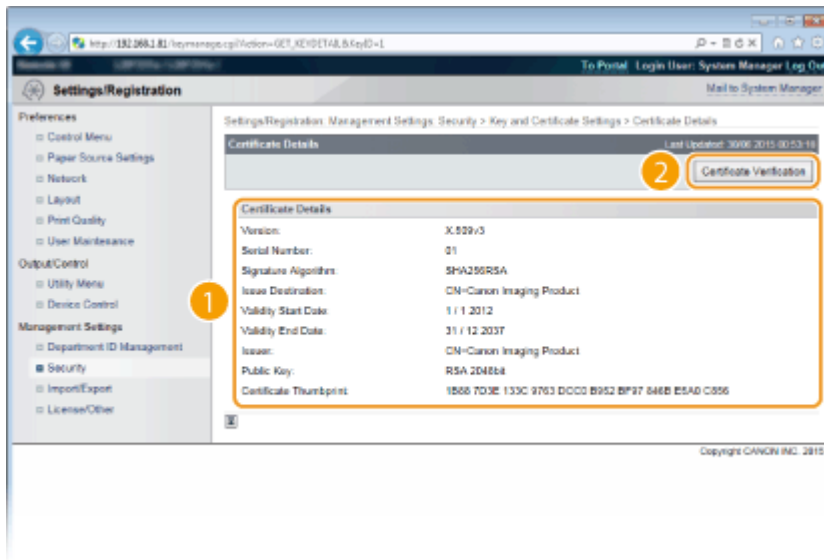

- The result from verifying the certificate is displayed as shown below.



LINKS

- ▶ **Generating Key Pairs(P. 268)**
- ▶ **Using CA-issued Key Pairs and Digital Certificates(P. 277)**

Using Remote UI

- Using Remote UI** 283
 - Starting Remote UI** 284
 - Remote UI Screens** 287
 - Managing Documents and Checking the Machine Status** 293
 - Enabling End Users to Operate Documents 298
 - Setting Up Menu Options from Remote UI** 301
 - Saving/Loading Registered Data** 303
 - Saving Registered Data 304
 - Loading Registered Data 306

Using Remote UI

51W4-04W

Using a Web browser to operate the machine remotely, you can check the documents waiting to be printed or the status of the machine. You can also make some settings for the machine. You can do this without leaving your desk, making system management easier. For more information about the system requirements for the Remote UI, see [▶ System Environment\(P. 483\)](#) .

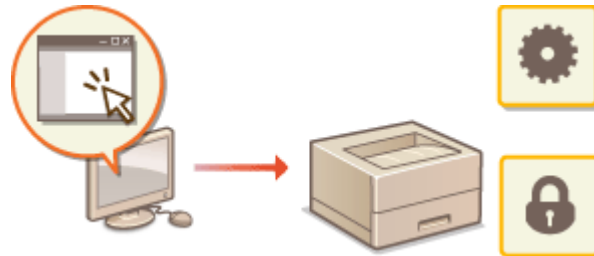

Functions of the Remote UI

- ▶ [Managing Documents and Checking the Machine Status\(P. 293\)](#)
- ▶ [Setting Up Menu Options from Remote UI\(P. 301\)](#)
- ▶ [Saving/Loading Registered Data\(P. 303\)](#)

Basics of the Remote UI

- ▶ [Starting Remote UI\(P. 284\)](#)
- ▶ [Remote UI Screens\(P. 287\)](#)

Starting Remote UI

51W4-04X

To operate remotely, you need to input the IP address of the machine into a Web browser and start the Remote UI. Check the IP address set to the machine in advance ([▶Network Status Print\(P. 403\)](#)). If you have any questions, ask your Network Administrator.

1 Start the Web browser.

2 Enter "http://(the IP address of the machine)/" in the address field, and press the [ENTER] key.

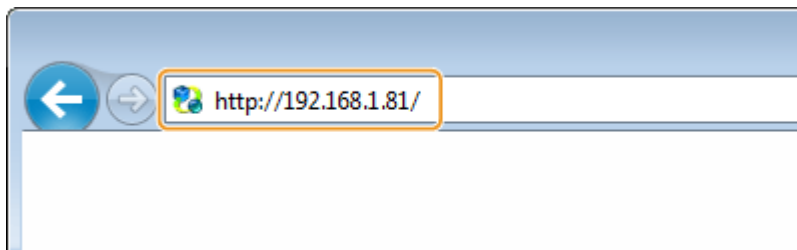

- If you want to use an IPv6 address, enclose the IPv6 address with brackets (example: http://[fe80::2e9e:fcff:fe4e:dbce]/).

NOTE:

If using a DNS server

- You can enter "<host name of the machine>.<domain name>" instead of "IP address of the machine" (example: http://my_printer.example.com).

If a security alert is displayed

- A security alert may be displayed when the Remote UI communication is encrypted ([▶Using TLS for Encrypted Communications\(P. 246\)](#)). When certificate settings or TLS settings have no errors, continue browsing the Web site.

3 Log on to the Remote UI.

■When the Department ID Management is disabled

Select [Management Mode] or [General User Mode].

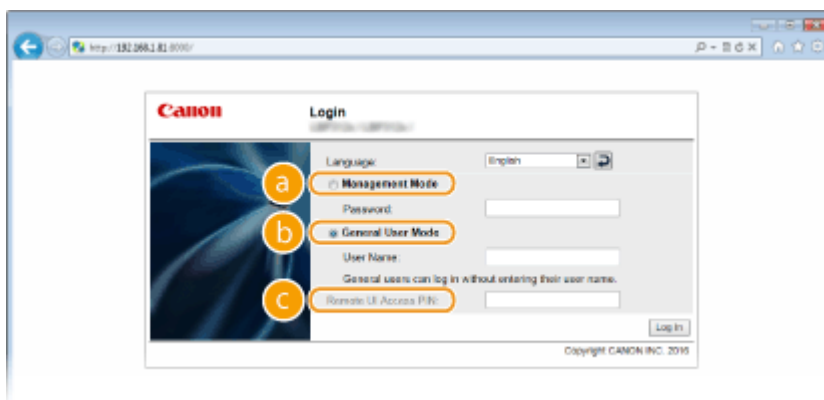

a [Management Mode]

You can perform all the Remote UI operations and settings. Enter the System Manager password in [Password].

NOTE:

- The default System Manager password is "7654321." **▶Setting the System Manager Password(P. 205)**

b [General User Mode]

You can check the status of documents or the machine, and you can also change some of the settings. If you wish to delete your print documents, enter the user name of the documents in [User Name]. The user name is automatically set to print documents based on information such as your computer name or computer logon name.

NOTE:**About [User Name]**

- By default, [User Name] is not displayed to disable general users to operate documents. If you want to operate documents in General User Mode, log on in Management Mode and enable [Allow General User Job Operation]. **▶Enabling End Users to Operate Documents(P. 298)**

c [Remote UI Access PIN]

If [Remote UI Access PIN] is displayed, enter the PIN (**▶Setting a Remote UI PIN(P. 215)**).

■When the Department ID Management is enabled

Enter the appropriate ID in [Department ID] and PIN in [PIN] (**▶Setting the Department ID Management(P. 208)**).

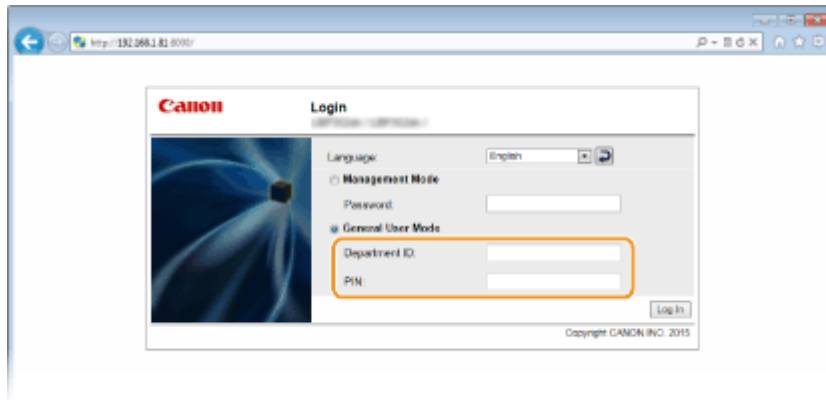
**4 Click [Log In].**

- ⇒ Portal Page (main page) will be displayed. **▶Remote UI Screens(P. 287)**

The screenshot displays the Remote UI Portal interface. At the top, it shows the device name, product name, and location. The main content area is divided into several sections: Device Status (indicating the device is in Sleep mode), Error Information (stating there is no error), Consumables Information (including Paper Information and Toner Cartridge Information), Message Board, and Support Link. A right-hand sidebar contains navigation buttons for Status Monitor/Cancel, Settings/Registration, Basic Tools (Box, Direct Print), and Management Tools (Service Management Service). The footer indicates Copyright CANON INC. 2016.

Device Name: [Redacted] Login User: System Manager Log Out
 Product Name (Serial No.): [Redacted]
 Location: [Redacted]

Remote UI: Portal Language: English Mail to System Manager

Last Updated: 2/26/2015 14:30:02

Device Basic Information

Device Status
 The device is in the Sleep mode.

Error Information
 There is no error.

Consumables Information

Paper Information

Paper Source	Remaining Paper	Paper Size	Paper Type
Multi-Purpose Tray	None	A4	Free (Mixed Types)
Drawer 1	OK	A4	Free (Mixed Types)

Toner Cartridge Information

Color	Remaining Toner
Black	██████████ 99%

Message Board
 Message from System Manager

Support Link
 Support Link: <http://www.canon.com>

Copyright CANON INC. 2016

Remote UI Screens

51W4-04Y

This section describes the typical screens of the Remote UI.

- ▶ **Portal Page (Main Page)(P. 287)**
- ▶ **[Status Monitor/Cancel] Page(P. 288)**
- ▶ **[Settings/Registration] Page(P. 289)**
- ▶ **[Box] Page(P. 290)**
- ▶ **[Direct Print] Page(P. 291)**

Portal Page (Main Page)

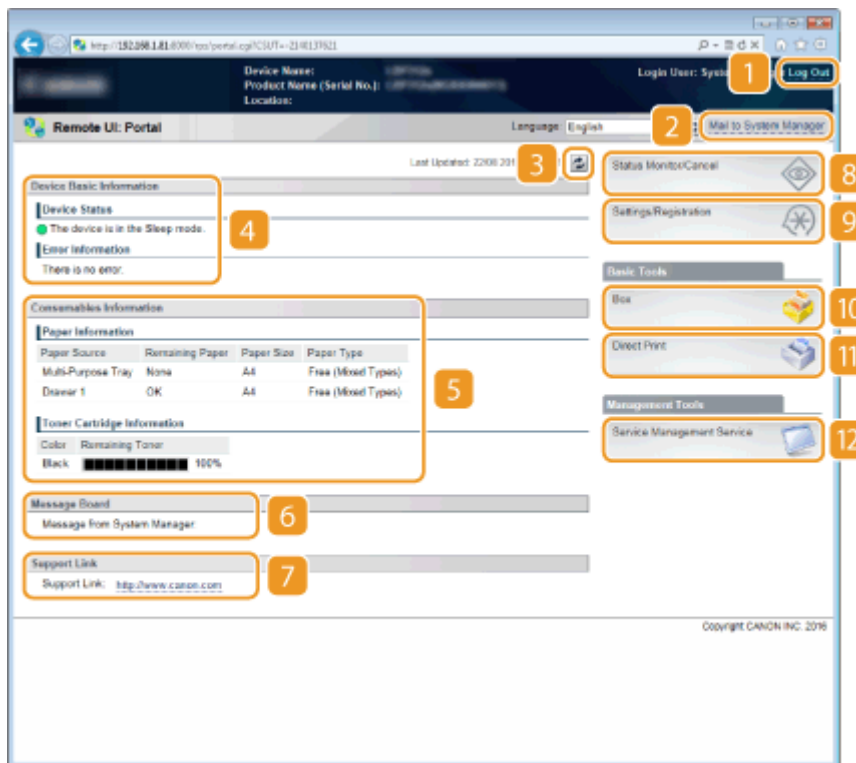

1 [Log Out]

Logs off from the Remote UI. The Login page will be displayed.

2 [Mail to System Manager]

Displays a window for creating an e-mail to the system manager specified in [Management Settings] under [Security].

3 Refresh Icon

Refreshes the currently displayed page.

4 Device Basic Information

Displays the current status of the machine and error information. If an error has occurred, the link to the Error Information page will be displayed.

5 Consumables Information

Displays information about paper (remaining amount, size, etc.) and the status of toner cartridges.

6 [Message Board]

Displays a message from the System Manager specified in [Message Board/Support Link] under [Settings/Registration] ▶ [License/Other]. **▶Setting Up Menu Options from Remote UI(P. 301)**

7 Support Link

Displays a text link to the support information of the machine specified in [Message Board/Support Link] under [Settings/Registration] ▶ [License/Other]. **▶Setting Up Menu Options from Remote UI(P. 301)**

8 [Status Monitor/Cancel]

Displays [Status Monitor/Cancel] page. You can use this page to check the current printing status, cancel print processing, and view a history of print jobs.

9 [Settings/Registration]

Displays [Settings/Registration] page. When you have logged on in Management Mode, you can change the settings items and save/load the registered data. **▶Setting Up Menu Options from Remote UI(P. 301)**

10 [Box] (only when an optional SD card is installed)

Displays the [Box] page. You can print and delete documents stored in the machine. **▶Printing a Document Stored in the Machine (Stored Job Print)(P. 92)**

11 [Direct Print]

You can print a file stored in a computer without opening it. **▶Printing without Opening a File (Direct Print)(P. 101)**

12 [Service Management Service]

Starts Service Management Service (SMS) used to manage MEAP applications (function-enhancing software). **Function Guide for MEAP Application Management**

[Status Monitor/Cancel] Page

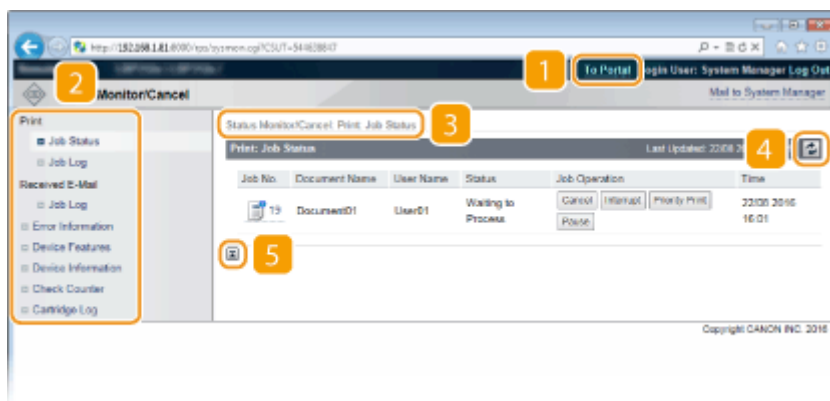

1 [To Portal]

Returns to Portal Page (main page).

2 Menu

Click an item, and the content is displayed in the right page. **▶Managing Documents and Checking the Machine Status(P. 293)**

3 Breadcrumb Trail

Indicates the series of pages you opened to display the currently displayed page. You can check what page is currently displayed.

4 Refresh Icon

Refreshes the currently displayed page.

5 Top Icon

Moves the scroll box up to the top of the page when the page is scrolled down.

[Settings/Registration] Page

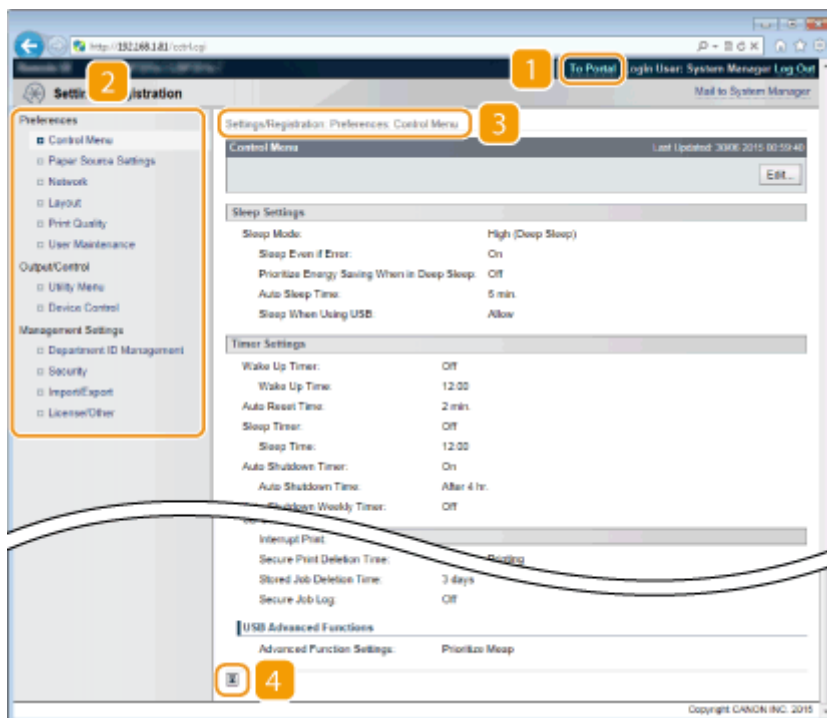
**1 [To Portal]**

Returns to Portal Page (main page).

2 Menu

Click an item, the content is displayed in the right page. **▶Setting Up Menu Options from Remote UI(P. 301)**

3 Breadcrumb Trail

Indicates the series of pages you opened to display the currently displayed page. You can check what page is currently displayed.

4 Top Icon

Moves the scroll box up to the top of the page when the page is scrolled down.

NOTE

Menu on the [Settings/Registration] page

- You can change settings on the [Settings/Registration] page only when you have logged on in Management Mode.
- If you log on in General User Mode, [Utility Menu], [Device Control], [Department ID Management], and [Import/Export] are not displayed.

[Box] Page

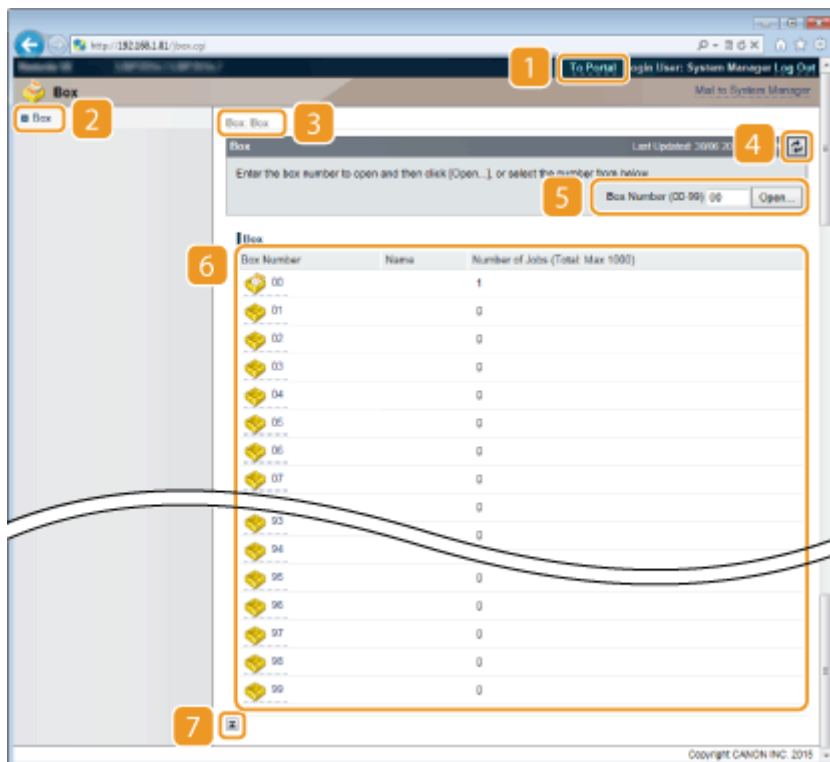

1 [To Portal]

Returns to Portal Page (main page).

2 [Box]

Displays a list of boxes. You can open a box to check detailed information of the documents stored in the box, print and delete the documents. ▶ **Printing a Document Stored in the Machine (Stored Job Print) (P. 92)**

3 Breadcrumb Trail

Indicates the series of pages you opened to display the currently displayed page. You can check what page is currently displayed.

4 Refresh Icon

Refreshes the currently displayed page.

5 Box Number

You can enter a box number and click [Open] to open the box of the entered number.

6 Box List

You can click the text link under [Box Number] to open the applicable box.

7 Top Icon

Moves the scroll box up to the top of the page when the page is scrolled down.

[Direct Print] Page

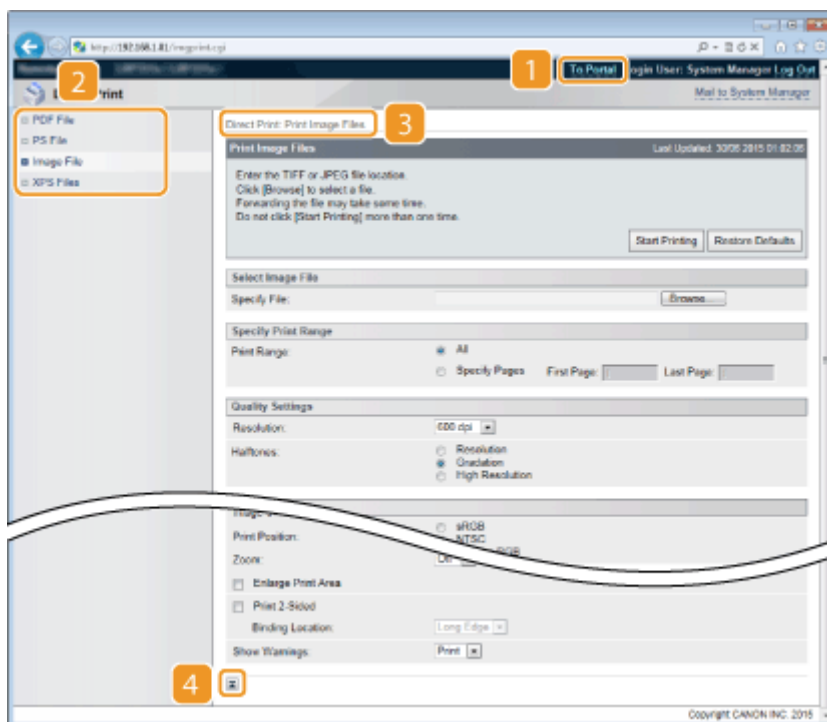

1 [To Portal]

Returns to Portal Page (main page).

2 Menu

Displays the page for specifying the file format of a file to be printed by Direct Print. ▶ **Printing without Opening a File (Direct Print)(P. 101)**

3 Breadcrumb Trail

Indicates the series of pages you opened to display the currently displayed page. You can check what page is currently displayed.

4 Top Icon

Moves the scroll box up to the top of the page when the page is scrolled down.

Managing Documents and Checking the Machine Status

51W4-050

- ▶ **Checking Current Status of Print Documents(P. 293)**
- ▶ **Checking History of Documents(P. 294)**
- ▶ **Checking Error Information(P. 295)**
- ▶ **Checking Device Specifications(P. 295)**
- ▶ **Checking System Manager Information(P. 296)**
- ▶ **Checking Print Total Counter(P. 297)**
- ▶ **Checking Toner Cartridge Usage Logs(P. 297)**

NOTE

- A file name of a document may not be displayed in full. The printed application name may be added to the file name.

Checking Current Status of Print Documents

You can check the print status (currently being printed or waiting to be printed) of the documents designated to be printed from a computer, and delete or interrupt documents.



Log on to the Remote UI (▶ **Starting Remote UI(P. 284)**) ▶ [Status Monitor/Cancel] ▶ [Job Status]

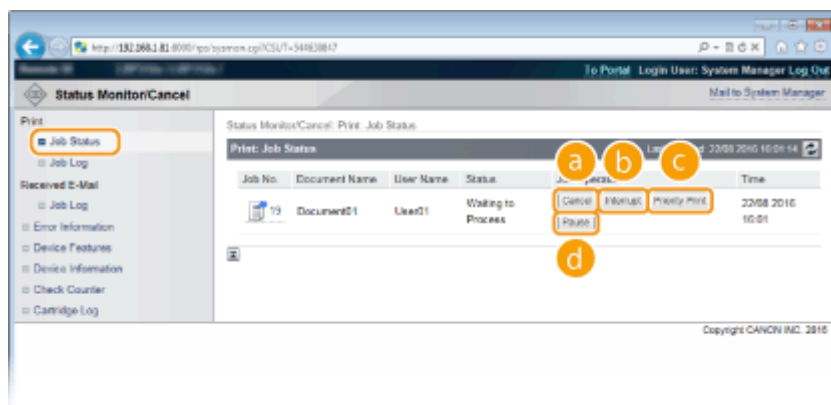

a [Cancel]

You can delete documents that are being printed or waiting to be printed.

b [Interrupt] *

Temporarily stops the current print job in progress and starts a specified print job. For the interrupted print job, printing of the remaining pages is started as soon as the interrupting print job is finished.

c [Priority Print] *

Moves up the print order of a document waiting to be printed by one.

d [Pause] */[Resume] *

Press [Pause] to temporarily stop the current print job. Press [Resume] to restart the paused print job.

NOTE:

- For a secured or encrypted secured document, clicking [Resume] displays a screen to prompt you to enter the PIN. Enter the correct PIN and click [OK].

*Not displayed when <Interrupt Print> is set to <Off> in the setting menu of the operation panel (**Interrupt Print(P. 319)**).

NOTE

- The status of all print jobs is displayed regardless of the settings of the Department ID Management.
- The factory default settings prevent some operations, such as deleting a document to print or interrupting a print job, from being performed in General User Mode. If you want to operate documents in General User Mode, log on in Management Mode and enable [Allow General User Job Operation]. **Enabling End Users to Operate Documents(P. 298)**
- If you entered your user name when you logged on in General User Mode, your user name will only be displayed on the documents that you printed.
- Click [Job No.] on the paused documents and secure documents to display detailed information. You can check the user name and the page count of the printed document.

Checking History of Documents

The print history and e-mail reception history are displayed in list form.

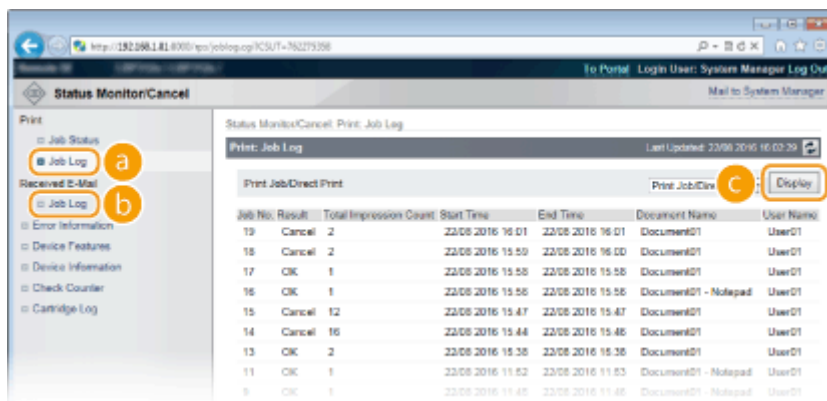

Log on to the Remote UI (**Starting Remote UI(P. 284)**) ▶ [Status Monitor/Cancel] ▶ [Job Log]

**a [Job Log] (Print)**

Print history can be displayed for each type of print. **Maximum Number of Job Logs That Can Be Displayed(P. 480)**

b [Job Log] (E-Mail RX)

The e-mail reception history is displayed. If an error occurs during e-mail reception, the applicable error code is displayed in [RX Results]. **E-Mail Reception Error Codes(P. 480)**

G [Display] (print history only)

When you select the print type from the drop-down list and click [Display], the history of the selected print type is displayed in list form.

NOTE

- If any optional SD card is not installed on the machine, the history is erased when a shutdown or hard reset is performed.
- If you log into the machine in General User Mode when [Allow General User Job Operation] is active, the document name for jobs other than yours is not shown but instead asterisks are shown, like "*****".  **Enabling End Users to Operate Documents(P. 298)**

Checking Error Information

When an error occurs, this page will be displayed by clicking the message displayed under [Error Information] on Portal Page (main page).  **Portal Page (Main Page)(P. 287)**



Log on to the Remote UI ( **Starting Remote UI(P. 284)**)  [Status Monitor/Cancel]  [Error Information]

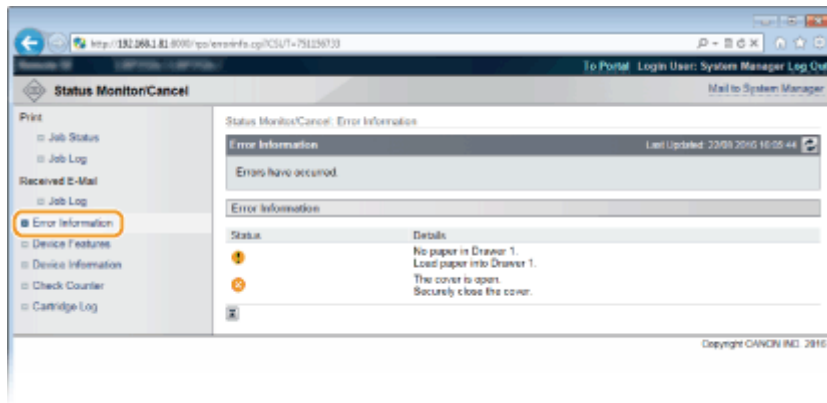

Checking Device Specifications

You can view the information including the maximum print speed and features of the machine.



Log on to the Remote UI ( **Starting Remote UI(P. 284)**)  [Status Monitor/Cancel]  [Device Features]

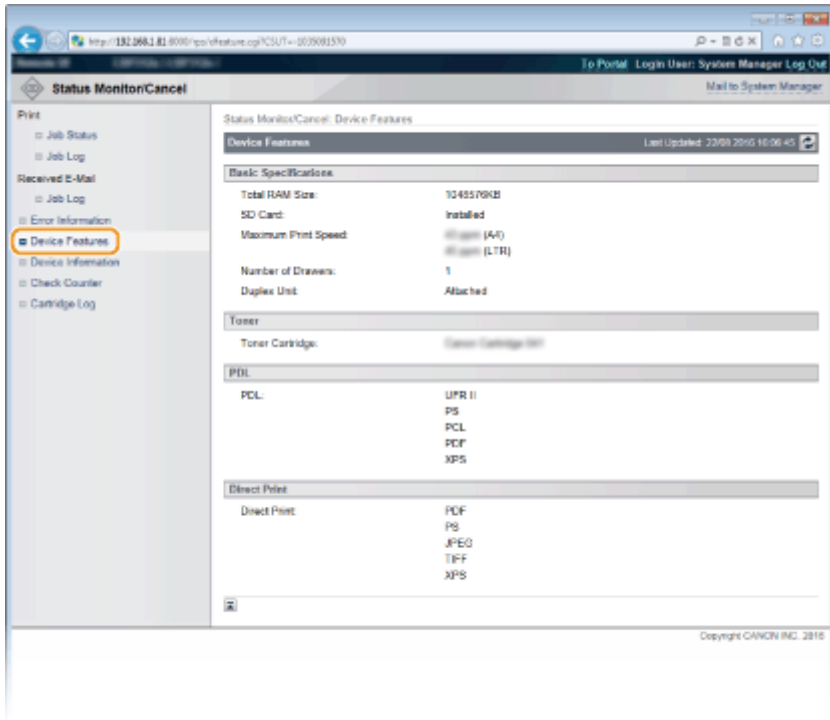

Checking System Manager Information

Information about the machine and the system manager is displayed. This information is what has been set in [Security] ▶ [Management Settings] on the [Settings/Registration] page (**Setting the System Manager Password(P. 205)**).



Log on to the Remote UI (**Starting Remote UI(P. 284)**) ▶ [Status Monitor/Cancel] ▶ [Device Information]

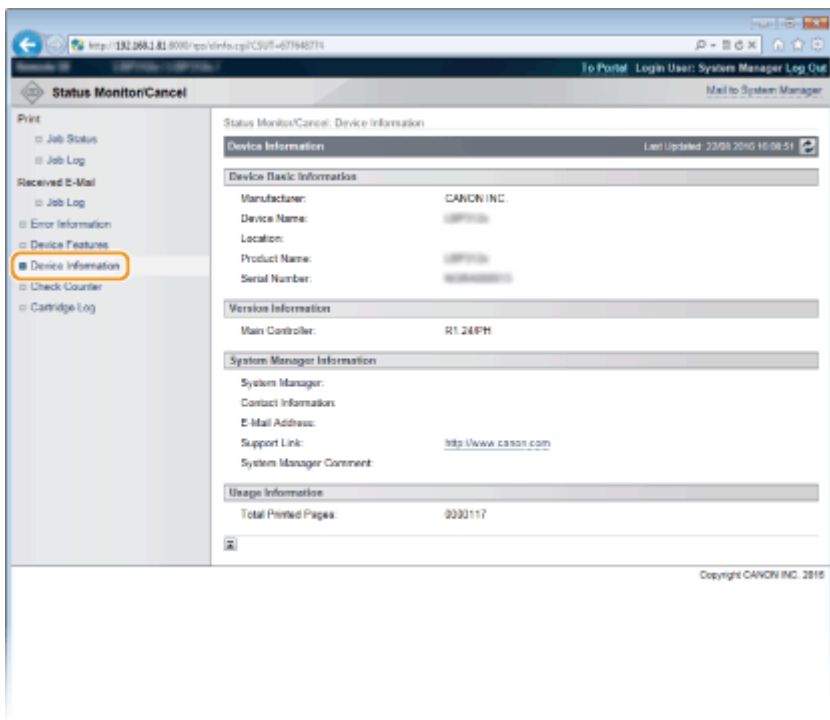

Checking Print Total Counter

The total number of pages that have been printed is displayed.



Log on to the Remote UI ([▶ Starting Remote UI\(P. 284\)](#)) ▶ [Status Monitor/Cancel] ▶ [Check Counter]



Checking Toner Cartridge Usage Logs

You can check logs of usage of toner cartridge.



Log on to the Remote UI ([▶ Starting Remote UI\(P. 284\)](#)) ▶ [Status Monitor/Cancel] ▶ [Cartridge Log]

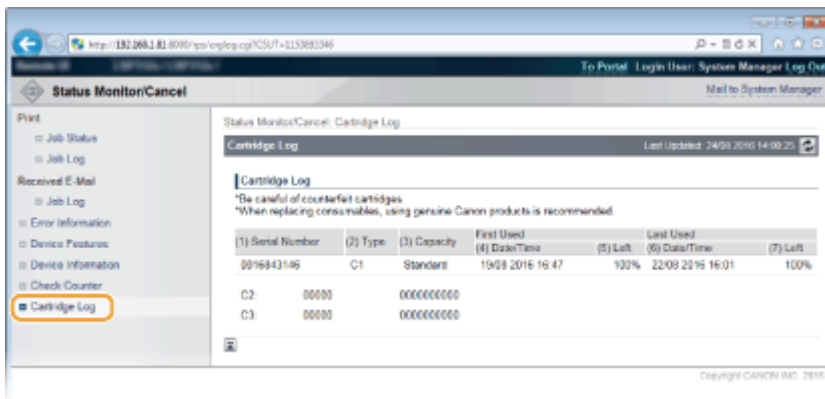

LINKS

[▶ Remote UI Screens\(P. 287\)](#)

Enabling End Users to Operate Documents

51W4-051

You can configure settings so that you can delete or interrupt the documents even when you log on to the Remote UI in General User Mode.

1 Start the Remote UI and log on in Management Mode. ▶ Starting Remote UI(P. 284)

2 Click [Settings/Registration].

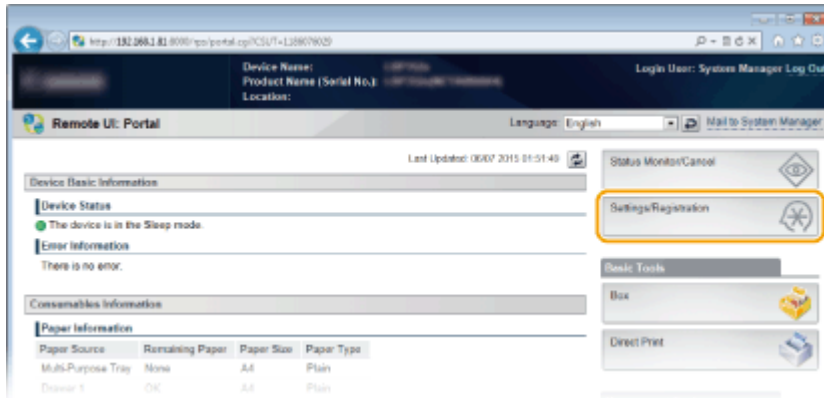

3 Click [Security] ▶ [Management Settings].

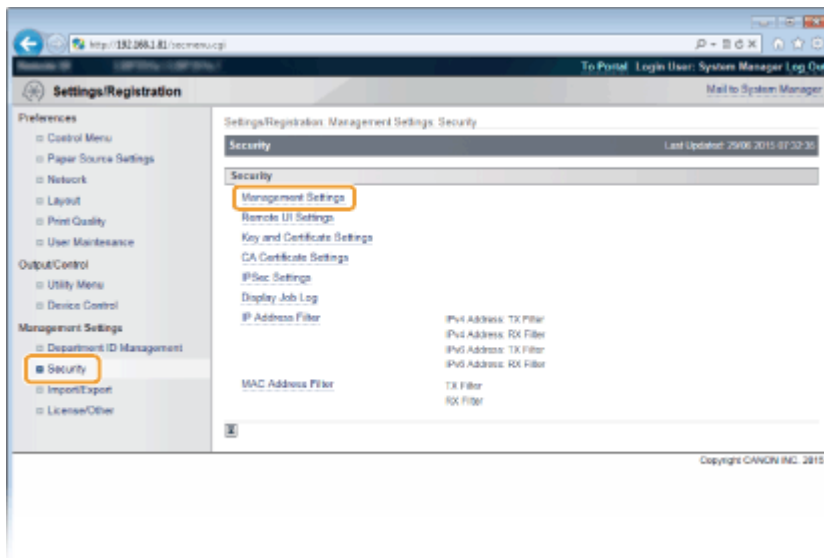

4 Click [Edit].

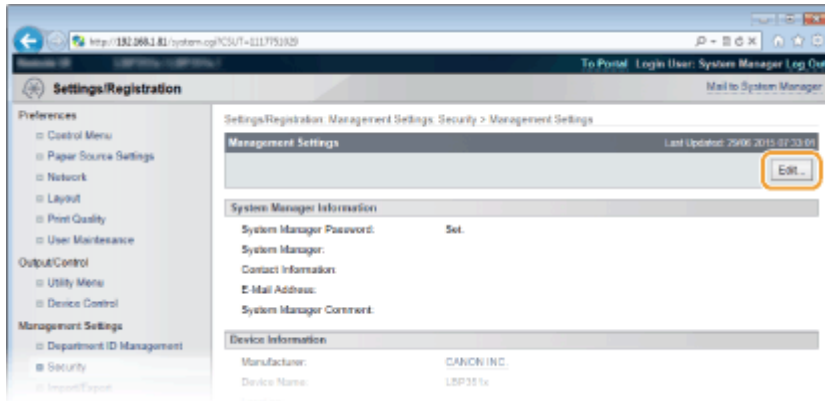

5 Enter the System Manager password in [Current System Manager Password].

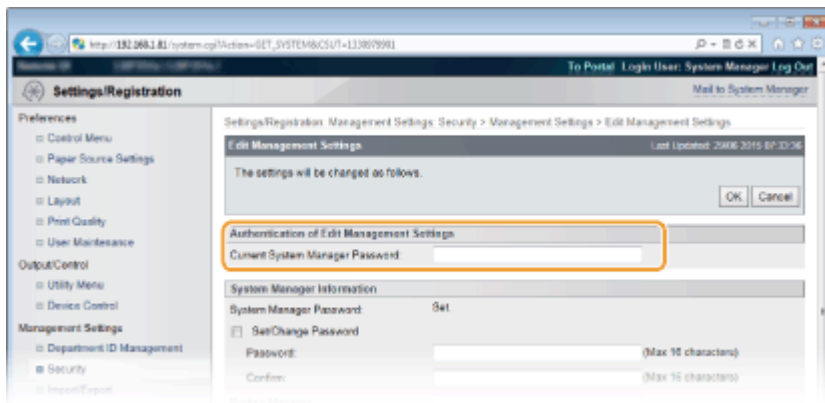

6 Select the [Allow General User Job Operation] check box and click [OK].

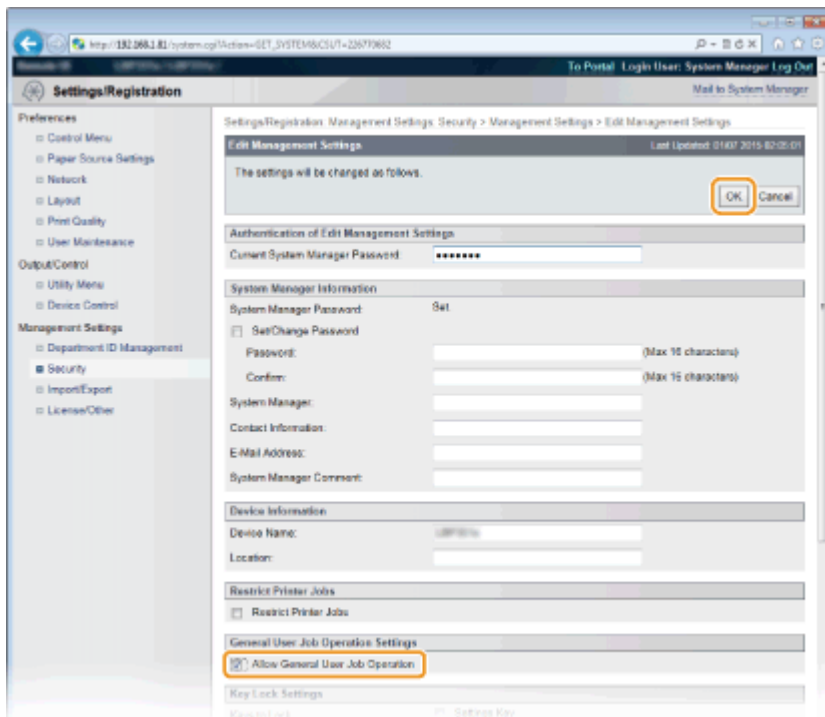

[Allow General User Job Operation]

If you select the check box, general users will be able to operate the documents of which the user name matches the one that was used to log on. When you do not want to allow general users to operate documents, clear the check box.

LINKS

▶ **Remote UI Screens(P. 287)**

Setting Up Menu Options from Remote UI

51W4-052

You can change the various machine settings by using the Remote UI. Most of the settings can be set also on the machine, but some settings can only be set using the Remote UI.

1 Start the Remote UI and log on in Management Mode. ▶Starting Remote UI(P. 284)

2 Click [Settings/Registration].

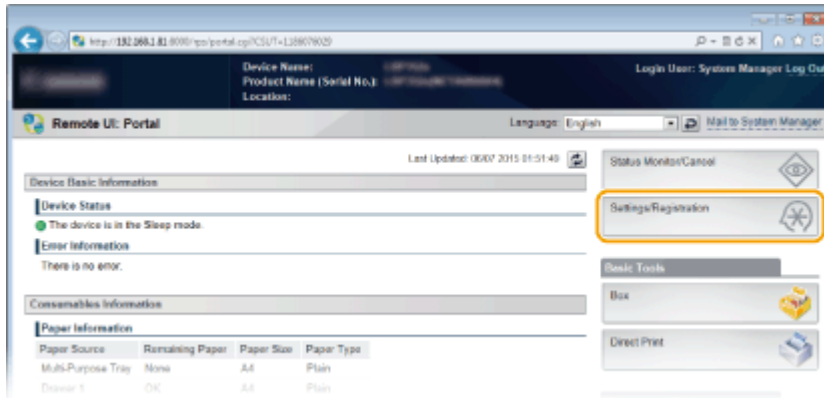

3 Click the menu item you want to set, and click [Edit].

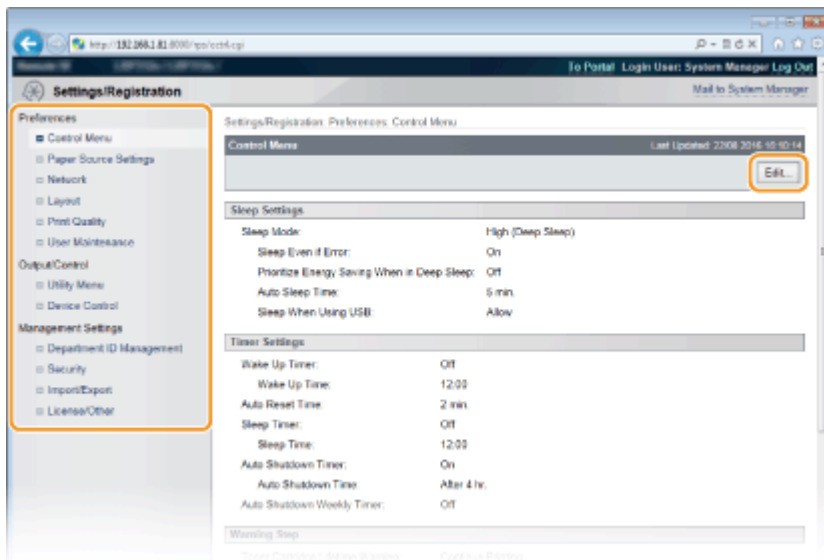

- For more information about the settings menu, see each item below

Menu items	Referents
Preferences	
Control Menu	▶Control Menu(P. 311)
Paper Source Settings	▶Select Feeder Menu(P. 410)
Network	▶Network(P. 326)

Menu items	Referents
Layout	▶ Layout(P. 347)
Print Quality	▶ Print Quality(P. 351)
User Maintenance	▶ User Maintenance(P. 358)
Output/Control	
Utility Menu	▶ Printing Reports and Lists(P. 441) ▶ Job Menu(P. 406)
Device Control	You can control the status of the machine. ▶ Online key(P. 26) ▶ Soft Reset(P. 408) ▶ Entering Sleep Mode(P. 63)
Management Settings	
Department ID Management	▶ Setting the Department ID Management(P. 208)
Security	▶ Security(P. 200)
Import/Export	▶ Saving/Loading Registered Data(P. 303)
License/Other	<ul style="list-style-type: none"> • You can change messages shown on the message board and the link to the support page that are displayed on the Portal Page (main page). • You can register or update software (Function Guide for Software Registration and Update). <p>NOTE:</p> <ul style="list-style-type: none"> • You may not be able to use this function in some countries or regions.

LINKS

▶ **Remote UI Screens(P. 287)**

▶ **Setting Menu List(P. 309)**

Saving/Loading Registered Data

51W4-053

Menu options data that has been registered in the machine can be saved in your computer (export). Data that is saved on your computer can also be registered in the machine (import). Data exported from this machine can be imported to another machine of the same model. So you can easily copy a variety of settings data to multiple machines. To use these features, it is required that you have logged on in Management Mode.

▶ **Saving Registered Data(P. 304)**

▶ **Loading Registered Data(P. 306)**

IMPORTANT

Do not turn OFF the machine until the export/import process is complete

- It may take a few minutes to complete the process. If the machine is turned OFF during the process, it may result in damage to data or the machine.

Do not operate the machine during the export/import process

- Before exporting/importing, check that no operation such as printing documents is currently processing.

NOTE

Import/export using the operation panel

- You can also save/load settings data via a USB memory device by using the operation panel of the machine.
▶ **Import/Export Set.(P. 368)**

Saving Registered Data

51W4-054

You can export machine settings data and save them in your computer. It is recommended that you regularly back up important settings.

1 Start the Remote UI and log on in Management Mode. ▶ Starting Remote UI(P. 284)

2 Click [Settings/Registration].

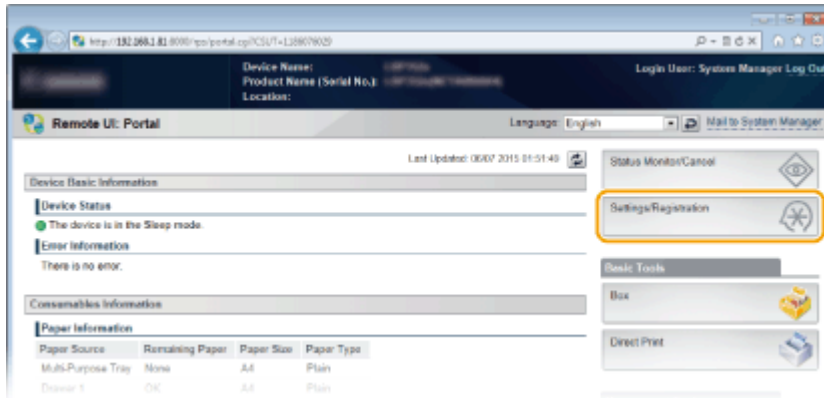

3 Click [Import/Export] ▶ [Export].

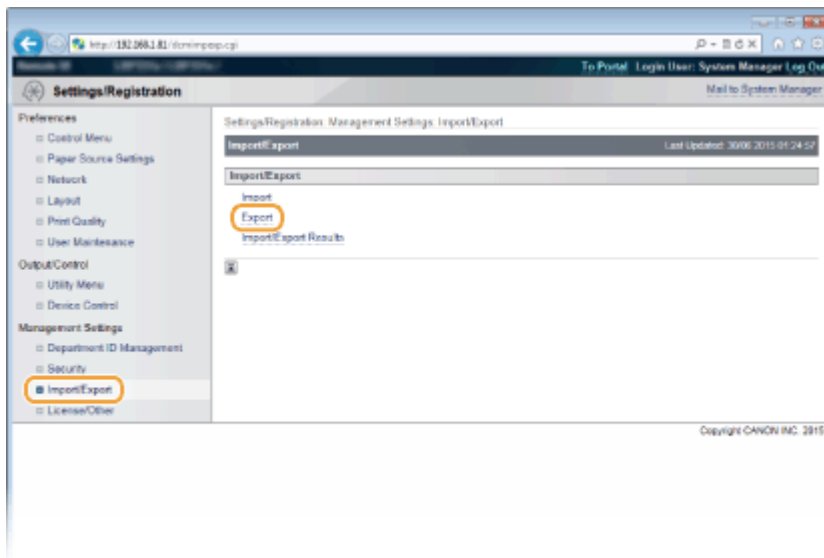

4 Select the settings to export, and set the encryption password.

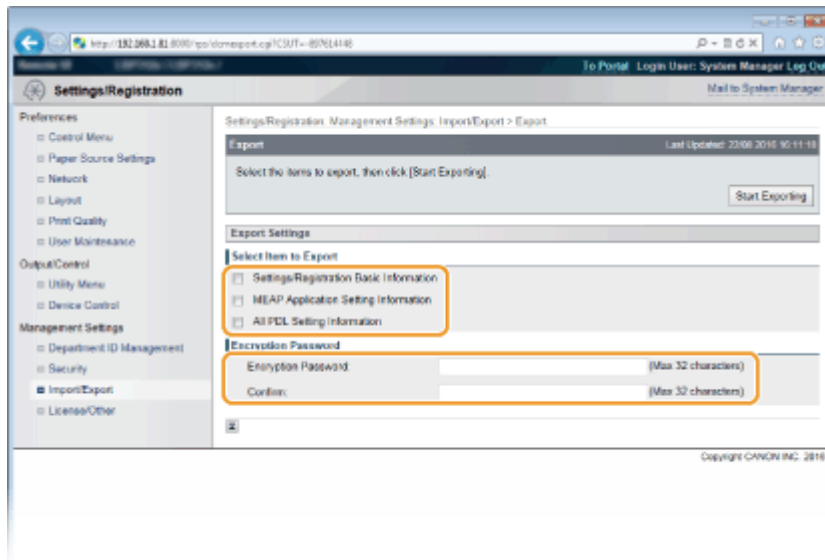

[Settings/Registration Basic Information]

To export the settings data of items that can be set from [Settings/Registration] in the Portal Page, select the check boxes for those items.

[MEAP Application Setting Information]

To export the settings data of MEAP applications, select this check box.

[All PDL Setting Information]

To export the settings data of items that can be set from [▶Settings Specific to Print Mode\(P. 373\)](#) , select this check box.

[Encryption Password]

Enter the password to encrypt data to be exported using characters. Enter the same password in [Confirm]. If no password is set, data exporting is impossible.

NOTE:

- The password is required when exported data is imported. [▶Loading Registered Data\(P. 306\)](#)

5 Click [Start Exporting].

6 Follow the on-screen instructions to specify the location where the exported setting data is saved.

⇒ The setting data will be saved.

LINKS

- ▶[Remote UI Screens\(P. 287\)](#)
- ▶[Setting Menu List\(P. 309\)](#)

Loading Registered Data

51W4-055

Load (import) data that was exported from the machine. You can also import settings from another machine if it is the same model as your machine.

1 Start the Remote UI and log on in Management Mode. ▶ Starting Remote UI(P. 284)

2 Click [Settings/Registration].

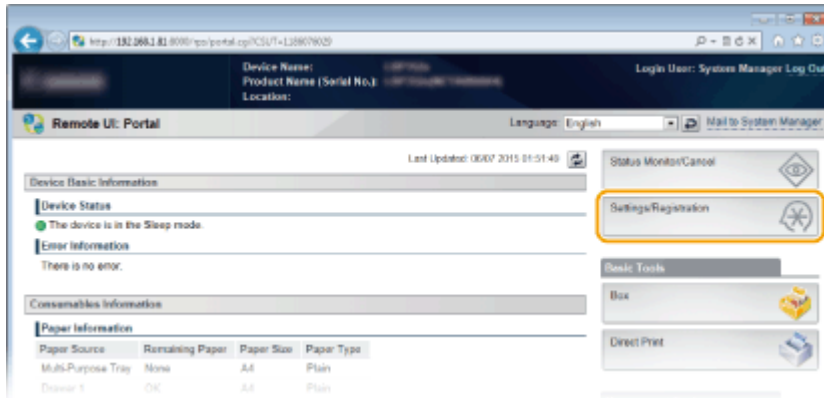

3 Click [Import/Export] ▶ [Import].

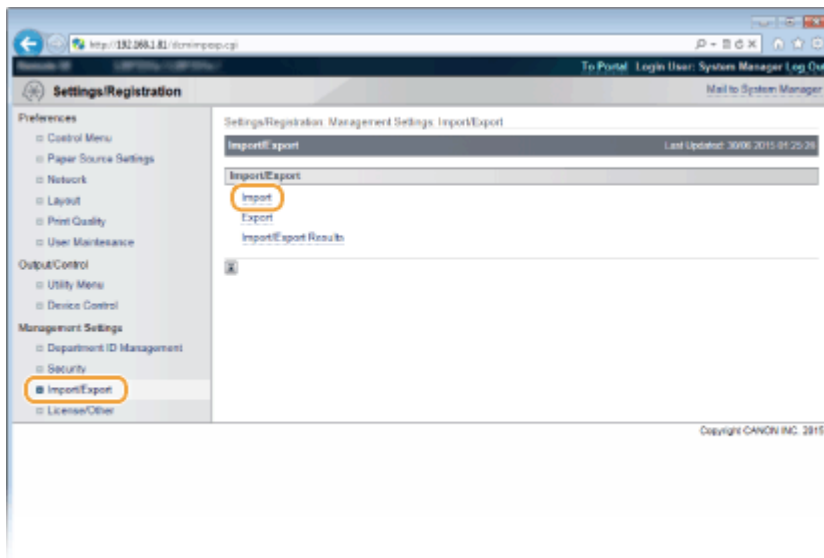

4 Specify the setting file to be imported, and enter the password.

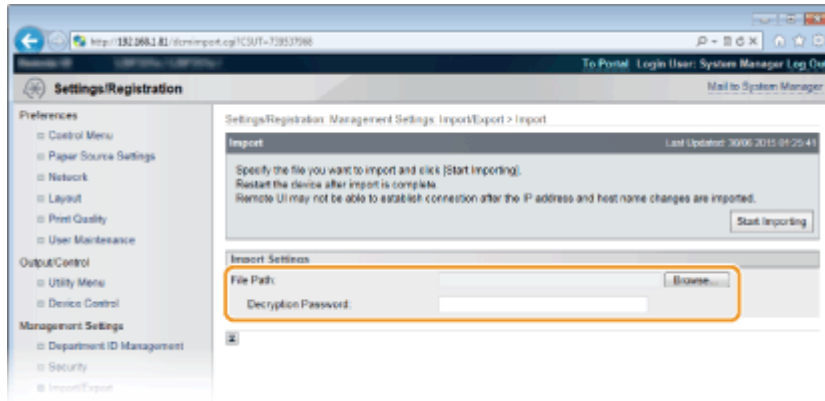
**[File Path]**

Click [Browse] and select the file.

[Decryption Password]

Enter the password set when the settings were exported.

5 Click [Start Importing].**6 Click [OK].**

⇒ The specified setting data will be imported into the machine.

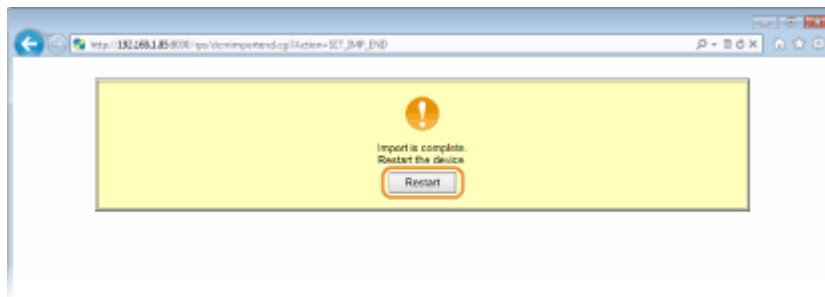
7 Click [Restart].

⇒ The settings are enabled after the machine is restarted.

LINKS

- ▶ Remote UI Screens(P. 287)
- ▶ Setting Menu List(P. 309)

Setting Menu List

Setting Menu List	309
Setup Menu	310
Control Menu	311
Paper Source	325
Network	326
Layout	347
Print Quality	351
Interface	355
User Maintenance	358
Print Mode	371
Settings Specific to Print Mode	373
UFR II	374
PCL	375
Imaging	381
XPS	387
PDF	391
PS	395
MEAP Settings	398
Check Counter	400
Initialize Menu	401
Utility Menu	402
Job Menu	406
Reset Menu	408
Select Feeder Menu	410

Setting Menu List

51W4-056

There are various settings in this machine. You can adjust each of the settings in detail. Specify the settings from the menu screens of the operation panel.

NOTE

Priority of settings

- Settings that are specified on the printer driver will override those specified on the operation panel.
- When you perform USB Direct Print or Direct Print, the settings specified for printing or stored in TIFF data override those specified on the operation panel.

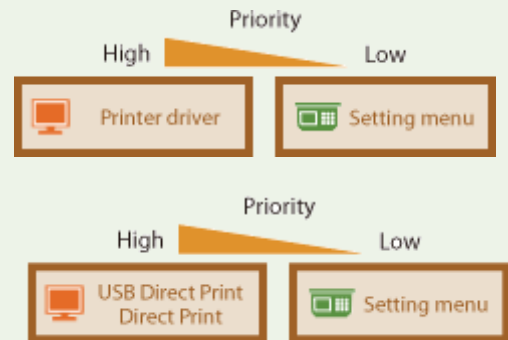

TIPS

- You can print the setting menu in list form to check the current settings:
 - ▶ **Configuration Page(P. 402)**
 - ▶ **Network Status Print(P. 403)**

Setup Menu

51W4-057

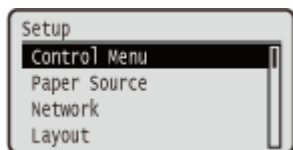

You can specify the settings for the operation environment of the machine and for printing. When you press **▶** () on the operation panel, the Setup menu appears to show the setting items under each function item.

- ▶ **Control Menu(P. 311)**
- ▶ **Paper Source(P. 325)**
- ▶ **Network(P. 326)**
- ▶ **Layout(P. 347)**
- ▶ **Print Quality(P. 351)**
- ▶ **Interface(P. 355)**
- ▶ **User Maintenance(P. 358)**
- ▶ **Print Mode(P. 371)**
- ▶ **Settings Specific to Print Mode(P. 373)**
- ▶ **MEAP Settings(P. 398)**
- ▶ **Check Counter(P. 400)**
- ▶ **Initialize Menu(P. 401)**

Control Menu

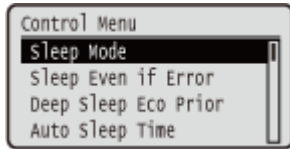

The settings about the sleep mode and how the machine should behave if an error occurs are listed with short descriptions. Default settings are marked with a dagger (†).

NOTE

Asterisks (*)

- Settings marked with an asterisk (*) may not be displayed depending on the model you are using, options, or other setting items.

- | | |
|--------------------------------|--------------------------------|
| ▶ Sleep Mode(P. 311) | ▶ Interrupt Print(P. 319) |
| ▶ Sleep Even if Error(P. 312) | ▶ Sec. Print Del. Time(P. 319) |
| ▶ Deep Sleep Eco Prior(P. 312) | ▶ Secure Job Log(P. 319) |
| ▶ Auto Sleep Time(P. 312) | ▶ USB-Connected PC OS(P. 320) |
| ▶ Sleep When Using USB(P. 312) | ▶ PDL Selection (PnP)(P. 320) |
| ▶ Timer Settings(P. 313) | ▶ Mng. Settings(P. 320) |
| ▶ Auto Skip Error(P. 314) | ▶ RMT-SW(P. 321) |
| ▶ Language(P. 314) | ▶ Adjust Screen(P. 321) |
| ▶ Alarm(P. 315) | ▶ Animated Instruction(P. 322) |
| ▶ Show Warnings(P. 315) | ▶ Show Toner Gauge(P. 322) |
| ▶ Action When Warning(P. 316) | ▶ Set. Comp. Notify(P. 323) |
| ▶ Date/Time Settings(P. 316) | ▶ Check Paper Settings(P. 323) |
| ▶ Main Pwr Quick Start(P. 318) | ▶ Scrolling Speed(P. 323) |
| ▶ SD Card(P. 318) | ▶ Canon Genuine Mode(P. 324) |

Sleep Mode

The sleep mode function reduces the amount of power consumed by the machine by temporarily stopping some internal operations. Specify the sleep mode level. ▶ **Entering Sleep Mode(P. 63)**

High (Deep Sleep) †
Mid (Printer Sleep)

NOTE

Sleep mode levels

- The energy consumption reduction effect is smaller with <Mid (Printer Sleep)> and greater with <High (Deep Sleep)>.

When you are using utility software related to network

- If you set sleep mode to <High (Deep Sleep)>, the utility software may fail in communication.

Sleep Even if Error

Select whether to automatically enter sleep mode when an error occurs.

Off
On[†]

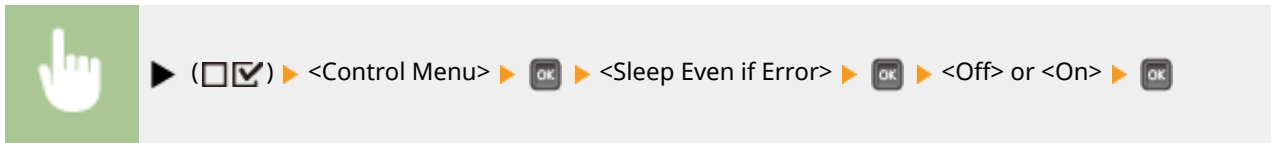

Deep Sleep Eco Prior

Select whether to further reduce power consumption when the machine and the computer are connected via USB.

Off[†]
On

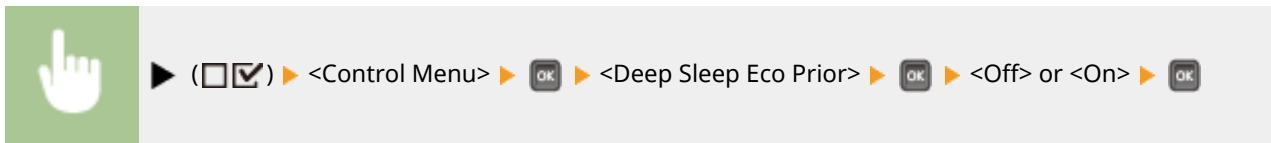

NOTE

- It may be possible that when you do an operation to perform printing with this item set to <On>, the machine does not exit the sleep mode. In that case, press to exit the sleep mode.

Auto Sleep Time

If the machine has not been operated or has had no data to print for a specified period of time, it enters sleep mode to save energy consumption (Auto Sleep). Specify the period of time after which auto sleep is performed. We recommend using the factory default settings to save the most power. ▶ **Entering Sleep Mode(P. 63)**

5 min. [†]
10 min.
15 min.
30 min.
60 min.

Sleep When Using USB^{*}

Select whether to allow the machine to enter sleep mode when you are using USB over NW to access a USB device from a computer via a network. ▶ **Adv. Func. Settings(P. 355)**

Do Not Allow

Allow [†]

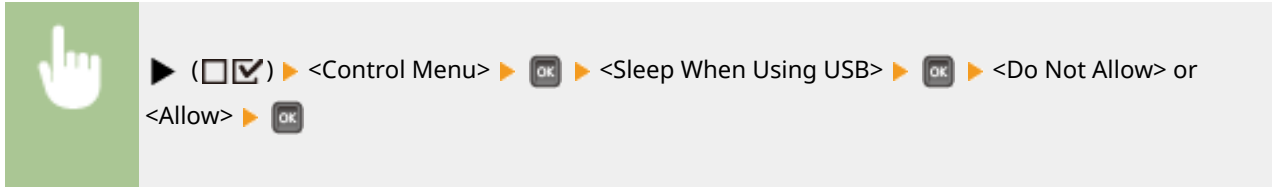

Timer Settings

You can specify the settings for the machine operations and time regarding Sleep Mode and for the Auto Reset function that displays the main screen if any key is not pressed for a specified period of time.

Wake Up Timer

Select whether to automatically exit sleep mode at a specified time. **▶ Entering Sleep Mode(P. 63)**

Off [†]
On

Wake Up Time

Set the time to exit sleep mode if <Wake Up Timer> is set to <On>. **▶ Entering Sleep Mode(P. 63)**

00:00 to 12:00 [†] to 23:59

Auto Reset Time

If any key is not pressed for a specified period of time, the current menu screen automatically returns to the main screen and the machine returns to the online mode (Auto Reset). Specify the interval at which the Auto Reset is performed. Select <Off> to disable the Auto Reset function.

Off
10 sec.
20 sec.
30 sec.
40 sec.
50 sec.
1 min.
2 min. [†]
3 min.
4 min.
5 min.
6 min.
7 min.
8 min.
9 min.

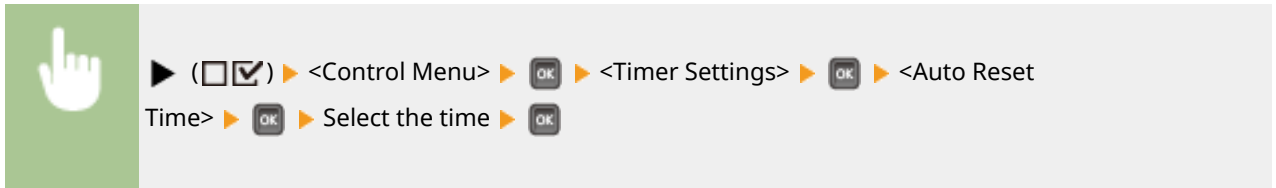

Sleep Timer

Select whether to automatically enter sleep mode at a specified time. **▶ Entering Sleep Mode(P. 63)**

Off [†]
On

Sleep Time

Set the time to enter sleep mode if <Sleep Timer> is set to <On>. **▶ Entering Sleep Mode(P. 63)**

00:00 to 12:00 [†] to 23:59

Auto Skip Error

If an error occurs during printing, the printing is stopped. When you want to continue printing even if an error occurs, specify <On>. For the errors during which the current print job is allowed to continue by this setting, see "Troubleshooting (FAQ)" on the online manual website.

Off [†]
On

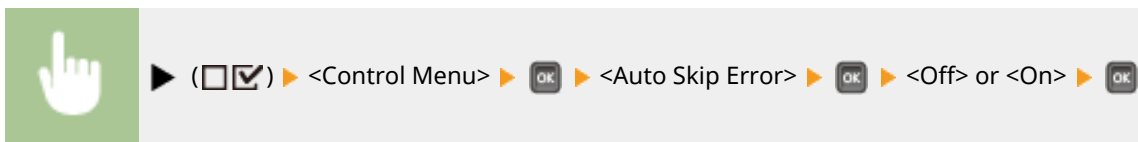

Language

You can change the language displayed on the operation panel screen, login screen of the remote UI, and the setting lists.

Čeština
Dansk
Deutsch
English [†]
Español
Français
Italiano
Magyar
Nederlands
Norsk
Polski
Português
Русский
Suomi
Svenska
Türkçe
中文(简体)
한국어

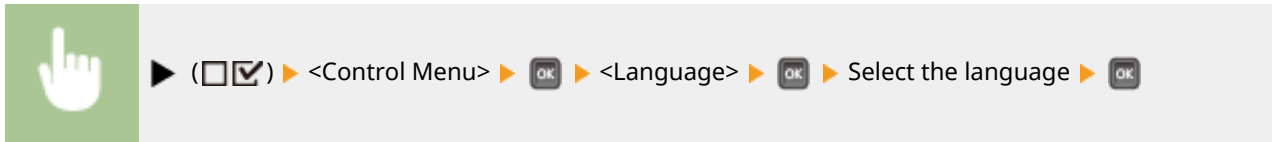

Alarm

Select whether the machine beeps when a problem such as a paper jam or an operation mistake occurs.

Off
On [†]

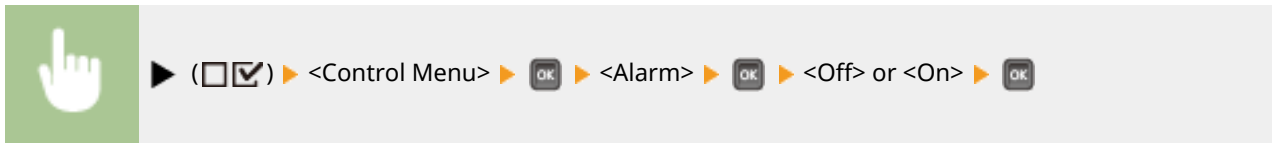

Show Warnings

Select whether to inform about warnings by messages when the machine has entered the warning state.

Chk/Chg. Toner Cart.

Select whether to display an applicable message when the replacement time for the toner cartridge is near.

Off
On [†]

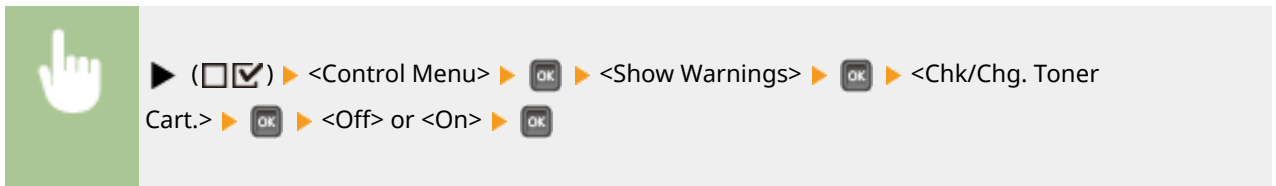

Drawer Empty

Select whether to display an applicable message when the paper drawer runs out of paper.

Off
On [†]

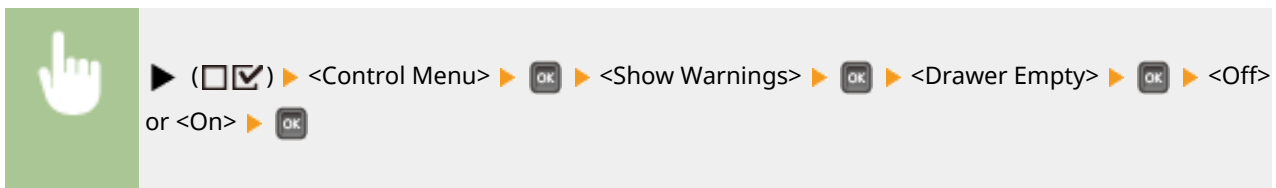

E-Mail Trans. Error

Select whether to display an applicable message when a communication error occurs during E-Mail Print.

Off
On †

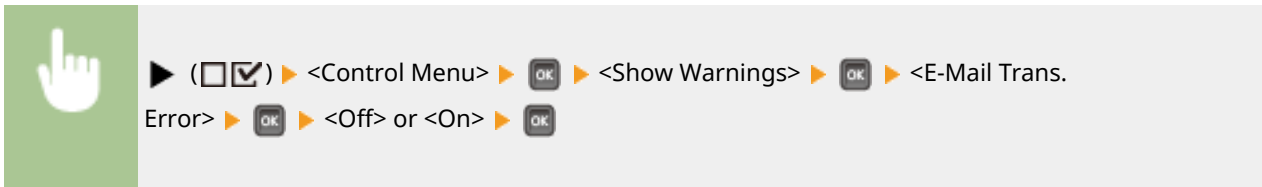

Action When Warning

Specify how the machine should behave when a toner cartridge lifetime message appears.

Chk/Chg. Toner Cart.

Select whether to automatically stop printing when the toner cartridge will soon reach the end of its lifetime.

Continue Printing †
Stop Printing

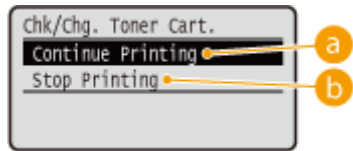
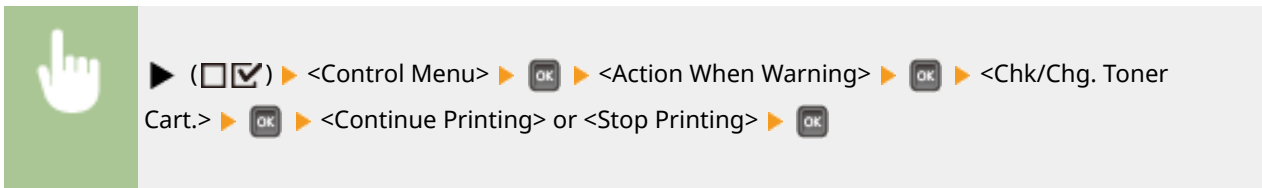

a <Continue Printing>

When the time for toner cartridge replacement is near, the <16 Tnr cart. will soon reach end of lifetime.> message is displayed, but the printing is continued.

b <Stop Printing>

When the time for toner cartridge replacement is near, the <Toner cartridge will soon reach end of lifetime.> message is displayed, and the printing is temporarily stopped. To resume the printing, press



Date/Time Settings

Set the current date and time.

Date

Set the current date in the order of Year, Month, and Day. Use ◀ / ▶ to move the cursor, and use the numeric keys to specify the date.

01/01 2001 to 31/12 2030



▶ () ▶ <Control Menu> ▶ ▶ <Date/Time Settings> ▶ ▶ <Date> ▶ ▶ Set the date ▶

Time (24 hour)

Specify the current time on a 24-hour basis. Use ◀ / ▶ to move the cursor, and use the numeric keys to specify the time.

00:00:00 to 23:59:59



▶ () ▶ <Control Menu> ▶ ▶ <Date/Time Settings> ▶ ▶ <Time (24 hour)> ▶ ▶ Set the time ▶

Daylight Savings

Specify settings for daylight saving time.

DST Settings

Specifies whether to set the daylight saving time.

Off
On +



▶ () ▶ <Control Menu> ▶ ▶ <Date/Time Settings> ▶ ▶ <Daylight Savings> ▶ ▶ Check the message ▶ ▶ <DST Settings> ▶ ▶ <Off> or <On> ▶ ▶ Perform a hard Reset ( **Performing a Hard Reset(P. 408)**)

Start Date/Time

Specifies the start date and time of daylight saving time.

Month
Week
Day
Time (24 hour)



▶ () ▶ <Control Menu> ▶ ▶ <Date/Time Settings> ▶ ▶ <Daylight Savings> ▶ ▶ Check the message ▶ ▶ <Start Date/Time> ▶ ▶ Set the date and time ▶ ▶ Perform a hard Reset (▶ **Performing a Hard Reset(P. 408)**)

End Date/Time

Specifies the end date and time of daylight saving time.

Month
Week
Day
Time (24 hour)



▶ () ▶ <Control Menu> ▶ ▶ <Date/Time Settings> ▶ ▶ <Daylight Savings> ▶ ▶ Check the message ▶ ▶ <End Date/Time> ▶ ▶ Set the date and time ▶ ▶ Perform a hard reset (▶ **Performing a Hard Reset(P. 408)**)

Time Zone

Specifies the time zone according to the region where the machine is being used.

GMT-12:00 to GMT 00:00 ⁺ to GMT+12:00



▶ () ▶ <Control Menu> ▶ ▶ <Date/Time Settings> ▶ ▶ <Time Zone> ▶ ▶ Check the message ▶ ▶ Set the time zone ▶ ▶ Perform a hard reset (▶ **Performing a Hard Reset(P. 408)**)

Main Pwr Quick Start

If you specify the quick startup settings, you can reduce the time from when the power switch is pressed until the screens become operable. ▶ **Performing a Quick Start of the Machine(P. 37)**

Off ⁺
On

SD Card *

Enable or disable the SD card.

Off
On ⁺



▶ () ▶ <Control Menu> ▶ ▶ <SD Card> ▶ ▶ Check the message ▶ ▶ <Off> or <On> ▶ ▶ Perform a hard reset ( **Performing a Hard Reset(P. 408)**)

Interrupt Print *

Select whether to allow use of the Interrupt Print function.

Off
On [†]



▶ () ▶ <Control Menu> ▶ ▶ <Interrupt Print> ▶ ▶ <Off> or <On> ▶

Sec. Print Del. Time *

Set the time until secured documents stored in the machine are automatically deleted.  **Changing the Valid Time Period for Secured Documents(P. 90)**

1 hr. [†]
2 hr.
3 hr.
6 hr.
12 hr.
24 hr.

Secure Job Log *

Depending on the timing of shutdown, a print log may not be generated and the total number of printed pages may not be counted. If you set this function to <On>, print log generation and total printed page counting are surely performed. However, the print speed will be slower.

Off [†]
On



▶ () ▶ <Control Menu> ▶ ▶ <Secure Job Log> ▶ ▶ Check the message ▶ ▶ <Off> or <On> ▶ ▶ Perform a hard reset ( **Performing a Hard Reset(P. 408)**)

USB-Connected PC OS

Select the OS of the PC connecting to the machine via USB.

Mac OS [†]
Windows
Other

IMPORTANT

- Be sure to match the machine settings to the OS of the PC. If not matched, the PC will not correctly recognize the machine.
- If the OS of your computer is OS X 10.10 or earlier and if you want to print from a printer driver via USB, set this item to <Other>.



▶ () ▶ <Control Menu> ▶ ▶ <USB-Connected PC OS> ▶ ▶ Check the message ▶ ▶ Select the OS of the computer to connect to the machine ▶ ▶ Perform a hard reset (**Performing a Hard Reset(P. 408)**)

PDL Selection (PnP)

Specify a printer driver to be installed when the machine is connected to a computer via USB or it is searched over the WSD network.

UFR II [†]
UFR II (V4)
PCL6
PCL6 (V4)
PS3
XPS (Direct)



▶ () ▶ <Control Menu> ▶ ▶ <PDL Selection (PnP)> ▶ ▶ Check the message ▶ ▶ Select the page description language ▶ ▶ Perform a hard reset (**Performing a Hard Reset(P. 408)**)

Mng. Settings

Select whether to restrict the use of the ▶ () key on the operation panel to prevent any settings from being changed carelessly.

Settings Key Lock

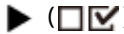
If you select <On>, the Setup menu is not operable even if  is pressed.

Off [†]
On

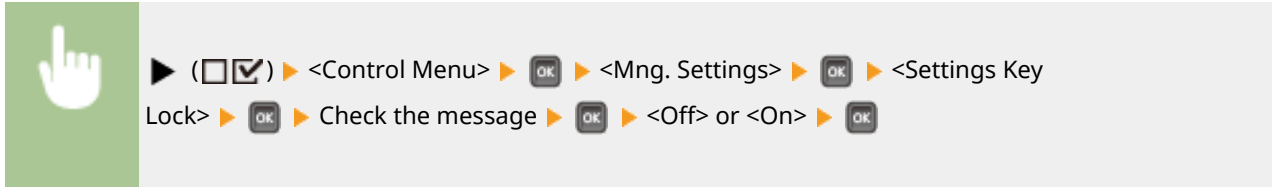

NOTE

- If you select <On>, the Settings key can be unlocked from the Remote UI only.  **Restricting Operation Panel Functions(P. 237)**

RMT-SW

Use this machine leaving this item set to <Off>. You may be asked to change the setting to <On> to allow for remote maintenance on your machine by a Canon service representative.

Off [†]
On



Adjust Screen

You can adjust the contrast and brightness of the display.

Contrast

Adjust the contrast (difference in brightness between light and dark areas) of the display to suit the installation location of the machine.

-3 to 0 [†] to +3

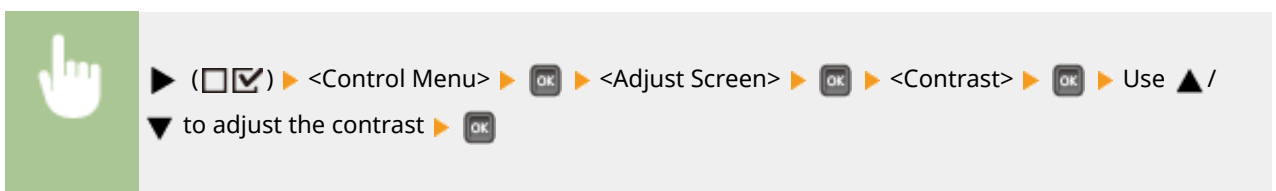

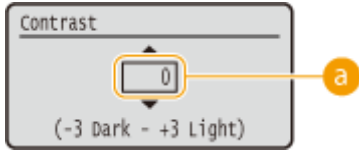

a Adjusting the contrast

Set a "+" value to brighten the screen. Set a "-" value to darken the screen.

Backlight Brightness

Adjust the backlight brightness of the display by selecting from three levels. Select <Off> to disable the backlight.

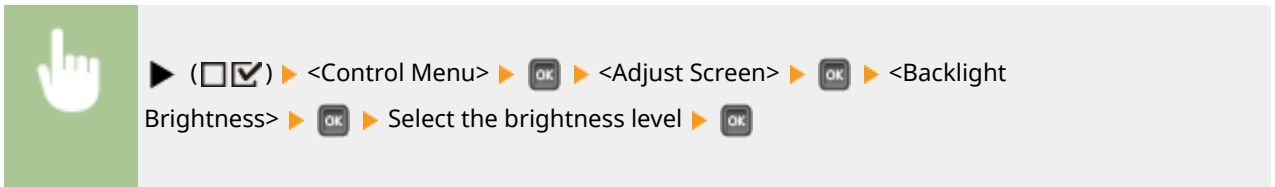

Animated Instruction

Select whether to show animated instructions on the display when a paper jam occurs or when you replace toner cartridges.

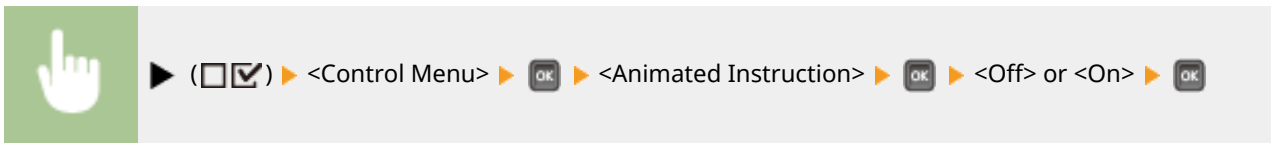

Show Toner Gauge

Select whether to display the toner cartridge status indicator icon in the lower right of the display.

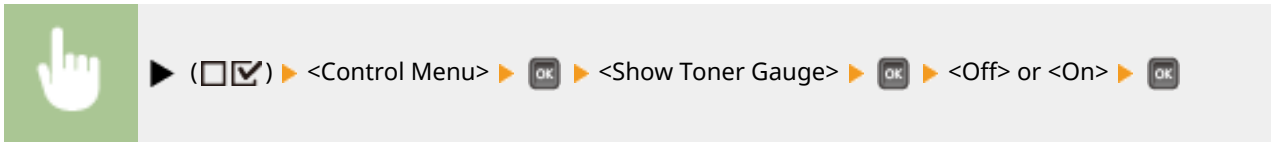

Set. Comp. Notify

Specify how long a message that appears when a setting is changed is displayed in seconds. If you select <Off>, the message will no longer be displayed.



Settings changed.

Off
1 sec.
2 sec.
3 sec. [†]



Check Paper Settings

Select whether to display a message prompting you to check the paper settings when you set a paper drawer.

Off
On [†]

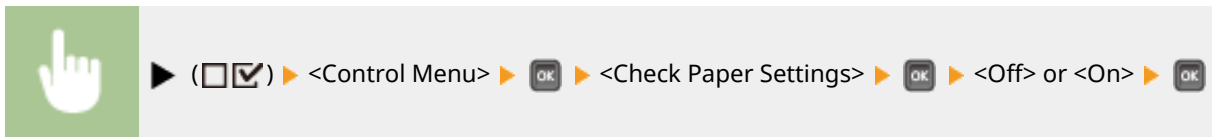

Scrolling Speed

Adjust the speed for scrolling characters from the right to the left on the display by selecting from three levels.

Slow
Normal [†]
Fast

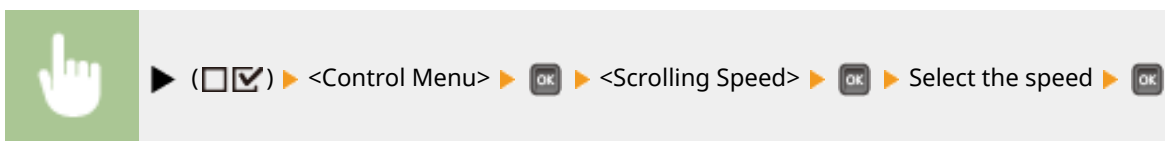

Canon Genuine Mode

The mode for when Canon genuine toner cartridges are used.

Off[†]
On

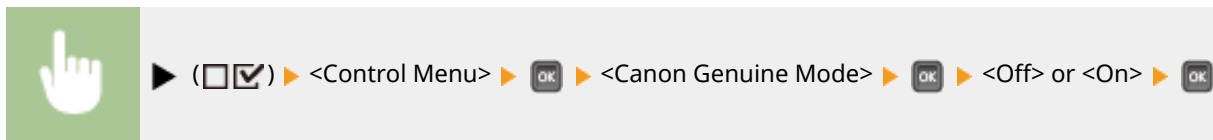

NOTE

- When necessary, the service representative may change the setting. If this item is not displayed, contact the administrator of the machine.

Paper Source

51W4-059

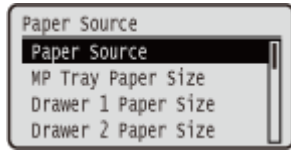

See [▶Select Feeder Menu\(P. 410\)](#) .

Network

51W4-05A

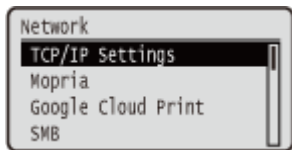

All the settings about the network are listed with short descriptions. Default settings are marked with a dagger (†).

NOTE

If <Network> is not displayed

- If <Network> under <Interface Selection> is set to <Off>, <Network> is not displayed in the Setup menu. ▶ **Interface Selection(P. 355)**

Asterisks (*)

- Settings marked with an asterisk (*) may not be displayed depending on the model you are using, options, or other setting items.

- | | |
|---------------------------------------|---------------------------------------|
| ▶ TCP/IP Settings(P. 326) | ▶ Software Regist/Updt(P. 342) |
| ▶ Mopria(P. 337) | ▶ Ethernet Driver(P. 342) |
| ▶ Google Cloud Print(P. 338) | ▶ Sleep Mode Priority(P. 343) |
| ▶ SMB(P. 338) | ▶ IEEE802.1X(P. 343) |
| ▶ SNMP Settings(P. 339) | ▶ Address Filter(P. 344) |
| ▶ Spooler(P. 340) | ▶ MAC Address(P. 344) |
| ▶ Receive in Parallel(P. 341) | ▶ E-Mail Print Set.(P. 344) |
| ▶ Wait Time at Startup(P. 341) | ▶ Monitoring Service(P. 345) |
| ▶ Remote UI Settings(P. 341) | ▶ Init. Network Set.(P. 346) |

TCP/IP Settings

Specify settings for using the machine in a TCP/IP network, such as IP address settings.

IPv4 Settings

Specify settings for using the machine in an IPv4 network.

IPv4

Enable or disable IPv4 in the machine.

Off

On †

▶ () ▶ <Network> ▶ ▶ Check the message ▶ ▶ <TCP/IP Settings> ▶ ▶ <IPv4 Settings> ▶ ▶ <IPv4> ▶ ▶ <Off> or <On> ▶ ▶ Perform a hard reset (▶ **Performing a Hard Reset(P. 408)**)

IP Mode

Select how to set the IP address. [▶Setting IPv4 Address\(P. 140\)](#)

Auto †
Manual

Protocol *

Select the protocol to use when <IP Mode> is set to <Auto>. If you set the selected protocol to <On>, the other two protocols are automatically set to <Off>. [▶Setting IPv4 Address\(P. 140\)](#)

Use DHCP

Off
On †

Use BOOTP

Off †
On

Use RARP

Off †
On

Auto IP *

Select whether to automatically obtain an IP address. Specify <On> when <IP Mode> is set to <Auto>. [▶Setting IPv4 Address\(P. 140\)](#)

Off
On †

IP Address Settings

Configure the IP address, which is used for identifying devices, such as computers and printers, on a TCP/IP network. [▶Setting IPv4 Address\(P. 140\)](#)

IP Address

0.0.0.0 † to 255.255.255.255

Subnet Mask

0.0.0.0 † to 255.255.255.255

Gateway Address

0.0.0.0 † to 255.255.255.255

DNS

Specify settings for the server address of the Domain Name System (DNS), which provides a host name for IP address resolutions. Use ◀ / ▶ to move the cursor, and use the numeric keys to specify the address. Use the Remote UI to specify other settings for DNS. [▶Configuring DNS\(P. 172\)](#)

Primary Address

0.0.0.0 † to 255.255.255.255

Secondary Address

0.0.0.0 † to 255.255.255.255



▶ () ▶ <Network> ▶ ▶ Check the message ▶ ▶ <TCP/IP Settings> ▶ ▶ <IPv4 Settings> ▶ ▶ <DNS> ▶ ▶ Select the server to configure ▶ ▶ Set the address ▶ ▶ Perform a hard reset ( **Performing a Hard Reset(P. 408)**)

mDNS Settings *

Specify settings for using DNS functions without DNS servers.  **Configuring DNS(P. 172)**

mDNS

Off
On †



▶ () ▶ <Network> ▶ ▶ Check the message ▶ ▶ <TCP/IP Settings> ▶ ▶ <IPv4 Settings> ▶ ▶ <mDNS Settings> ▶ ▶ <mDNS> ▶ ▶ <Off> or <On> ▶ ▶ Perform a hard reset ( **Performing a Hard Reset(P. 408)**)

mDNS Name *

When <mDNS> is set to <On>, set this item.



▶ () ▶ <Network> ▶ ▶ Check the message ▶ ▶ <TCP/IP Settings> ▶ ▶ <IPv4 Settings> ▶ ▶ <mDNS Settings> ▶ ▶ <mDNS Name> ▶ ▶ Set the name ▶ ▶ Perform a hard reset ( **Performing a Hard Reset(P. 408)**)

DHCP Option

When DHCP is enabled, select whether to acquire the host name and whether to perform dynamic update of the DNS using the DHCP options.

Acquire Host Name

Off
On †

DNS Dynamic Update

Off †
On



▶ () ▶ <Network> ▶ ▶ Check the message ▶ ▶ <TCP/IP Settings> ▶ ▶ <IPv4 Settings> ▶ ▶ <DHCP Option> ▶ ▶ <Acquire Host Name> or <DNS Dynamic Update> ▶ ▶ <Off> or <On> ▶ ▶ Perform a hard reset (▶ **Performing a Hard Reset(P. 408)**)

IPv6 Settings

Select whether to use the machine in an IPv6 network. Use the Remote UI to specify the IPv6 address settings.
 ▶ **Setting IPv6 Addresses(P. 144)**

IPv6

Enable or disable IPv6 in the machine.

Off ⁺

On



▶ () ▶ <Network> ▶ ▶ Check the message ▶ ▶ <TCP/IP Settings> ▶ ▶ <IPv6 Settings> ▶ ▶ <IPv6> ▶ ▶ <Off> or <On> ▶ ▶ Perform a hard reset (▶ **Performing a Hard Reset(P. 408)**)

mDNS Settings *

Specify settings for using DNS functions without DNS servers. ▶ **Configuring DNS(P. 172)**

mDNS

Off

On ⁺



▶ () ▶ <Network> ▶ ▶ Check the message ▶ ▶ <TCP/IP Settings> ▶ ▶ <IPv6 Settings> ▶ ▶ <mDNS Settings> ▶ ▶ <mDNS> ▶ ▶ <Off> or <On> ▶ ▶ Perform a hard reset (▶ **Performing a Hard Reset(P. 408)**)

Use IPv4 Name (mDNS) *

Off

On ⁺



▶ () ▶ <Network> ▶ ▶ Check the message ▶ ▶ <TCP/IP Settings> ▶ ▶ <IPv6 Settings> ▶ ▶ <mDNS Settings> ▶ ▶ <Use IPv4 Name (mDNS)> ▶ ▶ <Off> or <On> ▶ ▶ Perform a hard reset (▶ **Performing a Hard Reset(P. 408)**)

mDNS Name *

When <Use IPv4 Name (mDNS)> is set to <Off>, set this item.



▶ () ▶ <Network> ▶ ▶ Check the message ▶ ▶ <TCP/IP Settings> ▶ ▶ <IPv6 Settings> ▶ ▶ <mDNS Settings> ▶ ▶ <mDNS Name> ▶ ▶ Set the name ▶ ▶ Perform a hard reset (▶ **Performing a Hard Reset(P. 408)**)

WINS Resolution

Select whether to use Windows Internet Name Service (WINS), which provides a NetBIOS name for IP address resolutions in a mixed network environment of NetBIOS and TCP/IP. Use the Remote UI to specify detailed settings that are applied when WINS is enabled. ▶ **Configuring WINS(P. 178)**

Off [†]

On



▶ () ▶ <Network> ▶ ▶ Check the message ▶ ▶ <TCP/IP Settings> ▶ ▶ <WINS Resolution> ▶ ▶ <Off> or <On> ▶ ▶ Perform a hard reset (▶ **Performing a Hard Reset(P. 408)**)

FTP

Select whether to change the settings for printing and those configured in the machine from FTP.

FTP Print

Select whether to print from FTP. Use the Remote UI to set the user name and password that are used to print from FTP. ▶ **Preparing for Using the FTP Server(P. 509)**

Off [†]

On



▶ () ▶ <Network> ▶ ▶ Check the message ▶ ▶ <TCP/IP Settings> ▶ ▶ <FTP> ▶ ▶ <FTP Print> ▶ ▶ <Off> or <On> ▶ ▶ Perform a hard reset (▶ **Performing a Hard Reset(P. 408)**)

Allow Set. via FTP

Select whether to change the settings configured in the machine from FTP.

Off +
On



▶ () ▶ <Network> ▶ ▶ Check the message ▶ ▶ <TCP/IP Settings> ▶ ▶ <FTP> ▶ ▶ <Allow Set. via FTP> ▶ ▶ <Off> or <On> ▶ ▶ Perform a hard reset (▶ **Performing a Hard Reset(P. 408)**)

LPD Settings

Enable or disable LPD, a printing protocol that can be used on any hardware platform or operating system. Also, set the time period after which the print job automatically ends when print data cannot be received due to a communication error or some other problem. Use the Remote UI to specify settings for banner page printing when LPD is enabled. ▶ **Configuring Printing Protocols and WSD Functions(P. 149)**

LPD Print

Off
On +



▶ () ▶ <Network> ▶ ▶ Check the message ▶ ▶ <TCP/IP Settings> ▶ ▶ <LPD Settings> ▶ ▶ <LPD Print> ▶ ▶ <Off> or <On> ▶ ▶ Perform a hard reset (▶ **Performing a Hard Reset(P. 408)**)

RX Timeout *

1 to 60 + (min.)



▶ () ▶ <Network> ▶ ▶ Check the message ▶ ▶ <TCP/IP Settings> ▶ ▶ <LPD Settings> ▶ ▶ <RX Timeout> ▶ ▶ Set Timeout Time ▶ ▶ Perform a hard reset (▶ **Performing a Hard Reset(P. 408)**)

RAW Settings

Enable or disable RAW, a Windows specific printing protocol. Also, set the time period after which the print job automatically ends when print data cannot be received due to a communication error or some other problem. Use the Remote UI to specify settings for bidirectional communication. ▶ **Configuring Printing Protocols and WSD Functions(P. 149)**

RAW Print

Off

On ⁺



▶ () ▶ <Network> ▶ ▶ Check the message ▶ ▶ <TCP/IP Settings> ▶ ▶ <RAW Settings> ▶ ▶ <RAW Print> ▶ ▶ <Off> or <On> ▶ ▶ Perform a hard reset ()
Performing a Hard Reset(P. 408))

RX Timeout *

1 to 60 ⁺ (min.)



▶ () ▶ <Network> ▶ ▶ Check the message ▶ ▶ <TCP/IP Settings> ▶ ▶ <RAW Settings> ▶ ▶ <RX Timeout> ▶ ▶ Set Timeout Time ▶ ▶ Perform a hard reset ()
Performing a Hard Reset(P. 408))

IPP Print

Enable or disable IPP, which enables printing from an external network via Internet. Use the Remote UI to specify settings for TLS encryption of data to send and user authentication. **Configuring Printing Protocols and WSD Functions(P. 149)**

Off
 On ⁺



▶ () ▶ <Network> ▶ ▶ Check the message ▶ ▶ <TCP/IP Settings> ▶ ▶ <IPP Print> ▶ ▶ <Off> or <On> ▶ ▶ Perform a hard reset () **Performing a Hard Reset(P. 408))**

WSD

Enable or disable automatic browsing and acquiring information for the machine by using the WSD protocol. **Configuring Printing Protocols and WSD Functions(P. 149)**

WSD Print

Select whether to print with the machine by using WSD.

Off
 On ⁺



▶ () ▶ <Network> ▶ ▶ Check the message ▶ ▶ <TCP/IP Settings> ▶ ▶ <WSD> ▶ ▶ <WSD Print> ▶ ▶ <Off> or <On> ▶ ▶ Perform a hard reset (▶ **Performing a Hard Reset(P. 408)**)

WSD Browsing *

Select whether to acquire information of the machine from a computer by using WSD. If <WSD Print> is set to <On>, <WSD Browsing> is fixed to <On> and is not displayed in the setting menu.

Off
On ⁺



▶ () ▶ <Network> ▶ ▶ Check the message ▶ ▶ <TCP/IP Settings> ▶ ▶ <WSD> ▶ ▶ <WSD Browsing> ▶ ▶ <Off> or <On> ▶ ▶ Perform a hard reset (▶ **Performing a Hard Reset(P. 408)**)

Multicast Discovery

Select whether to set the machine to reply to multicast discovery messages.

Off
On ⁺



▶ () ▶ <Network> ▶ ▶ Check the message ▶ ▶ <TCP/IP Settings> ▶ ▶ <WSD> ▶ ▶ <Multicast Discovery> ▶ ▶ <Off> or <On> ▶ ▶ Perform a hard reset (▶ **Performing a Hard Reset(P. 408)**)

NOTE

- If <Multicast Discovery> is set to <Off>, the machine stays in sleep mode even when multicast discovery messages are flowing on the network.

HTTP

Enable or disable HTTP. HTTP is required for communications with a computer, such as when using the Remote UI and performing WSD printing. ▶ **Disabling HTTP Communication(P. 240)**

Off
On ⁺

Proxy Settings

Specify settings for using the proxy server that relays HTTP communications. ▶ **Setting a Proxy(P. 226)**

Proxy

Enable or disable the proxy server when the machine performs HTTP communications.

Off [†]
On



▶ () ▶ <Network> ▶ ▶ Check the message ▶ ▶ <TCP/IP Settings> ▶ ▶ <Proxy Settings> ▶ ▶ <Proxy> ▶ ▶ <Off> or <On> ▶ ▶ Perform a hard reset (▶ **Performing a Hard Reset(P. 408)**)

Server Address *

Set the address of the proxy server to use. Specify the IP address, domain name, and other necessary information that suit your operational environment. Use ◀ / ▶ to move the cursor, and use the numeric keys to enter the address (▶ **Entering Text(P. 33)**).



▶ () ▶ <Network> ▶ ▶ Check the message ▶ ▶ <TCP/IP Settings> ▶ ▶ <Proxy Settings> ▶ ▶ <Server Address> ▶ ▶ Enter the server address ▶ ▶ Perform a hard reset (▶ **Performing a Hard Reset(P. 408)**)

Port Number *

Specify the port number of the proxy server to use.

1 to 80 [†] to 65535



▶ () ▶ <Network> ▶ ▶ Check the message ▶ ▶ <TCP/IP Settings> ▶ ▶ <Proxy Settings> ▶ ▶ <Port Number> ▶ ▶ Enter the port number ▶ ▶ Perform a hard reset (▶ **Performing a Hard Reset(P. 408)**)

Same Domain *

Enable or disable the proxy server even for performing HTTP communications with devices in the same domain.

Use Proxy
Do Not Use Proxy [†]



▶ () ▶ <Network> ▶ ▶ Check the message ▶ ▶ <TCP/IP Settings> ▶ ▶ <Proxy Settings> ▶ ▶ <Same Domain> ▶ ▶ <Use Proxy> or <Do Not Use Proxy> ▶ ▶ Perform a hard reset (▶ **Performing a Hard Reset(P. 408)**)

Proxy Authentication *

Enable or disable the authentication function of the proxy server.

Off [†]
On



▶ () ▶ <Network> ▶ ▶ Check the message ▶ ▶ <TCP/IP Settings> ▶ ▶ <Proxy Settings> ▶ ▶ <Proxy Authentication> ▶ ▶ <Off> or <On> ▶ ▶ Perform a hard reset (▶ **Performing a Hard Reset(P. 408)**)

User Name *

To enable the proxy authentication, enter up to 24 alphanumeric characters for the user name to authenticate. Use the numeric keys to enter the user name. (▶ **Entering Text(P. 33)**)



▶ () ▶ <Network> ▶ ▶ Check the message ▶ ▶ <TCP/IP Settings> ▶ ▶ <Proxy Settings> ▶ ▶ <User Name> ▶ ▶ Enter the user name ▶ ▶ Perform a hard reset (▶ **Performing a Hard Reset(P. 408)**)

Password *

To set the password for the proxy authentication, enter up to 24 alphanumeric characters. Use the numeric keys to enter the password. (▶ **Entering Text(P. 33)**)



▶ () ▶ <Network> ▶ ▶ Check the message ▶ ▶ <TCP/IP Settings> ▶ ▶ <Proxy Settings> ▶ ▶ <Password> ▶ ▶ Enter the password ▶ ▶ Perform a hard reset (▶ **Performing a Hard Reset(P. 408)**)

SNTP

Select whether to acquire time from a network time server. Use the Remote UI to specify the server address settings. ▶ **Configuring SNTP(P. 181)**

Off [†]
On



▶ () ▶ <Network> ▶ ▶ Check the message ▶ ▶ <TCP/IP Settings> ▶ ▶ <SNTP> ▶ ▶ <Off> or <On> ▶ ▶ Perform a hard reset (▶ **Performing a Hard Reset(P. 408)**)

Discovery Response

Select whether to set the machine to respond to multicast discovery packets on the network. Use the Remote UI to specify the scope name that is used to include the machine into a specific scope. ▶ **Configuring Settings for Device Management Software(P. 190)**

Off
On [†]



▶ () ▶ <Network> ▶ ▶ Check the message ▶ ▶ <TCP/IP Settings> ▶ ▶ <Discovery Response> ▶ ▶ <Off> or <On> ▶ ▶ Perform a hard reset (▶ **Performing a Hard Reset(P. 408)**)

IPSec

Select whether to perform encrypted communication by establishing a virtual private network (VPN) via IPSec. Use the Remote UI to register and specify the security policies. ▶ **Configuring IPSec Settings(P. 251)**

Off [†]
On



▶ () ▶ <Network> ▶ ▶ Check the message ▶ ▶ <TCP/IP Settings> ▶ ▶ <IPSec> ▶ ▶ <Off> or <On> ▶ ▶ Perform a hard reset (▶ **Performing a Hard Reset(P. 408)**)

Sleep Notif. Set.

Specify settings for SLP communication to notify imageWARE of the power status of the machine. If you set <Sleep Mode Notif.> to <On>, you can expect the machine to avoid unnecessary communication during sleep mode and reduce the total power consumption. ▶ **Configuring Settings for Device Management Software(P. 190)**

Sleep Mode Notif.

Enable or disable SLP communication. If you select <On>, the power status of the machine is notified to imageWARE.

Off
On [†]



▶ () ▶ <Network> ▶ ▶ Check the message ▶ ▶ <TCP/IP Settings> ▶ ▶ <Sleep Notif. Set.> ▶ ▶ <Sleep Mode Notif.> ▶ ▶ <Off> or <On> ▶ ▶ Perform a hard reset ()
Performing a Hard Reset(P. 408))

Port Number *

Enter the port number for SLP communications with management software.

1 to 11427 ⁺ to 65535



▶ () ▶ <Network> ▶ ▶ Check the message ▶ ▶ <TCP/IP Settings> ▶ ▶ <Sleep Notif. Set.> ▶ ▶ <Port Number> ▶ ▶ Use the numeric keys to enter the port number ▶ ▶ Perform a hard reset ()
Performing a Hard Reset(P. 408))

Routers to Traverse *

Specify how many routers the notification packets can pass.

0 to 3 ⁺ to 254



▶ () ▶ <Network> ▶ ▶ Check the message ▶ ▶ <TCP/IP Settings> ▶ ▶ <Sleep Notif. Set.> ▶ ▶ <Routers to Traverse> ▶ ▶ Use the numeric keys to enter the number of routers to traverse ▶ ▶ Perform a hard reset ()
Performing a Hard Reset(P. 408))

Notif. Interval *

Specify how often the machine notifies imageWARE of its power status.

60 to 600 ⁺ to 65535





▶ () ▶ <Network> ▶ ▶ Check the message ▶ ▶ <TCP/IP Settings> ▶ ▶ <Sleep Notif. Set.> ▶ ▶ <Notif. Interval> ▶ ▶ Use the numeric keys to enter the notification interval ▶ ▶ Perform a hard reset ()
Performing a Hard Reset(P. 408))

Mopria

Select whether to use Mopria®. **Printing by Mopria®(P. 120)**

Off
On ⁺



▶ () ▶ <Network> ▶ ▶ Check the message ▶ ▶ <Mopria> ▶ ▶ <Off> or <On> ▶ ▶ Perform a hard reset ( **Performing a Hard Reset(P. 408)**)

Google Cloud Print

Enable or disable Google Cloud Print.  **Changing Google Cloud Print Settings(P. 128)**

Use Cloud Print
Off
On ⁺
Registration Status

SMB *

Select whether to use the machine as a shared printer on the SMB network. Use the Remote UI to specify other SMB settings including the server name and the workgroup name.  **Configuring SMB(P. 194)**

SMB Server

Select whether to display the machine as an SMB Server on the SMB network configuration screen.

Off ⁺
On





▶ () ▶ <Network> ▶ ▶ Check the message ▶ ▶ <SMB> ▶ ▶ <SMB Server> ▶ ▶ <Off> or <On> ▶ ▶ Perform a hard reset ( **Performing a Hard Reset(P. 408)**)

SMB Print *

Enable or disable SMB Print.

Off ⁺
On



▶ () ▶ <Network> ▶ ▶ Check the message ▶ ▶ <SMB> ▶ ▶ <SMB Print> ▶ ▶ <Off> or <On> ▶ ▶ Perform a hard reset ( **Performing a Hard Reset(P. 408)**)

SNMP Settings

Specify the settings for monitoring and controlling the machine from a computer running SNMP-compatible software.
▶ Monitoring and Controlling the Machine with SNMP(P. 184)

SNMPv1 Settings

Specify settings for using SNMPv1. Use the Remote UI to specify a community name and access privileges to Management Information Base (MIB) objects.

SNMPv1

Enable or disable SNMPv1.

Off
 On [†]

▶ () ▶ <Network> ▶ ▶ Check the message ▶ ▶ <SNMP Settings> ▶ ▶ <SNMPv1 Settings> ▶ ▶ <SNMPv1> ▶ ▶ <Off> or <On> ▶ ▶ Perform a hard reset (▶ **Performing a Hard Reset(P. 408)**)

Dctd. Community Set.

Dedicated Community is a preset community, intended exclusively for administrators using Canon software, such as iW Management Console. Select the access privilege to Management Information Base (MIB) objects.

Dctd. Community

Off
 Read/Write
 Read Only [†]

▶ () ▶ <Network> ▶ ▶ Check the message ▶ ▶ <SNMP Settings> ▶ ▶ <SNMPv1 Settings> ▶ ▶ <Dctd. Community Set.> ▶ ▶ <Dctd. Community> ▶ ▶ Select the access privilege ▶ ▶ Perform a hard reset (▶ **Performing a Hard Reset(P. 408)**)

SNMPv3 Settings

Specify settings for using SNMPv3. Use the Remote UI to specify detailed settings that are applied when SNMPv3 is enabled.

SNMPv3

Enable or disable SNMPv3.

Off [†]
 On



▶ () ▶ <Network> ▶ ▶ Check the message ▶ ▶ <SNMP Settings> ▶ ▶ <SNMPv3 Settings> ▶ ▶ <SNMPv3> ▶ ▶ <Off> or <On> ▶ ▶ Perform a hard reset ()
Performing a Hard Reset(P. 408))

User Settings N (N=1, 2, 3, 4, 5) *

Specify the authentication password and encryption password as the user information used on SNMPv3. Use the Remote UI to register the user information.  **Monitoring and Controlling the Machine with SNMP(P. 184)**

Auth. Password /Encryption Password

Enter 6 to 16 alphanumeric characters for each password. Use the numeric keys to enter the password.



▶ () ▶ <Network> ▶ ▶ Check the message ▶ ▶ <SNMP Settings> ▶ ▶ <SNMPv3 Settings> ▶ ▶ Select the user settings number ▶ ▶ Check the user name ▶ ▶ <Auth. Password> or <Encryption Password> ▶ ▶ Enter the password ▶ ▶ Perform a hard reset ( **Performing a Hard Reset(P. 408))**

Rjct Packet in Sleep

Select whether to discard SNMP packets received during sleep mode.

Off 

On



▶ () ▶ <Network> ▶ ▶ Check the message ▶ ▶ <SNMP Settings> ▶ ▶ <Rjct Packet in Sleep> ▶ ▶ <Off> or <On> ▶ ▶ Perform a hard reset ( **Performing a Hard Reset(P. 408))**

NOTE

- If you select <On>, applications that use the SNMP protocol, such as Canon software imageWARE Series, may be disabled to access the machine.

Spooler *

Select whether to include the SD card in the storage locations of received print data. If you select <On>, the machine capacity of receiving print data is increased.

Off 

On





▶ () ▶ <Network> ▶ ▶ Check the message ▶ ▶ <Spooler> ▶ ▶ <Off> or <On> ▶ ▶ Perform a hard reset ( **Performing a Hard Reset(P. 408)**)

Receive in Parallel

Specifies whether to print jobs in the order received when print data for several jobs are sent to the printer from one computer. If you select <Off>, jobs are printed in the order received but printing speed may be slower.

Off
On [†]



▶ () ▶ <Network> ▶ ▶ Check the message ▶ ▶ <Receive in Parallel> ▶ ▶ <Off> or <On> ▶ ▶ Perform a hard reset ( **Performing a Hard Reset(P. 408)**)

NOTE

- Even if you select <Off>, jobs may not be saved in the order received in some cases, for example when the Stored Job Print function is being executed.

Wait Time at Startup

Specify a wait time for connecting to a network. Select the setting depending on the network environment.  **Setting a Wait Time for Connecting to a Network(P. 171)**

0 [†] to 300 (sec.)

Remote UI Settings

Specify settings for using the Remote UI. You can use the Remote UI to specify settings for the machine from a Web browser.

Remote UI

Enable or disable the Remote UI.  **Disabling Remote UI(P. 241)**

Off
On [†]

RUI Access Sec. Set.

Select whether to use a PIN to access the Remote UI.  **Setting a Remote UI PIN(P. 215)**

Off [†]
On

TLS *

Enable or disable TLS for Remote UI communications. To use TLS for encrypted communications, you need to set key pairs by using the Remote UI (**Using TLS for Encrypted Communications(P. 246)**), respectively.

Off †
On



▶ () ▶ <Network> ▶ ▶ Check the message ▶ ▶ <Remote UI Settings> ▶ ▶ <TLS> ▶ ▶ <Off> or <On> ▶ ▶ Perform a hard reset (**Performing a Hard Reset(P. 408)**)

Software Regist/Updt *

When you register or update a MEAP application, you can check for communication with a distribution server to connect to.

Software Mngt. Set.

Communication Test



▶ () ▶ <Network> ▶ ▶ Check the message ▶ ▶ <Software Regist/Updt> ▶ ▶ <Software Mngt. Set.> ▶ ▶ <Communication Test> ▶ ▶ <Yes> ▶ ▶ Check the message ▶ ▶ Check the communication result ▶

Ethernet Driver

Specify the Ethernet communication mode (half duplex/full duplex) and Ethernet type (10 Base-T/100 Base-TX/1000 Base-T). **Configuring Ethernet Settings(P. 169)**

Auto Detect

Select whether to automatically detect or manually select the communication mode and the Ethernet type.

Off
On †

Communication Mode *

If <Auto Detect> is set to <Off>, select the Ethernet communication mode.

Half Duplex †
Full Duplex

Ethernet Type *

If <Auto Detect> is set to <Off>, select the Ethernet type.

- 10 Base-T +
- 100 Base-TX
- 1000 Base-T

Sleep Mode Priority

Select whether to give priority to rapid returning from sleep mode or greater energy saving effect of sleep mode.

- Optimal Balance +
- Exit Speed
- Energy Saving



▶ () ▶ <Network> ▶ ▶ Check the message ▶ ▶ <Sleep Mode Priority> ▶ ▶ Select the settings item ▶ ▶ Perform a hard reset (▶ **Performing a Hard Reset(P. 408)**)

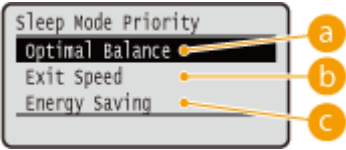

a Optimal Balance

The machine returns from sleep mode rapidly. When the devices directly connected to the machine support EEE (Energy Efficient Ethernet), power consumption can be reduced to a greater degree. Normally use this setting.

b Exit Speed

The machine returns from sleep mode more rapidly.

c Energy Saving

Communication speed during sleep mode is reduced for lowest power consumption.

NOTE

- This item is available when <Sleep Mode> is set to <High (Deep Sleep)>. ▶ **Entering Sleep Mode(P. 63)**

IEEE802.1X

Enable or disable IEEE 802.1X authentication. Use the Remote UI to specify detailed settings that are applied when IEEE802.1X authentication is enabled. ▶ **Configuring IEEE 802.1X Authentication(P. 261)**

Off [†]
On



▶ () ▶ <Network> ▶ ▶ Check the message ▶ ▶ <IEEE802.1X> ▶ ▶ Check the message ▶ ▶ <Off> or <On> ▶ ▶ Perform a hard reset (▶ **Performing a Hard Reset(P. 408)**)

Address Filter

Enable or disable communication restricted with the IP address and MAC address. Use the Remote UI to specify the address to restrict. ▶ **Restricting Communication by Using Firewalls(P. 216)**

Off
On [†]



▶ () ▶ <Network> ▶ ▶ Check the message ▶ ▶ <Address Filter> ▶ ▶ <Off> or <On> ▶ ▶ Perform a hard reset (▶ **Performing a Hard Reset(P. 408)**)

MAC Address

Check the MAC address of the machine, which is a number unique to each communication device.

(Display only)



▶ () ▶ <Network> ▶ ▶ Check the message ▶ ▶ <MAC Address> ▶



E-Mail Print Set.

Specify settings for using the E-Mail Print function. Use the Remote UI to specify other settings for E-Mail Print including the mail server settings. ▶ **Printing Received E-mail (E-Mail Print)(P. 111)**

POP3 RX Interval

Specify the interval for automatically connecting to the mail server in minutes. New e-mails in the mailbox of the mail server are automatically received and printed at the specified time intervals.

0 [†] to 90 (min.)

 ▶ () ▶ <Network> ▶ ▶ Check the message ▶ ▶ <E-Mail Print Set.> ▶ ▶ <POP3 RX Interval> ▶ ▶ Use the numeric keys to enter the interval of auto e-mail reception ▶ ▶ Perform a hard reset ( **Performing a Hard Reset(P. 408)**)



NOTE

- If you select "0," e-mails are not automatically received. In this case, receive e-mails manually.  **Manually Receiving E-Mails(P. 115)**

POP3 RX

Enable or disable E-Mail Print for the POP3 mail server.



Off 
On

 ▶ () ▶ <Network> ▶ ▶ Check the message ▶ ▶ <E-Mail Print Set.> ▶ ▶ <POP3 RX> ▶ ▶ <Off> or <On> ▶ ▶ Perform a hard reset ( **Performing a Hard Reset(P. 408)**)

SMTP RX

Enable or disable E-Mail Print for the SMTP protocol.

Off 
On

 ▶ () ▶ <Network> ▶ ▶ Check the message ▶ ▶ <E-Mail Print Set.> ▶ ▶ <SMTP RX> ▶ ▶ <Off> or <On> ▶ ▶ Perform a hard reset ( **Performing a Hard Reset(P. 408)**)

Monitoring Service

Enable communication with a remote monitoring server and display of communication logs.

Comm. Test

Enable communication with a remote monitoring server. Execution of this item enables information about the machine to be periodically sent to the remote monitoring server connected to the machine.

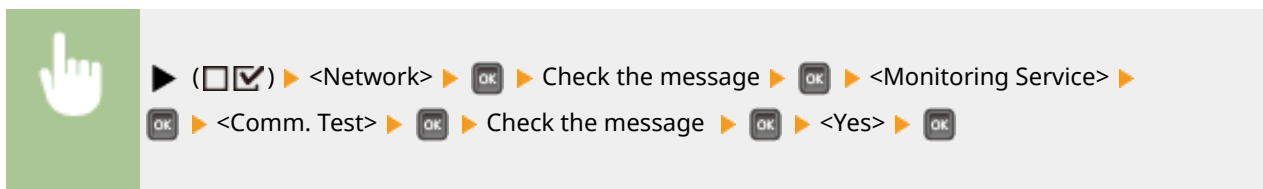

Comm. Log

Display communication logs including error information generated with <Comm. Test>.

(Display only)

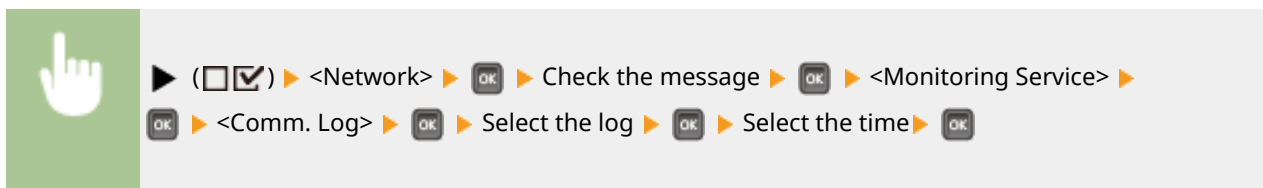

Init. Network Set.

Select to return the Network Settings to the factory defaults. ▶ **Initializing the Network Settings(P. 457)**

Layout

51W4-05C

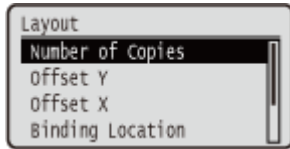

The settings about print appearance including gutter margins and print positions are listed with short descriptions. Default settings are marked with a dagger (†).

- ▶ **Number of Copies**(P. 347)
- ▶ **Offset Y/Offset X**(P. 347)
- ▶ **Binding Location**(P. 348)
- ▶ **Gutter**(P. 349)
- ▶ **Alternative Method**(P. 350)

Number of Copies

Specify the number of copies.

1 † to 9999



▶ () ▶ <Layout> ▶ ▶ <Number of Copies> ▶ ▶ Use the numeric keys to enter the number of copies ▶

Offset Y/Offset X

You can specify settings for shifting the print position for all types of printing in 0.5 mm increments regardless of the paper source.

-50.0 to 0.0 † to +50.0 (mm)



▶ () ▶ <Layout> ▶ ▶ <Offset Y> or <Offset X> ▶ ▶ Use ▲ / ▼ to enter the offset value ▶

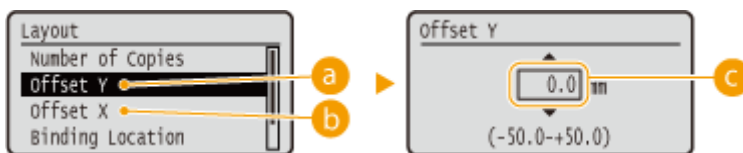

a <Offset Y>

Shifts the print position vertically.

b <Offset X>

Shifts the print position horizontally.

c Offset values

For <Offset Y>, set a plus (+) value to shift the print position downward. For <Offset X>, set a plus (+) value to shift the print position rightward. Set a minus (-) value to shift the print position in the opposite direction.

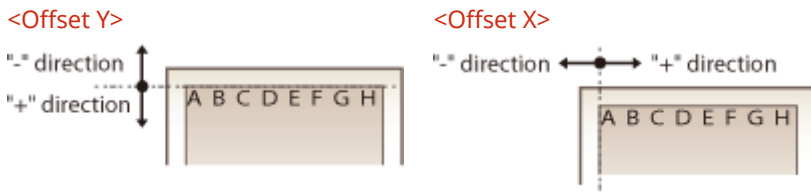

Specifying fine settings for the print position

You can select <Adj. Print Position> under <User Maintenance> to finely specify the print position for each paper source. The range of available offset values is from -5.0 mm to +5.0 mm. **▶ Adjusting Print Position(P. 436)**

Binding Location

Select whether to bind the long edge or short edge of the printouts with a binding tool such as a stapler. In this case, specify settings for <Gutter> to adjust the binding margin, as well.

Long Edge [†]
Short Edge

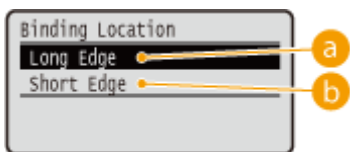
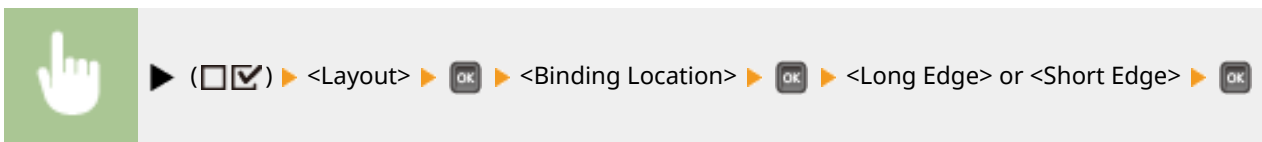

a <Long Edge>

Select to bind the printouts along the long edge.



b <Short Edge>

Select to bind the printouts along the short edge.



Gutter

Adjust the margin width of the edge specified in <Binding Location> by shifting the print position of the print data. If you select "0.0", the margin will not be changed.



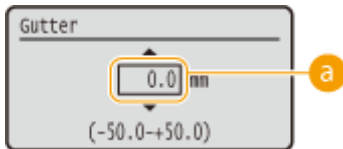
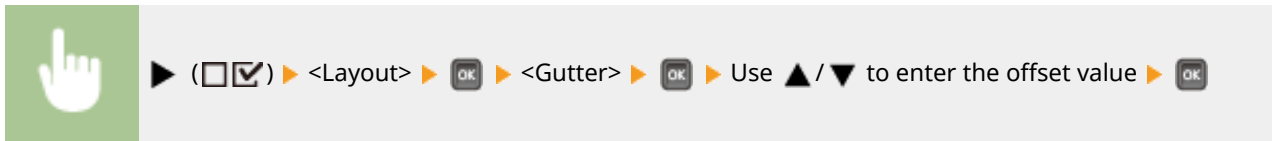

-50.0 to 0.0 + to +50.0 (mm)





a Margin values

Specify the direction and width for shifting the print position of the print data. The edge where the margin is changed varies depending on whether a "+" or "-" value is set. You can adjust the margin width in 0.5 mm increments.



■ Portrait-oriented document

Setting Value	Long edge binding	Short edge binding
"+" value	Left end of paper (for left binding) 	Upper end of paper (for top binding) 
"-" value	Right end of paper (for right binding) 	Lower end of paper (for bottom binding) 

■ Landscape-oriented document

Setting Value	Long edge binding	Short edge binding
"+" value	Left end of paper (for top binding) 	Upper end of paper (for right binding) 

Setting Menu List

Setting Value	Long edge binding	Short edge binding
"-" value	Right end of paper (for bottom binding) 	Upper end of paper (for right binding) 

Alternative Method

When you perform 2-sided printing of a document that consists of an odd number of pages, you can select whether to process the last page in 1-sided printing mode. If you select <On>, the printing will be finished faster than the regular 2-sided printing.

Off
On †

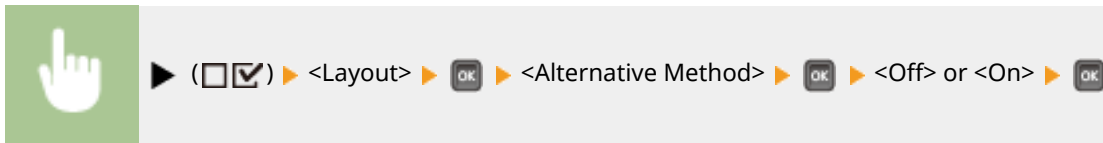

NOTE

When the printing of a document consisting of an even number of pages finishes in 1-sided printing mode

In the following cases, the last page is processed in 1-sided printing mode even if the document consists of an even number of pages.

- The last page is blank.
- The last page cannot be printed for a reason such as the paper size is not available for 2-sided printing.

When paper with preprinted logo is used

- If the last page is processed in 1-sided printing mode with <Alternative Method> to <On>, the orientation or print side of the last page may not match those of other pages. In this case, set <Alternative Method> to <Off>.

Print Quality

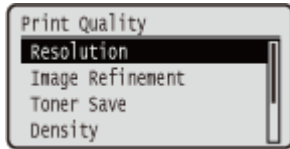

The settings about print quality including the resolution and toner density are listed with short descriptions. Default settings are marked with a dagger (†).

NOTE

Asterisks (*)

- Settings marked with an asterisk (*) may not be displayed depending on the model you are using, options, or other setting items.

- ▶ **Resolution(P. 351)**
- ▶ **Image Refinement(P. 352)**
- ▶ **Toner Save(P. 352)**
- ▶ **Density(P. 352)**
- ▶ **Density (Fine Adj)(P. 352)**
- ▶ **Halftones(P. 353)**
- ▶ **Reduce Quality(P. 354)**
- ▶ **Adj. Prt. Line Width(P. 354)**

Resolution

Specify the resolution for processing print data.

600 dpi †
 1200 dpi

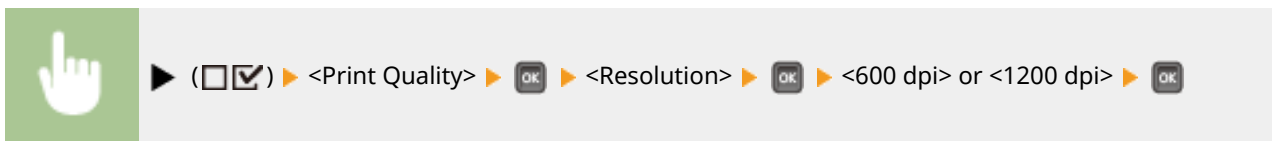

a <600 dpi>

This print mode is suitable for printing at a high speed.

b <1200 dpi>

Edges of characters and graphics can be clearly reproduced at high resolution. This print mode is suitable for printing data that contains many small characters.

Image Refinement *

Enable or disable the smoothing mode in which the edges of characters and graphics are smoothly printed. <Image Refinement> is not displayed when <Resolution> is set to <1200 dpi>.

Off
On †

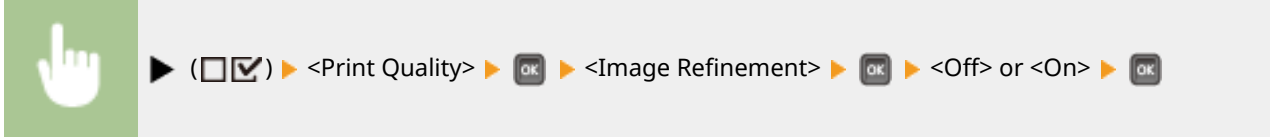

Toner Save

Specify this setting when you want to check the finishing such as the layout before printing a large job, for example. Since this printing mode saves toner, fine lines and portions with lighter print density may become blurred.

Off †
On

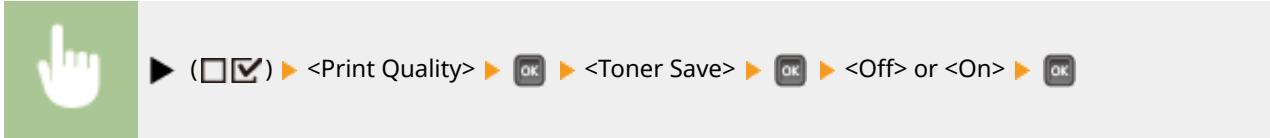

Density *

Adjust the toner density to apply to printing. <Density> is not displayed when <Toner Save> is set to <On>. **▶ Adjusting Print Density(P. 434)**

-8 to 0 † to +8

Density (Fine Adj) *

You can make fine adjustment of the toner density applied to printing separately for three different density areas. <Density (Fine Adj)> is not displayed when <Toner Save> is set to <On>. **▶ Adjusting Print Density(P. 434)**

High
-8 to 0 † to +8

Medium
-8 to 0 † to +8

Low
-8 to 0 † to +8

Halftones

You can select the printing method to reproduce halftones (the intermediate range between the lighter and darker areas of an image). Halftones can be specified for each image data type in a single document.

<p>Text</p> <p>Resolution †</p> <p>Gradation</p> <p>Color Tone</p> <p>High Resolution</p> <p>Graphics</p> <p>Resolution</p> <p>Gradation</p> <p>Color Tone †</p> <p>High Resolution</p> <p>Image</p> <p>Resolution</p> <p>Gradation</p> <p>Color Tone †</p> <p>High Resolution</p>

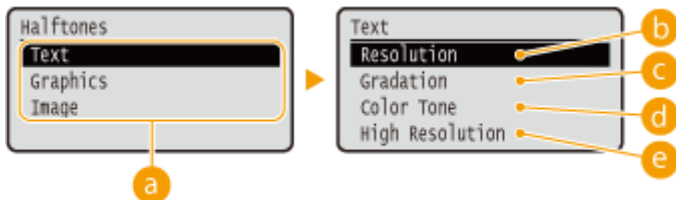

a Image data type

Select the image data type for which the settings are changed. Select <Text> for characters, <Graphics> for lines and figures, or <Image> for images such as photos.

b <Resolution>

Performs fine printing by sharply reproducing the edges of characters. This print mode is suitable for printing data of characters and thin lines with a clear finish.

c <Gradation>

Prints gradation and lines with a smooth finish. This print mode is suitable for printing figures and charts with gradation.

d <Color Tone>

Prints vivid images with a tonal contrast effect. This print mode is suitable for printing image data such as photos.

e <High Resolution>

Implements higher definition printing than the <Resolution> setting, but is slightly inferior in stability of texture. This print mode is suitable for sharply printing edges of data such as characters, thin lines, and CAD data.

Reduce Quality

Select whether to continue printing by automatically reducing the quality when insufficient memory is available for the processing.

Continue Printing [†]
 Stop Printing

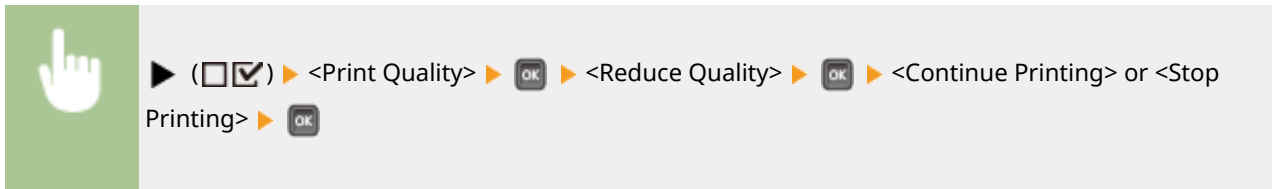

NOTE

- If you select <Stop Printing>, an error message is displayed and the printing is stopped when the machine runs out of memory. You can press (●—●) to resume the printing by reducing the quality.

Adj. Prt. Line Width

Adjust this if the printed text or thin lines are faded.

-7 to 0 [†] to +8

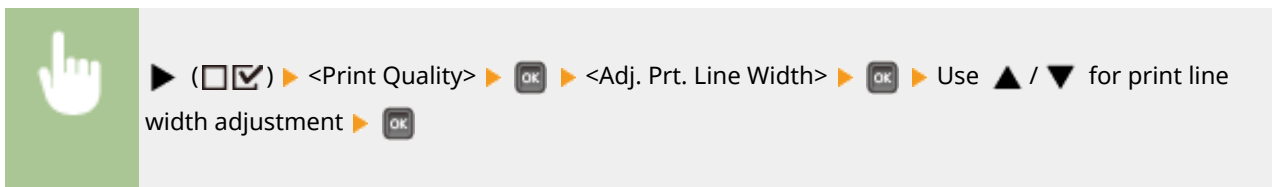

Interface

51W4-05F

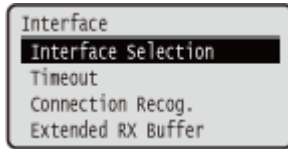

All the settings about interfaces for communications with a computer and USB are listed with short descriptions. Default settings are marked with a dagger (†).

NOTE

Asterisks (*)

- Settings marked with an asterisk (*) may not be displayed depending on the model you are using, options, or other setting items.

- ▶ **Interface Selection(P. 355)**
- ▶ **Timeout(P. 356)**
- ▶ **Connection Recog.(P. 357)**
- ▶ **Extended RX Buffer(P. 357)**

Interface Selection

Select the interface used for the machine.

USB

Enable or disable the USB port. ▶ **Restricting the USB Connection with a Computer(P. 234)**

Off
On †

Network

Enable or disable the LAN port. ▶ **Disabling the LAN Port(P. 242)**

Off
On †

USB Adv. Functions

Specify settings for selecting a function to use a USB device or selecting a device driver to use.

Adv. Func. Settings

Select which of MEAP applications and USB over NW to be given priority when a USB device is connected to the machine.

Meap Priority †
USB Over NW Priority



▶ () ▶ <Interface> ▶ ▶ <Interface Selection> ▶ ▶ Check the message ▶ ▶ <USB Adv. Functions> ▶ ▶ <Adv. Func. Settings> ▶ ▶ <Meap Priority> or <USB Over NW Priority> ▶ ▶ Perform a hard reset ( **Performing a Hard Reset(P. 408)**)

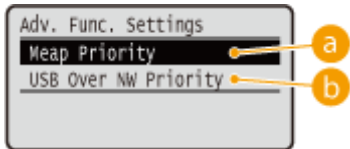

a <Meap Priority>

Specify this to give priority to MEAP applications.

b <USB Over NW Priority>

Specify this to give priority to USB over NW. This function enables you to use, from your computer, a USB device connected to the machine's USB port.

USB Storage Device

Specify settings for the device driver for using a USB memory device.

MEAP Driver

Enable or disable the MEAP specific device driver when a USB memory device is attached to the machine. When you want to perform the direct print function (USB Direct Print) from a USB memory device without using a computer, select <Off>.

▶ () ▶ <Interface> ▶ ▶ <Interface Selection> ▶ ▶ Check the message ▶ ▶ <USB Adv. Functions> ▶ ▶ <USB Storage Device> ▶ ▶ <MEAP Driver> ▶ ▶ <Off> or <On> ▶ ▶ Perform a hard reset ( **Performing a Hard Reset(P. 408)**)

Timeout

Specify how the machine should behave if receiving print data is interrupted.

Timeout

Select whether to cancel printing if print data receiving is interrupted for a specified period of time.



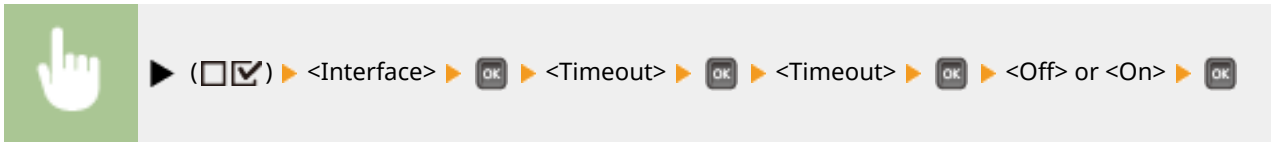

Timeout Time *

Set the time period until a timeout error occurs.

5 to 15 ⁺ to 300 (seconds)



Connection Recog.

A problem such as improper overlay printing or garbled characters may occur during printing via wired LAN connection. In this case, set <Connection Recog.> to <Off>.

Off
On ⁺

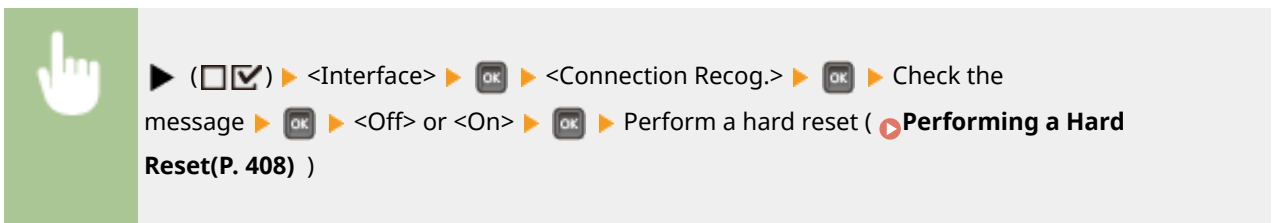

Extended RX Buffer

Select whether to increase the space of the memory built in the machine for receiving print data from a computer. If you select <On>, the time until the computer will be freed from print data processing or transmission can be reduced when the computer sends a large volume of data or complicatedly structured data.

Off
On ⁺

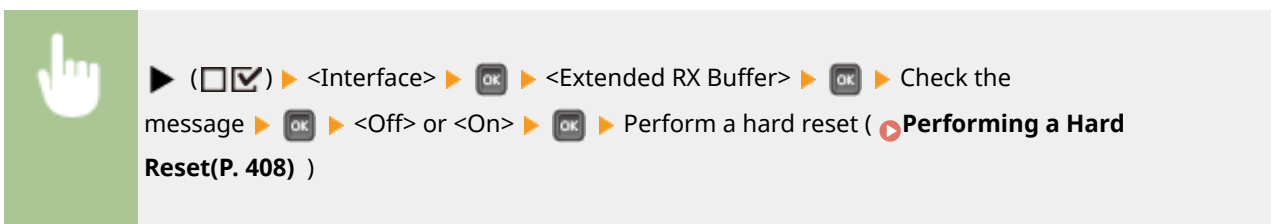

User Maintenance

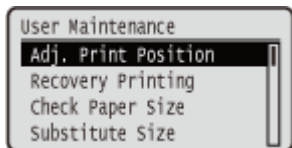

The settings about adjustment of the machine including print position correction for each paper source and print quality improvement are listed with short descriptions. You can specify those settings when the machine is offline. Default settings are marked with a dagger (†).

NOTE

Asterisks (*)

- Settings marked with an asterisk (*) may not be displayed depending on the model you are using, options, or other setting items.

- ▶ **Adj. Print Position(P. 358)**
- ▶ **Recovery Printing(P. 359)**
- ▶ **Check Paper Size(P. 359)**
- ▶ **Substitute Size(P. 359)**
- ▶ **Short Edge Fd. Prty.(P. 360)**
- ▶ **Sp. Transfer Mode(P. 360)**
- ▶ **Special Print Mode A(P. 360)**
- ▶ **Adj. Scndry Transfer(P. 361)**
- ▶ **Wrinkle Correction(P. 361)**
- ▶ **Afterimage Corr.(P. 361)**
- ▶ **Sp. Transfer Mode 2(P. 362)**
- ▶ **Special Deliv. Mode(P. 362)**
- ▶ **Improve Toner Fixing(P. 363)**
- ▶ **SD Card Maintenance(P. 363)**
- ▶ **Special Print Mode(P. 363)**
- ▶ **Special Print Adj. C(P. 365)**
- ▶ **Update Firmware(P. 366)**
- ▶ **Paper Feed Method(P. 366)**
- ▶ **Show Job List(P. 367)**
- ▶ **Rdc Thin Ppr Curling(P. 367)**
- ▶ **Import/Export Set.(P. 368)**
- ▶ **Notify to Clean(P. 368)**
- ▶ **Clean. Notif. Timing(P. 369)**
- ▶ **Toner Check Timing(P. 369)**
- ▶ **Spec Tnr Chk Timing(P. 369)**
- ▶ **Control Condensation(P. 369)**
- ▶ **Rdc Drk Aftr Cart Ch(P. 370)**

Adj. Print Position

You can adjust the print position for each paper source. ▶ **Adjusting Print Position(P. 436)**

Common

You can adjust the vertical/horizontal print position for printing on the first page (front side) in 2-sided printing mode. The print position on the second page (back side) follows the settings for the paper source available when the printing is started.

Offset Y (2-Sided) / Offset X (2-Sided)

-5.0 to 0.0 † to +5.0 (mm)

Multi-Purpose Tray

You can adjust the vertical/horizontal print position for printing on paper from the multi-purpose tray.

Offset Y (MP Tray) / Offset X (MP Tray)

-5.0 to 0.0 † to +5.0 (mm)

Drawer 1 to 4 *

You can adjust the vertical/horizontal print position for printing on paper fed from a paper drawer.

Offset Y (Drawer 1 to 4)/ Offset X (Drawer 1 to 4)

-5.0 to 0.0[†] to +5.0 (mm)

Recovery Printing

Select whether to print again the page of which printing was interrupted by a paper jam or an error.

Off
On[†]

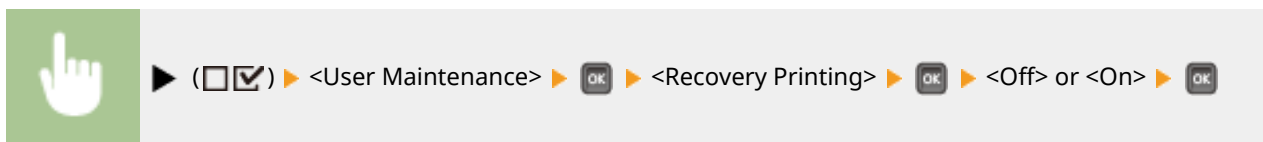

Check Paper Size

Select whether to check the size of paper that is fed from the paper source with the paper size set to <Free Size>. If you select <On>, the message for confirming the paper size is displayed and the printing is stopped when the size of the paper fed from the paper source does not match the print data.

Off[†]
On



NOTE

- If the difference in size between the fed paper and the print data is not so large, it is possible that no message will be displayed and the printing will be continued even when the selected setting is <On>.

Substitute Size

Select whether to print by substituting A4 size paper and Letter size paper with each other. If you select <On>, Letter size paper is used for printing when you have specified A4 size paper for printing from a computer but the A4 size paper is not loaded in the machine.

Off[†]
On



Short Edge Fd. Prty.

When printing on paper of a size that allows for loading both in portrait and landscape orientations, set this item to <On> if you want the paper in portrait orientation to be fed preferentially. This setting applies only when <Paper Source> to <Auto>.

Off †
On

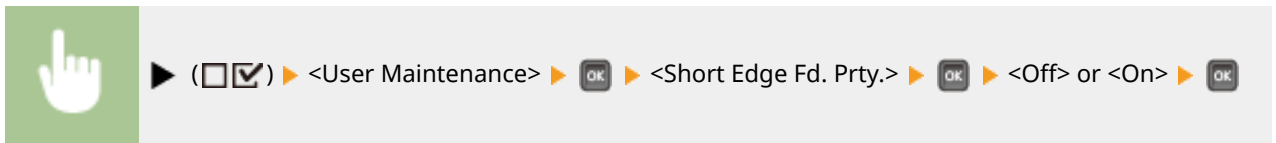

Sp. Transfer Mode

When you use the machine in an environment with low humidity, printed images or text may be smudged. In this case, setting this item to <On> may solve the problem.

Off †
On

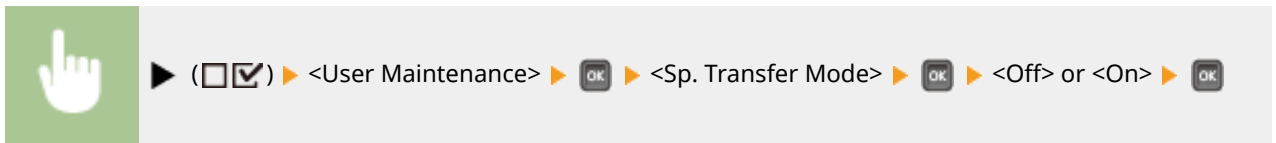

NOTE

- When you set this item to <On> and use the machine in an environment with high humidity, the print density may become lighter or uneven.

Special Print Mode A

Streaks may appear on printouts depending on the paper type or the environmental conditions. In this case, setting this item may solve the problem. The improvement effect is weakest with <Mode 1> and strongest with <Mode 4>.

Off
Mode 1 †
Mode 2
Mode 3
Mode 4

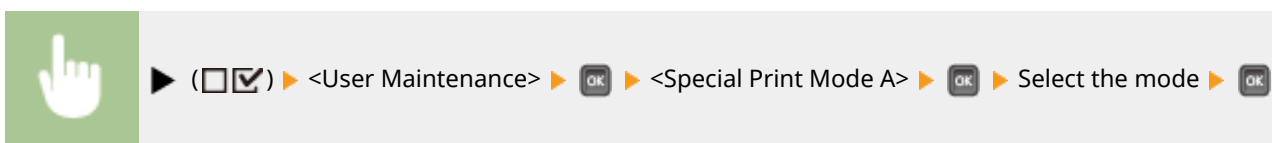

NOTE

- As the improvement effect is increased, the print density becomes lighter. In addition, the edges may be blurred or roughness may be slightly emphasized.
- If you select <Mode 3> or <Mode 4>, the print speed will be slower.

Adj. Scndry Transfer

When you use the machine in an environment with high humidity, the print density may become lighter or uneven. In this case, setting this item to <On> may solve the problem.

Off [†]
On

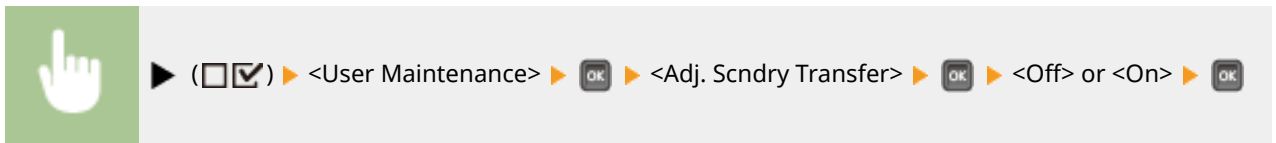

NOTE

- If you select <On> and use the machine in an environment with low humidity, printed images or text may be smudged.

Wrinkle Correction

If printouts crease, set this item to <On>.

Off [†]
On

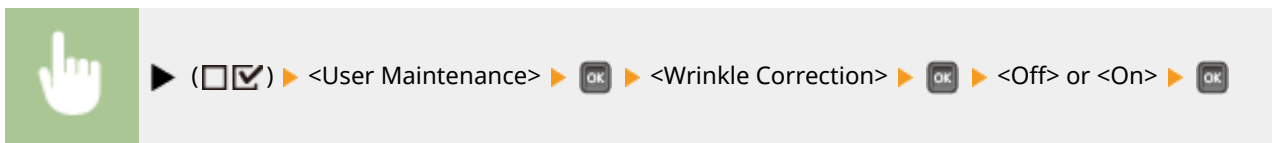

Afterimage Corr.

When you print on large size paper after printing on small size paper, afterimages may appear in blank areas. In this case, setting this item to <On> may solve the problem.

Off [†]
On

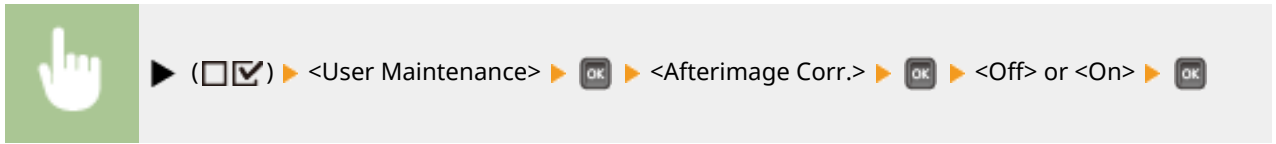

NOTE

- If you select <On>, the print speed may be slower.

Sp. Transfer Mode 2

If blurring of graphics or text persists with <Sp. Transfer Mode> specified, setting this item to <On> may solve the problem.

Off [†]
On

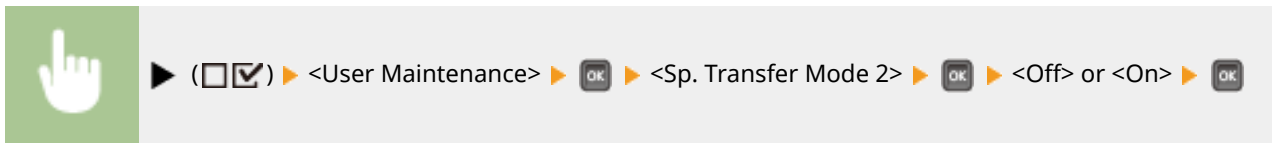

NOTE

- If you select <On> and use the machine in an environment with high humidity, the print density may become lighter or uneven.

Special Deliv. Mode

Printouts may crease or black horizontal streaks may appear in the leading edge of paper depending on the paper type or environmental conditions. In this case, setting this item may solve the problem.

Off [†]
On

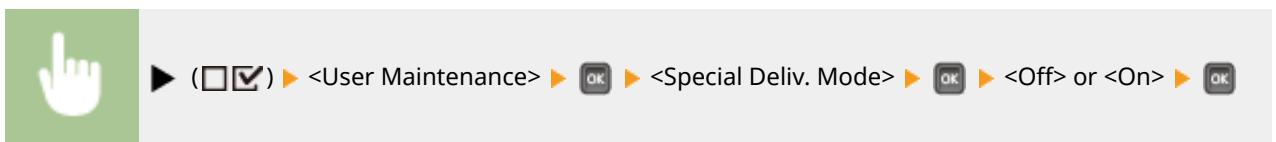

NOTE

- If you select <On>, the print speed may be slower.

Improve Toner Fixing

When you perform 2-sided printing after the machine is left unused for a long time, void may occur in printed images. In this case, setting this item to <On> may solve the problem.

Off†
On



NOTE

- If you select <On>, the print speed may be slower.

SD Card Maintenance *

When an error occurs in an SD card or when you want to discard an SD card, you can erase all the data stored on that card.

Format

Initializes the SD card. All the stored data is erased from the card.

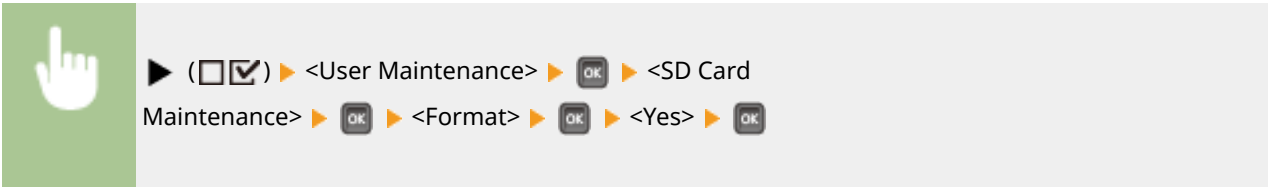

Completely Del. Data

All the stored data is erased from the SD card. Perform this operation as necessary, such as when you want to discard an SD card after erasing all the stored data including those fragments that cannot be erased normally.

▶ **Deleting All Data in an SD Card(P. 498)**

Special Print Mode

Provides items you can set when printing cannot be performed properly.

Curl Correction

If the printed paper curls, set this item to <On>.

Off†
On



▶ () ▶ <User Maintenance> ▶ ▶ <Special Print Mode> ▶ ▶ <Curl Correction> ▶ ▶ <Off> or <On> ▶

NOTE

- If you select <On>, the print speed may be slower. Also, printouts may be faded.

Reduce Ppr. Sticking

In 2-sided printing, printed paper may stick to each other depending on the image density of print data. In this case, setting this item to <On> may solve the problem.

Off [†]
On



▶ () ▶ <User Maintenance> ▶ ▶ <Special Print Mode> ▶ ▶ <Reduce Ppr. Sticking> ▶ ▶ <Off> or <On> ▶

NOTE

- If you select <On>, the print speed may be slower.

Rough Paper Adj.

When you print on envelopes, toner may come off printed images depending on the environmental conditions. In this case, setting this item to <On> may solve the problem. However, the printing speed will be slower.

Off [†]
On



▶ () ▶ <User Maintenance> ▶ ▶ <Special Print Mode> ▶ ▶ <Rough Paper Adj.> ▶ ▶ <Off> or <On> ▶

NOTE

- <Rough Paper Adj.> functions only when the paper type setting is <Envelope H>. **▶ Specifying Paper Size and Type(P. 57)**
- If you set to <On>, the <Curl Correction> setting will be disabled.

2-Sd Prnt Speed Prty

Printing speed may be slower during 2-sided printing. To avoid slower printing speed, set to <On>.

Off [†]
On



▶ () ▶ <User Maintenance> ▶ ▶ <Special Print Mode> ▶ ▶ <2-Sd Prnt Speed Prty> ▶ ▶ <Off> or <On> ▶

NOTE

- If you set to <On>, streaks may appear on printouts.

Incr Pcard Fix. Qlty

When you print on postcard, toner may come off printed images depending on the environmental conditions. In this case, setting this item to <On> may solve the problem. However, the printing speed will be slower.

Off [†]
On



▶ () ▶ <User Maintenance> ▶ ▶ <Special Print Mode> ▶ ▶ <Incr Pcard Fix. Qlty> ▶ ▶ <Off> or <On> ▶

Special Print Adj. C

Set this item to <On> when printing noise is noticeable.

Off [†]
On



▶ () ▶ <User Maintenance> ▶ ▶ <Special Print Adj. C> ▶ ▶ <Off> or <On> ▶

NOTE

- If you set this item to <On>, the printing speed becomes slower.

Update Firmware

Upgrades the firmware of the machine.

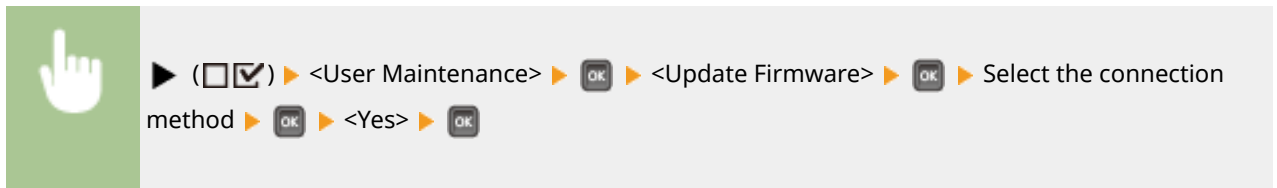

a Connection method selection

Select the method to connect a computer that performs the firmware update.

Paper Feed Method

Specify this setting when you print a document on paper with logos. To print on paper with logos, you need to change how the paper loaded in the paper source is facing depending on whether you are performing 1- or 2-sided printing. However, if you change the setting to <Print Side Priority>, you can just load the paper face down for both 1- and 2-sided printing. For more information, see [▶ Loading Preprinted Paper\(P. 53\)](#) .

Speed Priority [†]
 Print Side Priority

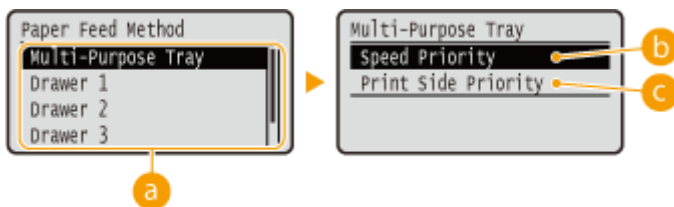
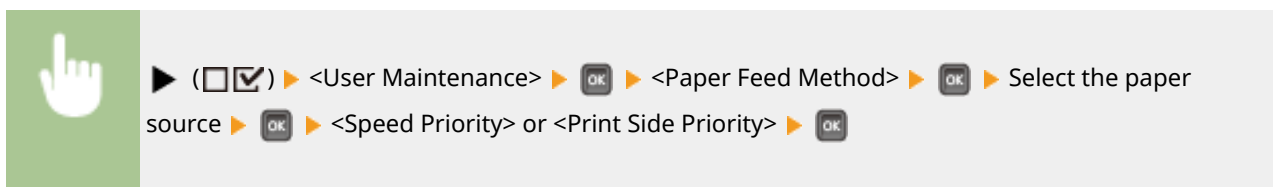

a Paper source selection

Select the paper source for which you want to change the setting of Paper Feed Mode.

b <Speed Priority>

When using paper that has been preprinted with a logo, you need to change which side is up depending on 1-sided or 2-sided printing.

NOTE:

- We recommend selecting <Speed Priority> if you do not need to consider which side to print on.



C <Print Side Priority>

To print on a specific side of paper, you do not need to flip over paper in the paper source regardless of whether 1- or 2-sided printing is selected.

NOTE:

- Even if <Print Side Priority> is selected for the paper source (**Available Paper(P. 470)**), it is disabled and the machine operates in the same way as when <Speed Priority> is selected. In this case, load the paper in the same way as when <Speed Priority> is selected (**Loading Preprinted Paper(P. 53)**).
- If you select <Print Side Priority>, 1-sided printing speed will be slower.

Show Job List



Select whether to display a list of data that is being printed and waiting to be printed when you press  ( / ) on the operation panel.

Off

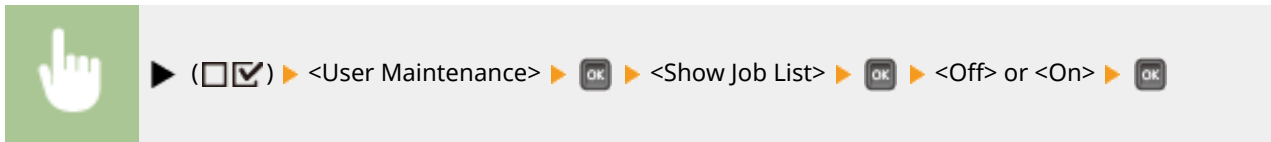
On [†]



NOTE

- If you press  ( / ) when <Off> is selected, the current print job in progress is canceled.

Rdc Thin Ppr Curling

If printing on thin paper produces curled printouts, setting this item to <On> may solve the problem.

Off [†]

On

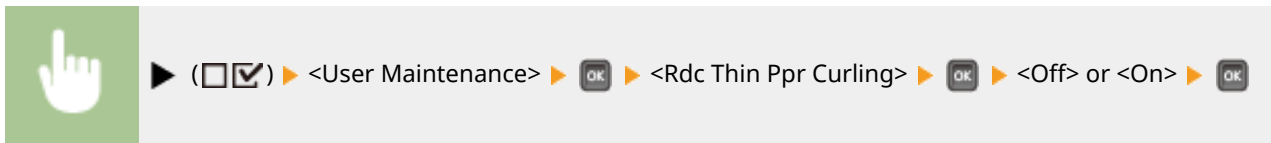

NOTE

- <Rdc Thin Ppr Curling> functions only when the paper type setting is <Thin 1>. **Specifying Paper Size and Type(P. 57)**
- If you set to <On>, automatic 2-sided printing with <Thin 1> is disabled. Further, printouts may be faded due to poor fixing of toner.

Import/Export Set.

You can transfer and save the data registered in the machine and the setting data of the menu options to the USB memory device attached to the machine. The exported data can be imported. If the machine model is the same, other machines can import the data exported from this machine and vice versa.

IMPORT

You can import data that was written to a USB memory device from the machine.

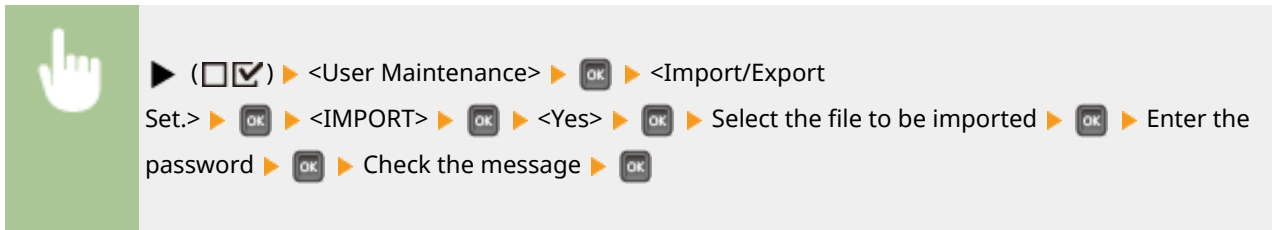

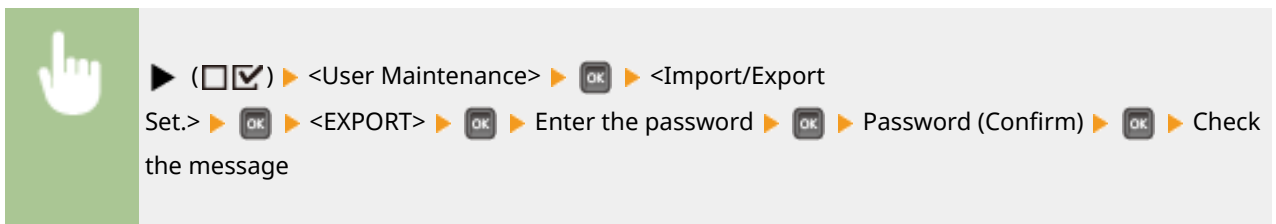

EXPORT

You can save the data registered in the machine and the setting data of the menu options to a USB memory device.



NOTE

- For these purposes, you can only use the USB port provided on the right side of the machine.
- If the <Ready to print files from USB memory.> screen is displayed when USB memory is connected, press  ().
- For details about import/export of settings data, see [▶ Saving/Loading Registered Data\(P. 303\)](#) .

Notify to Clean

Select whether to display a message that prompts you to clean the fixing unit.

Off [†]
On

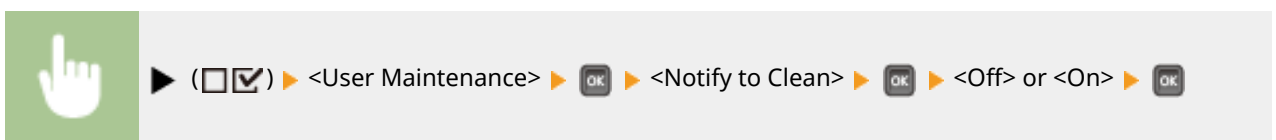

Clean. Notif. Timing *

When you have set <Notify to Clean> to <On>, you can specify the timing to display a prompt message for cleaning the fixing unit, in terms of the number of printed pages and in units of 1,000. The Configuration Page allows you to check how many pages you can print before the prompt message is displayed. (▶ **Configuration Page(P. 441)**)

1000 † to 50000



▶ () ▶ <User Maintenance> ▶ ▶ <Clean. Notif. Timing> ▶ ▶ Enter the number of printed pages ▶

Toner Check Timing

To change the timing to display a message when the toner remaining amount is low, select <Custom>.

Default †
Custom



▶ () ▶ <User Maintenance> ▶ ▶ <Toner Check Timing> ▶ ▶ <Default> or <Custom> ▶

Spec Tnr Chk Timing *

When you have set <Toner Check Timing> to <Custom>, specify the timing to display the message.



▶ () ▶ <User Maintenance> ▶ ▶ <Spec Tnr Chk Timing> ▶ ▶ Use the numeric keys to enter the toner cartridge remaining amount ▶

Control Condensation

When the temperature changes rapidly in the environment where the machine is installed, condensation occurs, which may cause fading or bleeding in images and text. If this item is set to <On>, condensation inside the machine will be removed.

Off †
On



IMPORTANT

- While condensation removal is being performed, printing may not be performed properly and blank paper may be output.
- If you set to <On>, you need to keep the machine turned ON to maintain the effect of condensation removal.

Rdc Drk Aftr Cart Ch

Immediately after replacing toner cartridges with new ones, black streaks may appear on printouts or printing on heavy paper may result in grayish printouts. In this case, setting this item to <On> may solve the problem.

Off [†]
On

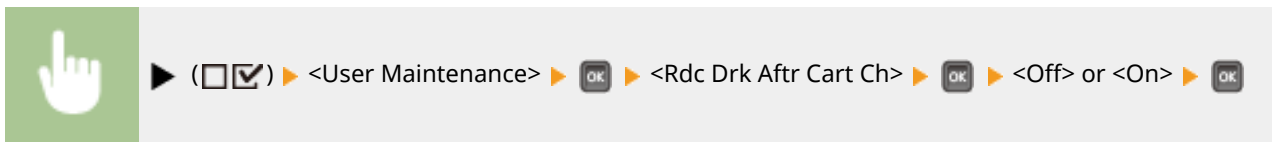

NOTE

- If you set to <On>, the setting will become effective with next replacement of toner cartridges.
- Immediately after cartridge replacement, a certain amount of time is required for toner to be evenly distributed inside the cartridge.

Print Mode

51W4-05J

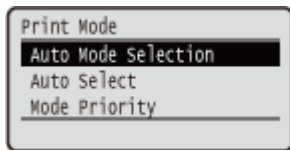

All the settings about print mode switching are listed with short descriptions. Default settings are marked with a dagger (†).

NOTE

Asterisks (*)

- Settings marked with an asterisk (*) may not be displayed depending on the model you are using, options, or other setting items.

▶ **Auto Mode Selection(P. 371)**

▶ **Auto Select(P. 372)**

▶ **Mode Priority(P. 372)**

■ Type of Print Mode

Auto selection mode	The machine enters the auto selection mode when <Auto Selection> is selected for <Auto Mode Selection>. The machine automatically discriminates data sent from a computer and selects the print mode. Normally use this print mode when you print from an application.
<PCL>	Mode for printing a PCL file sent from a computer.
<PS>	Mode for printing a PS file sent from a computer.
<PDF>	Mode for printing a PDF file by using Direct Print or USB Direct Print.
<XPS>	Mode for printing an XPS file by using Direct Print or USB Direct Print.

Auto Mode Selection

Specify the print mode in which the machine operates.

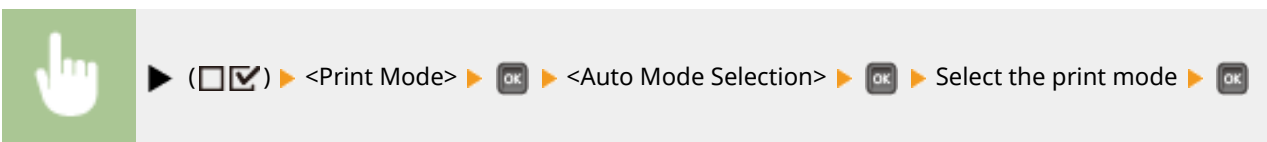

Auto Select

Enable or disable the automatic mode selection feature for the print modes during auto selection mode.

Off
On [†]

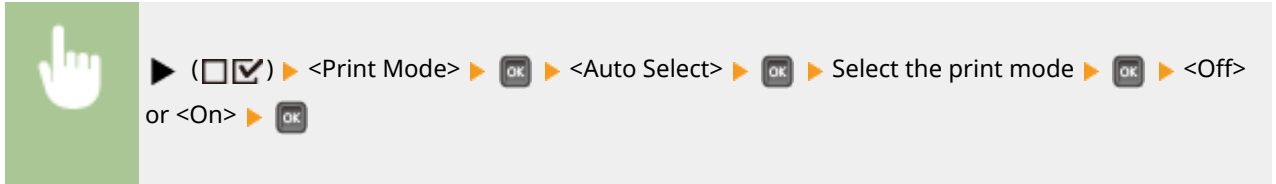

NOTE

- If all print modes are set to <Off>, the machine operates in the print mode specified for <Mode Priority>.

Mode Priority

Specify the print mode that is automatically selected when the machine cannot identify the control command during auto selection mode.

None [†]
PCL
PS
PDF
XPS

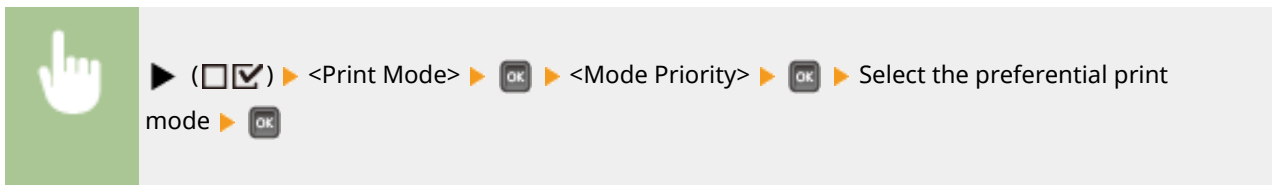

NOTE

- If you select <None>, the machine automatically determines the print mode when it cannot identify the control command.

Settings Specific to Print Mode

51W4-05K

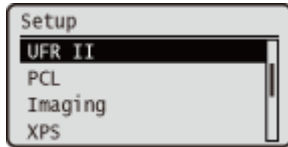

You can use the Setup menu to specify settings specific to each print mode. The settings specific to print mode are described for each mode.

- ▶ **UFR II(P. 374)**
- ▶ **PCL(P. 375)**
- ▶ **Imaging(P. 381)**
- ▶ **XPS(P. 387)**
- ▶ **PDF(P. 391)**
- ▶ **PS(P. 395)**

UFR II

51W4-05L

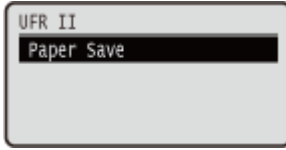

This section describes the settings available during use of UFR II with the control commands. Default settings are marked with a dagger (†).

Paper Save

Select whether to prevent blank pages from being output when they are contained in documents to print.

Off
On †

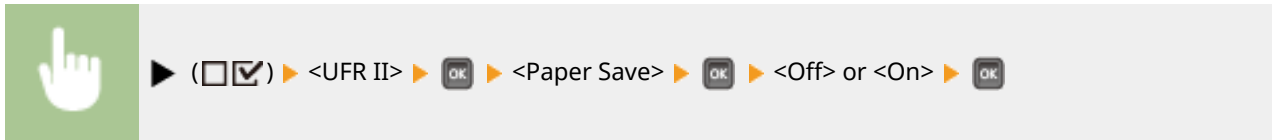

PCL

51W4-05R

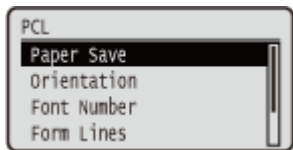

All the settings about the PCL control commands are listed with short descriptions. Default settings are marked with a dagger (†).

NOTE

Asterisks (*)

- Settings marked with an asterisk (*) may not be displayed depending on the model you are using, options, or other setting items.

- ▶ Paper Save(P. 375)
- ▶ Orientation(P. 375)
- ▶ Font Number(P. 376)
- ▶ Point Size(P. 376)
- ▶ Pitch(P. 376)
- ▶ Form Lines(P. 376)
- ▶ Character Code(P. 377)
- ▶ Custom Size(P. 378)
- ▶ Unit of Measurement(P. 378)
- ▶ X Dimension(P. 378)
- ▶ Y Dimension(P. 379)
- ▶ Append CR to LF(P. 379)
- ▶ Enlarge A4 Prt Width(P. 379)
- ▶ BarDIMM(P. 380)
- ▶ FreeScape(P. 380)

Paper Save

Specifies whether the machine outputs the blank page that can be created due to no data existing between two form feed codes sent from an application.

Off †

On

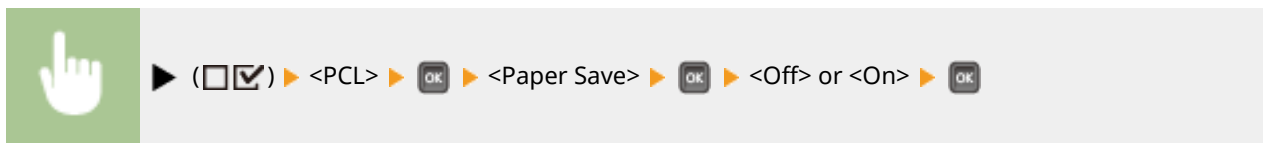

Orientation

Enables you to set the paper orientation.

Portrait †

Landscape

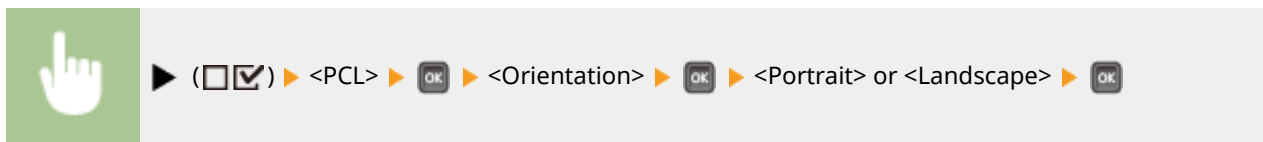

Font Number

Enables you to set the default font for this machine function using the corresponding font numbers. Valid font numbers are from 0 to 116.

0 + to 116



▶ () ▶ <PCL> ▶ ▶ ▶ ▶ Use the numeric keys to enter the font number ▶

Point Size *

If the number selected in is that of a proportionally spaced scalable font, this option appears in the <PCL> options. It enables you to specify a point size for the default font. The point size can be adjusted in increments of 0.25 pts.

4.00 to 12.00 + to 999.75 (point)



▶ () ▶ <PCL> ▶ ▶ <Point Size> ▶ ▶ Use the numeric keys to enter the setting value ▶

Pitch *

If the number selected in is that of a fixed pitch scalable font, <Pitch> appears in the <PCL> options. It enables you to specify the pitch for the default font. The pitch can be adjusted in increments of 0.01 cpi (characters per inch).

0.44 to 10.00 + to 99.99 (cpi)



▶ () ▶ <PCL> ▶ ▶ <Pitch> ▶ ▶ Use the numeric keys to enter the setting value ▶

Form Lines

Enables you to specify the number of lines to be printed on a page. You can specify from 5 to 128 lines.

5 to 64 + to 128 (lines)

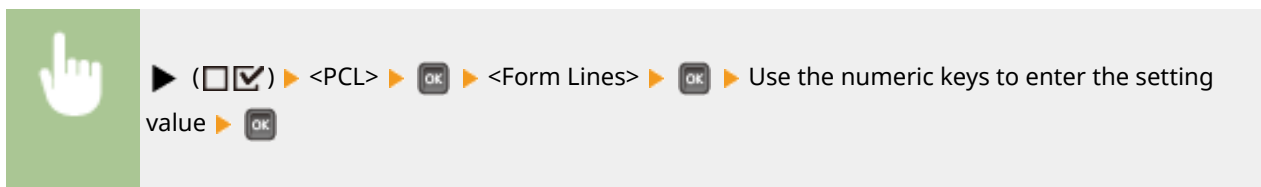

Character Code

Enables you to select the symbol set most suited to the needs of the host computer.

PC8 ⁺
 ROMAN8
 ROMAN9
 ISOL1
 ISOL2
 ISOL5
 ISOL6
 ISOL9
 PC775
 PC8DN
 PC850
 PC852
 PC858
 PC8TK
 PC1004
 WINL1
 WINL2
 WINL5
 WINBALT
 DESKTOP
 PSTEXT
 LEGAL
 ISO4
 ISO6
 ISO11
 ISO15
 ISO17
 ISO21
 ISO60
 ISO69
 WIN 30
 MCTEXT
 PC864
 ARABIC8
 WINARB
 PC866
 ISOCYR
 WINCYR
 PC851
 GREEK8
 ISOGRK
 PC8GRK
 WINGRK

PC862
HEBREW7
HEBREW8
ISOHEB

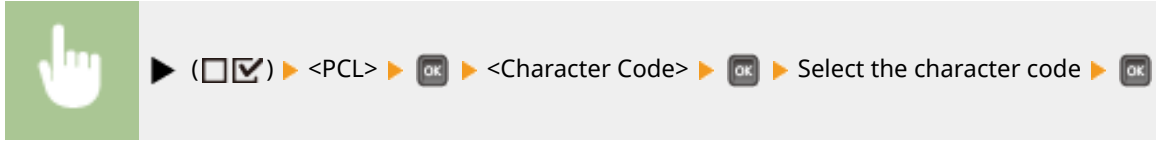

Custom Size

Enables you to specify a custom paper size. If <Set> is selected, you can enter a custom size.

Do Not Set [†]
Set

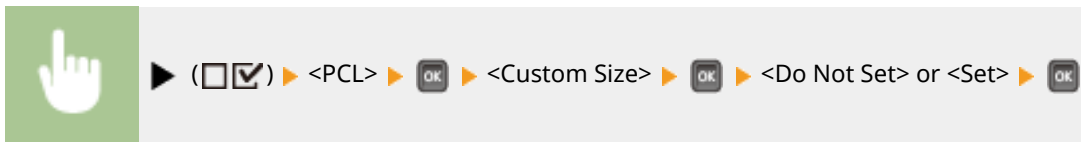

Unit of Measurement ^{*}

Enables you to specify the unit of measurement you would like to use to specify your custom paper size.

Millimeters [†]
Inches

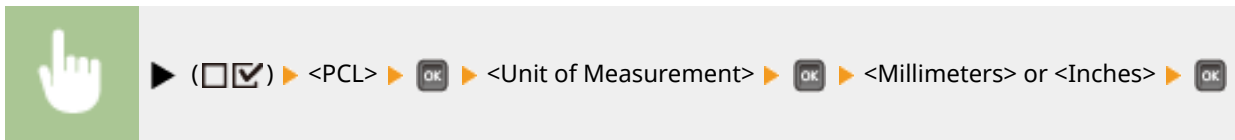

X Dimension ^{*}

Enables you to specify the X dimension of the custom paper. The X dimension can be adjusted between 76.0 mm and 216.0 mm in increments of 0.1 mm.

76.0 to 215.9 [†] to 216.0 mm



Y Dimension *

Enables you to specify the Y dimension of the custom paper. The Y dimension can be adjusted between 127.0 mm and 356.0 mm in increments of 0.1 mm.

127.0 to 355.6 † to 356.0 mm



Append CR to LF

Enables you to specify whether to append a carriage return (CR) when line feed code (LF) is received.

Yes
No †

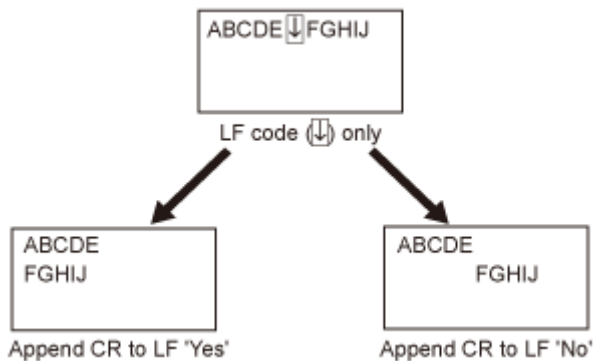
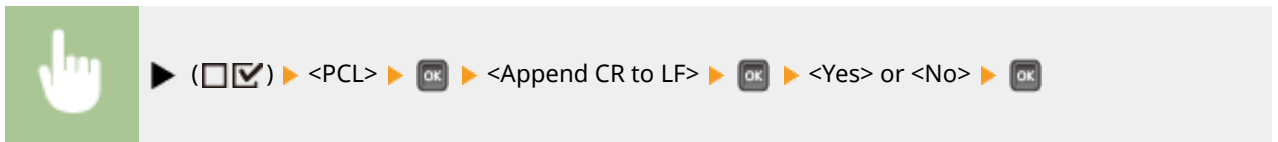

Enlarge A4 Prt Width

Determines whether to expand the printable area of A4 paper to that of Letter size in width.

Off †
On

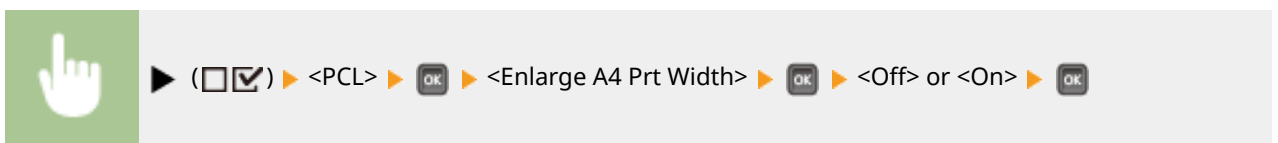

BarDIMM *

You can enable or disable the Bar Code Printing function of the machine.

Enable
Disable †

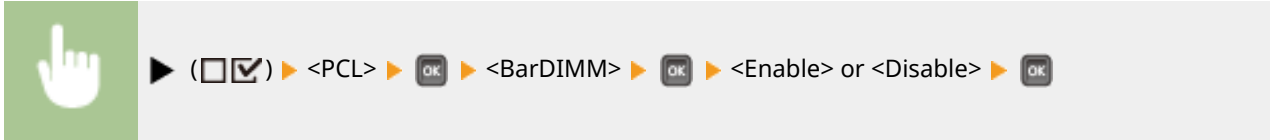

FreeScape *

You can specify the AEC (Alternate Escape Code) to be used for bar code commands when the host computer does not support the standard Escape Code.

Off
~ †
"

\$
/
\
?
{
}
|

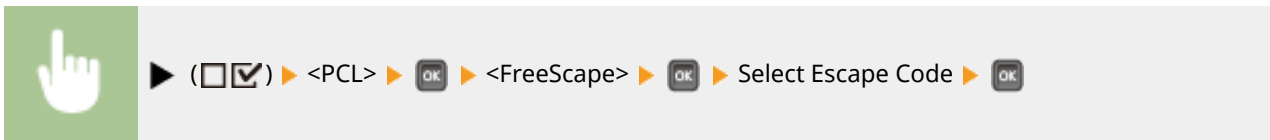

Imaging

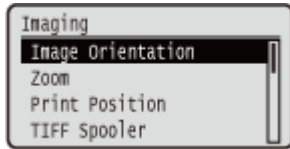

All the settings about image files (JPEG and TIFF files) available for USB Direct Print, Direct Print, and E-Mail Print are listed with short descriptions. Default settings are marked with a dagger (†).

NOTE

Asterisks (*)

- Settings marked with an asterisk (*) may not be displayed depending on the model you are using, options, or other setting items.

▶ **Image Orientation**(P. 381)

▶ **Zoom**(P. 382)

▶ **Print Position**(P. 382)

▶ **TIFF Spooler**(P. 383)

▶ **Show Warnings**(P. 383)

▶ **Print E-Mail Text**(P. 384)

▶ **Limit E-Mail Print**(P. 384)

▶ **Enlarge Print Area**(P. 385)

▶ **Halftones**(P. 385)

▶ **Grayscale Conversion**(P. 386)

Image Orientation

Specify the print orientation of an image.

Auto †
Vertical
Horizontal

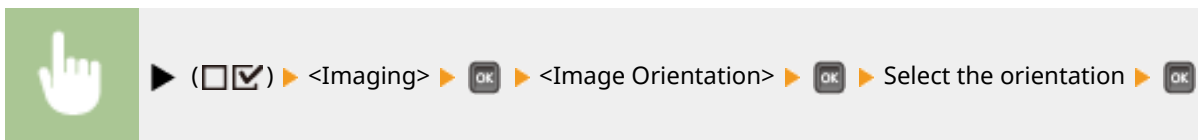

a <Auto>

Automatically determines the print orientation based on the width and height of the image.

b <Vertical>

Select when printing a vertically-long image.

c <Horizontal>

Select when printing a horizontally-long image.

NOTE

- If the specified setting (<Vertical> or <Horizontal>) does not match the orientation of the image, the image is printed at a reduced size.

Zoom

Enable or disable enlarging/reducing images. The printouts are enlarged or reduced with the image aspect ratio kept.

Off [†]
Auto

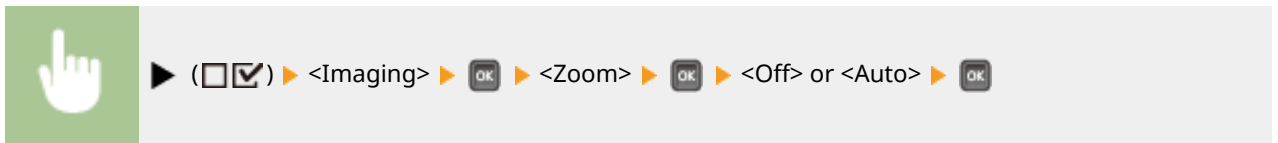

a <Off>

When an image is within printable area, it is printed at the original size. When an image is larger than the printable area, printouts are reduced.

b <Auto>

Makes enlarged or reduced printouts according to the printable area of the paper.

Print Position

Specify the position to print the image.

Auto [†]
Center
Top Left

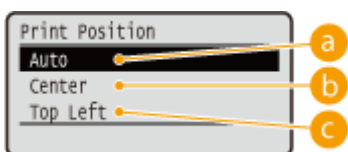
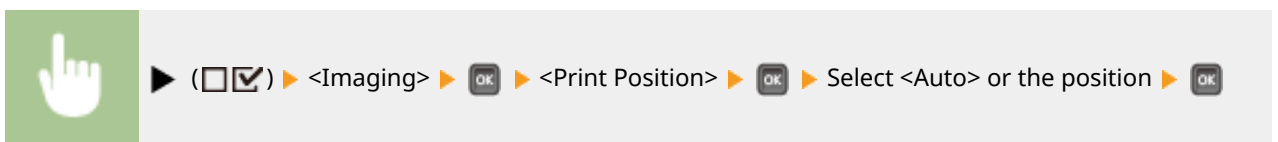

a <Auto>

If the TIFF data contains the information that specifies the print position, the image is printed according to the information, otherwise, it is printed at the center of paper. JPEG data is always printed at the center of paper.

b <Center>

Images are printed at the center of paper.

c <Top Left>

Images are printed at the top left.

TIFF Spooler

Select whether to store TIFF data in the SD card prior to processing it for printing. Set this item to <On> if an error occurs during printing.

Off[†]
On

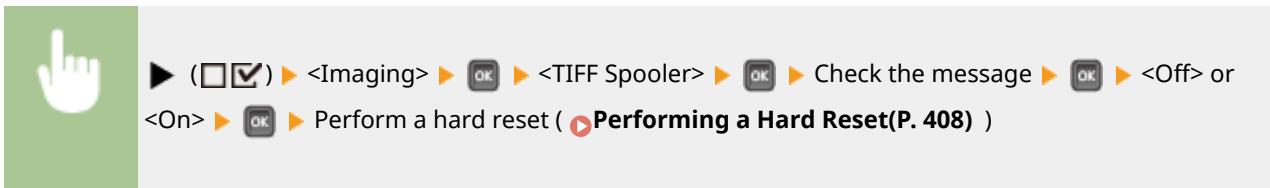

a <Off>

TIFF data is continuously processed as soon as it is received, reducing the processing time.

b <On>

All of received TIFF data is processed at one time, reducing the occurrence of errors. When an SD card is installed, the data is stored to the SD card.

Show Warnings

You can specify how the machine should behave if an error occurs.

Off
Print[†]
Panel

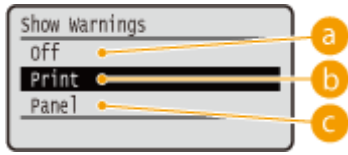
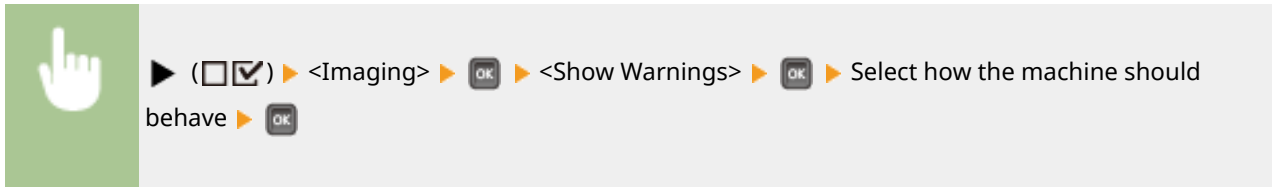

a <Off>

No image is printed and no error is displayed.

b <Print>

Error information is printed and no image is printed.

c <Panel>

No image is printed and an error message is displayed on the operation panel.

Print E-Mail Text

Select whether to print e-mail messages when E-Mail Print is performed. If you select <Off>, only an image attached to the e-mail is printed.

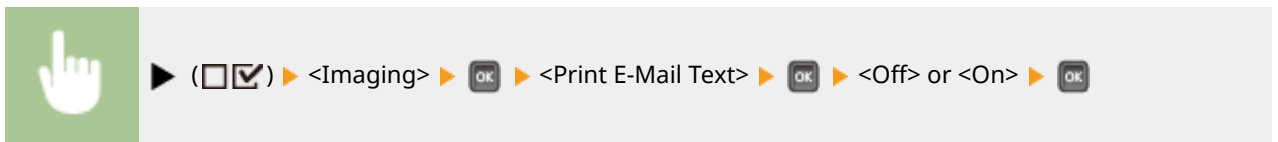

Limit E-Mail Print *

Select whether to limit the number of e-mail message pages to print when <Print E-Mail Text> is set to <On>. If you select <On>, the number of e-mail message pages to print is limited to 5.

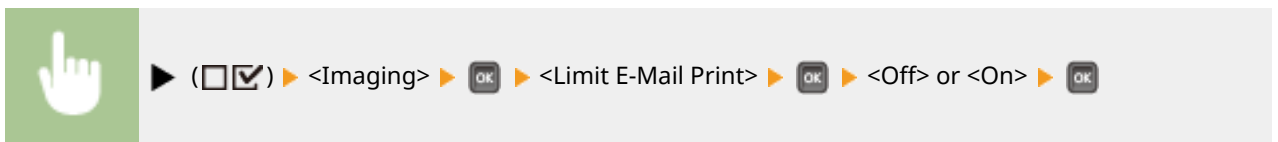

Enlarge Print Area

Specify whether or not to print the image by extending the printable area fully to the paper size.

Off[†]
On

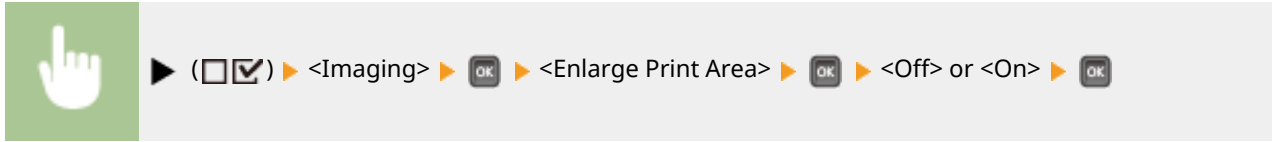

NOTE

- If you select <On>, some portions of the image may be missing near the edge of the paper or the paper may be partly tainted depending on the original.

Halftones

You can select the printing method to reproduce halftones (the intermediate range between the lighter and darker areas of an image).

Resolution
Gradation[†]
High Resolution

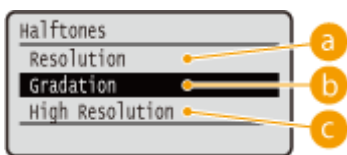
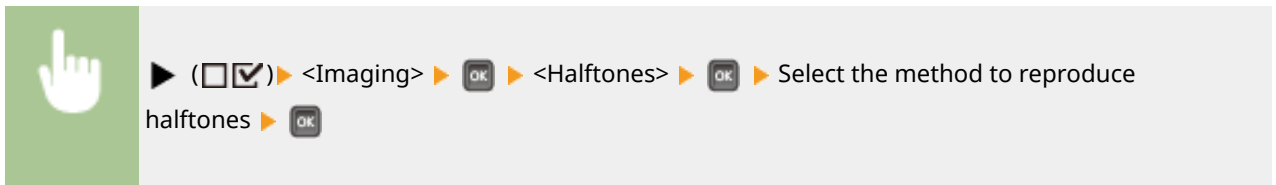

a <Resolution>

Performs fine printing by sharply reproducing the edges of characters. This print mode is suitable for printing data of characters and thin lines with a clear finish.

b <Gradation>

Prints gradation and lines with a smooth finish. This print mode is suitable for printing figures and charts with gradation.

c <High Resolution>

Implements higher definition printing than the <Resolution> setting, but is slightly inferior in stability of texture. This print mode is suitable for sharply printing edges of data such as characters, thin lines, and CAD data.

Grayscale Conversion

You can select the method to convert color print data to black-and-white data.

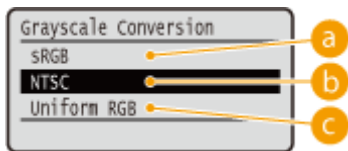

a <sRGB>

Color data is converted to black-and-white data to generate color-conscious smooth gradation.

b <NTSC>

Color data is converted to black-and-white data to generate appearances equivalent to television pictures (NTSC).

c <Uniform RGB>

Color data is converted to black-and-white data to equalize all RGB levels based on the brightness only.

XPS

51W4-05U

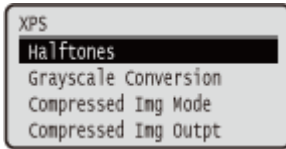

All the settings about XPS files available for USB Direct Print and Direct Print are listed with short descriptions. Default settings are marked with a dagger (†).

NOTE

Asterisks (*)

- Settings marked with an asterisk (*) may not be displayed depending on the model you are using, options, or other setting items.

- ▶ **Halftones(P. 387)**
- ▶ **Grayscale Conversion(P. 388)**
- ▶ **Compressed Img Mode(P. 389)**
- ▶ **Compressed Img Outpt(P. 390)**

Halftones

You can select the printing method to reproduce halftones (the intermediate range between the lighter and darker areas of an image). Halftones can be specified for each image data type in a single document.

Text
Resolution †
Gradation
High Resolution
Graphics
Resolution †
Gradation
High Resolution
Image
Resolution †
Gradation
High Resolution

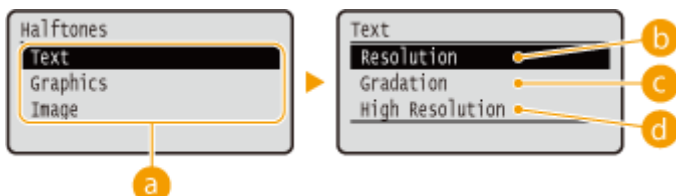
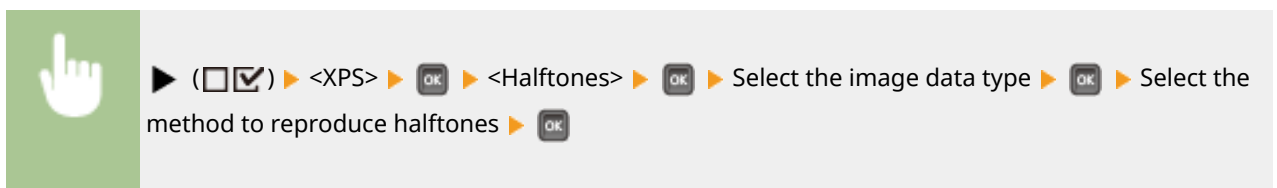

a Image data type

Select the image data type for which the settings are changed. Select <Text> for characters, <Graphics> for lines and figures, or <Image> for images such as photos.

b <Resolution>

Performs fine printing by sharply reproducing the edges of characters. This print mode is suitable for printing data of characters and thin lines with a clear finish.

c <Gradation>

Prints gradation and lines with a smooth finish. This print mode is suitable for printing figures and charts with gradation.

d <High Resolution>

Implements higher definition printing than the <Resolution> setting, but is slightly inferior in stability of texture. This print mode is suitable for sharply printing edges of data such as characters, thin lines, and CAD data.

Grayscale Conversion

You can select the method to convert color print data to black-and-white data. You can specify the conversion method for each image data type: <Text>, <Graphics>, and <Image>.

<p>Text sRGB NTSC † Uniform RGB</p> <p>Graphics sRGB NTSC † Uniform RGB</p> <p>Image sRGB NTSC † Uniform RGB</p>
--

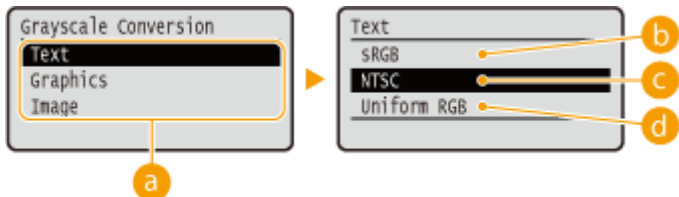
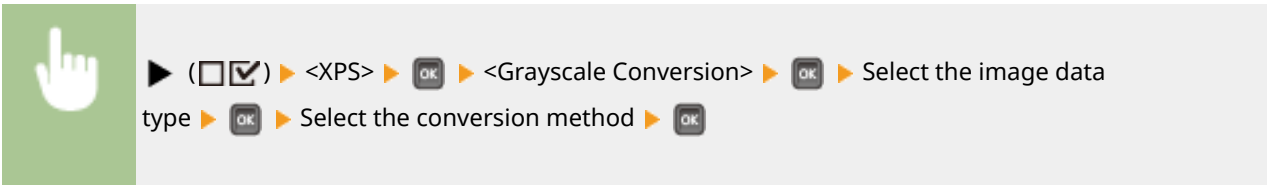

a Image data type

Select the image data type for which you want to specify the conversion method.

b <sRGB>

Color data is converted to black-and-white data to generate color-conscious smooth gradation.

c <NTSC>

Color data is converted to black-and-white data to generate appearances equivalent to television pictures (NTSC).

d <Uniform RGB>

Color data is converted to black-and-white data to equalize all RGB levels based on the brightness only.

Compressed Img Mode *

Specify how the machine should behave when the machine is running out of memory during XPS file printing.

Image Priority †

Output Priority

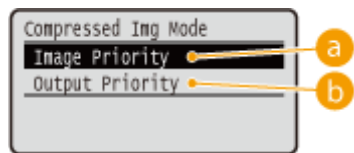
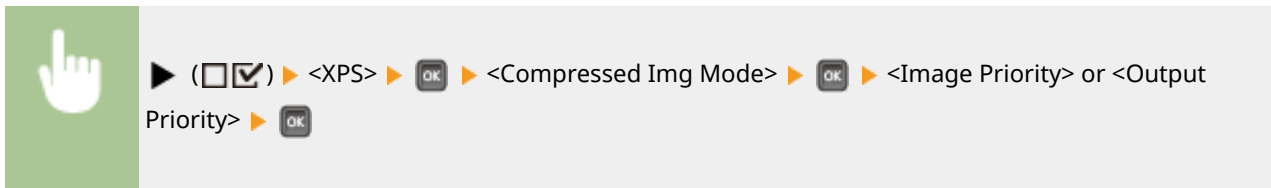

a <Image Priority>

Cancels printing before the quality is reduced when insufficient memory is available.

b <Output Priority>

Continues printing even if the quality is reduced due to insufficient memory.

NOTE

- You can specify this item when no SD card is used. If <SD Card> is set to <On>, the machine always operates with <Output Priority> selected (**SD Card(P. 318)**).

Compressed Img Outpt

If <Compressed Img Mode> is set to <Output Priority>, the quality may be reduced over time depending on image data. You can specify how the machine should behave if the quality is excessively reduced.

Output †
Display Error

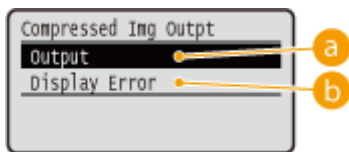
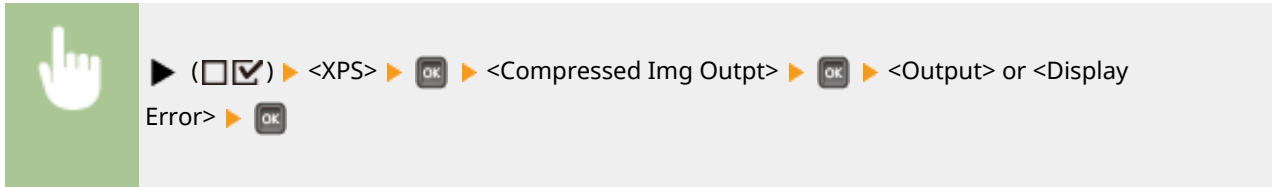

a <Output>

Continues printing regardless of how the quality is reduced.

b <Display Error>

Displays an applicable error message and cancels printing when the quality is excessively reduced.

NOTE

- This setting is valid when <Compressed Img Mode> is set to <Output Priority> or <SD Card> (**SD Card(P. 318)**) is set to <On>.

PDF

51W4-05W

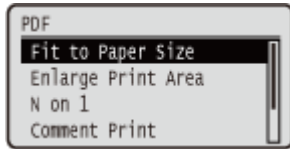

All the settings about PDF files available for USB Direct Print and Direct Print are listed with short descriptions. Default settings are marked with a dagger (†).

- ▶ **Fit to Paper Size**(P. 391)
- ▶ **Enlarge Print Area**(P. 391)
- ▶ **N on 1**(P. 392)
- ▶ **Comment Print**(P. 392)
- ▶ **Halftones**(P. 392)
- ▶ **Grayscale Conversion**(P. 393)

Fit to Paper Size

Specify whether to enlarge or reduce printouts according to the printable area of paper. The printouts are enlarged or reduced with the original aspect ratio kept.

Off †
On

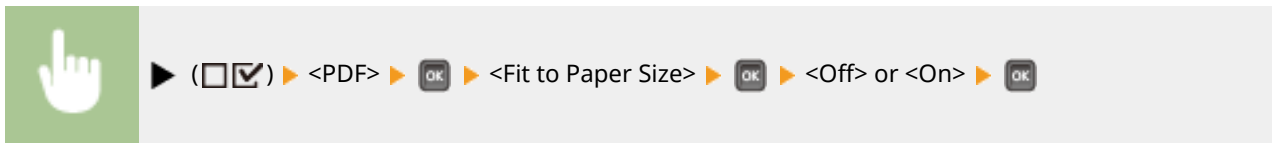

Enlarge Print Area

Specify whether or not to print the image by extending the printable area fully to the paper size.

Off †
On

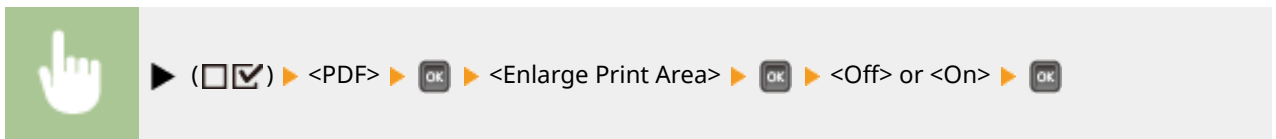

NOTE

- If you select <On>, some portions of the image may be missing near the edge of the paper or the paper may be partly tainted depending on the original.

N on 1

Select whether to print multiple pages onto a single sheet at a reduced size by sequentially allocating them from the top left. For example, to print four pages onto a single sheet, select <4 on 1>.

Off †
 2 on 1
 4 on 1
 6 on 1
 8 on 1
 9 on 1
 16 on 1

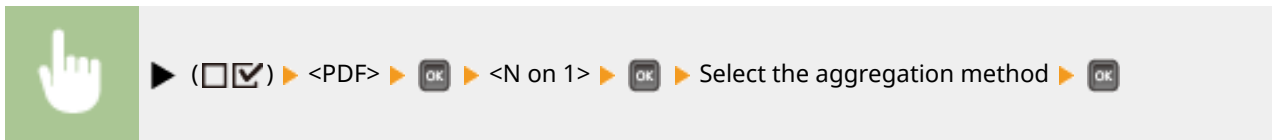

Comment Print

Select whether to print comments. If you select <Auto>, comments in the PDF file are printed.

Off
 Auto †

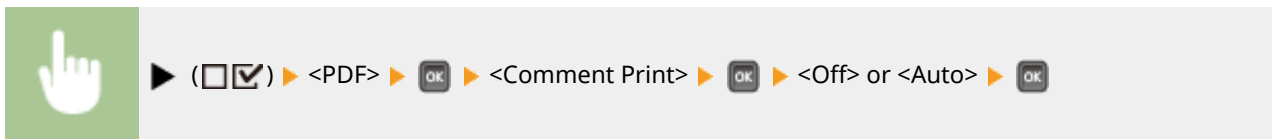

Halftones

You can select the printing method to reproduce halftones (the intermediate range between the lighter and darker areas of an image). Halftones can be specified for each image data type in a single document.

Text
 Resolution †
 Gradation
 High Resolution

Graphics
 Resolution †
 Gradation
 High Resolution

Image
 Resolution †
 Gradation
 High Resolution

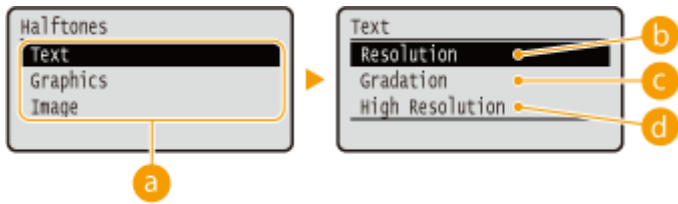
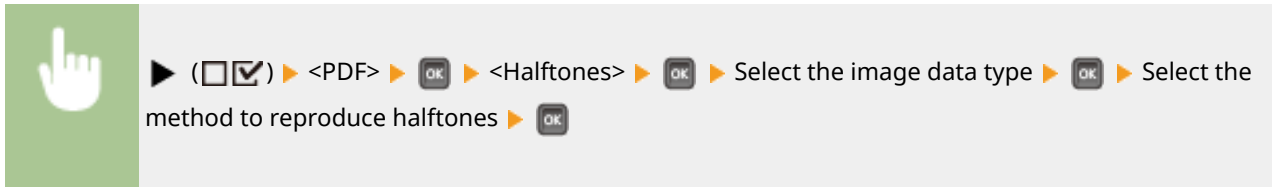

a Image data type

Select the image data type for which the settings are changed. Select <Text> for characters, <Graphics> for lines and figures, or <Image> for images such as photos.

b <Resolution>

Performs fine printing by sharply reproducing the edges of characters. This print mode is suitable for printing data of characters and thin lines with a clear finish.

c <Gradation>

Prints gradation and lines with a smooth finish. This print mode is suitable for printing figures and charts with gradation.

d <High Resolution>

Implements higher definition printing than the <Resolution> setting, but is slightly inferior in stability of texture. This print mode is suitable for sharply printing edges of data such as characters, thin lines, and CAD data.

Grayscale Conversion

You can select the method to convert color print data to black-and-white data.

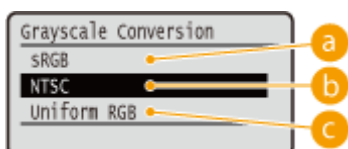
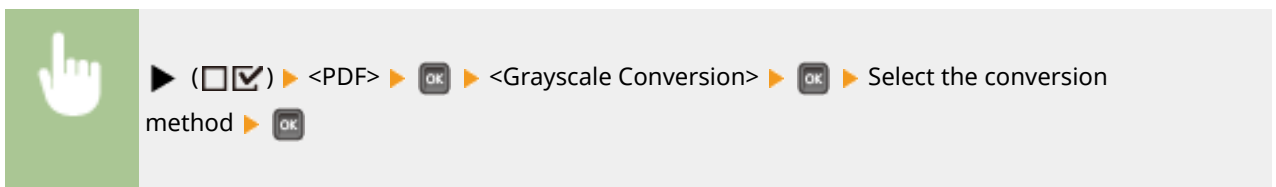
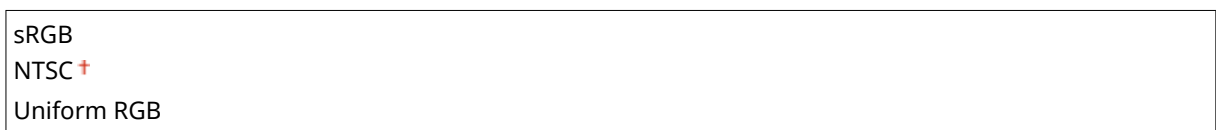

a <sRGB>

Color data is converted to black-and-white data to generate color-conscious smooth gradation.

b <NTSC>

Color data is converted to black-and-white data to generate appearances equivalent to television pictures (NTSC).

c <Uniform RGB>

Color data is converted to black-and-white data to equalize all RGB levels based on the brightness only.

PS

51W4-05X

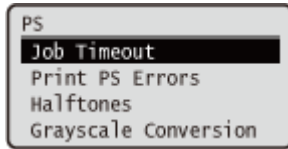

All the settings about the PS control commands are listed with short descriptions. Default settings are marked with a dagger (†).

- ▶ **Job Timeout(P. 395)**
- ▶ **Print PS Errors(P. 395)**
- ▶ **Halftones(P. 395)**
- ▶ **Grayscale Conversion(P. 396)**

Job Timeout

If the time specified in this item has elapsed since a job process was started, the machine automatically finishes the job and receives the next job.

If you do not want to specify the timeout, specify "0 seconds."

0 † to 3600 (seconds)

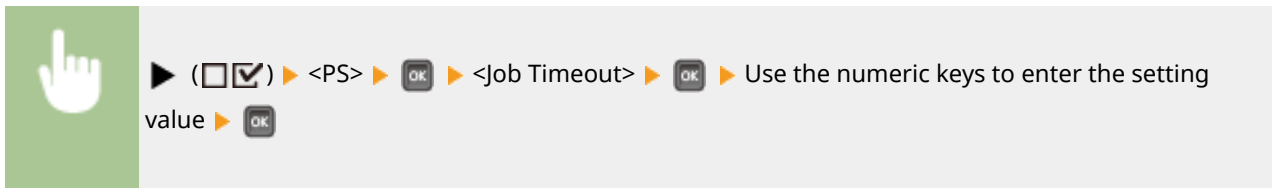

Print PS Errors

Specifies whether an error page should be printed when a PostScript error is occurring.

Off †
On

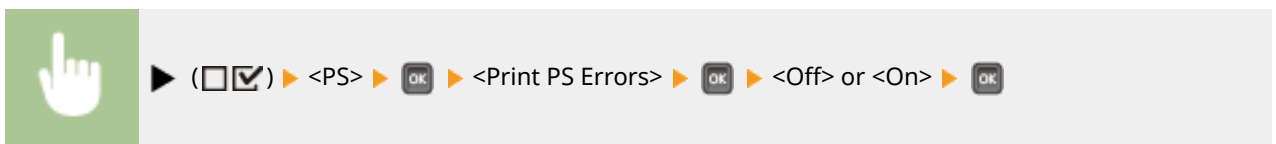

Halftones

You can select the printing method to reproduce halftones (the intermediate range between the lighter and darker areas of an image). Halftones can be specified for each image data type in a single document.

Text
Resolution †
Gradation

High Resolution
Graphics
Resolution †
Gradation
High Resolution
Image
Resolution †
Gradation
High Resolution

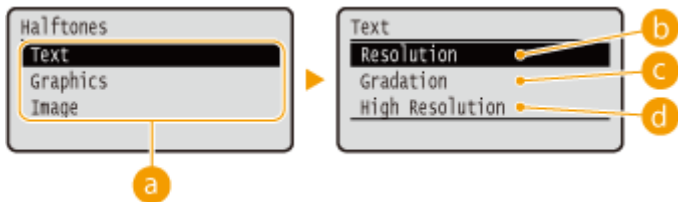

a Image data type

Select the image data type for which the settings are changed. Select <Text> for characters, <Graphics> for lines and figures, or <Image> for images such as photos.

b <Resolution>

Performs fine printing by sharply reproducing the edges of characters. This print mode is suitable for printing data of characters and thin lines with a clear finish.

c <Gradation>

Prints gradation and lines with a smooth finish. This print mode is suitable for printing figures and charts with gradation.

d <High Resolution>

Implements higher definition printing than the <Resolution> setting, but is slightly inferior in stability of texture. This print mode is suitable for sharply printing edges of data such as characters, thin lines, and CAD data.

Grayscale Conversion

You can select the method to convert color print data to black-and-white data.

sRGB
NTSC †
Uniform RGB

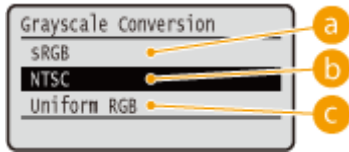

a <sRGB>

Color data is converted to black-and-white data to generate color-conscious smooth gradation.

b <NTSC>

Color data is converted to black-and-white data to generate appearances equivalent to television pictures (NTSC).

c <Uniform RGB>

Color data is converted to black-and-white data to equalize all RGB levels based on the brightness only.

MEAP Settings

51W4-05Y

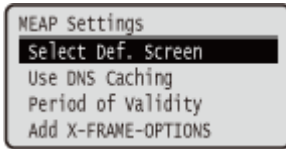

The setting items about the main screen on MEAP are listed with short descriptions. Default settings are marked with a dagger (†).

NOTE

Asterisks (*)

- Settings marked with an asterisk (*) may not be displayed depending on the model you are using, options, or other setting items.

- ▶ **Select Def. Screen**(P. 398)
- ▶ **Use DNS Caching**(P. 399)
- ▶ **Period of Validity**(P. 399)
- ▶ **Add X-FRAME-OPTIONS**(P. 399)

Select Def. Screen

You can specify the screen that appears on the display of the operation panel when the machine starts up.

Print Screen †
MEAP

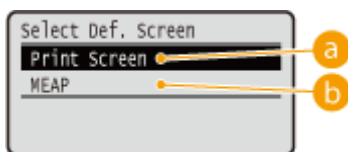



a <Print Screen>

The print standby screen (main screen) is displayed.

b <MEAP>

The screen of an installed MEAP application is displayed if any installed.

NOTE

- You can press  () on the operation panel to change the screens of the display.

Use DNS Caching

You can specify whether to hold in memory the DNS information with which search by a MEAP application has succeeded. Selecting <On (Specify Period)> allows for temporary holding and makes it possible to specify a valid holding period (**▶Period of Validity(P. 399)**).

Off [†]
 On (Unlimited Use)
 On (Specify Period)



Period of Validity ^{*}

When the setting of <Use DNS Caching> is <On (Specify Period)>, specify the time period for which to hold the DNS information in memory.

1 to 60 [†] to 120 (seconds)

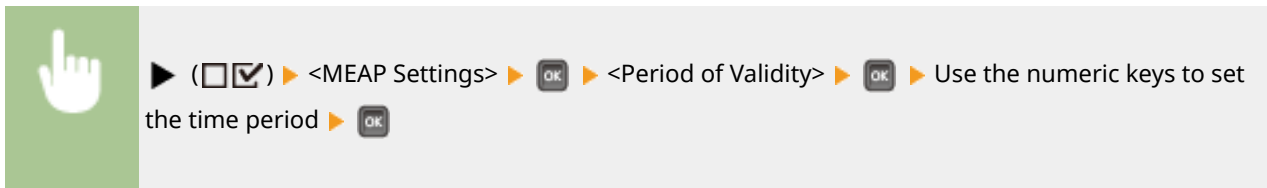

Add X-FRAME-OPTIONS

Specify whether to add X-FRAME-OPTIONS to the header when the HTTP server returns a response. Adding X-FRAME-OPTIONS prevents the information from overlapping on contents generated by other servers.

Off
 On [†]

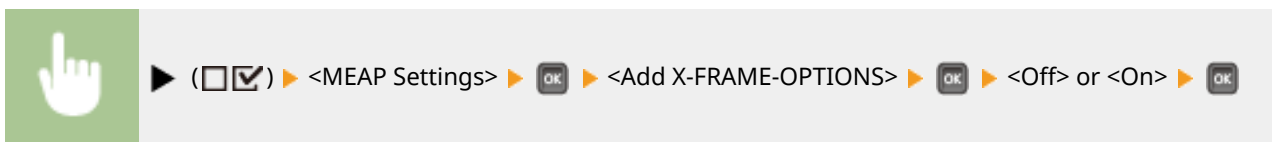

Check Counter

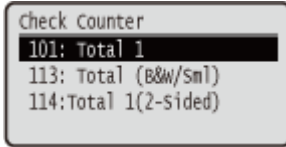

You can check the total number of printed pages.

NOTE

- You can also check the counter value by selecting <Check Counter> in the **▶Utility Menu(P. 402)** as well as this item.

101: Total 1

You can check the total number of pages printed.

(Display only)

113: Total (B&W/Sml)

You can check the total number of pages printed.

(Display only)

114: Total 1(2-Sided)

You can check the total number of pages printed in 2-sided printing mode.

(Display only)

Initialize Menu

51W4-061

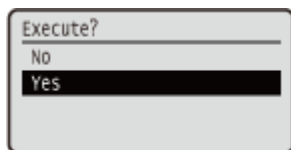

Select to restore the settings of the Setup menu listed below to the factory defaults.
▶ **Initializing Menu(P. 456)**

NOTE

Settings that cannot be initialized

- You cannot initialize the settings specified for <Network> and <Adj. Print Position>. When you want to initialize the <Network> settings, see ▶ **Initializing the Network Settings(P. 457)** . When you want to initialize the <Adj. Print Position> settings, manually restore them to the factory default settings (▶ **Adj. Print Position(P. 358)**).

Utility Menu

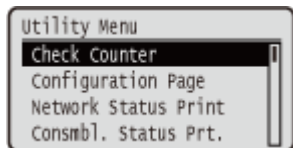

You can display the total number of printed pages and print internal system information. When you press ◀ () on the operation panel, the Utility menu is displayed. You can specify the settings described below when the machine is offline.

- ▶ **Check Counter(P. 402)**
- ▶ **Configuration Page(P. 402)**
- ▶ **Network Status Print(P. 403)**
- ▶ **Consmb1. Status Prt.(P. 403)**
- ▶ **IPSec Policy List(P. 403)**
- ▶ **PCL Utility(P. 403)**
- ▶ **PS Utility(P. 403)**
- ▶ **Cleaning(P. 403)**
- ▶ **E-Mail Print Utility(P. 403)**
- ▶ **Printing Pos. Print(P. 404)**
- ▶ **Page Count List(P. 404)**
- ▶ **Counter Report(P. 404)**
- ▶ **Print MEAP Sys. Info(P. 404)**
- ▶ **Cartridge Log Print(P. 404)**
- ▶ **Serial Number(P. 404)**
- ▶ **Consumables Info.(P. 404)**

Check Counter

You can check the total number of printed pages. ▶ **Checking Total Number of Printed Pages(P. 450)**

NOTE

- You can also check the counter value by selecting <Check Counter> in the ▶ **Setup Menu(P. 310)** as well as this item.

101: Total 1

You can check the total number of pages printed.

(Display only)

113: Total (B&W/Sml)

You can check the total number of pages printed.

(Display only)

114:Total 1(2-Sided)

You can check the total number of pages printed in 2-sided printing mode.

(Display only)

Configuration Page

You can check the machine settings (▶ **Setup Menu(P. 310)**) configured in the machine. You can also check other information such as the toner cartridge status, the number of printed pages, and the capacity of the memory (RAM) mounted on the machine. ▶ **Configuration Page(P. 441)**

Network Status Print

Select to print a list of the settings ([▶Network\(P. 326\)](#)) about the network configured in the machine. You can also check the information about the security including the address filter settings and IPSec settings. [▶Network Status Print\(P. 441\)](#)

Consmbl. Status Prt.

You can print information such as toner cartridge status, warning messages, and information on where you can purchase new toner cartridges. [▶Consmbl. Status Prt.\(P. 442\)](#)

IPSec Policy List

Select to print a list of the IPSec policy names and settings ([▶Configuring IPSec Settings\(P. 251\)](#)) configured in the machine. [▶IPSec Policy List\(P. 442\)](#)

PCL Utility

Select to print a list of the internal information items registered in the machine for use of the PCL mode.

Font List

Select to print a list of the fonts that can be used in the PCL mode. [▶PCL Font List\(P. 445\)](#)

PS Utility

Select to print a list of the settings for use of the PS mode and the internal information items registered in the machine. [▶PS Mode List\(P. 446\)](#)

Configuration Page

Select to print a list of the machine settings ([▶PS\(P. 395\)](#)).

Font List

Select to print a list of the fonts that can be used in the PS mode.

Cleaning

Select to clean the fixing unit when black spots or streaks appear on printouts. [▶Fixing Unit\(P. 424\)](#)

E-Mail Print Utility

Select to manually receive e-mails and print a log of received e-mails in list form.

Received E-Mail

Select to manually receive e-mails from the POP3 mail server and print them. [▶Manually Receiving E-Mails\(P. 115\)](#)

E-Mail RX Log List

Select to print a log consisting of subjects and received date/time of e-mails received in the machine in list form. [▶E-Mail Print Log\(P. 449\)](#)

Printing Pos. Print

Select to print marks that indicate the current print position. [▶Adjusting Print Position\(P. 436\)](#)

Page Count List

Select to print a report on the number of printed pages for each department when Department ID Management is enabled. [▶Page Count List\(P. 443\)](#)

Counter Report

Prints an aggregate report of the number of pages printed for each counter. [▶Counter Report\(P. 444\)](#)

Print MEAP Sys. Info

Select to print a list of information about MEAP applications installed in the machine and the MEAP system applications when the MEAP function is enabled. [▶Print MEAP Sys. Info\(P. 444\)](#)

Cartridge Log Print

Prints logs of usage of toner cartridge in the form of a list. [▶Cartridge Log Print\(P. 445\)](#)

Serial Number

Select to display the serial number of the machine.

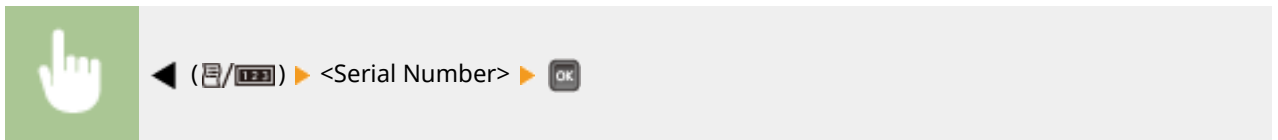

Consumables Info.

Select to display the information about the paper and toner cartridge.

Paper Information

Select to display the currently specified paper size and paper type, and the remaining paper level for each paper source. [▶Checking Paper\(P. 453\)](#)

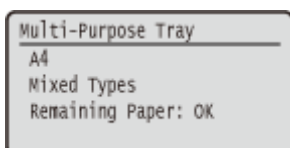

Toner Cart. Model

Select to display the model number of the toner cartridge for the machine. [▶Checking the Toner Cartridge Model\(P. 453\)](#)

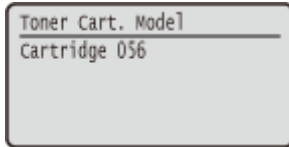

Remaining Toner

Displays the toner cartridge status. [▶Checking the Toner Cartridge Status\(P. 453\)](#)



NOTE

- The displayed toner cartridge status can be used only as a guide and may differ from the actual level.

Job Menu

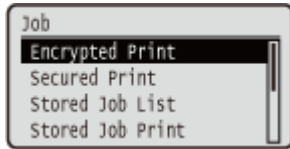

You can print documents stored in the SD card and a print log. When you press ▲ (↔) on the operation panel, the Job menu is displayed. You can specify the settings described below when the machine is offline.

NOTE

Asterisks (*)

- Settings marked with "*1" may not be displayed depending on the model you are using, options, or other setting items.
- Settings marked with "*2" may not be displayed when [Display Job Log] check box of the Remote UI is not selected. ▶ **Hiding the Print Job History(P. 243)**

- ▶ **Encrypted Print(P. 406)**
- ▶ **Secured Print(P. 406)**
- ▶ **Stored Job List(P. 406)**
- ▶ **Stored Job Print(P. 406)**
- ▶ **Job Print Log(P. 407)**
- ▶ **Stored Job Print Log(P. 407)**
- ▶ **Report Print Log(P. 407)**
- ▶ **E-Mail Print Log(P. 407)**

Encrypted Print *1

Select to print encrypted secured documents that you sent to the machine from the computer. ▶ **Printing Out Secured Documents(P. 89)**

Secured Print *1

Select to print secured documents that you sent to the machine from the computer. ▶ **Printing Out Secured Documents(P. 89)**

Stored Job List *1

Select to print a list of documents stored in the SD card installed on the machine. ▶ **Stored Job List(P. 447)**

Stored Job Print *1

Select to print documents stored in the SD card installed on the machine. ▶ **Printing a Document Stored in the Machine(P. 94)**

Job Print Log *2

Select to print a log of documents printed from the computer in list form. ▶ **Job Print Log(P. 447)**

Stored Job Print Log *1*2

Select to print a print log of documents stored in the SD card installed on the machine in list form. ▶ **Stored Job Print Log(P. 448)**

Report Print Log *2

Select to print the settings and a print log of reports in list form. ▶ **Report Print Log(P. 448)**

E-Mail Print Log *2

Select to print a print log of received e-mails in list form. ▶ **E-Mail Print Log(P. 449)**

Reset Menu



You can cancel all processes, delete data in memory, and turn OFF the power. When you press ▼ (//) on the operation panel, the Reset menu is displayed.

- ▶ **Soft Reset(P. 408)**
- ▶ **Form Feed(P. 409)**
- ▶ **Shut Down(P. 409)**

NOTE

- When the message Ennn-nnnn (n is a number) is displayed, only <Shut Down> can be executed.

Soft Reset

Select to erase all data of print jobs that are not yet finished (soft reset). You can also select this item to perform a hard reset for enabling the changed settings.

IMPORTANT

- Make sure to check that other users are not using the machine before performing a soft reset or hard reset, otherwise, all print data is erased before being printed.

■ Performing a Soft Reset

Perform a soft reset when you want to erase all print data that is being printed, waiting to be printed, or being received.

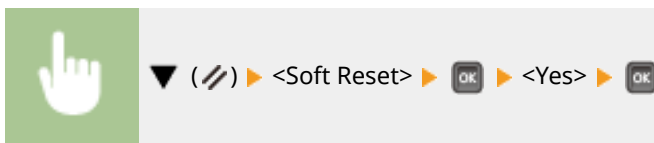

■ Performing a Hard Reset

Perform a hard reset when you want to enable the changed settings of machine or to erase data registered in memory of the machine.

- 1 Press ▼ (//).

NOTE:

- If the setting menu is displayed, first press  (●—●) to return to the main screen and then perform this step 1.

- 2** Use ▲ / ▼ to select <Soft Reset>, press and hold  for 5 seconds or more, and release it.



⇒ The message <Execute hard reset?> is displayed.

- 3** Select <Yes>, and press .

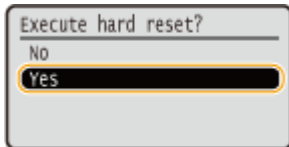

⇒ When a hard reset is executed, the machine is restarted.

NOTE

- When a soft reset or hard reset is performed, secured documents stored in the optional SD card are also deleted.

Form Feed

If printing is canceled from the computer or the communication is interrupted during data reception, the data may remain in the memory of the machine, preventing the printing from finishing. The next print data cannot be printed with the remaining data left as is. In this case, select <Form Feed> to forcibly print the data remaining in memory.

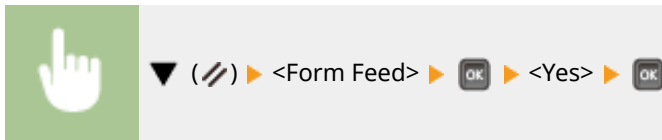

NOTE

- If the remaining data is not printed, perform a soft reset.
- If the data still remains in the memory of the machine after a form feed is performed (the [Job] indicator is lit on the machine), perform a soft reset.

Shut Down

When turning OFF the machine, shut down the machine from the operation panel without using the power switch. ▶ **Turning OFF the Power (Performing a Shutdown)(P. 35)**

Select Feeder Menu

51W4-065

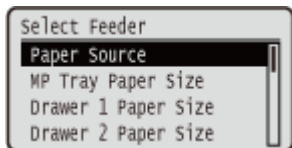

The settings about the paper source and the size of paper loaded in the machine are listed with short descriptions. When you press () on the operation panel, the Select Feeder menu is displayed. Default settings are marked with a dagger (†).

NOTE

Common settings

- The settings are the same as those for <Paper Source> in the **Setup Menu(P. 310)** . The settings specified here are also applied to the <Paper Source> settings.

Asterisks (*)

- Settings marked with an asterisk (*) may not be displayed depending on the model you are using, options, or other setting items.

- | | |
|---|---|
| Paper Source(P. 410) | Default Paper Type(P. 414) |
| MP Tray Paper Size(P. 410) | MP Tray Paper Type(P. 414) |
| Drawer N Paper Size (N=1, 2, 3, 4)(P. 411) | Drawer N Paper Type (N=1, 2, 3, 4)(P. 415) |
| Standard Paper Size(P. 411) | Manual 2-Sided (MP)(P. 415) |
| MP Tray Priority(P. 412) | 2-Sided Printing(P. 416) |
| MP Tray for Mix Ppr.(P. 413) | |
| Auto Select Drawer(P. 413) | |

Paper Source

Select the paper source from which paper is fed. When you want to automatically change the paper source based on the paper size and paper type, select <Auto>.

Auto †
Multi-Purpose Tray
Drawer 1
Drawer 2 *
Drawer 3 *
Drawer 4 *



() ▶ <Paper Source> ▶ ▶ Select the paper source ▶

MP Tray Paper Size

Specify the size of the paper that is loaded in the multi-purpose tray. **Specifying Paper Size and Type in the Multi-Purpose Tray(P. 60)**

A6
 A5
 A5R
 B5
 A4 †
 LTR
 LGL
 EXEC
 Free Size
 Custom Size
 Custom Size R
 Postcard
 Reply Postcard
 4on1 Postcard
 Env. Nagagata3
 Env. Younaga 3
 Env. ISO-C5
 Env. Monarch
 Env. No.10
 Env. DL
 India-LGL
 Index Card
 STMT
 FLSC
 16K

Drawer N Paper Size (N=1, 2, 3, 4) *

Set the size of paper loaded in the machine's paper drawer or optional paper feeder's paper drawer. **▶Specifying Paper Size and Type in the Paper Drawer(P. 58)**

A6
 A5
 A5R
 B5
 A4 †
 LTR
 LGL
 EXEC
 Free Size
 Custom Size
 Custom Size R
 India-LGL
 STMT
 FLSC
 16K

Standard Paper Size

Set the default paper size. Printing will be performed with the paper size set here when you want to print from an OS not supporting printer drivers or a mobile device or other device not supporting paper size settings.

A6

- A5
- B5
- A4 †
- LTR
- LGL
- EXEC
- Postcard
- Reply Postcard
- 4on1 Postcard
- Env. Nagagata3
- Env. Younaga 3
- Env. ISO-C5
- Env. Monarch
- Env. No.10
- Env. DL
- India-LGL
- Index Card
- STMT
- FLSC
- 16K

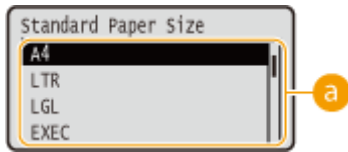
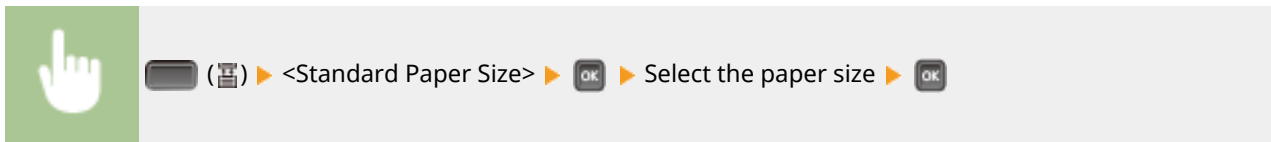

a Selecting the paper size

Specify the setting according to the size of the paper to print on.

MP Tray Priority

Select whether to prioritize paper feeding from the multi-purpose tray when <Paper Source> is set to <Auto>. If you select <On>, paper is fed from the multi-purpose tray when the same size paper is loaded in both the multi-purpose tray and the paper drawer.

- Off †
- On

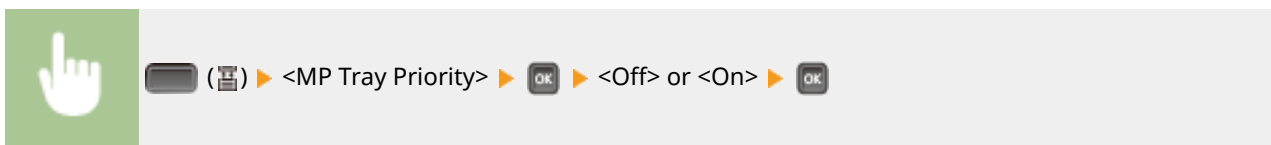

NOTE

- When <MP Tray for Mix Ppr.> is set to <On>, paper is preferentially fed from the paper drawer even if <MP Tray Priority> is set to <On>.

MP Tray for Mix Ppr.

If you select <On> with <Paper Source> set to other than <Multi-Purpose Tray>, the multi-purpose tray is automatically selected when appropriate size paper is not loaded in any paper drawer.

Off⁺
On



Auto Select Drawer

If you select <Use> with <Paper Source> set to <Auto>, the machine automatically selects the paper source with appropriate size paper loaded. Also, when the paper runs out, this setting enables continuous printing by switching from one paper source to another that is loaded with the same paper size.

Do Not Use
Use⁺

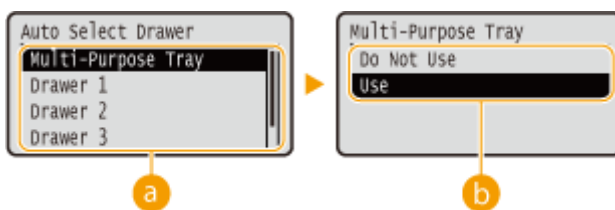
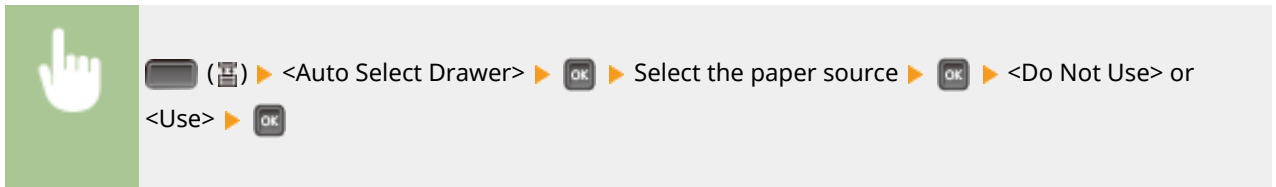

a Paper source selection

Select the paper source to which you want to apply the Auto Select Drawer function.

b Switching of the settings

Select <Use> to enable automatic drawer selection for the paper source you selected on the previous screen (a).

Default Paper Type

Set the default paper type. Printing will be performed with the paper type set here when you want to print from an OS not supporting printer drivers or a mobile device or other device not supporting paper type settings.

Thin 1
Plain 1
Plain 2 +
Heavy 1
Heavy 2
Heavy 3
Heavy 4
Postcard
Envelope
Envelope H
Labels
Bond 1
Bond 2
Bond 3

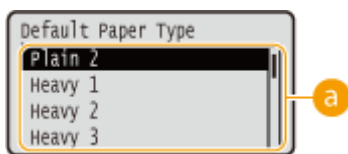
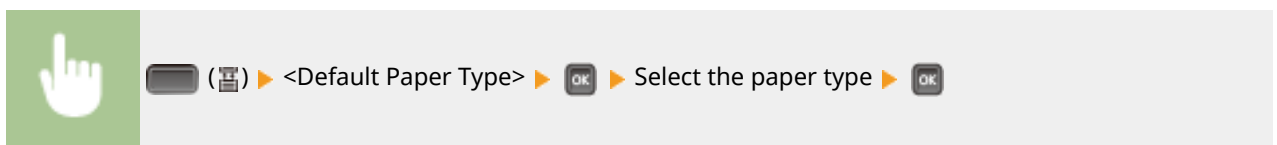

a Paper type selection

Specify the settings in the same way as the paper settings in the printer driver according to the paper type for printing. ▶ **Loading Paper(P. 39)**

NOTE

- Printing will be performed with the paper type set here if [Paper Type] is set to [Printer Default] on the printer driver side and the type of the paper loaded in the paper source is set to <Mixed Types> on the machine side.

MP Tray Paper Type

Set the type of paper loaded in the multi-purpose tray. ▶ **Specifying Paper Size and Type in the Multi-Purpose Tray(P. 60)**

Thin 1
Plain 1
Plain 2
Heavy 1
Heavy 2

Heavy 3
 Heavy 4
 Postcard
 Envelope
 Envelope H
 Labels
 Bond 1
 Bond 2
 Bond 3
 Mixed Types †

Drawer N Paper Type (N=1, 2, 3, 4) *

Set the type of paper loaded in the paper drawer. ▶ **Specifying Paper Size and Type in the Paper Drawer(P. 58)**

Thin 1
 Plain 1
 Plain 2
 Heavy 1
 Heavy 2
 Bond 1
 Bond 2
 Bond 3
 Mixed Types †

Manual 2-Sided (MP)

If printouts on the back side of printed paper are too light, select <2nd Side>.

1st Side †
 2nd Side

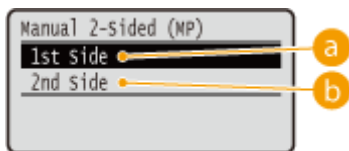
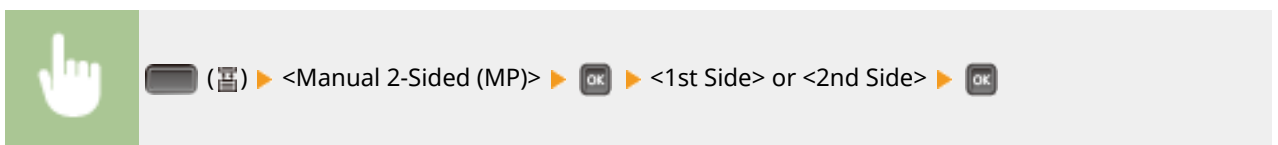

a <1st Side>

Select to print on the front side (the side to print first).

b <2nd Side>

Select to print on the back side (the opposite of the side that is already printed).

2-Sided Printing

Select whether to print on both sides of paper.

Off ⁺
On

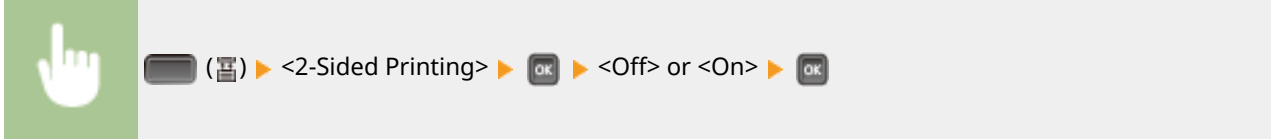

Troubleshooting (FAQ)

Troubleshooting (FAQ) 418

Troubleshooting (FAQ)

51W4-066

When a problem occurs, check this chapter to find out solutions before contacting Canon.

Maintenance

Maintenance	420
Cleaning the Machine	422
Exterior	423
Fixing Unit	424
Replacing the Toner Cartridges	425
Relocating the Machine	431
Maintaining and Improving Print Quality	433
Adjusting Print Density	434
Adjusting Print Position	436
Printing Reports and Lists	441
Viewing the Counter Value	450
Checking Consumables	453
Initializing Settings	455
Initializing Menu	456
Initializing the Network Settings	457

Maintenance

This chapter describes upkeep of the machine, including how to clean the machine and initialize settings.

■ Basic Cleaning ▶ **Cleaning the Machine(P. 422)**



- The machine becomes dirty, see ▶ **Exterior(P. 423)** .
- Black spots appear on printouts, see ▶ **Fixing Unit(P. 424)** .

■ Replacing the Toner Cartridges



- To check the toner cartridge status, or how to replace the toner cartridge, see ▶ **Replacing the Toner Cartridges(P. 425)** .

■ Relocating the Machine

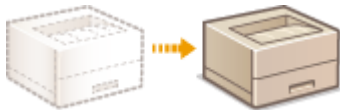

- Relocating the machine for maintenance or an office move, see ▶ **Relocating the Machine(P. 431)** .

■ Managing Print Quality ▶ **Maintaining and Improving Print Quality(P. 433)**

- If you want to adjust the toner density to be used for printing, see ▶ **Adjusting Print Density(P. 434)** .
- If you want to adjust the print position, see ▶ **Adjusting Print Position(P. 436)** .

■ Printing Reports and Lists



- Printing out lists of settings or the like , see ▶ **Printing Reports and Lists(P. 441)** .

■ Checking the Total Pages Printed by the Machine

If you want to check the total page number of printouts , see ▶ **Viewing the Counter Value(P. 450)** .

■ Initializing Settings

If you want to restore the settings, see [▶ Initializing Settings\(P. 455\)](#) .

Cleaning the Machine

51W4-06R

Regularly clean the machine to prevent deterioration in printing quality and to ensure that you use it safely and easily.

Where to Clean

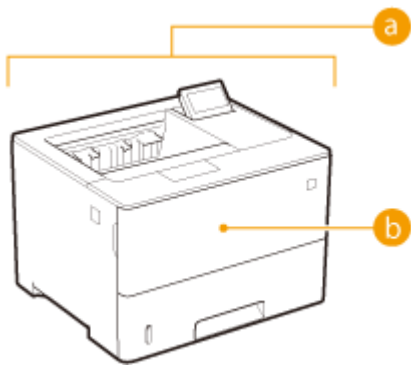

- a** Exterior of the machine and ventilation slots
▶ **Exterior(P. 423)**
- b** Internal fixing unit
▶ **Fixing Unit(P. 424)**

Exterior

51W4-06S

Regularly wipe the exterior of the machine, especially around the ventilation slots, to keep the machine in good condition.

1 Turn OFF the machine, and unplug the power cord from the AC power outlet.

- When you turn OFF the power, shut down the machine from the operation panel without using the power switch. [▶Turning OFF the Power \(Performing a Shutdown\)\(P. 35\)](#)

2 Clean the exterior of the machine and the ventilation slots.

- Use a soft, well-wrung-out cloth dampened with water or a mild detergent diluted with water.
- To locate the ventilation slots, see [▶Front Side\(P. 18\)](#) and [▶Back Side\(P. 20\)](#) .



3 Wait for the exterior of machine to dry completely.

4 Reconnect the power cord and turn ON the machine.









Fixing Unit

51W4-06U

Dirt may adhere to the fixing unit inside the machine and cause black spots to appear on printouts. To clean the fixing unit, perform the following procedure. Note that you cannot clean the fixing unit when the machine has documents waiting to be printed. Note that cleaning the fixing unit requires A4 or Letter size paper. Set the paper in the multi-purpose tray before performing the following procedure.

NOTE

- Cleaning consumes the toner cartridge. Make sure that there is sufficient toner cartridge remaining beforehand. [▶Checking the Toner Cartridge Status\(P. 427\)](#)

- 1 Press  (/ ).
- 2 Use  /  to select <Cleaning>, and press .
- 3 Select the size of the loaded paper, and press .
- 4 Select <Yes>, and press .

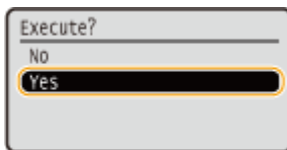

⇒ The <Set cleaning paper and press the Online key.> message appears on the display.

- 5 Press  (—).

⇒ The cleaning paper is slowly fed into the machine and the cleaning of the fixing unit starts.

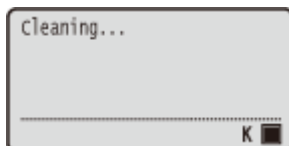

- You cannot stop the cleaning halfway. Wait until the cleaning is completed.

Replacing the Toner Cartridges

51W4-06W

When the replacement time for a toner cartridge is near, a message appears on the display. Note that the print quality becomes poor if you continue printing without taking any action. You can also check the toner cartridge status on the display.

- ▶ **When a Message Appear(P. 425)**
- ▶ **If Printouts are Poor in Quality(P. 426)**
- ▶ **Checking the Toner Cartridge Status(P. 427)**
- ▶ **Before Replacing the Toner Cartridge(P. 427)**
- ▶ **How to Replace Toner Cartridges(P. 428)**

■ When a Message Appear

Depending on which message is displayed, you will need to make sure that you have a replacement toner cartridge ready or replace the toner cartridge. ▶ **Before Replacing the Toner Cartridge(P. 427)** ▶ **How to Replace Toner Cartridges(P. 428)** ▶ **Consumables(P. 485)**

<16 Tnr cart. will soon reach end of lifetime.>

<Toner cartridge will soon reach end of lifetime.>

This message notifies you that a toner cartridge needs to be replaced soon. Make sure that you have a replacement toner cartridge ready. Replace the toner cartridge if you see this message before you start to print a large job.

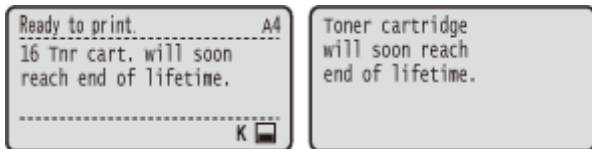

NOTE

- When the <Toner cartridge will soon reach end of lifetime.> message is displayed, the printing is temporarily stopped. To resume the printing, press  (●—●).
- Which message is to be displayed depends on the <Action When Warning> setting in the setting menu of the operation panel. ▶ **Action When Warning(P. 316)**
- You can set any value as the percentage of the amount remaining in the toner cartridge that triggers this message. ▶ **Spec Tnr Chk Timing(P. 369)**

<1G Change toner cartridge recommended.>

The toner cartridge has reached the end of its lifetime. It is recommended that you replace this cartridge with a new one.

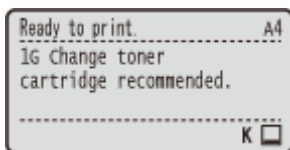

IMPORTANT

- You can continue printing when this message is displayed, but the print quality may deteriorate.

- Receiving e-mail and fax documents will be disabled. ▶ **Printing Received E-mail (E-Mail Print) (P. 111)**

<Non-Canon cart. not covered by warranty.>

This message notifies you that the machine may not print in optimum quality. It is recommended that you replace this cartridge with a new one.

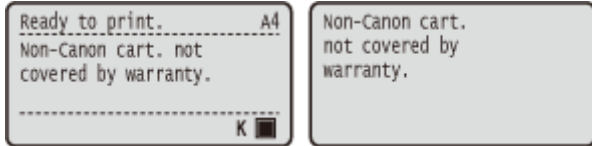

IMPORTANT

- You can continue printing when this message is displayed, but the print quality may deteriorate. Doing so may result in damage to the machine.

<Cannot print. Cart. may be non-Canon/counterfeit.>

This message notifies you that the machine may not print in optimum quality. It is recommended that you replace the toner cartridge with a new one.



IMPORTANT

- When this message is displayed, you cannot continue printing. ▶ **Canon Genuine Mode(P. 324)**

■ If Printouts are Poor in Quality

If your printouts begin to show any of the following features, one of your toner cartridges is consumed. Replace the nearly empty toner cartridge even if no message is displayed. ▶ **Before Replacing the Toner Cartridge(P. 427)** ▶ **How to Replace Toner Cartridges(P. 428)**

Streaks Appear/Printing is Uneven



Toner smudges and splatters appear

Partially faded



Blank space of originals becomes grayish in printouts

Uneven density



White Spots Appear





■ Checking the Toner Cartridge Status

You can check the toner cartridge status on the main screen. It is recommended that you check the amount before you start to print a large job.

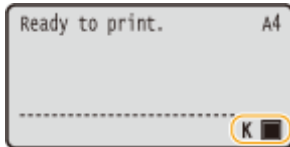

NOTE

- The displayed toner cartridge status can be used only as a guide and may differ from the actual status.
- You can also check the toner cartridge status with <Remaining Toner> under <Consumables Info.>. [▶](#)
Consumables Info.(P. 404)

Before Replacing the Toner Cartridge

Perform the following before replacing the toner cartridge. The message may no longer appear, or print quality may be improved.

1 Press the button to open the Front cover.

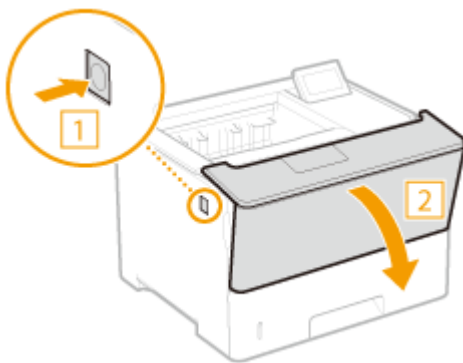

2 Remove the toner cartridge.

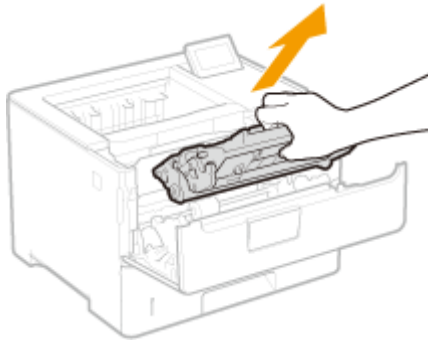

- 3 Shake the toner cartridge five or six times as shown below to evenly distribute the toner inside the cartridge.**



- 4 Install the toner cartridge.**

- Fully push it in until it cannot go any further.

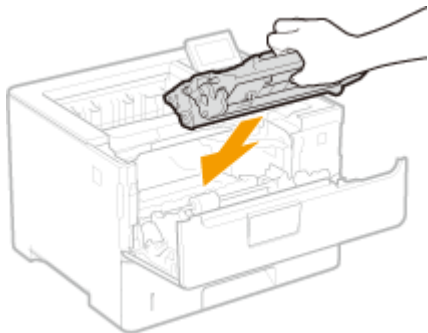

- 5 Close the Front cover.**

How to Replace Toner Cartridges

Read the precautions in **Maintenance and Inspections(P. 9)** and **Consumables(P. 10)** before replacing the toner cartridges.

- 1 Press the button to open the Front cover.**

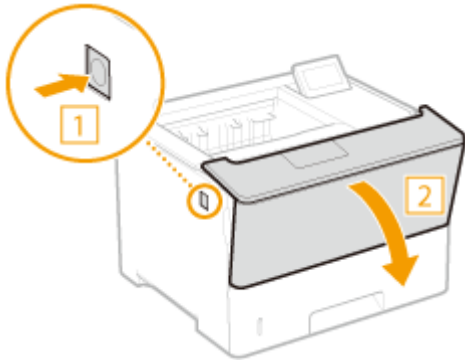

2 Remove the toner cartridge.

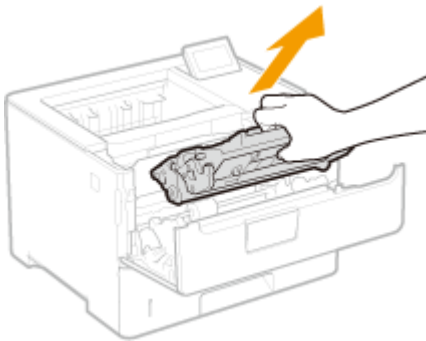

3 Remove the replacement toner cartridge from the protective case.

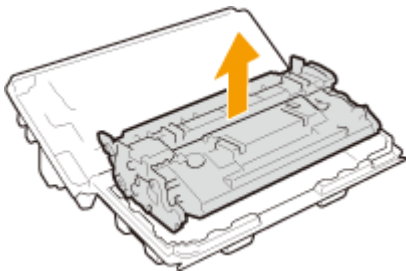

4 Shake the toner cartridge five or six times as shown below to evenly distribute the toner inside the cartridge.

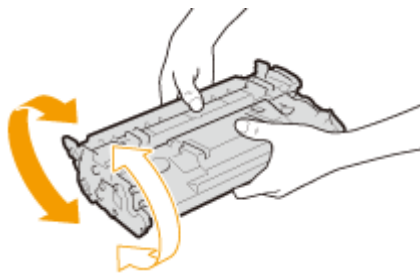

5 Install the toner cartridge.

- Fully push it in until it cannot go any further.

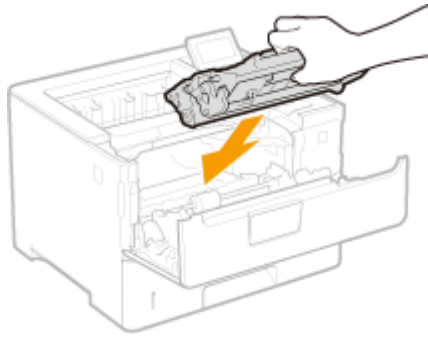

6 Close the Front cover.

LINKS

◉ [Consumables\(P. 485\)](#)

Relocating the Machine

51W4-06Y

The machine is heavy. Make sure to follow the procedures below when moving the machine to avoid injury, and also make sure to read the safety precautions before you begin. **▶Important Safety Instructions(P. 2)**

1 Turn OFF the machine and computer.

- When you turn OFF the power, be sure to shut down the machine from the operation panel without using the power switch. **▶Turning OFF the Power (Performing a Shutdown)(P. 35)**

2 Disconnect the cables and cord from the machine in numerical order as in the illustration below.

- Whether the cables with "*" are connected depends on your environment.

- 1 Power plug
- 2 Power cord
- 3 USB device*
- 4 USB cable*
- 5 LAN cable*

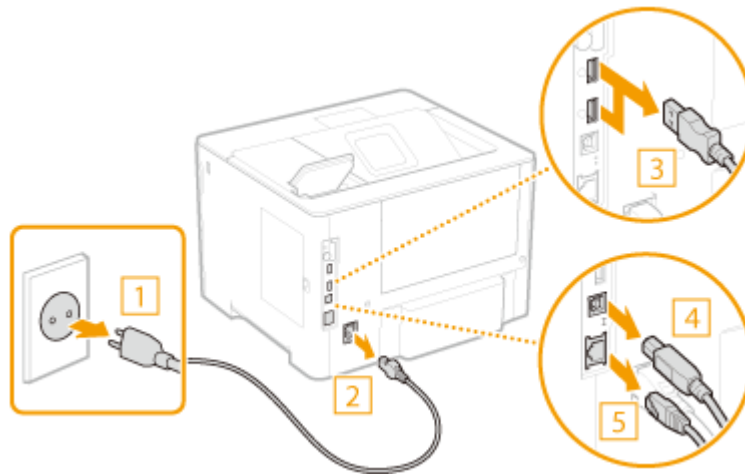

3 When transporting the machine across a long distance, remove the toner cartridge. **▶Replacing the Toner Cartridges(P. 425)**

4 Pull out the paper drawer until it stops, and remove it while lifting the front side.

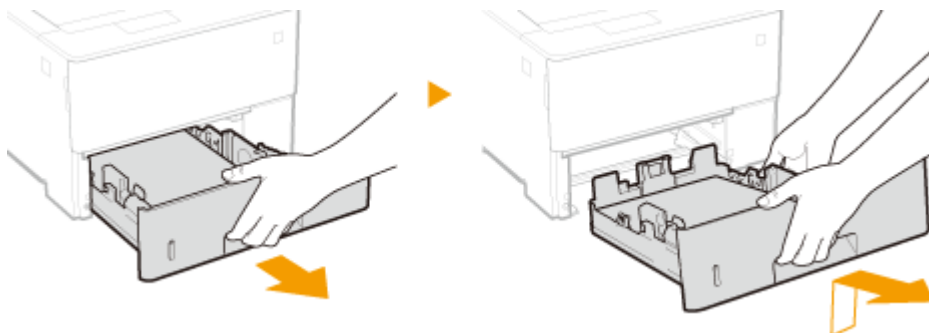

5 Close all the open covers, and move the machine to a new location.

- The machine is heavy (**▶Main Unit(P. 468)**). Do not try hard to carry the machine.
- Position yourself toward the front side of the machine and hold the lift handles, then lift up the machine.

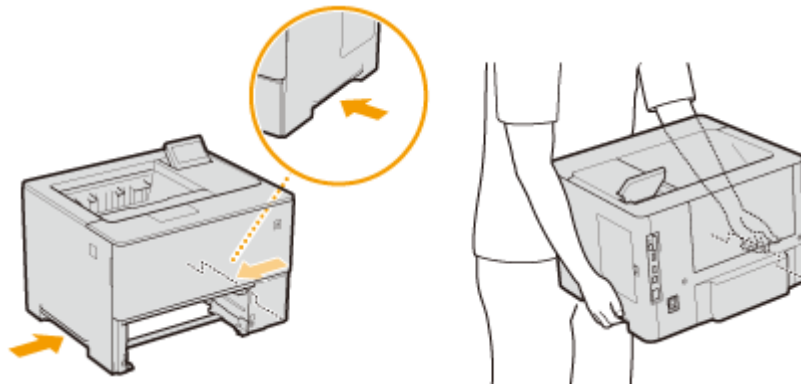

IMPORTANT:

If the optional paper feeder is attached to the machine

- Unlock the paper feeder before lifting the machine, and transport the paper feeder separately.

Front Side

Back Side

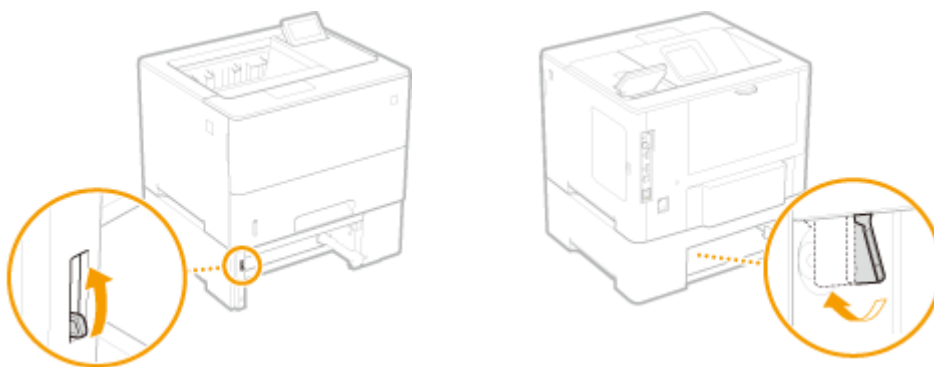

6 Carefully place the machine at the new installation site.

- For information about how to install the machine after relocating it, see Getting Started. ▶ **Manuals and Their Contents(P. 500)**

Maintaining and Improving Print Quality

51W4-070

When you cannot obtain a satisfactory print result, such as when the resulting print density or print position is different than expected, try the following adjustments.

■ Density Adjustment

Adjust the toner density. You can make fine adjustment of toner density by density level. [▶ Adjusting Print Density\(P. 434\)](#)

■ Print Position Adjustment

For each paper source, you can adjust the print position. [▶ Adjusting Print Position\(P. 436\)](#)

Adjusting Print Density

51W4-071

If the resulting print is darker or lighter than expected, you can adjust the toner density. You can make fine adjustment of the toner density by dividing the whole density range into three areas.

IMPORTANT

- If <Toner Save> is set to <On>, you cannot use this adjustment function. **Toner Save(P. 352)**

1 Press **▶** (□).

2 Use **▲ / ▼** to select <Print Quality>, and press **OK**.

3 Adjust the density.

1 Select <Density>, and press **OK**.

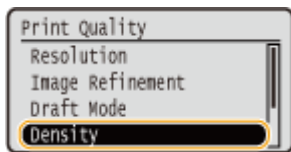

2 Use **▲ / ▼** to adjust the density.



a Density adjustment

Set a "+" value to increase the density. Set a "-" value to decrease the density.

3 Press **OK**.

■ Making fine adjustment of toner density by density level

You can make fine adjustment of toner density on three density levels - high, medium, and low.

1 Select <Density (Fine Adj)>, and press **OK**.

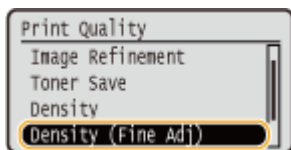

2 Select the desired density level, and press **OK**.

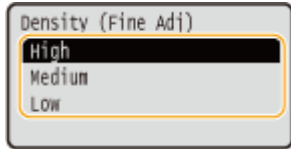

3 Use ▲ / ▼ to adjust the density.



a Density adjustment

Set a "+" value to increase the density. Set a "-" value to decrease the density.

■ Example adjustment of each density area

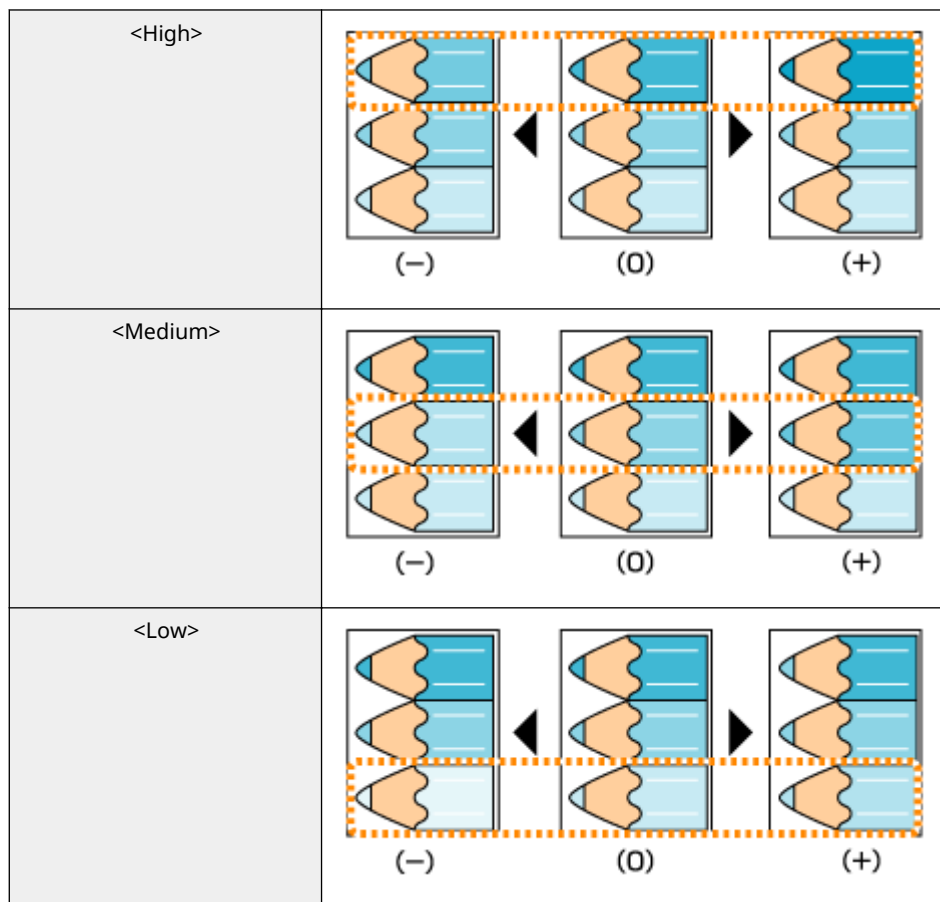

4 Press .

- If you want to also make adjustments on other density levels, repeat the operations in steps 2 to 4.

Adjusting Print Position

51W4-072

If a document is printed off-center or out of the printable range, adjust the print position. You can adjust the print position for each paper source.

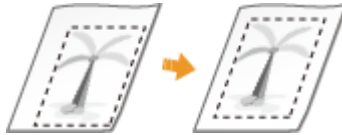

- ▶ **Step 1: Printing the Current Print Position(P. 436)**
- ▶ **Step 2: Checking the Direction and Distance to Adjust(P. 437)**
- ▶ **Step 3: Adjusting the Print Position for Each Paper Source(P. 438)**

Step 1: Printing the Current Print Position

You can perform "Printing Position Adjustment Print" to check the direction and distance to adjust.

NOTE

- When you want to check the print position for 2-sided printing, set <2-Sided Printing> to <On> in the setting menu of the operation panel in advance. ▶ **2-Sided Printing(P. 416)**

1 Press  ().

2 Use  /  to select <Paper Source>, and press .

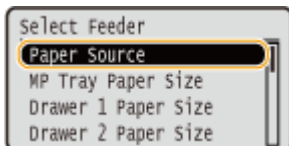

3 Select the paper source for which you want to check the print position, and press .

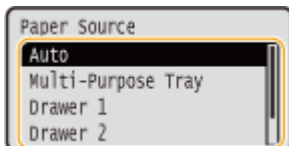

4 Press  ().

⇒ The screen returns to the main screen.

5 Press  ().

6 Select <Printing Pos. Print>, and press **OK**.

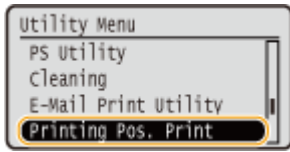

7 Select <Yes>, and press **OK**.

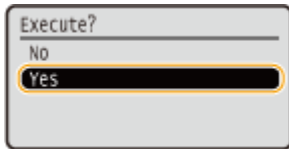

⇒ A printing position adjustment printout is output.

Step 2: Checking the Direction and Distance to Adjust

When Printing Position Adjustment Print is performed, the print position check marks "田" are printed. Determine the direction and distance to adjust based on those marks. When the print position is normal, all the marks are printed at a position 5 mm from the nearest edge of the paper.

How to Check Printing Position Adjustment Printouts

The edge of paper that comes out first when the paper is output is the top of a Printing Position Adjustment Print. When you check the print position, make sure which edge of the paper is the top.

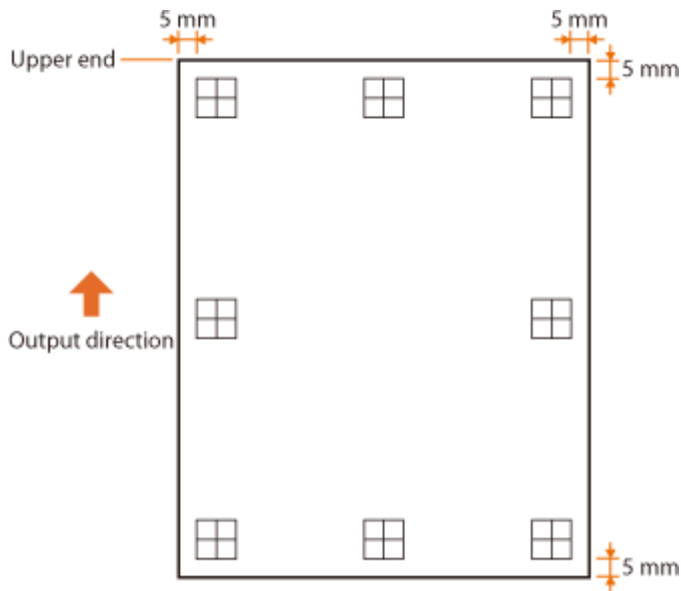

- The size of the mark "田" for checking the print position is as shown in the illustration below.

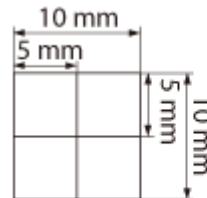

When the Print Position Is Off-Center

When the print position check marks are printed off the correct position, you need to adjust the print position. When you adjust the print position, specify the direction using "+" and "-" and the distance using "mm". Use "-" to shift the print position upward and "+" to shift it downward (vertical position correction). Use "-" to shift the print position leftward and "+" to shift it rightward (horizontal position correction).

Vertical direction (<Offset Y>)

Horizontal direction (<Offset X>)



In the example shown below, to shift the print position 5 mm upward and 1.7 mm rightward, "-5.0 mm" is set in <Offset Y> and "+1.70 mm" is set in <Offset X>.

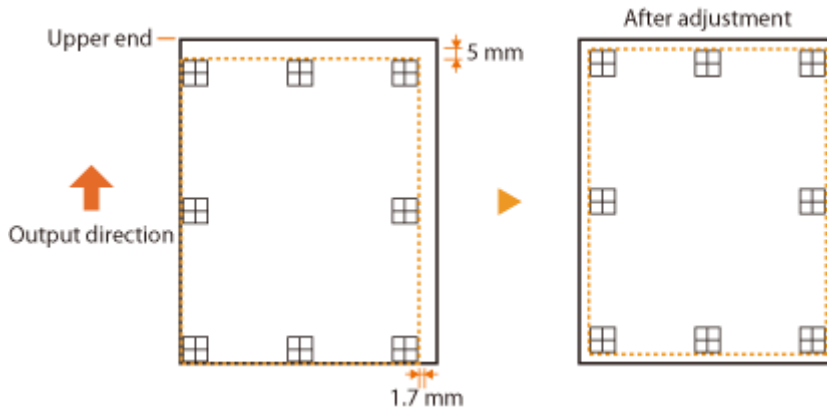

Step 3: Adjusting the Print Position for Each Paper Source

After you confirm the direction and distance to adjust, specify an adjusted print position. You can adjust the print position in the range of -5.0 mm to +5.0 mm in 0.1 mm increments in either direction: vertical and horizontal.

1 Set the machine to offline.

- When (●—●) is lit, press (●—●).

2 Press ▶ (□✓).

3 Use ▲ / ▼ to select <User Maintenance>, and press .

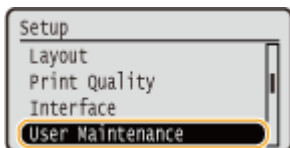

4 Select <Adj. Print Position>, and press .

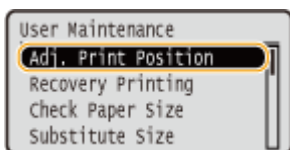

5 Select the paper source, and press .

- Use <Common> to adjust the print position on the first page (front side) in 2-sided printing mode regardless of the paper source.

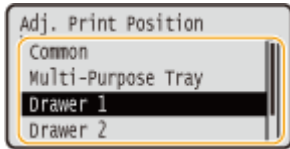

6 Select the direction to adjust, and press .

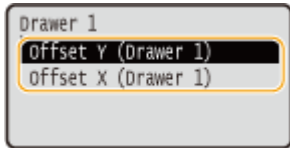

NOTE:

Print position adjustment for 2-sided printing

- <Offset Y (2-Sided)> and <Offset X (2-Sided)> allow you to adjust the print position on the first page (front side). The print position on the second page (back side) will be adjusted based on the values set for each paper source.

■ An example of print position adjustment

First page (front side)	<Offset Y (2-Sided)> setting value
Second page (back side)	<Offset Y (MP Tray)> setting value

7 Set a value, and press .

- Based on the printout made by Printing Position Adjustment Print, use ▲ / ▼ to enter a value.

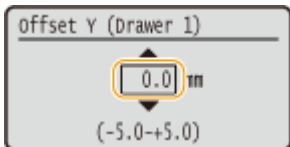

- To adjust another position or paper source, repeat steps 5 and 7.

8 Press  (●—●).

⇒ The screen returns to the main screen.

9 Press  (●—●) again.

⇒ The machine becomes online.

10 Perform the Printing Position Adjustment Print, and check the adjusted print position on the printout. ▶ Step 1: Printing the Current Print Position(P. 436)

Adjusting all print positions

You can use <Offset Y> and <Offset X> in the setting menu of the operation panel to adjust the print positions for all types of printing regardless of the paper source. You can adjust the print position in the range of -50.0 mm to +50.0 mm in 0.5 mm increments in either direction: vertical and horizontal.  **Offset Y/Offset X(P. 347)**

Printing Reports and Lists

51W4-073

You can check the condition of consumables and the machine settings by printing reports and lists.

NOTE

Asterisks (*)

- Settings marked with "*"1" may not be displayed depending on the model you are using, options, or other setting items.
- Settings marked with "*"2" may not be displayed when [Display Job Log] check box of the Remote UI is not selected. **▶Hiding the Print Job History(P. 243)**

Configuration Page

You can check the machine settings (**▶Setup Menu(P. 310)**), the contents registered in the machine, and other information in list form. The other information includes the amount of remaining toner, the number of printed pages, and the capacity of the memory (RAM) mounted on the machine. Setting items whose name is preceded by an asterisk (*) are the items whose setting was changed from the factory default.

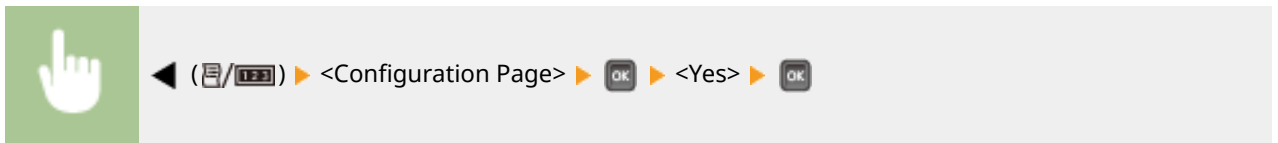

Example:

Canon		Configuration Page	
Main Controller Version	: R1.36/96 R34.53	Activated Instruction	: On
DCDN Version	: 1.01.00	Show Toner Gauge	: On
FWC Version	: 20080612	Set. Comp. Notify	: 2 sec.
RAM Size	: 1024 MB	Scrolling Speed	: Normal
Model	: [REDACTED]		
Device		Paper Source	: Auto
Manufacturer	: Canon	MF Tray Paper Size	: A4
Product Name	: [REDACTED]	MF Tray Priority	: Off
Display Name	: [REDACTED]	Drawer 1 Paper Size	: A4
Serial Number	: RYVA500014	Standard Paper Size	: A4
Controller		MF Tray for Mix. Trp.	: Off
SWH II	: Ver.02.030/01.032	Auto Select Drawer	: Off
PCU	: Ver.60.009.009	Multi-Purpose Tray	: Use
PS	: Ver.3018.102	Drawer 1	: Use
Network		Default Paper type	: Plain
Version	: 1.00	MF Tray Paper Type	: Plain
MAC Address	: d8:49:2f:c9:3d:6e	Drawer 1 Paper Type	: Plain
USB		Manual 2-Sided (MP)	: 1st Side
Vendor ID	: 040a49	2-Sided Printing	: Off
Product ID	: 040a49	Select Drawer1 Model	: Standard Drawer
Serial Number	: d8492f193d6e		
Mode	: USB	Layout	
		Number of Copies	: 1
		Size	: A4

Network Status Print

You can check the settings about the network configured in the machine (**▶Network(P. 326)**) in list form. The information about the security including the address filter settings and IPSec settings is also printed.



Example:

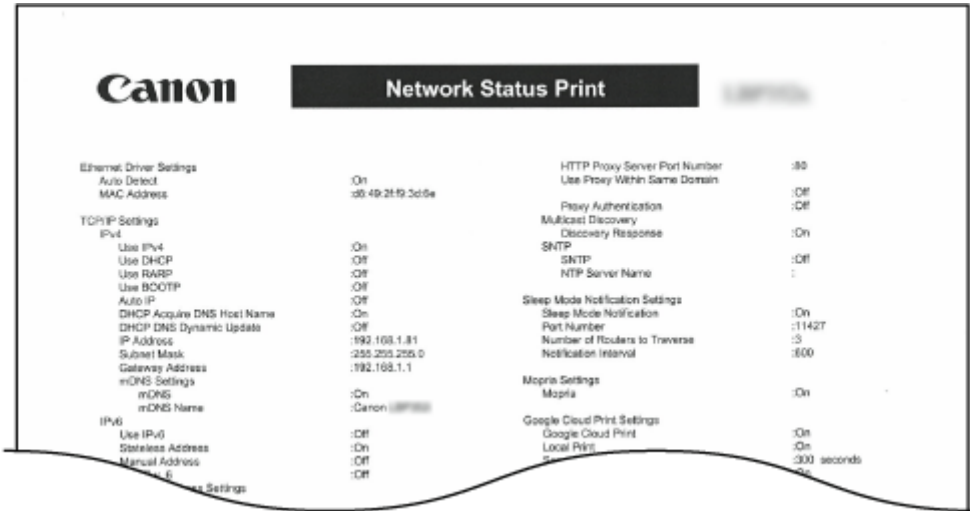

Consmbl. Status Prt.

The information such as toner remaining amount, warning messages, and information on where you can purchase new toner cartridges can be viewed in list form.



Example:

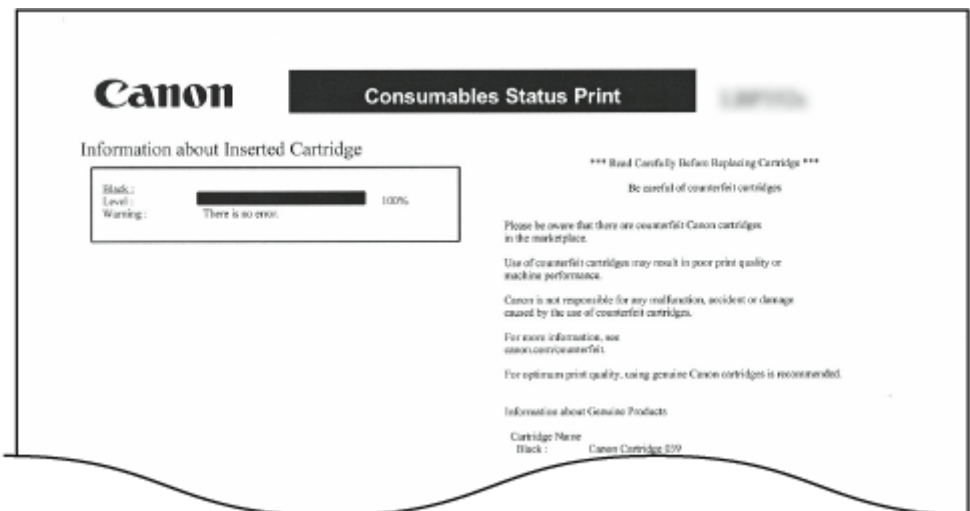

IPSec Policy List

You can check the list of policy names and the IPSec settings registered in the machine by printing an IPSec Policy List.

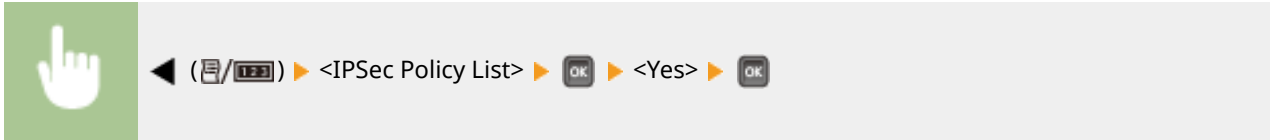

Example:

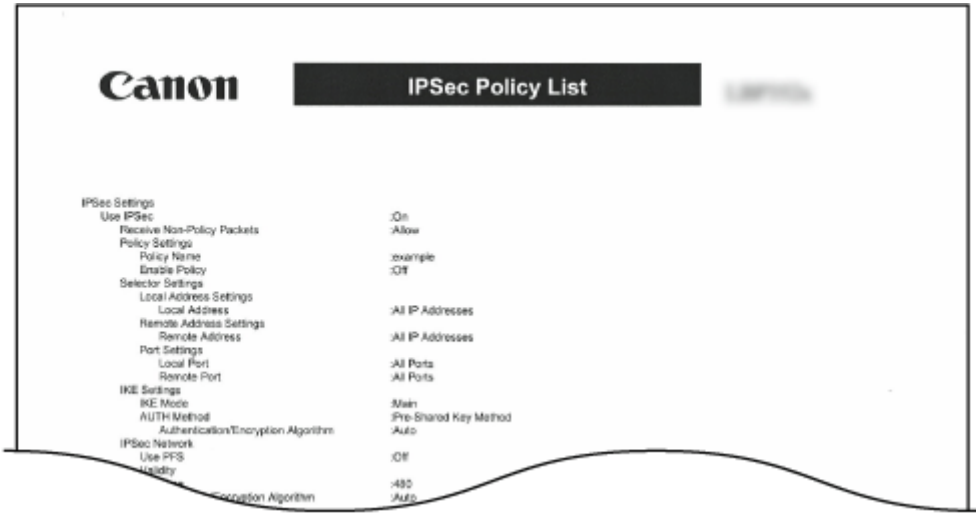

E-Mail RX Log List

You can check a log consisting of subjects and received date/time of e-mails received in the machine in list form.



Example:

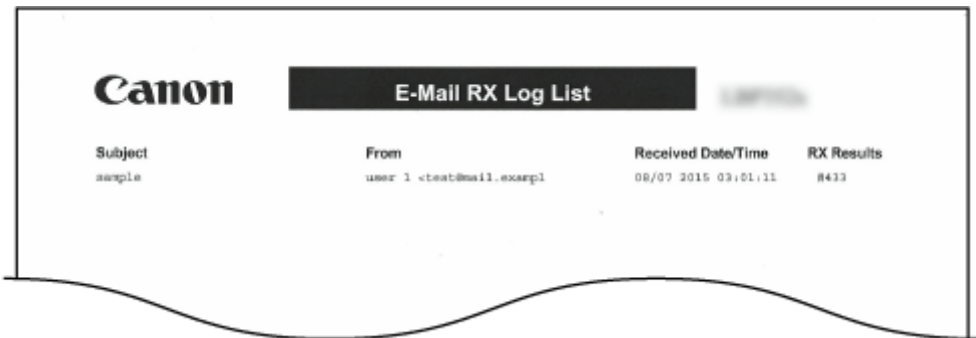

Page Count List

You can check the number of pages printed for each department by printing a report when [Department ID Management] is enabled.



Example:

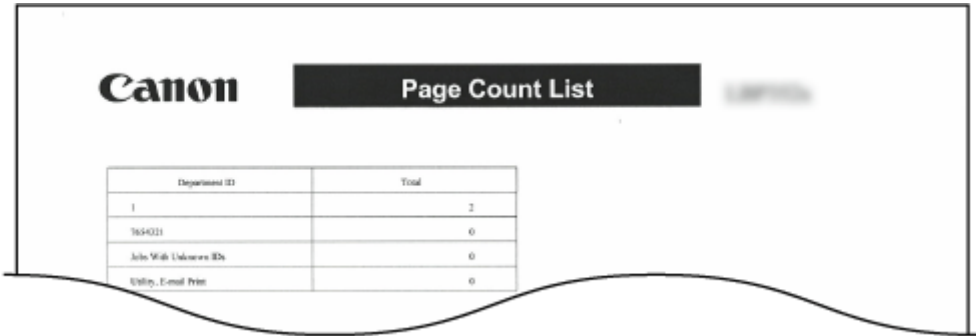

Counter Report

You can print an aggregate report of the number of pages printed for each counter.

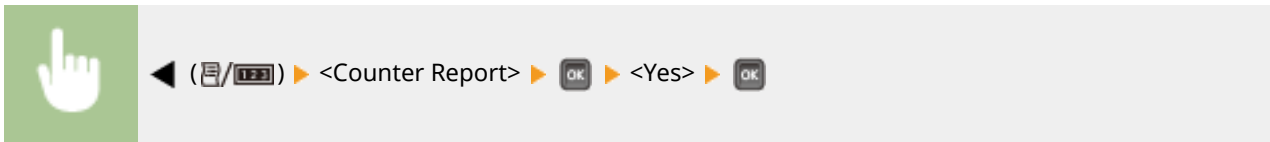

Example:

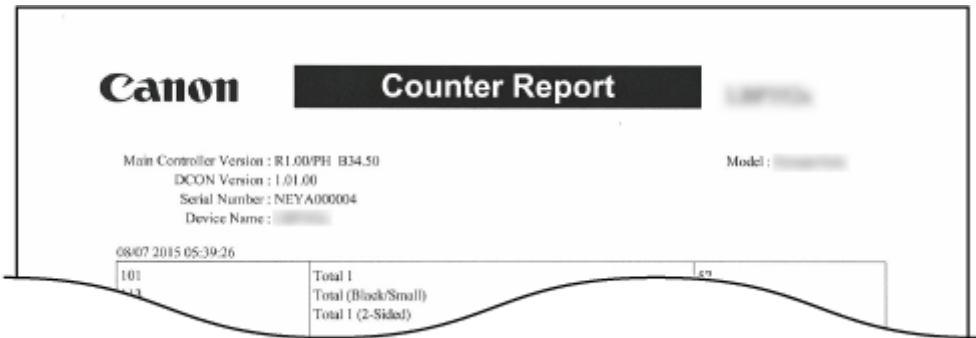

Print MEAP Sys. Info

You can check the information about MEAP applications installed in the machine and the MEAP system applications in list form if the MEAP function is enabled.



Example:

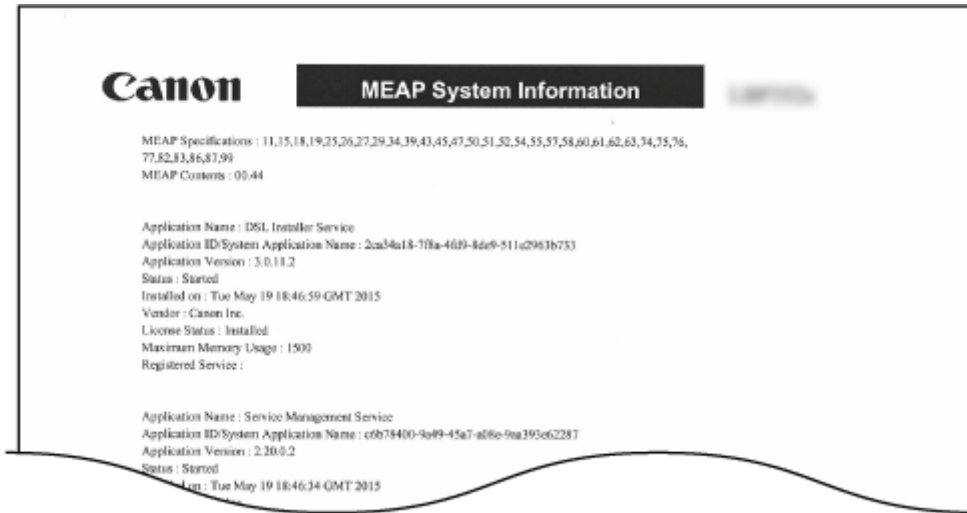

Cartridge Log Print

You can check logs of usage of toner cartridge in the form of a list.

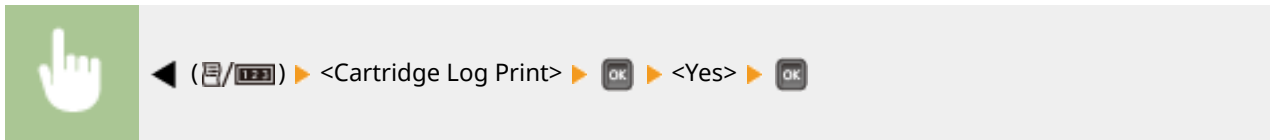

Example:

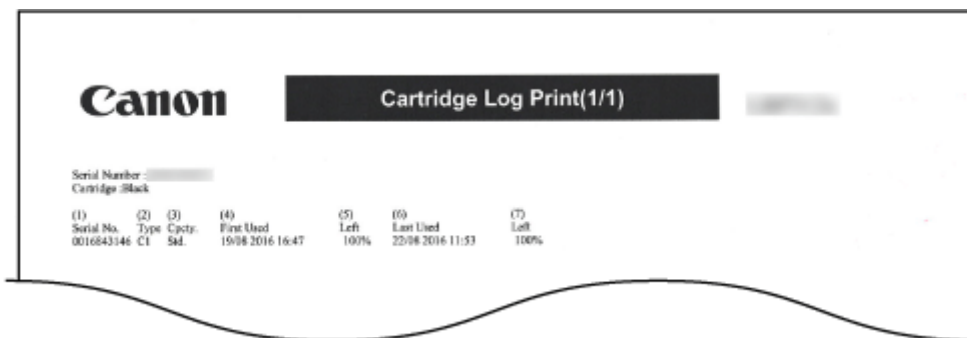

PCL Font List

You can check the fonts available in PCL mode in list form. ▶ **Font Samples(P. 530)**

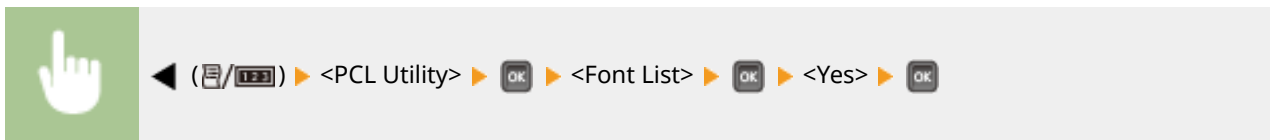

Example:

Font List							PAGE 001
PCL Internal Fonts							
Font Name	Symbol	Spacing	Style	StrokeW	Pitch/Point Typeface	Sample	
[000] Courier		0	0	0	scalable 4099	ABCDEFGHIJKLMNOPQRSTUVWXYZ	
[001] CG Times		1	0	0	scalable 4101	ABCDEFGHIJKLMNOPQRSTUVWXYZ	
[002] CG Times Bold		1	0	3	scalable 4101	ABCDEFGHIJKLMNOPQRSTUVWXYZ	
[003] CG Times Italic		1	1	0	scalable 4101	ABCDEFGHIJKLMNOPQRSTUVWXYZ	
[004] CG Times Bold Italic		1	1	3	scalable 4101	ABCDEFGHIJKLMNOPQRSTUVWXYZ	
[005] CG Dsega		1	0	0	scalable 4113	ABCDEFGHIJKLMNOPQRSTUVWXYZ	
[006] CG Dsega Bold		1	0	3	scalable 4113	ABCDEFGHIJKLMNOPQRSTUVWXYZ	

PS Mode List

The settings for use of the PS mode and the internal information items registered in the machine are printed in list form.

- ▶ Configuration Page(P. 446)
- ▶ Font List(P. 446)

■ Configuration Page

You can check the machine settings (▶PS(P. 395)) and the contents registered in the machine in list form.

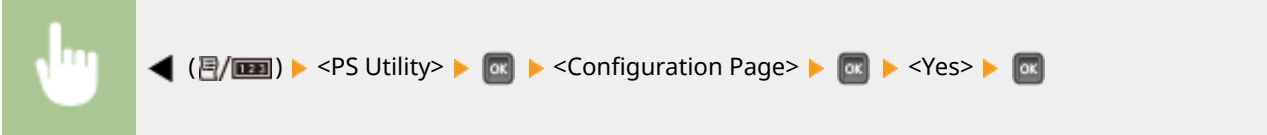

Example:

Canon		PS Configuration Page	
PS Settings		Halftones	
Printer Name	: [REDACTED]	Text	: Resolution
PS Version	: 3018.102	Graphics	: Resolution
PS Disk Space	: 3156.15 MB (3145.14 MB Available)	Image	: Resolution
Job Timeout	: 0 s		
Data Protocol	: Auto		
Print PS Errors	: Off		
Grayscale Conversion	: NTSC		

■ Font List

You can check the fonts available in PS mode in list form.

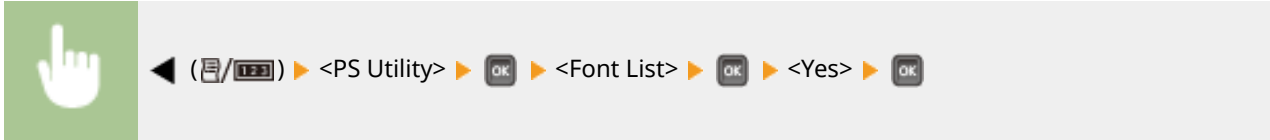

Example:



Stored Job List *1

You can print a list of documents stored in the SD card installed on the machine.



Example:

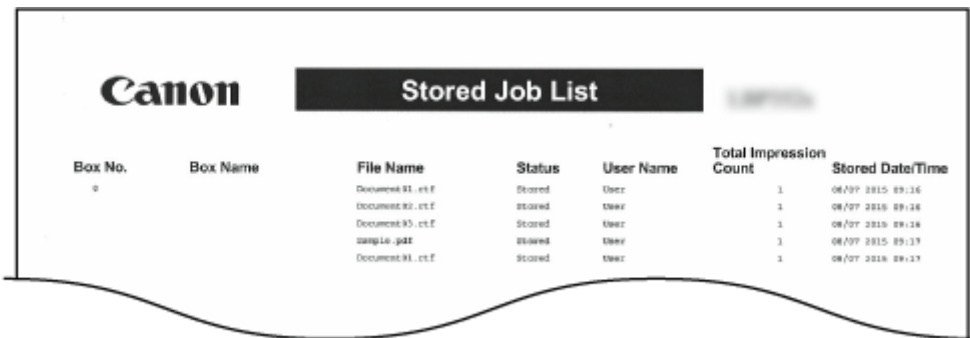

Job Print Log *2

You can print a log of documents printed from the computer in list from.

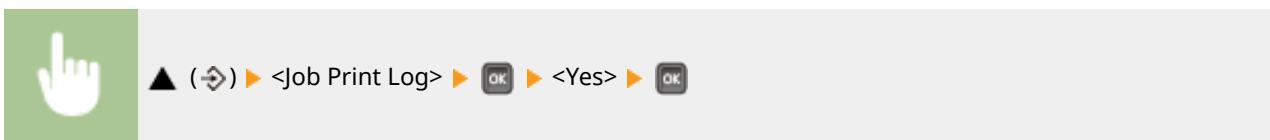

Example:

File Name	User Name	Total Impression Count	Start Time	End Time	Print Results
Sample.pdf	User	1	08/07 2015 09:19	08/07 2015 09:19	OK
Document02.rtf	User	1	08/07 2015 09:19	08/07 2015 09:19	OK
Document02.rtf	User	1	08/07 2015 09:19	08/07 2015 09:19	OK
Document03.rtf	User	1	08/07 2015 09:19	08/07 2015 09:19	OK
Sample.pdf	User	1	08/07 2015 09:19	08/07 2015 09:19	OK

Stored Job Print Log *1*2

You can print a print log of documents stored in the SD card installed on the machine in list form.

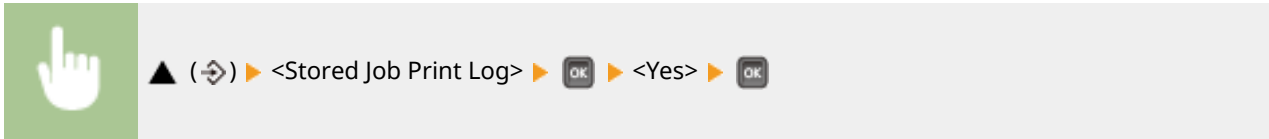

Example:

File Name	User Name	Total Impression Count	Start Time	End Time	Print Results
Document02.rtf	No Name	1	08/07 2015 09:18	08/07 2015 09:18	OK
Sample.pdf	No Name	1	08/07 2015 09:18	08/07 2015 09:18	OK
Document02.rtf	No Name	1	08/07 2015 09:18	08/07 2015 09:18	OK
Document03.rtf	No Name	1	08/07 2015 09:18	08/07 2015 09:18	OK
Document02.rtf	No Name	1	08/07 2015 09:18	08/07 2015 09:18	OK
Document02.rtf	No Name	1	08/07 2015 09:18	08/07 2015 09:18	OK
Document02.rtf	No Name	1	08/07 2015 09:18	08/07 2015 09:18	OK

Report Print Log *2

You can print the settings and a print log of reports in list form.



Example:

File Name	User Name	Total Impression Count	Start Time	End Time	Print Results
ReportPrint	No Name	1	08/07 2015 05:59	08/07 2015 05:59	OK
ReportPrint	No Name	1	08/07 2015 05:43	08/07 2015 05:43	OK
ReportPrint	No Name	1	08/07 2015 05:43	08/07 2015 05:43	OK
ReportPrint	No Name	9	08/07 2015 05:42	08/07 2015 05:42	OK
ReportPrint	No Name	9			OK
ReportPrint	No Name	1			OK

E-Mail Print Log *2

You can print a print log of received e-mails in list form.



Example:

File Name	User Name	Total Impression Count	Start Time	End Time	Print Results
sample03	user 1 <test@mail.exempl>	1	08/07 2015 05:41	08/07 2015 05:41	OK
sample02	user 1 <test@mail.exempl>	1	08/07 2015 05:41	08/07 2015 05:41	OK
sample01	user 1 <test@mail.exempl>	1	08/07 2015 05:40	08/07 2015 05:40	OK
sample	user 1 <test@mail.exempl>	1	08/07 2015 03:01	08/07 2015 03:01	OK

LINKS

- ▶ Utility Menu(P. 402)
- ▶ Job Menu(P. 406)

Viewing the Counter Value

51W4-074

You can check the number of printed pages.

- ▶ **Checking Total Number of Printed Pages(P. 450)**
- ▶ **Checking the Number of Pages Printed for Each Department(P. 450)**

Checking Total Number of Printed Pages

You can check the total number of printed pages.

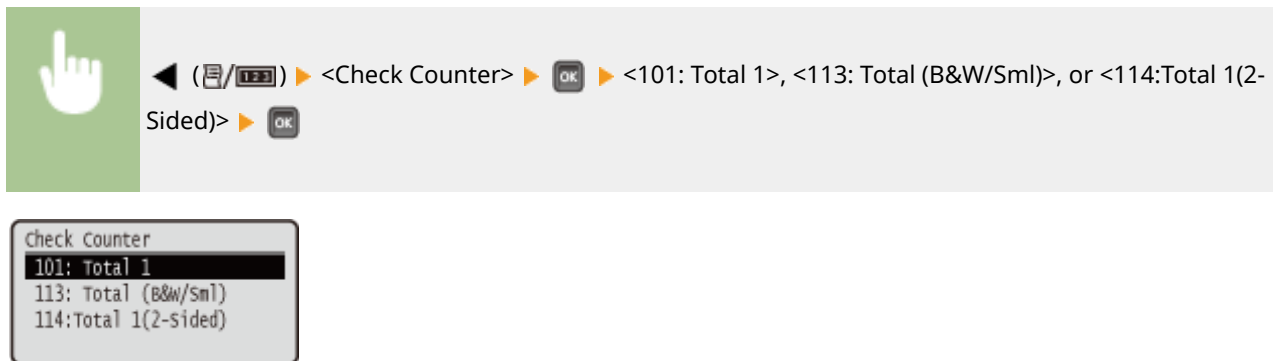

Checking the Number of Pages Printed for Each Department

You can check the number of pages printed for each department.

- 1 Start the Remote UI and log on in Management Mode. ▶ Starting Remote UI(P. 284)**
- 2 Click [Settings/Registration].**

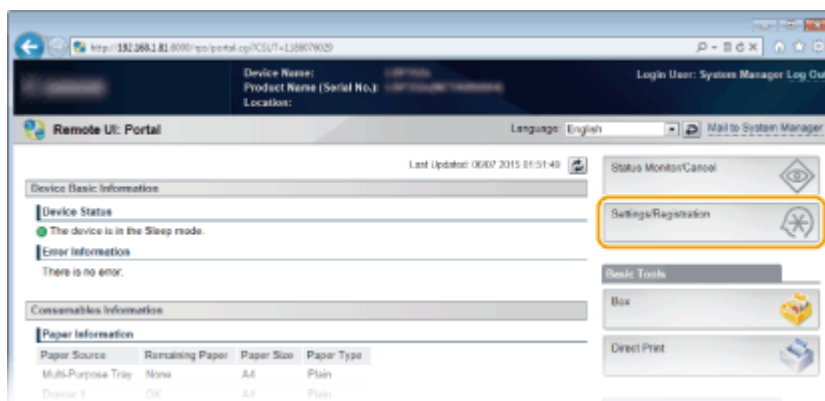

- 3 Click [Department ID Management].**

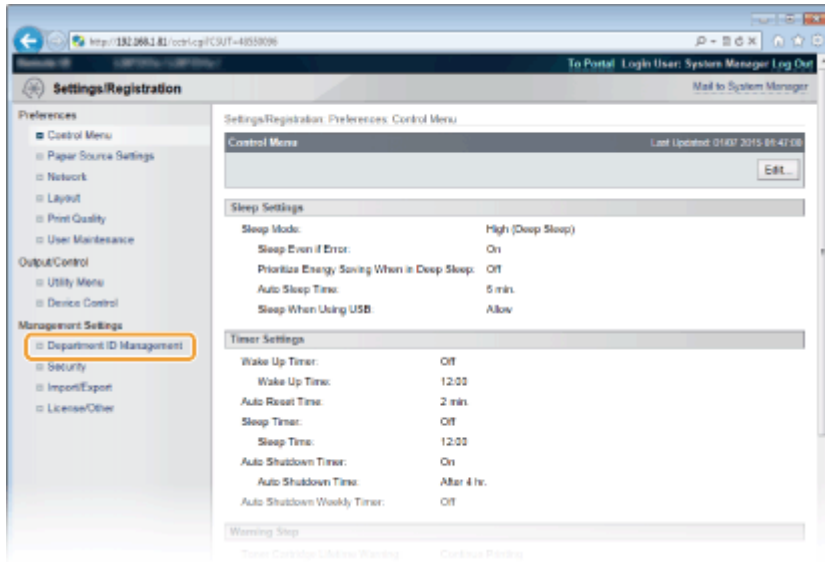

⇒ The number of printed pages is displayed for each Department ID under [Printed Pages].

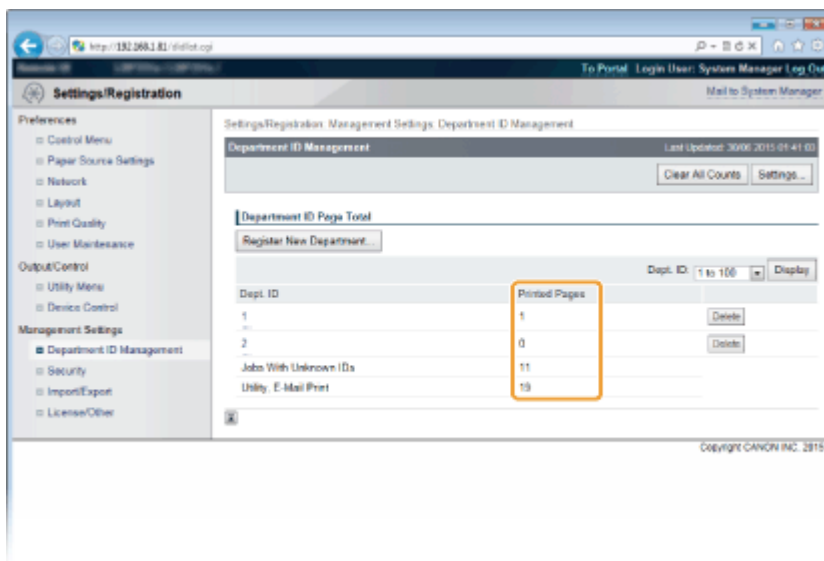

NOTE

To print the check result

▶ **Page Count List(P. 443)**

To clear the page count to zero

- When you want to clear the page count to zero for each department, click the text link under [Dept. ID], and click [Clear Count] ▶ [OK].

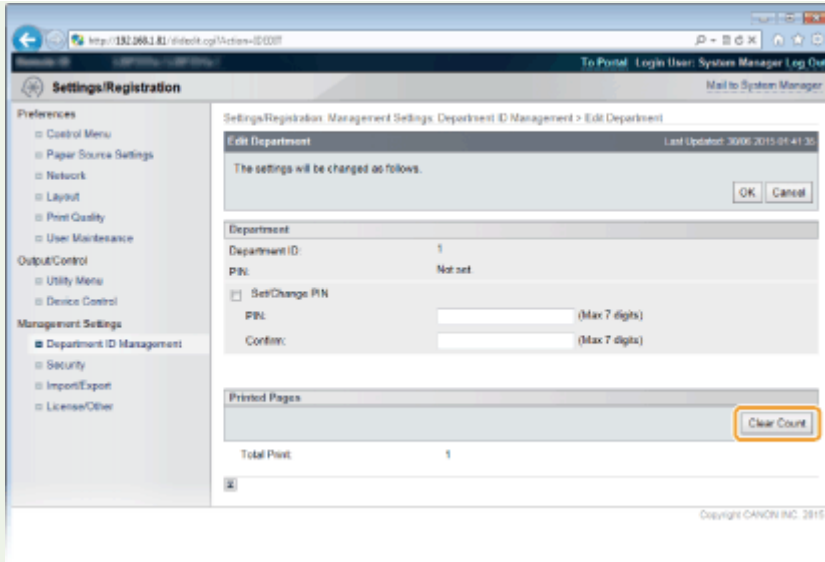

- If you want to return the counts of all departments to zero, click [Clear All Counts] ► [OK].

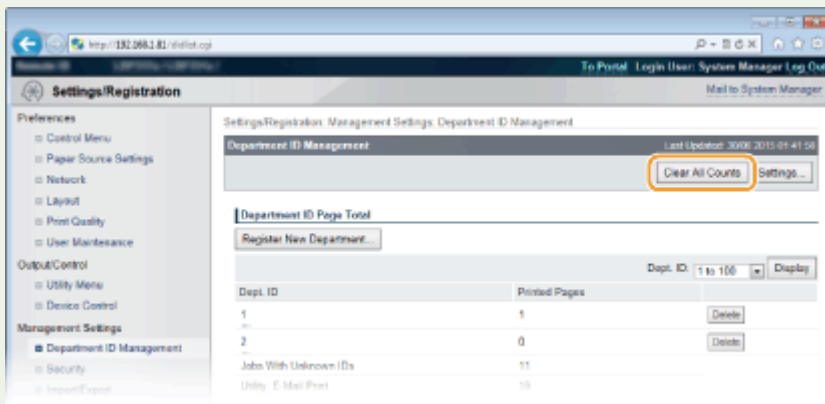

Checking Consumables

51W4-075

You can use the operation panel to check the information of the consumables.

- ▶ **Checking Paper(P. 453)**
- ▶ **Checking the Toner Cartridge Model(P. 453)**
- ▶ **Checking the Toner Cartridge Status(P. 453)**

Checking Paper

You can display the currently specified paper size and paper type, and the remaining paper level for each paper source.

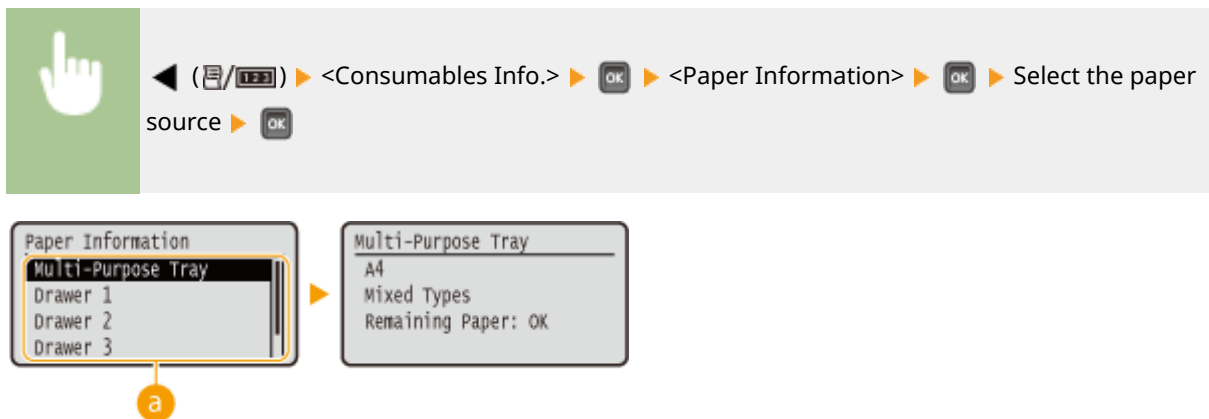

a Paper source selection

Select the paper source of which information is displayed.

Checking the Toner Cartridge Model

You can display the model number of the toner cartridge for the machine.

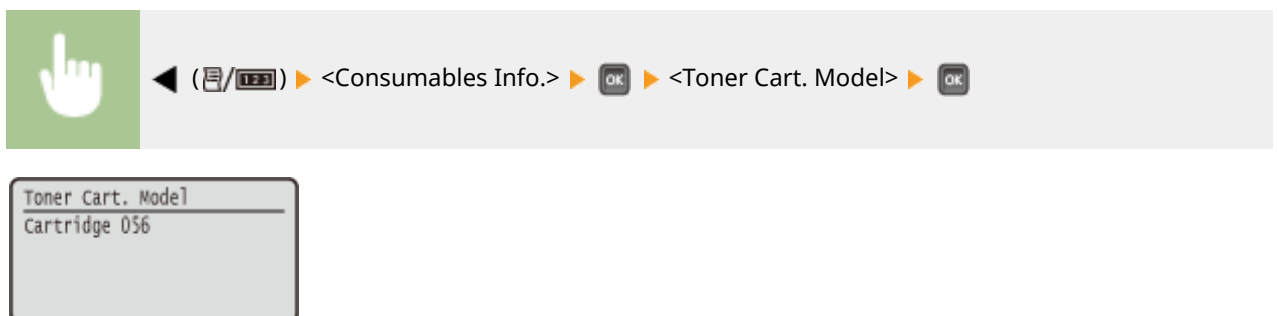

Checking the Toner Cartridge Status

Displays the toner cartridge status. Other internal parts may reach the end of their lifetime before the toner runs out.

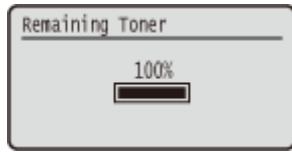
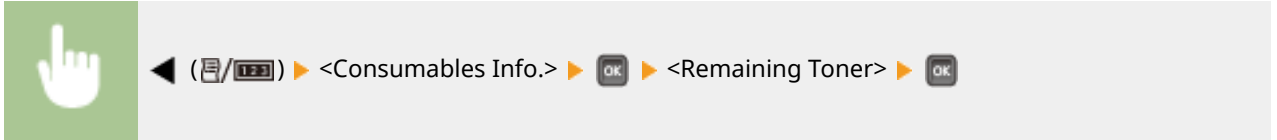

NOTE

- The displayed values can be used only as a guide and may differ from the actual status.

Initializing Settings

51W4-076

You can restore the following settings:

- ▶ **Initializing Menu(P. 456)**
- ▶ **Initializing the Network Settings(P. 457)**

Initializing Menu

51W4-077

You can restore the settings of the machine (▶ **Setup Menu(P. 310)**) to the factory default settings.

IMPORTANT

Do not press the power switch when the initialization is in progress

- If the machine is turned OFF during the initialization, it may be damaged.

If a Remote UI Access PIN has been specified

- The Remote UI Access PIN is also initialized. After performing initialization, respecify a Remote UI Access PIN. ▶ **Setting a Remote UI PIN(P. 215)**

NOTE

- When you want to initialize the network settings, follow the procedure in ▶ **Initializing the Network Settings(P. 457)** .
- When you want to initialize the settings in <Adj. Print Position>, follow the procedure in ▶ **Adj. Print Position(P. 358)** .



▶ () ▶ <Initialize Menu> ▶ ▶ <Yes> ▶ ▶ Perform a hard reset (▶ **Performing a Hard Reset(P. 408)**)

Initializing the Network Settings

51W4-078

You can restore the network settings (▶ **Network(P. 326)**) to the factory default settings.

IMPORTANT

Do not initialize the network settings when the machine is printing or receiving print data

- Doing so may result in incorrect printing, paper jams, or damage to the machine.



▶ () ▶ <Network> ▶ ▶ Check the message ▶ ▶ <Init. Network Set.> ▶ ▶ <Yes> ▶ ▶ Perform a hard reset (▶ **Performing a Hard Reset(P. 408)**)

Appendix

Appendix	459
Third Party Software	460
Feature Highlights	461
Going Green and Saving Money	462
Improving Efficiency	463
So Much More	465
Specifications	467
Main Unit	468
Available Paper	470
Paper Feeder PF-C	474
Printer Functions	475
Management Functions	479
System Environment	483
Network Environment	484
Consumables	485
Options	487
Optional Equipment	488
System Options	489
Installing the ROM	491
Installing an SD Card	495
Manuals and Their Contents	500
Using User's Guide	501
Screen Layout of User's Guide	502
Viewing User's Guide	505
Managing MEAP Applications	507
Using FTP Clients	508
Preparing for Using the FTP Server	509
Printing via FTP Client (FTP Print)	512
Specifying Settings via FTP Client	514
Others	521
Basic Windows Operations	522
Font Samples	530
Notice	535

Appendix

51W4-079

This chapter contains technical specifications of this machine, instructions on how to use the User's Guide, disclaimers, copyright information, and other important information for customers.

Third Party Software

51W4-07A

For information related to third-party software, click the following icon(s).



Feature Highlights

51W4-07C

Give the features that are described in this section a try. The features are grouped under three headings: "Going Green and Saving Money," "Improving Efficiency," and "So Much More."

Going Green and Saving Money

51W4-07E



There are lots of ways to cut back on paper, toner, power, and expenses.

01



2-Sided Printing

You can print on both sides of the paper. Use 2-sided printing to save paper not only on large print jobs but also when you only want to print a few pages. To save even more, combine 2-sided printing with N on 1 printing of multiple pages on one sheet of paper. You can print up to 32 pages on a single sheet, which is both economical and environmentally friendly.



▶ **Printing from a Computer(P. 70)**

02



Sleep Mode

If you will not be using the machine for a while, you can save power by putting it into sleep mode, either manually or automatically. You don't need to turn OFF the power each time, but you can still have the machine minimize its power consumption. The auto shutdown function can boost the savings, by automatically turning OFF the machine if it remains idle for a longer time. These convenient functions work in the background to save power and money every day.



▶ **Entering Sleep Mode(P. 63)**

▶ **Setting Auto Shutdown Time(P. 65)**

Improving Efficiency

51W4-07F



Here are some simple operations that can make complicated tasks more efficient.

01



Print without Application Programs

You can send PDF/PS/EPS/JPEG/TIFF/XPS data from the Remote UI directly to the machine for printing. You can also print without a computer by connecting a USB memory device to the machine. There is no need to open files, so you do not need to start an application program. This is very convenient when you are in a hurry and do not have access to a computer.

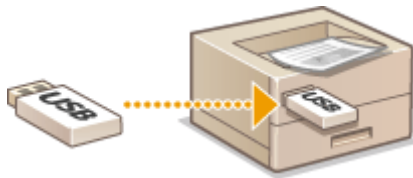

▶ **Printing without Opening a File (Direct Print)(P. 101)**

▶ **Printing from USB Memory (USB Direct Print)(P. 77)**

02



Remote Management with Remote UI

The Remote UI allows you to manage the machine remotely from the computer at your desk. You can check the remaining amounts of paper and toner cartridge, and check the current status of print jobs to decide if you should temporarily interrupt print jobs to print urgent documents or move documents up among the jobs waiting to be printed. Save time and trouble by eliminating trips between your desk and the printer.

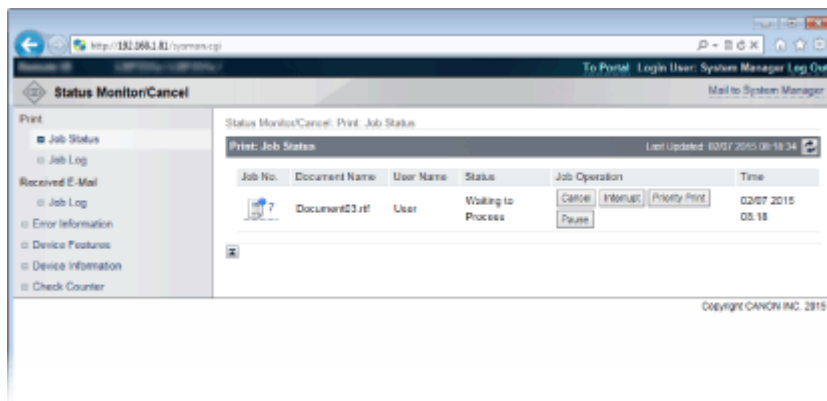

▶ **Using Remote UI(P. 283)** .

03



Save Time with Shortcuts

When you have a number of documents to print, it would be convenient to print them all with one operation. Canon PageComposer allows you to combine multiple documents and print them all at once. You can also save frequently printed documents like fax cover sheets in the machine's SD card, and then print them directly from the operation panel. You don't need to return to your computer and start the printer driver. These shortcuts save time and allow you to work more efficiently.

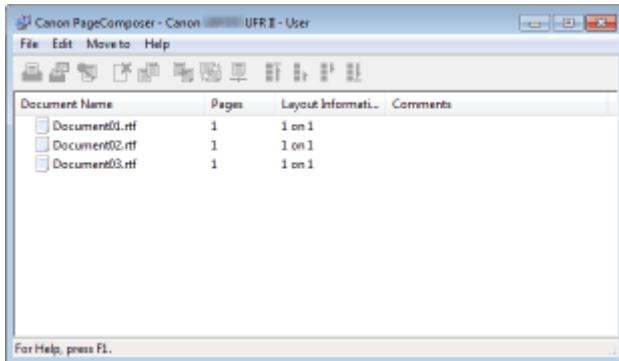

▶ **Printing from a Computer(P. 70)**

▶ **Printing a Document Stored in the Machine (Stored Job Print)(P. 92)**

04



Make Print Settings Quickly with Intuitive Operation

You can easily specify the page layout as well as binding position, switching between 1-sided and 2-sided printing, etc. intuitively on the preview image in the printer driver. The simple click-operation allows you to conveniently make settings while viewing how settings are applied.

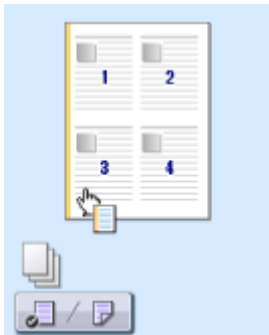

▶ **Printing from a Computer(P. 70)**

So Much More

51W4-07H



There are a variety of features for whatever you need to do - at home, in the office, or even on the road.

01



Using a smartphone/tablet

At times such as when you want to quickly print out a proposal you completed on a tablet while travelling to a business destination, Canon Mobile Application comes in handy. PCless, quick, and easy! An even broader range of possibilities for work/play with functionality made for this age of speed.



► **Can Be Used Conveniently with a Mobile Device(P. 118)**

02



Easy Printing with Google Cloud Print

Hook up to Google Cloud Print with your laptop or cell phone, send your data, and out come your printed documents. With this machine, Google Cloud Print, and your mobile device, print whenever you want from wherever you want.



► **Using Google Cloud Print(P. 128)** .

03



Keep Your Printouts Private

Normally, when you print something from your computer, it comes out of the printer right away. However, if you have sensitive documents, this may not be what you want. Just use secure printing and no one will be able to print your documents without entering your password on the machine's operation panel. Don't let your confidential documents lie exposed on the tray for everyone to see.

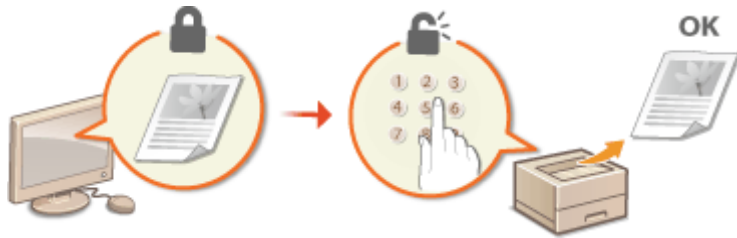

▶ **Printing a Document Secured by a PIN (Secured Print)(P. 88)**

Specifications

51W4-07J

Specifications are subject to change without notice for product improvement or future release.

■ Machine Specifications

- ▶ **Main Unit(P. 468)**
- ▶ **Available Paper(P. 470)**

■ Specifications of Optional Equipment

- ▶ **Paper Feeder PF-C(P. 474)**

■ Functional Specifications

- ▶ **Printer Functions(P. 475)**
- ▶ **Management Functions(P. 479)**

■ Environment To Use the Machine

- ▶ **System Environment(P. 483)**
- ▶ **Network Environment(P. 484)**

Main Unit

51W4-07K

NOTE

- For information on paper sizes and types for each paper source, see " [▶ Available Paper\(P. 470\)](#) ."

Type	Desktop
Color Supported	Black and White
Resolution for Writing	600 dpi x 600 dpi
Number of Tones	256
Acceptable Paper Stock	<p>Paper Sizes</p> <ul style="list-style-type: none"> Max: 216.0 mm x 355.6 mm Min (Paper Drawer): 105.0 mm x 148.0 mm Min (Multi-Purpose Tray): 76.2 mm x 127.0 mm <p>Paper Weight</p> <ul style="list-style-type: none"> Paper Drawer: 60 g/m² to 120 g/m² Multi-Purpose Tray: 60 g/m² to 199 g/m²
Paper Type	▶ Available Paper(P. 470)
Warm-Up Time ^{*1}	<p>After Powering ON</p> <p>30.0 seconds or less</p> <p>Returning from the Sleep Mode</p> <p>3.0 seconds or less</p>
First Print Time (A4)	Approx. 5.7 seconds
Print Speed ^{*2} (A4)	43.0 sheets/minute
Paper Feeding System/Capacity ^{*3}	<p>Paper Drawer</p> <p>550 sheets (80 g/m²)/640 sheets (64 g/m²) x 1</p> <p>Multi-Purpose Tray</p> <p>100 sheets (80 g/m²)/100 sheets (64 g/m²) x 1</p>
Paper Output System/Capacity ^{*3}	<p>Output Tray</p> <p>250 sheets (68 g/m²)</p>

Appendix

Power Source	AC 220 V - 240 V, 3.6 A, 50 Hz/60 Hz
Power Consumption ^{*1}	<p>Maximum Power Consumption</p> <p>1,380 W or less</p> <p>During Sleep Mode</p> <ul style="list-style-type: none"> • Approx. 1.9 W (USB connection) • Approx. 1.2 W (wired LAN connection) <p>With the Main Power Turned OFF</p> <p>0.4 W or less</p>
Dimensions (W x D x H)	417 mm x 376 mm x 330 mm
Weight	<p>Main Unit ^{*4}</p> <p>Approx. 11.5 kg</p> <p>Consumables</p> <p>➤ Consumables(P. 485)</p>
Installation Space	See "Getting Started" ➤ Manuals and Their Contents(P. 500)
Memory Capacity	RAM: 1 GB
Environmental Conditions	<ul style="list-style-type: none"> • Temperature: 10 °C to 30 °C • Humidity: 20 % to 80 % RH (no condensation)

^{*1}May vary depending on the environment and conditions under which the machine is being used.

^{*2}Print speed is measured based on internal testing using A4 size paper printed with 100% print ratio to original on one-sided paper. Internal testing involved continuously printing the same one page of content on plain paper. Print speed may vary depending on paper type, paper size or paper feeding direction. The device may automatically pause or slow down in order to adjust printer condition such as controlling temperature of a certain unit or limiting impact to image quality during continuous printing.

^{*3}May vary depending on the installation environment and paper to use.

^{*4}The toner cartridge is not included.

Available Paper

51W4-07L

The paper types that can be used with this machine are shown in the following table.

■ Supported Paper Sizes

✓ : Available — : Unavailable

Paper Size	Paper Drawer *1	Multi-Purpose Tray	Automatic 2-Sided Printing *2
A4	✓	✓	✓
B5	✓	✓	—
A5 *3	✓	✓	—
A6	✓	✓	—
Legal (LGL)	✓	✓	✓
Letter (LTR)	✓	✓	✓
Statement (STMT)	✓	✓	—
Executive (EXEC)	✓	✓	—
Foolscap (FLSC)	✓	✓	✓
16K	✓	✓	—
Index Card	—	✓	—

*1Includes the optional Paper Feeder PF-C.

*2Automatic 2-sided printing is available without replacing paper.

*3Can be loaded in portrait orientation.

*4The following sizes are available:

- When loaded in portrait orientation (only with the Canon Generic Plus UFR II printer driver used):
Width 105.0 mm to 216.0 mm, Length 148.0 mm to 355.6 mm
- When loaded in landscape orientation:
Width 148.0 mm to 216.0 mm, Length 148.0 mm to 216.0 mm

*5The following sizes are available:

- When loaded in portrait orientation (only with the Canon Generic Plus UFR II printer driver used):
Width 76.2 mm to 216.0 mm, Length 127.0 mm to 355.6 mm
- When loaded in landscape orientation:
Width 127.0 mm to 216.0 mm, Length 127.0 mm to 216.0 mm

*6The following sizes are available:

- Width 210.0 mm to 216.0 mm, Length 270.0 mm to 355.6 mm

Appendix

Paper Size	Paper Drawer *1	Multi-Purpose Tray	Automatic 2-Sided Printing *2
Indian Legal (India-LGL)	✓	✓	✓
Postcard	—	✓	—
Reply Postcard	—	✓	—
4 on 1 Postcard	—	✓	—
Envelope NAGAGATA 3	—	✓	—
Envelope YUUGATANAGA 3 (Younaga 3)	—	✓	—
Envelope No. 10 (COM10)	—	✓	—
Envelope Monarch	—	✓	—
Envelope C5 (ISO-C5)	—	✓	—
Envelope DL	—	✓	—
Custom Paper Size	✓ *4	✓ *5	✓ *6

*1Includes the optional Paper Feeder PF-C.

*2Automatic 2-sided printing is available without replacing paper.

*3Can be loaded in portrait orientation.

*4The following sizes are available:

- When loaded in portrait orientation (only with the Canon Generic Plus UFR II printer driver used):
Width 105.0 mm to 216.0 mm, Length 148.0 mm to 355.6 mm
- When loaded in landscape orientation:
Width 148.0 mm to 216.0 mm, Length 148.0 mm to 216.0 mm

*5The following sizes are available:

- When loaded in portrait orientation (only with the Canon Generic Plus UFR II printer driver used):
Width 76.2 mm to 216.0 mm, Length 127.0 mm to 355.6 mm
- When loaded in landscape orientation:
Width 127.0 mm to 216.0 mm, Length 127.0 mm to 216.0 mm

*6The following sizes are available:

- Width 210.0 mm to 216.0 mm, Length 270.0 mm to 355.6 mm

NOTE

- Some paper sizes may not be displayed depending on the printer driver. If the paper size that you want to use is not displayed, download the UFR II / UFR II LT V4 printer driver from the Canon website. If you cannot download, contact your local authorized Canon dealer or the Canon help line.

■ Supported Paper Types

Chlorine-free paper can be used with this machine.

NOTE

- Print quality may deteriorate depending on the paper type used.

✓ : Available — : Unavailable

Paper Type		Paper Drawer *1	Multi-Purpose Tray	Automatic 2-Sided Printing *2
Thin 1 *3*4	60 g/m ²	✓	✓	✓
Plain 1 *3	60 g/m ² to 74 g/m ²	✓	✓	✓
Plain 2 *3	75 g/m ² to 89 g/m ²	✓	✓	✓
Heavy 1	90 g/m ² to 105 g/m ²	✓	✓	✓
Heavy 2	106 g/m ² to 120 g/m ²	✓	✓	✓
Heavy 3	121 g/m ² to 149 g/m ²	—	✓	—
Heavy 4	150 g/m ² to 199 g/m ²	—	✓	—
Bond 1	60 g/m ² to 74 g/m ²	✓	✓	✓
Bond 2	75 g/m ² to 104 g/m ²	✓	✓	✓
Bond 3	105 g/m ² to 120 g/m ²	✓	✓	✓
Labels		—	✓	—
Postcard *5		—	✓	—
Envelope		—	✓	—
Envelope H *6		—	✓	—

*1Includes the optional Paper Feeder PF-C.

*2Automatic 2-sided printing is available without replacing paper.

*3Recycled paper is also available.

*4If the <Plain 1> setting results in curled printouts, change the setting to <Thin 1>.

*5The inkjet printable postcard or reply postcard cannot be used.

*6Specify <Envelope H> as the paper type if printouts come out faded due to poor toner fixing with <Envelope> specified.

■ Paper Type and Setting for the Machine

▶ Loading Paper(P. 39)

Paper Feeder PF-C

51W4-08F

Paper Sizes	<ul style="list-style-type: none"> ● Max: 216.0 mm x 355.6 mm ● Min: 105.0 mm x 148.0 mm
Paper Weight	60 g/m ² to 120 g/m ²
Paper Drawers Capacity *	550 sheets (80 g/m ²)/640 sheets (64 g/m ²) x 1
Dimensions (W x D x H)	417 mm x 373 mm x 156 mm
Weight	Approx. 4.0 kg

*May vary depending on the installation environment and paper to use.

Printer Functions

51W4-08H

■ UFR II Printer Function

Type	Internal
Print Size	▶ Available Paper(P. 470)
Print Speed	Same as "Print Speed" in "Main Unit" ▶ Main Unit(P. 468)
Resolution	Data Processing 1200 dpi x 1200 dpi, 600 dpi x 600 dpi
Page Description Language (PDL)	UFR II
Protocol Supported	TCP/IP, SMB (with SD card installed)
Resident Fonts	None
Interface	USB USB2.0 Wired LAN 10Base-T, 100Base-TX, 1000Base-T

■ PS Printer Function

Type	Internal
Print Size	▶ Available Paper(P. 470)
Print Speed	Same as "Print Speed" in "Main Unit" ▶ Main Unit(P. 468)
Resolution	Data Processing 600 dpi x 600 dpi
Page Description Language (PDL)	Adobe®PostScript®3™ (*Genuine Adobe PostScript. Support version is 3018)
Protocol Supported	TCP/IP, SMB (with SD card installed)

Resident Fonts	136 Roman
Interface	USB USB2.0 Wired LAN 10Base-T, 100Base-TX, 1000Base-T

■ PCL Printer Function

Type	Internal
Print Size	▶ Available Paper(P. 470)
Print Speed	Same as "Print Speed" in "Main Unit" ▶ Main Unit(P. 468)
Resolution	Data Processing 1200 dpi x 1200 dpi (only for PCL6), 600 dpi x 600 dpi
Page Description Language (PDL)	PCL6, PCL5
Protocol Supported	TCP/IP, SMB (with SD card installed)
Resident Fonts	PCL fonts: 93 Roman, 10 Bitmap fonts, 2 OCR fonts, Andalé Mono WT, THAI Fonts 12, J/K/S/T* ¹ (Japanese, Korean, Simplified and Traditional Chinese), Barcode fonts* ²
Interface	USB USB2.0 Wired LAN 10Base-T, 100Base-TX, 1000Base-T

*¹Requires optional PCL International Font Set

*²Require optional Barcode Printing Kit

■ USB Direct Print Function

Printable File Formats	<ul style="list-style-type: none"> ● PDF ● XPS ● TIFF (MH/MR/MMR/Packbits/JPEG/LZW) ● JPEG (Standard DCT method)
-------------------------------	--

■ Stored Job Print Function

- Up to 1,000 documents (3 GB total) can be stored on an SD card.

■ Direct Print Function

Printable File Formats *1	<ul style="list-style-type: none"> ● PDF (Version 1.7)*2 ● PS ● EPS ● JPEG ● TIFF ● XPS
----------------------------------	---

*1Printing may not be performed properly depending on the data.

*2The machine supports the PDF encryption algorithm of RC4 128 bit/AES 128 bit/AES 256 bit.

IMPORTANT

The maximum printable file size is as shown below.

- PDF/XPS files (with SD card installed) : 2 GB
(without SD card installed) : 20 MB
- JPEG files (with SD card installed) : 2 GB
(without SD card installed) : 2 GB
- TIFF files*1 (with SD card installed) : 2 GB
(without SD card installed) : 2 GB

*1Even TIFF files not exceeding the upper limit of size may not be printed depending on the file structure. In this case, set <TIFF Spooler> to <On> and try printing again. **▶TIFF Spooler(P. 383)**

■ E-Mail Print Function

Outline of E-Mail Print

General

- An e-mail message is printed with e-mail header information.
- An HTML e-mail message is printed as a plain text.
- If a line (without line feed) in an e-mail message contains more than 1,000 characters, excessive characters are placed on a new line and may not be correctly printed.

When <TIFF Spooler> is set to <On>

- If the e-mail message size exceeds 25 MB or the e-mail size exceeds 1.5 GB, the e-mail message is not printed.
- If the e-mail header data exceeds 20 KB, the excessive data is not printed.
- If no SD card is installed, TIFF files exceeding 40 MB in size may not be printed.
- If the SD card has no sufficient free space, E-Mail Print is not available.

IMPORTANT

- When the toner cartridge is nearly empty, no e-mails can be received.

Supported Encoding Formats	<ul style="list-style-type: none"> • 7 bit • 8 bit • binary • uuencode • x-uencode • base64 • quoted-printable
Supported Character Sets *	<ul style="list-style-type: none"> • us-ascii • iso-8859-1 • iso-8859-15
Printable Formats of Attached Image Files	<ul style="list-style-type: none"> • JPEG • TIFF

*If any character set is not specified, "us-ascii" is applied.

NOTE

Attached image files

- Some files are unavailable depending on the file structure.
- You can print up to three attached files for each e-mail. (Excessive attached files are not printed.)
- If the SD card is installed, the printable file size is 100 MB or less per file.

Management Functions

51W4-08J

■ Firewall Settings

- Up to 16 IP addresses (or ranges of IP addresses) can be specified for both IPv4 and IPv6.
- The packet filters described in this section control communications over TCP, UDP, and ICMP.
- Up to 50 MAC addresses can be specified.

■ IPSec

- IPSec that is supported by the machine conforms to RFC2401, RFC2402, RFC2406, and RFC4305.

Operating system	<ul style="list-style-type: none"> • Windows 7 • Windows 8 • Windows 8.1 • Windows 10 	
Connection mode	Transport mode	
Key exchange protocol	IKEv1 (main mode)	
	Authentication method	<ul style="list-style-type: none"> • Pre-shared key • Digital signature
	Hash algorithm (and key length)	<ul style="list-style-type: none"> • HMAC-MD5-96 • HMAC-SHA1-96
	Encryption algorithm (and key length)	<ul style="list-style-type: none"> • 3DES-CBC • AES-CBC (128 bits, 192 bits, or 256 bits)
	Key exchange algorithm/group (and key length)	Diffie-Hellman (DH) <ul style="list-style-type: none"> • Group 1 (768 bits) • Group 2 (1024 bits) • Group 14 (2048 bits)
ESP	Hash algorithm	<ul style="list-style-type: none"> • HMAC-MD5-96 • HMAC-SHA1-96
	Encryption algorithm (and key length)	<ul style="list-style-type: none"> • 3DES-CBC • AES-CBC (128 bits, 192 bits, or 256 bits)
AH	Hash algorithm	<ul style="list-style-type: none"> • HMAC-MD5-96 • HMAC-SHA1-96

NOTE

- IPSec supports communication to a unicast address (or a single device).
- The machine cannot use both IPSec and DHCPv6 at the same time.

■ Registration of Keys and Certificates

- If you install a key or CA certificate from a computer, make sure that they meet the following requirements:

Format	CA certificate: X.509 DER/PEM
File extension	CA certificate: ".cer" or ".pem"
Public key algorithm (and key length)	<ul style="list-style-type: none"> • RSA (512 bits, 1024 bits, 2048 bits, 4096 bits) • DSA (1024 bits, 2048 bits, 3072 bits) • ECDSA (P256, P384, P521)
Certificate signature algorithm	<ul style="list-style-type: none"> • RSA: SHA-1, SHA-256, SHA-384*, SHA-512*, MD2, MD5 • DSA: SHA-1 • ECDSA: SHA-1, SHA-256, SHA-384, SHA-512
Certificate thumbprint algorithm	SHA1

*RSA-SHA-384 and RSA-SHA-512 are available only when the RSA key length is 1024 bits or more.

NOTE

- The machine does not support use of a certificate revocation list (CRL).

■ Maximum Number of Job Logs That Can Be Displayed

[Print Job/Direct Print]	Up to 200 documents printed from computers and USB memory devices are displayed.
[Stored Job]	The history of up to 200 printed documents stored in the machine is displayed (only when the SD card is installed).
[Report]	The history of up to 16 documents printed as setting lists and reports is displayed (up to 128 documents when the SD card is installed).
[E-Mail Print]	The history of up to 16 e-mails printed after received is displayed (up to 128 documents when the SD card is installed).

■ E-Mail Reception Error Codes

The details of error codes are as follows.

Error Code	Cause	Action
407	The POP3 mail server was disconnected.	<ul style="list-style-type: none"> • Consult your network administrator. • If the error occurs frequently with the same e-mail data, check whether the e-mail data is normal.
	Data of 1 KB (1024 bytes) could not be received within 10 minutes during e-mail reception.	
408	The "ERR" response was returned from the POP3 mail server.	Consult your network administrator.

Appendix

412	Data of 1 KB (1024 bytes) could not be received within 10 minutes during e-mail reception.	<ul style="list-style-type: none"> • Consult your network administrator. • If the error occurs frequently with the same e-mail data, check whether the e-mail data is normal.
420	The e-mail data size exceeds 1.5 GB.	If the SD card is installed on the machine, the data size of an e-mail to send must be 1.5 GB or less.
421	The e-mail message size exceeds 25 MB.	If the SD card is installed on the machine, the message size of an e-mail to send must be 25 MB or less.
422	The size of an attached file exceeds 100 MB.	If the SD card is installed on the machine, the size of each attached file must be 100 MB or less.
423	A received attached file is in an unsupported format.	Attached files must be in JPEG or TIFF format. Do not attach any files of other formats to an e-mail to send.
424	More than three files are attached.	Excessive attached files are not printed.
430	The sender of the received e-mail is unknown.	Make sure to set a sender before sending e-mails.
431	A divided e-mail has been received.	<p>Take the following action to prevent e-mails from being sent as a divided e-mail.</p> <ul style="list-style-type: none"> • Reduce the size of an e-mail to send. (Reduce the e-mail size to be less than the one that causes a divided e-mail.) • Configure the application to prevent e-mails from being divided before sending.
	The received e-mail contains unsupported encoding or character codes.	For e-mails to send, use the encoding and character codes supported by the machine. ▶Outline of E-Mail Print(P. 477)
	The received e-mail is in an unsupported format.	Check the e-mail format. We recommend sending e-mails in text format.
432	The received data is invalid.	Check whether the data of the sent e-mail is normal.
433	The received e-mail is in HTML format.	This machine does not support HTML e-mails. (An HTML e-mail message is printed as a plain text.)
434	No message is in the e-mail.	The received e-mail contains no message.
435	Forwarded fax document is illegal.	The attached file is not in TIFF format or exceeds the printable size.
436	Forwarded fax document has no attached file.	No document is printed due to no attached file.
440	Printing was canceled for some reason.	Resend the e-mail.
441	An error has occurred during processing.	Resend the e-mail.
499	An error has occurred in the machine.	Take appropriate action according to the message on the display of the machine. For more information, see "Troubleshooting (FAQ)" on the online manual website.

NOTE:

- If two or more errors occur, only the error code of a lower number is displayed.

- You can also check error codes by using the E-Mail RX History List. [▶E-Mail RX Log List\(P. 443\)](#)

System Environment

51W4-08K

System Requirements for the Remote UI *1	Windows <ul style="list-style-type: none"> • Internet Explorer 7.0 and later
System Requirements for the User's Guide	Windows <ul style="list-style-type: none"> • Internet Explorer 9 and later • Microsoft Edge • Firefox • Firefox ESR • Chrome*2 macOS <ul style="list-style-type: none"> • Safari • Firefox • Chrome*2 Linux <ul style="list-style-type: none"> • Firefox iOS <ul style="list-style-type: none"> • Safari*2 Android <ul style="list-style-type: none"> • Chrome*2

*1Before changing the settings of the machine, set your Web browser to enable all cookies and use JavaScript.

*2Only when browsing the manual on the Internet.

Network Environment

51W4-08L

■ Network Specifications

Protocol Supported	TCP/IP <ul style="list-style-type: none">• Frame type: Ethernet II• Print applications: LPD, Raw, IPP, IPPS, WSD, Mopria, Google Cloud Print, AirPrint, Windows10 Mobile Print
Interface	Interface supporting 10BASE-T, 100BASE-TX, 1000BASE-T

Consumables

51W4-07R

This section describes the consumables of the machine and the estimated timing for replacing them. Purchase consumables at your local authorized Canon dealer. Observe safety and health precautions when storing and handling consumables. For optimum print quality, using Canon genuine Toner, Cartridge and Parts is recommended.



NOTE

- To handle and store consumables, observe the precautions below.
 - ▶ **Maintenance and Inspections(P. 9)**
 - ▶ **Consumables(P. 10)**
- Depending on the installation environment, printing paper size, or document type, you may need to replace consumables before the end of the estimated lifetime.

■ Toner Cartridges

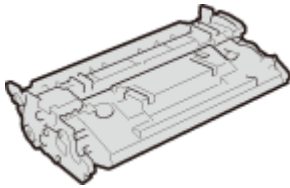

Supplied Toner Cartridges

The average yield and the weight of the toner cartridge that comes with the machine are shown below.

- Average yield*
5,100 sheets
- Weight
Approx. 0.8 kg

Replacement Toner Cartridges

For optimum print quality, using Canon genuine toner cartridges is recommended.

Canon Genuine Toner Cartridge	Average yield and weight of toner cartridge
Canon Cartridge 056 L	<ul style="list-style-type: none"> Average yield* 5,100 sheets Weight Approx. 0.8 kg
Canon Cartridge 056	<ul style="list-style-type: none"> Average yield* 10,000 sheets Weight Approx. 1.0 kg
Canon Cartridge 056 H	<ul style="list-style-type: none"> Average yield* 21,000 sheets Weight Approx. 1.4 kg

*The average yield is based on "ISO/IEC 19752" (the global standard related to "Method for the determination of toner cartridge yield for monochromatic electrophotographic printers and multi-function devices that contain printer components" issued by ISO [International Organization for Standardization]) when printing A4 size paper with the default print density setting.

IMPORTANT

Be careful of counterfeit toner cartridges

- Please be aware that there are counterfeit Canon toner cartridges in the marketplace. Use of counterfeit toner cartridge may result in poor print quality or machine performance. Canon is not responsible for any malfunction, accident or damage caused by the use of counterfeit toner cartridge. For more information, see global.canon/ctc.

NOTE

- When replacing toner cartridges  **Replacing the Toner Cartridges(P. 425)**

Options

51W4-08R

Installing options on the machine enables you to use more features.

■ Knowing What Types of Options are Available

- ▶ **Optional Equipment(P. 488)**

- ▶ **System Options(P. 489)**

■ Looking for Optional Equipment by Purpose

Adding a Paper Drawer

- ▶ **Paper Feeder PF-C(P. 488)**

Optional Equipment

51W4-07S

The functionality of the machine can be fully utilized by using the optional items described below. Optional items can be purchased from the retail outlet where you purchased the machine or from your local Canon dealer.

Paper Feeder PF-C

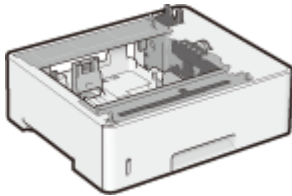

Use of the optional paper feeder allows you to load a different size of paper than that loadable in the standard paper drawer, thus reducing the time and labor of paper size replacement.

Installation Method

See "Getting Started." [▶ Manuals and Their Contents\(P. 500\)](#)

NOTE

- You can install up to three units of paper feeder in the machine.

System Options

51W4-08S

The functionality of the machine can be fully utilized by using the optional equipment described below. Optional equipment can be purchased from the retail outlet where you purchased the machine or from your local Canon dealer.

- ▶ **Barcode Printing Kit(P. 489)**
- ▶ **PCL International Font Set(P. 489)**
- ▶ **SD CARD(P. 490)**

Barcode Printing Kit

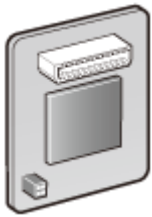

If the Barcode Printing Kit is installed on the machine, barcode printing mode is added, enabling barcodes to be printed from your computer.

The Barcode Printing Kit contains the following barcode fonts.

- OCR-B
- Symb. FontInform
- Symbole stethos
- BarDIMM ©1997
- USPS ZEBRA+4Stat

This option enables you to generate barcodes in various formats. Note that if you want to print barcodes, PCL must be enabled. For information on using the Barcode Printing Kit, see the Barcode Printing Guide (PDF manual).

Installation Method

- ▶ **Installing the ROM(P. 491)**

PCL International Font Set



If the PCL International Font Set is installed on the machine, the following fonts are added for a PCL printer. As a result, you can output using multiple languages in a SAP Unicode environment.

- Andale® and WorldType® Collection J (Japanese Version)
- Andale® and WorldType® Collection K (Korean Version)
- Andale® and WorldType® Collection S (Simplified Chinese Version)
- Andale® and WorldType® Collection T (Traditional Chinese Version)

In order to support differences in character design depending on the region, four font versions are enabled.

Installation Method

- ▶ **Installing the ROM(P. 491)**

SD CARD



You can install the SD card to use the functions described below.

- Secured Print
 - ▶ **Printing a Document Secured by a PIN (Secured Print)(P. 88)**
- Stored Job Print
 - ▶ **Printing a Document Stored in the Machine (Stored Job Print)(P. 92)**
- Interrupt Print, Priority Print, Pause/Resume
 - ▶ **Checking Current Status of Print Documents(P. 293)**
- SMB Print
 - ▶ **Configuring SMB(P. 194)**
- Spooler
 - ▶ **Spooler(P. 340)**

Installation Method

- ▶ **Installing an SD Card(P. 495)**

IMPORTANT

- When you dispose of a used SD card, perform <Completely Del. Data> for it or physically destroy it to prevent your personal information from being leaked. ▶ **Installing an SD Card(P. 495)**

Installing the ROM

51W4-07U

This section describes how to install the Barcode Printing Kit or PCL International Font Set in the machine. The ROM is used connected to the ROM connectors inside the right cover of the machine. Read the precautions in **Installation(P. 3)** before installing the ROM.

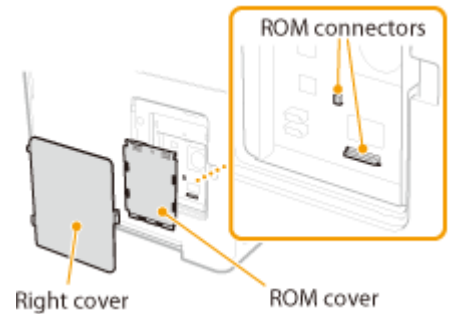

IMPORTANT

Precautions when installing the ROM

- Do not cause any metal such as screws to come into contact with the circuit boards in the machine. Doing so may result in damage to the machine.
- Do not touch the internal parts, printed wiring, connectors, or switches. Doing so may result in damage to the machine.
- Do not turn ON the power when the ROM cover is open. Doing so may result in damage to the machine.

Precautions for avoiding static electricity

The ROM contains parts that are sensitive to static electricity. Observe the following precautions for preventing the ROM from being damaged by static electricity.

- Touch a metal portion in the room to discharge static electricity from your body before handling the ROM.
- Do not touch any item that is likely to generate static electricity, such as a display, during work.
- To avoid the influence of static electricity, do not remove the ROM from the packing material until just before connecting it to the ROM connectors.

1 Turn OFF the machine, and unplug the power plug from the AC power outlet.

IMPORTANT:

- When you turn OFF the power, shut down the machine from the operation panel without using the power switch. **Turning OFF the Power (Performing a Shutdown)(P. 35)**

2 Remove the right cover.

- 1 While pushing the catch, slightly open the cover toward you.

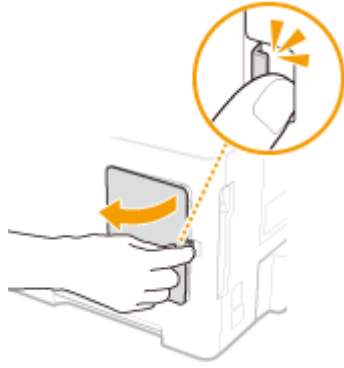

2 Remove the right cover in the direction indicated by the arrow.

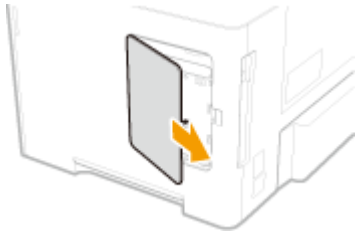

3 Remove the ROM cover.

1 Use a coin to remove the screws.

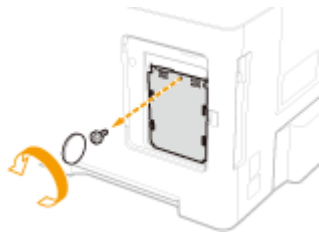

2 Open the ROM cover, and remove it in the direction indicated by the arrow.

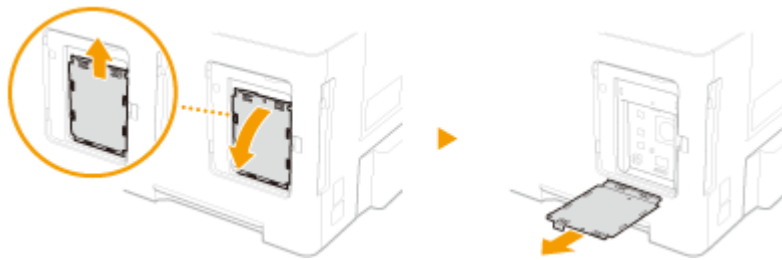

4 Install the ROM.

- While aligning the ROM with the two ROM connectors of the machine, securely push it until it stops.

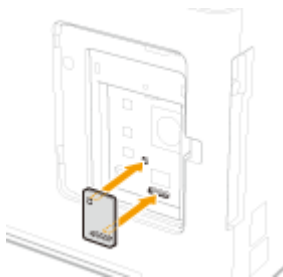

NOTE:

When disconnecting the ROM

- Hold the edges of the ROM and pull it out as shown in the illustration below.

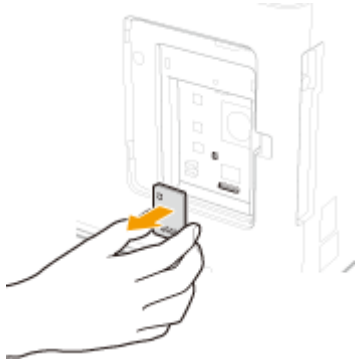

5 Put the ROM cover back into position.

- 1 Close the ROM cover by pushing in the catch of the ROM cover in the direction indicated by the arrow.

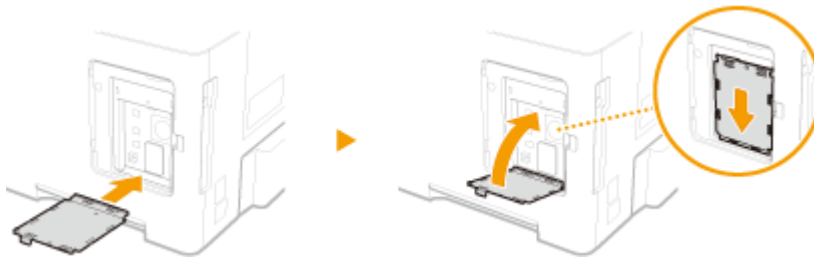

- 2 Use a coin to reattach the screws.

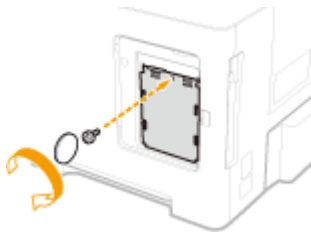

- 6 Insert the right cover in the direction indicated by the arrow, and close it while pushing the catch.

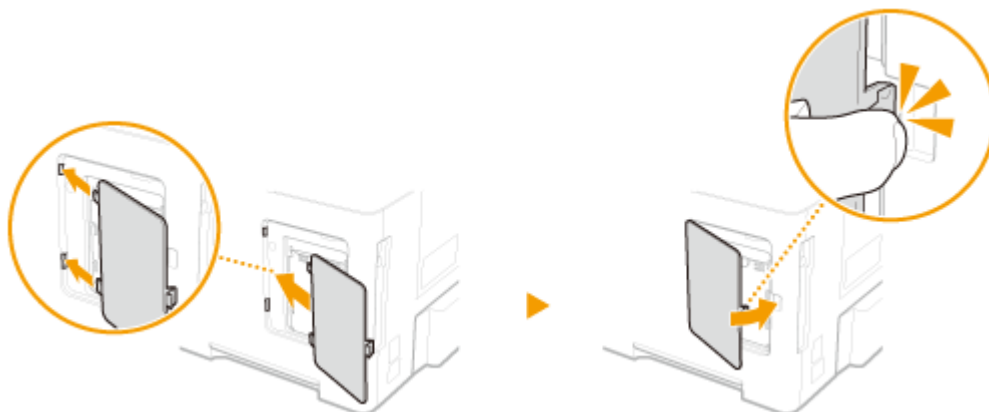

NOTE

- When you want to install an SD card at the same time, proceed to [▶Installing an SD Card\(P. 495\)](#) .

■ Checking that Barcode Printing Kit Is Properly Installed

Print the **▶ Configuration Page(P. 402)** , and confirm that "BarDIMM" is displayed in "PCL"
If "BarDIMM" is displayed, the ROM is properly installed.

NOTE:

If "BarDIMM" is not displayed

- The ROM is not installed properly. Remove the ROM from the machine, and reconnect it.

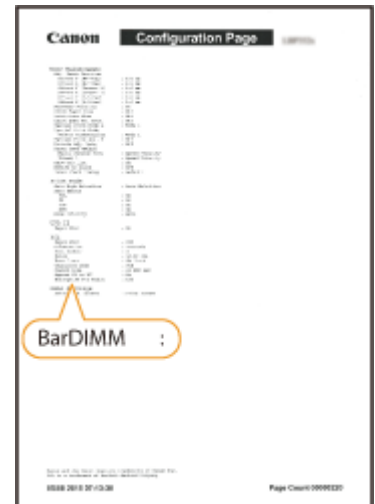

Installing an SD Card

51W4-07W

This section describes how to mount and initialize an SD card. Insert the SD card into the SD card slot on the back side of the machine. Read the precautions in **Installation(P. 3)** before installing the SD card. Note that the data in the machine that is stored to the SD card is all subjected to encryption. This ensures safe use of the SD card on a computer or in other situation because the encrypted data in the SD card is protected against unauthorized extraction.

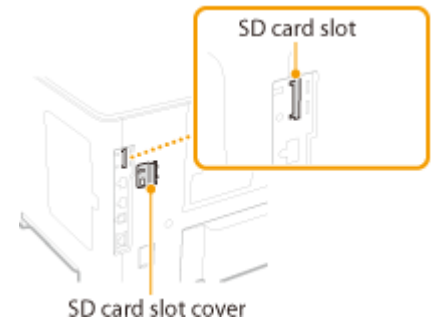

NOTE

- Before mounting the SD card, check whether the SD card is write-protected. If the card is write-protected, unlock the card before inserting it.

1 Turn OFF the machine, and unplug the power plug from the AC power outlet.

IMPORTANT:

- When you turn OFF the power, shut down the machine from the operation panel without using the power switch. **Turning OFF the Power (Performing a Shutdown)(P. 35)**

2 Remove the SD card slot cover.

1 Use a coin to remove the screws.

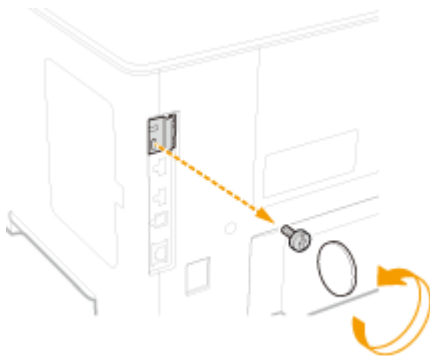

2 Open the SD card slot cover, and remove it in the direction indicated by the arrow.



3 Install an SD Card.

- Insert the card into the SD card slot until it clicks.

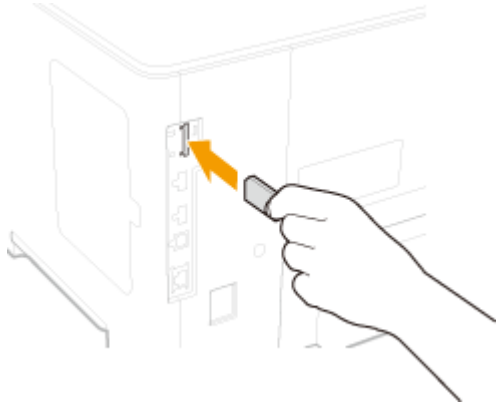

NOTE:

When removing the SD card

- Push the SD card until it clicks as shown in the illustration, release your finger, and then remove it.



4 Reinstall the SD card slot cover.

- 1 Close the SD card slot cover by pushing in the catch of the cover.



- 2 Use a coin to reattach the screws.

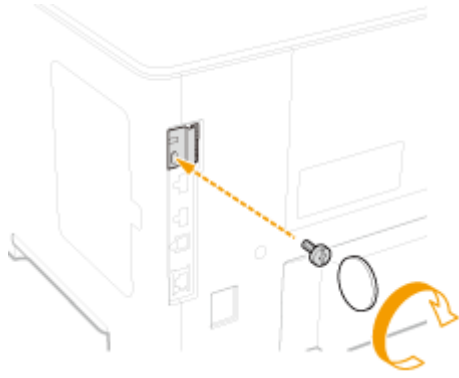

NOTE

SD Card Anti-theft Security Slot

- The SD card slot cover is provided with a security slot, to which you can attach security wire or equivalent.
- The hole of the security slot is 7.6 mm wide and 3.6 mm high.
- For inquiries about the security slot, contact your local authorized Canon dealer.

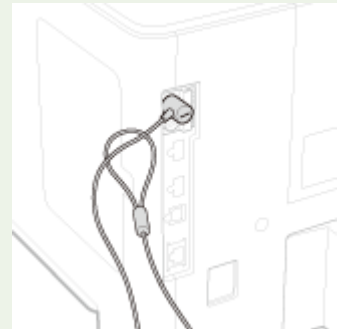

■ Initializing the SD Card

When you turn ON the power for the first time after installing the SD card, <Format SD Card?> appears on the display. Press **OK** to start initializing the SD card. When the initialization is completed, the SD card is ready to use.

Format SD Card?

OK Key: Yes
Back Key: No

NOTE:

If <Format SD Card?> is not displayed

- Initialize the SD card by selecting <Format> under <SD Card Maintenance> in the setting menu of the operation panel. **▶SD Card Maintenance(P. 363)**

■ Checking that the SD Card Is Properly Installed on the Machine

Print the **▶ Configuration Page (P. 441)**, and the SD card is installed properly if "SD Card" in "Control Menu" is "On."

NOTE:

If no SD card status information is indicated

- The SD card is not installed properly. Remove the SD card from the machine, and remount it.



■ Configuring the Information of the SD Card

If an SD card was added after the printer driver was installed, you need to configure the SD card information in the printer driver. **▶ Options (P. 487)**



■ Deleting All Data in an SD Card

Before disposing of an SD card, you can use the procedure below to delete all data in the card. The procedure deletes even those fragments of data that cannot be deleted normally. This eliminates the risk of your data being read by third parties, thus you can dispose of the SD card safely.

NOTE

- This function cannot be used with any SD card other than that indicated as an available optional device.

1 Set the machine to offline.

- When  is lit, press .

2 Press ()

3 Use / to select <User Maintenance>, and press .

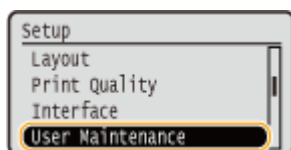

4 Proceed with <SD Card Maintenance> <Completely Del. Data> in this order.

- When a message appears, press .

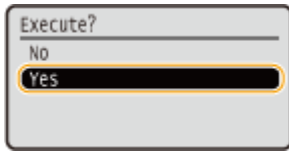
5 Select <Yes>, and press .

⇒ The machine is restarted. After that, the machine is turned OFF automatically.





NOTE

- When <Completely Del. Data> has been performed, the setting for <SD Card> changes to <Off>.

Manuals and Their Contents

51W4-07X

The manuals listed below are included with the machine. Refer to them as necessary.

Getting Started		<p>Read this manual first. It describes basic setup procedures, from removing the packing materials to setting up the machine.</p> 
User's Guide (This Manual)		<p>This manual describes all the functions of the machine in a manual that is viewed using a Web browser. You can browse information by category or enter a keyword to search for pages on a specific topic.  Using User's Guide(P. 501)</p>

Using User's Guide

51W4-07Y

The User's Guide is a manual that can be viewed on your computer or mobile device and it describes all of the functions of the machine. You can search from your intended use or enter a keyword to quickly find the page you are looking for. The section describes the screen layout of the User's Guide and how to read the Guide. You can specify how the appearance of the User's Guide looks.

■ Screen Layout of User's Guide

This section describes the screens configuring the User's Guide and how to use the on-screen buttons. [▶Screen Layout of User's Guide\(P. 502\)](#)

■ Viewing User's Guide

This section describes the meaning of the marks used in the User's Guide, how the keys on the operation panel and the buttons on the computer display are represented, and other matters that help you understand the information contained in the User's Guide. [▶Viewing User's Guide\(P. 505\)](#)

■ Specifying How the Appearance of the User's Guide Looks

You can change the character size used in the User's Guide, and switch the screen layout to fit to the device you use to view the User's Guide.

How to Find the Topic You Are Looking for

Search the contents

- You can find the page you are looking for by selecting the topic from the "Contents" on the left side of the screen.

Search by keyword

- Perform a search by entering a keyword, such as "envelope" or "toner cartridge," and the pages containing the keyword are displayed. You can find the page you are looking for from those results. You can also enter phrases such as "connecting to a network." The keyword search also supports the AND Boolean to search for multiple keywords. For the organization of the search screen and how to operate the search screen, see [▶Search\(P. 503\)](#) .

Screen Layout of User's Guide

51W4-080

The User's Guide is divided into different screens, and the content of each screen varies.

Top Page

Appears when User's Guide is started.

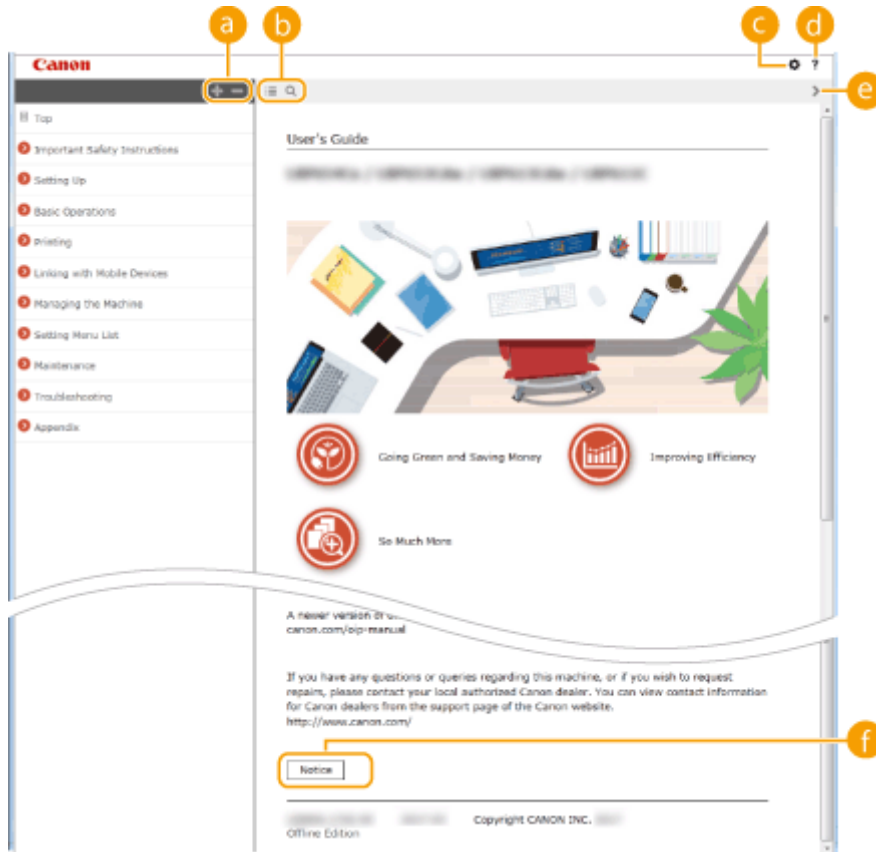

Click to also display all of the sections under the chapters. Click to return to the previous display.



Click to toggle the display between the contents and search. When the table of contents is displayed, each click on switches between hiding and showing the display. When the search display is shown, each click on switches between hiding and showing the display.



Click to set parameters to determine how the User's Guide is displayed, such as character size or layout.



Click to display information on how to view the User's Guide, how to perform a search, and other information.



Click to display the previous or following topic.



Click to view important information you should know when using the machine.

Topic Page

Contains information about how to configure and use the machine.

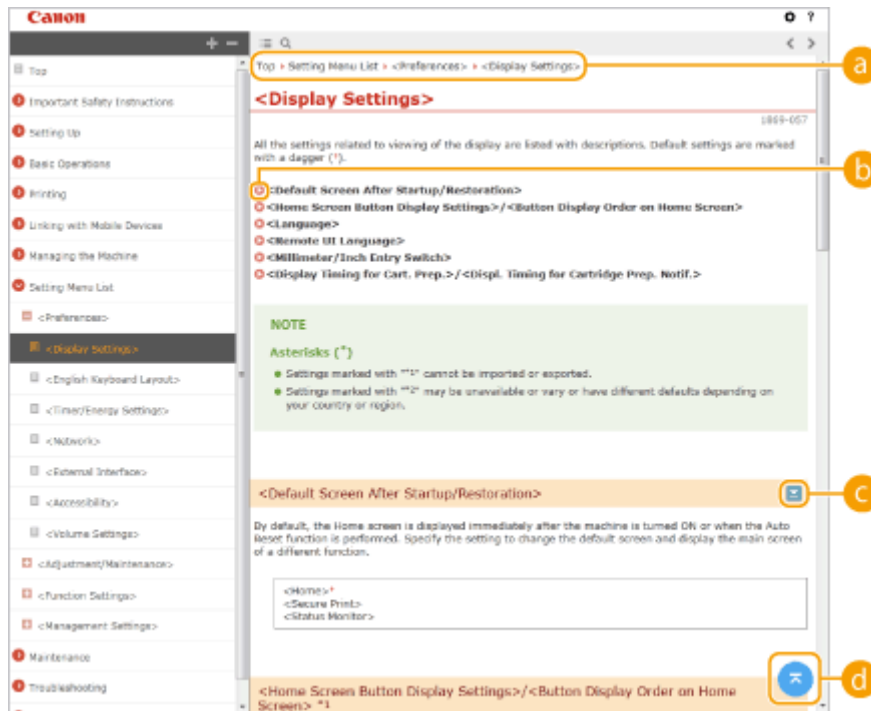



a Navigation

See what chapter topic you are currently viewing.



Click to jump to the corresponding page. To return to the previous page, click "Back" on your Web browser.



Click  to display the hidden detailed descriptions. Click  to close the detailed descriptions.



Click to return to the page top.

Search

Click  to display the search window. Contains a text box to perform a search by keyword and find the page you are looking for.

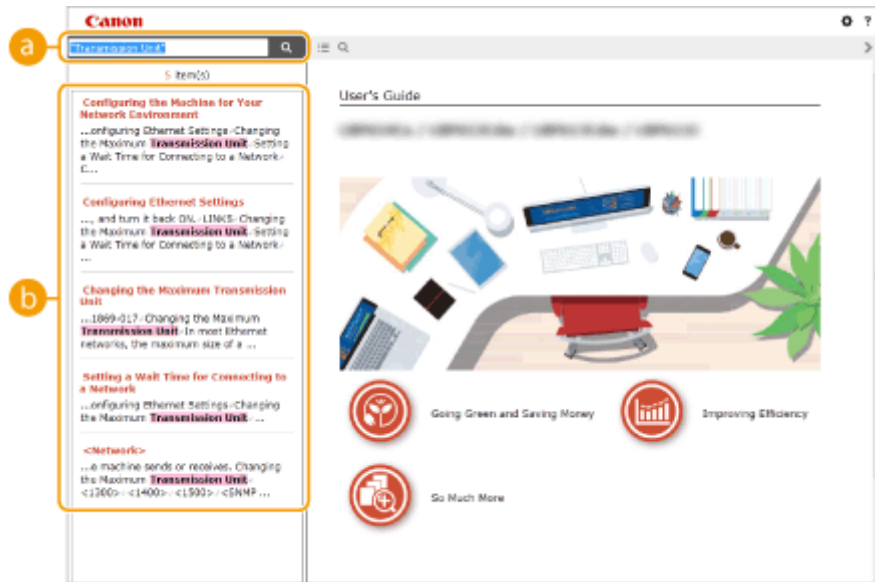

a [Enter keyword(s) here]

Enter a keyword or keywords and click  to display the search results. You can search for pages containing all the keywords by separating the keywords by a space (blank). Also you can only search for pages containing an exact phrase by enclosing the keywords in double quotation marks.

b Search result

Displays the search results of the pages that contain the specified keywords. From the results, locate the page you are looking for and click the topic title of the page.

NOTE:

- The specified keyword(s) are shown in bold in the search results.

Viewing User's Guide

51W4-081

This section describes the marks, buttons, screens, and other items used in the User's Guide. The warnings and cautions are also given in the "Important Safety Instructions" in the "Getting Started" included with the machine. See also these instructions.

Marks

Cautions regarding safety, restrictions and cautions regarding the handling of the machine, useful tips, and other information are indicated using the marks below.



Indicates a warning concerning operations that may lead to death or injury to persons if not performed correctly. To use the machine safely, always pay attention to these warnings.



Indicates a caution concerning operations that may lead to injury to persons if not performed correctly. To use the machine safely, always pay attention to these cautions.



Indicates an operation that must not be performed. Read these items carefully, and make sure not to perform the described operations.

IMPORTANT

Indicates operational requirements and restrictions. Be sure to read these items carefully to operate the machine correctly, and avoid damage to the machine or property.

NOTE

Indicates a clarification of an operation, or contains additional explanations for a procedure.

TIPS

Indicates useful functions or tips for using the machine.

Keys and Buttons Used in this Manual

Keys on the operation panel and buttons on the computer display appear in the following notation:

Type	Example
Keys on the operation panel	 ▶ (<input type="checkbox"/> <input checked="" type="checkbox"/>)
Settings displayed on the operation panel	<Timer Settings> <Paper is jammed.>
Buttons and other text interfaces displayed on the computer display	[Preferences]

▲ / ▼ Used in This Manual

The ▲ / ▼ keys are used to select a desired setting. They are only described at the first applicable occurrence of their use in a page and omitted from the second time onward. For example, the ▲ / ▼ keys appear in Step 2, but are omitted in Step 3.

Example:

- 1 Press ▶ ().
- 2 Use ▲ / ▼ to select <Network>, and press .

- 3 Select <TCP/IP Settings> ▶ <IPv4 Settings> ▶ <IP Address Settings>.

Computer Screens Used in This Manual

Depending on the operating system you are using, the appearance of the displays used in this manual may slightly differ from the actual displays. Also, the appearance of the printer driver and software may differ depending on their version.

Illustrations Used in This Manual

The illustrations of the toner cartridge used in the User's Guide are those for the Canon Cartridge 056.

Managing MEAP Applications

51W4-083

You can install MEAP applications (function-enhancing software) on the machine to add various features. You can customize the functions according to your needs, for example, to configure an authentication system with IC cards or to manage printouts based on logs. When you want to manage MEAP applications, access the machine from your computer via a Web browser. For more information, see **Function Guide for MEAP Application Management** .

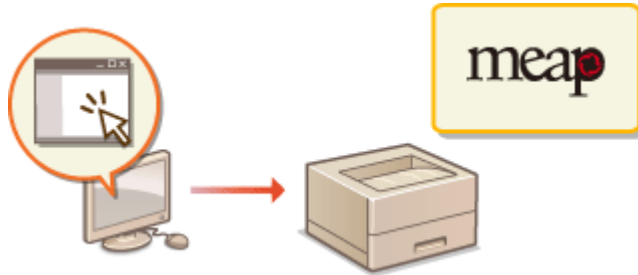

Using FTP Clients

51W4-084

You can use an FTP client to access the FTP server of the machine and specify settings for document printing and networking. Printing and settings can be performed with Command Prompt installed in the operating system as standard, requiring neither specific drivers nor specific applications.



Preparing for Using the FTP Server

Specify settings to enable communication between the machine and the clients. [▶Preparing for Using the FTP Server\(P. 509\)](#)

Printing via FTP Client (FTP Print)

You can print a document sent to the machine via FTP. [▶Printing via FTP Client \(FTP Print\)\(P. 512\)](#)

Specifying Settings via FTP Client

You can download the machine settings in text format and edit them. [▶Specifying Settings via FTP Client\(P. 514\)](#)

Preparing for Using the FTP Server

51W4-085

Because the factory default settings prevent operations from FTP clients, specify settings to allow the operations.

1 Start the Remote UI and log on in Management Mode. ▶ Starting Remote UI(P. 284)

2 Click [Settings/Registration].

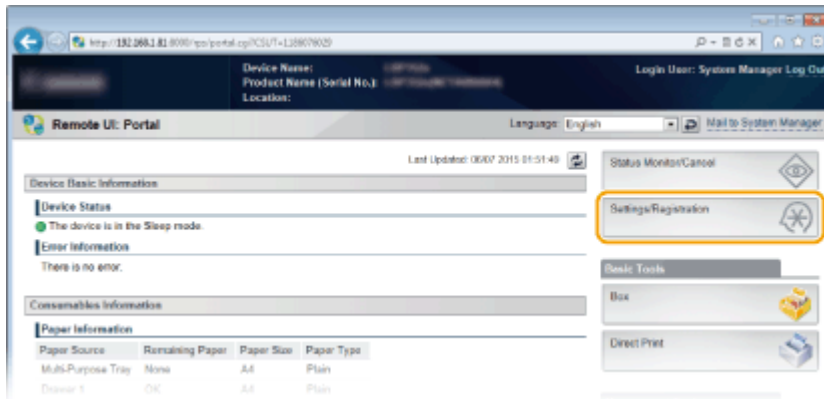

3 Click [Network] ▶ [TCP/IP Settings].

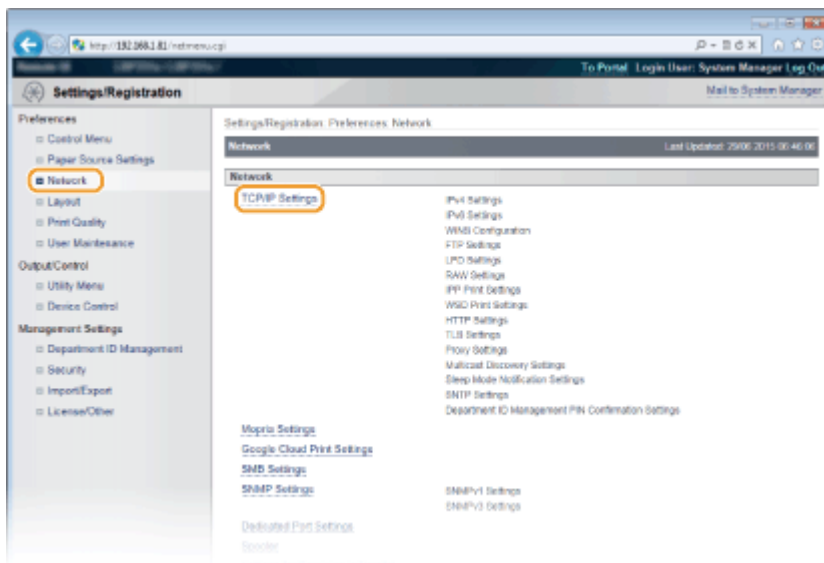

4 Click [Edit] in [FTP Settings].

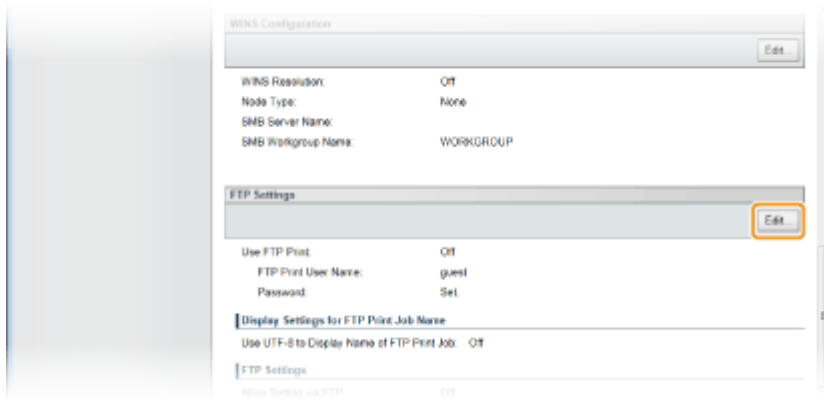

5 Specify the required settings and click [OK].

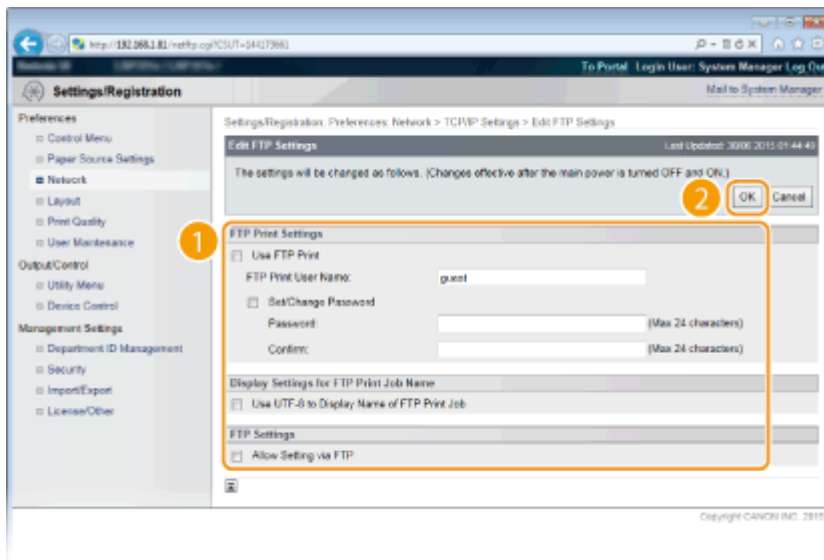

[Use FTP Print]

To perform printing via FTP client, select the check box. Otherwise, clear the check box.

[FTP Print User Name]

Enter alphanumeric characters for the user name used to log on to the FTP server when performing FTP Print.

NOTE:

- You cannot set "root."

[Set/Change Password]

Select the check box to set the FTP Print password, and enter alphanumeric characters for the password in the [Password] text box. For confirmation, enter the same password in the [Confirm] text box.

NOTE:

- If you click [OK] with the check box selected and the [Password] and [Confirm] text boxes left blank, the currently set password is deleted.

[Use UTF-8 to Display Name of FTP Print Job]

Select the check box if you are using UTF-8 character code for the name of the file to be printed.

[Allow Setting via FTP]

Select the check box to allow setting changes of the machine via FTP client. When not allowing setting changes, clear the check box.

6 Perform a hard reset.

- Click [Device Control], select [Hard Reset], and then click [Execute].

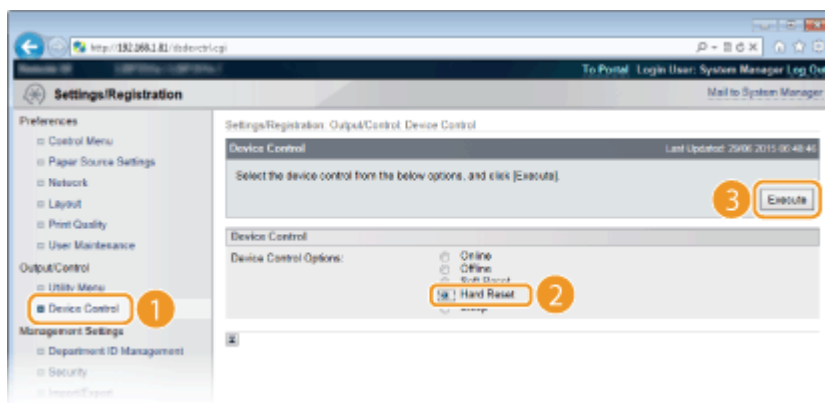

⇒ The settings are enabled after the hard reset is performed.

NOTE

Using the operation panel

- You can also enable or disable FTP print, and FTP settings from the setting menu of the operation panel. ▶ **FTP(P. 330)**

LINKS

- ▶ **Printing via FTP Client (FTP Print)(P. 512)**
- ▶ **Specifying Settings via FTP Client(P. 514)**

Printing via FTP Client (FTP Print)

51W4-086

Documents in TEXT/JPEG/TIFF format can be printed from FTP clients via network. Check the IP address set to the machine in advance ([▶Network Status Print\(P. 441\)](#)). If you are unsure of the IP address, contact your network administrator.

1 Start [Command Prompt].

- Open the [Start] menu and select [All Programs] or [Programs] ▶ [Accessories] ▶ [Command Prompt].

NOTE:

For macOS users

- Start the Terminal.

For UNIX users

- Display the console screen.

2 Copy a document that you want to print to the directory displayed in Command Prompt.

- In an example of a screen, the document is copied into the "USER_NAME" folder in [Users] on drive C:.

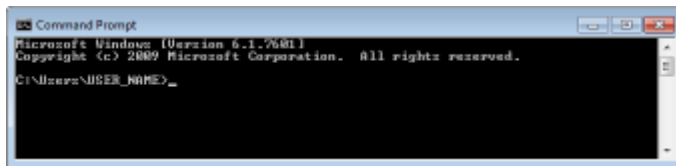

```

Microsoft Windows [Version 6.1.7601]
Copyright (c) 2009 Microsoft Corporation. All rights reserved.

C:\Users\USER_NAME>
  
```

3 Enter "ftp <IP address of the machine>" and press the [ENTER] key.

- **Example:** ftp 192.168.1.45

4 Enter the FTP Print user name and press the [ENTER] key.

- The default user name is "guest".

NOTE:

- Anonymous (a user with no account) cannot be used to log on.

5 Enter the FTP Print password and press the [ENTER] key.

- The default password is "7654321".
- ⇒ "230 User <FTP Print user name> logged in." is displayed.

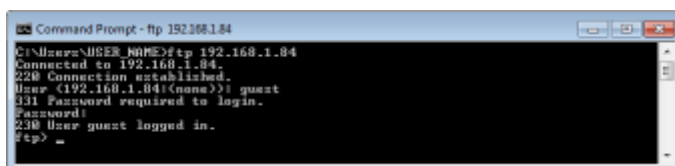

```

Microsoft Windows [Version 6.1.7601]
Copyright (c) 2009 Microsoft Corporation. All rights reserved.

C:\Users\USER_NAME>ftp 192.168.1.84
Connected to 192.168.1.84.
220 Connection established.
User (192.168.1.84:(none)) guest
331 Password required to login.
Password:
230 User guest logged in.
ftp>
  
```

6 Enter "bin" and press the [ENTER] key.

⇒ The data transfer mode is changed to binary mode.

NOTE:

- You also need to specify binary mode when printing a text document.

7 Enter "put <File name to print>" and press the [ENTER] key.

- **Example:** put sample.txt

⇒ The document is printed.

8 Enter "quit" and press the [ENTER] key.

9 Enter "exit" and press the [ENTER] key.

⇒ Command Prompt exits.

Specifying Settings via FTP Client

51W4-087

You can specify settings, such as the network settings of the machine, from an FTP client via TCP/IP network. Check the IP address set to the machine in advance ([▶Network Status Print\(P. 441\)](#)). If you are unsure of the IP address, contact your network administrator.

1 Start [Command Prompt].

- Open the [Start] menu and select [All Programs] or [Programs] ▶ [Accessories] ▶ [Command Prompt].

NOTE:

For macOS users

- Start the Terminal.

For UNIX users

- Display the console screen.

2 Enter "ftp <IP address of the machine>" and press the [ENTER] key.

- **Example:** ftp 192.168.1.45

3 Enter "root" for the user name and press the [ENTER] key.

4 Enter the System Manager password and press the [ENTER] key.

- The default password is "7654321". [▶Setting the System Manager Password\(P. 205\)](#)

⇒ "230 User root logged in." is displayed.

```

Microsoft Windows [Version 6.1.7601
Copyright (c) 2009 Microsoft Corporation. All rights reserved.
C:\Users\USER_NAME>ftp 192.168.1.45
Connected to 192.168.1.45.
220 Connection established.
User (192.168.1.84:(none)): root
331 Password required to login.
Password:
230 User root logged in.
ftp> =

```

5 Enter "cd config" and press the [ENTER] key.

6 Enter "get CONFIG <file name>" and press the [ENTER] key.

- "CONFIG" must be all uppercase.
 - Any characters can be used in <file name> (example: get CONFIG Setting.txt).
- ⇒ The setting file is downloaded to the directory that is displayed when Command Prompt is started. In an example of a screen, the file is downloaded to the "USER_NAME" folder in [Users] on drive C:.

```

C:\Users\USER_NAME>ftp 192.168.1.84
Microsoft Windows [Version 6.1.7601]
Copyright (c) 2009 Microsoft Corporation. All rights reserved.

C:\Users\USER_NAME>ftp 192.168.1.84
Connected to 192.168.1.84.
220 Connection established.
User (192.168.1.84:(none)) root
331 Password required to login.
Password:
230 User root logged in.
ftp> cd config
ftp> get CONFIG Setting.txt

```

7 Edit the downloaded config file by using the text editor such as Notepad.

■ List of config file setting items

General Menu (General Settings)

Item Name	Setting Value	Factory Default Setting
DEVICE_NAME (Device Name)	Up to 128 characters	LBP325x
SYS_LOC (Location)	Up to 128 characters	(Blank)
SYS_CONTACT (System Manager)	Up to 32 characters	(Blank)
ROOT_PWD (System Manager Password)	Up to 16 alphanumeric characters	7654321
USER_JOB_CONT (Allow End-User's Job Operation)	ON, OFF	OFF
LINK_URL1 (Support Link URL)	Up to 512 alphanumeric characters	http://canon.jp

TCP/IP Menu (TCP/IP Settings)

Item Name	Setting Value	Factory Default Setting
INT_ADDR (IP Address)	IP Address	0.0.0.0
NET_MASK (Subnet Mask)	IP Address	0.0.0.0
DEF_GW (Gateway Address)	IP Address	0.0.0.0
DHCP_ENB (Use DHCP)	ON, OFF	OFF
RARP_ENB (Use RARP)	ON, OFF	OFF
BOOTP_ENB (Use BOOTP)	ON, OFF	OFF
DNS_PADDR	IP Address	0.0.0.0

Appendix

(Primary DNS Server Address)		
DNS_SADDR (Secondary DNS Server Address)	IP Address	0.0.0.0
HOST_NAME (Host Name)	Up to 47 alphanumeric characters	"Canon"+ "Lower 6 digits of MAC address"
DOMAIN_NAME (Domain Name)	Up to 47 alphanumeric characters	(Blank)
DDNS_ENB (DNS Dynamic Update)	ON, OFF	OFF
WINS_ENB (WINS Resolution)	ON, OFF	OFF
WINS_SERVER (WINS Server Address)	IP Address	0.0.0.0
ARP_PING_ENB (Use ARP/PING)	ON, OFF	OFF
LPD_ENB (Use LPD Printing)	ON, OFF	ON
LPD_BANN (Print LPD Banner Page)	ON, OFF	OFF
RAW_ENB (Use RAW Printing)	ON, OFF	ON
RAW_BIDIR_ENB (Use Bidirectional Communication)	ON, OFF	OFF
FTP_PRINT_ENB (Use FTP Print)	ON, OFF	OFF
FTP_PRINT_USER (FTP Print User Name)	Up to 24 alphanumeric characters	guest
FTP_PRINT_PWD (FTP Print Password)	Up to 24 alphanumeric characters	7654321
IPP_ENB (Use IPP)	ON, OFF	ON
IPP_AUTH_ENB (Use IPP Authentication)	ON, OFF	OFF
IPP_AUTH_ACCUNT1 (IPP Authentication User Name)	Up to 24 alphanumeric characters (mandatory when using IPP authentication)	guest
IPP_AUTH_PASSWD1 (IPP Authentication Password)	Up to 24 alphanumeric characters (mandatory when using IPP authentication)	7654321
WSD_ENB (Use WSD Printing)	ON, OFF	ON
WSD_BROWSING (Use WSD Browsing)	ON, OFF	ON
WSD_MULTICAST_ DISCOVERY	ON, OFF	ON

Appendix

(Use Multicast Discovery)		
HTTP_ENB (Use HTTP)	ON, OFF	ON
SNTP_ENB (Use SNTP)	ON, OFF	OFF
SNTP_ADDR (NTP Server Name)	IP address or host name	(Blank)
SNTP_INTERVAL (Polling Interval)	1 to 48 (hr.)	24
DISCOVERY_ENB (Respond to Discovery)	ON, OFF	ON
DISCOVERY_SCOPE_NAME (Scope Name)	Up to 32 alphanumeric characters	default
EMAIL_PRINT_ENB (POP3 RX)	ON, OFF	OFF
EMAIL_POP_ADDR (POP3 Server Name)	Up to 48 alphanumeric characters	(Blank)
EMAIL_POP_ACCOUNT (POP3 User Name)	Up to 32 alphanumeric characters	(Blank)
EMAIL_POP_PASSWD (POP3 Password)	Up to 32 alphanumeric characters	(Blank)
EMAIL_POP_INTERVAL (POP3 RX Interval)	0 to 90 (min.)	0
EMAIL_POP_PORTNO (POP3 Server Port Number)	0 to 65535	110
IPV4_USE (Use IPv4)	ON, OFF	ON
IPV6_USE (Use IPv6)	ON, OFF	OFF
IPV6_STATELESS_USE (Use Stateless Address)	ON, OFF	ON
IPV6_MANUAL_ADDR_USE (Use Manual Address)	ON, OFF	OFF
IPV6_MANUAL_ADDR_SET (IP Address)	IP Address	(Blank)
IPV6_MANUAL_ADDR_PREFIX (Prefix Length)	0 to 128	64
IPV6_MANUAL_ROUTER_ADDR (Default Router Address)	IP Address	(Blank)
IPV6_DHCPV6_USE (Use DHCPv6)	ON, OFF	OFF
IPV6_DNS_ADDRESS_PRI (Primary DNS Server Address)	IP Address	(Blank)
IPV6_DNS_ADDRESS_SEC	IP Address	(Blank)

Appendix

(Secondary DNS Server Address)		
IPV6_DNS_NAME_SAME_AS_IPV4 (Use IPv4 Host/Domain Names)	ON, OFF	OFF
IPV6_DNS_HOST_NAME_V6 (Host Name)	Up to 47 alphanumeric characters	"Canon"+ "Lower 6 digits of MAC address"
IPV6_DNS_DOMAIN_NAME_V6 (Domain Name)	Up to 47 alphanumeric characters	(Blank)
IPV6_DNS_DYNAMIC_SET (DNS Dynamic Update)	ON, OFF	OFF
IPV6_DNS_STATELESS (Register Stateless Address)	ON, OFF	OFF
IPV6_DNS_MANUAL (Register Manual Address)	ON, OFF	OFF
IPV6_DNS_STATEFUL (Register Stateful Address)	ON, OFF	OFF

SMB Server Menu (SMB Settings)

Item Name	Setting Value	Factory Default Setting
SMB_ENB (Use SMB)	ON, OFF	OFF
SMB_SERVER (Server Name)	Up to 16 characters	(Blank)
SMB_WG (Workgroup Name)	Up to 16 characters	WORKGROUP
SMB_COMMENT (Comments)	Up to 192 characters	(Blank)
SMB_LM_ENB (Use LM Announce)	ON, OFF	OFF
SMB_PRINT_ENB (Use SMB Printing)	ON, OFF	OFF
SMB_PRINTER (Printer Name)	Up to 13 characters	PRINTER

SNMP Menu (SNMP Settings)

Item Name	Setting Value	Factory Default Setting
SNMP_V1_ENB (Use SNMPv1)	ON, OFF	ON

SNMP_COMMUNITY1_ENB (Use Community Name 1)	ON, OFF	ON
SNMP_COMMUNITY1_ACCESS (MIB Access Permission)	RW (Read/Write), RO (Read Only)	RO
SNMP_COMMUNITY1_NAME (Community Name 1)	Up to 32 alphanumeric characters	public
SNMP_COMMUNITY2_ENB (Use Community Name 2)	ON, OFF	OFF
SNMP_COMMUNITY2_ACCESS (MIB Access Permission)	RW (Read/Write), RO (Read Only)	RO
SNMP_COMMUNITY2_NAME (Community Name 2)	Up to 32 alphanumeric characters	public2
SNMP_V3_ENB (Use SNMPv3)	ON, OFF	OFF
SNMP_GET_PRT_MNG_INFO (Obtain Printer Management Information from Host)	ON, OFF	OFF

SPOOLER Menu (Spool Settings)

Item Name	Setting Value	Factory Default Setting
SPOOL_ENB (Use Spooler)	ON, OFF	OFF

START TIMER Menu (Waiting Time Settings for Connection at Startup)

Item Name	Setting Value	Factory Default Setting
STRT_DELAY_TIME (Waiting Time for Connection at Startup)	0 to 300 (sec.)	0

RUI Menu (Remote UI Settings)

Item Name	Setting Value	Factory Default Setting
RUI_ENB (Use Remote UI)	ON, OFF	ON

8 Enter "put <file name> CONFIG" and press the [ENTER] key.

- Specify the edited file name in <file name> (example: put Setting.txt CONFIG).

⇒ The setting file is uploaded.

9 Enter "get reset" and press the [ENTER] key.

⇒ The machine is restarted. The settings are enabled after the machine is restarted.

10 Confirm that the machine has been normally restarted, press [C] key while holding down the [CTRL] key.

11 Enter "quit" and press the [ENTER] key.

12 Enter "exit" and press the [ENTER] key.

⇒ Command Prompt exits.

LINKS

🔗 **Network(P. 326)**

Others

51W4-088

This section describes basic Windows operations and includes disclaimers, copyright information, and other information.

Basic Windows Operations

51W4-089

- ▶ **Displaying the Printer Folder**(P. 522)
- ▶ **Enabling [Network discovery]**(P. 522)
- ▶ **Displaying Shared Printers in the Print Server**(P. 523)
- ▶ **Displaying the [Software Programs/Manuals Setup] Screen**(P. 524)
- ▶ **Printing a Test Page in Windows**(P. 524)
- ▶ **Checking the Bit Architecture**(P. 525)
- ▶ **Checking the Computer Name**(P. 526)
- ▶ **Checking the Printer Port**(P. 527)
- ▶ **Checking Bidirectional Communication**(P. 528)
- ▶ **When Printing from the Windows Store App**(P. 529)

NOTE

- Depending on the computer that you use, the operation may differ.

■ Displaying the Printer Folder

Windows Vista

[Start] ▶ select [Control Panel] ▶ [Printer].

Windows 7/Server 2008 R2

[Start] ▶ select [Devices and Printers].

Windows 8/Server 2012

Right-click the lower-left corner of the screen ▶ select [Control Panel] ▶ [View devices and printers].

Windows 8.1/Server 2012 R2

Right-click [Start] ▶ select [Control Panel] ▶ [View devices and printers].

Windows 10

[

Windows Server 2008

[Start] ▶ select [Control Panel] ▶ double-click [Printers].

Windows Server 2016

Right-click [

■ Enabling [Network discovery]

Enable [Network discovery] to view the computers on your network.

Windows Vista

[Start] ▶ select [Control Panel] ▶ [View network status and tasks] ▶ select [Turn on network discovery] under [Network discovery].

Windows 7/Server 2008 R2

[Start] ▶ select [Control Panel] ▶ [View network status and tasks] ▶ [Change advanced sharing settings] ▶ select [Turn on network discovery] under [Network discovery].

Windows 8/Server 2012

Right-click the lower-left corner of the screen ▶ select [Control Panel] ▶ [View network status and tasks] ▶ [Change advanced sharing settings] ▶ select [Turn on network discovery] under [Network discovery].

Windows 8.1/Server 2012 R2

Right-click [Start] ► select [Control Panel] ► [View network status and tasks] ► [Change advanced sharing settings] ► select [Turn on network discovery] under [Network discovery].

Windows 10

[] ► select [Windows System] ► [Control Panel] ► [View network status and tasks] ► [Change advanced sharing settings] ► select [Turn on network discovery] under [Network discovery].

Windows Server 2008

[Start] ► select [Control Panel] ► double-click [Network and Sharing Center] ► select [Turn on network discovery] under [Network discovery].

Windows Server 2016

Right-click [] ► select [Control Panel] ► [View network status and tasks] ► [Change advanced sharing settings] ► select [Turn on network discovery] under [Network discovery].

■ Displaying Shared Printers in the Print Server

1 Open Windows Explorer.

Windows Vista/7/Server 2008

[Start] ► select [All Programs] or [Programs] ► [Accessories] ► [Windows Explorer].

Windows 8/Server 2012

Right-click the lower-left corner of the screen ► select [File Explorer].

Windows 8.1/Server 2012 R2

Right-click [Start] ► select [File Explorer].

Windows 10/Server 2016

Right-click [] ► select [File Explorer].

2 Select the printer server in [Network] or [My Network Places].

- To view computers on the network, you may need to turn on network discovery or search the network for computers.

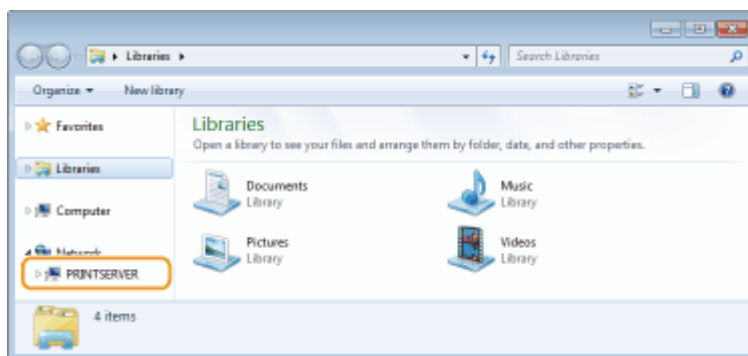

⇒ Shared printers are displayed.

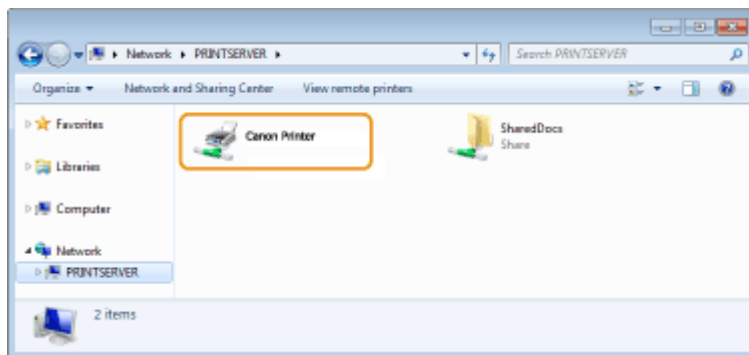

■ Displaying the [Software Programs/Manuals Setup] Screen

If your computer does not display the [Software Programs/Manuals Setup] screen after inserting the provided CD-ROM/DVD-ROM, follow the procedure below. The CD-ROM/DVD-ROM drive name is indicated as "D:" in this manual. The CD-ROM/DVD-ROM drive name may differ depending on the computer you are using.

Windows Vista/7/Server 2008

[Start] ► enter "D:\MInst.exe" in [Search programs and files] or [Start Search] ► press the [ENTER] key.

Windows 8/Server 2012

Right-click the lower-left corner of the screen ► [Run] ► enter "D:\MInst.exe" ► click [OK]

Windows 8.1/Server 2012 R2

Right-click [Start] ► [Run] ► enter "D:\MInst.exe" ► click [OK]

Windows 10

Click [Ask me anything] ► enter "D:\MInst.exe" ► click [D:\MInst.exe] displayed as the search result.

Windows Server 2016

Click [Start] ► enter "D:\MInst.exe" ► click [D:\MInst.exe] displayed as the search result.

■ Printing a Test Page in Windows

You can check whether the printer driver is operational by printing a test page in Windows.

- 1** Load A4 size paper in the paper drawer or multi-purpose tray. **▶ Loading Paper(P. 39)**
- 2** Open the printer folder. **▶ Displaying the Printer Folder(P. 522)**
- 3** Right-click the printer driver icon for this machine, and click [Printer properties] or [Properties].

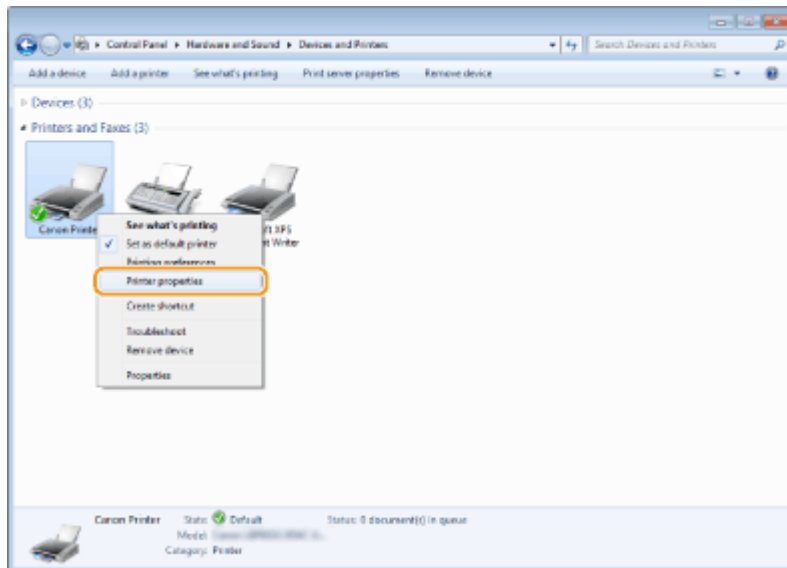

4 Click [Print Test Page] in [General] tab.

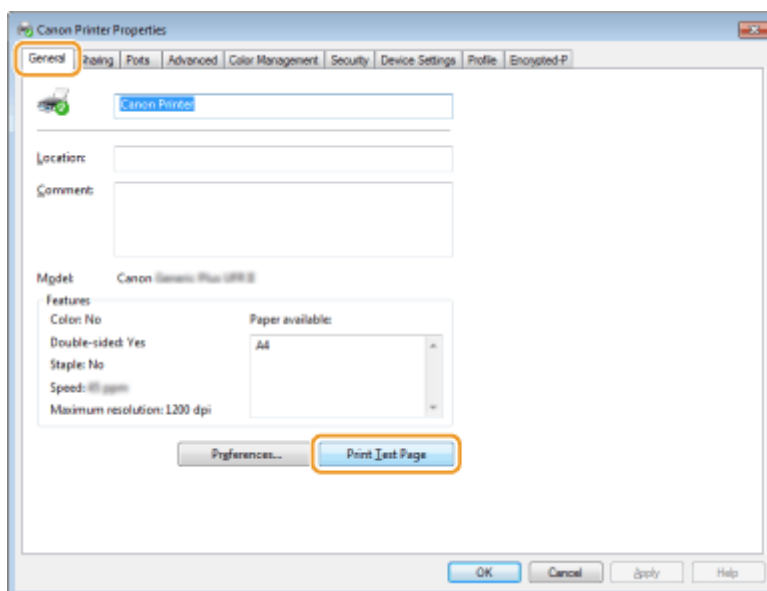

⇒ The test page is printed.

■ Checking the Bit Architecture

If you are not sure whether your computer is running 32-bit or 64-bit Windows follow the procedure below.

1 Display [Control Panel].

Windows Vista/7/Server 2008
[Start] ► select [Control Panel].

Windows 8/Server 2012
Right-click the lower-left corner of the screen ► select [Control Panel].

Windows 8.1/Server 2012 R2
Right-click [Start] ► select [Control Panel].

Windows 10/Server 2016
Proceed to step 2.

2 Display [System].

Windows Vista/7/8/Server 2008 R2/Server 2012

Click [System and Maintenance] or [System and Security] ► [System].

Windows 10/Server 2016

Click [⊞] ► [Settings] ► [System] ► select [About].

Windows Server 2008

Double-click [System].

3 Check the bit architecture.

For 32-bit versions

[32-bit Operating System] is displayed.

For 64-bit versions

[64-bit Operating System] is displayed.

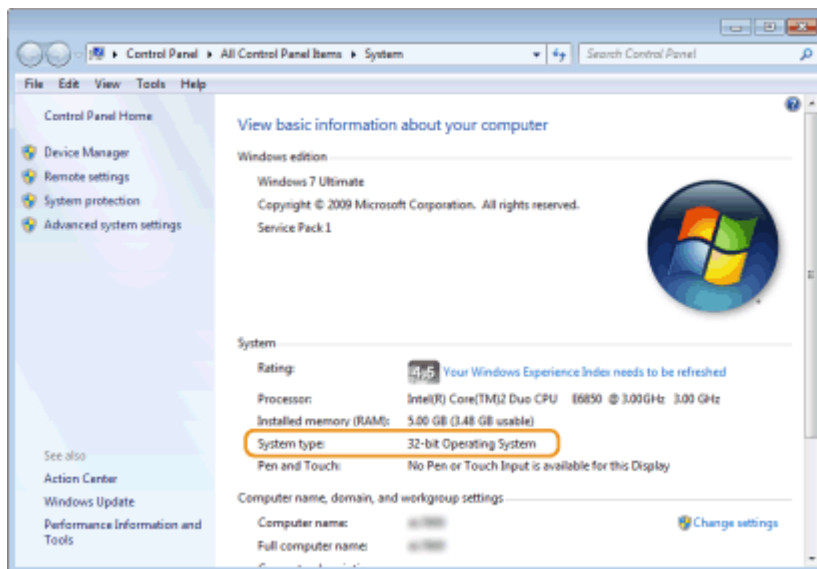

■ Checking the Computer Name

1 Display [Control Panel].

Windows Vista/7/Server 2008

[Start] ► select [Control Panel].

Windows 8/Server 2012

Right-click the lower-left corner of the screen ► select [Control Panel].

Windows 8.1/Server 2012 R2

Right-click [Start] ► select [Control Panel].

Windows 10

Click [⊞] ► select [Windows System] ► [Control Panel].

Windows Server 2016

Right-click [⊞] ► select [Control Panel].

2 Display [System].

Windows Vista/7/8/10/Server 2008 R2/Server 2012/Server 2016

Click [System and Maintenance] or [System and Security] ► [System].

Windows Server 2008

Double-click [System].

3 Check the computer name.

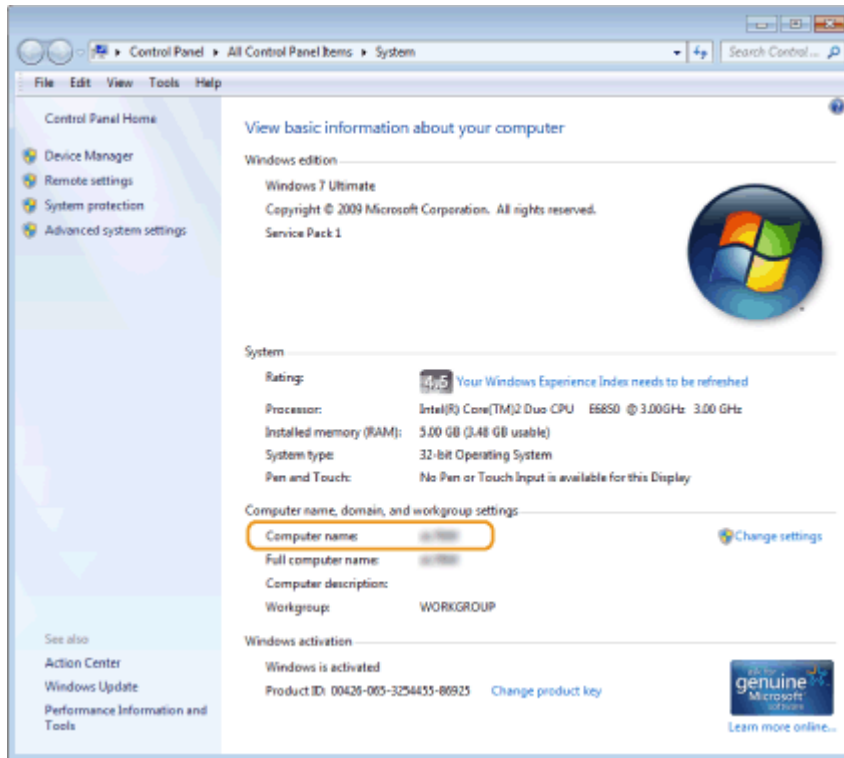

■ Checking the Printer Port

1 Open the printer folder. ► **Displaying the Printer Folder(P. 522)**

2 Right-click the printer driver icon for this machine, and click [Printer properties] or [Properties].

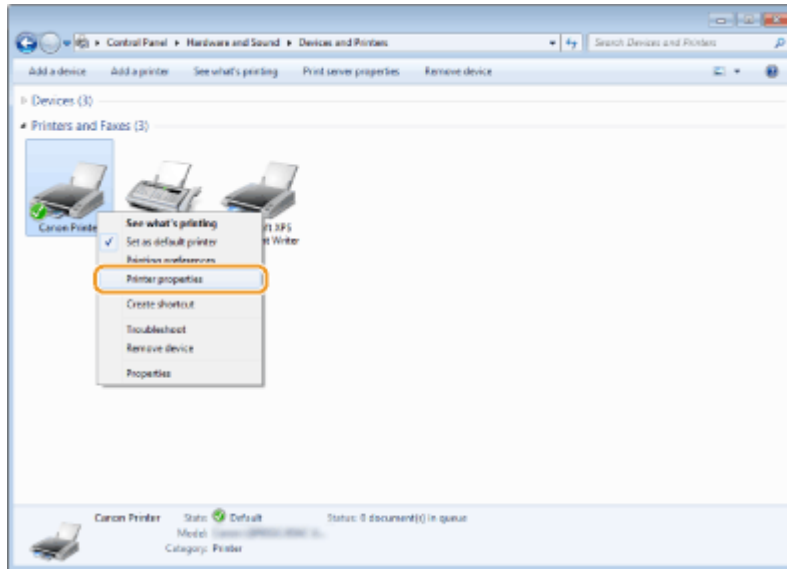

3 In the [Ports] tab, check that the port is selected correctly.

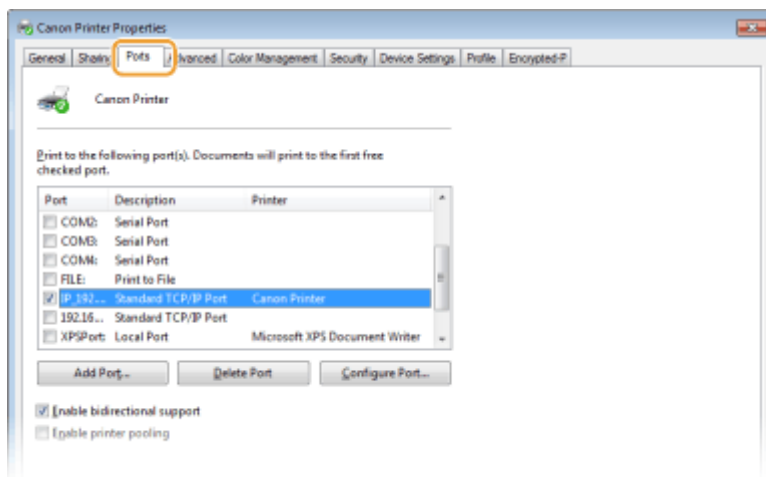

■ Checking Bidirectional Communication

1 Open the printer folder. ▶ Displaying the Printer Folder(P. 522)

2 Right-click the printer driver icon for this machine, and click [Printer properties] or [Properties].

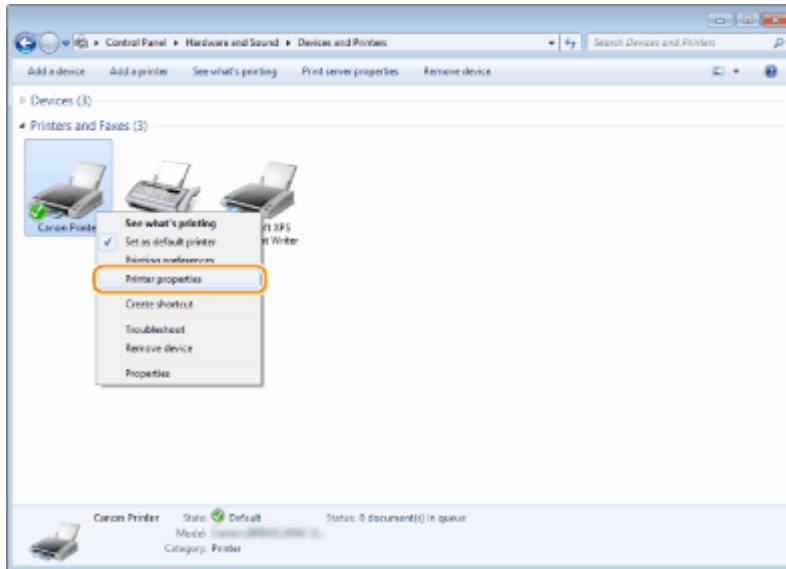

3 In the [Ports] tab, make sure that the [Enable bidirectional support] check box is selected.

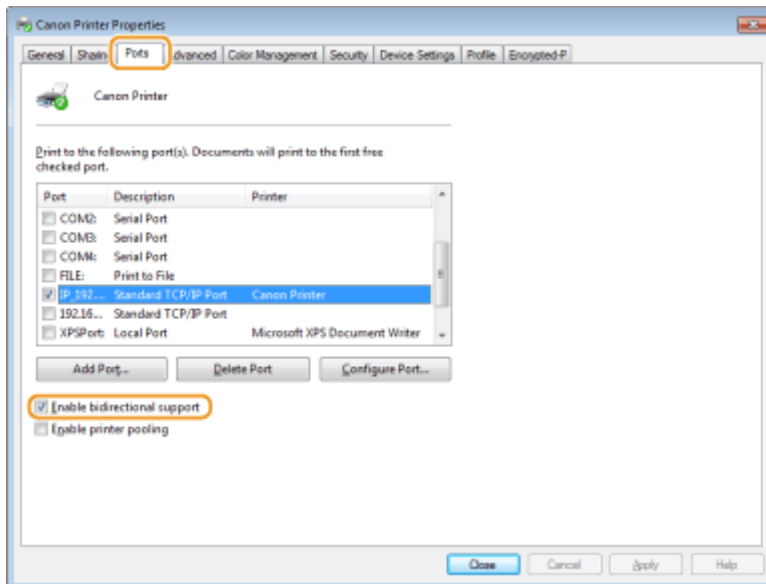

■ When Printing from the Windows Store App

Windows 8.1/Server 2012 R2

Display the charms on the right side of the screen ► Tap or click [Devices] ► [Print] ► The driver that you use ► [Print].

Windows 10

Tap or click [Print] on the application ► The driver that you use ► [Print].

Windows Server 2012

Display the charms on the right side of the screen ► Tap or click [Devices] ► The driver that you use ► [Print].

NOTE

- If you print using this method, only a limited number of print settings are available.
- If the message [The printer requires your attention. Go to the desktop to take care of it.] is displayed, go to the desktop and follow the instructions in the displayed dialog box. This message appears when the machine is set to display the user name during printing and similar instances.

Font Samples

51W4-08A

The fonts lists printed from the Utility menu are a comprehensive listing of all fonts currently available. The listing contains the names and print samples of the fonts stored on the printer.

- ▶ **Scalable Fonts (PCL)(P. 531)**
- ▶ **OCR Code Scalable Fonts (PCL) (P. 534)**
- ▶ **Bitmapped Fonts (PCL)(P. 534)**

Scalable Fonts (PCL)

Courier	ABCDEFGHIJKLMNOPQRSTUVWXYZ
CG Times	ABCDEFGHIJKLMNOPQRSTUVWXYZ
CG Times Bold	ABCDEFGHIJKLMNOPQRSTUVWXYZ
CG Times Italic	<i>ABCDEFGHIJKLMNOPQRSTUVWXYZ</i>
CG Times Bold Italic	<i>ABCDEFGHIJKLMNOPQRSTUVWXYZ</i>
CG Omega	ABCDEFGHIJKLMNOPQRSTUVWXYZ
CG Omega Bold	ABCDEFGHIJKLMNOPQRSTUVWXYZ
CG Omega Italic	<i>ABCDEFGHIJKLMNOPQRSTUVWXYZ</i>
CG Omega Bold Italic	<i>ABCDEFGHIJKLMNOPQRSTUVWXYZ</i>
Coronet	<i>ABCDEFGHIJKLMNOPQRSTUVWXYZ</i>
Clarendon Condensed Bold	ABCDEFGHIJKLMNOPQRSTUVWXYZ
Univers Medium	ABCDEFGHIJKLMNOPQRSTUVWXYZ
Univers Bold	ABCDEFGHIJKLMNOPQRSTUVWXYZ
Univers Medium Italic	<i>ABCDEFGHIJKLMNOPQRSTUVWXYZ</i>
Univers Bold Italic	<i>ABCDEFGHIJKLMNOPQRSTUVWXYZ</i>
Univers Condensed Medium	ABCDEFGHIJKLMNOPQRSTUVWXYZ
Univers Condensed Bold	ABCDEFGHIJKLMNOPQRSTUVWXYZ
Univers Condensed Medium Italic	<i>ABCDEFGHIJKLMNOPQRSTUVWXYZ</i>
Univers Condensed Bold Italic	<i>ABCDEFGHIJKLMNOPQRSTUVWXYZ</i>
Antique Olive	ABCDEFGHIJKLMNOPQRSTUVWXYZ
Antique Olive Bold	ABCDEFGHIJKLMNOPQRSTUVWXYZ
Antique Olive Italic	<i>ABCDEFGHIJKLMNOPQRSTUVWXYZ</i>
Garamond Antiqua	ABCDEFGHIJKLMNOPQRSTUVWXYZ
Garamond Halbfett	ABCDEFGHIJKLMNOPQRSTUVWXYZ
Garamond Kursiv	<i>ABCDEFGHIJKLMNOPQRSTUVWXYZ</i>
Garamond Kursiv Halbfett	<i>ABCDEFGHIJKLMNOPQRSTUVWXYZ</i>
Marigold	<i>ABCDEFGHIJKLMNOPQRSTUVWXYZ</i>
Albertus Medium	ABCDEFGHIJKLMNOPQRSTUVWXYZ
Albertus Extra Bold	ABCDEFGHIJKLMNOPQRSTUVWXYZ
Ryadh	ABCDEFGHIJKLMNOPQRSTUVWXYZ
Ryadh Bold	ABCDEFGHIJKLMNOPQRSTUVWXYZ

Malka	ABCDEFGHIJKLMNOPQRSTUVWXYZ
Malka Bold	ABCDEFGHIJKLMNOPQRSTUVWXYZ
Malka Italic	<i>ABCDEFGHIJKLMNOPQRSTUVWXYZ</i>
Dorit	ABCDEFGHIJKLMNOPQRSTUVWXYZ
Dorit Bold	ABCDEFGHIJKLMNOPQRSTUVWXYZ
Naamit	ABCDEFGHIJKLMNOPQRSTUVWXYZ
Naamit Bold	ABCDEFGHIJKLMNOPQRSTUVWXYZ
Arial	ABCDEFGHIJKLMNOPQRSTUVWXYZ
Arial Bold	ABCDEFGHIJKLMNOPQRSTUVWXYZ
Arial Italic	<i>ABCDEFGHIJKLMNOPQRSTUVWXYZ</i>
Arial Bold Italic	<i>ABCDEFGHIJKLMNOPQRSTUVWXYZ</i>
Times New Roman	ABCDEFGHIJKLMNOPQRSTUVWXYZ
Times New Roman Bold	ABCDEFGHIJKLMNOPQRSTUVWXYZ
Times New Roman Italic	<i>ABCDEFGHIJKLMNOPQRSTUVWXYZ</i>
Times New Roman Bold Italic	<i>ABCDEFGHIJKLMNOPQRSTUVWXYZ</i>
Helvetica	ABCDEFGHIJKLMNOPQRSTUVWXYZ
Helvetica Bold	ABCDEFGHIJKLMNOPQRSTUVWXYZ
Helvetica Oblique	<i>ABCDEFGHIJKLMNOPQRSTUVWXYZ</i>
Helvetica Bold Oblique	<i>ABCDEFGHIJKLMNOPQRSTUVWXYZ</i>
Helvetica Narrow	ABCDEFGHIJKLMNOPQRSTUVWXYZ
Helvetica Narrow Bold	ABCDEFGHIJKLMNOPQRSTUVWXYZ
Helvetica Narrow Oblique	<i>ABCDEFGHIJKLMNOPQRSTUVWXYZ</i>
Helvetica Narrow Bold Oblique	<i>ABCDEFGHIJKLMNOPQRSTUVWXYZ</i>
Palatino Roman	ABCDEFGHIJKLMNOPQRSTUVWXYZ
Palatino Bold	ABCDEFGHIJKLMNOPQRSTUVWXYZ
Palatino Italic	<i>ABCDEFGHIJKLMNOPQRSTUVWXYZ</i>
Palatino Bold Italic	<i>ABCDEFGHIJKLMNOPQRSTUVWXYZ</i>
ITC Avant Garde Gothic Book	ABCDEFGHIJKLMNOPQRSTUVWXYZ
ITC Avant Garde Gothic Demi	ABCDEFGHIJKLMNOPQRSTUVWXYZ
ITC Avant Garde Gothic Book Oblique	<i>ABCDEFGHIJKLMNOPQRSTUVWXYZ</i>
ITC Avant Garde Gothic Demi Oblique	<i>ABCDEFGHIJKLMNOPQRSTUVWXYZ</i>

ITC Bookman Light	ABCDEFGHIJKLMNOPQRSTUVWXYZ
ITC Bookman Demi	ABCDEFGHIJKLMNOPQRSTUVWXYZ
ITC Bookman Light Italic	<i>ABCDEFGHIJKLMNOPQRSTUVWXYZ</i>
ITC Bookman Demi Italic	<i>ABCDEFGHIJKLMNOPQRSTUVWXYZ</i>
New Century Schoolbook Roman	ABCDEFGHIJKLMNOPQRSTUVWXYZ
New Century Schoolbook Bold	ABCDEFGHIJKLMNOPQRSTUVWXYZ
New Century Schoolbook Italic	<i>ABCDEFGHIJKLMNOPQRSTUVWXYZ</i>
New Century Schoolbook Bold Italic	<i>ABCDEFGHIJKLMNOPQRSTUVWXYZ</i>
Times Roman	ABCDEFGHIJKLMNOPQRSTUVWXYZ
Times Bold	ABCDEFGHIJKLMNOPQRSTUVWXYZ
Times Italic	<i>ABCDEFGHIJKLMNOPQRSTUVWXYZ</i>
Times Bold Italic	<i>ABCDEFGHIJKLMNOPQRSTUVWXYZ</i>
ITC Zapf Chancery Medium Italic	<i>ABCDEFGHIJKLMNOPQRSTUVWXYZ</i>
Symbol	ΑΒΧΔΕΦΓΗΘΚΛΜΝΟΠΡΣΤΥϚΩΞΨΖ
SymbolPS	ΑΒΧΔΕΦΓΗΘΚΛΜΝΟΠΡΣΤΥϚΩΞΨΖ
Wingdings	☺☻☼☽☾☿♁♂♃♄♅♆♇♈♉♊♋♌♍♎♏♐♑♒♓♔♕♖♗♘♙♚♛♜♝♞♟♠♡♢♣♤♥♦♧♨♩♪♫♬♭♮♯♰♱♲♳♴♵♶♷♸♹♺♻♼♽♾♿
ITC Zapf Dingbats	♠♡♢♣♤♥♦♧♨♩♪♫♬♭♮♯♰♱♲♳♴♵♶♷♸♹♺♻♼♽♾♿
Courier Bold	ABCDEFGHIJKLMNOPQRSTUVWXYZ
Courier Italic	<i>ABCDEFGHIJKLMNOPQRSTUVWXYZ</i>
Courier Bold Italic	<i>ABCDEFGHIJKLMNOPQRSTUVWXYZ</i>
Letter Gothic	ABCDEFGHIJKLMNOPQRSTUVWXYZ
Letter Gothic Bold	ABCDEFGHIJKLMNOPQRSTUVWXYZ
Letter Gothic Italic	<i>ABCDEFGHIJKLMNOPQRSTUVWXYZ</i>
Naskh	ABCDEFGHIJKLMNOPQRSTUVWXYZ
Naskh Bold	ABCDEFGHIJKLMNOPQRSTUVWXYZ
Koufi	ABCDEFGHIJKLMNOPQRSTUVWXYZ
Koufi Bold	ABCDEFGHIJKLMNOPQRSTUVWXYZ
CourierPS	ABCDEFGHIJKLMNOPQRSTUVWXYZ
CourierPS Bold	ABCDEFGHIJKLMNOPQRSTUVWXYZ
CourierPS Oblique	<i>ABCDEFGHIJKLMNOPQRSTUVWXYZ</i>
CourierPS Bold Oblique	<i>ABCDEFGHIJKLMNOPQRSTUVWXYZ</i>

Notice

51W4-08C

■ IPv6 Ready Logo



The protocol stack included in this machine has obtained the IPv6 Ready Logo Phase-2 established by the IPv6 Forum.

■ Product Information required by COMMISSION REGULATION (EU) No 801/2013 amending Regulation (EC) No 1275/2008

Power consumption of the product in networked standby if wired network ports are connected and all wireless network ports are activated (if they are available at the same time).

Model Name	Power consumption of the product in networked standby
LBP325x	3.0 W or less

NOTE

- The above value(s) are the actual values for single machine, chosen arbitrarily, and may therefore vary from the value of the machine in use. Optional network ports are not connected and/or activated in the measurement.

■ WEEE and Battery Directives



Only for European Union and EEA (Norway, Iceland and Liechtenstein)

These symbols indicate that this product is not to be disposed of with your household waste, according to the WEEE Directive (2012/19/EU), the Battery Directive (2006/66/EC) and/or national legislation implementing those Directives. If a chemical symbol is printed beneath the symbol shown above, in accordance with the Battery Directive, this indicates that a heavy metal (Hg = Mercury, Cd = Cadmium, Pb = Lead) is present in this battery or accumulator at a concentration above an applicable threshold specified in the Battery Directive.

This product should be handed over to a designated collection point, e.g., on an authorized one-for-one basis when you buy a new similar product or to an authorized collection site for recycling waste electrical and electronic equipment (EEE) and batteries and accumulators. Improper handling of this type of waste could have a possible impact on the environment and human health due to potentially hazardous substances that are generally associated with EEE. Your cooperation in the correct disposal of this product will contribute to the effective usage of natural resources.

For more information about the recycling of this product, please contact your local city office, waste authority, approved scheme or your household waste disposal service or visit www.canon-europe.com/weee, or www.canon-europe.com/battery.

■ Environmental Information

Reducing your environmental impact while saving money

Power Consumption and Activation Time

The amount of electricity a device consumes depends on the way the device is used. This product is designed and set in a way to allow you to reduce your electricity costs. After the last print it switches to Ready Mode. In this mode it can print again immediately if required. If the product is not used for a time, the device switches to its Power Save Mode. The devices consume less power (Watt) in these modes.

If you wish to set a longer Activation Time or would like to completely deactivate the Power Save Mode, please consider that this device may then only switch to a lower energy level after a longer period of time or not at all. Canon does not recommend extending the Activation Times from the optimum ones set as default.

Energy Star®

The Energy Star® programme is a voluntary scheme to promote the development and purchase of energy efficient models, which help to minimise environmental impact.

Products which meet the stringent requirements of the Energy Star® programme for both environmental benefits and the amount of energy consumption will carry the Energy Star® logo accordingly.

Paper types

This product can be used to print on both recycled and virgin paper (certified to an environmental stewardship scheme), which complies with EN12281 or a similar quality standard. In addition it can support printing on media down to a weight of 64g/m².

Lighter paper means less resources used and a lower environmental footprint for your printing needs.

Duplex printing (Standard duplex printing products only)

Duplex printing capability enables you to print on both sides automatically, and therefore helps to reduce the use of valuable resources by reducing your paper consumption.

The duplex function has been auto enabled during the set up and driver installation and Canon strongly recommends that you do not disable this function. You should continue to use the duplex function to reduce the environmental impact of your work with this product at all times.

■ Disclaimers

- The information in this document is subject to change without notice.
- CANON INC. MAKES NO WARRANTY OF ANY KIND WITH REGARD TO THIS MATERIAL, EITHER EXPRESS OR IMPLIED, EXCEPT AS PROVIDED HEREIN, INCLUDING WITHOUT LIMITATION, THEREOF, WARRANTIES AS TO MARKETABILITY, MERCHANTABILITY, FITNESS FOR A PARTICULAR PURPOSE OF USE, OR NON-INFRINGEMENT. CANON INC. SHALL NOT BE LIABLE FOR ANY DIRECT, INCIDENTAL, OR CONSEQUENTIAL DAMAGES OF ANY NATURE, OR LOSSES OR EXPENSES RESULTING FROM THE USE OF THIS MATERIAL.
- If you do not have access to Adobe Reader to view the manuals in PDF format, try other programs such as PDF Preview developed by Vivid Document Imaging Technologies.

■ Trademarks

Adobe, Acrobat and Reader are registered trademarks of Adobe Systems Incorporated in the United States and/or other countries.

Apple, Bonjour, iPad, iPhone, iPod touch, Safari, Mac, macOS and OS X are trademarks of Apple Inc.

Microsoft, Windows, Windows Vista, Windows Server, Internet Explorer, Microsoft Edge, Excel and PowerPoint are either registered trademarks or trademarks of Microsoft Corporation in the United States and/or other countries.

iOS is a trademark or registered trademark of Cisco in the U.S. and other countries and is used under license.

"MEAP" is a trademark of CANON Inc., referring to an "application platform" for Canon multifunction and single function printers.

Mopria®, the Mopria® Logo and the Mopria® Alliance logo are registered trademarks and service marks of Mopria Alliance, Inc. in the United States and other countries. Unauthorized use is strictly prohibited.

Google Cloud Print, Google Chrome and Android are either registered trademarks or trademarks of Google Inc.

UFST: Copyright © 1989 - 1996, 1997, 2003, 2004, 2008, all rights reserved, by Monotype Imaging Inc.

This product contains the Universal Font Scaling Technology or UFST® under license from Monotype Imaging, Inc.

UFST® is a trademark of Monotype Imaging, Inc. registered in the United States Patent and Trademark Office and may be registered in certain jurisdictions.



Java and all Java based trademarks and logos are trademarks or registered trademarks of Oracle and/or its affiliates.



Copyright © 2007 -08 Adobe Systems Incorporated. All rights reserved.

Protected by U.S. Patents 5,737,599; 5,781,785; 5,819,301; 5,929,866; 5,943,063; 6,073,148; 6,515,763; 6,639,593; 6,754,382; 7,046,403; 7,213,269; 7,242,415; Patents pending in the U.S. and other countries.

All instances of the name PostScript in the text are references to the PostScript language as defined by Adobe Systems Incorporated unless otherwise stated. The name PostScript also is used as a product trademark for Adobe Systems' implementation of the PostScript language interpreter.

Except as otherwise stated, any reference to a "PostScript printing device," "PostScript display device," or similar item refers to a printing device, display device or item (respectively) that contains PostScript technology created or licensed by Adobe Systems Incorporated and not to devices or items that purport to be merely compatible with the PostScript language.

Adobe, the Adobe logo, PostScript, the PostScript logo, and PostScript 3 are either registered trademarks or trademarks of Adobe Systems Incorporated in the United States and/or other countries.

Linux is a registered trademark of Linus Torvalds. Microsoft and Windows are either registered trademarks or trademarks of Microsoft Corporation in the United States and/or other countries.

All other trademarks are the property of their respective owners.

All other product and brand names are registered trademarks, trademarks or service marks of their respective owners.

■ Copyright

Reproduction of the contents of this document in whole or in part without prior permission is prohibited.

■ Legal Limitations on the Usage of Your Product and the Use of Images

Using your product to scan, print or otherwise reproduce certain documents, and the use of such images as scanned, printed or otherwise reproduced by your product, may be prohibited by law and may result in criminal and/or civil liability. A non-exhaustive list of these documents is set forth below. This list is intended to be a guide only. If you are uncertain about the legality of using your product to scan, print or otherwise reproduce any particular document, and/or of the use of the images scanned, printed or otherwise reproduced, you should consult in advance with your legal advisor for guidance.

- Paper Money
- Travelers Checks
- Money Orders
- Food Stamps
- Certificates of Deposit
- Passports
- Postage Stamps (canceled or uncanceled)
- Immigration Papers
- Identifying Badges or Insignias
- Internal Revenue Stamps (canceled or uncanceled)
- Selective Service or Draft Papers
- Bonds or Other Certificates of Indebtedness
- Checks or Drafts Issued by Governmental Agencies
- Stock Certificates
- Motor Vehicle Licenses and Certificates of Title
- Copyrighted Works/Works of Art without Permission of Copyright Owner

V_190320

This Font Software is licensed under the SIL Open Font License, Version 1.1.

This license is copied below, and is also available with a FAQ at: <http://scripts.sil.org/OFL>

SIL OPEN FONT LICENSE Version 1.1 - 26 February 2007

PREAMBLE

The goals of the Open Font License (OFL) are to stimulate worldwide development of collaborative font projects, to support the font creation efforts of academic and linguistic communities, and to provide a free and open framework in which fonts may be shared and improved in partnership with others.

The OFL allows the licensed fonts to be used, studied, modified and redistributed freely as long as they are not sold by themselves. The fonts, including any derivative works, can be bundled, embedded, redistributed and/or sold with any software provided that any reserved names are not used by derivative works. The fonts and derivatives, however, cannot be released under any other type of license. The requirement for fonts to remain under this license does not apply to any document created using the fonts or their derivatives.

DEFINITIONS

"Font Software" refers to the set of files released by the Copyright Holder(s) under this license and clearly marked as such. This may include source files, build scripts and documentation.

"Reserved Font Name" refers to any names specified as such after the copyright statement(s).

"Original Version" refers to the collection of Font Software components as distributed by the Copyright Holder(s).

"Modified Version" refers to any derivative made by adding to, deleting, or substituting -- in part or in whole -- any of the components of the Original Version, by changing formats or by porting the Font Software to a new environment.

"Author" refers to any designer, engineer, programmer, technical writer or other person who contributed to the Font Software.

PERMISSION & CONDITIONS

Permission is hereby granted, free of charge, to any person obtaining a copy of the Font Software, to use, study, copy, merge, embed, modify, redistribute, and sell modified and unmodified copies of the Font Software, subject to the following conditions:

- 1) Neither the Font Software nor any of its individual components, in Original or Modified Versions, may be sold by itself.
- 2) Original or Modified Versions of the Font Software may be bundled, redistributed and/or sold with any software, provided that each copy contains the above copyright notice and this license. These can be included either as stand-alone text files, human-readable headers or in the appropriate machine-readable metadata fields within text or binary files as long as those fields can be easily viewed by the user.
- 3) No Modified Version of the Font Software may use the Reserved Font Name(s) unless explicit written permission is granted by the corresponding Copyright Holder. This restriction only applies to the primary font name as presented to the users.
- 4) The name(s) of the Copyright Holder(s) or the Author(s) of the Font Software shall not be used to promote, endorse or advertise any Modified Version, except to acknowledge the contribution(s) of the Copyright Holder(s) and the Author(s) or with their explicit written permission.
- 5) The Font Software, modified or unmodified, in part or in whole, must be distributed entirely under this license, and must not be distributed under any other license. The requirement for fonts to remain under this license does not apply to any document created using the Font Software.

TERMINATION

This license becomes null and void if any of the above conditions are not met.

DISCLAIMER

THE FONT SOFTWARE IS PROVIDED "AS IS", WITHOUT WARRANTY OF ANY KIND, EXPRESS OR IMPLIED, INCLUDING BUT NOT LIMITED TO ANY WARRANTIES OF MERCHANTABILITY, FITNESS FOR A PARTICULAR PURPOSE AND NONINFRINGEMENT OF COPYRIGHT, PATENT, TRADEMARK, OR OTHER RIGHT. IN NO EVENT SHALL THE COPYRIGHT HOLDER BE LIABLE FOR ANY CLAIM, DAMAGES OR OTHER LIABILITY, INCLUDING ANY GENERAL, SPECIAL, INDIRECT, INCIDENTAL, OR CONSEQUENTIAL DAMAGES, WHETHER IN AN ACTION OF CONTRACT, TORT OR OTHERWISE, ARISING FROM, OUT OF THE USE OR INABILITY TO USE THE FONT SOFTWARE OR FROM OTHER DEALINGS IN THE FONT SOFTWARE.

Third-Party Services

If you use third-party services through the PRODUCT, use of the services are subjected the conditions below. When you access and/or obtain some third party content (such as text, images, videos, audios, or software) through the SOFTWARE, except as expressly permitted by the content owner or by applicable law, you may not (a) scrape, build databases or otherwise create permanent copies of such content, or keep cached copies longer than permitted by the cache header; (b) copy, translate, modify, create a derivative work of, sell, lease, lend, convey, distribute, publicly display or sublicense to any third party; (c) misrepresent the source or ownership; and (d) remove, obscure, or alter any copyright, trademark or other proprietary rights notices, falsify or delete any author attributions, legal notices or other labels of the origin or source of material.

The Software Subjected to the Other License Conditions

Please refer to Table of Software and respective License terms below, for more detail and corresponding license conditions.

Table of Software

Names of Software	Terms and Conditions of the License: See Page
Adobe PostScript 3	4
HttpClient2.0 Alpha1 Release	11
Crypto API	13
expat	14
J2ME	15
libjingle	16
MD4	17
NET-SNMP	18
OpenSSL	25
OSGi Release 4.2	29
servlet.jar	35

If you need source code of the following Software, please send email with the following information in English or Japanese at: <oipossg@canon.co.jp>

-Name of the model that you purchased.

-Product ID number labeled on the back of the main unit.

Please refer to Table of Software and respective License terms below, for more detail and corresponding license conditions

Table of Software

Names of Software	Terms and Conditions of the License: See page
Linux	38
glibc	45
json-glib	
glib	54

Adobe PostScript 3

Copyright 2007-2008 Adobe Systems Incorporated and its licensors. All rights reserved.

Portions include software under the following terms:

This product contains either BSAFE and/or TIPEM software by RSA Security Inc.

Portions of Pool.c_Copyright 1987 - NeXT, Inc., and portions of Graphics.c_Copyright 1988 NeXT, Inc. as an unpublished work. All Rights Reserved.

The Apache Software License, Version 1.1

This product includes software developed by the Apache Software Foundation (<http://www.apache.org/>).

Portions Copyright (c) 1998-2000 The Apache Software Foundation. All rights reserved.

Redistribution and use in source and binary forms, with or without modification, are permitted provided that the following conditions are met:

1. Redistributions of source code must retain the above copyright notice, this list of conditions and the following disclaimer.
2. Redistributions in binary form must reproduce the above copyright notice, this list of conditions and the following disclaimer in the documentation and/or other materials provided with the distribution.
3. The end-user documentation included with the redistribution, if any, must include the following acknowledgment:

"This product includes software developed by the Apache Software Foundation (<http://www.apache.org/>)."

Alternately, this acknowledgment may appear in the software itself, if and wherever such third-party acknowledgments normally appear.

4. The names "Xerces" and "Apache Software Foundation" must not be used to endorse or promote products derived from this software without prior written permission. For written permission, please contact apache@apache.org.
5. Products derived from this software may not be called "Apache", nor may "Apache" appear in their name, without prior written permission of the Apache Software Foundation.

THIS SOFTWARE IS PROVIDED ``AS IS" AND ANY EXPRESSED OR IMPLIED WARRANTIES, INCLUDING, BUT NOT LIMITED TO, THE IMPLIED WARRANTIES OF MERCHANTABILITY AND FITNESS FOR A PARTICULAR PURPOSE ARE DISCLAIMED. IN NO EVENT SHALL THE APACHE SOFTWARE FOUNDATION OR ITS CONTRIBUTORS BE LIABLE FOR ANY DIRECT, INDIRECT, INCIDENTAL, SPECIAL, EXEMPLARY, OR CONSEQUENTIAL DAMAGES (INCLUDING, BUT NOT LIMITED TO,

PROCUREMENT OF SUBSTITUTE GOODS OR SERVICES; LOSS OF USE, DATA, OR PROFITS; OR BUSINESS INTERRUPTION) HOWEVER CAUSED AND ON ANY THEORY OF LIABILITY, WHETHER IN CONTRACT, STRICT LIABILITY, OR TORT (INCLUDING NEGLIGENCE OR OTHERWISE) ARISING IN ANY WAY OUT OF THE USE OF THIS SOFTWARE, EVEN IF ADVISED OF THE POSSIBILITY OF SUCH DAMAGE.

This software consists of voluntary contributions made by many individuals on behalf of the Apache Software Foundation and was originally based on software copyright (c) 1999, International Business Machines, Inc., <http://www.ibm.com>. For more information on the Apache Software Foundation, please see <http://www.apache.org/>.

This product includes software developed by the University of California, Berkeley and its contributors. Portions Copyright (c) 1990 The Regents of the University of California. All rights reserved.

Redistribution and use in source and binary forms, with or without modification, are permitted provided that the following conditions are met:

1. Redistributions of source code must retain the above copyright notice, this list of conditions and the following disclaimer.
2. Redistributions in binary form must reproduce the above copyright notice, this list of conditions and the following disclaimer in the documentation and/or other materials provided with the distribution.
3. All advertising materials mentioning features or use of this software must display the following acknowledgement:

This product includes software developed by the University of California, Berkeley and its contributors.

4. Neither the name of the University nor the names of its contributors may be used to endorse or promote products derived from this software without specific prior written permission.

THIS SOFTWARE IS PROVIDED BY THE REGENTS AND CONTRIBUTORS "AS IS" AND ANY EXPRESS OR IMPLIED WARRANTIES, INCLUDING, BUT NOT LIMITED TO, THE IMPLIED WARRANTIES OF MERCHANTABILITY AND FITNESS FOR A PARTICULAR PURPOSE ARE DISCLAIMED. IN NO EVENT SHALL THE REGENTS OR CONTRIBUTORS BE LIABLE FOR ANY DIRECT, INDIRECT, INCIDENTAL, SPECIAL, EXEMPLARY, OR CONSEQUENTIAL DAMAGES (INCLUDING, BUT NOT LIMITED TO, PROCUREMENT OF SUBSTITUTE GOODS OR SERVICES; LOSS OF USE, DATA, OR PROFITS; OR BUSINESS INTERRUPTION) HOWEVER CAUSED AND ON ANY THEORY OF LIABILITY, WHETHER IN CONTRACT, STRICT LIABILITY, OR TORT (INCLUDING NEGLIGENCE OR OTHERWISE) ARISING IN ANY WAY OUT OF THE USE OF THIS SOFTWARE, EVEN IF ADVISED OF THE POSSIBILITY OF SUCH DAMAGE.

Portions Copyright (c) 1985, 1986 The Regents of the University of California. All rights reserved.

This code is derived from software contributed to Berkeley by James A. Woods, derived from original work by Spencer Thomas and Joseph Orost.

Redistribution and use in source and binary forms are permitted provided that the above copyright notice and this paragraph are duplicated in all such forms and that any documentation, advertising materials, and other materials related to such distribution and use acknowledge that the software was developed by the University of California, Berkeley. The name of the University may not be used to endorse or promote products derived from this software without specific prior written permission.

THIS SOFTWARE IS PROVIDED ``AS IS" AND WITHOUT ANY EXPRESS OR IMPLIED WARRANTIES, INCLUDING, WITHOUT LIMITATION, THE IMPLIED WARRANTIES OF MERCHANTABILITY AND FITNESS FOR A PARTICULAR PURPOSE.

Portions Copyright (c) 1993 X Consortium

Permission is hereby granted, free of charge, to any person obtaining a copy of this software and associated documentation files (the "Software"), to deal in the Software without restriction, including without limitation the rights to use, copy, modify, merge, publish, distribute, sublicense, and/or sell copies of the Software, and to permit persons to whom the Software is furnished to do so, subject to the following conditions:

The above copyright notice and this permission notice shall be included in all copies or substantial portions of the Software.

THE SOFTWARE IS PROVIDED "AS IS", WITHOUT WARRANTY OF ANY KIND, EXPRESS OR IMPLIED, INCLUDING BUT NOT LIMITED TO THE WARRANTIES OF MERCHANTABILITY, FITNESS FOR A PARTICULAR PURPOSE AND NONINFRINGEMENT. IN NO EVENT SHALL THE X CONSORTIUM BE LIABLE FOR ANY CLAIM, DAMAGES OR OTHER LIABILITY, WHETHER IN AN ACTION OF CONTRACT, TORT OR OTHERWISE, ARISING FROM, OUT OF OR IN CONNECTION WITH THE SOFTWARE OR THE USE OR OTHER DEALINGS IN THE SOFTWARE.

Except as contained in this notice, the name of the X Consortium shall not be used in advertising or otherwise to promote the sale, use or other dealings in this Software without prior written authorization from the X Consortium.

NOTICE REGARDING SABLOTRON

March 27, 2003

Portions of this product are based on Modifications created from the Original Code known as the "Sablotron XSLT Processor". The Sablotron XSLT Processor is subject to the Mozilla Public License Version 1.1 (the "License"). You may obtain a copy of the License at <http://www.mozilla.org/MPL/>

Software distributed under the License is distributed on an "AS IS" basis, WITHOUT WARRANTY OF ANY KIND, either express or implied. See the License for the specific language governing rights and limitations under the License.

The Original Code is the Sablotron XSLT Processor.

The Initial Developer of the Original Code is Ginger Alliance Ltd. Portions created by Ginger Alliance are Copyright (C) 2000 Ginger Alliance Ltd. All Rights Reserved.

Pursuant to sections 3.2 and 3.6 of the License, the Modifications created by Adobe Systems Incorporated are available as Source Code. The Modifications may be downloaded via the Internet from:

<http://partners.adobe.com/asn/tech/xml/sablotron/index.jsp>

The Original Code may be downloaded via the Internet from:

<https://sourceforge.net/projects/sablotron/>

This product includes software developed by the University of California, Berkeley and its contributors. Portions Copyright (c) 1982, 1986, 1987, 1988, 1989, 1990, 1991, 1992, 1993, 1994 The Regents of the University of California. All rights reserved.

Redistribution and use in source and binary forms, with or without modification, are permitted provided that the following conditions are met:

1. Redistributions of source code must retain the above copyright notice, this list of conditions and the following disclaimer.
2. Redistributions in binary form must reproduce the above copyright notice, this list of conditions and the following disclaimer in the documentation and/or other materials provided with the distribution.
3. All advertising materials mentioning features or use of this software must display the following acknowledgement: This product includes software developed by the University of California, Berkeley and its contributors.
4. Neither the name of the University nor the names of its contributors may be used to endorse or promote

products derived from this software without specific prior written permission.

THIS SOFTWARE IS PROVIDED BY THE REGENTS AND CONTRIBUTORS "AS IS" AND ANY EXPRESS OR IMPLIED WARRANTIES, INCLUDING, BUT NOT LIMITED TO, THE IMPLIED WARRANTIES OF MERCHANTABILITY AND FITNESS FOR A PARTICULAR PURPOSE ARE DISCLAIMED. IN NO EVENT SHALL THE REGENTS OR CONTRIBUTORS BE LIABLE FOR ANY DIRECT, INDIRECT, INCIDENTAL, SPECIAL, EXEMPLARY, OR CONSEQUENTIAL DAMAGES (INCLUDING, BUT NOT LIMITED TO, PROCUREMENT OF SUBSTITUTE GOODS OR SERVICES; LOSS OF USE, DATA, OR PROFITS; OR BUSINESS INTERRUPTION) HOWEVER CAUSED AND ON ANY THEORY OF LIABILITY, WHETHER IN CONTRACT, STRICT LIABILITY, OR TORT (INCLUDING NEGLIGENCE OR OTHERWISE) ARISING IN ANY WAY OUT OF THE USE OF THIS SOFTWARE, EVEN IF ADVISED OF THE POSSIBILITY OF SUCH DAMAGE.

Portions Copyright (c) 2001 by Andrei Alexandrescu. This code accompanies the book:

Alexandrescu, Andrei. "Modern C++ Design: Generic Programming and Design Patterns Applied". Copyright (c) 2001. Addison-Wesley.

Permission to use, copy, modify, distribute and sell this software for any purpose is hereby granted without fee, provided that the above copyright notice appear in all copies and that both that copyright notice and this permission notice appear in supporting documentation. The author or Addison-Wesley Longman make no representations about the suitability of this software for any purpose. It is provided "as is" without express or implied warranty.

Portions developed by the University of California, Berkeley.

Portions Copyright © 1991-2005 Unicode, Inc. All rights reserved. Distributed under the Terms of Use in <http://www.unicode.org/copyright.html>.

Permission is hereby granted, free of charge, to any person obtaining a copy of the Unicode data files and associated documentation (the "Data Files") or Unicode software and associated documentation (the "Software") to deal in the Data Files or Software without restriction, including without limitation the rights to use, copy, modify, merge, publish, distribute, and/or sell copies of the Data Files or Software, and to permit persons to whom the Data Files or Software are furnished to do so, provided that (a) the above copyright notice(s) and this permission notice appear in all copies of the Data Files or Software, (b) both the above copyright notice(s) and this permission notice appear in associated documentation, and (c) there is clear notice in each modified Data File or in the Software as well as in the documentation associated with the Data File(s) or Software that the data or software has been modified.

THE DATA FILES AND SOFTWARE ARE PROVIDED "AS IS", WITHOUT WARRANTY OF ANY KIND,

EXPRESS OR IMPLIED, INCLUDING BUT NOT LIMITED TO THE WARRANTIES OF MERCHANTABILITY, FITNESS FOR A PARTICULAR PURPOSE AND NONINFRINGEMENT OF THIRD PARTY RIGHTS. IN NO EVENT SHALL THE COPYRIGHT HOLDER OR HOLDERS INCLUDED IN THIS NOTICE BE LIABLE FOR ANY CLAIM, OR ANY SPECIAL INDIRECT OR CONSEQUENTIAL DAMAGES, OR ANY DAMAGES WHATSOEVER RESULTING FROM LOSS OF USE, DATA OR PROFITS, WHETHER IN AN ACTION OF CONTRACT, NEGLIGENCE OR OTHER TORTIOUS ACTION, ARISING OUT OF OR IN CONNECTION WITH THE USE OR PERFORMANCE OF THE DATA FILES OR SOFTWARE.

Except as contained in this notice, the name of a copyright holder shall not be used in advertising or otherwise to promote the sale, use or other dealings in these Data Files or Software without prior written authorization of the copyright holder.

Unicode and the Unicode logo are trademarks of Unicode, Inc., and may be registered in some jurisdictions. All other trademarks and registered trademarks mentioned herein are the property of their respective owners.

Adobe shall retain and reproduce, and require its Sublicensees to retain and reproduce JIM's following copyright notice within each copy of the licensed programs in any form, in whole or in part: "© 1981, 1990 JMI Consultants, Inc. All rights reserved."

This product includes software developed by the University of California, Berkeley and its contributors. Portions Copyright (c) 1990, 1993 The Regents of the University of California. All rights reserved.

This code is derived from software contributed to Berkeley by Chris Torek.

Redistribution and use in source and binary forms, with or without modification, are permitted provided that the following conditions are met:

1. Redistributions of source code must retain the above copyright notice, this list of conditions and the following disclaimer.
2. Redistributions in binary form must reproduce the above copyright notice, this list of conditions and the following disclaimer in the documentation and/or other materials provided with the distribution.
3. All advertising materials mentioning features or use of this software must display the following acknowledgement:

This product includes software developed by the University of California, Berkeley and its contributors.

4. Neither the name of the University nor the names of its contributors may be used to endorse or promote products derived from this software without specific prior written permission.

THIS SOFTWARE IS PROVIDED BY THE REGENTS AND CONTRIBUTORS "AS IS" AND ANY EXPRESS

OR IMPLIED WARRANTIES, INCLUDING, BUT NOT LIMITED TO, THE IMPLIED WARRANTIES OF MERCHANTABILITY AND FITNESS FOR A PARTICULAR PURPOSE ARE DISCLAIMED. IN NO EVENT SHALL THE REGENTS OR CONTRIBUTORS BE LIABLE FOR ANY DIRECT, INDIRECT, INCIDENTAL, SPECIAL, EXEMPLARY, OR CONSEQUENTIAL DAMAGES (INCLUDING, BUT NOT LIMITED TO, PROCUREMENT OF SUBSTITUTE GOODS OR SERVICES; LOSS OF USE, DATA, OR PROFITS; OR BUSINESS INTERRUPTION) HOWEVER CAUSED AND ON ANY THEORY OF LIABILITY, WHETHER IN CONTRACT, STRICT LIABILITY, OR TORT (INCLUDING NEGLIGENCE OR OTHERWISE) ARISING IN ANY WAY OUT OF THE USE OF THIS SOFTWARE, EVEN IF ADVISED OF THE POSSIBILITY OF SUCH DAMAGE.

The Loki Library

Portions Copyright (c) 2001 by Andrei Alexandrescu // This code accompanies the book: Alexandrescu, Andrei. "Modern C++ Design: Generic Programming and Design Patterns Applied". Copyright (c) 2001. Addison-Wesley.

Permission to use, copy, modify, distribute and sell this software for any purpose is hereby granted without fee, provided that the above copyright notice appear in all copies and that both that copyright notice and this permission notice appear in supporting documentation. The author or Addison-Wesley Longman make no representations about the suitability of this software for any purpose. It is provided "as is" without express or implied warranty.

Updated Information/Additional Third Party Code Information available at <http://www.adobe.com/go/thirdparty> .

HttpClient2.0 Alpha1 Release

This product includes software developed by the Apache Software Foundation (<http://www.apache.org/>) and is subject to the following terms and conditions.

Copyright (c) 2001 The Apache Software Foundation. All rights reserved.

Redistribution and use in source and binary forms, with or without modification, are permitted provided that the following conditions are met:

1. Redistributions of source code must retain the above copyright notice, this list of conditions and the following disclaimer.
2. Redistributions in binary form must reproduce the above copyright notice, this list of conditions and the following disclaimer in the documentation and/or other materials provided with the distribution.
3. The end-user documentation included with the redistribution, if any, must include the following acknowledgement:

"This product includes software developed by the Apache Software Foundation (<http://www.apache.org/>)."

Alternately, this acknowledgement may appear in the software itself, if and wherever such third-party acknowledgements normally appear.

4. The names "The Jakarta Project", "Commons", "Xerces", "Crimson", "Velocity", and "Apache Software Foundation" must not be used to endorse or promote products derived from this software without prior written permission. For written permission, please contact apache@apache.org.
5. Products derived from this software may not be called "Jakarta", "Commons", "Xerces", "Crimson", "Velocity", or "Apache", nor may "Jakarta", "Commons", "Xerces", "Crimson", "Velocity", or "Apache" appear in their names without prior written permission of the Apache Group.

NO WARRANTY

THIS SOFTWARE IS PROVIDED "AS IS" AND ANY EXPRESSED OR IMPLIED WARRANTIES, INCLUDING, BUT NOT LIMITED TO, THE IMPLIED WARRANTIES OF MERCHANTABILITY AND FITNESS FOR A PARTICULAR PURPOSE ARE DISCLAIMED. IN NO EVENT SHALL THE APACHE SOFTWARE FOUNDATION OR ITS CONTRIBUTORS BE LIABLE FOR ANY DIRECT, INDIRECT, INCIDENTAL, SPECIAL, EXEMPLARY, OR CONSEQUENTIAL DAMAGES (INCLUDING, BUT NOT LIMITED TO, PROCUREMENT OF SUBSTITUTE GOODS OR SERVICES; LOSS OF USE, DATA, OR PROFITS; OR BUSINESS INTERRUPTION) HOWEVER CAUSED AND ON ANY THEORY OF LIABILITY, WHETHER IN CONTRACT, STRICT LIABILITY, OR TORT (INCLUDING NEGLIGENCE OR OTHERWISE) ARISING IN ANY WAY OUT OF THE USE OF THIS SOFTWARE, EVEN IF ADVISED OF THE POSSIBILITY OF SUCH DAMAGE.

This software consists of voluntary contributions made by many individuals on behalf of the Apache Software Foundation. For more information on the Apache Software Foundation, please see <http://www.apache.org/>.

Crypto API

COPYRIGHT INFORMATION

Copyright (c) 2000 The Legion Of The Bouncy Castle (<http://www.bouncycastle.org>)

Permission is hereby granted, free of charge, to any person obtaining a copy of this software and associated documentation files (the "Software"), to deal in the Software without restriction, including without limitation the rights to use, copy, modify, merge, publish, distribute, sublicense, and/or sell copies of the Software, and to permit persons to whom the Software is furnished to do so, subject to the following conditions:

The above copyright notice and this permission notice shall be included in all copies or substantial portions of the Software.

THE SOFTWARE IS PROVIDED "AS IS", WITHOUT WARRANTY OF ANY KIND, EXPRESS OR IMPLIED, INCLUDING BUT NOT LIMITED TO THE WARRANTIES OF MERCHANTABILITY, FITNESS FOR A PARTICULAR PURPOSE AND NONINFRINGEMENT. IN NO EVENT SHALL THE AUTHORS OR COPYRIGHT HOLDERS BE LIABLE FOR ANY CLAIM, DAMAGES OR OTHER LIABILITY, WHETHER IN AN ACTION OF CONTRACT, TORT OR OTHERWISE, ARISING FROM, OUT OF OR IN CONNECTION WITH THE SOFTWARE OR THE USE OR OTHER DEALINGS IN THE SOFTWARE.

expat

Copyright (c) 1998, 1999, 2000 Thai Open Source Software Center Ltd
and Clark Cooper

Copyright (c) 2001, 2002, 2003, 2004, 2005, 2006 Expat maintainers.

Permission is hereby granted, free of charge, to any person obtaining a copy of this software and associated documentation files (the "Software"), to deal in the Software without restriction, including without limitation the rights to use, copy, modify, merge, publish, distribute, sublicense, and/or sell copies of the Software, and to permit persons to whom the Software is furnished to do so, subject to the following conditions:

The above copyright notice and this permission notice shall be included in all copies or substantial portions of the Software.

THE SOFTWARE IS PROVIDED "AS IS", WITHOUT WARRANTY OF ANY KIND, EXPRESS OR IMPLIED, INCLUDING BUT NOT LIMITED TO THE WARRANTIES OF MERCHANTABILITY, FITNESS FOR A PARTICULAR PURPOSE AND NONINFRINGEMENT. IN NO EVENT SHALL THE AUTHORS OR COPYRIGHT HOLDERS BE LIABLE FOR ANY CLAIM, DAMAGES OR OTHER LIABILITY, WHETHER IN AN ACTION OF CONTRACT, TORT OR OTHERWISE, ARISING FROM, OUT OF OR IN CONNECTION WITH THE SOFTWARE OR THE USE OR OTHER DEALINGS IN THE SOFTWARE.

J2ME

Software is a “commercial item,” as that term is defined in 48 C.F.R. 2.101 (Oct. 1995), consisting of “commercial computer software” and “commercial computer software documentation,” as such terms are used in 48 C.F.R. 12.212 (Sept. 1995).

Consistent with 48 C.F.R. 12.212 and 48 C.F.R. 227.7202-1 through 227.7202-4 (June 1995), all U.S. Government End Users acquire Software with only those rights set forth herein.

libjingle

Copyright 2004--2007, Google Inc.

Redistribution and use in source and binary forms, with or without modification, are permitted provided that the following conditions are met:

1. Redistributions of source code must retain the above copyright notice, this list of conditions and the following disclaimer.
2. Redistributions in binary form must reproduce the above copyright notice, this list of conditions and the following disclaimer in the documentation and/or other materials provided with the distribution.
3. The name of the author may not be used to endorse or promote products derived from this software without specific prior written permission.

THIS SOFTWARE IS PROVIDED BY THE AUTHOR "AS IS" AND ANY EXPRESS OR IMPLIED WARRANTIES, INCLUDING, BUT NOT LIMITED TO, THE IMPLIED WARRANTIES OF MERCHANTABILITY AND FITNESS FOR A PARTICULAR PURPOSE ARE DISCLAIMED. IN NO EVENT SHALL THE AUTHOR BE LIABLE FOR ANY DIRECT, INDIRECT, INCIDENTAL, SPECIAL, EXEMPLARY, OR CONSEQUENTIAL DAMAGES (INCLUDING, BUT NOT LIMITED TO, PROCUREMENT OF SUBSTITUTE GOODS OR SERVICES; LOSS OF USE, DATA, OR PROFITS; OR BUSINESS INTERRUPTION) HOWEVER CAUSED AND ON ANY THEORY OF LIABILITY, WHETHER IN CONTRACT, STRICT LIABILITY, OR TORT (INCLUDING NEGLIGENCE OR OTHERWISE) ARISING IN ANY WAY OUT OF THE USE OF THIS SOFTWARE, EVEN IF ADVISED OF THE POSSIBILITY OF SUCH DAMAGE.

MD4

"RSA Data Security, Inc. MD4 Message-Digest Algorithm"

NET-SNMP

Various copyrights apply to this package, listed in various separate parts below. Please make sure that you read all the parts. Up until 2001, the project was based at UC Davis, and the first part covers all code written during this time. From 2001 onwards, the project has been based at SourceForge, and Networks Associates Technology, Inc hold the copyright on behalf of the wider Net-SNMP community, covering all derivative work done since then. An additional copyright section has been added as Part 3 below also under a BSD license for the work contributed by Cambridge Broadband Ltd. to the project since 2001. An additional copyright section has been added as Part 4 below also under a BSD license for the work contributed by Sun Microsystems, Inc. to the project since 2003.

Code has been contributed to this project by many people over the years it has been in development, and a full list of contributors can be found in the README file under the THANKS section.

---- Part 1: CMU/UCD copyright notice: (BSD like) ----

Copyright 1989, 1991, 1992 by Carnegie Mellon University

Derivative Work - 1996, 1998-2000

Copyright 1996, 1998-2000 The Regents of the University of California

All Rights Reserved

Permission to use, copy, modify and distribute this software and its documentation for any purpose and without fee is hereby granted, provided that the above copyright notice appears in all copies and that both that copyright notice and this permission notice appear in supporting documentation, and that the name of CMU and The Regents of the University of California not be used in advertising or publicity pertaining to distribution of the software without specific written permission.

CMU AND THE REGENTS OF THE UNIVERSITY OF CALIFORNIA DISCLAIM ALL WARRANTIES WITH REGARD TO THIS SOFTWARE, INCLUDING ALL IMPLIED WARRANTIES OF MERCHANTABILITY AND FITNESS. IN NO EVENT SHALL CMU OR THE REGENTS OF THE UNIVERSITY OF CALIFORNIA BE LIABLE FOR ANY SPECIAL, INDIRECT OR CONSEQUENTIAL DAMAGES OR ANY DAMAGES WHATSOEVER RESULTING FROM THE LOSS OF USE, DATA OR PROFITS, WHETHER IN AN ACTION OF CONTRACT, NEGLIGENCE OR OTHER TORTIOUS ACTION, ARISING OUT OF OR IN CONNECTION WITH THE USE OR PERFORMANCE OF THIS SOFTWARE.

---- Part 2: Networks Associates Technology, Inc copyright notice (BSD) ----

Copyright (c) 2001-2003, Networks Associates Technology, Inc
All rights reserved.

Redistribution and use in source and binary forms, with or without modification, are permitted provided that the following conditions are met:

- * Redistributions of source code must retain the above copyright notice, this list of conditions and the following disclaimer.
- * Redistributions in binary form must reproduce the above copyright notice, this list of conditions and the following disclaimer in the documentation and/or other materials provided with the distribution.
- * Neither the name of the Networks Associates Technology, Inc nor the names of its contributors may be used to endorse or promote products derived from this software without specific prior written permission.

THIS SOFTWARE IS PROVIDED BY THE COPYRIGHT HOLDERS AND CONTRIBUTORS "AS IS" AND ANY EXPRESS OR IMPLIED WARRANTIES, INCLUDING, BUT NOT LIMITED TO, THE IMPLIED WARRANTIES OF MERCHANTABILITY AND FITNESS FOR A PARTICULAR PURPOSE ARE DISCLAIMED. IN NO EVENT SHALL THE COPYRIGHT HOLDERS OR CONTRIBUTORS BE LIABLE FOR ANY DIRECT, INDIRECT, INCIDENTAL, SPECIAL, EXEMPLARY, OR CONSEQUENTIAL DAMAGES (INCLUDING, BUT NOT LIMITED TO, PROCUREMENT OF SUBSTITUTE GOODS OR SERVICES; LOSS OF USE, DATA, OR PROFITS;

OR BUSINESS INTERRUPTION) HOWEVER CAUSED AND ON ANY THEORY OF LIABILITY, WHETHER IN CONTRACT, STRICT LIABILITY, OR TORT (INCLUDING NEGLIGENCE OR OTHERWISE) ARISING IN ANY WAY OUT OF THE USE OF THIS SOFTWARE, EVEN IF ADVISED OF THE POSSIBILITY OF SUCH DAMAGE.

---- Part 3: Cambridge Broadband Ltd. copyright notice (BSD) -----

Portions of this code are copyright (c) 2001-2003, Cambridge Broadband Ltd.
All rights reserved.

Redistribution and use in source and binary forms, with or without modification, are permitted provided that the following conditions are met:

- * Redistributions of source code must retain the above copyright notice, this list of conditions and the following disclaimer.
- * Redistributions in binary form must reproduce the above copyright notice, this list of conditions and the following disclaimer in the documentation and/or other materials provided with the distribution.
- * The name of Cambridge Broadband Ltd. may not be used to endorse or promote products derived from this software without specific prior written permission.

THIS SOFTWARE IS PROVIDED BY THE COPYRIGHT HOLDER ``AS IS" AND ANY EXPRESS OR IMPLIED WARRANTIES, INCLUDING, BUT NOT LIMITED TO, THE IMPLIED WARRANTIES OF MERCHANTABILITY AND FITNESS FOR A PARTICULAR PURPOSE ARE DISCLAIMED. IN NO EVENT SHALL THE COPYRIGHT HOLDER BE LIABLE FOR ANY DIRECT, INDIRECT, INCIDENTAL, SPECIAL, EXEMPLARY, OR CONSEQUENTIAL DAMAGES (INCLUDING, BUT NOT LIMITED TO, PROCUREMENT OF SUBSTITUTE GOODS OR SERVICES; LOSS OF USE, DATA, OR PROFITS; OR BUSINESS INTERRUPTION) HOWEVER CAUSED AND ON ANY THEORY OF LIABILITY, WHETHER IN CONTRACT, STRICT LIABILITY, OR TORT (INCLUDING NEGLIGENCE OR OTHERWISE) ARISING IN ANY WAY OUT OF THE USE OF THIS SOFTWARE, EVEN IF ADVISED OF THE POSSIBILITY OF SUCH DAMAGE.

---- Part 4: Sun Microsystems, Inc. copyright notice (BSD) -----

Copyright © 2003 Sun Microsystems, Inc., 4150 Network Circle, Santa Clara, California 95054, U.S.A. All rights reserved.

Use is subject to license terms below.

This distribution may include materials developed by third parties.

Sun, Sun Microsystems, the Sun logo and Solaris are trademarks or registered trademarks of Sun Microsystems, Inc. in the U.S. and other countries.

Redistribution and use in source and binary forms, with or without modification, are permitted provided that the following conditions are met:

- * Redistributions of source code must retain the above copyright notice, this list of conditions and the following disclaimer.
- * Redistributions in binary form must reproduce the above copyright notice, this list of conditions and the following disclaimer in the documentation and/or other materials provided with the distribution.
- * Neither the name of the Sun Microsystems, Inc. nor the names of its contributors may be used to endorse or promote products derived from this software without specific prior written permission.

THIS SOFTWARE IS PROVIDED BY THE COPYRIGHT HOLDERS AND CONTRIBUTORS "AS IS" AND ANY EXPRESS OR IMPLIED WARRANTIES, INCLUDING, BUT NOT LIMITED TO, THE IMPLIED WARRANTIES OF MERCHANTABILITY AND FITNESS FOR A PARTICULAR PURPOSE ARE DISCLAIMED. IN NO EVENT SHALL THE COPYRIGHT HOLDERS OR CONTRIBUTORS BE LIABLE FOR ANY DIRECT, INDIRECT, INCIDENTAL, SPECIAL, EXEMPLARY, OR CONSEQUENTIAL DAMAGES (INCLUDING, BUT NOT LIMITED TO, PROCUREMENT OF SUBSTITUTE GOODS OR SERVICES; LOSS OF USE, DATA, OR PROFITS; OR BUSINESS INTERRUPTION) HOWEVER CAUSED AND ON ANY THEORY OF LIABILITY, WHETHER IN CONTRACT, STRICT LIABILITY, OR TORT (INCLUDING NEGLIGENCE OR OTHERWISE) ARISING IN ANY WAY OUT OF THE USE OF THIS SOFTWARE, EVEN IF ADVISED OF THE POSSIBILITY OF SUCH DAMAGE.

---- Part 5: Sparta, Inc copyright notice (BSD) ----

Copyright (c) 2003-2005, Sparta, Inc

All rights reserved.

Redistribution and use in source and binary forms, with or without modification, are permitted provided that the following conditions are met:

- * Redistributions of source code must retain the above copyright notice, this list of conditions and the following disclaimer.
- * Redistributions in binary form must reproduce the above copyright notice, this list of conditions and the following disclaimer in the documentation and/or other materials provided with the distribution.
- * Neither the name of Sparta, Inc nor the names of its contributors may be used to endorse or promote products derived from this software without specific prior written permission.

THIS SOFTWARE IS PROVIDED BY THE COPYRIGHT HOLDERS AND CONTRIBUTORS "AS IS" AND ANY EXPRESS OR IMPLIED WARRANTIES, INCLUDING, BUT NOT LIMITED TO, THE IMPLIED WARRANTIES OF MERCHANTABILITY AND FITNESS FOR A PARTICULAR PURPOSE ARE DISCLAIMED. IN NO EVENT SHALL THE COPYRIGHT HOLDERS OR CONTRIBUTORS BE LIABLE FOR ANY DIRECT, INDIRECT, INCIDENTAL, SPECIAL, EXEMPLARY, OR CONSEQUENTIAL DAMAGES (INCLUDING, BUT NOT LIMITED TO, PROCUREMENT OF SUBSTITUTE GOODS OR SERVICES; LOSS OF USE, DATA, OR PROFITS; OR BUSINESS INTERRUPTION) HOWEVER CAUSED AND ON ANY THEORY OF LIABILITY, WHETHER IN CONTRACT, STRICT LIABILITY, OR TORT (INCLUDING NEGLIGENCE OR OTHERWISE) ARISING IN ANY WAY OUT OF THE USE OF THIS SOFTWARE, EVEN IF ADVISED OF THE POSSIBILITY OF SUCH DAMAGE.

---- Part 6: Cisco/BUPTNIC copyright notice (BSD) ----

Copyright (c) 2004, Cisco, Inc and Information Network

Center of Beijing University of Posts and Telecommunications.

All rights reserved.

Redistribution and use in source and binary forms, with or without

modification, are permitted provided that the following conditions are met:

- * Redistributions of source code must retain the above copyright notice, this list of conditions and the following disclaimer.
- * Redistributions in binary form must reproduce the above copyright notice, this list of conditions and the following disclaimer in the documentation and/or other materials provided with the distribution.
- * Neither the name of Cisco, Inc, Beijing University of Posts and Telecommunications, nor the names of their contributors may be used to endorse or promote products derived from this software without specific prior written permission.

THIS SOFTWARE IS PROVIDED BY THE COPYRIGHT HOLDERS AND CONTRIBUTORS "AS IS" AND ANY EXPRESS OR IMPLIED WARRANTIES, INCLUDING, BUT NOT LIMITED TO, THE IMPLIED WARRANTIES OF MERCHANTABILITY AND FITNESS FOR A PARTICULAR PURPOSE ARE DISCLAIMED. IN NO EVENT SHALL THE COPYRIGHT HOLDERS OR CONTRIBUTORS BE LIABLE FOR ANY DIRECT, INDIRECT, INCIDENTAL, SPECIAL, EXEMPLARY, OR CONSEQUENTIAL DAMAGES (INCLUDING, BUT NOT LIMITED TO, PROCUREMENT OF SUBSTITUTE GOODS OR SERVICES; LOSS OF USE, DATA, OR PROFITS; OR BUSINESS INTERRUPTION) HOWEVER CAUSED AND ON ANY THEORY OF LIABILITY, WHETHER IN CONTRACT, STRICT LIABILITY, OR TORT (INCLUDING NEGLIGENCE OR OTHERWISE) ARISING IN ANY WAY OUT OF THE USE OF THIS SOFTWARE, EVEN IF ADVISED OF THE POSSIBILITY OF SUCH DAMAGE.

---- Part 7: Fabasoft R&D Software GmbH & Co KG copyright notice (BSD) ----

Copyright (c) Fabasoft R&D Software GmbH & Co KG, 2003

oss@fabasoft.com

Author: Bernhard Penz <bernhard.penz@fabasoft.com>

Redistribution and use in source and binary forms, with or without modification, are permitted provided that the following conditions are met:

- * Redistributions of source code must retain the above copyright notice, this list of conditions and the following disclaimer.

- * Redistributions in binary form must reproduce the above copyright notice, this list of conditions and the following disclaimer in the documentation and/or other materials provided with the distribution.

- * The name of Fabasoft R&D Software GmbH & Co KG or any of its subsidiaries, brand or product names may not be used to endorse or promote products derived from this software without specific prior written permission.

THIS SOFTWARE IS PROVIDED BY THE COPYRIGHT HOLDER ``AS IS" AND ANY EXPRESS OR IMPLIED WARRANTIES, INCLUDING, BUT NOT LIMITED TO, THE IMPLIED WARRANTIES OF MERCHANTABILITY AND FITNESS FOR A PARTICULAR PURPOSE ARE DISCLAIMED. IN NO EVENT SHALL THE COPYRIGHT HOLDER BE LIABLE FOR ANY DIRECT, INDIRECT, INCIDENTAL, SPECIAL, EXEMPLARY, OR CONSEQUENTIAL DAMAGES (INCLUDING, BUT NOT LIMITED TO, PROCUREMENT OF SUBSTITUTE GOODS OR SERVICES; LOSS OF USE, DATA, OR PROFITS; OR BUSINESS INTERRUPTION) HOWEVER CAUSED AND ON ANY THEORY OF LIABILITY, WHETHER IN CONTRACT, STRICT LIABILITY, OR TORT (INCLUDING NEGLIGENCE OR OTHERWISE) ARISING IN ANY WAY OUT OF THE USE OF THIS SOFTWARE, EVEN IF ADVISED OF THE POSSIBILITY OF SUCH DAMAGE.

OpenSSL

OpenSSL License

/* =====

* Copyright (c) 1998-2011 The OpenSSL Project. All rights reserved.

*

* Redistribution and use in source and binary forms, with or without

* modification, are permitted provided that the following conditions

* are met:

*

* 1. Redistributions of source code must retain the above copyright

* notice, this list of conditions and the following disclaimer.

*

* 2. Redistributions in binary form must reproduce the above copyright

* notice, this list of conditions and the following disclaimer in

* the documentation and/or other materials provided with the

* distribution.

*

* 3. All advertising materials mentioning features or use of this

* software must display the following acknowledgment:

* "This product includes software developed by the OpenSSL Project

* for use in the OpenSSL Toolkit. (<http://www.openssl.org/>)"

*

* 4. The names "OpenSSL Toolkit" and "OpenSSL Project" must not be used to

* endorse or promote products derived from this software without

* prior written permission. For written permission, please contact

* openssl-core@openssl.org.

*

* 5. Products derived from this software may not be called "OpenSSL"

* nor may "OpenSSL" appear in their names without prior written

* permission of the OpenSSL Project.

*

* 6. Redistributions of any form whatsoever must retain the following

* acknowledgment:

* "This product includes software developed by the OpenSSL Project

* for use in the OpenSSL Toolkit (<http://www.openssl.org/>)"

*
* THIS SOFTWARE IS PROVIDED BY THE OpenSSL PROJECT ``AS IS" AND ANY
* EXPRESSED OR IMPLIED WARRANTIES, INCLUDING, BUT NOT LIMITED TO, THE
* IMPLIED WARRANTIES OF MERCHANTABILITY AND FITNESS FOR A PARTICULAR
* PURPOSE ARE DISCLAIMED. IN NO EVENT SHALL THE OpenSSL PROJECT OR
* ITS CONTRIBUTORS BE LIABLE FOR ANY DIRECT, INDIRECT, INCIDENTAL,
* SPECIAL, EXEMPLARY, OR CONSEQUENTIAL DAMAGES (INCLUDING, BUT
* NOT LIMITED TO, PROCUREMENT OF SUBSTITUTE GOODS OR SERVICES;
* LOSS OF USE, DATA, OR PROFITS; OR BUSINESS INTERRUPTION)
* HOWEVER CAUSED AND ON ANY THEORY OF LIABILITY, WHETHER IN CONTRACT,
* STRICT LIABILITY, OR TORT (INCLUDING NEGLIGENCE OR OTHERWISE)
* ARISING IN ANY WAY OUT OF THE USE OF THIS SOFTWARE, EVEN IF ADVISED
* OF THE POSSIBILITY OF SUCH DAMAGE.

* =====

*
* This product includes cryptographic software written by Eric Young
* (eay@cryptsoft.com). This product includes software written by Tim
* Hudson (tjh@cryptsoft.com).

*
*/

Original SSLeay License

/* Copyright (C) 1995-1998 Eric Young (eay@cryptsoft.com)

* All rights reserved.

*

* This package is an SSL implementation written

* by Eric Young (eay@cryptsoft.com).

* The implementation was written so as to conform with Netscapes SSL.

*

* This library is free for commercial and non-commercial use as long as

* the following conditions are aheared to. The following conditions

* apply to all code found in this distribution, be it the RC4, RSA,

* lhash, DES, etc., code; not just the SSL code. The SSL documentation

* included with this distribution is covered by the same copyright terms

* except that the holder is Tim Hudson (tjh@cryptsoft.com).

*

- * Copyright remains Eric Young's, and as such any Copyright notices in
- * the code are not to be removed.
- * If this package is used in a product, Eric Young should be given attribution
- * as the author of the parts of the library used.
- * This can be in the form of a textual message at program startup or
- * in documentation (online or textual) provided with the package.
- *
- * Redistribution and use in source and binary forms, with or without
- * modification, are permitted provided that the following conditions
- * are met:
- * 1. Redistributions of source code must retain the copyright
- * notice, this list of conditions and the following disclaimer.
- * 2. Redistributions in binary form must reproduce the above copyright
- * notice, this list of conditions and the following disclaimer in the
- * documentation and/or other materials provided with the distribution.
- * 3. All advertising materials mentioning features or use of this software
- * must display the following acknowledgement:
- * "This product includes cryptographic software written by
- * Eric Young (eay@cryptsoft.com)"
- * The word 'cryptographic' can be left out if the routines from the library
- * being used are not cryptographic related :-).
- * 4. If you include any Windows specific code (or a derivative thereof) from
- * the apps directory (application code) you must include an acknowledgement:
- * "This product includes software written by Tim Hudson (tjh@cryptsoft.com)"
- *
- * THIS SOFTWARE IS PROVIDED BY ERIC YOUNG ``AS IS" AND
- * ANY EXPRESS OR IMPLIED WARRANTIES, INCLUDING, BUT NOT LIMITED TO, THE
- * IMPLIED WARRANTIES OF MERCHANTABILITY AND FITNESS FOR A PARTICULAR PURPOSE
- * ARE DISCLAIMED. IN NO EVENT SHALL THE AUTHOR OR CONTRIBUTORS BE LIABLE
- * FOR ANY DIRECT, INDIRECT, INCIDENTAL, SPECIAL, EXEMPLARY, OR CONSEQUENTIAL
- * DAMAGES (INCLUDING, BUT NOT LIMITED TO, PROCUREMENT OF SUBSTITUTE GOODS
- * OR SERVICES; LOSS OF USE, DATA, OR PROFITS; OR BUSINESS INTERRUPTION)
- * HOWEVER CAUSED AND ON ANY THEORY OF LIABILITY, WHETHER IN CONTRACT, STRICT
- * LIABILITY, OR TORT (INCLUDING NEGLIGENCE OR OTHERWISE) ARISING IN ANY WAY
- * OUT OF THE USE OF THIS SOFTWARE, EVEN IF ADVISED OF THE POSSIBILITY OF
- * SUCH DAMAGE.
- *
- * The licence and distribution terms for any publically available version or

* derivative of this code cannot be changed. i.e. this code cannot simply be
* copied and put under another distribution licence
* [including the GNU Public Licence.]
*/

OSGi Release 4.2

Apache License

Version 2.0, January 2004

<http://www.apache.org/licenses/>

TERMS AND CONDITIONS FOR USE, REPRODUCTION, AND DISTRIBUTION

1. Definitions.

"License" shall mean the terms and conditions for use, reproduction, and distribution as defined by Sections 1 through 9 of this document.

"Licensor" shall mean the copyright owner or entity authorized by the copyright owner that is granting the License.

"Legal Entity" shall mean the union of the acting entity and all other entities that control, are controlled by, or are under common control with that entity. For the purposes of this definition, "control" means (i) the power, direct or indirect, to cause the direction or management of such entity, whether by contract or otherwise, or (ii) ownership of fifty percent (50%) or more of the outstanding shares, or (iii) beneficial ownership of such entity.

"You" (or "Your") shall mean an individual or Legal Entity exercising permissions granted by this License.

"Source" form shall mean the preferred form for making modifications, including but not limited to software source code, documentation source, and configuration files.

"Object" form shall mean any form resulting from mechanical transformation or translation of a Source form, including but not limited to compiled object code, generated documentation, and conversions to other media types.

"Work" shall mean the work of authorship, whether in Source or Object form, made available under the License, as indicated by a copyright notice that is included in or attached to the work

(an example is provided in the Appendix below).

"Derivative Works" shall mean any work, whether in Source or Object form, that is based on (or derived from) the Work and for which the editorial revisions, annotations, elaborations, or other modifications represent, as a whole, an original work of authorship. For the purposes of this License, Derivative Works shall not include works that remain separable from, or merely link (or bind by name) to the interfaces of, the Work and Derivative Works thereof.

"Contribution" shall mean any work of authorship, including the original version of the Work and any modifications or additions to that Work or Derivative Works thereof, that is intentionally submitted to Licensor for inclusion in the Work by the copyright owner or by an individual or Legal Entity authorized to submit on behalf of the copyright owner. For the purposes of this definition, "submitted" means any form of electronic, verbal, or written communication sent to the Licensor or its representatives, including but not limited to communication on electronic mailing lists, source code control systems, and issue tracking systems that are managed by, or on behalf of, the Licensor for the purpose of discussing and improving the Work, but excluding communication that is conspicuously marked or otherwise designated in writing by the copyright owner as "Not a Contribution."

"Contributor" shall mean Licensor and any individual or Legal Entity on behalf of whom a Contribution has been received by Licensor and subsequently incorporated within the Work.

2. Grant of Copyright License. Subject to the terms and conditions of this License, each Contributor hereby grants to You a perpetual, worldwide, non-exclusive, no-charge, royalty-free, irrevocable copyright license to reproduce, prepare Derivative Works of, publicly display, publicly perform, sublicense, and distribute the Work and such Derivative Works in Source or Object form.

3. Grant of Patent License. Subject to the terms and conditions of this License, each Contributor hereby grants to You a perpetual, worldwide, non-exclusive, no-charge, royalty-free, irrevocable

(except as stated in this section) patent license to make, have made, use, offer to sell, sell, import, and otherwise transfer the Work, where such license applies only to those patent claims licensable by such Contributor that are necessarily infringed by their Contribution(s) alone or by combination of their Contribution(s) with the Work to which such Contribution(s) was submitted. If You institute patent litigation against any entity (including a cross-claim or counterclaim in a lawsuit) alleging that the Work or a Contribution incorporated within the Work constitutes direct or contributory patent infringement, then any patent licenses granted to You under this License for that Work shall terminate as of the date such litigation is filed.

4. Redistribution. You may reproduce and distribute copies of the Work or Derivative Works thereof in any medium, with or without modifications, and in Source or Object form, provided that You meet the following conditions:

(a) You must give any other recipients of the Work or Derivative Works a copy of this License; and

(b) You must cause any modified files to carry prominent notices stating that You changed the files; and

(c) You must retain, in the Source form of any Derivative Works that You distribute, all copyright, patent, trademark, and attribution notices from the Source form of the Work, excluding those notices that do not pertain to any part of the Derivative Works; and

(d) If the Work includes a "NOTICE" text file as part of its distribution, then any Derivative Works that You distribute must include a readable copy of the attribution notices contained within such NOTICE file, excluding those notices that do not pertain to any part of the Derivative Works, in at least one of the following places: within a NOTICE text file distributed as part of the Derivative Works; within the Source form or documentation, if provided along with the Derivative Works; or,

within a display generated by the Derivative Works, if and wherever such third-party notices normally appear. The contents of the NOTICE file are for informational purposes only and do not modify the License. You may add Your own attribution notices within Derivative Works that You distribute, alongside or as an addendum to the NOTICE text from the Work, provided that such additional attribution notices cannot be construed as modifying the License.

You may add Your own copyright statement to Your modifications and may provide additional or different license terms and conditions for use, reproduction, or distribution of Your modifications, or for any such Derivative Works as a whole, provided Your use, reproduction, and distribution of the Work otherwise complies with the conditions stated in this License.

5. Submission of Contributions. Unless You explicitly state otherwise, any Contribution intentionally submitted for inclusion in the Work by You to the Licensor shall be under the terms and conditions of this License, without any additional terms or conditions.

Notwithstanding the above, nothing herein shall supersede or modify the terms of any separate license agreement you may have executed with Licensor regarding such Contributions.

6. Trademarks. This License does not grant permission to use the trade names, trademarks, service marks, or product names of the Licensor, except as required for reasonable and customary use in describing the origin of the Work and reproducing the content of the NOTICE file.

7. Disclaimer of Warranty. Unless required by applicable law or agreed to in writing, Licensor provides the Work (and each Contributor provides its Contributions) on an "AS IS" BASIS, WITHOUT WARRANTIES OR CONDITIONS OF ANY KIND, either express or implied, including, without limitation, any warranties or conditions of TITLE, NON-INFRINGEMENT, MERCHANTABILITY, or FITNESS FOR A PARTICULAR PURPOSE. You are solely responsible for determining the appropriateness of using or redistributing the Work and assume any risks associated with Your exercise of permissions under this License.

8. Limitation of Liability. In no event and under no legal theory, whether in tort (including negligence), contract, or otherwise, unless required by applicable law (such as deliberate and grossly negligent acts) or agreed to in writing, shall any Contributor be liable to You for damages, including any direct, indirect, special, incidental, or consequential damages of any character arising as a result of this License or out of the use or inability to use the Work (including but not limited to damages for loss of goodwill, work stoppage, computer failure or malfunction, or any and all other commercial damages or losses), even if such Contributor has been advised of the possibility of such damages.

9. Accepting Warranty or Additional Liability. While redistributing the Work or Derivative Works thereof, You may choose to offer, and charge a fee for, acceptance of support, warranty, indemnity, or other liability obligations and/or rights consistent with this License. However, in accepting such obligations, You may act only on Your own behalf and on Your sole responsibility, not on behalf of any other Contributor, and only if You agree to indemnify, defend, and hold each Contributor harmless for any liability incurred by, or claims asserted against, such Contributor by reason of your accepting any such warranty or additional liability.

END OF TERMS AND CONDITIONS

APPENDIX: How to apply the Apache License to your work.

To apply the Apache License to your work, attach the following boilerplate notice, with the fields enclosed by brackets "[]" replaced with your own identifying information. (Don't include the brackets!) The text should be enclosed in the appropriate comment syntax for the file format. We also recommend that a file or class name and description of purpose be included on the same "printed page" as the copyright notice for easier identification within third-party archives.

Copyright [yyyy] [name of copyright owner]

Licensed under the Apache License, Version 2.0 (the "License");
you may not use this file except in compliance with the License.

You may obtain a copy of the License at

<http://www.apache.org/licenses/LICENSE-2.0>

Unless required by applicable law or agreed to in writing, software
distributed under the License is distributed on an "AS IS" BASIS,
WITHOUT WARRANTIES OR CONDITIONS OF ANY KIND, either express or implied.
See the License for the specific language governing permissions and
limitations under the License.

servlet.jar

1. Java Platform Interface. Licensee may not modify the Java Platform Interface (JPI, identified as classes contained within the javax package or any subpackages of the javax package), by creating additional classes within the JPI or otherwise causing the addition to or modification of the classes in the JPI. In the event that Licensee creates any Java-related API and distribute such API to others for applet or application development, you must promptly publish broadly, an accurate specification for such API for free use by all developers of Java-based software.

2. Restrictions. Software is confidential copyrighted information of Sun and title to all copies is retained by Sun and/or its licensors. Licensee shall not modify, decompile, disassemble, decrypt, extract, or otherwise reverse engineer Software. Software may not be leased, assigned, or sublicensed, in whole or in part. Software is not designed or intended for use in on-line control of aircraft, air traffic, aircraft navigation or aircraft communications; or in the design, construction, operation or maintenance of any nuclear facility. Licensee warrants that it will not use or redistribute the Software for such purposes.

3. Disclaimer of Warranty. Software is

provided "AS IS," without a warranty of any kind. ALL EXPRESS OR IMPLIED REPRESENTATIONS AND WARRANTIES, INCLUDING ANY IMPLIED WARRANTY OF MERCHANTABILITY, FITNESS FOR A PARTICULAR PURPOSE OR NON-INFRINGEMENT, ARE HEREBY EXCLUDED.

4. Termination. This License is effective until terminated. Licensee may terminate this License at any time by destroying all copies of Software. This License will terminate immediately without notice from Sun if Licensee fails to comply with any provision of this License. Upon such termination, Licensee must destroy all copies of Software.

5. Export Regulations. Software, including technical data, is subject to U.S. export control laws, including the U.S. Export Administration Act and its associated regulations, and may be subject to export or import regulations in other countries. Licensee agrees to comply strictly with all such regulations and acknowledges that it has the responsibility to obtain licenses to export, re-export, or import Software. Software may not be downloaded, or otherwise exported or re-exported (i) into, or to a national or resident of, Cuba, Iraq, Iran, North Korea, Libya, Sudan, Syria or any country to which the U.S. has embargoed goods; or (ii) to anyone on the U.S. Treasury Department's list of Specially Designated Nations or the U.S. Commerce

Department's Table of Denial Orders.

Linux

GNU GENERAL PUBLIC LICENSE

Version 2, June 1991

Copyright (C) 1989, 1991 Free Software Foundation, Inc.

51 Franklin Street, Fifth Floor, Boston, MA 02110-1301, USA

Everyone is permitted to copy and distribute verbatim copies of this license document, but changing it is not allowed.

Preamble

The licenses for most software are designed to take away your freedom to share and change it. By contrast, the GNU General Public License is intended to guarantee your freedom to share and change free software--to make sure the software is free for all its users. This General Public License applies to most of the Free Software Foundation's software and to any other program whose authors commit to using it. (Some other Free Software Foundation software is covered by the GNU Lesser General Public License instead.) You can apply it to your programs, too.

When we speak of free software, we are referring to freedom, not price. Our General Public Licenses are designed to make sure that you have the freedom to distribute copies of free software (and charge for this service if you wish), that you receive source code or can get it if you want it, that you can change the software or use pieces of it in new free programs; and that you know you can do these things.

To protect your rights, we need to make restrictions that forbid anyone to deny you these rights or to ask you to surrender the rights. These restrictions translate to certain responsibilities for you if you distribute copies of the software, or if you modify it.

For example, if you distribute copies of such a program, whether gratis or for a fee, you must give the recipients all the rights that you have. You must make sure that they, too, receive or can get the source code. And you must show them these terms so they know their rights.

We protect your rights with two steps: (1) copyright the software, and (2) offer you this license which gives you legal permission to copy, distribute and/or modify the software.

Also, for each author's protection and ours, we want to make certain that everyone understands that there is no warranty for this free software. If the software is modified by someone else and passed on, we want its recipients to know that what they have is not the original, so that any problems introduced by others will not reflect on the original authors' reputations.

Finally, any free program is threatened constantly by software patents. We wish to avoid the danger that redistributors of a free program will individually obtain patent licenses, in effect making the program proprietary. To prevent this, we have made it clear that any patent must be licensed for everyone's free use or not licensed at all.

The precise terms and conditions for copying, distribution and modification follow.

TERMS AND CONDITIONS FOR COPYING, DISTRIBUTION AND MODIFICATION

0. This License applies to any program or other work which contains a notice placed by the copyright holder saying it may be distributed under the terms of this General Public License. The "Program", below, refers to any such program or work, and a "work based on the Program" means either the Program or any derivative work under copyright law: that is to say, a work containing the Program or a portion of it, either verbatim or with modifications and/or translated into another language. (Hereinafter, translation is included without limitation in the term "modification".) Each licensee is addressed as "you".

Activities other than copying, distribution and modification are not covered by this License; they are outside its scope. The act of running the Program is not restricted, and the output from the Program is covered only if its contents constitute a work based on the Program (independent of having been made by running the Program). Whether that is true depends on what the Program does.

1. You may copy and distribute verbatim copies of the Program's source code as you receive it, in any medium, provided that you conspicuously and appropriately publish on each copy an appropriate copyright notice and disclaimer of warranty; keep intact all the notices that refer to this License and to the absence of any warranty; and give any other recipients of the Program a copy of this License along with the Program.

You may charge a fee for the physical act of transferring a copy, and you may at your option offer warranty protection in exchange for a fee.

2. You may modify your copy or copies of the Program or any portion of it, thus forming a work based on the Program, and copy and distribute such modifications or work under the terms of Section 1 above, provided that you also meet all of these conditions:

- a) You must cause the modified files to carry prominent notices stating that you changed the files and the date of any change.
- b) You must cause any work that you distribute or publish, that in whole or in part contains or is derived from the Program or any part thereof, to be licensed as a whole at no charge to all third parties under the terms of this License.

c) If the modified program normally reads commands interactively when run, you must cause it, when started running for such interactive use in the most ordinary way, to print or display an announcement including an appropriate copyright notice and a notice that there is no warranty (or else, saying that you provide a warranty) and that users may redistribute the program under these conditions, and telling the user how to view a copy of this License. (Exception: if the Program itself is interactive but does not normally print such an announcement, your work based on the Program is not required to print an announcement.)

These requirements apply to the modified work as a whole. If identifiable sections of that work are not derived from the Program, and can be reasonably considered independent and separate works in themselves, then this License, and its terms, do not apply to those sections when you distribute them as separate works. But when you distribute the same sections as part of a whole which is a work based on the Program, the distribution of the whole must be on the terms of this License, whose permissions for other licensees extend to the entire whole, and thus to each and every part regardless of who wrote it.

Thus, it is not the intent of this section to claim rights or contest your rights to work written entirely by you; rather, the intent is to exercise the right to control the distribution of derivative or collective works based on the Program.

In addition, mere aggregation of another work not based on the Program with the Program (or with a work based on the Program) on a volume of a storage or distribution medium does not bring the other work under the scope of this License.

3. You may copy and distribute the Program (or a work based on it, under Section 2) in object code or executable form under the terms of Sections 1 and 2 above provided that you also do one of the following:

a) Accompany it with the complete corresponding machine-readable source code, which must be distributed under the terms of Sections 1 and 2 above on a medium customarily used for software interchange; or,

b) Accompany it with a written offer, valid for at least three years, to give any third party, for a charge no more than your cost of physically performing source distribution, a complete machine-readable copy of the corresponding source code, to be distributed under the terms of Sections 1 and 2 above on a medium customarily used for software interchange; or,

c) Accompany it with the information you received as to the offer to distribute corresponding source code. (This alternative is allowed only for noncommercial distribution and only if you received the program in object code or executable form with such an offer, in accord with Subsection b above.)

The source code for a work means the preferred form of the work for making modifications to it. For an executable work, complete source code means all the source code for all modules it contains, plus any associated interface definition files, plus the scripts used to control compilation and installation of the executable. However, as a special exception, the source code distributed need not include anything that is normally distributed (in either source or binary form) with the major components (compiler, kernel, and so on) of the operating system on which the executable runs, unless that component itself accompanies the executable.

If distribution of executable or object code is made by offering access to copy from a designated place, then offering equivalent access to copy the source code from the same place counts as distribution of the source code, even though third parties are not compelled to copy the source along with the object code.

4. You may not copy, modify, sublicense, or distribute the Program except as expressly provided under this License. Any attempt otherwise to copy, modify, sublicense or distribute the Program is void, and will automatically terminate your rights under this License. However, parties who have received copies, or rights, from you under this License will not have their licenses terminated so long as such parties remain in full compliance.

5. You are not required to accept this License, since you have not signed it. However, nothing else grants you permission to modify or distribute the Program or its derivative works. These actions are prohibited by law if you do not accept this License. Therefore, by modifying or distributing the Program (or any work based on the Program), you indicate your acceptance of this License to do so, and all its terms and conditions for copying, distributing or modifying the Program or works based on it.

6. Each time you redistribute the Program (or any work based on the Program), the recipient automatically receives a license from the original licensor to copy, distribute or modify the Program subject to these terms and conditions. You may not impose any further restrictions on the recipients' exercise of the rights granted herein. You are not responsible for enforcing compliance by third parties to this License.

7. If, as a consequence of a court judgment or allegation of patent infringement or for any other reason (not limited to patent issues), conditions are imposed on you (whether by court order, agreement or otherwise) that contradict the conditions of this License, they do not excuse you from the conditions of this License. If you cannot distribute so as to satisfy simultaneously your obligations under this License and any other pertinent obligations, then as a consequence you may not distribute the Program at all. For example, if a patent license would not permit royalty-free redistribution of the Program by all those who receive copies directly or indirectly through you, then the only way you could satisfy both it and this License would be to refrain entirely from distribution of the Program.

If any portion of this section is held invalid or unenforceable under any particular circumstance, the balance of the section is intended to apply and the section as a whole is intended to apply in other circumstances.

It is not the purpose of this section to induce you to infringe any patents or other property right claims or to contest validity of any such claims; this section has the sole purpose of protecting the integrity of the free software distribution system, which is implemented by public license practices. Many people have made generous contributions to the wide range of software distributed through that system in reliance on consistent application of that system; it is up to the author/donor to decide if he or she is willing to distribute software through any other system and a licensee cannot impose that choice.

This section is intended to make thoroughly clear what is believed to be a consequence of the rest of this License.

8. If the distribution and/or use of the Program is restricted in certain countries either by patents or by copyrighted interfaces, the original copyright holder who places the Program under this License may add an explicit geographical distribution limitation excluding those countries, so that distribution is permitted only in or among countries not thus excluded. In such case, this License incorporates the limitation as if written in the body of this License.

9. The Free Software Foundation may publish revised and/or new versions of the General Public License from time to time. Such new versions will be similar in spirit to the present version, but may differ in detail to address new problems or concerns.

Each version is given a distinguishing version number. If the Program specifies a version number of this License which applies to it and "any later version", you have the option of following the terms and conditions either of that version or of any later version published by the Free Software Foundation. If the Program does not specify a version number of this License, you may choose any version ever published by the Free Software Foundation.

10. If you wish to incorporate parts of the Program into other free programs whose distribution conditions are different, write to the author to ask for permission. For software which is copyrighted by the Free Software Foundation, write to the Free Software Foundation; we sometimes make exceptions for this. Our decision will be guided by the two goals of preserving the free status of all derivatives of our free software and of promoting the sharing and reuse of software generally.

NO WARRANTY

11. BECAUSE THE PROGRAM IS LICENSED FREE OF CHARGE, THERE IS NO WARRANTY FOR THE PROGRAM, TO THE EXTENT PERMITTED BY APPLICABLE LAW. EXCEPT WHEN OTHERWISE STATED IN WRITING THE COPYRIGHT HOLDERS AND/OR OTHER PARTIES PROVIDE THE PROGRAM "AS IS" WITHOUT WARRANTY OF ANY KIND, EITHER EXPRESSED OR IMPLIED, INCLUDING, BUT NOT LIMITED TO, THE IMPLIED WARRANTIES OF MERCHANTABILITY AND FITNESS FOR A PARTICULAR PURPOSE. THE ENTIRE RISK AS TO THE QUALITY AND PERFORMANCE OF THE PROGRAM IS WITH YOU. SHOULD THE PROGRAM PROVE DEFECTIVE, YOU ASSUME THE COST OF ALL NECESSARY SERVICING, REPAIR OR CORRECTION.

12. IN NO EVENT UNLESS REQUIRED BY APPLICABLE LAW OR AGREED TO IN WRITING WILL ANY COPYRIGHT HOLDER, OR ANY OTHER PARTY WHO MAY MODIFY AND/OR REDISTRIBUTE THE PROGRAM AS PERMITTED ABOVE, BE LIABLE TO YOU FOR DAMAGES, INCLUDING ANY GENERAL, SPECIAL, INCIDENTAL OR CONSEQUENTIAL DAMAGES ARISING OUT OF THE USE OR INABILITY TO USE THE PROGRAM (INCLUDING BUT NOT LIMITED TO LOSS OF DATA OR DATA BEING RENDERED INACCURATE OR LOSSES SUSTAINED BY YOU OR THIRD PARTIES OR A FAILURE OF THE PROGRAM TO OPERATE WITH ANY OTHER PROGRAMS), EVEN IF SUCH HOLDER OR OTHER PARTY HAS BEEN ADVISED OF THE POSSIBILITY OF SUCH DAMAGES.

END OF TERMS AND CONDITIONS

How to Apply These Terms to Your New Programs

If you develop a new program, and you want it to be of the greatest possible use to the public, the best way to achieve this is to make it free software which everyone can redistribute and change under these terms.

To do so, attach the following notices to the program. It is safest to attach them to the start of each source file to most effectively convey the exclusion of warranty; and each file should have at least the "copyright" line and a pointer to where the full notice is found.

one line to give the program's name and an idea of what it does.

Copyright (C) yyyy *name of author*

This program is free software; you can redistribute it and/or modify it under the terms of the GNU General Public License as published by the Free Software Foundation; either version 2 of the License, or (at your option) any later version.

This program is distributed in the hope that it will be useful, but WITHOUT ANY WARRANTY; without even the implied warranty of MERCHANTABILITY or FITNESS FOR A PARTICULAR PURPOSE. See the

GNU General Public License for more details.

You should have received a copy of the GNU General Public License along with this program; if not, write to the Free Software Foundation, Inc., 51 Franklin Street, Fifth Floor, Boston, MA 02110-1301, USA.

Also add information on how to contact you by electronic and paper mail.

If the program is interactive, make it output a short notice like this when it starts in an interactive mode:

```
Gnomovision version 69, Copyright (C) year name of author
Gnomovision comes with ABSOLUTELY NO WARRANTY; for details
type `show w'. This is free software, and you are welcome
to redistribute it under certain conditions; type `show c'
for details.
```

The hypothetical commands `show w' and `show c' should show the appropriate parts of the General Public License. Of course, the commands you use may be called something other than `show w' and `show c'; they could even be mouse-clicks or menu items--whatever suits your program.

You should also get your employer (if you work as a programmer) or your school, if any, to sign a "copyright disclaimer" for the program, if necessary. Here is a sample; alter the names:

```
Yoyodyne, Inc., hereby disclaims all copyright
interest in the program `Gnomovision'
(which makes passes at compilers) written
by James Hacker.
```

```
signature of Ty Coon, 1 April 1989
Ty Coon, President of Vice
```

This General Public License does not permit incorporating your program into proprietary programs. If your program is a subroutine library, you may consider it more useful to permit linking proprietary applications with the library. If this is what you want to do, use the GNU Lesser General Public License instead of this License.

glibc

json-glib

GNU LESSER GENERAL PUBLIC LICENSE

Version 2.1, February 1999

Copyright (C) 1991, 1999 Free Software Foundation, Inc.

51 Franklin Street, Fifth Floor, Boston, MA 02110-1301 USA

Everyone is permitted to copy and distribute verbatim copies of this license document, but changing it is not allowed.

[This is the first released version of the Lesser GPL. It also counts as the successor of the GNU Library Public License, version 2, hence the version number 2.1.]

Preamble

The licenses for most software are designed to take away your freedom to share and change it. By contrast, the GNU General Public Licenses are intended to guarantee your freedom to share and change free software--to make sure the software is free for all its users.

This license, the Lesser General Public License, applies to some specially designated software packages--typically libraries--of the Free Software Foundation and other authors who decide to use it. You can use it too, but we suggest you first think carefully about whether this license or the ordinary General Public License is the better strategy to use in any particular case, based on the explanations below.

When we speak of free software, we are referring to freedom of use, not price. Our General Public Licenses are designed to make sure that you have the freedom to distribute copies of free software (and charge for this service if you wish); that you receive source code or can get it if you want it; that you can change the software and use pieces of it in new free programs; and that you are informed that you can do these things.

To protect your rights, we need to make restrictions that forbid distributors to deny you these rights or to ask you to surrender these rights. These restrictions translate to certain responsibilities for you if you distribute copies of the library or if you modify it.

For example, if you distribute copies of the library, whether gratis or for a fee, you must give the recipients all the rights that we gave you. You must make sure that they, too, receive or can get the source code. If you link other code with the library, you must provide complete object files to the recipients, so that they can relink them with the library after making changes to the library and recompiling it. And you must show them these terms so they know their rights.

We protect your rights with a two-step method: (1) we copyright the library, and (2) we offer you this license, which gives you legal permission to copy, distribute and/or modify the library.

To protect each distributor, we want to make it very clear that there is no warranty for the free library. Also, if the library is modified by someone else and passed on, the recipients should know that what they have is not

the original version, so that the original author's reputation will not be affected by problems that might be introduced by others.

Finally, software patents pose a constant threat to the existence of any free program. We wish to make sure that a company cannot effectively restrict the users of a free program by obtaining a restrictive license from a patent holder. Therefore, we insist that any patent license obtained for a version of the library must be consistent with the full freedom of use specified in this license.

Most GNU software, including some libraries, is covered by the ordinary GNU General Public License. This license, the GNU Lesser General Public License, applies to certain designated libraries, and is quite different from the ordinary General Public License. We use this license for certain libraries in order to permit linking those libraries into non-free programs.

When a program is linked with a library, whether statically or using a shared library, the combination of the two is legally speaking a combined work, a derivative of the original library. The ordinary General Public License therefore permits such linking only if the entire combination fits its criteria of freedom. The Lesser General Public License permits more lax criteria for linking other code with the library.

We call this license the "Lesser" General Public License because it does Less to protect the user's freedom than the ordinary General Public License. It also provides other free software developers Less of an advantage over competing non-free programs. These disadvantages are the reason we use the ordinary General Public License for many libraries. However, the Lesser license provides advantages in certain special circumstances. For example, on rare occasions, there may be a special need to encourage the widest possible use of a certain library, so that it becomes a de-facto standard. To achieve this, non-free programs must be allowed to use the library. A more frequent case is that a free library does the same job as widely used non-free libraries. In this case, there is little to gain by limiting the free library to free software only, so we use the Lesser General Public License.

In other cases, permission to use a particular library in non-free programs enables a greater number of people to use a large body of free software. For example, permission to use the GNU C Library in non-free programs enables many more people to use the whole GNU operating system, as well as its variant, the GNU/Linux operating system.

Although the Lesser General Public License is Less protective of the users' freedom, it does ensure that the user of a program that is linked with the Library has the freedom and the wherewithal to run that program using a modified version of the Library.

The precise terms and conditions for copying, distribution and modification follow. Pay close attention to the difference between a "work based on the library" and a "work that uses the library". The former contains code derived from the library, whereas the latter must be combined with the library in order to run.

TERMS AND CONDITIONS FOR COPYING, DISTRIBUTION AND MODIFICATION

0. This License Agreement applies to any software library or other program which contains a notice placed by the copyright holder or other authorized party saying it may be distributed under the terms of this Lesser General Public License (also called "this License"). Each licensee is addressed as "you".

A "library" means a collection of software functions and/or data prepared so as to be conveniently linked with application programs (which use some of those functions and data) to form executables.

The "Library", below, refers to any such software library or work which has been distributed under these terms.

A "work based on the Library" means either the Library or any derivative work under copyright law: that is to say, a work containing the Library or a portion of it, either verbatim or with modifications and/or translated straightforwardly into another language. (Hereinafter, translation is included without limitation in the term "modification".)

"Source code" for a work means the preferred form of the work for making modifications to it. For a library, complete source code means all the source code for all modules it contains, plus any associated interface definition files, plus the scripts used to control compilation and installation of the library.

Activities other than copying, distribution and modification are not covered by this License; they are outside its scope. The act of running a program using the Library is not restricted, and output from such a program is covered only if its contents constitute a work based on the Library (independent of the use of the Library in a tool for writing it). Whether that is true depends on what the Library does and what the program that uses the Library does.

1. You may copy and distribute verbatim copies of the Library's complete source code as you receive it, in any medium, provided that you conspicuously and appropriately publish on each copy an appropriate copyright notice and disclaimer of warranty; keep intact all the notices that refer to this License and to the absence of any warranty; and distribute a copy of this License along with the Library.

You may charge a fee for the physical act of transferring a copy, and you may at your option offer warranty protection in exchange for a fee.

2. You may modify your copy or copies of the Library or any portion of it, thus forming a work based on the Library, and copy and distribute such modifications or work under the terms of Section 1 above, provided that you also meet all of these conditions:

- **a)** The modified work must itself be a software library.
- **b)** You must cause the files modified to carry prominent notices stating that you changed the files and the date of any change.
- **c)** You must cause the whole of the work to be licensed at no charge to all third parties under the terms of this License.
- **d)** If a facility in the modified Library refers to a function or a table of data to be supplied by an application program that uses the facility, other than as an argument passed when the facility is invoked, then you must make a good faith effort to ensure that, in the event an application does not supply such function or table, the facility still operates, and performs whatever part of its purpose remains meaningful.

(For example, a function in a library to compute square roots has a purpose that is entirely well-defined independent of the application. Therefore, Subsection 2d requires that any application-supplied

function or table used by this function must be optional: if the application does not supply it, the square root function must still compute square roots.)

These requirements apply to the modified work as a whole. If identifiable sections of that work are not derived from the Library, and can be reasonably considered independent and separate works in themselves, then this License, and its terms, do not apply to those sections when you distribute them as separate works. But when you distribute the same sections as part of a whole which is a work based on the Library, the distribution of the whole must be on the terms of this License, whose permissions for other licensees extend to the entire whole, and thus to each and every part regardless of who wrote it.

Thus, it is not the intent of this section to claim rights or contest your rights to work written entirely by you; rather, the intent is to exercise the right to control the distribution of derivative or collective works based on the Library.

In addition, mere aggregation of another work not based on the Library with the Library (or with a work based on the Library) on a volume of a storage or distribution medium does not bring the other work under the scope of this License.

3. You may opt to apply the terms of the ordinary GNU General Public License instead of this License to a given copy of the Library. To do this, you must alter all the notices that refer to this License, so that they refer to the ordinary GNU General Public License, version 2, instead of to this License. (If a newer version than version 2 of the ordinary GNU General Public License has appeared, then you can specify that version instead if you wish.) Do not make any other change in these notices.

Once this change is made in a given copy, it is irreversible for that copy, so the ordinary GNU General Public License applies to all subsequent copies and derivative works made from that copy.

This option is useful when you wish to copy part of the code of the Library into a program that is not a library.

4. You may copy and distribute the Library (or a portion or derivative of it, under Section 2) in object code or executable form under the terms of Sections 1 and 2 above provided that you accompany it with the complete corresponding machine-readable source code, which must be distributed under the terms of Sections 1 and 2 above on a medium customarily used for software interchange.

If distribution of object code is made by offering access to copy from a designated place, then offering equivalent access to copy the source code from the same place satisfies the requirement to distribute the source code, even though third parties are not compelled to copy the source along with the object code.

5. A program that contains no derivative of any portion of the Library, but is designed to work with the Library by being compiled or linked with it, is called a "work that uses the Library". Such a work, in isolation, is not a derivative work of the Library, and therefore falls outside the scope of this License.

However, linking a "work that uses the Library" with the Library creates an executable that is a derivative of the Library (because it contains portions of the Library), rather than a "work that uses the library". The executable is therefore covered by this License. Section 6 states terms for distribution of such executables.

When a "work that uses the Library" uses material from a header file that is part of the Library, the object code for the work may be a derivative work of the Library even though the source code is not. Whether this is true is

especially significant if the work can be linked without the Library, or if the work is itself a library. The threshold for this to be true is not precisely defined by law.

If such an object file uses only numerical parameters, data structure layouts and accessors, and small macros and small inline functions (ten lines or less in length), then the use of the object file is unrestricted, regardless of whether it is legally a derivative work. (Executables containing this object code plus portions of the Library will still fall under Section 6.)

Otherwise, if the work is a derivative of the Library, you may distribute the object code for the work under the terms of Section 6. Any executables containing that work also fall under Section 6, whether or not they are linked directly with the Library itself.

6. As an exception to the Sections above, you may also combine or link a "work that uses the Library" with the Library to produce a work containing portions of the Library, and distribute that work under terms of your choice, provided that the terms permit modification of the work for the customer's own use and reverse engineering for debugging such modifications.

You must give prominent notice with each copy of the work that the Library is used in it and that the Library and its use are covered by this License. You must supply a copy of this License. If the work during execution displays copyright notices, you must include the copyright notice for the Library among them, as well as a reference directing the user to the copy of this License. Also, you must do one of these things:

- **a)** Accompany the work with the complete corresponding machine-readable source code for the Library including whatever changes were used in the work (which must be distributed under Sections 1 and 2 above); and, if the work is an executable linked with the Library, with the complete machine-readable "work that uses the Library", as object code and/or source code, so that the user can modify the Library and then relink to produce a modified executable containing the modified Library. (It is understood that the user who changes the contents of definitions files in the Library will not necessarily be able to recompile the application to use the modified definitions.)
- **b)** Use a suitable shared library mechanism for linking with the Library. A suitable mechanism is one that (1) uses at run time a copy of the library already present on the user's computer system, rather than copying library functions into the executable, and (2) will operate properly with a modified version of the library, if the user installs one, as long as the modified version is interface-compatible with the version that the work was made with.
- **c)** Accompany the work with a written offer, valid for at least three years, to give the same user the materials specified in Subsection 6a, above, for a charge no more than the cost of performing this distribution.
- **d)** If distribution of the work is made by offering access to copy from a designated place, offer equivalent access to copy the above specified materials from the same place.
- **e)** Verify that the user has already received a copy of these materials or that you have already sent this user a copy.

For an executable, the required form of the "work that uses the Library" must include any data and utility programs needed for reproducing the executable from it. However, as a special exception, the materials to be distributed need not include anything that is normally distributed (in either source or binary form) with the major components (compiler, kernel, and so on) of the operating system on which the executable runs, unless that component itself accompanies the executable.

It may happen that this requirement contradicts the license restrictions of other proprietary libraries that do not normally accompany the operating system. Such a contradiction means you cannot use both them and the Library together in an executable that you distribute.

7. You may place library facilities that are a work based on the Library side-by-side in a single library together with other library facilities not covered by this License, and distribute such a combined library, provided that the separate distribution of the work based on the Library and of the other library facilities is otherwise permitted, and provided that you do these two things:

- **a)** Accompany the combined library with a copy of the same work based on the Library, uncombined with any other library facilities. This must be distributed under the terms of the Sections above.
- **b)** Give prominent notice with the combined library of the fact that part of it is a work based on the Library, and explaining where to find the accompanying uncombined form of the same work.

8. You may not copy, modify, sublicense, link with, or distribute the Library except as expressly provided under this License. Any attempt otherwise to copy, modify, sublicense, link with, or distribute the Library is void, and will automatically terminate your rights under this License. However, parties who have received copies, or rights, from you under this License will not have their licenses terminated so long as such parties remain in full compliance.

9. You are not required to accept this License, since you have not signed it. However, nothing else grants you permission to modify or distribute the Library or its derivative works. These actions are prohibited by law if you do not accept this License. Therefore, by modifying or distributing the Library (or any work based on the Library), you indicate your acceptance of this License to do so, and all its terms and conditions for copying, distributing or modifying the Library or works based on it.

10. Each time you redistribute the Library (or any work based on the Library), the recipient automatically receives a license from the original licensor to copy, distribute, link with or modify the Library subject to these terms and conditions. You may not impose any further restrictions on the recipients' exercise of the rights granted herein. You are not responsible for enforcing compliance by third parties with this License.

11. If, as a consequence of a court judgment or allegation of patent infringement or for any other reason (not limited to patent issues), conditions are imposed on you (whether by court order, agreement or otherwise) that contradict the conditions of this License, they do not excuse you from the conditions of this License. If you cannot distribute so as to satisfy simultaneously your obligations under this License and any other pertinent obligations, then as a consequence you may not distribute the Library at all. For example, if a patent license would not permit royalty-free redistribution of the Library by all those who receive copies directly or indirectly

through you, then the only way you could satisfy both it and this License would be to refrain entirely from distribution of the Library.

If any portion of this section is held invalid or unenforceable under any particular circumstance, the balance of the section is intended to apply, and the section as a whole is intended to apply in other circumstances.

It is not the purpose of this section to induce you to infringe any patents or other property right claims or to contest validity of any such claims; this section has the sole purpose of protecting the integrity of the free software distribution system which is implemented by public license practices. Many people have made generous contributions to the wide range of software distributed through that system in reliance on consistent application of that system; it is up to the author/donor to decide if he or she is willing to distribute software through any other system and a licensee cannot impose that choice.

This section is intended to make thoroughly clear what is believed to be a consequence of the rest of this License.

12. If the distribution and/or use of the Library is restricted in certain countries either by patents or by copyrighted interfaces, the original copyright holder who places the Library under this License may add an explicit geographical distribution limitation excluding those countries, so that distribution is permitted only in or among countries not thus excluded. In such case, this License incorporates the limitation as if written in the body of this License.

13. The Free Software Foundation may publish revised and/or new versions of the Lesser General Public License from time to time. Such new versions will be similar in spirit to the present version, but may differ in detail to address new problems or concerns.

Each version is given a distinguishing version number. If the Library specifies a version number of this License which applies to it and "any later version", you have the option of following the terms and conditions either of that version or of any later version published by the Free Software Foundation. If the Library does not specify a license version number, you may choose any version ever published by the Free Software Foundation.

14. If you wish to incorporate parts of the Library into other free programs whose distribution conditions are incompatible with these, write to the author to ask for permission. For software which is copyrighted by the Free Software Foundation, write to the Free Software Foundation; we sometimes make exceptions for this. Our decision will be guided by the two goals of preserving the free status of all derivatives of our free software and of promoting the sharing and reuse of software generally.

NO WARRANTY

15. BECAUSE THE LIBRARY IS LICENSED FREE OF CHARGE, THERE IS NO WARRANTY FOR THE LIBRARY, TO THE EXTENT PERMITTED BY APPLICABLE LAW. EXCEPT WHEN OTHERWISE STATED IN WRITING THE COPYRIGHT HOLDERS AND/OR OTHER PARTIES PROVIDE THE LIBRARY "AS IS" WITHOUT WARRANTY OF ANY KIND, EITHER EXPRESSED OR IMPLIED, INCLUDING, BUT NOT LIMITED TO, THE IMPLIED WARRANTIES OF MERCHANTABILITY AND FITNESS FOR A PARTICULAR PURPOSE. THE ENTIRE RISK AS TO THE QUALITY AND PERFORMANCE OF THE LIBRARY IS WITH YOU. SHOULD THE LIBRARY PROVE DEFECTIVE, YOU ASSUME THE COST OF ALL NECESSARY SERVICING, REPAIR OR CORRECTION.

16. IN NO EVENT UNLESS REQUIRED BY APPLICABLE LAW OR AGREED TO IN WRITING WILL ANY COPYRIGHT HOLDER, OR ANY OTHER PARTY WHO MAY MODIFY AND/OR REDISTRIBUTE THE LIBRARY AS PERMITTED ABOVE, BE LIABLE TO YOU FOR DAMAGES, INCLUDING ANY GENERAL, SPECIAL, INCIDENTAL OR CONSEQUENTIAL DAMAGES ARISING OUT OF THE USE OR INABILITY TO USE THE LIBRARY (INCLUDING BUT NOT LIMITED TO LOSS OF DATA OR DATA BEING RENDERED INACCURATE OR LOSSES SUSTAINED BY YOU OR THIRD PARTIES OR A FAILURE OF THE LIBRARY TO OPERATE WITH ANY OTHER SOFTWARE), EVEN IF SUCH HOLDER OR OTHER PARTY HAS BEEN ADVISED OF THE POSSIBILITY OF SUCH DAMAGES.

END OF TERMS AND CONDITIONS

How to Apply These Terms to Your New Libraries

If you develop a new library, and you want it to be of the greatest possible use to the public, we recommend making it free software that everyone can redistribute and change. You can do so by permitting redistribution under these terms (or, alternatively, under the terms of the ordinary General Public License).

To apply these terms, attach the following notices to the library. It is safest to attach them to the start of each source file to most effectively convey the exclusion of warranty; and each file should have at least the "copyright" line and a pointer to where the full notice is found.

one line to give the library's name and an idea of what it does.

Copyright (C) *year* *name of author*

This library is free software; you can redistribute it and/or modify it under the terms of the GNU Lesser General Public License as published by the Free Software Foundation; either version 2.1 of the License, or (at your option) any later version.

This library is distributed in the hope that it will be useful, but WITHOUT ANY WARRANTY; without even the implied warranty of MERCHANTABILITY or FITNESS FOR A PARTICULAR PURPOSE. See the GNU Lesser General Public License for more details.

You should have received a copy of the GNU Lesser General Public License along with this library; if not, write to the Free Software Foundation, Inc., 51 Franklin Street, Fifth Floor, Boston, MA 02110-1301 USA

Also add information on how to contact you by electronic and paper mail.

You should also get your employer (if you work as a programmer) or your school, if any, to sign a "copyright disclaimer" for the library, if necessary. Here is a sample; alter the names:

Yoyodyne, Inc., hereby disclaims all copyright interest in the library `Frob' (a library for tweaking knobs) written by James Random Hacker.

signature of Ty Coon, 1 April 1990

Ty Coon, President of Vice

That's all there is to it!

glib

GNU LIBRARY GENERAL PUBLIC LICENSE

Version 2, June 1991

Copyright (C) 1991 Free Software Foundation, Inc.

59 Temple Place, Suite 330, Boston, MA 02111-1307 USA

Everyone is permitted to copy and distribute verbatim copies of this license document, but changing it is not allowed.

[This is the first released version of the library GPL. It is numbered 2 because it goes with version 2 of the ordinary GPL.]

Preamble

The licenses for most software are designed to take away your freedom to share and change it. By contrast, the GNU General Public Licenses are intended to guarantee your freedom to share and change free software--to make sure the software is free for all its users.

This license, the Library General Public License, applies to some specially designated Free Software Foundation software, and to any other libraries whose authors decide to use it. You can use it for your libraries, too.

When we speak of free software, we are referring to freedom, not price. Our General Public Licenses are designed to make sure that you have the freedom to distribute copies of free software (and charge for this service if you wish), that you receive source code or can get it if you want it, that you can change the software or use pieces of it in new free programs; and that you know you can do these things.

To protect your rights, we need to make restrictions that forbid anyone to deny you these rights or to ask you to surrender the rights. These restrictions translate to certain responsibilities for you if you distribute copies of the library, or if you modify it.

For example, if you distribute copies of the library, whether gratis

or for a fee, you must give the recipients all the rights that we gave you. You must make sure that they, too, receive or can get the source code. If you link a program with the library, you must provide complete object files to the recipients so that they can relink them with the library, after making changes to the library and recompiling it. And you must show them these terms so they know their rights.

Our method of protecting your rights has two steps: (1) copyright the library, and (2) offer you this license which gives you legal permission to copy, distribute and/or modify the library.

Also, for each distributor's protection, we want to make certain that everyone understands that there is no warranty for this free library. If the library is modified by someone else and passed on, we want its recipients to know that what they have is not the original version, so that any problems introduced by others will not reflect on the original authors' reputations.

Finally, any free program is threatened constantly by software patents. We wish to avoid the danger that companies distributing free software will individually obtain patent licenses, thus in effect transforming the program into proprietary software. To prevent this, we have made it clear that any patent must be licensed for everyone's free use or not licensed at all.

Most GNU software, including some libraries, is covered by the ordinary GNU General Public License, which was designed for utility programs. This license, the GNU Library General Public License, applies to certain designated libraries. This license is quite different from the ordinary one; be sure to read it in full, and don't assume that anything in it is the same as in the ordinary license.

The reason we have a separate public license for some libraries is that they blur the distinction we usually make between modifying or adding to a program and simply using it. Linking a program with a library, without changing the library, is in some sense simply using the library, and is analogous to running a utility program or application program. However, in a textual and legal sense, the linked executable is a combined work, a

derivative of the original library, and the ordinary General Public License treats it as such.

Because of this blurred distinction, using the ordinary General Public License for libraries did not effectively promote software sharing, because most developers did not use the libraries. We concluded that weaker conditions might promote sharing better.

However, unrestricted linking of non-free programs would deprive the users of those programs of all benefit from the free status of the libraries themselves. This Library General Public License is intended to permit developers of non-free programs to use free libraries, while preserving your freedom as a user of such programs to change the free libraries that are incorporated in them. (We have not seen how to achieve this as regards changes in header files, but we have achieved it as regards changes in the actual functions of the Library.) The hope is that this will lead to faster development of free libraries.

The precise terms and conditions for copying, distribution and modification follow. Pay close attention to the difference between a "work based on the library" and a "work that uses the library". The former contains code derived from the library, while the latter only works together with the library.

Note that it is possible for a library to be covered by the ordinary General Public License rather than by this special one.

GNU LIBRARY GENERAL PUBLIC LICENSE TERMS AND CONDITIONS FOR COPYING, DISTRIBUTION AND MODIFICATION

0. This License Agreement applies to any software library which contains a notice placed by the copyright holder or other authorized party saying it may be distributed under the terms of this Library General Public License (also called "this License"). Each licensee is addressed as "you".

A "library" means a collection of software functions and/or data prepared so as to be conveniently linked with application programs

(which use some of those functions and data) to form executables.

The "Library", below, refers to any such software library or work which has been distributed under these terms. A "work based on the Library" means either the Library or any derivative work under copyright law: that is to say, a work containing the Library or a portion of it, either verbatim or with modifications and/or translated straightforwardly into another language. (Hereinafter, translation is included without limitation in the term "modification".)

"Source code" for a work means the preferred form of the work for making modifications to it. For a library, complete source code means all the source code for all modules it contains, plus any associated interface definition files, plus the scripts used to control compilation and installation of the library.

Activities other than copying, distribution and modification are not covered by this License; they are outside its scope. The act of running a program using the Library is not restricted, and output from such a program is covered only if its contents constitute a work based on the Library (independent of the use of the Library in a tool for writing it). Whether that is true depends on what the Library does and what the program that uses the Library does.

1. You may copy and distribute verbatim copies of the Library's complete source code as you receive it, in any medium, provided that you conspicuously and appropriately publish on each copy an appropriate copyright notice and disclaimer of warranty; keep intact all the notices that refer to this License and to the absence of any warranty; and distribute a copy of this License along with the Library.

You may charge a fee for the physical act of transferring a copy, and you may at your option offer warranty protection in exchange for a fee.

2. You may modify your copy or copies of the Library or any portion of it, thus forming a work based on the Library, and copy and

distribute such modifications or work under the terms of Section 1 above, provided that you also meet all of these conditions:

- a) The modified work must itself be a software library.
- b) You must cause the files modified to carry prominent notices stating that you changed the files and the date of any change.
- c) You must cause the whole of the work to be licensed at no charge to all third parties under the terms of this License.
- d) If a facility in the modified Library refers to a function or a table of data to be supplied by an application program that uses the facility, other than as an argument passed when the facility is invoked, then you must make a good faith effort to ensure that, in the event an application does not supply such function or table, the facility still operates, and performs whatever part of its purpose remains meaningful.

(For example, a function in a library to compute square roots has a purpose that is entirely well-defined independent of the application. Therefore, Subsection 2d requires that any application-supplied function or table used by this function must be optional: if the application does not supply it, the square root function must still compute square roots.)

These requirements apply to the modified work as a whole. If identifiable sections of that work are not derived from the Library, and can be reasonably considered independent and separate works in themselves, then this License, and its terms, do not apply to those sections when you distribute them as separate works. But when you distribute the same sections as part of a whole which is a work based on the Library, the distribution of the whole must be on the terms of this License, whose permissions for other licensees extend to the entire whole, and thus to each and every part regardless of who wrote it.

Thus, it is not the intent of this section to claim rights or contest

your rights to work written entirely by you; rather, the intent is to exercise the right to control the distribution of derivative or collective works based on the Library.

In addition, mere aggregation of another work not based on the Library with the Library (or with a work based on the Library) on a volume of a storage or distribution medium does not bring the other work under the scope of this License.

3. You may opt to apply the terms of the ordinary GNU General Public License instead of this License to a given copy of the Library. To do this, you must alter all the notices that refer to this License, so that they refer to the ordinary GNU General Public License, version 2, instead of to this License. (If a newer version than version 2 of the ordinary GNU General Public License has appeared, then you can specify that version instead if you wish.) Do not make any other change in these notices.

Once this change is made in a given copy, it is irreversible for that copy, so the ordinary GNU General Public License applies to all subsequent copies and derivative works made from that copy.

This option is useful when you wish to copy part of the code of the Library into a program that is not a library.

4. You may copy and distribute the Library (or a portion or derivative of it, under Section 2) in object code or executable form under the terms of Sections 1 and 2 above provided that you accompany it with the complete corresponding machine-readable source code, which must be distributed under the terms of Sections 1 and 2 above on a medium customarily used for software interchange.

If distribution of object code is made by offering access to copy from a designated place, then offering equivalent access to copy the source code from the same place satisfies the requirement to distribute the source code, even though third parties are not compelled to copy the source along with the object code.

5. A program that contains no derivative of any portion of the Library, but is designed to work with the Library by being compiled or linked with it, is called a "work that uses the Library". Such a work, in isolation, is not a derivative work of the Library, and therefore falls outside the scope of this License.

However, linking a "work that uses the Library" with the Library creates an executable that is a derivative of the Library (because it contains portions of the Library), rather than a "work that uses the library". The executable is therefore covered by this License. Section 6 states terms for distribution of such executables.

When a "work that uses the Library" uses material from a header file that is part of the Library, the object code for the work may be a derivative work of the Library even though the source code is not. Whether this is true is especially significant if the work can be linked without the Library, or if the work is itself a library. The threshold for this to be true is not precisely defined by law.

If such an object file uses only numerical parameters, data structure layouts and accessors, and small macros and small inline functions (ten lines or less in length), then the use of the object file is unrestricted, regardless of whether it is legally a derivative work. (Executables containing this object code plus portions of the Library will still fall under Section 6.)

Otherwise, if the work is a derivative of the Library, you may distribute the object code for the work under the terms of Section 6. Any executables containing that work also fall under Section 6, whether or not they are linked directly with the Library itself.

6. As an exception to the Sections above, you may also compile or link a "work that uses the Library" with the Library to produce a work containing portions of the Library, and distribute that work under terms of your choice, provided that the terms permit modification of the work for the customer's own use and reverse engineering for debugging such modifications.

You must give prominent notice with each copy of the work that the Library is used in it and that the Library and its use are covered by this License. You must supply a copy of this License. If the work during execution displays copyright notices, you must include the copyright notice for the Library among them, as well as a reference directing the user to the copy of this License. Also, you must do one of these things:

a) Accompany the work with the complete corresponding machine-readable source code for the Library including whatever changes were used in the work (which must be distributed under Sections 1 and 2 above); and, if the work is an executable linked with the Library, with the complete machine-readable "work that uses the Library", as object code and/or source code, so that the user can modify the Library and then relink to produce a modified executable containing the modified Library. (It is understood that the user who changes the contents of definitions files in the Library will not necessarily be able to recompile the application to use the modified definitions.)

b) Accompany the work with a written offer, valid for at least three years, to give the same user the materials specified in Subsection 6a, above, for a charge no more than the cost of performing this distribution.

c) If distribution of the work is made by offering access to copy from a designated place, offer equivalent access to copy the above specified materials from the same place.

d) Verify that the user has already received a copy of these materials or that you have already sent this user a copy.

For an executable, the required form of the "work that uses the Library" must include any data and utility programs needed for reproducing the executable from it. However, as a special exception, the source code distributed need not include anything that is normally distributed (in either source or binary form) with the major components (compiler, kernel, and so on) of the operating system on

which the executable runs, unless that component itself accompanies the executable.

It may happen that this requirement contradicts the license restrictions of other proprietary libraries that do not normally accompany the operating system. Such a contradiction means you cannot use both them and the Library together in an executable that you distribute.

7. You may place library facilities that are a work based on the Library side-by-side in a single library together with other library facilities not covered by this License, and distribute such a combined library, provided that the separate distribution of the work based on the Library and of the other library facilities is otherwise permitted, and provided that you do these two things:

a) Accompany the combined library with a copy of the same work based on the Library, uncombined with any other library facilities. This must be distributed under the terms of the Sections above.

b) Give prominent notice with the combined library of the fact that part of it is a work based on the Library, and explaining where to find the accompanying uncombined form of the same work.

8. You may not copy, modify, sublicense, link with, or distribute the Library except as expressly provided under this License. Any attempt otherwise to copy, modify, sublicense, link with, or distribute the Library is void, and will automatically terminate your rights under this License. However, parties who have received copies, or rights, from you under this License will not have their licenses terminated so long as such parties remain in full compliance.

9. You are not required to accept this License, since you have not signed it. However, nothing else grants you permission to modify or distribute the Library or its derivative works. These actions are prohibited by law if you do not accept this License. Therefore, by modifying or distributing the Library (or any work based on the

Library), you indicate your acceptance of this License to do so, and all its terms and conditions for copying, distributing or modifying the Library or works based on it.

10. Each time you redistribute the Library (or any work based on the Library), the recipient automatically receives a license from the original licensor to copy, distribute, link with or modify the Library subject to these terms and conditions. You may not impose any further restrictions on the recipients' exercise of the rights granted herein. You are not responsible for enforcing compliance by third parties to this License.

11. If, as a consequence of a court judgment or allegation of patent infringement or for any other reason (not limited to patent issues), conditions are imposed on you (whether by court order, agreement or otherwise) that contradict the conditions of this License, they do not excuse you from the conditions of this License. If you cannot distribute so as to satisfy simultaneously your obligations under this License and any other pertinent obligations, then as a consequence you may not distribute the Library at all. For example, if a patent license would not permit royalty-free redistribution of the Library by all those who receive copies directly or indirectly through you, then the only way you could satisfy both it and this License would be to refrain entirely from distribution of the Library.

If any portion of this section is held invalid or unenforceable under any particular circumstance, the balance of the section is intended to apply, and the section as a whole is intended to apply in other circumstances.

It is not the purpose of this section to induce you to infringe any patents or other property right claims or to contest validity of any such claims; this section has the sole purpose of protecting the integrity of the free software distribution system which is implemented by public license practices. Many people have made generous contributions to the wide range of software distributed through that system in reliance on consistent application of that system; it is up to the author/donor to decide if he or she is willing to distribute software through any other system and a licensee cannot

impose that choice.

This section is intended to make thoroughly clear what is believed to be a consequence of the rest of this License.

12. If the distribution and/or use of the Library is restricted in certain countries either by patents or by copyrighted interfaces, the original copyright holder who places the Library under this License may add an explicit geographical distribution limitation excluding those countries, so that distribution is permitted only in or among countries not thus excluded. In such case, this License incorporates the limitation as if written in the body of this License.

13. The Free Software Foundation may publish revised and/or new versions of the Library General Public License from time to time. Such new versions will be similar in spirit to the present version, but may differ in detail to address new problems or concerns.

Each version is given a distinguishing version number. If the Library specifies a version number of this License which applies to it and "any later version", you have the option of following the terms and conditions either of that version or of any later version published by the Free Software Foundation. If the Library does not specify a license version number, you may choose any version ever published by the Free Software Foundation.

14. If you wish to incorporate parts of the Library into other free programs whose distribution conditions are incompatible with these, write to the author to ask for permission. For software which is copyrighted by the Free Software Foundation, write to the Free Software Foundation; we sometimes make exceptions for this. Our decision will be guided by the two goals of preserving the free status of all derivatives of our free software and of promoting the sharing and reuse of software generally.

NO WARRANTY

15. BECAUSE THE LIBRARY IS LICENSED FREE OF CHARGE, THERE IS NO

WARRANTY FOR THE LIBRARY, TO THE EXTENT PERMITTED BY APPLICABLE LAW. EXCEPT WHEN OTHERWISE STATED IN WRITING THE COPYRIGHT HOLDERS AND/OR OTHER PARTIES PROVIDE THE LIBRARY "AS IS" WITHOUT WARRANTY OF ANY KIND, EITHER EXPRESSED OR IMPLIED, INCLUDING, BUT NOT LIMITED TO, THE IMPLIED WARRANTIES OF MERCHANTABILITY AND FITNESS FOR A PARTICULAR PURPOSE. THE ENTIRE RISK AS TO THE QUALITY AND PERFORMANCE OF THE LIBRARY IS WITH YOU. SHOULD THE LIBRARY PROVE DEFECTIVE, YOU ASSUME THE COST OF ALL NECESSARY SERVICING, REPAIR OR CORRECTION.

16. IN NO EVENT UNLESS REQUIRED BY APPLICABLE LAW OR AGREED TO IN WRITING WILL ANY COPYRIGHT HOLDER, OR ANY OTHER PARTY WHO MAY MODIFY AND/OR REDISTRIBUTE THE LIBRARY AS PERMITTED ABOVE, BE LIABLE TO YOU FOR DAMAGES, INCLUDING ANY GENERAL, SPECIAL, INCIDENTAL OR CONSEQUENTIAL DAMAGES ARISING OUT OF THE USE OR INABILITY TO USE THE LIBRARY (INCLUDING BUT NOT LIMITED TO LOSS OF DATA OR DATA BEING RENDERED INACCURATE OR LOSSES SUSTAINED BY YOU OR THIRD PARTIES OR A FAILURE OF THE LIBRARY TO OPERATE WITH ANY OTHER SOFTWARE), EVEN IF SUCH HOLDER OR OTHER PARTY HAS BEEN ADVISED OF THE POSSIBILITY OF SUCH DAMAGES.

END OF TERMS AND CONDITIONS

How to Apply These Terms to Your New Libraries

If you develop a new library, and you want it to be of the greatest possible use to the public, we recommend making it free software that everyone can redistribute and change. You can do so by permitting redistribution under these terms (or, alternatively, under the terms of the ordinary General Public License).

To apply these terms, attach the following notices to the library. It is safest to attach them to the start of each source file to most effectively convey the exclusion of warranty; and each file should have at least the "copyright" line and a pointer to where the full notice is found.

<one line to give the library's name and a brief idea of what it does.>

Copyright (C) <year> <name of author>

This library is free software; you can redistribute it and/or modify it under the terms of the GNU Library General Public License as published by the Free Software Foundation; either version 2 of the License, or (at your option) any later version.

This library is distributed in the hope that it will be useful, but WITHOUT ANY WARRANTY; without even the implied warranty of MERCHANTABILITY or FITNESS FOR A PARTICULAR PURPOSE. See the GNU Library General Public License for more details.

You should have received a copy of the GNU Library General Public License along with this library; if not, write to the Free Software Foundation, Inc., 59 Temple Place - Suite 330, Boston, MA 02111-1307 USA.

Also add information on how to contact you by electronic and paper mail.

You should also get your employer (if you work as a programmer) or your school, if any, to sign a "copyright disclaimer" for the library, if necessary. Here is a sample; alter the names:

Yoyodyne, Inc., hereby disclaims all copyright interest in the library 'Frob' (a library for tweaking knobs) written by James Random Hacker.

<signature of Ty Coon>, 1 April 1990
Ty Coon, President of Vice

That's all there is to it!

Copyright (c) 1997-2008 University of Cambridge.

↑ Redistribution and use in source and binary forms, with or without modification, are permitted provided that the following conditions are met:

- * Redistributions of source code must retain the above copyright notice, this list of conditions and the following disclaimer.
- * Redistributions in binary form must reproduce the above copyright

notice, this list of conditions and the following disclaimer in the documentation and/or other materials provided with the distribution.

- * Neither the name of the University of Cambridge nor the name of Google Inc. nor the names of their contributors may be used to endorse or promote products derived from this software without specific prior written permission.

THIS SOFTWARE IS PROVIDED BY THE COPYRIGHT HOLDERS AND CONTRIBUTORS "AS IS" AND ANY EXPRESS OR IMPLIED WARRANTIES, INCLUDING, BUT NOT LIMITED TO, THE IMPLIED WARRANTIES OF MERCHANTABILITY AND FITNESS FOR A PARTICULAR PURPOSE ARE DISCLAIMED. IN NO EVENT SHALL THE COPYRIGHT OWNER OR CONTRIBUTORS BE LIABLE FOR ANY DIRECT, INDIRECT, INCIDENTAL, SPECIAL, EXEMPLARY, OR CONSEQUENTIAL DAMAGES (INCLUDING, BUT NOT LIMITED TO, PROCUREMENT OF SUBSTITUTE GOODS OR SERVICES; LOSS OF USE, DATA, OR PROFITS; OR BUSINESS INTERRUPTION) HOWEVER CAUSED AND ON ANY THEORY OF LIABILITY, WHETHER IN CONTRACT, STRICT LIABILITY, OR TORT (INCLUDING NEGLIGENCE OR OTHERWISE) ARISING IN ANY WAY OUT OF THE USE OF THIS SOFTWARE, EVEN IF ADVISED OF THE POSSIBILITY OF SUCH DAMAGE.

* Copyright (C) 2007 Red Hat Inc.

*

- * Permission is hereby granted, free of charge, to any person
- * obtaining a copy of this software and associated documentation files
- * (the "Software"), to deal in the Software [↑](#) without restriction,
- * including without limitation the rights to use, copy, modify, merge,
- * publish, distribute, sublicense, and/or sell copies of the Software,
- * and to permit persons to whom the Software is furnished to do so,
- * subject to the following conditions:

*

- * The above copyright notice and this permission notice shall be
- * included in all copies or substantial portions of the Software.

*

- * THE SOFTWARE IS PROVIDED "AS IS", WITHOUT WARRANTY OF ANY KIND,
- * EXPRESS OR IMPLIED, INCLUDING BUT NOT LIMITED TO THE WARRANTIES OF
- * MERCHANTABILITY, FITNESS FOR A PARTICULAR PURPOSE AND
- * NONINFRINGEMENT. IN NO EVENT SHALL THE AUTHORS OR COPYRIGHT HOLDERS
- * BE LIABLE FOR ANY CLAIM, DAMAGES OR OTHER LIABILITY, WHETHER IN AN

* ACTION OF CONTRACT, TORT OR OTHERWISE, ARISING FROM, OUT OF OR IN
* CONNECTION WITH THE SOFTWARE OR THE USE OR OTHER DEALINGS IN THE
* SOFTWARE.



Function Guide for Software Registration and Update

User's Guide

Contents

Available Functions	2
Installing the System Options/MEAP Applications	4
Installing by Connecting This Printer to an Outside Network (Delivery)	6
Installing by Not Connecting This Printer to an Outside Network (Manual)	9
Downloading the Manuals and Related Software	15
Updating the Firmware	17
Managing the Register/Update Software Function	28
Using This Guide	32
Operating Environment of This Guide	33
Screen Layout of This Guide	34
Top Page	35
Topic Page	36
Site Map	37
Search Method	38
Viewing This Guide	39
Disclaimer	41
Trademarks	43

Available Functions

Available Functions 2

Available Functions

OY1C-000

Installing the System Options/MEAP Applications

Using the Register/Update Software function, you can install the System Options/MEAP Applications to the printer. You can use this function from both the touch panel display and the computer (Remote UI).

Installing by Connecting This Printer to an Outside Network

You can install the System Options/MEAP Applications by accessing the delivery server from this printer.

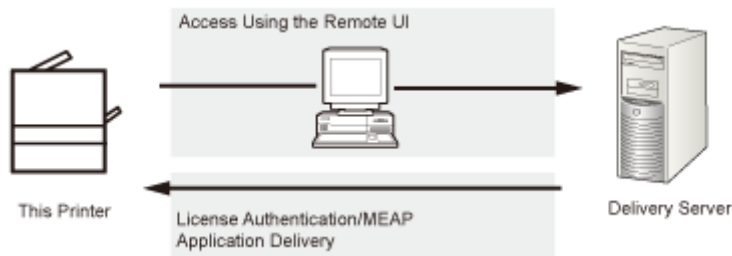

Installing by Not Connecting This Printer to an Outside Network

You can install the System Options/MEAP Applications by using the license file/license key that you obtained from the License Management System.

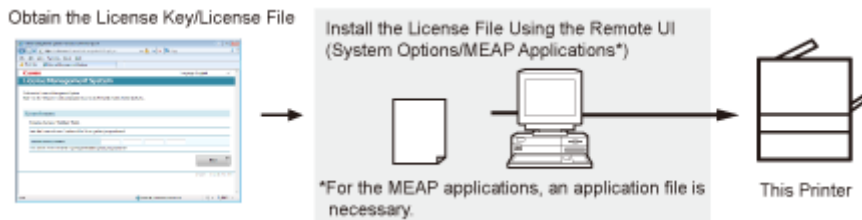

Updating the Firmware

Using the Register/Update Software function, you can update the firmware of the printer to the most recent version. You can use this function from the computer (Remote UI).

Updating by Connecting This Printer to an Outside Network

You can update the firmware by accessing the delivery server from this printer.

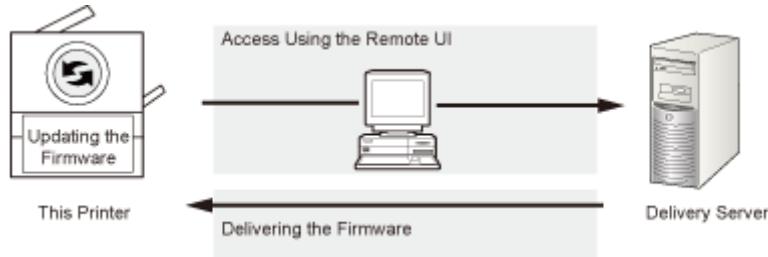

Installing the System Options/MEAP Applications

Installing the System Options/MEAP Applications	4
Installing by Connecting This Printer to an Outside Network (Delivery)	6
Installing by Not Connecting This Printer to an Outside Network (Manual)	9
Downloading the Manuals and Related Software	15

Installing the System Options/MEAP Applications

0Y1C-001

The procedures to install the system options or MEAP applications on the printer differ, depending on whether the printer is connected or not to an outside network. Select the procedure that matches your conditions using the references below.

Installing by Connecting this Printer to an Outside Network

Install from the Remote UI.

 **NOTE**

Communication test
To check that the transmission with the delivery server is properly operating, if necessary, perform a communication test before installation.

 **" Testing Communication Using the Remote UI(P. 29) "**



Installing by Not Connecting this Printer to an Outside Network

Installing System Options

Install using one of the following procedures.

 **NOTE**

If you install multiple system options
We recommend that you install from the Remote UI.

Procedure	Necessary Steps	Reference Page
Using the Remote UI to install	1. Obtain the license file from the License Management System	 " Obtaining the License File(P. 9) "
	2. Install the license file using the Remote UI	 " Installing the System Options Using the Remote UI(P. 9) "

Installing MEAP Applications

Use the following procedure to install.

Procedure	Necessary Steps	Reference Page
Using the Remote UI to install	1. Obtain the license file from the License Management System	 " Obtaining the License File(P. 9) "

Installing the System Options/MEAP Applications

Procedure	Necessary Steps	Reference Page
	Install the license file and 2. application file using the Remote UI	▶ " Installing the MEAP Applications Using the Remote UI(P. 11) "
	3. Start the MEAP applications from SMS	▶ " Starting the MEAP Applications(P. 13) "

Installing by Connecting This Printer to an Outside Network (Delivery)

OY1C-002

If the printer is connected to an outside network, you can install the system options and MEAP applications from the Remote UI by linking with the delivery server.

NOTE

Preparing a license access number certificate

Make sure that the license access number that is included with the package is available.

1 Start the Remote UI, and then log in as Administrator.

 " e-Manual "

2 From the top page of the Remote UI, click [Settings/Registration] → [License/Other] → [Register/Update Software].

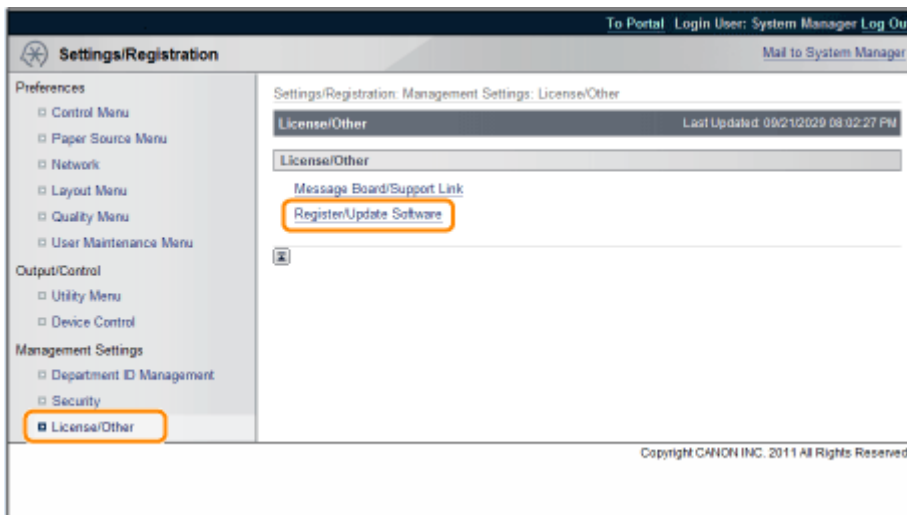

3 Click [Delivered Installation].

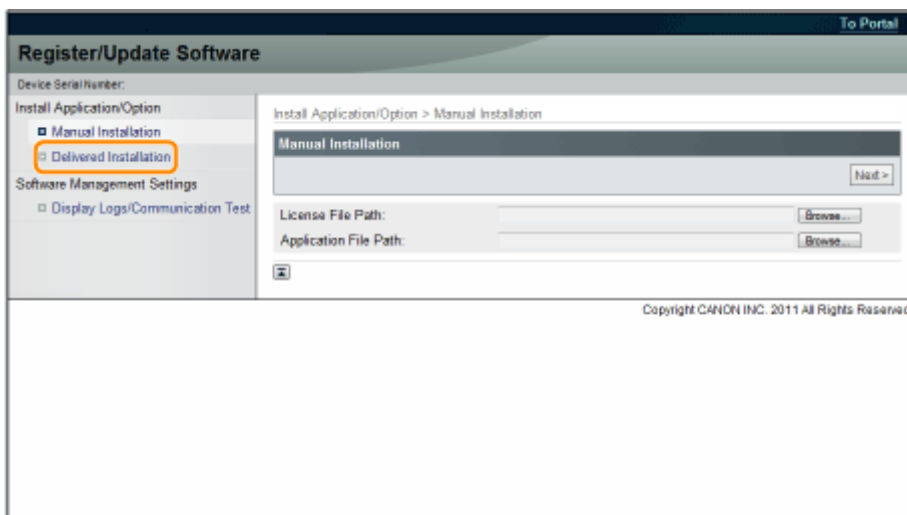

4 Enter the license access number → click [Next].

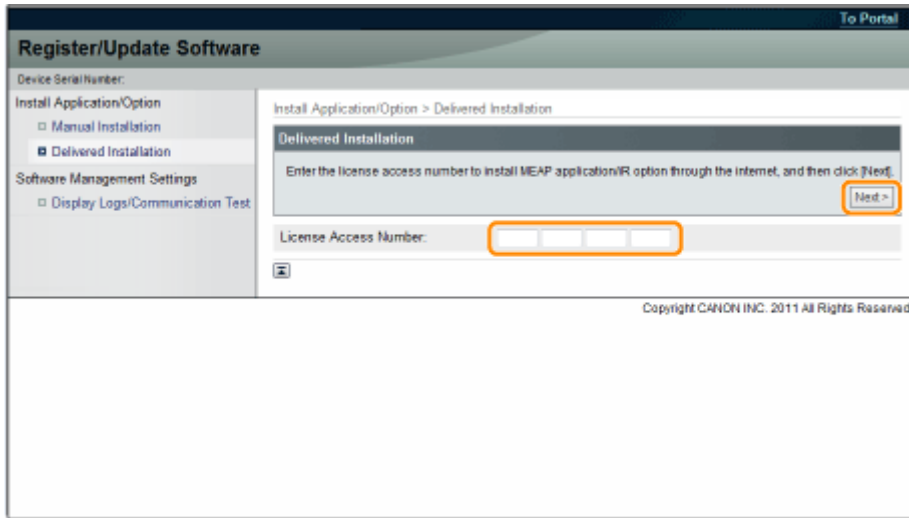

Once the license access number is confirmed after contacting the delivery server, information for the system options/MEAP applications you can install are displayed.

5 Select the system options and MEAP applications → click [Start Installation].

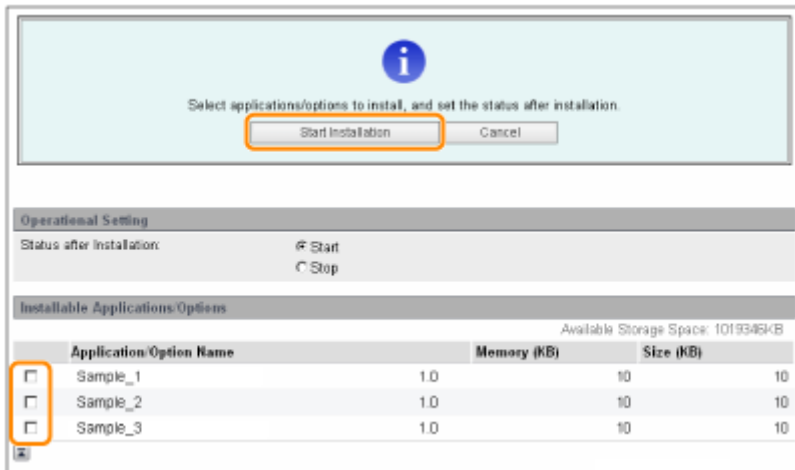

Status after Installation:

Start: Starts the installed MEAP applications.

Stop: Stops the installed MEAP applications.

IMPORTANT

If [Stop] is selected when installing MEAP applications

You need to start the application before using the MEAP application.

▶ " Function Guide for MEAP Application Management "

If the agreement screen is displayed, read the agreement. If you abide with the agreement, click [Accept].

6 Check the Installation Result page.

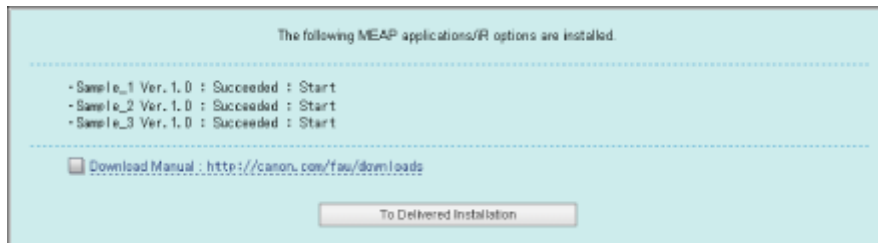

When the installation of the system options is completed, the message <Restart the device.> appears. Restart the printer to enable the function.

To return to the Delivered Installation screen, click [To Delivered Installation].

NOTE

The manual for system options/MEAP applications

You can download the manual for the installed system options/MEAP applications by accessing the URL for the manual download site displayed on the Installation Result screen.

 " Downloading the Manuals and Related Software(P. 15) "

Installing by Not Connecting This Printer to an Outside Network (Manual)

0Y1C-003

This section describes how to install the system options and MEAP applications without connecting the printer to an outside network.

Obtaining the License File

Obtain the license file.

License file: Obtain the license file when installing the system options/MEAP applications using the Remote UI.



NOTE

Preparing a license access number certificate

Make sure that the license access number that is included with the package is available.

License access number is not printed on the package of the MEAP application

If the license access number is not printed on the package of the MEAP application you are using, the license file is issued by the distributor of the MEAP application. You do not need to obtain the license file explained in this section. For more information, see the manual for each MEAP application.

1 Check the management number you need to obtain the license file.

To obtain the license file, the following management number is required.

- License Access Number: Check the license access number certificate.
- Device Serial Number: You can check this number from the Utility menu of the operation panel.

" e-Manual "

2 Access <http://www.canon.com/lms/license/>.

3 Follow the instructions on the screen and obtain the license file.

Next, install the system options or the MEAP applications.

Installing the System Options Using the Remote UI

You can install the system options to the printer using the Remote UI.

1 Start the Remote UI, and then log in as Administrator.

" e-Manual "

2 From the top page of the Remote UI, click [Settings/Registration] → [License/Other] → [Register/Update Software].

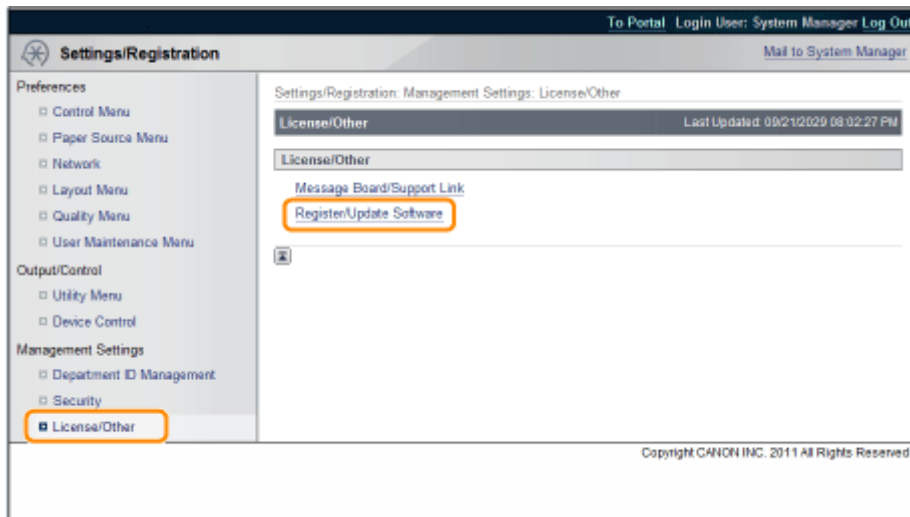

3 Click [Manual Installation].

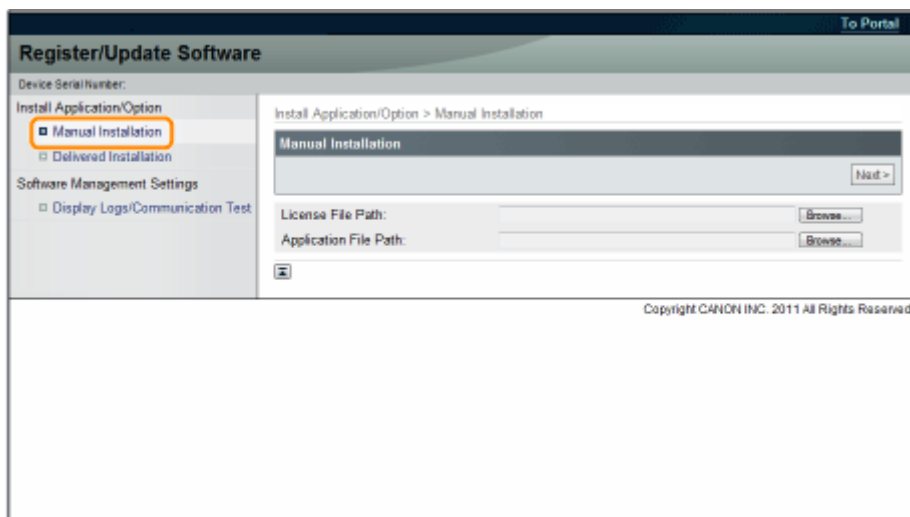

4 Click [Browse...] → select the license file to install → click [Next].

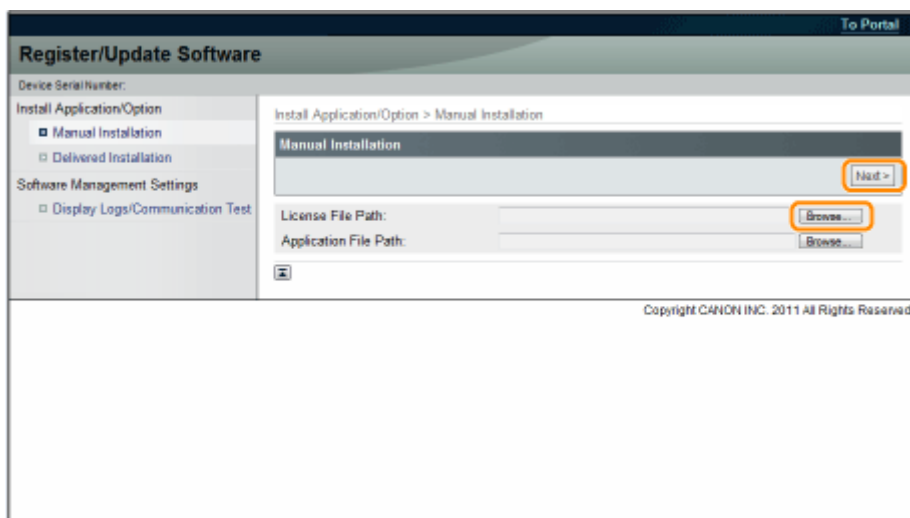

File extensions:

License File: A file with the [lic] extension.

5 Check the contents that will be installed on the confirmation screen → click [Install].

Installing the MEAP Applications Using the Remote UI

You can install the MEAP applications to the printer using the Remote UI.

NOTE

The number of MEAP applications that can be installed

You can install up to eight applications.

For details on MEAP applications

There may be other system requirements for installation, depending on the MEAP applications. For instructions on settings, see the manual provided with the MEAP application.

1 Start the Remote UI, and then log in as Administrator.

 " e-Manual "

2 From the top page of the Remote UI, click [Settings/Registration] → [License/Other] → [Register/Update Software].

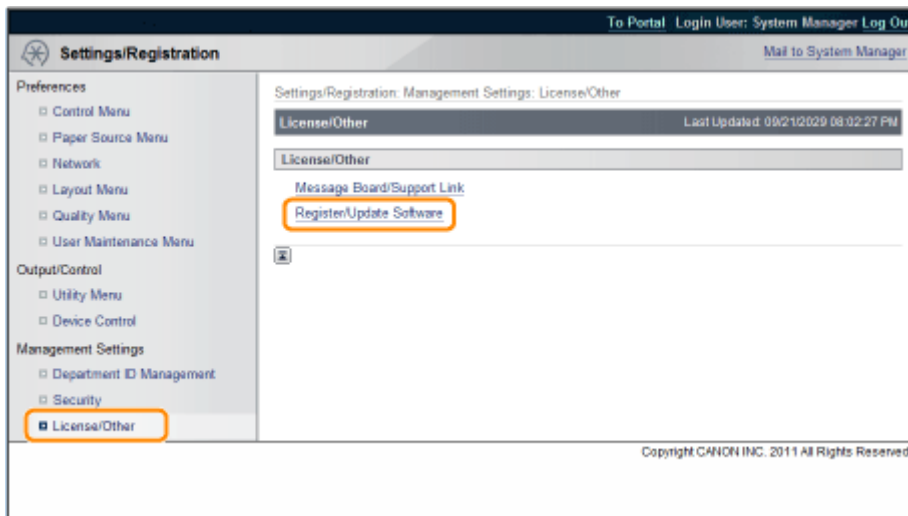

3 Click [Manual Installation].

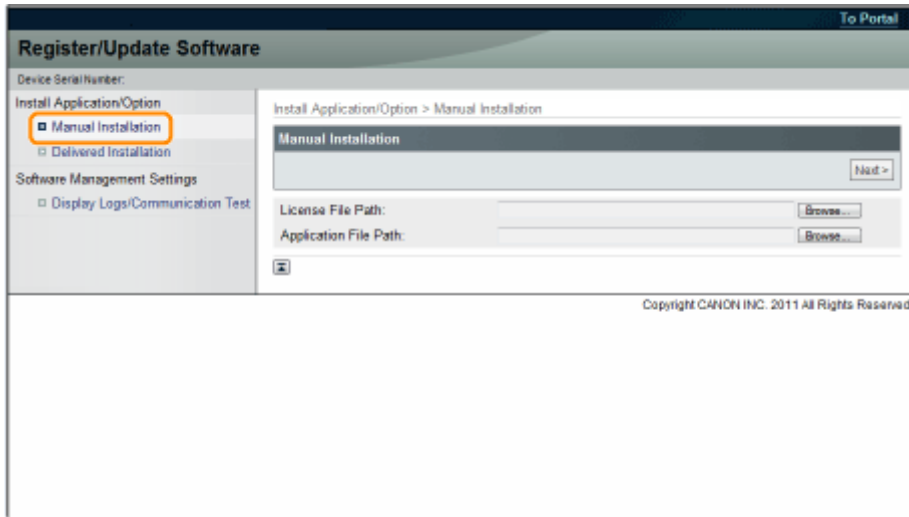

4 Click [Browse...] → select the license file and the application file to install → click [Next].

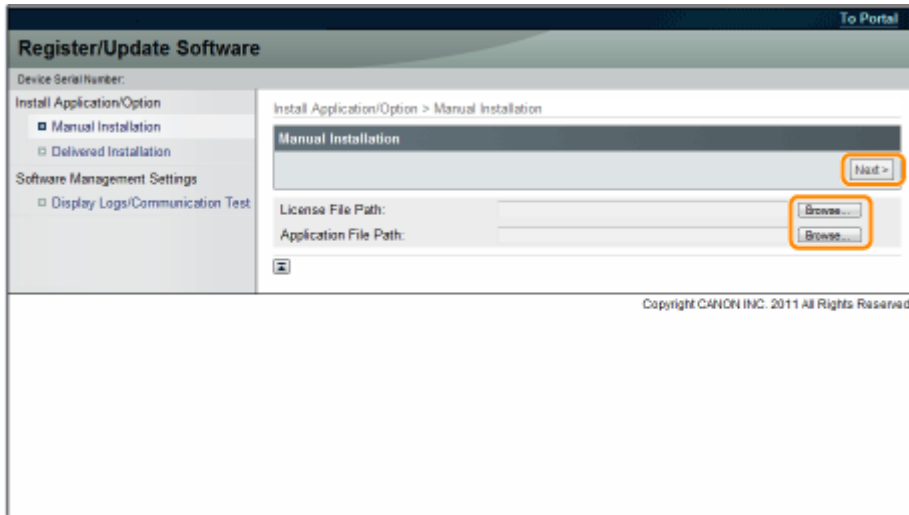

File extensions:

License File: A file with the [lic] extension.

Application File: A file with the [jar] extension.

! IMPORTANT

When you install MEAP applications

- You cannot install license files only.
- When installing the MEAP application, make sure you specify the license file. You cannot install the MEAP application without specifying the license file.

5 Confirm the information displayed on the install confirmation page → click [Yes].

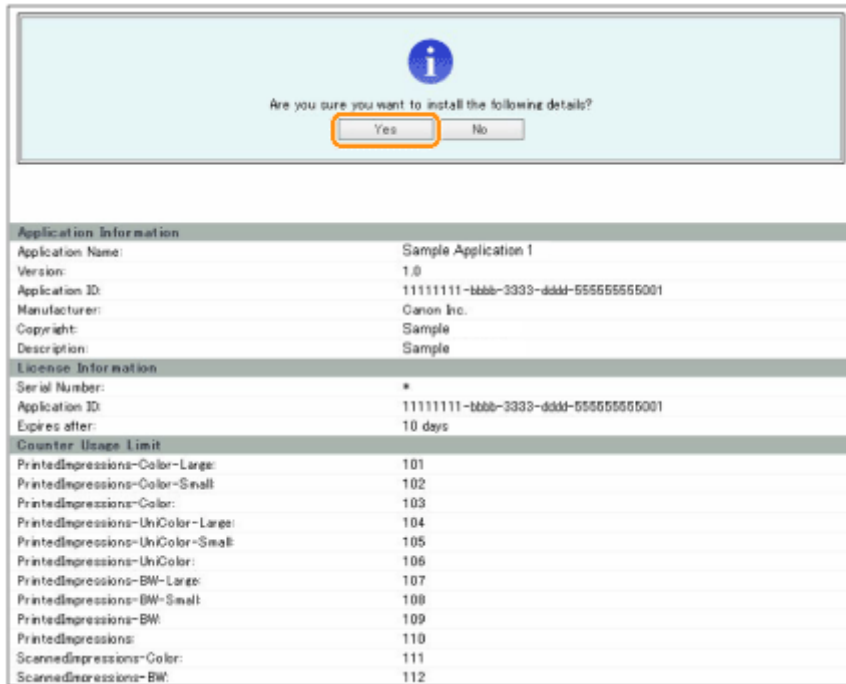

Depending on the MEAP application, a software license agreement screen may be displayed. Confirm the information displayed on the screen → click [OK].

If you are installing a new MEAP application, the following information is displayed on the screen.

- Application Information
- License Information

The following information is displayed when you overwrite a MEAP application.

- Current Application Information
- Application Information after Overwrite

Installation will start after the message <Installing... Please wait.> is displayed again. After the installation, click [To Manual Installation] to display the Manual Installation screen.

 **IMPORTANT**

To use MEAP applications

To use the installed MEAP application, you must start the MEAP application.

 **" Function Guide for MEAP Application Management "**

Starting the MEAP Applications

This section describes how to start the installed MEAP application from the SMS screen.

 **NOTE**

Details on SMS

For details on SMS, see **" Function Guide for MEAP Application Management ."**

- 1 From the top page of the SMS, click [MEAP Application Management].**

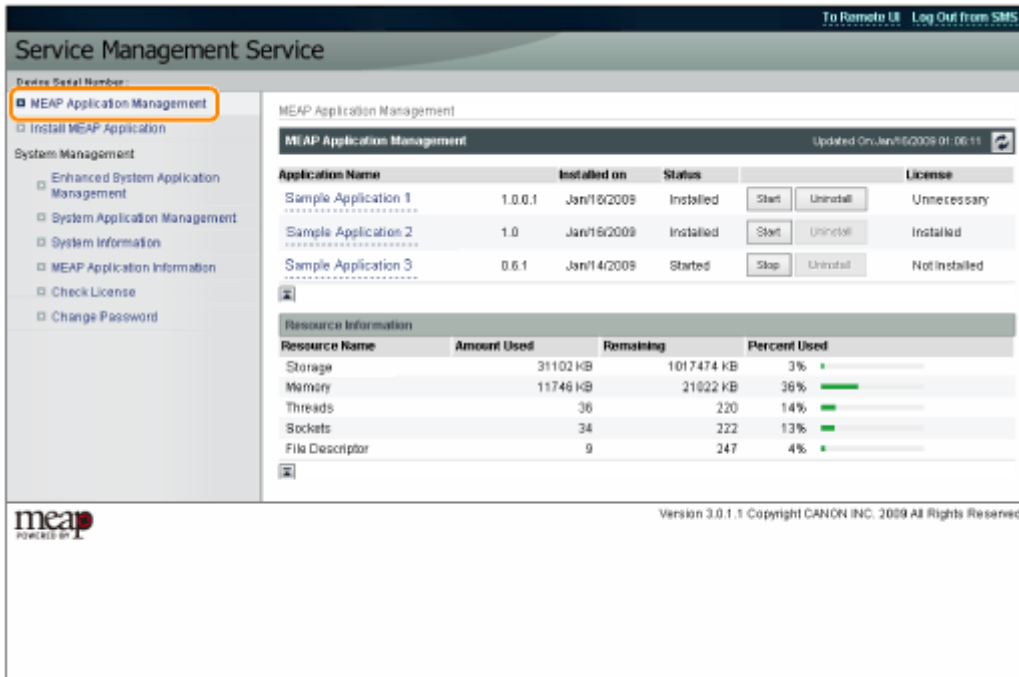

2 Select the application you want to start → click [Start].

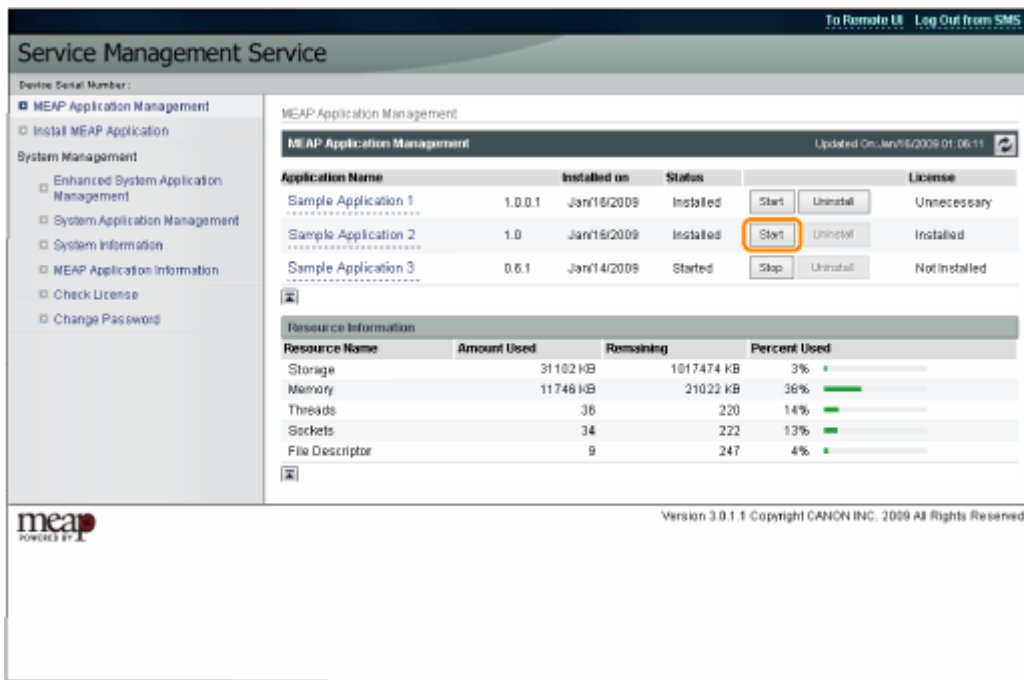

Downloading the Manuals and Related Software

0Y1C-004

You can download the manuals for the installed system options/MEAP applications and their related software from the following URL.

<http://canon.com/fau/downloads>

 **NOTE**

- Make sure that the license access number that is included with the package is available.
- If you installed from the Remote UI, you can jump to the above URL from the link displayed on the Installation Result screen. If you do so, the license access number is entered automatically.

- 1 Start the Web browser on your computer.**
- 2 Enter the URL in [Address].**
- 3 After entering the license access number, follow the instructions on the screen to download the manuals and related software.**

If software is downloaded, refer to the manual of that software to install.

Updating the Firmware

Updating the Firmware 17

Updating the Firmware

OY1C-005

Update from the Remote UI.

NOTE

Communication test

To check that the transmission with the delivery server is properly operating, if necessary, perform a communication test before installation.

 " **Testing Communication Using the Remote UI(P. 29)** "

Updating by Connecting This Printer to an Outside Network

If the printer is connected to an outside network, you can update to a most recent firmware by linking with the delivery server.

IMPORTANT

Estimated time required to apply firmware

The time required to apply the downloaded firmware is approximately 20 minutes. This operation may take more time depending on the system configuration and network environment of your printer.

Checking the New Firmware/Specifying the Delivery Settings

You can check the new firmware that is applicable with the printer and specify the delivery settings.

1 Start the Remote UI, and then log in as Administrator.

 " e-Manual "

2 From the top page of the Remote UI, click [Settings/Registration] → [License/Other] → [Register/Update Software].

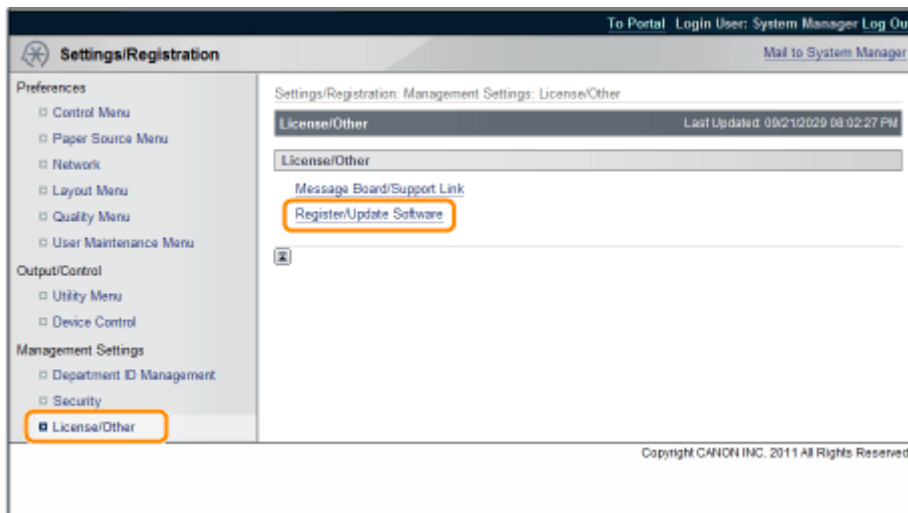

3 Click [Delivered Update].

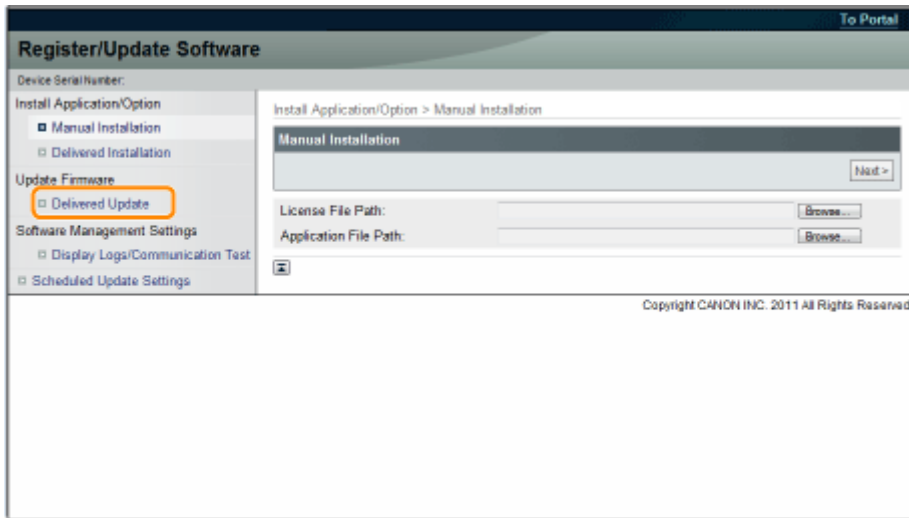

4 Click [Confirm New Firmware].

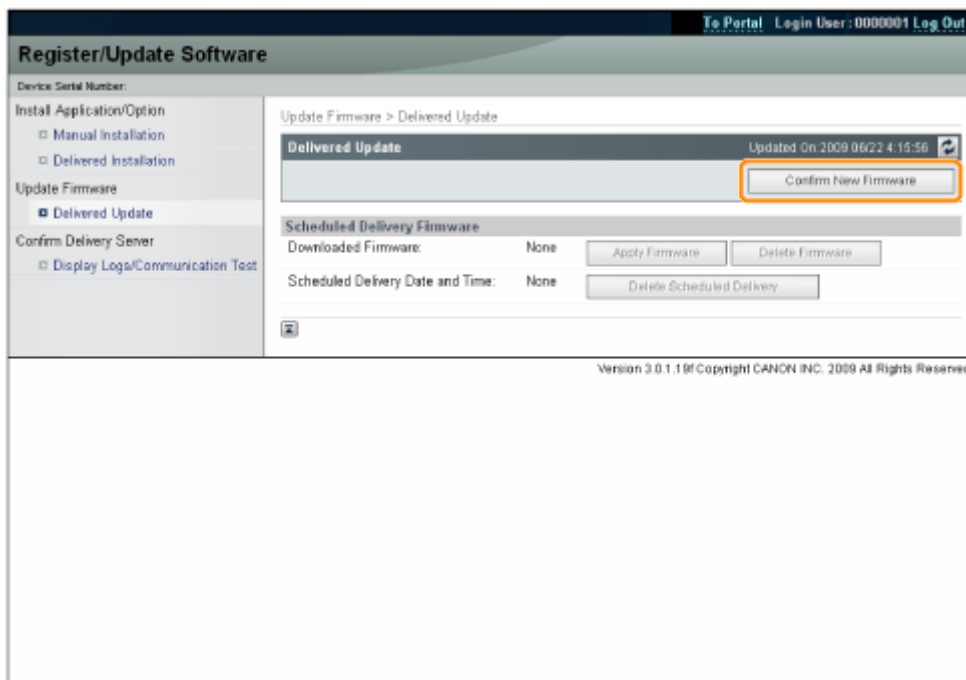

Contact the delivery server for information on whether an applicable new firmware is available or not.

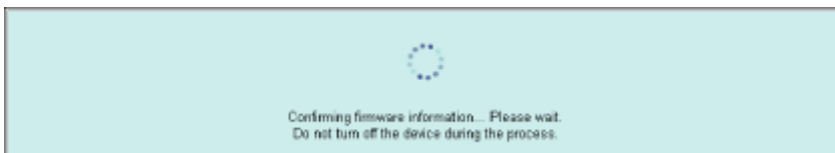

5 Verify the displayed information → specify necessary settings → click [Execute].

If the agreement screen is displayed, read the agreement. If you abide with the agreement, press [I Accept].

Updating the Firmware

Select necessary languages and set the delivery settings.
If you set [Deliver now] for the delivery schedule, and set [Auto] for the timing to apply, the applicable firmware will be delivered and updated automatically, and the device will restart.

Execute Cancel

Firmware
Current Version: V00.00 ENGLISH
Applicable Firmware: V00.10 ENGLISH

Release Note:
Sample
Sample
Sample
Sample

Select Language
Language Name
FR2

Delivery Settings
Delivery Schedule:
 Deliver now
 Deliver at specified date and time
Year: 2009
Month: 0
Date: 14
Time: 0 0 +2
Timing to Apply:
 Auto
 Manual
Deliver Update:
 On
 Off
E-Mail Address:
Comments:

Details of each item are shown below.

- **Firmware:**

Current Version: Displays the version of the current firmware.

Applicable Firmware: Displays the new firmware that is applicable with the printer.

Release Note: If the new firmware has a release note, that information is displayed.

Delivery Settings:

- **Delivery Schedule:** Click "Deliver now" or "Deliver at specified date and time."

[Deliver now]: Downloads the firmware after the delivery setting is specified.

[Deliver at specified date and time]: Select the date/time (year, month, date, and time) to download the firmware from the drop-down list.

- **Timing to Apply:** Click [Auto] or [Manual].

[Auto]: The firmware is automatically applied after the download of the firmware is completed.

[Manual]: Only downloads the firmware. To apply the downloaded firmware, set from [Apply Firmware].

- **Deliver Update:** Click [On] or [Off].

[On]: Downloads only the difference between the current firmware and the new firmware.

[Off]: Downloads the new firmware entirely.

- **E-Mail Address:** Enter the e-mail address of the administrator. You can receive e-mails regarding the update status that is sent from the delivery server.
- **Comments:** Enter the comment that will automatically be added to the e-mail. If the model name is entered, you can identify which device status the e-mail is about.

 NOTE

Delivery Schedule and Timing to Apply

- When the Delivery Schedule is set to [Deliver now] and the Timing to Apply is set to [Auto]
The firmware is applied after the new firmware is downloaded from the delivery server. When the application is completed, the printer automatically restarts.

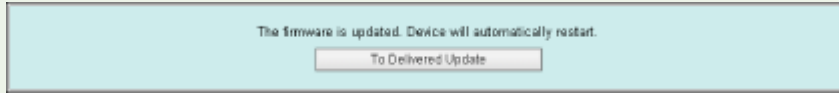

- When the Delivery Schedule is set to [Deliver now] and the Timing to Apply is set to [Manual]
The new firmware is downloaded.



- When the Delivery Schedule is set to [Deliver at specified date and time]
The scheduled delivery is set to the specified date/time.

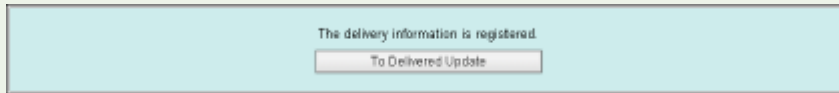

Applying the Downloaded Firmware

You can apply the downloaded firmware to the printer.

 NOTE

If the Timing to Apply in Delivery Settings is set to [Auto], this step is not necessary.

1 Start the Remote UI, and then log in as Administrator.

 " e-Manual "

2 From the top page of the Remote UI, click [Settings/Registration] → [License/Other] → [Register/Update Software].

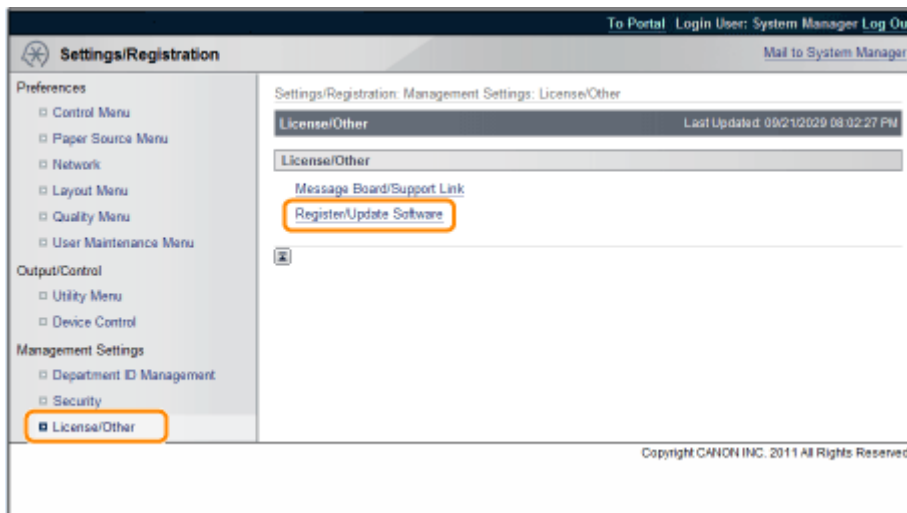

3 Click [Delivered Update].

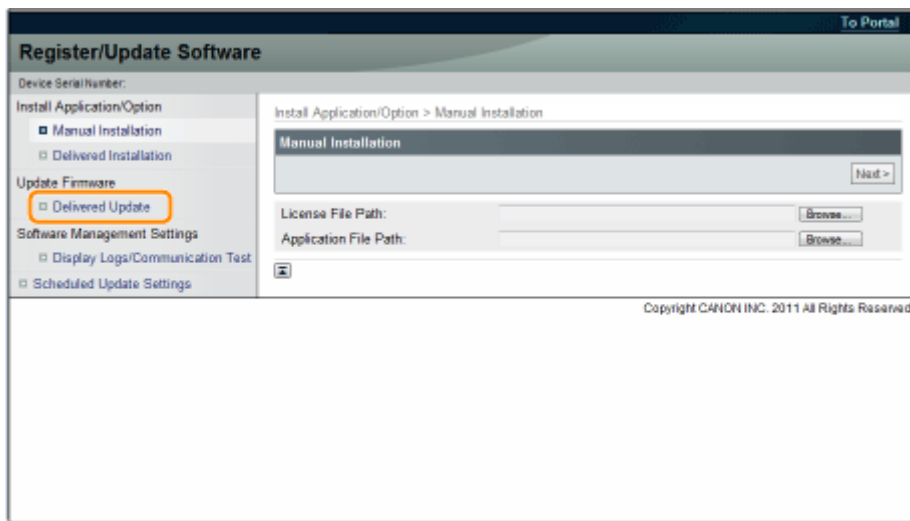

4 Click [Apply Firmware].

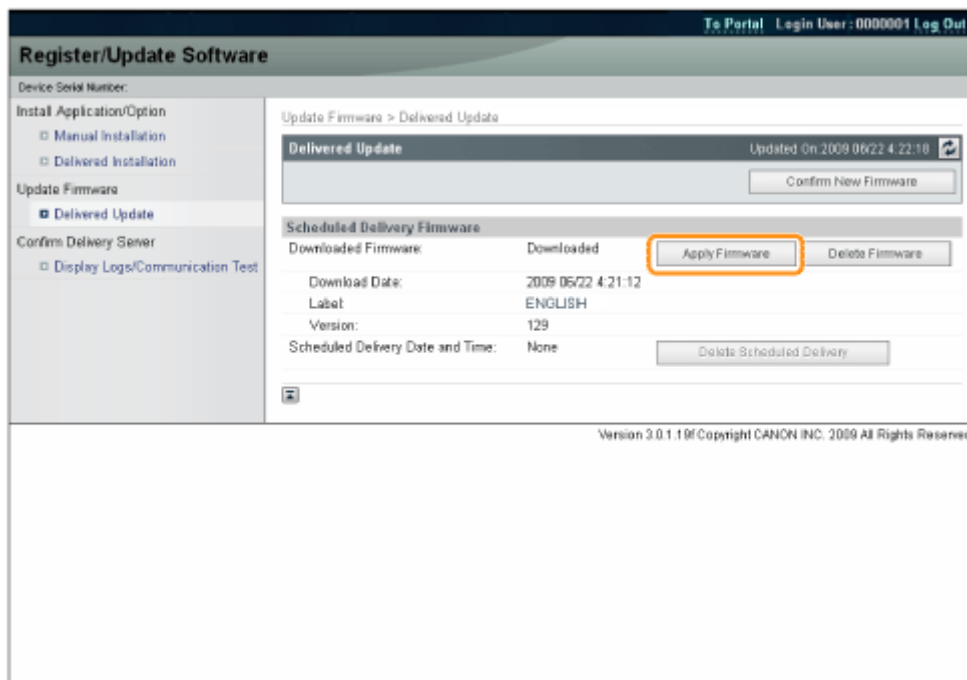

5 Confirm the firmware to apply → click [Yes].

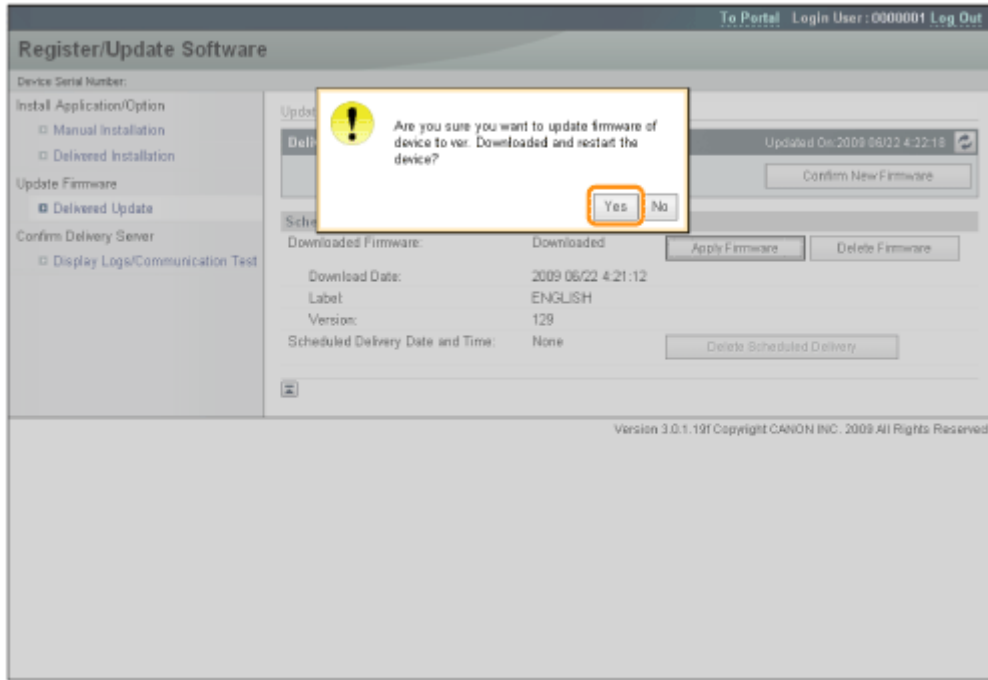

The new firmware is applied to the printer. When the application is completed, the printer automatically restarts.

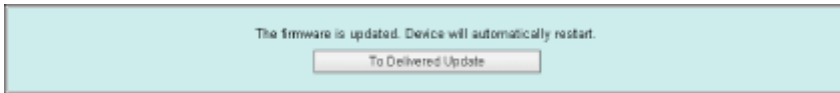

Deleting the Downloaded Firmware

You can delete the downloaded firmware.

1 Start the Remote UI, and then log in as Administrator.

▶ " e-Manual "

2 From the top page of the Remote UI, click [Settings/Registration] → [License/Other] → [Register/Update Software].

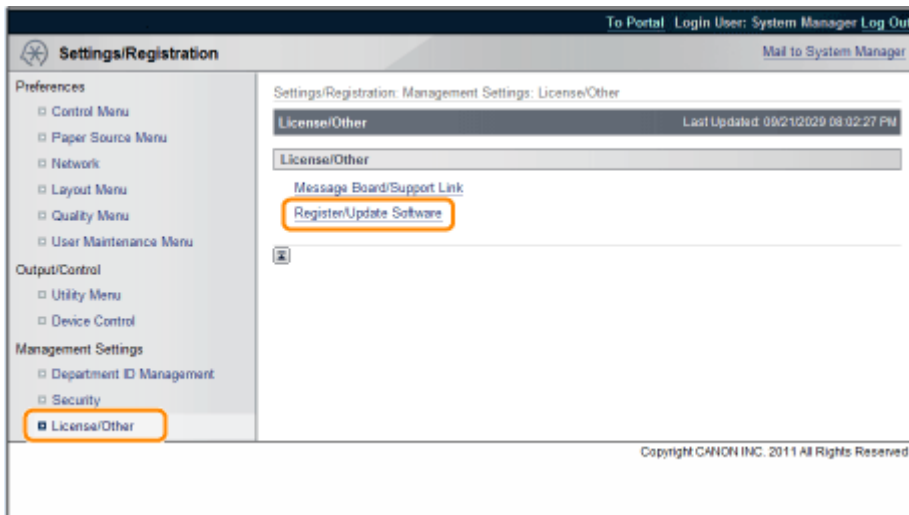

3 Click [Delivered Update].

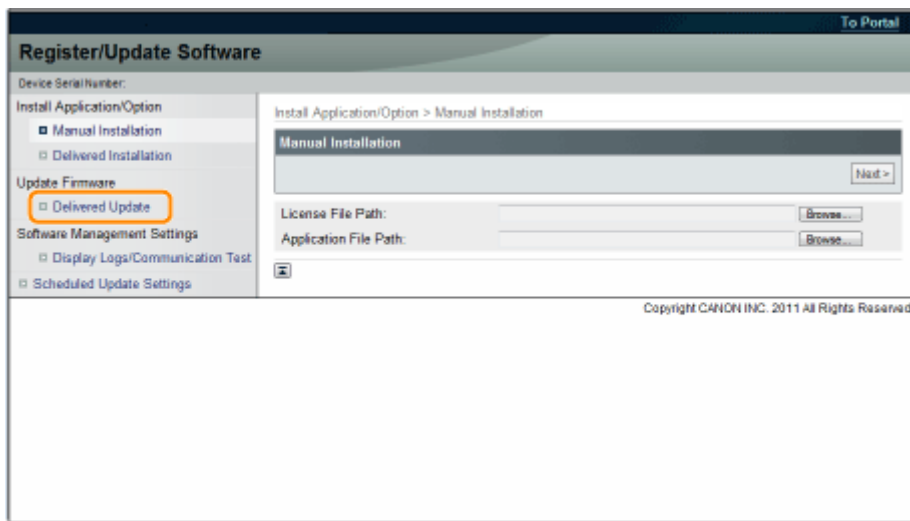

4 Click [Delete Firmware].

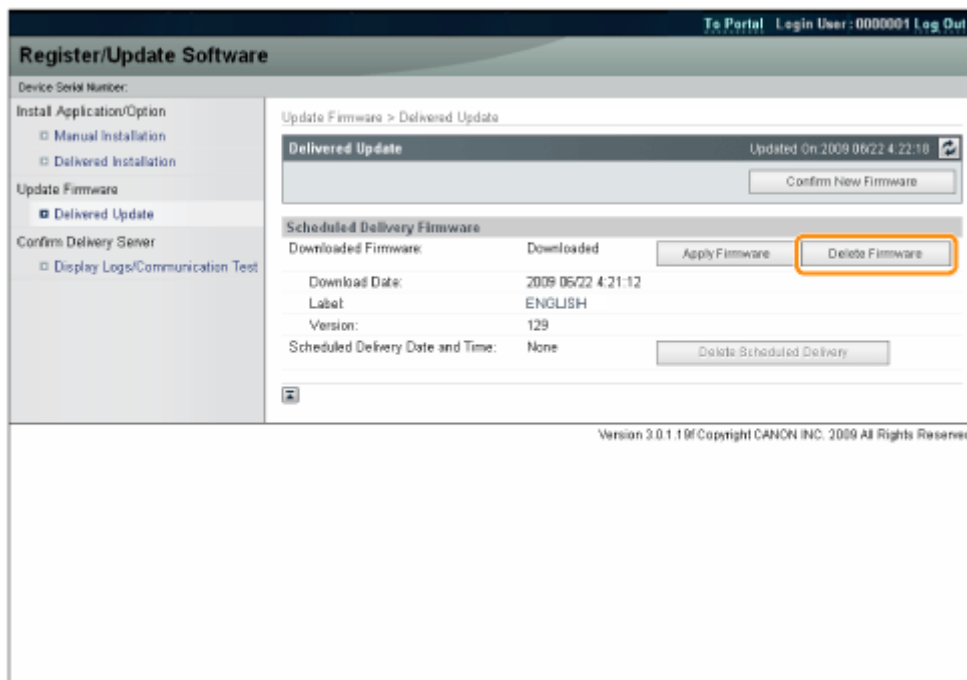

5 Confirm the firmware to delete → click [Yes].

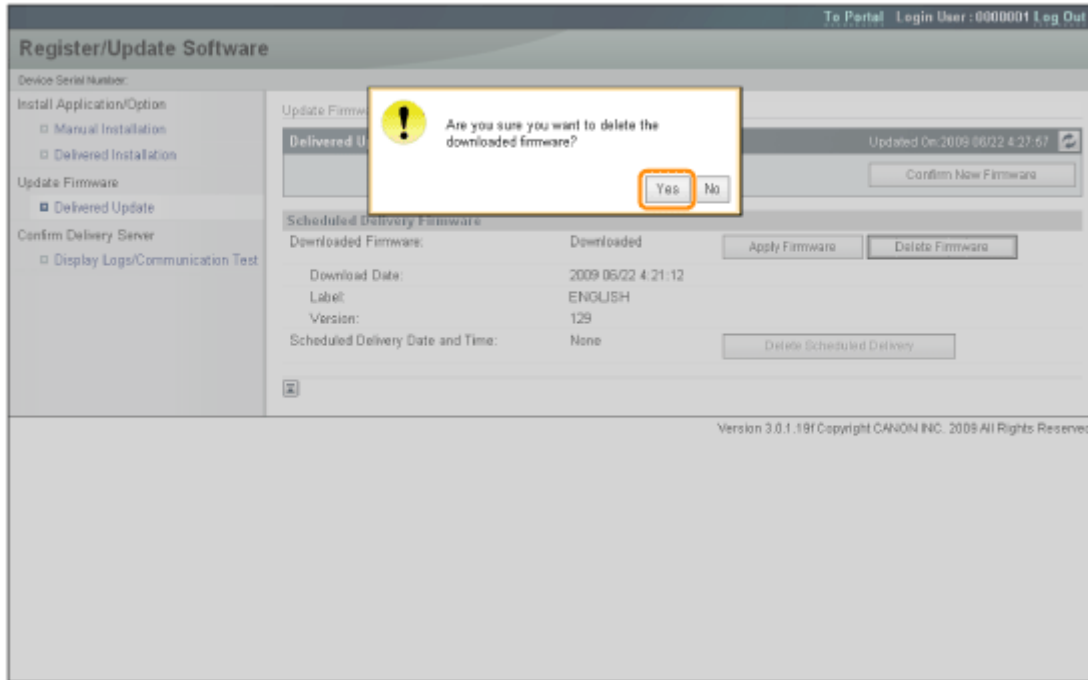

The firmware is deleted.

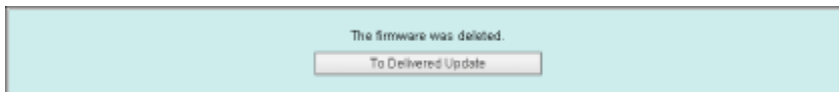

Deleting the Scheduled Delivery

You can delete the scheduled delivery of the firmware.

- 1 Start the Remote UI, and then log in as Administrator.
 - ▶ " e-Manual "
- 2 From the top page of the Remote UI, click [Settings/Registration] → [License/Other] → [Register/Update Software].

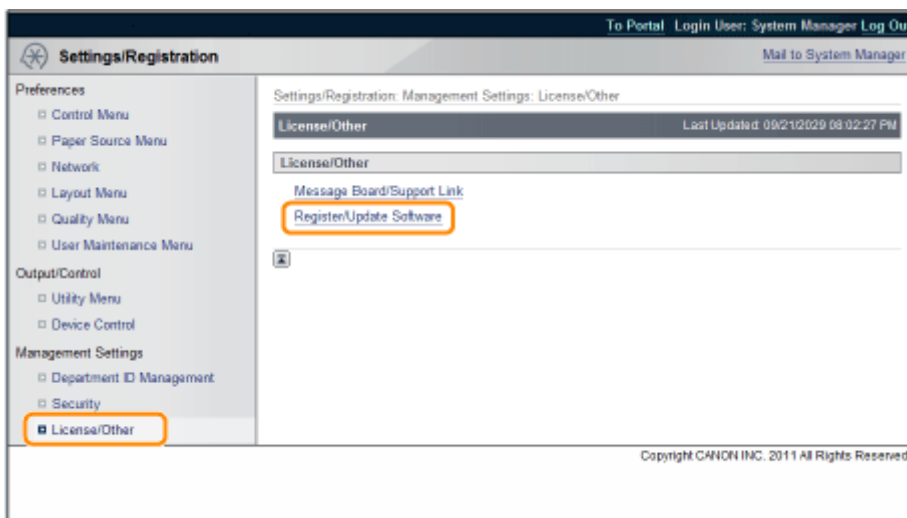

- 3 Click [Delivered Update].

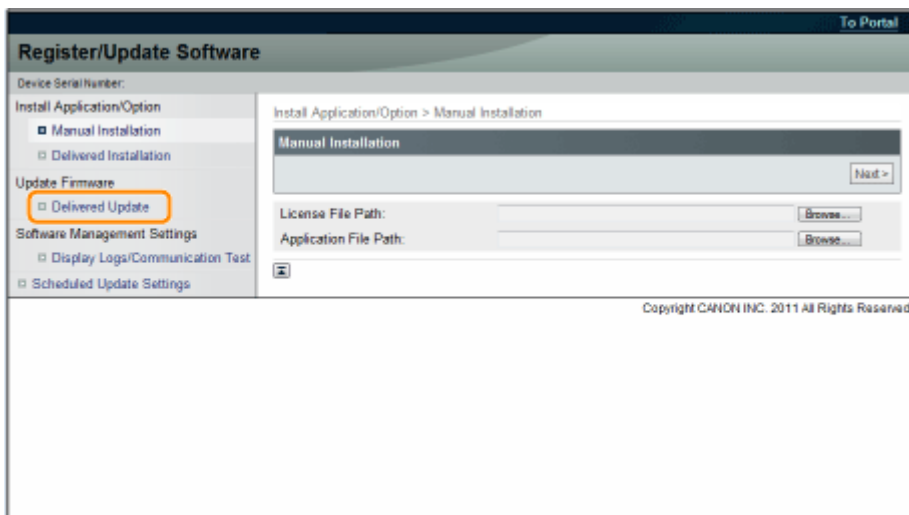

4 Click [Delete Scheduled Delivery].

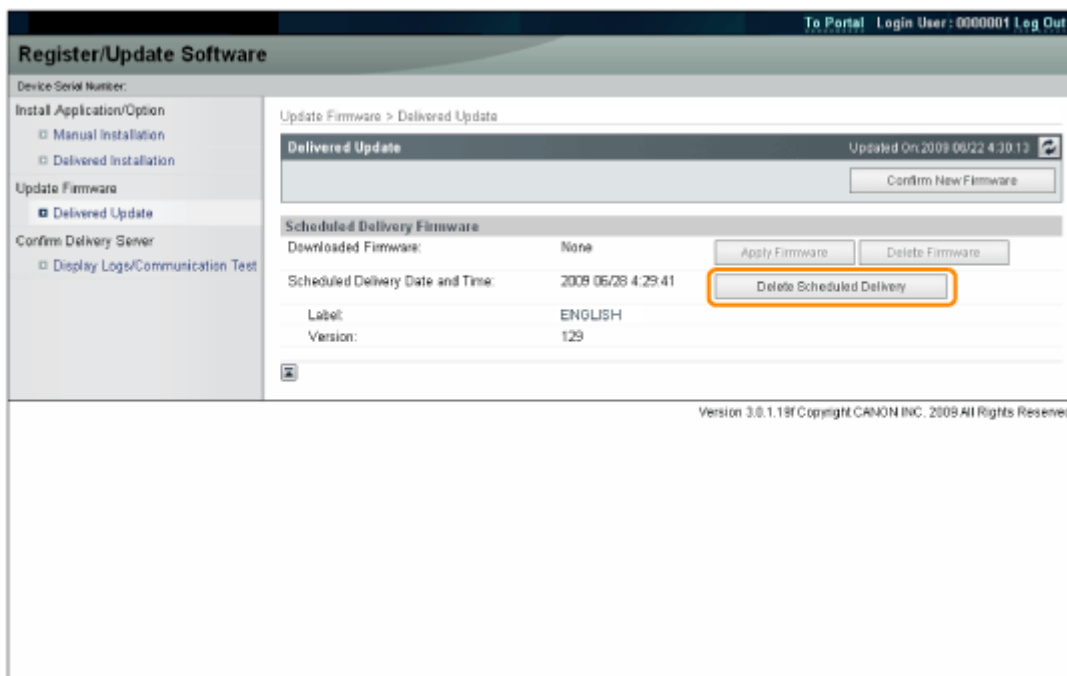

5 Confirm the information of the scheduled delivery → click [Yes].

Updating the Firmware

The screenshot shows the 'Register/Update Software' web interface. A confirmation dialog box is overlaid on the page, asking 'Are you sure you want to delete the scheduled delivery?'. The dialog has a yellow warning icon and two buttons: 'Yes' and 'No'. The 'Yes' button is highlighted with a red rectangle. In the background, the 'Update Firmware' section is visible, showing a table with columns for 'Downloaded Firmware', 'Scheduled Delivery Date and Time', 'Label', and 'Version'. The 'Downloaded Firmware' is 'None', the 'Scheduled Delivery Date and Time' is '2009 06/28 4:29:41', the 'Label' is 'ENGLISH', and the 'Version' is '129'. There are buttons for 'Apply Firmware', 'Delete Firmware', and 'Delete Scheduled Delivery'. The 'Confirm New Firmware' button is also visible. The footer of the page reads 'Version 3.0.1.19f Copyright CANON INC. 2009 All Rights Reserved'.

The scheduled delivery is deleted.

A light blue confirmation message box is displayed. It contains the text 'The scheduled delivery was deleted.' and a button labeled 'To Delivered Update'.

Managing the Register/Update Software Function

Managing the Register/Update Software Function 28

Managing the Register/Update Software Function

OY1C-006

You can display the installation logs and test communication using the Remote UI.

Displaying the Installation/Update Log Using the Remote UI

You can check the installation logs of the system options/MEAP applications and the update log of the firmware.

1 Start the Remote UI, and then log in as Administrator.

▶ " e-Manual "

2 From the top page of the Remote UI, click [Settings/Registration] → [License/Other] → [Register/Update Software].

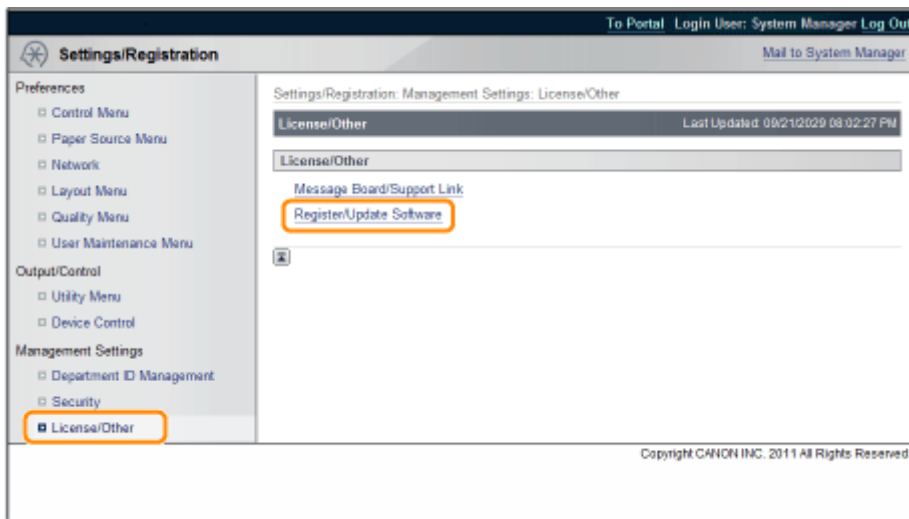

3 Click [Display Logs /Communication Test].

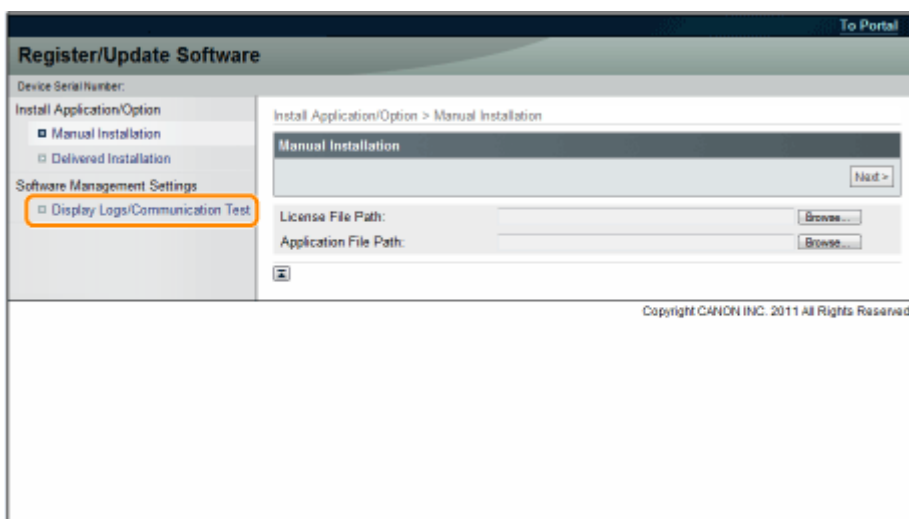

4 From the Log View drop-down list, select [Update Logs] → click [Switch].

The installation logs of the system options/MEAP applications and the update log of the firmware are displayed.

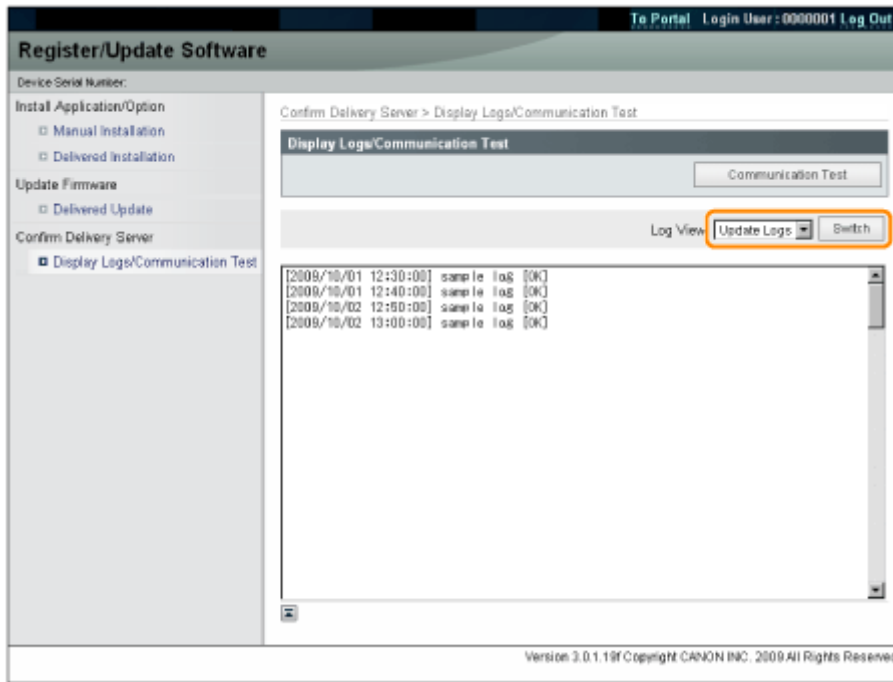

Testing Communication Using the Remote UI

You can check whether the printer can properly communicate with the delivery server.

1 Start the Remote UI, and then log in as Administrator.

▶ " e-Manual "

2 From the top page of the Remote UI, click [Settings/Registration] → [License/Other] → [Register/Update Software].

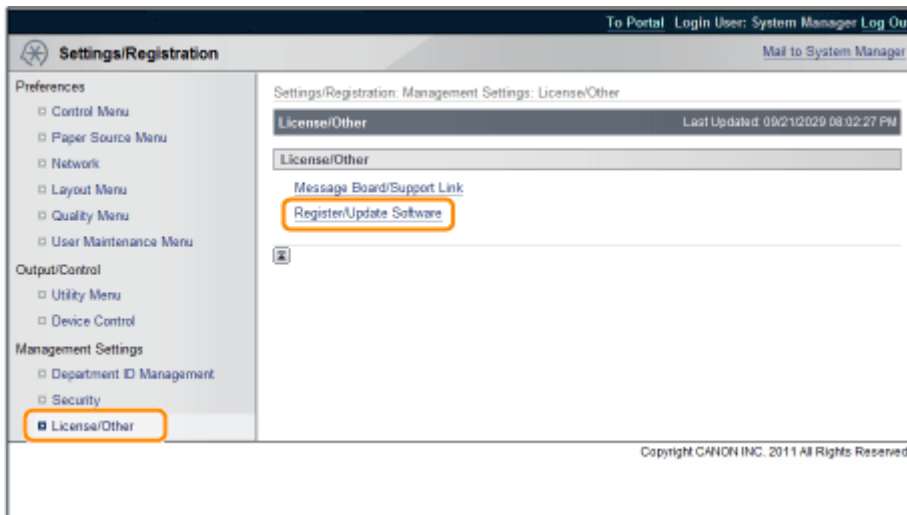

3 Click [Display Logs /Communication Test] → [Communication Test].

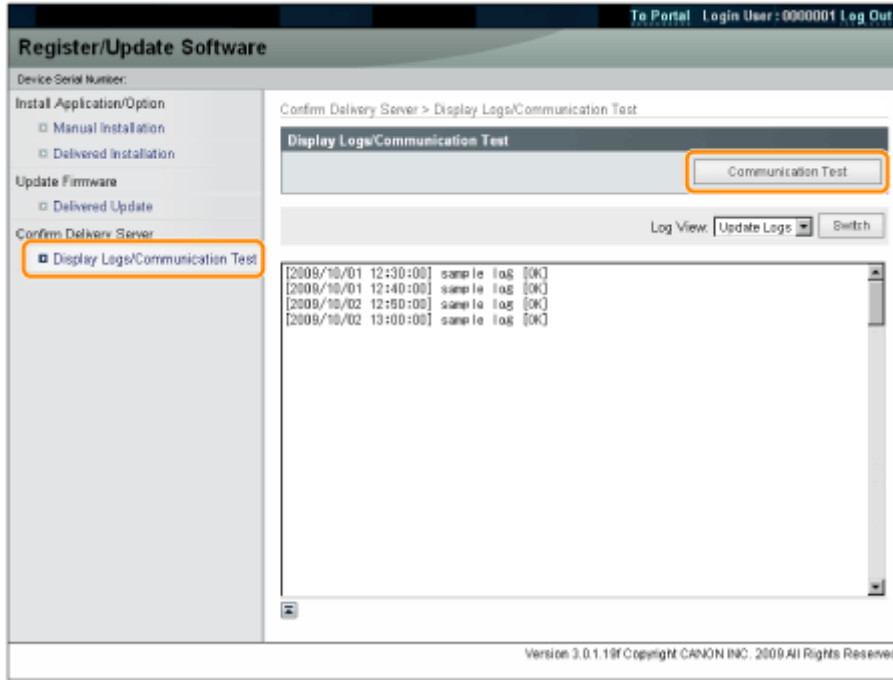

When the confirmation dialog is displayed, click [Yes].

Contents for the test are downloaded from the delivery server.

When the communication test is completed, the communication test result screen is displayed.

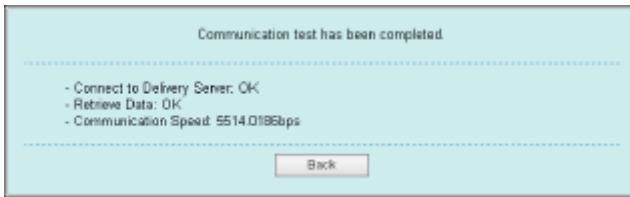

 **NOTE**

If [Failed] is displayed on the communication test result

If [Failed] is displayed on the communication test result screen, check that the network cable is connected and that the network settings are correct. If the problem is not resolved, contact your local authorized Canon dealer.

Using This Guide

Using This Guide	32
Operating Environment of This Guide	33
Screen Layout of This Guide	34
Top Page	35
Topic Page	36
Site Map	37
Search Method	38
Viewing This Guide	39

Using This Guide

0Y1C-007

This chapter describes how to use this guide.

❖ **Operating Environment of This Guide(P. 33)**

❖ **Screen Layout of This Guide(P. 34)**

▶ **Top Page(P. 35)**

▶ **Topic Page(P. 36)**

▶ **Site Map(P. 37)**

▶ **Search Method(P. 38)**

❖ **Viewing This Guide(P. 39)**

<To find the desired content>

- **Selecting between the category icons**

From the top page, select a category icon you want.

❖ " **Top Page(P. 35)** "

- **Searching from the site map**

On the site map, you can view the list of whole sections of this guide sorted by category. You can directly display sections in a category.

❖ " **Site Map(P. 37)** "

- **Whole text search function**

You can search by keyword in this guide. You can display the desired description from the search results by entering a keyword you want to search. This function supports AND search.

❖ " **Search Method(P. 38)** "

Operating Environment of This Guide

0Y1C-008

You need a Web browser to use this guide. Operation of the following Web browsers is guaranteed.

Windows

- Internet Explorer 6.0 or later
- Firefox 2.x or later

Mac OS

- Safari 3.x or later
- Firefox 3.x or later

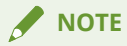

Enabling the script function

Enable the script function for a Web browser before using this guide.

Screen Layout of This Guide

0Y1C-009

This section describes the screen layout of this guide.

The page displayed right after this guide starts is called "Top Page" and the guide description is called "Topic Page" in this section.

"Site map" is displayed from [Site map] which is located on the upper right of this guide.

The search panel is used to make search through this guide.

The screen layout is different for each page, so click the following links to see the instruction.

➤ **Top Page(P. 35)**

➤ **Topic Page(P. 36)**

➤ **Site Map(P. 37)**

➤ **Search Method(P. 38)**

Top Page

0Y1C-00A

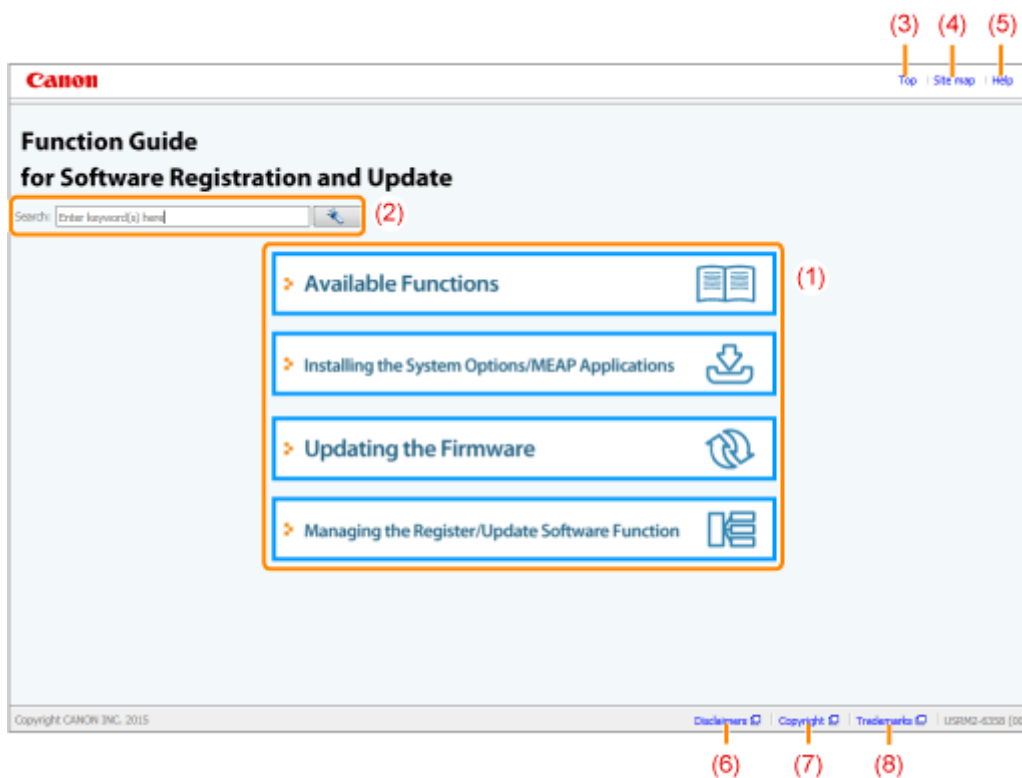

(1) Select from functions

The instructions of each function and operation method are described.

(2) [Search]

The search panel is displayed by entering keyword(s) and clicking [].

For details, see " **Search Method(P. 38)** ."

(3) [Top]

The top page of this guide is displayed.

(4) [Site map]

The entire contents of this guide are displayed.

(5) [Help]

How to use this guide is displayed.

(6) [Disclaimers]

The disclaimers are displayed.

(7) [Copyright]

The information of copyrights is displayed.

(8) [Trademarks]



The trademarks are displayed.

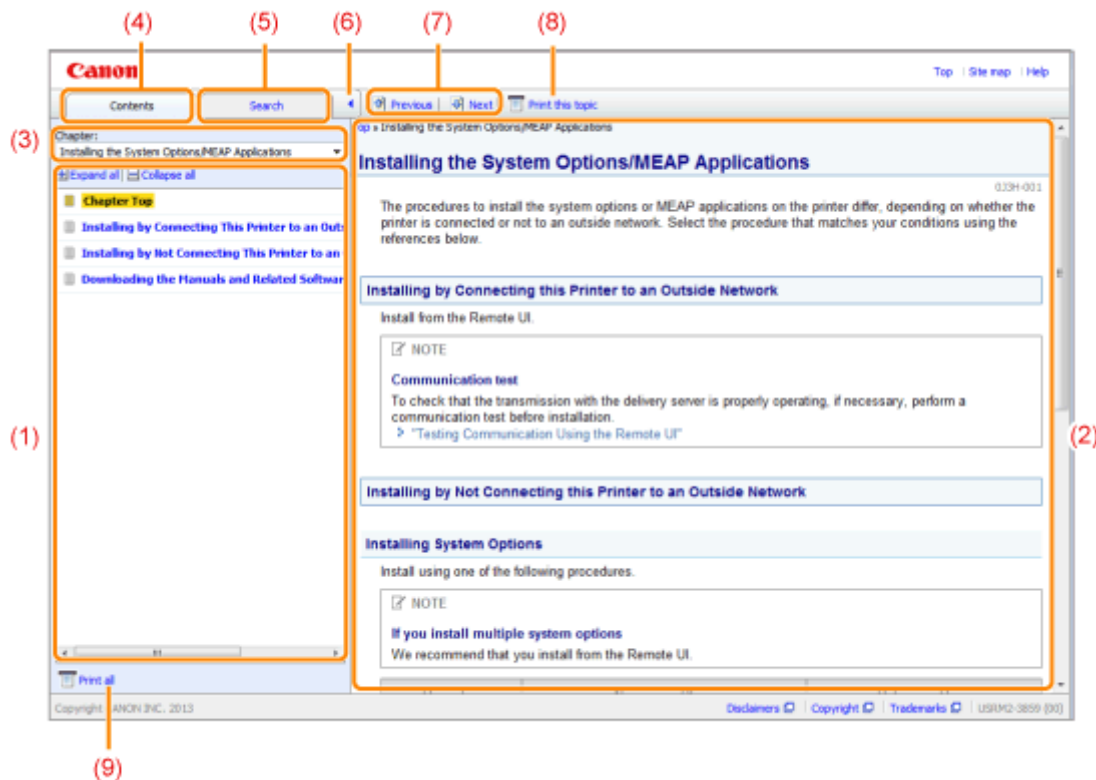

Topic Page

0Y1C-00C



(1) Chapter contents

This is the list of the contents in the chapter. Clicking each item displays the description in the topic page. Click [] to expand a menu, and click [] to collapse a menu.

Alternatively, click [ Expand all] to expand all menus, and click [ Collapse all] to collapse all menus.

(2) Topic page

The descriptions of each item are displayed.

The current location of the displayed topic is displayed at the upper left of the topic page. Click a link to move to a higher level.

(3) [Chapter] menu

You can select a different chapter from the pull-down menu.

(4) [Contents] tab

Click to display the chapter contents panel.

(5) [Search] tab

Click to display the search panel.

For details, see " **Search Method(P. 38)** ."

(6) []

Click to display or hide the chapter contents panel/search panel.

(7) [Previous]/[Next]

Click to move to the previous or next topic.

(8) [Print this topic]

Prints only the topic page currently displayed.

(9) [Print all]

Prints all the contents in a chapter.

Site Map

0Y1C-00E

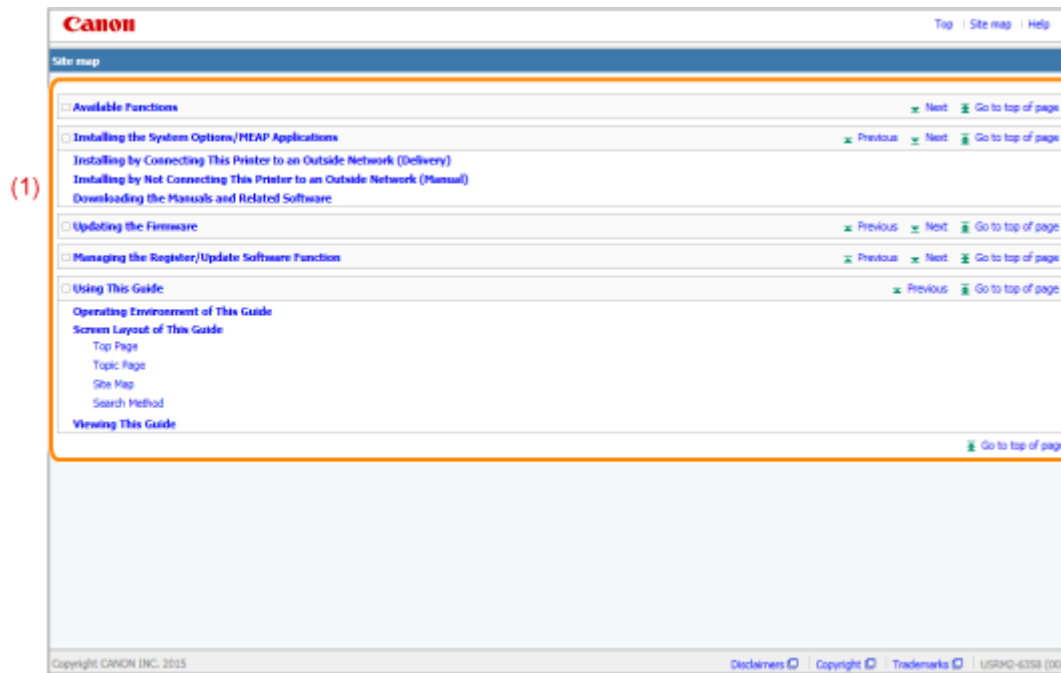

(1) Whole contents

Shows the all chapters and sections of this guide. Click an item to view the contents.

Search Method

OY1C-00F

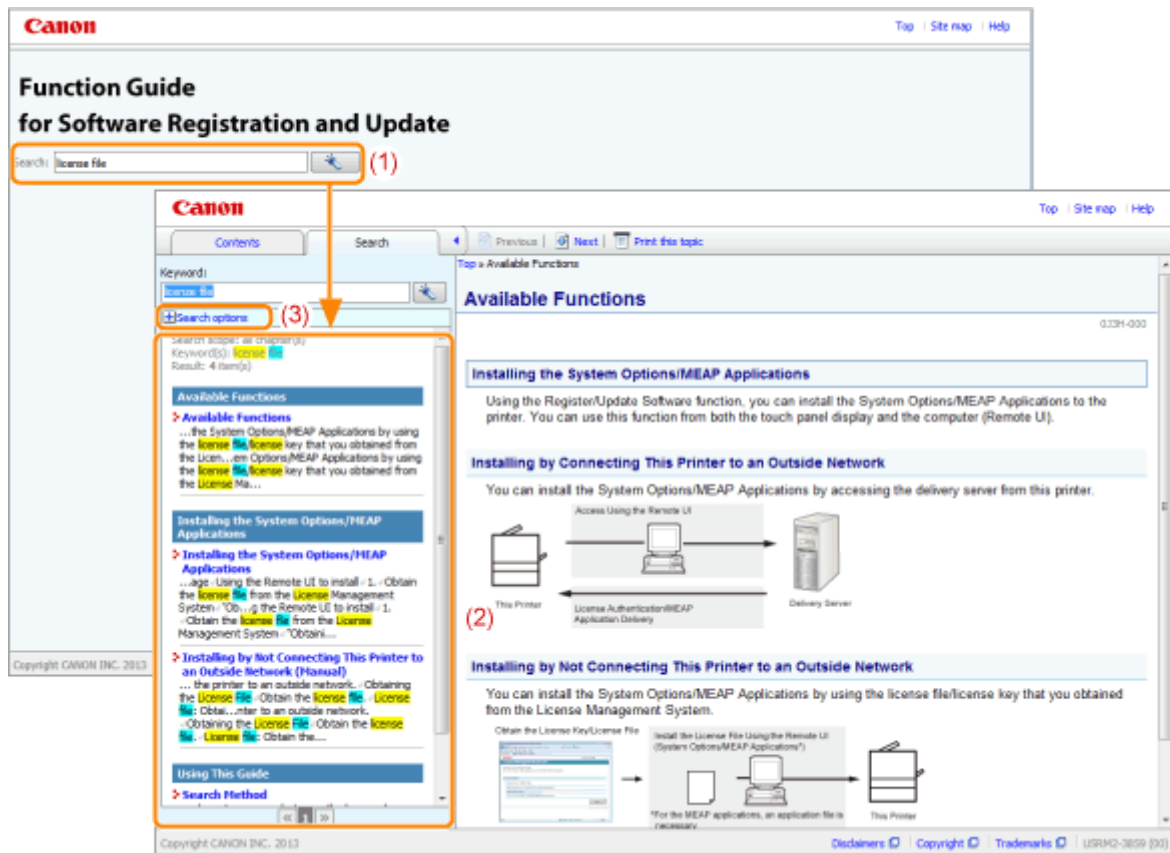

(1) Search



Entering a character string in [Search] on the top page or in the [Keyword] text box on the search panel and then clicking [] displays the search results.

The AND search is available in this guide so you can refine the search results by entering two or more keywords. When entering keywords, enter a space between the keywords.

- **Example:** license file (if you want to display pages which include words, "license" and "file")

(2) Search result

The search results for a keyword are displayed.

If there are more than 10 search results, you can see the other results by clicking [], [], or the number which is located below the result.

(3) [Search options]

Click to display the search options.

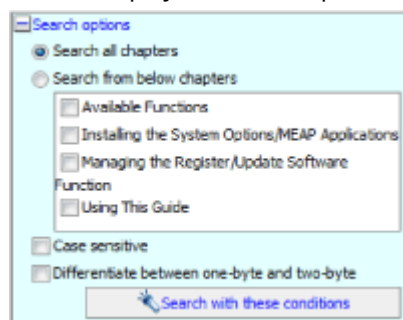

The search options can be used to specify the chapter to search, case sensitivity, and whether to differentiate between one- and two-byte characters.

Click [Search with these conditions] to search with the specified conditions.

Viewing This Guide

0Y1C-00H

Symbols Used in This Guide

The following symbols are used in this Guide to mark descriptions of handling restrictions, precautions, and instructions that should be observed for your safety.

IMPORTANT

Indicates operational requirements and restrictions. Be sure to read these items carefully to operate the machine correctly, and avoid damage to the machine or property.

NOTE

Indicates a clarification of an operation, or contains additional explanations for a procedure. Reading these notes is highly recommended.

Buttons Used in This Guide

The following are examples of how control panel keys and on-screen buttons are depicted in this guide.

Type	Depiction in This Guide	Example
Buttons on computer operation screen and so on	[Button name and so on]	[OK]

Screenshots Used in This Guide

The contents of the screenshots used in this guide are the default settings.

Depending on the system configuration, the contents of the screenshots may partly differ.

Disclaimer

Disclaimer 41

Disclaimer

0Y1C-00J

The information in this manual is subject to change without notice.

CANON INC. MAKES NO WARRANTY OF ANY KIND WITH REGARD TO THIS MATERIAL, EITHER EXPRESS OR IMPLIED, EXCEPT AS PROVIDED HEREIN, INCLUDING WITHOUT LIMITATION, THEREOF, WARRANTIES AS TO MARKETABILITY, MERCHANTABILITY, FITNESS FOR A PARTICULAR PURPOSE OF USE OR AGAINST INFRINGEMENT OF ANY PATENT. CANON INC. SHALL NOT BE LIABLE FOR ANY DIRECT, INCIDENTAL, OR CONSEQUENTIAL DAMAGES OF ANY NATURE, OR LOSSES OR EXPENSES RESULTING FROM THE USE OF THIS MATERIAL.

Trademarks

Trademarks 43

Trademarks

OY1C-00L

- "MEAP" is a trademark of CANON Inc., referring to an "application platform" for Canon multifunction and single function printers.
- Apple, AppleTalk, EtherTalk, LocalTalk, Mac, Mac OS, and Safari are trademarks of Apple Inc., registered in the U.S. and other countries.
- Microsoft, Windows, Windows Vista, Windows Server, and Internet Explorer are either registered trademarks or trademarks of Microsoft Corporation in the United States and/or other countries.
- This product contains the Universal Font Scaling Technology or UFST® under license from Monotype Imaging, Inc. UFST® is a trademark of Monotype Imaging, Inc. registered in the United States Patent and Trademark Office and may be registered in certain jurisdictions.
- UFST: Copyright© 1989 - 1996, 1997, 2003, 2004, 2008, all rights reserved, by Monotype Imaging Inc.



- Java and all Java based trademarks and logos are trademarks or registered trademarks of Oracle and/or its affiliates.



- Adobe, PostScript, and the PostScript logo are either registered trademarks or trademarks of Adobe Systems Incorporated in the United States and/or other countries.
- Copyright© 2007 -08 Adobe Systems Incorporated. All rights reserved.
- Protected by U.S. Patents 5,737,599; 5,781,785; 5,819,301; 5,929,866; 5,943,063; 6,073,148; 6,515,763; 6,639,593; 6,754,382; 7,046,403; 7,213,269; 7,242,415; Patents pending in the U.S. and other countries.
- All instances of the name PostScript in the text are references to the PostScript language as defined by Adobe Systems Incorporated unless otherwise stated. The name PostScript also is used as a product trademark for Adobe Systems' implementation of the PostScript language interpreter.
- Except as otherwise stated, any reference to a "PostScript printing device," "PostScript display device," or similar item refers to a printing device, display device or item (respectively) that contains PostScript technology created or licensed by Adobe Systems Incorporated and not to devices or items that purport to be merely compatible with the PostScript language.
- Adobe, the Adobe logo, PostScript, the PostScript logo, and PostScript 3 are either registered trademarks or trademarks of Adobe Systems Incorporated in the United States and/or other countries.
- Linux is a registered trademark of Linus Torvalds. Microsoft and Windows are either registered trademarks or trademarks of Microsoft Corporation in the United States and/or other countries.

Trademarks

- All other trademarks are the property of their respective owners.
- All other product and brand names are registered trademarks, trademarks or service marks of their respective owners.

This Font Software is licensed under the SIL Open Font License, Version 1.1.

This license is copied below, and is also available with a FAQ at: <http://scripts.sil.org/OFL>

SIL OPEN FONT LICENSE Version 1.1 - 26 February 2007

PREAMBLE

The goals of the Open Font License (OFL) are to stimulate worldwide development of collaborative font projects, to support the font creation efforts of academic and linguistic communities, and to provide a free and open framework in which fonts may be shared and improved in partnership with others.

The OFL allows the licensed fonts to be used, studied, modified and redistributed freely as long as they are not sold by themselves. The fonts, including any derivative works, can be bundled, embedded, redistributed and/or sold with any software provided that any reserved names are not used by derivative works. The fonts and derivatives, however, cannot be released under any other type of license. The requirement for fonts to remain under this license does not apply to any document created using the fonts or their derivatives.

DEFINITIONS

"Font Software" refers to the set of files released by the Copyright Holder(s) under this license and clearly marked as such. This may include source files, build scripts and documentation.

"Reserved Font Name" refers to any names specified as such after the copyright statement(s).

"Original Version" refers to the collection of Font Software components as distributed by the Copyright Holder(s).

"Modified Version" refers to any derivative made by adding to, deleting, or substituting -- in part or in whole -- any of the components of the Original Version, by changing formats or by porting the Font Software to a new environment.

"Author" refers to any designer, engineer, programmer, technical writer or other person who contributed to the Font Software.

PERMISSION & CONDITIONS

Permission is hereby granted, free of charge, to any person obtaining a copy of the Font Software, to use, study, copy, merge, embed, modify, redistribute, and sell modified and unmodified copies of the Font Software, subject to the following conditions:

- 1) Neither the Font Software nor any of its individual components, in Original or Modified Versions, may be sold by itself.
- 2) Original or Modified Versions of the Font Software may be bundled, redistributed and/or sold with any software, provided that each copy contains the above copyright notice and this license. These can be included either as stand-alone text files, human-readable headers or in the appropriate machine-readable metadata fields within text or binary files as long as those fields can be easily viewed by the user.
- 3) No Modified Version of the Font Software may use the Reserved Font Name(s) unless explicit written permission is granted by the corresponding Copyright Holder. This restriction only applies to the primary font name as presented to the users.
- 4) The name(s) of the Copyright Holder(s) or the Author(s) of the Font Software shall not be used to promote, endorse or advertise any Modified Version, except to acknowledge the contribution(s) of the Copyright Holder(s) and the Author(s) or with their explicit written permission.
- 5) The Font Software, modified or unmodified, in part or in whole, must be distributed entirely under this license, and must not be distributed under any other license. The requirement for fonts to remain under this license does not apply to any document created using the Font Software.

TERMINATION

This license becomes null and void if any of the above conditions are not met.

DISCLAIMER

THE FONT SOFTWARE IS PROVIDED "AS IS", WITHOUT WARRANTY OF ANY KIND, EXPRESS OR IMPLIED, INCLUDING BUT NOT LIMITED TO ANY WARRANTIES OF MERCHANTABILITY, FITNESS FOR A PARTICULAR PURPOSE AND NONINFRINGEMENT OF COPYRIGHT, PATENT, TRADEMARK, OR OTHER RIGHT. IN NO EVENT SHALL THE COPYRIGHT HOLDER BE LIABLE FOR ANY CLAIM, DAMAGES OR OTHER LIABILITY, INCLUDING ANY GENERAL, SPECIAL, INDIRECT, INCIDENTAL, OR CONSEQUENTIAL DAMAGES, WHETHER IN AN ACTION OF CONTRACT, TORT OR OTHERWISE, ARISING FROM, OUT OF THE USE OR INABILITY TO USE THE FONT SOFTWARE OR FROM OTHER DEALINGS IN THE FONT SOFTWARE.



Function Guide for MEAP Application Management

User's Guide

Contents

Available Functions	2
Launching and Closing SMS	5
Before Launching SMS (Preparation)	7
Setting Up HTTP Communication	8
Launching SMS (Log in)	9
Attention (Launching SMS (Log in))	13
Closing SMS (Logging Out)	14
MEAP Application Settings	16
Installing MEAP Applications	19
Attention (Installing MEAP Applications)	22
Uninstalling MEAP Applications	23
Starting/Stopping MEAP Applications	25
Starting MEAP Applications	26
Stopping MEAP Applications	27
Checking the Details of MEAP Applications	29
MEAP Application License Settings	31
Adding License Files	32
Disabling License Files	35
Downloading Disabled License Files	38
Deleting Disabled License Files	41
Setting Authentication Information for MEAP Applications	44
System Settings	49
Changing the MEAP Applet Display Order	50
Checking Login Services	52
Setting Enhanced System Applications	54
Starting/Stopping Enhanced System Applications	55
Starting Enhanced System Applications	56
Stopping Enhanced System Applications	57
Installing Enhanced System Applications	58
Uninstalling Enhanced System Applications	61
Checking Information	62
Checking System Information	63
Checking Application Information	65
Checking License Files	66
Changing the SMS Password	67
Deleting the MEAP Application Setting Information	69
Managing MEAP Application Log Data	71
Downloading Log Data	72

Deleting Log Data	74
-------------------------	----

List of Error Messages (MEAP) 77

Errors Relating to the [Login] Page	79
Errors Relating to the [MEAP Application Management] Page	81
Errors Relating to the [Install MEAP Application] Page	83
Errors Relating to the [Authentication Information Settings] Page	88
Errors Relating to the [License Management] Page	89
Errors Relating to the [Enhanced System Application Management] Page	91
Errors Relating to the [Check License] and [Change Password] Pages	97
Errors Relating to the [MEAP Application Setting Information Management] Page	99
Errors Relating to the [MEAP Application Log Management] Page	100
Other Errors	101

Using This Guide 103

Operating Environment of This Guide	104
Screen Layout of This Guide	105
Top Page	106
Topic Page	107
Site Map	108
Search Method	109
Viewing This Guide	110

Disclaimer 112

Trademarks 114

Available Functions

Available Functions 2

Available Functions

0XW7-000

SMS (Service Management Service) is software that accesses the printer over the network from an existing Web browser, and can install and manage MEAP applications (called "applications" in this document). Since the software (Web server) for using SMS is embedded in the printer, there is no need for any software other than a Web browser.

If a printer on the network is connected to a computer, it can use SMS. You can perform the following operations using SMS.

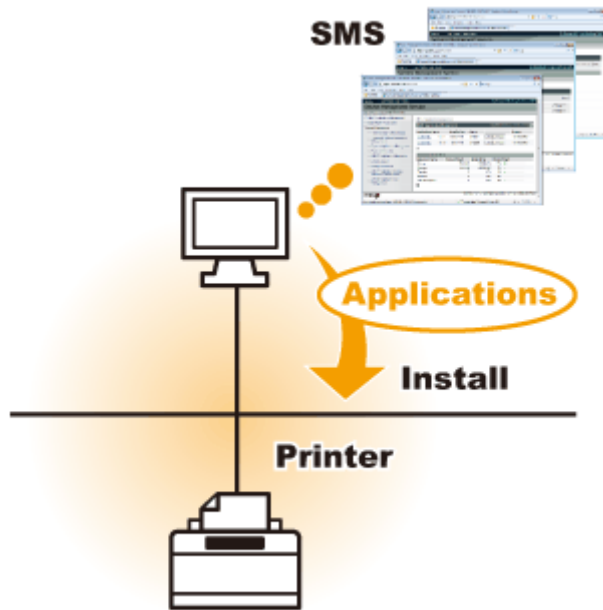

You can check application information from computers on the network

You can access the printer via the network and display the status and information of installed applications.

After SMS launches and you log in by entering your password in the [Log In] page, the following top page is displayed.

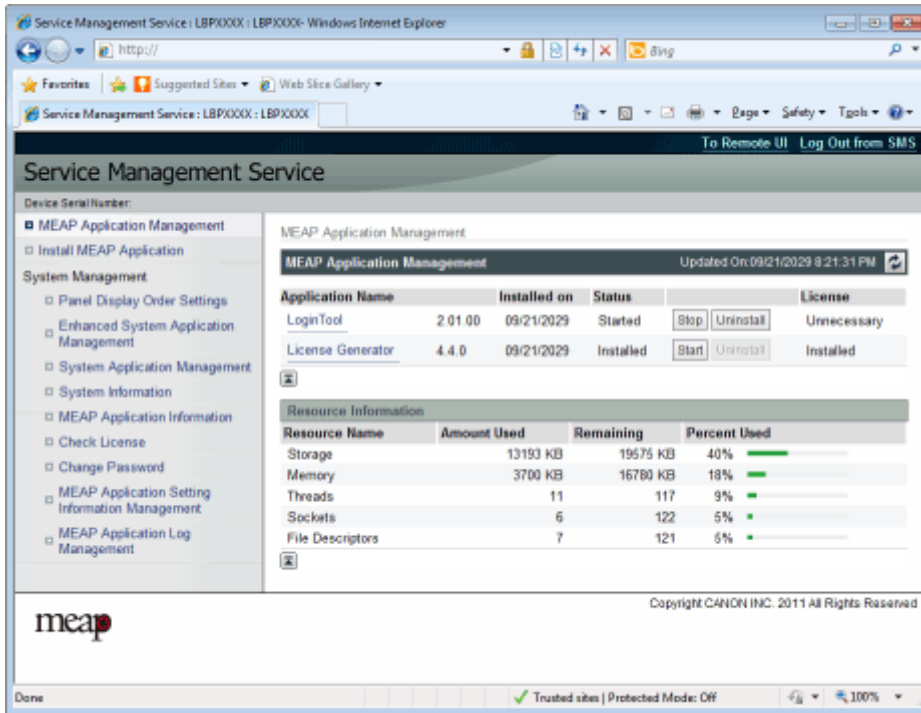

(1) [MEAP Application Management]

It can display the status of applications that are installed in the printer.

▶ " MEAP Application Settings(P. 16) "

(2) [Install MEAP Application]

Install the MEAP application.

▶ " Installing MEAP Applications(P. 19) "

(3) [System Management]

MEAP system administrator settings are used for setting system application settings, displaying information and changing passwords, etc.

▶ " System Settings(P. 49) "

You can install and uninstall applications

You can install and uninstall applications that support this printer from the computer.

▶ " Installing MEAP Applications(P. 19) "

▶ " Uninstalling MEAP Applications(P. 23) "

You can update installed applications and license files

If the license for the installed applications has expired, you can reinstall and update it.

▶ " Adding License Files(P. 32) "

Launching and Closing SMS

Launching and Closing SMS	5
Before Launching SMS (Preparation)	7
Setting Up HTTP Communication	8
Launching SMS (Log in)	9
Attention (Launching SMS (Log in))	13
Closing SMS (Logging Out)	14

Launching and Closing SMS

0XW7-001

Log in is required to use SMS.

➤ **Before Launching SMS (Preparation)
(P. 7)**

➤ **Launching SMS (Log in)(P. 9)**

➤ **Closing SMS (Logging Out)(P. 14)**

 **NOTE**

Web Browser Settings

The following settings are required.

- JavaScript must be enabled
- The use of session cookies must be enabled
- When a proxy server is used, using the proxy server settings of your Web browser, add the IP address of the printer to the [Exceptions] (addresses that do not use a proxy) list.
Since settings differ depending on the network environment, consult with your network administrator.

Launching SMS

Multiple users cannot log in to SMS at the same time.

Automatic SMS Logout

While SMS is in use, if it is not accessed for approximately five minutes or more it times out and the user is automatically logged out. If that happens, log in again from the [Login] page.

Do not use the Web browser's [Back] navigation button

If you use the Web browser's [Back] navigation button, SMS may not operate properly.

SMS System Environment

SMS operation is guaranteed in the following system environments.

Web Browsers	<ul style="list-style-type: none"> • Internet Explorer 7 or later • Safari 4.0.5 or later
Operating system	<ul style="list-style-type: none"> • Windows Vista SP2 • Windows 7 SP1 • Windows 8

Launching and Closing SMS

- Windows 10
- Mac OS X v 10.5 or later

Before Launching SMS (Preparation)

0XW7-002

Set the following before launching SMS.

Step 1	Configure the network settings.	▶ " e-Manual "
Step 2	Check the printer's IP address by Network Status Print.	▶ " e-Manual "
Step 3	Set it so that the printer can be accessed from the Web browser.	▶ " Setting Up HTTP Communication(P. 8) "

Setting Up HTTP Communication

0XW7-003

In order to use MEAP functions from the Web browser, HTTP communication must be enabled.

Follow the steps in the procedure below to configure the settings. (The default settings are <On>.)

1 Press [Settings] key, select <Network> with ▲/▼, and then press [OK] key.

After the message is displayed, press [OK] key.

2 Select <TCP/IP Settings> with ▲/▼, and then press [OK] key.

3 Select <HTTP> with ▲/▼, and then press [OK] key.

4 Select <On> with ▲/▼, and then press [OK] key.

<On>	It uses HTTP.
<Off>	It does not use HTTP.

5 Perform a hard reset or restart the printer.

The settings are enabled after a hard reset or after the printer is restarted.

 **NOTE**

Details about Hard Resets
See the " e-Manual ."

Launching SMS (Log in)

0XW7-004

The following two methods are used for launching SMS.

- ▶ **Launching SMS directly from the Web browser(P. 9)**
- ▶ **Launching SMS from a Remote UI(P. 10)**

Before launching SMS, see " **Attention (Launching SMS (Log in))(P. 13)** ."

Launching SMS directly from the Web browser

1 Start the Web browser.

2 Enter "https://<Printer's IP address>:8443/sms/" in the address bar, and then press [ENTER] from the Enter key on the keyboard.

- Entry Example: https://192.168.0.215:8443/sms/

† If the printer's host name is registered in the DNS server, you can enter [host name.domain name] instead of the IP address.

- Input Example: http://my_printer.xy_dept.company.com:8443/sms/

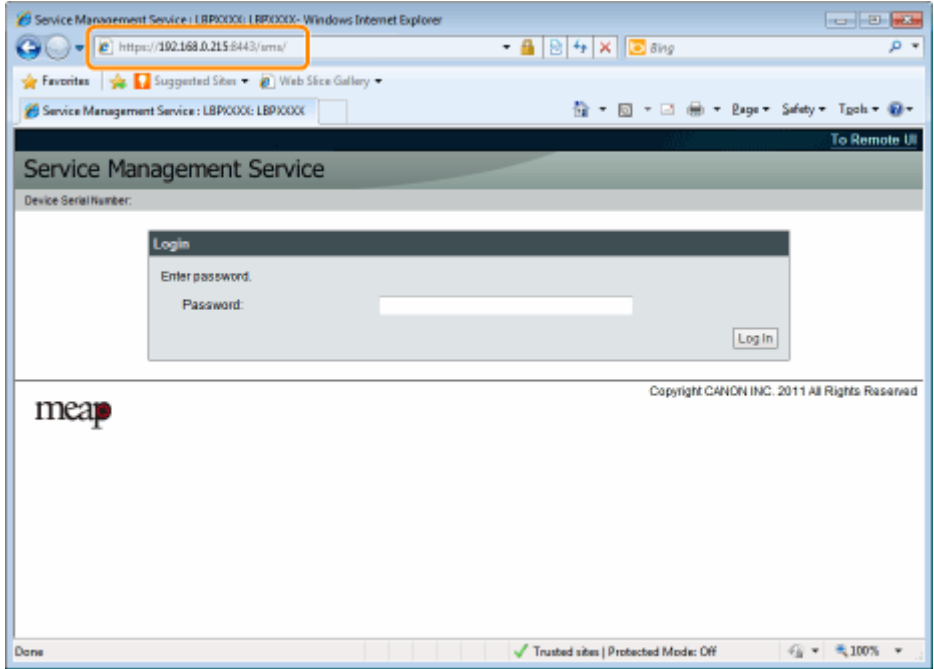

? If SMS does not launch

Check the following.

- HTTP communication is enabled.
 - " **Setting Up HTTP Communication(P. 8)** "
- The computer and printer are connected properly over the network.
- The printer is turned ON.

- The IP address or [host name.domain name] are entered correctly.

 **NOTE**

Device Serial Number

The printer's device serial number is displayed on the upper left of the screen. (The device serial number is required to obtain the license file from the license management system.)

3 Enter the password, and then click [Login].

† The default password is "MeapSmsLogin" (case sensitive).

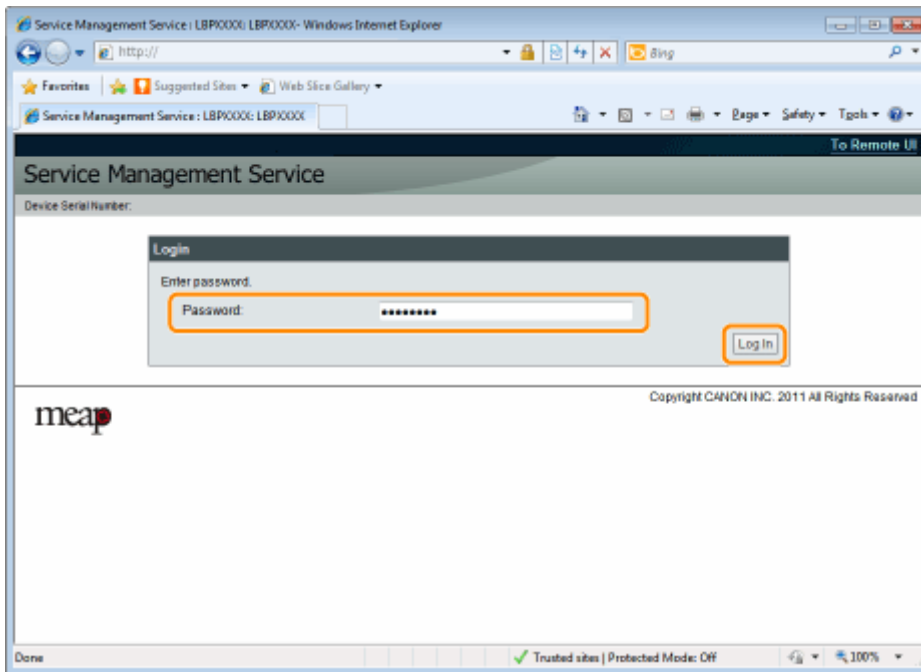

 **If you cannot log in**

If you cannot log in because the password is not correct, a message is displayed prompting you to re-enter your password.

Enter the correct password, and then click [Login].

- † If you do not log in within approximately 5 minutes after the login page is displayed, you will not be able to log in even if you enter the correct password.
- † A switch license file is required to initialize passwords. After clicking on [Browse] in [Initialize Password] in the screen that displays the message prompting password re-entry, select Switch License File, and then click [Initialize]. Contact your local authorized Canon dealer or sales representatives.

Launching SMS from a Remote UI

1 Start the Remote UI and log on in system manager mode.

- ▶ " e-Manual "

2 Click [Service Management Service] on the portal page.

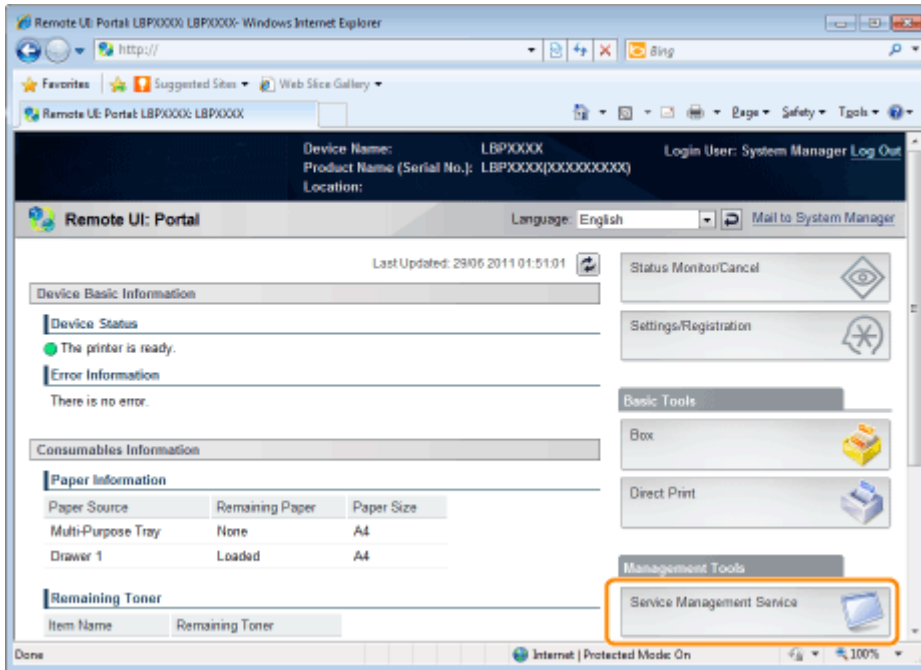

3 Enter the password, and then click [Login].

† The default password is "MeapSmsLogin" (case sensitive).

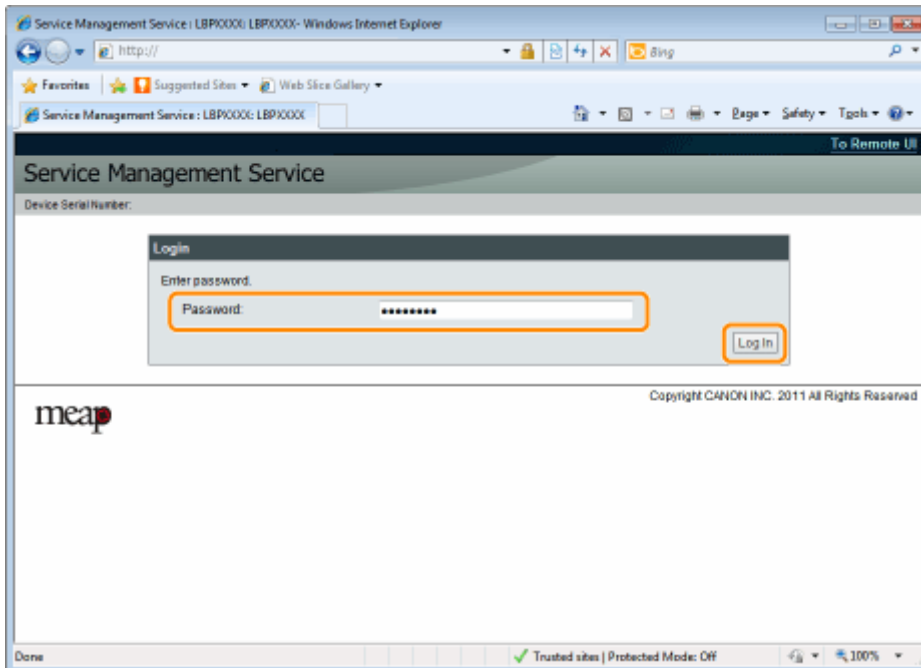

? If you cannot log in

If you cannot log in because the password is not correct, a message is displayed prompting you to re-enter your password.

Enter the correct password, and then click [Login].

† If you do not log in within approximately 5 minutes after the login page is displayed, you will not be able to log in even if you enter the correct password.

† A switch license file is required to initialize passwords. After clicking on [Browse] in [Initialize Password] in the screen that displays the message prompting password re-entry, select Switch License File, and then click [Initialize]. Contact your local authorized Canon dealer or sales representatives.

Attention (Launching SMS (Log in))

0XW7-005

IMPORTANT

SMS Password

- To prevent unauthorized access, We recommend that the administrator change the password before SMS use is begun. See " **Changing the SMS Password(P. 67)** " when changing passwords.
- This password is to prevent unauthorized operation of the printer. Do not let anyone know except the administrator.
- Make sure that you do not forget your password. If you forget your password, you will not be able to use SMS. If this happens, contact your local dealer.

Closing SMS (Logging Out)

OXW7-006

Click [Log Out from SMS] to close SMS.

† If you close the Web browser without clicking [Log Out from SMS], SMS becomes temporarily unusable.

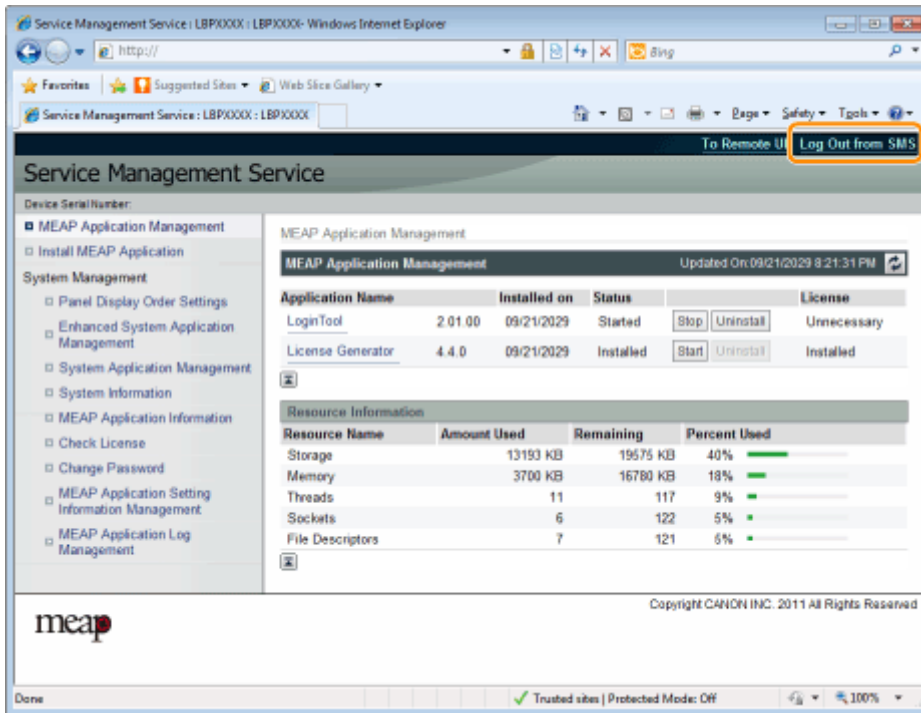

MEAP Application Settings

MEAP Application Settings	16
Installing MEAP Applications	19
Attention (Installing MEAP Applications)	22
Uninstalling MEAP Applications	23
Starting/Stopping MEAP Applications	25
Starting MEAP Applications	26
Stopping MEAP Applications	27
Checking the Details of MEAP Applications	29
MEAP Application License Settings	31
Adding License Files	32
Disabling License Files	35
Downloading Disabled License Files	38
Deleting Disabled License Files	41
Setting Authentication Information for MEAP Applications	44

MEAP Application Settings

0XW7-007

MEAP applications are set from the [MEAP Application Management] and the [Install MEAP Application] menus.

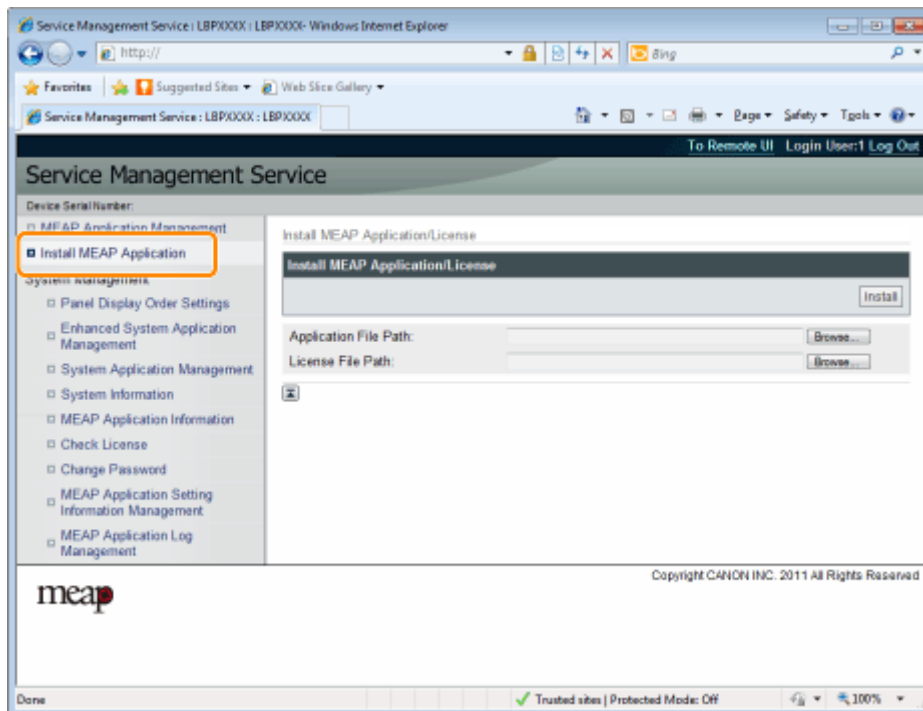
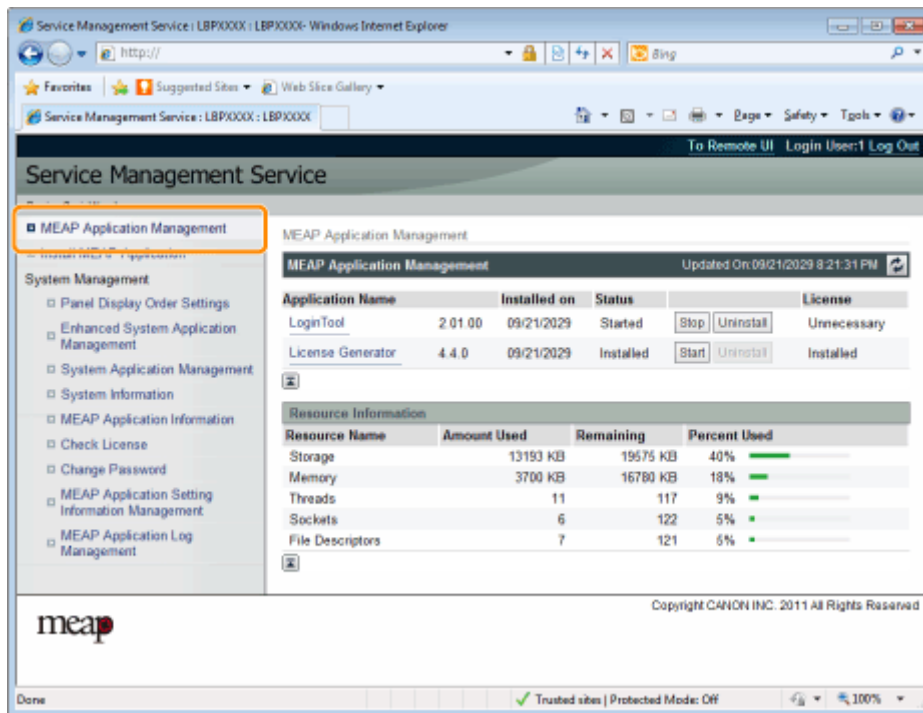

Items shown in the [MEAP Application Management] menu

[Application Name]	The name of the application is displayed.
[Installed on]	The date on which the application was installed is displayed.
[Status]	The status of the application is displayed. <ul style="list-style-type: none"> • [Installed]:

MEAP Application Settings

	<p>The application has been installed, but not started. Or, the printer was turned OFF after the application stopped, and after the printer was restarted the application was not yet started.</p> <ul style="list-style-type: none"> • [Started]: The application is running. • [Stopped]: The application is stopped. • [Starting]: The application is starting up. • [Stopping]: The application is closing down. 						
<p>[License]</p>	<p>The license status of the application is displayed.</p> <ul style="list-style-type: none"> • [Installed]: A valid license file has been installed. • [Not Installed]: The license file has been disabled. • [Over Limit]: The license file that is installed has an expiration date, and multiple types of counters have been set. One or more of the counter values has exceeded the upper limits of the counter. • [Invalid]: The installed license file has passed its expiration date. Or, the current counter value has exceeded the upper limit of the license file. <p>* When upper limits have been set for multiple types of counters, the license will become invalid at the point in time when any counter exceeds its upper limit.</p> <ul style="list-style-type: none"> • [Unnecessary]: The application does not require a license file for startup. 						
<p>[Resource Information]</p>	<p>The resources being used by the applications are displayed.</p> <ul style="list-style-type: none"> • [Storage]: The amount of storage being used. It is shown in kilobyte units (KB). • [Memory]: The amount of memory being used. It is shown in kilobyte units (KB). • [Threads]: The number of threads. • [Sockets]: The number of sockets. • [File Descriptors]: The number of file descriptors. <div data-bbox="604 1637 1445 2054" style="background-color: #e1f5fe; padding: 10px; border: 1px solid #ccc;"> <p> NOTE</p> <p>Timing of [Resource Information] Updates</p> <p>[Resource Information] is updated at the following times.</p> <table border="1" data-bbox="719 1823 1382 2054"> <thead> <tr> <th>Item</th> <th>Timing of Updates</th> </tr> </thead> <tbody> <tr> <td>[Storage]</td> <td>When the application is installed or uninstalled</td> </tr> <tr> <td>[Memory] [Threads] [Sockets]</td> <td>When the application starts or stops</td> </tr> </tbody> </table> </div>	Item	Timing of Updates	[Storage]	When the application is installed or uninstalled	[Memory] [Threads] [Sockets]	When the application starts or stops
Item	Timing of Updates						
[Storage]	When the application is installed or uninstalled						
[Memory] [Threads] [Sockets]	When the application starts or stops						

Item	Timing of Updates
[File Descriptors]	

[Install MEAP Application] Menu Settings

[Install MEAP Application/License]	<p>Install the MEAP application.</p> <ul style="list-style-type: none"> • [Install]: Specify the application file and license file to be installed, and then click [Install] to start the installation. • [Application File Path]: Specify the application file to be installed. • [License File Path]: Specify the license file.
------------------------------------	---

See the following section for settings that use the [MEAP Application Management] and [Install MEAP Application] menus.

- **Installing MEAP Applications(P. 19)**
- **Uninstalling MEAP Applications(P. 23)**
- **Starting/Stopping MEAP Applications(P. 25)**
- **Checking the Details of MEAP Applications(P. 29)**
- **MEAP Application License Settings(P. 31)**
- **Setting Authentication Information for MEAP Applications(P. 44)**

Installing MEAP Applications

0XW7-008

Before starting the following operation, see " **Attention (Installing MEAP Applications)(P. 22)** ."

1 Start SMS (Service Management Service).

▶ " **Launching SMS (Log in)(P. 9)** "

2 Click [Install MEAP Application].

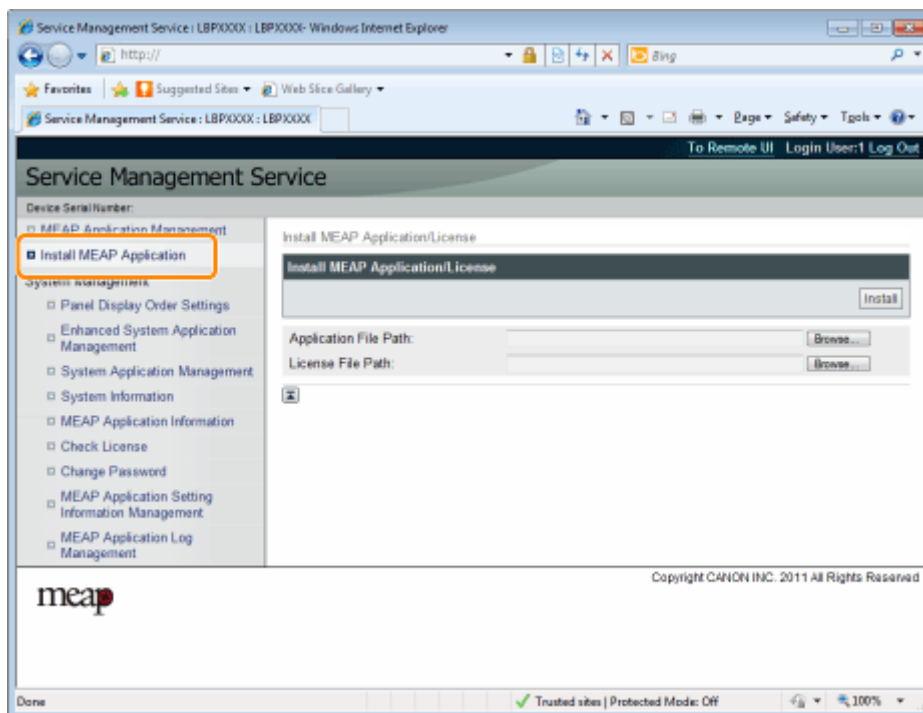

3 Set [Application File Path] and [License File Path].

Either select the file by clicking [Browse...], or enter the location where the file is stored.

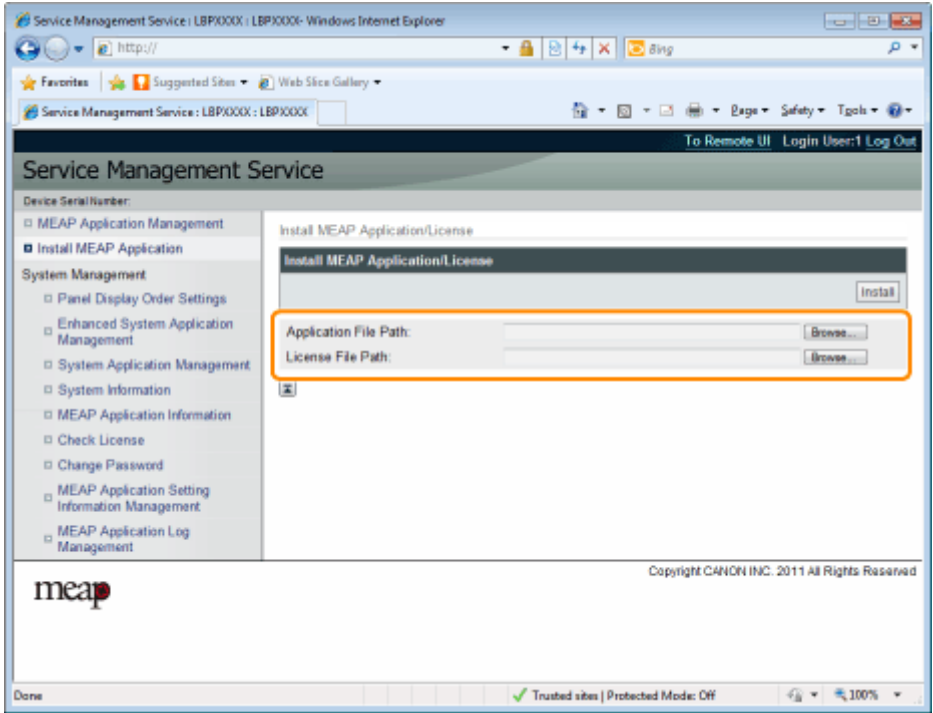

[Application File Path]	Specify a file with a "jar" extension.
[License File Path]	Specify a file with a "lic" extension.

4 Click [Install].

5 Confirm the information on the install confirmation page, and then click [Yes].

When the [License Agreement] appears, confirm the information, and then click [I Accept].

→ The installation begins.

<Information Displayed on the Install Confirmation Page>

If you are installing a new application

[Application Information]	Information about the application
[License Information]	The expiration date of the application

If you are updating an application

[Application Information]	[Current Application Information]	Information about the current application
	[Application Information after Overwrite]	Application information after overwrite
[License Information]	[Expires after]	The expiration date of the targeted application
	[Current Counter Usage Limit]	Current counter information
	[Counter Usage Limit after Overwrite]	Counter information after overwrite

? If the install is cancelled

If the shutdown process for the printer starts while an application is being installed, an error message may be displayed on the [Install] page for SMS, and the installation cancelled. If this happens, install the application again after restarting the printer by turning the main power switch OFF and then back ON again.

6 After the install is completed, click [To MEAP Application Management].

NOTE

When using the installed application

Start the application.

 **" Starting MEAP Applications(P. 26) "**

Attention (Installing MEAP Applications)

0XW7-009

IMPORTANT

Installing Applications

- There may be other specific requirements for installation, depending on the application. For more information, see the instruction manual provided with the application.
- You can install up to eight applications.
- You cannot install license files only. Specify both the application file and the license file. To only add a license file for an application that is already installed, see "**Adding License Files(P. 32)**."

Obtaining License Files

- In order to install an application, a valid license file is required. If you have a license access number in your application package, obtain a valid license file from License Management System (<http://www.canon.com/lms/license/>).



In order to obtain a license file, a license access number and a device serial number (the number displayed on the upper left of the SMS screen) are required.

- If you do not have a license access number in your application package, it will be provided by the dealer where you purchased the application. For more information, see the instruction manual provided with the application.

Storage Area

"Storage" under resource information displayed on the [MEAP Application Management] page allows you to confirm the maximum storage space that can be used by the application and the storage space currently used by the application.

When you are updating an application

Stop the application before installing the new version.

- ▶ **Stopping MEAP Applications(P. 27)** "

Uninstalling MEAP Applications

0XW7-00A

IMPORTANT

If the license status is not "Not Installed"

Uninstall the application after disabling and deleting the license files.

- ▶ " Disabling License Files(P. 35) "
- ▶ " Deleting Disabled License Files(P. 41) "

1 Start SMS (Service Management Service).

- ▶ " Launching SMS (Log in)(P. 9) "

2 Click [MEAP Application Management].

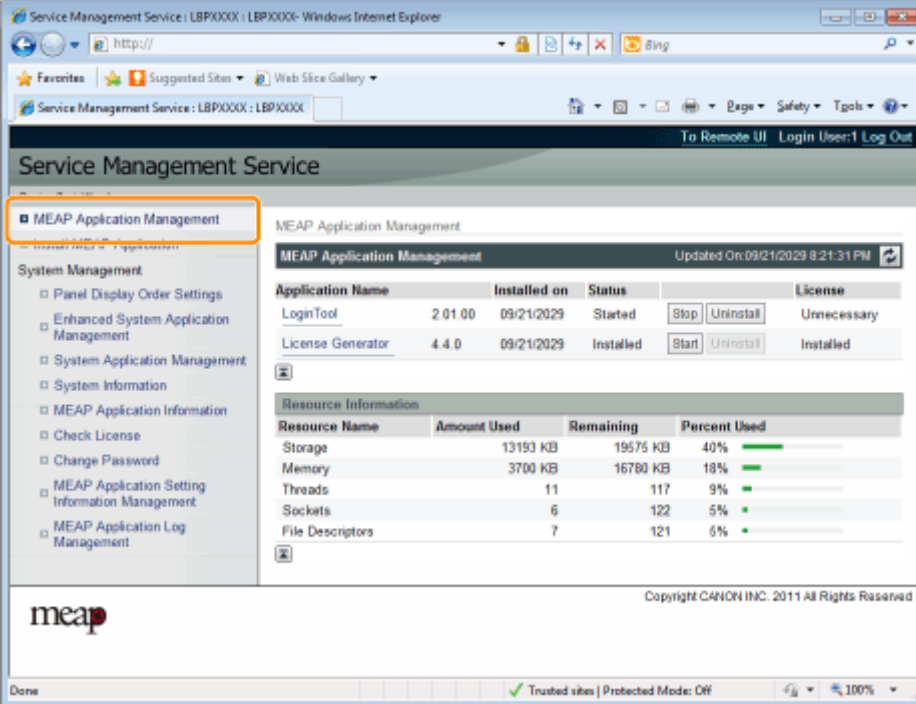

The screenshot shows the Service Management Service (SMS) web interface. The 'MEAP Application Management' section is active, displaying a table of installed applications and a resource usage section.

Application Name	Installed on	Status	License
LoginTool	2 01 00 09/21/2029	Started	Unnecessary
License Generator	4 4 0 09/21/2029	Installed	Installed

Resource Name	Amount Used	Remaining	Percent Used
Storage	13193 KB	19575 KB	40%
Memory	3700 KB	16780 KB	18%
Threads	11	117	9%
Sockets	6	122	5%
File Descriptors	7	121	6%

3 Click [Uninstall] for the application to uninstall.

† Applications with [Uninstall] grayed out cannot be deleted.

4 Click [Yes].

→ The uninstall begins.

? When the restart prompt message is displayed
Follow the on-screen instructions to restart the printer.

 **IMPORTANT**

If <A package exported from this application cannot be used.> is displayed and you uninstall the application that displayed this message, you may not be able to use other applications.

Starting/Stopping MEAP Applications

0XW7-00C

- **Starting MEAP Applications(P. 26)**

- **Stopping MEAP Applications(P. 27)**

Starting MEAP Applications

1 Start SMS (Service Management Service).

▶ " Launching SMS (Log in)(P. 9) "

2 Click [MEAP Application Management].

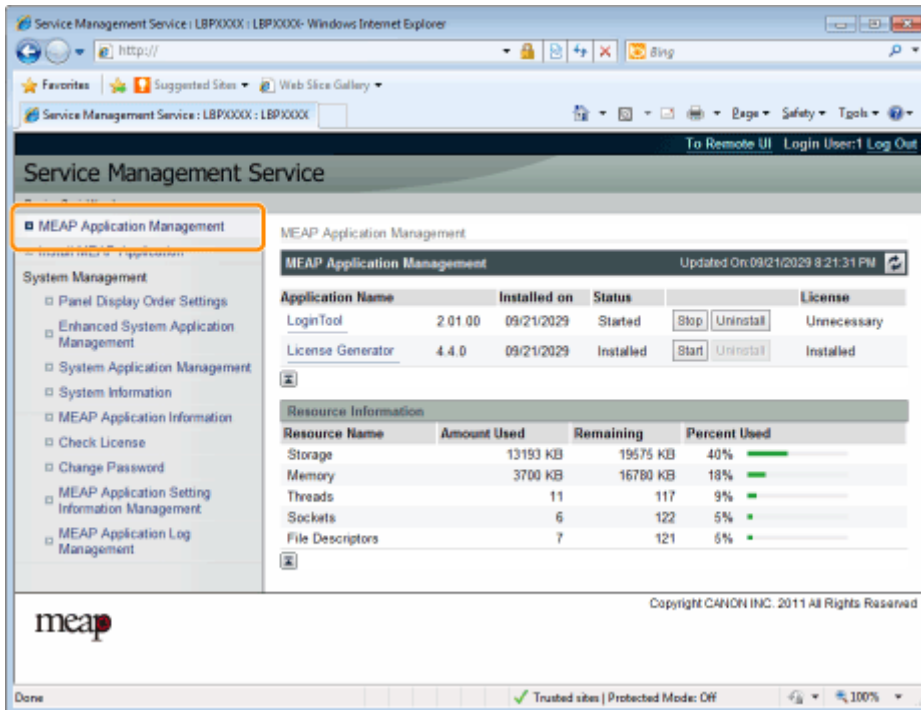

3 Click [Start] for the application to start.

? If the application does not start

Check the following.

- The required license file has been installed
- There is sufficient [Memory], [Threads], [Sockets] and [File Descriptors] under [Resource Information]

? When the restart prompt message is displayed

Follow the on-screen instructions to restart the printer.

Stopping MEAP Applications

1 Start SMS (Service Management Service).

▶ " Launching SMS (Log in)(P. 9) "

2 Click [MEAP Application Management].

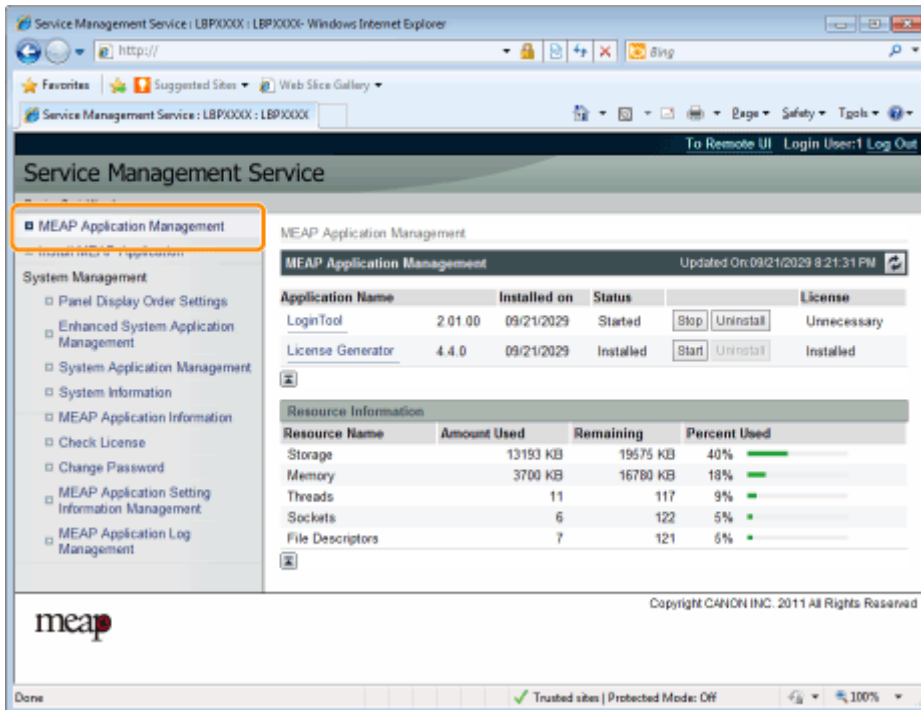

Service Management Service: LBPXXXX : LBPXXXX - Windows Internet Explorer

http://

Service Management Service : LBPXXXX : LBPXXXX

To Remote UI Login User:1 Log Out

Service Management Service

MEAP Application Management

MEAP Application Management Updated On 09/21/2029 8:21:31 PM

Application Name	Installed on	Status	License
LoginTool	2.01.00 09/21/2029	Started	Unnecessary
License Generator	4.4.0 09/21/2029	Installed	Installed

Resource Information

Resource Name	Amount Used	Remaining	Percent Used
Storage	13193 KB	19575 KB	40%
Memory	3700 KB	16780 KB	18%
Threads	11	117	9%
Sockets	6	122	5%
File Descriptors	7	121	6%

Copyright CANON INC. 2011 All Rights Reserved

3 Click [Stop] for the application to stop.

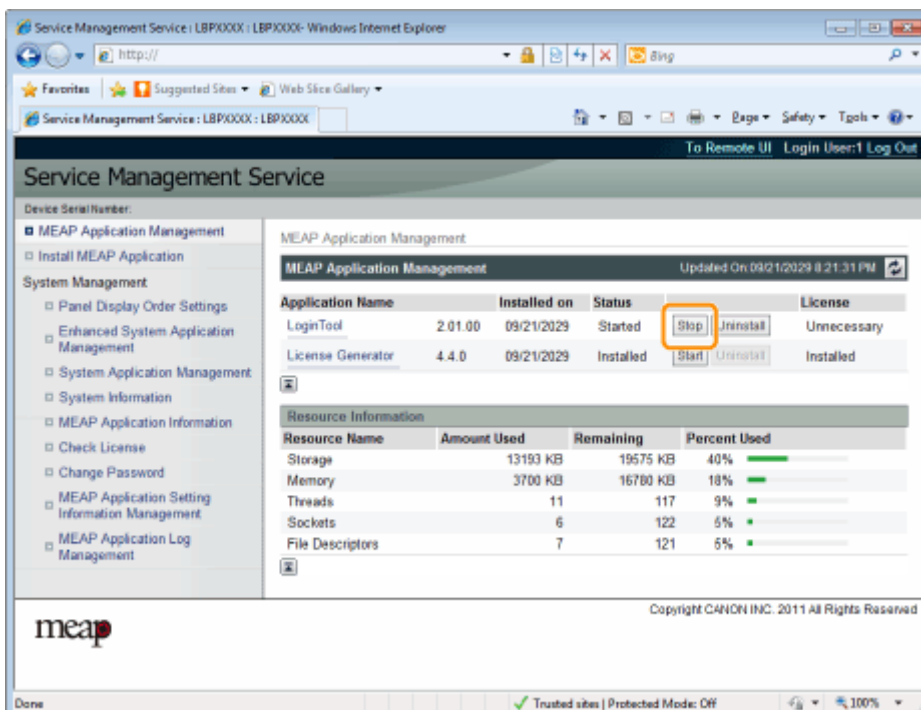

Service Management Service: LBPXXXX : LBPXXXX - Windows Internet Explorer

http://

Service Management Service : LBPXXXX : LBPXXXX

To Remote UI Login User:1 Log Out

Service Management Service

MEAP Application Management

MEAP Application Management Updated On 09/21/2029 8:21:31 PM

Application Name	Installed on	Status	License
LoginTool	2.01.00 09/21/2029	Started	Unnecessary
License Generator	4.4.0 09/21/2029	Installed	Installed

Resource Information

Resource Name	Amount Used	Remaining	Percent Used
Storage	13193 KB	19575 KB	40%
Memory	3700 KB	16780 KB	18%
Threads	11	117	9%
Sockets	6	122	5%
File Descriptors	7	121	6%

Copyright CANON INC. 2011 All Rights Reserved

? When the restart prompt message is displayed

Follow the on-screen instructions to restart the printer.

Checking the Details of MEAP Applications

OXW7-00H

Check the details of installed applications.

1 Start SMS (Service Management Service).

▶ " Launching SMS (Log in)(P. 9) "

2 Click [MEAP Application Management].

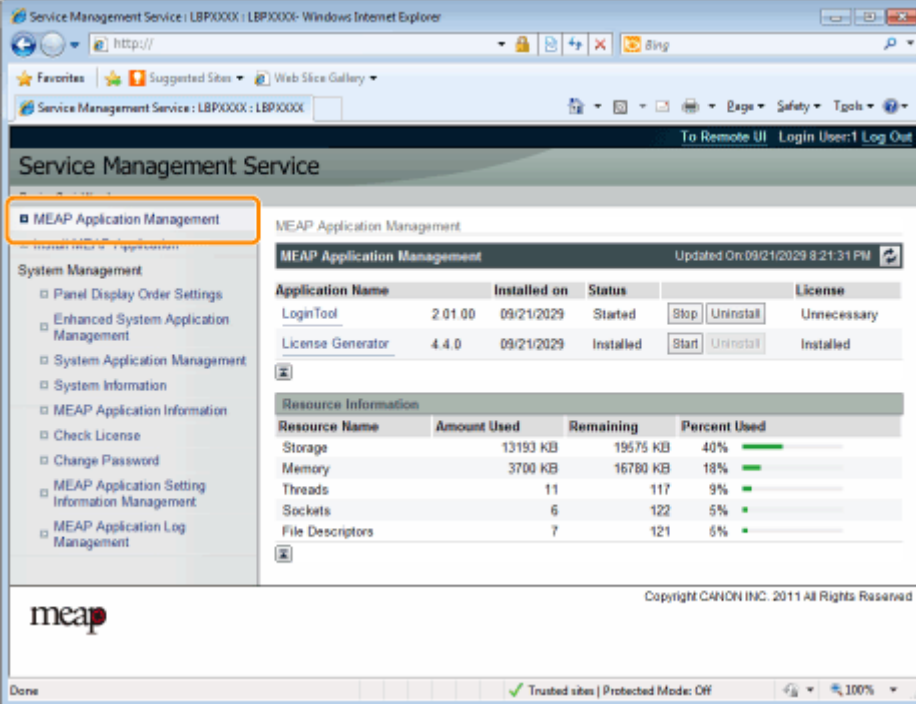

The screenshot shows the Service Management Service web interface in a browser window. The left sidebar contains a navigation menu with 'MEAP Application Management' highlighted. The main content area displays the 'MEAP Application Management' page, which includes a table of installed applications and a resource information section.

Application Name	Installed on	Status	License
LoginTool	2.01.00 09/21/2029	Started	Unnecessary
License Generator	4.4.0 09/21/2029	Installed	Installed

Resource Name	Amount Used	Remaining	Percent Used
Storage	13193 KB	19575 KB	40%
Memory	3700 KB	16780 KB	18%
Threads	11	117	9%
Sockets	6	122	5%
File Descriptors	7	121	6%

3 Click the application to check the details.

→ [Application/License Information] is displayed on the screen.

MEAP Application Settings

The screenshot displays the Service Management Service web interface in Internet Explorer. The browser address bar shows 'http://'. The page title is 'Service Management Service'. The navigation menu on the left includes 'MEAP Application Management', 'System Management', and 'MEAP Application Information'. The main content area is titled 'MEAP Application Management > Application/License Information'. It features a table for 'Application Information' and a section for 'License Information'. The 'Application Information' table lists details such as Application Name (License Generator), Version (4.4.0), Application ID, Installed on date (09/20/2029), Description (generic), Manufacturer (Canon Inc.), Import Package, and Import Service. The 'License Information' section shows the license status as 'Installed' with a serial number 'XXXXXXXXXX' and an expiration date of 'Does not Expire'. A copyright notice for CANON INC. 2011 is visible at the bottom.

Application Information	
Application Name:	License Generator
Version:	4.4.0
Application ID:	c7cfe585-f319-4f24-b511-bbd9c38690cc
Installed on:	09/20/2029
Description:	generic
Manufacturer:	Canon Inc.
Import Package:	javax.servlet javax.servlet.http org.osgi.service.http com.canon.meap.service.http
Import Service:	com.canon.meap.service.http.HttpService
Resources Used	
Storage:	10000 KB
Memory:	850 KB
Threads:	1
Sockets:	0
File Descriptors:	3

License Information	
Status:	Installed
Serial Number:	XXXXXXXXXX
Expires after:	Does not Expire

? When [Authentication Information Settings] is displayed

Set the authentication information.

▶ Setting Authentication Information for MEAP Applications(P. 44) "

MEAP Application License Settings

0XW7-00J

You can add, disable and delete license files for installed applications.

➤ Adding License Files(P. 32)

➤ Disabling License Files(P. 35)

➤ Downloading Disabled License Files(P. 38)

➤ Deleting Disabled License Files(P. 41)

IMPORTANT

Disabling Licenses

- You cannot disable a license file if the application is still running.
 - " **Stopping MEAP Applications(P. 27)** "
- When a disabled license file is generated, the status of that license file becomes <Not Installed> and the application becomes unusable.

Downloading and Deleting Licenses

- You can only download or delete disabled license files.
- Some license files need to be downloaded after they have been disabled.
- Once you have deleted the disabled license file, you cannot download it from the printer again. We recommend downloading and backing it up before deleting it.

Reinstalling License Files

You can reinstall disabled or downloaded license files in the same printer.

Adding License Files

OXW7-00K

You can install license files for applications that are already installed.

You can also increase counter values and extend terms of validity by adding license files.

1 Start SMS (Service Management Service).

▶ " Launching SMS (Log in)(P. 9) "

2 Click [MEAP Application Management].

The screenshot shows the Service Management Service web interface. The left navigation menu has "MEAP Application Management" highlighted. The main content area displays the "MEAP Application Management" page, which includes a table of installed applications and a resource information section.

Application Name	Installed on	Status	License
LoginTool	2 01 00 09/21/2029	Started	Unnecessary
License Generator	4 4 0 09/21/2029	Installed	Installed

Resource Name	Amount Used	Remaining	Percent Used
Storage	13193 KB	19575 KB	40%
Memory	3700 KB	16780 KB	18%
Threads	11	117	9%
Sockets	6	122	5%
File Descriptors	7	121	6%

3 Click the name of the application to which a license file will be added.

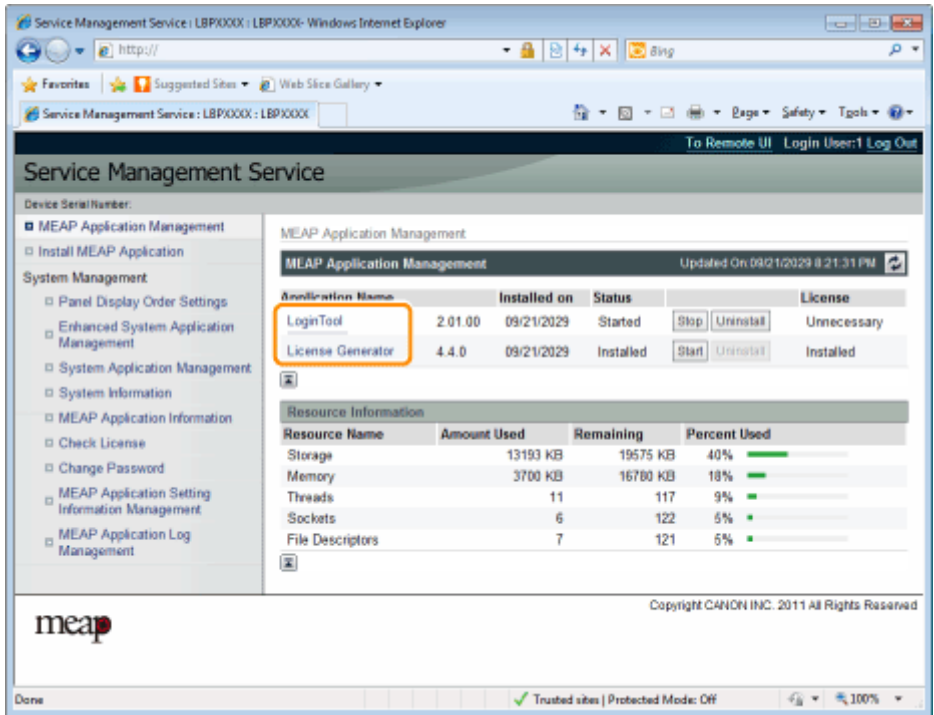

4 Click [License Management].

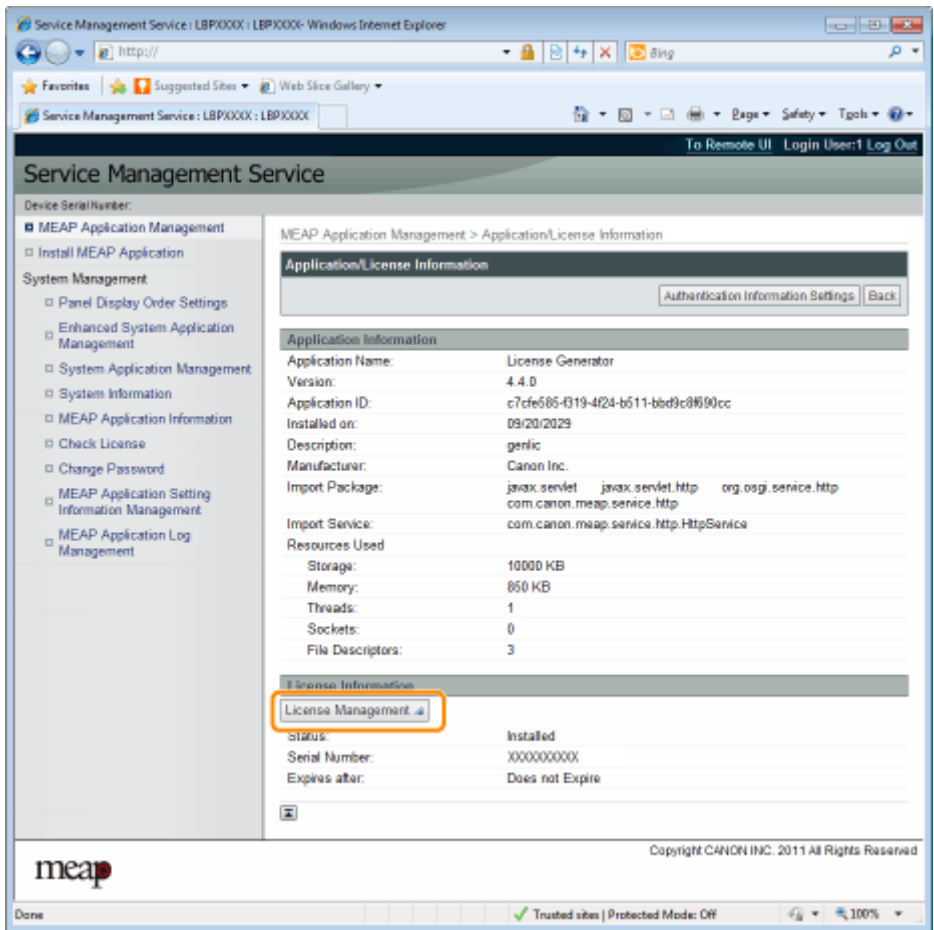

5 Specify the license file.

- (1) Click [Browse], and then select the license file to be added.

(2) Click [Install].

6 Confirm the information on the install confirmation page, and then click [Yes].

→ The license file is installed.

? If you are adding a license file to an [Over Limit] or [Invalid] application
you may need to restart the application.
▶ " Starting/Stopping MEAP Applications(P. 25) "

Disabling License Files

OXW7-00L

After you disable a license file, you can download and save it to a computer or delete it.

IMPORTANT

Disabling Licenses

- You cannot disable a license file if the application is still running.
 - " **Stopping MEAP Applications(P. 27)** "
- When a disabled license file is generated, the status of that license file becomes <Not Installed> and the application becomes unusable.

Reinstalling License Files

You can reinstall disabled license files in the same printer.

1 Start SMS (Service Management Service).

" **Launching SMS (Log in)(P. 9)** "

2 Click [MEAP Application Management].

The screenshot shows the Service Management Service web interface. The left navigation menu has "MEAP Application Management" highlighted. The main content area displays the "MEAP Application Management" page, which includes a table of applications and a resource information section.

Application Name	Installed on	Status	License
LoginTool	2.01.00 09/21/2029	Started	Unnecessary
License Generator	4.4.0 09/21/2029	Installed	Installed

Resource Name	Amount Used	Remaining	Percent Used
Storage	13193 KB	19575 KB	40%
Memory	3700 KB	16780 KB	18%
Threads	11	117	9%
Sockets	6	122	5%
File Descriptors	7	121	6%

3 Click the name of the application for which to disable to license file.

MEAP Application Settings

The screenshot shows the Service Management Service web interface. The left sidebar contains a navigation menu with the following items:

- MEAP Application Management
 - Install MEAP Application
- System Management
 - Panel Display Order Settings
 - Enhanced System Application Management
 - System Application Management
 - System Information
 - MEAP Application Information
 - Check License
 - Change Password
 - MEAP Application Setting Information Management
 - MEAP Application Log Management

The main content area displays the 'MEAP Application Management' page. It includes a table of installed applications:

Application Name	Installed on	Status	License
LoginTool	2.01.00 09/21/2029	Started	Unnecessary
License Generator	4.4.0 09/21/2029	Installed	Installed

Below the table is a 'Resource Information' section with a table showing system resources:

Resource Name	Amount Used	Remaining	Percent Used
Storage	13193 KB	19575 KB	40%
Memory	3700 KB	16700 KB	18%
Threads	11	117	9%
Sockets	6	122	5%
File Descriptors	7	121	6%

4 Click [License Management].

The screenshot shows the Service Management Service web interface. The left sidebar contains the same navigation menu as the previous screenshot.

The main content area displays the 'MEAP Application Management > Application/License Information' page. It includes a table of application details:

Application Information	License Information
Application Name: License Generator	Status: Installed
Version: 4.4.0	Serial Number: XXXXXXXXXX
Application ID: c7cf685-4319-4f24-b511-bb09c8090cc	Expires after: Does not Expire
Installed on: 09/20/2029	
Description: genic	
Manufacturer: Canon Inc.	
Import Package: javax.servlet javax.servlet.http org.osgi.service.http com.canon.meap.service.http	
Import Service: com.canon.meap.service.http.HttpService	
Resources Used	
Storage: 10000 KB	
Memory: 850 KB	
Threads: 1	
Sockets: 0	
File Descriptors: 3	

5 Click [Disable].

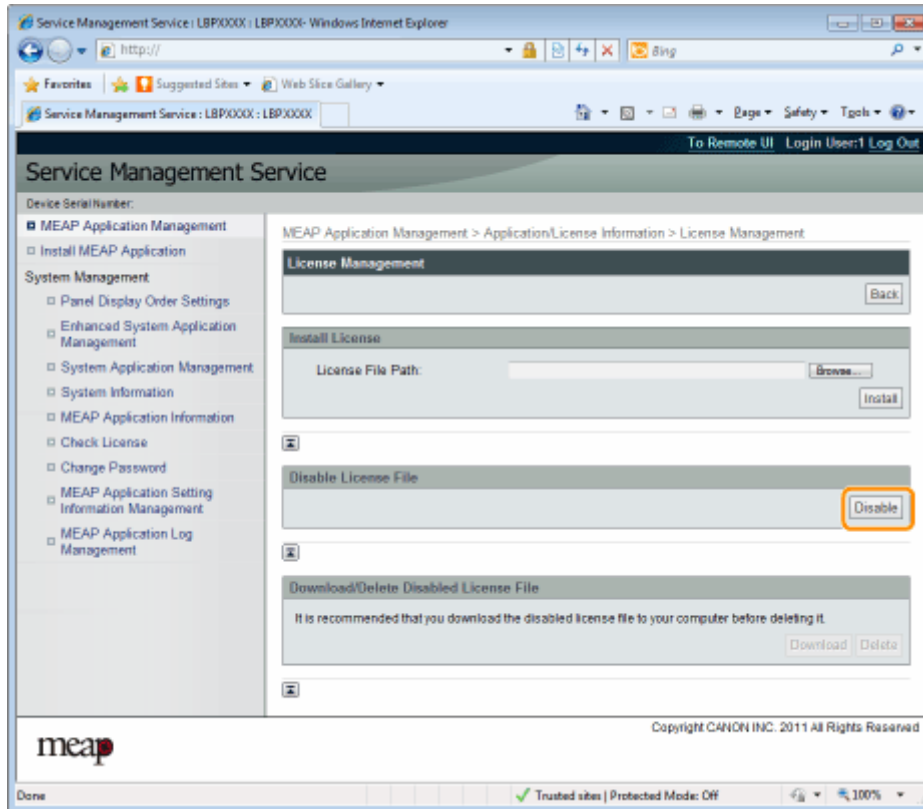

6 Click [Yes].

→ The license file is disabled.

Downloading Disabled License Files

Download and back up disabled license files to the computer.

IMPORTANT

Downloading Licenses

- You can only download disabled license files.
- Some license files need to be downloaded after they have been disabled.

Reinstalling License Files

You can reinstall downloaded and disabled license files in the same printer.

1 Start SMS (Service Management Service).

▶ " Launching SMS (Log in)(P. 9) "

2 Click [MEAP Application Management].

The screenshot shows the Service Management Service (SMS) web interface. The 'MEAP Application Management' section is highlighted in the left navigation menu. The main content area displays the following information:

MEAP Application Management
Updated On: 09/21/2029 8:21:31 PM

Application Name	Installed on	Status	License
LoginTool	2 01 00 09/21/2029	Started	Unnecessary
License Generator	4 4 0 09/21/2029	Installed	Installed

Resource Information

Resource Name	Amount Used	Remaining	Percent Used
Storage	13193 KB	19575 KB	40%
Memory	3700 KB	16780 KB	18%
Threads	11	117	9%
Sockets	6	122	5%
File Descriptors	7	121	6%

Copyright CANON INC. 2011 All Rights Reserved

3 Click the name of the application for which to download to license file.

MEAP Application Settings

The screenshot shows the Service Management Service web interface. The left sidebar contains a navigation menu with the following items:

- MEAP Application Management
 - Install MEAP Application
- System Management
 - Panel Display Order Settings
 - Enhanced System Application Management
 - System Application Management
 - System Information
 - MEAP Application Information
 - Check License
 - Change Password
 - MEAP Application Setting Information Management
 - MEAP Application Log Management

The main content area displays the MEAP Application Management page. It includes a table of installed applications:

Application Name	Installed on	Status	License
LoginTool	2.01.00 09/21/2029	Started	Unnecessary
License Generator	4.4.0 09/21/2029	Installed	Installed

Below the table is a Resource Information section with a table showing system resources:

Resource Name	Amount Used	Remaining	Percent Used
Storage	13193 KB	19575 KB	40%
Memory	3700 KB	16700 KB	18%
Threads	11	117	9%
Sockets	6	122	5%
File Descriptors	7	121	6%

4 Click [License Management].

The screenshot shows the Service Management Service web interface. The left sidebar contains the same navigation menu as the previous screenshot. The main content area displays the MEAP Application Management > Application/License Information page. It includes a table of application details:

Application Information	License Information
Application Name: License Generator	Status: Installed
Version: 4.4.0	Serial Number: XXXXXXXXXX
Application ID: c7cf685-4319-4f24-b511-bb09c8090cc	Expires after: Does not Expire
Installed on: 09/20/2029	
Description: genic	
Manufacturer: Canon Inc.	
Import Package: javax.servlet javax.servlet.http org.osgi.service.http com.canon.meap.service.http	
Import Service: com.canon.meap.service.http.HttpService	
Resources Used	
Storage: 10000 KB	
Memory: 850 KB	
Threads: 1	
Sockets: 0	
File Descriptors: 3	

5 Click [Download].

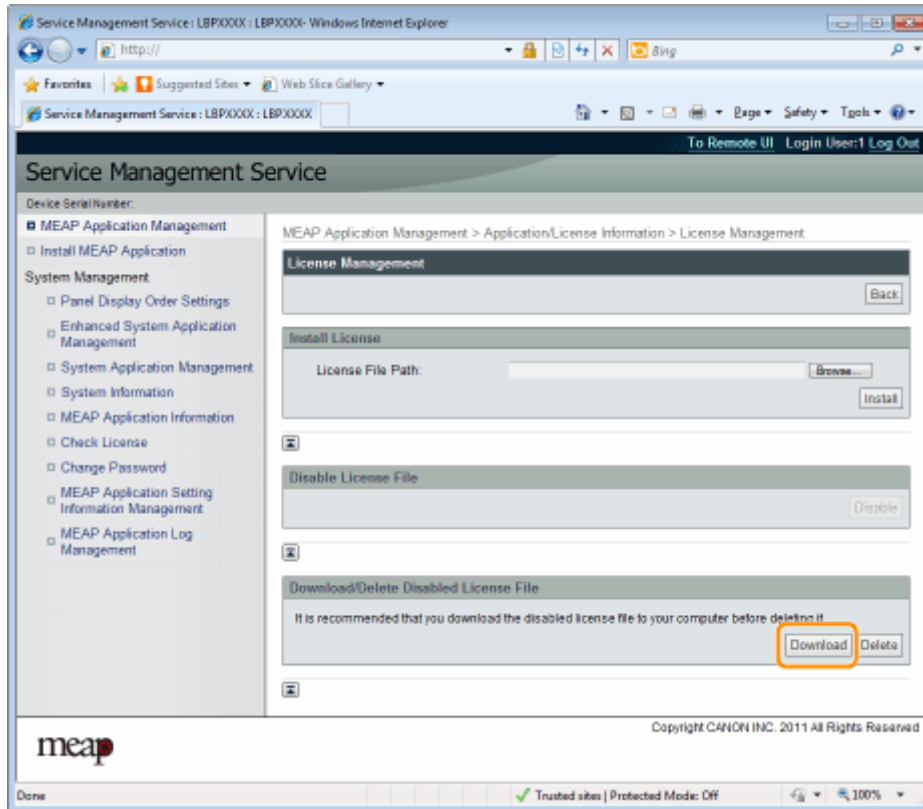

6 Follow the on-screen instructions and specify a file storage directory.

→ The license file is saved.

Deleting Disabled License Files

OXW7-00S

To uninstall an application, you must first delete the license file.

IMPORTANT

Deleting Licenses

- You can only delete disabled license files.
- Once you have deleted the disabled license file, you cannot download it again. We recommend downloading and backing it up before deleting it.

1 Start SMS (Service Management Service).

▶ " Launching SMS (Log in)(P. 9) "

2 Click [MEAP Application Management].

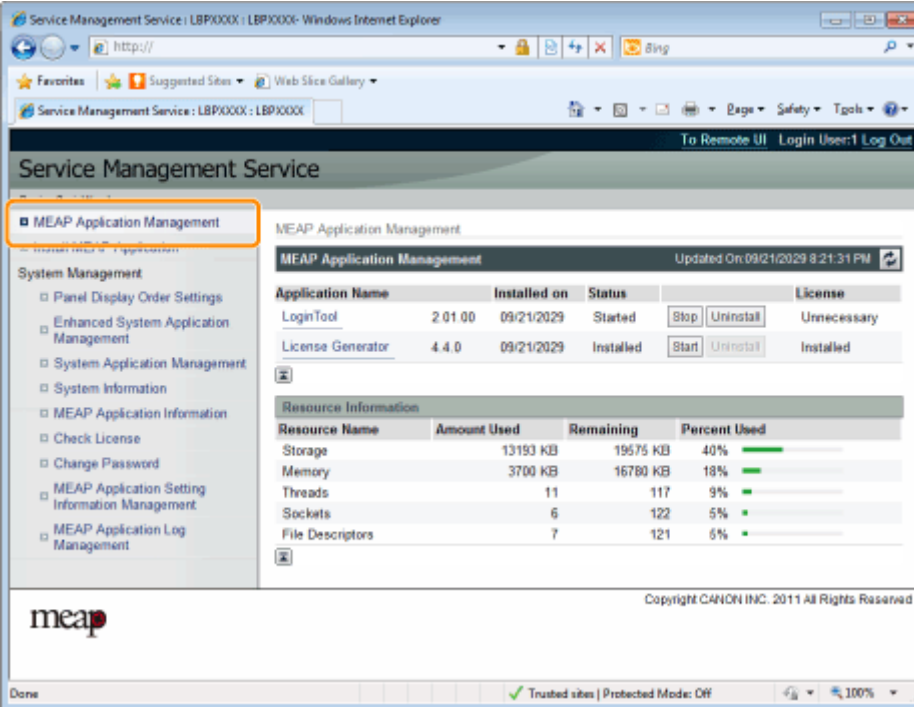

The screenshot shows the Service Management Service web interface. The left sidebar contains a navigation menu with 'MEAP Application Management' highlighted. The main content area displays the 'MEAP Application Management' page, which includes a table of applications and a resource information section.

Application Name	Installed on	Status	License
LoginTool	2 01 00 09/21/2029	Started	Unnecessary
License Generator	4 4 0 09/21/2029	Installed	Installed

Resource Name	Amount Used	Remaining	Percent Used
Storage	13193 KB	19575 KB	40%
Memory	3700 KB	16780 KB	18%
Threads	11	117	9%
Sockets	6	122	5%
File Descriptors	7	121	6%

3 Click the name of the application to which to delete a license file.

MEAP Application Settings

The screenshot shows the Service Management Service web interface. The left sidebar contains a navigation menu with the following items:

- MEAP Application Management
 - Install MEAP Application
- System Management
 - Panel Display Order Settings
 - Enhanced System Application Management
 - System Application Management
 - System Information
 - MEAP Application Information
 - Check License
 - Change Password
 - MEAP Application Setting Information Management
 - MEAP Application Log Management

The main content area displays the MEAP Application Management page. It includes a table of installed applications:

Application Name	Installed on	Status	License
LoginTool	2.01.00 09/21/2029	Started	Unnecessary
License Generator	4.4.0 09/21/2029	Installed	Installed

The 'License Generator' row is highlighted with a red box. Below the table is a 'Resource Information' section with a table showing resource usage:

Resource Name	Amount Used	Remaining	Percent Used
Storage	13193 KB	19575 KB	40%
Memory	3700 KB	16700 KB	18%
Threads	11	117	9%
Sockets	6	122	5%
File Descriptors	7	121	6%

4 Click [License Management].

The screenshot shows the Service Management Service web interface. The left sidebar contains the same navigation menu as the previous screenshot.

The main content area displays the MEAP Application Management > Application/License Information page. It includes a table of application details:

Application Information	License Information
Application Name: License Generator	Status: Installed
Version: 4.4.0	Serial Number: XXXXXXXXXX
Application ID: c7cf685-4319-4f24-b511-bb09c8090cc	Expires after: Does not Expire
Installed on: 09/20/2029	
Description: genic	
Manufacturer: Canon Inc.	
Import Package: javax.servlet javax.servlet.http org.osgi.service.http com.canon.meap.service.http	
Import Service: com.canon.meap.service.http.HttpService	
Resources Used	
Storage: 10000 KB	
Memory: 850 KB	
Threads: 1	
Sockets: 0	
File Descriptors: 3	

The 'License Management' link in the 'License Information' section is highlighted with a red box.

5 Click [Delete].

MEAP Application Settings

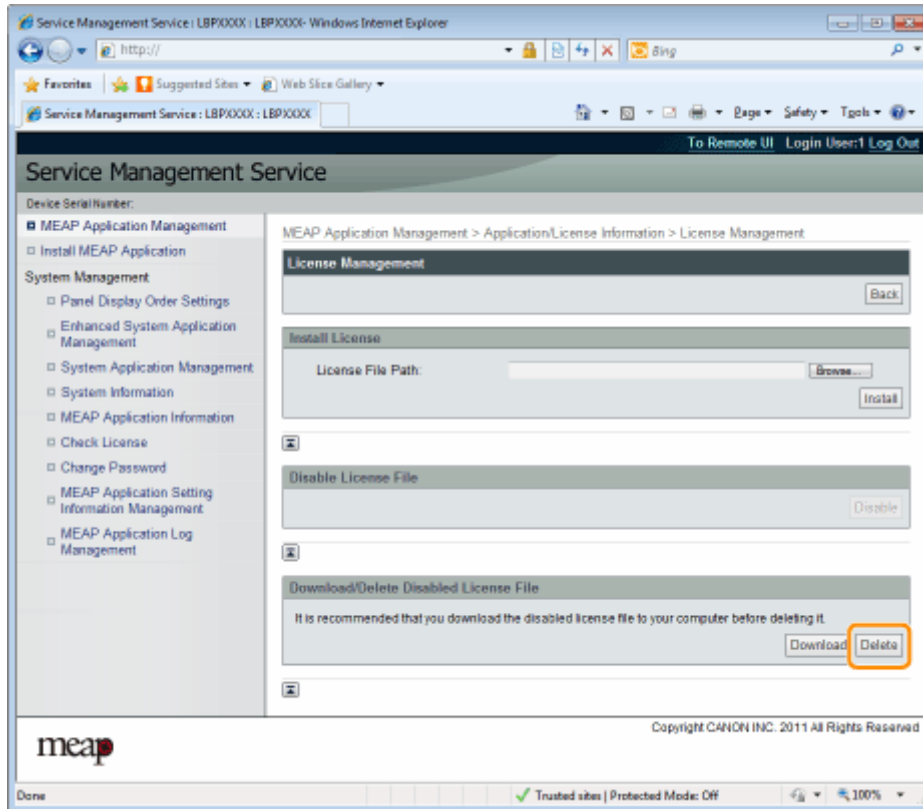

6 Click [Yes].

→ The license file is deleted.

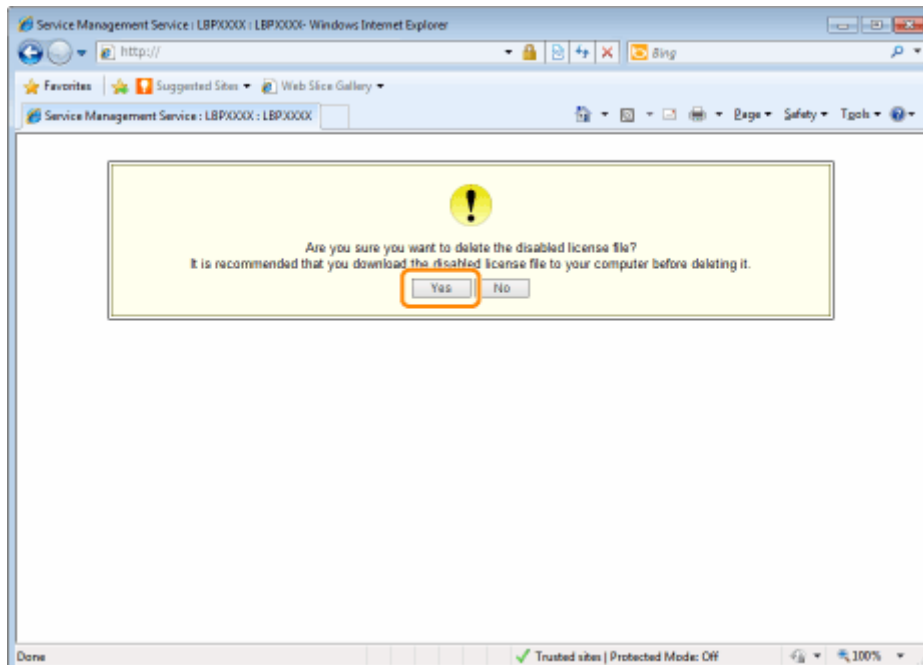

Setting Authentication Information for MEAP Applications

0XW7-00U

When processing jobs from applications that do not require operation from the printer, you must first set the authentication information.

1 Start SMS (Service Management Service).

▶ " Launching SMS (Log in)(P. 9) "

2 Click [MEAP Application Management].

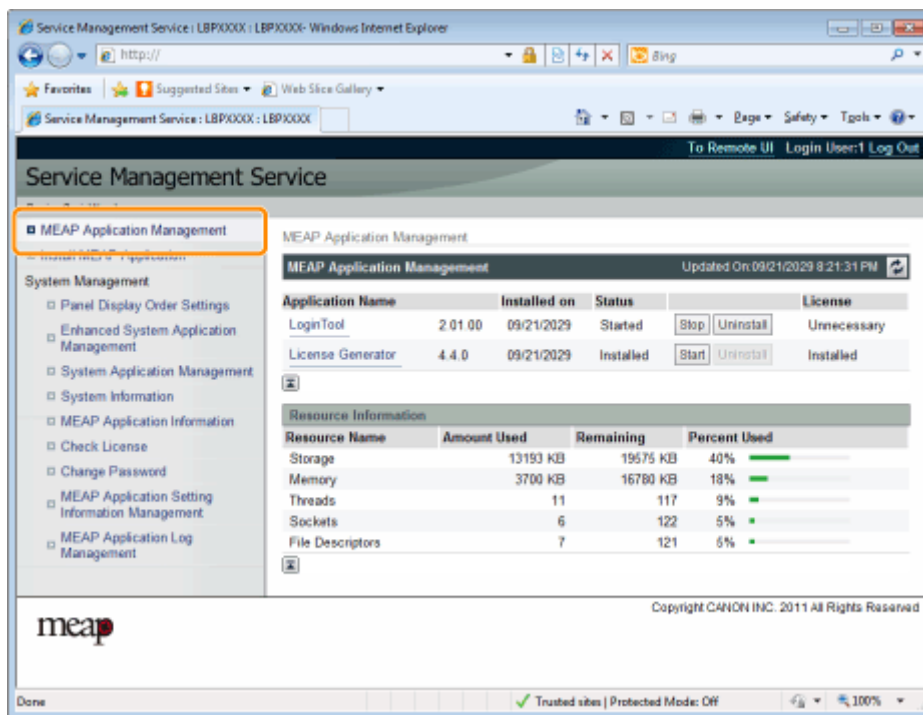

The screenshot shows the Service Management Service web interface in Internet Explorer. The left sidebar contains a navigation menu with 'MEAP Application Management' highlighted. The main content area displays 'MEAP Application Management' with a table of installed applications and a 'Resource Information' section.

Application Name	Installed on	Status	License
LoginTool	2 01 00 09/21/2029	Started	Unnecessary
License Generator	4 4 0 09/21/2029	Installed	Installed

Resource Name	Amount Used	Remaining	Percent Used
Storage	13193 KB	19575 KB	40%
Memory	3700 KB	16780 KB	18%
Threads	11	117	9%
Sockets	6	122	5%
File Descriptors	7	121	6%

3 Click the name of the application for which to set authentication information.

MEAP Application Settings

The screenshot shows the Service Management Service web interface. The left sidebar contains a navigation menu with the following items:

- MEAP Application Management
 - Install MEAP Application
- System Management
 - Panel Display Order Settings
 - Enhanced System Application Management
 - System Application Management
 - System Information
 - MEAP Application Information
 - Check License
 - Change Password
 - MEAP Application Setting Information Management
 - MEAP Application Log Management

The main content area displays 'MEAP Application Management' with a table of installed applications:

Application Name	Installed on	Status	License
LoginTool	2.01.00 09/21/2029	Started	Unnecessary
License Generator	4.4.0 09/21/2029	Installed	Installed

The 'License Generator' application is highlighted with an orange box. Below the table is a 'Resource Information' section with a table:

Resource Name	Amount Used	Remaining	Percent Used
Storage	13193 KB	19575 KB	40%
Memory	3700 KB	16700 KB	18%
Threads	11	117	9%
Sockets	6	122	5%
File Descriptors	7	121	6%

4 Click [Authentication Information Settings].

The screenshot shows the Service Management Service web interface. The left sidebar contains the same navigation menu as in the previous screenshot. The main content area displays 'MEAP Application Management > Application/License Information' with a table of application details:

Application Information	
Application Name:	License Generator
Version:	4.4.0
Application ID:	c7cf685-4319-4f24-b511-bb09c8090cc
Installed on:	09/20/2029
Description:	genlic
Manufacturer:	Canon Inc.
Import Package:	javax.servlet javax.servlet.http org.osgi.service.http com.canon.meap.service.http
Import Service:	com.canon.meap.service.http.HttpService
Resources Used	
Storage:	10000 KB
Memory:	850 KB
Threads:	1
Sockets:	0
File Descriptors:	3

The 'Authentication Information Settings' button is highlighted with an orange box. Below the application information is a 'License Information' section with a table:

License Information	
Status:	Installed
Serial Number:	XXXXXXXXXX
Expires after:	Does not Expire

5 Enter the authentication information.

If you use department ID management

Enter the department ID and password in the fields marked [Department ID] and [PIN].

If you do not use department ID management

Enter an arbitrary ID and password in the fields marked [Department ID] and [PIN].

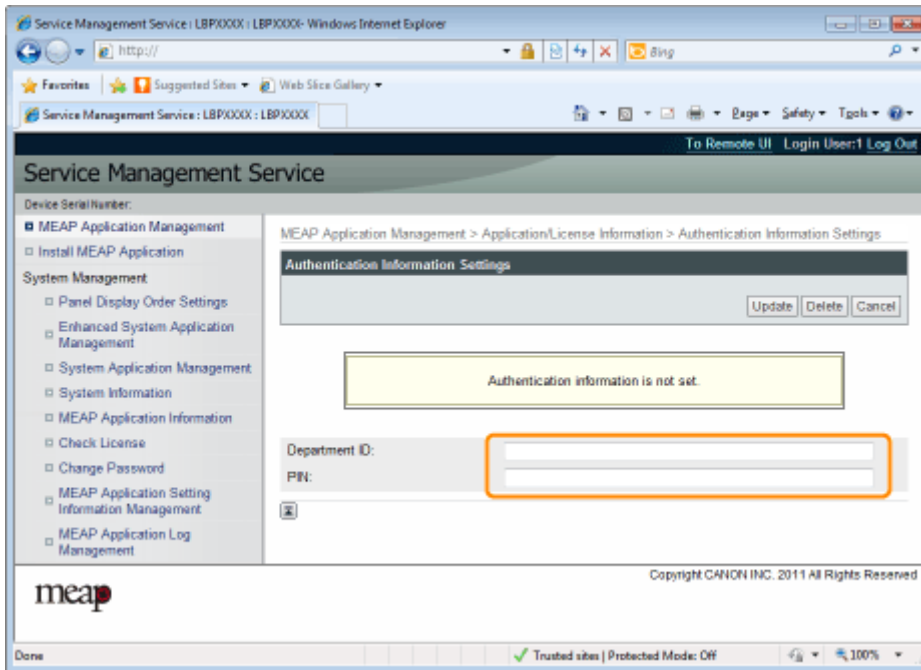

6 Click [Update].

→ Authentication information is set.

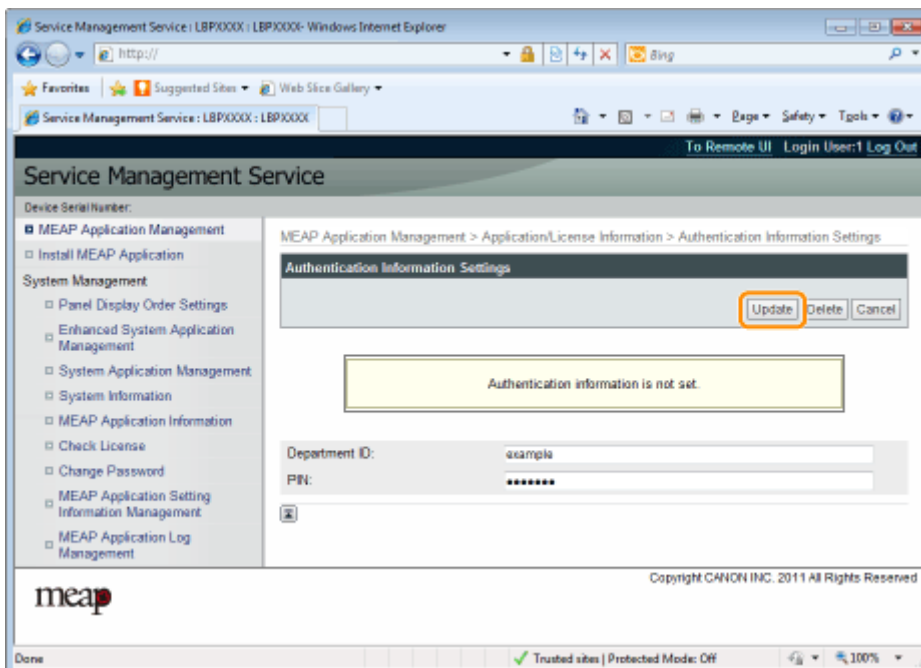

 **IMPORTANT**

When cancelling authentication information

Click [Delete].

System Settings

System Settings	49
Changing the MEAP Applet Display Order	50
Checking Login Services	52
Setting Enhanced System Applications	54
Starting/Stopping Enhanced System Applications	55
Starting Enhanced System Applications	56
Stopping Enhanced System Applications	57
Installing Enhanced System Applications	58
Uninstalling Enhanced System Applications	61
Checking Information	62
Checking System Information	63
Checking Application Information	65
Checking License Files	66
Changing the SMS Password	67
Deleting the MEAP Application Setting Information	69
Managing MEAP Application Log Data	71
Downloading Log Data	72
Deleting Log Data	74

System Settings

OXW7-00W

The [System Management] menu contains the following items.

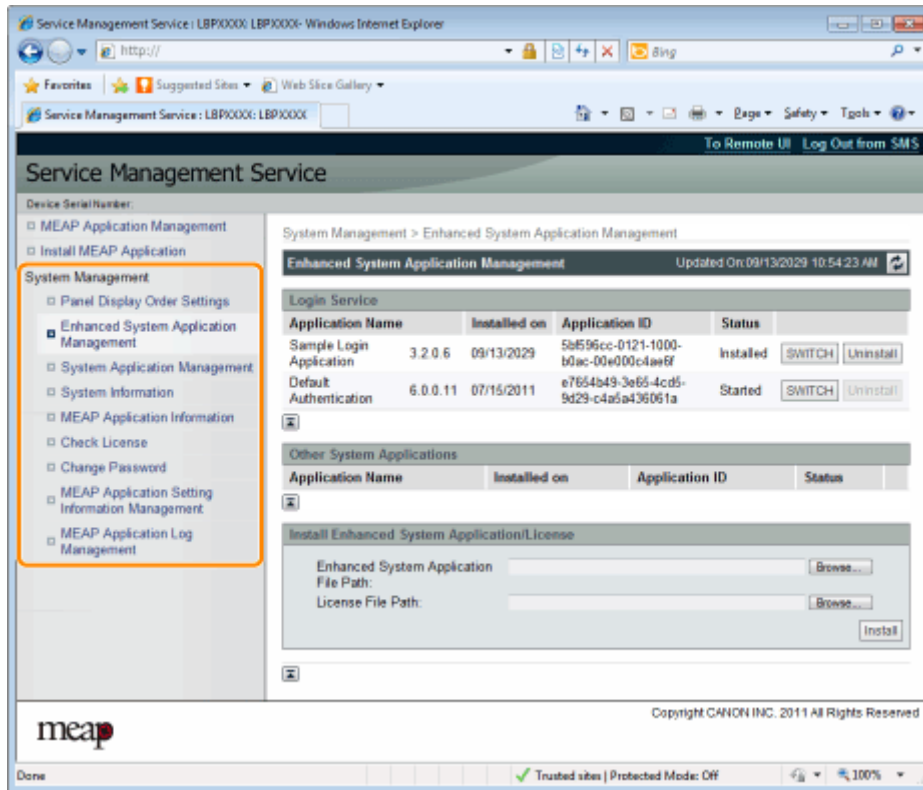

[Panel Display Order Settings]	It sets the order MEAP applets are displayed on the operation panel. ▶ " Changing the MEAP Applet Display Order(P. 50) "
[Enhanced System Application Management]	It displays enhanced system application status and performs settings. You can also set log in service settings. ▶ " Setting Enhanced System Applications(P. 54) "
[System Application Management]	It displays system application status and performs start/stop operations.
[System Information]	It displays versions and system application information, etc. ▶ " Checking System Information(P. 63) "
[MEAP Application Information]	It displays the details about MEAP applications. ▶ " Checking Application Information(P. 65) "
[Check License]	It checks the content of the license file before it is installed. ▶ " Checking License Files(P. 66) "
[Change Password]	It changes the SMS log in password. ▶ " Changing the SMS Password(P. 67) "
[MEAP Application Setting Information Management]	It deletes the details about MEAP applications. ▶ " Deleting the MEAP Application Setting Information(P. 69) "
[MEAP Application Log Management]	It downloads and deletes log data obtained by MEAP applications. ▶ " Managing MEAP Application Log Data(P. 71) "

Changing the MEAP Applet Display Order

0XW7-00X

The applet display order changes when you press [Application] key on the control panel.

1 Start SMS (Service Management Service).

▶ " Launching SMS (Log in)(P. 9) "

2 Click [Panel Display Order Settings].

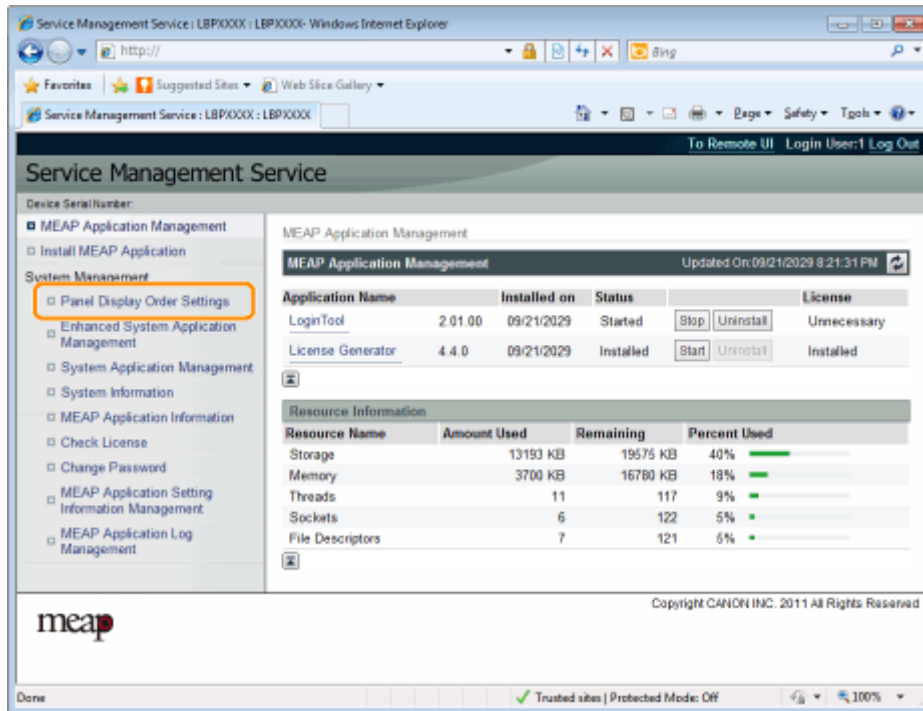

The screenshot shows the Service Management Service web interface in a browser window. The left sidebar contains a tree view of system management options. The 'Panel Display Order Settings' option is highlighted with a red box. The main content area displays 'MEAP Application Management' with a table of installed applications and a 'Resource Information' section showing system usage statistics.

Application Name	Installed on	Status	License
LoginTool	2.01.00 09/21/2029	Started	Unnecessary
License Generator	4.4.0 09/21/2029	Installed	Installed

Resource Name	Amount Used	Remaining	Percent Used
Storage	13193 KB	19575 KB	40%
Memory	3700 KB	16780 KB	18%
Threads	11	117	9%
Sockets	6	122	5%
File Descriptors	7	121	6%

3 Select the check boxes for the applets whose display order you wish to change.

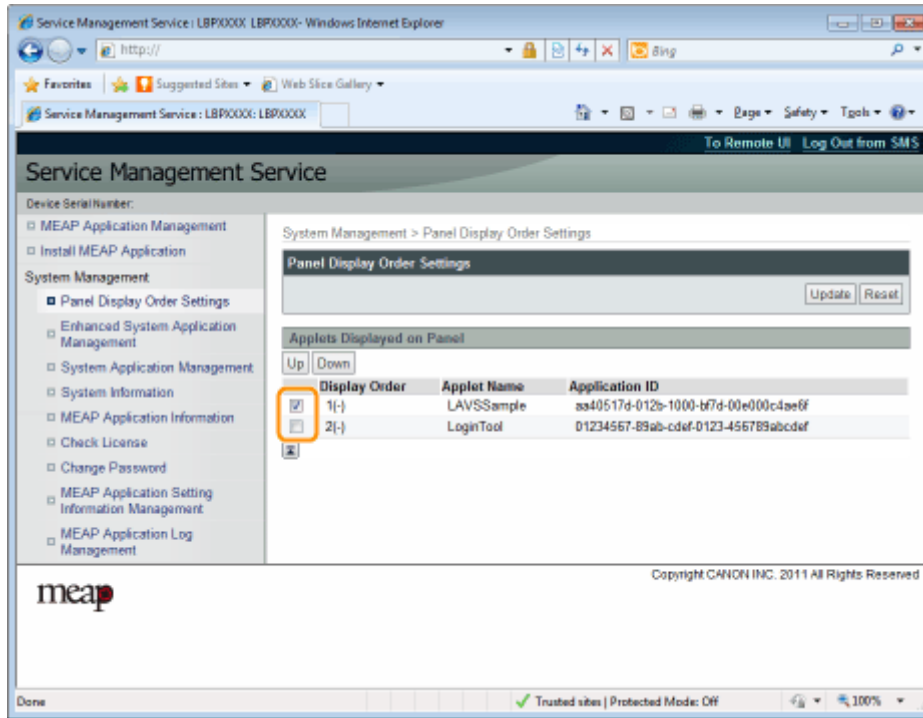

4 The display order changes.

- (1) Move the applets up and down by clicking [Up] and [Down].
- (2) Click [Update].

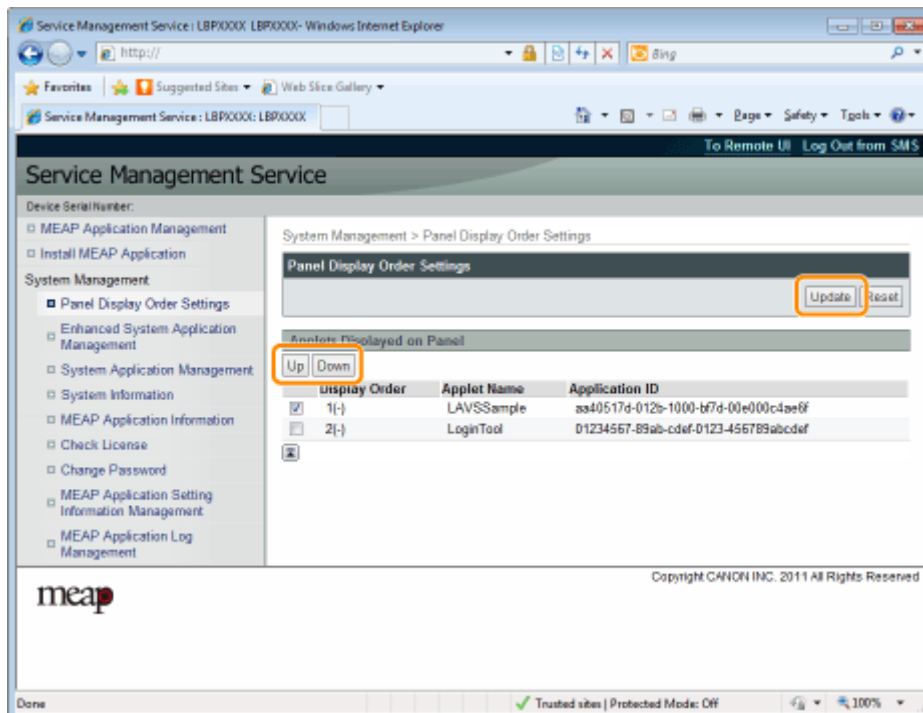

Checking Login Services

OXW7-00Y

Check the login services that perform user authentication.

1 Start SMS (Service Management Service).

☞ " Launching SMS (Log in)(P. 9) "

2 Click [Enhanced System Application Management].

The screenshot shows a web browser window displaying the Service Management Service interface. The left sidebar contains a navigation menu with the following items:

- MEAP Application Management
 - Install MEAP Application
- System Management
 - Panel Display Order Settings
 - Enhanced System Application Management** (highlighted with an orange box)
 - System Application Management
 - System Information
- MEAP Application Information
 - Check License
 - Change Password
- MEAP Application Setting Information Management
- MEAP Application Log Management

The main content area displays the MEAP Application Management page, which includes a table of installed applications and a resource information section.

Application Name	Installed on	Status	License
LoginTool	2.01.00 09/21/2029	Started	Unnecessary
License Generator	4.4.0 09/21/2029	Installed	Installed

Resource Name	Amount Used	Remaining	Percent Used
Storage	13193 KB	19575 KB	40%
Memory	3700 KB	16780 KB	18%
Threads	11	117	9%
Sockets	6	122	5%
File Descriptors	7	121	6%

Copyright CANON INC. 2011 All Rights Reserved

3 Check the status of log in service.

The screenshot displays the Service Management Service web interface in Internet Explorer. The browser address bar shows 'http://'. The page title is 'Service Management Service'. The main content area is titled 'System Management > Enhanced System Application Management' and 'Enhanced System Application Management', with a timestamp of 'Updated On: 09/13/2029 10:54:23 AM'. A left-hand navigation menu is highlighted with an orange box, containing the following items:

- Device Serial Number
- MEAP Application Management
- Install MEAP Application
- System Management**
 - Panel Display Order Settings
 - Enhanced System Application Management**
 - System Application Management
 - System Information
 - MEAP Application Information
 - Check License
 - Change Password
 - MEAP Application Setting Information Management
 - MEAP Application Log Management

The main content area features a table for 'Login Service' with the following data:

Application Name	Installed on	Application ID	Status	
Sample Login Application	3.2.0.6 09/13/2029	5b596cc-0121-1000-b0ac-00e000c1ae6f	Installed	<input type="button" value="SWITCH"/> <input type="button" value="Uninstall"/>
Default Authentication	6.0.0.11 07/15/2011	e7654b49-3e65-4cd5-9d29-c4a5a436061a	Started	<input type="button" value="SWITCH"/> <input type="button" value="Uninstall"/>

Below the table is a section for 'Other System Applications' with a table structure:

Application Name	Installed on	Application ID	Status
[Empty Row]			

At the bottom of the main content area is the 'Install Enhanced System Application/License' section, which includes input fields for 'Enhanced System Application File Path' and 'License File Path', each with a 'Browse...' button, and an 'Install' button.

The footer of the page contains the 'meap' logo and the text 'Copyright CANON INC. 2011 All Rights Reserved'. The browser status bar at the bottom shows 'Done', 'Trusted sites | Protected Mode: Off', and '100%' zoom.

Setting Enhanced System Applications

0XW7-010

They perform the operations of the enhanced system applications that enhance the system applications (the basic applications that make up the MEAP system).

- **Starting/Stopping Enhanced System Applications(P. 55)**

- ▶ **Starting Enhanced System Applications(P. 56)**

- ▶ **Stopping Enhanced System Applications(P. 57)**

- **Installing Enhanced System Applications(P. 58)**

- **Uninstalling Enhanced System Applications(P. 61)**

Starting/Stopping Enhanced System Applications

0XW7-011

➤ **Starting Enhanced System Applications(P. 56)**

➤ **Stopping Enhanced System Applications(P. 57)**

Starting Enhanced System Applications

OXW7-012

1 Start SMS (Service Management Service).

▶ " Launching SMS (Log in)(P. 9) "

2 Click [Enhanced System Application Management].

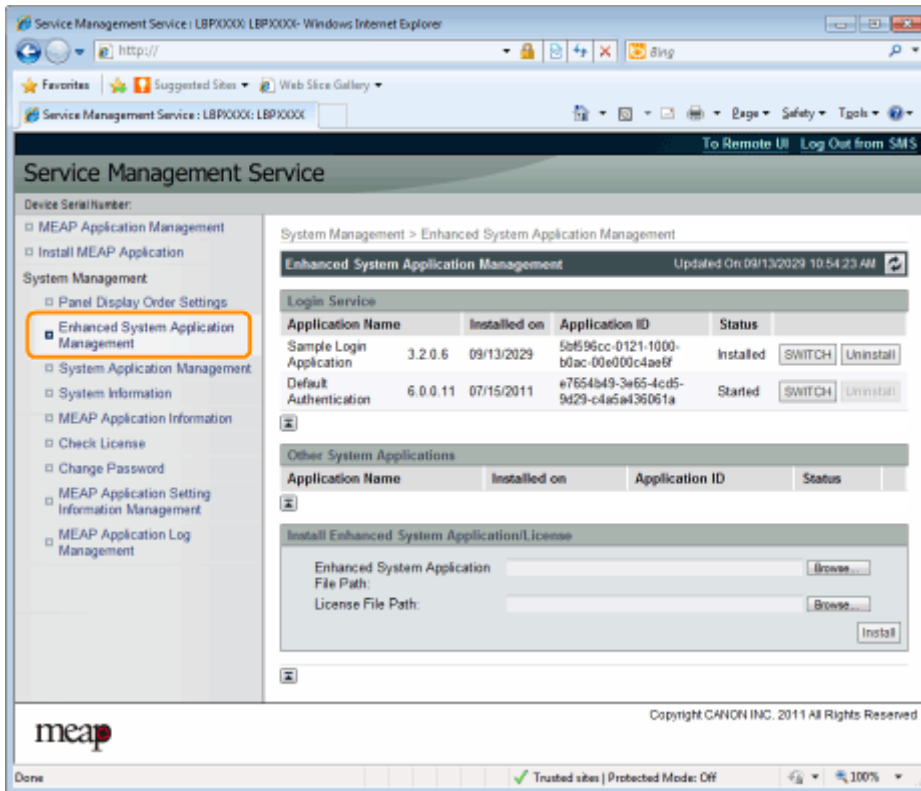

The screenshot shows the Service Management Service web interface in Internet Explorer. The page title is "Service Management Service". The breadcrumb navigation is "System Management > Enhanced System Application Management". The main content area is titled "Enhanced System Application Management" and is updated on 09/13/2029 10:54:23 AM. It contains a table for "Login Service" with the following data:

Application Name	Installed on	Application ID	Status
Sample Login Application	3.2.0.6 09/13/2029	5b596cc-0121-1000-b0ac-00e000c4ae6f	Installed [SWITCH] [Uninstall]
Default Authentication	6.0.0.11 07/15/2011	e7654b49-3a65-4cd5-9d29-c4a6a436061a	Started [SWITCH] [Uninstall]

Below the table is a section for "Other System Applications" with a table structure:

Application Name	Installed on	Application ID	Status
[Empty row]			

At the bottom, there is an "Install Enhanced System Application/License" section with input fields for "Enhanced System Application File Path" and "License File Path", each with a "Browse..." button, and an "Install" button.

3 Click [Start] for Other System Applications, and then start the application.

When the [License Agreement] appears, confirm the information, and then click [I Accept].

Stopping Enhanced System Applications

OXW7-013

1 Start SMS (Service Management Service).

▶ " Launching SMS (Log in)(P. 9) "

2 Click [Enhanced System Application Management].

The screenshot shows the Service Management Service web interface in Internet Explorer. The browser address bar shows 'http://'. The page title is 'Service Management Service'. The main content area is titled 'System Management > Enhanced System Application Management'. It features a table of 'Login Service' applications and a section for 'Other System Applications'.

Application Name	Installed on	Application ID	Status
Sample Login Application	3.2.0.6 09/13/2029	5b596cc-0121-1000-b0ac-00e000c4ae6f	Installed [SWITCH] [Uninstall]
Default Authentication	6.0.0.11 07/15/2011	e7654b49-3a65-4cd5-9d29-c4a5a436061a	Started [SWITCH] [Uninstall]

Below the table, there is a section for 'Other System Applications' with columns for Application Name, Installed on, Application ID, and Status. At the bottom, there is a form to 'Install Enhanced System Application/License' with fields for 'Enhanced System Application File Path' and 'License File Path', each with a 'Browse...' button, and an 'Install' button.

3 Click [Stop] for Other System Applications, and then stop the application.

Installing Enhanced System Applications

OXW7-014

1 Start SMS (Service Management Service).

▶ " Launching SMS (Log in)(P. 9) "

2 Click [Enhanced System Application Management].

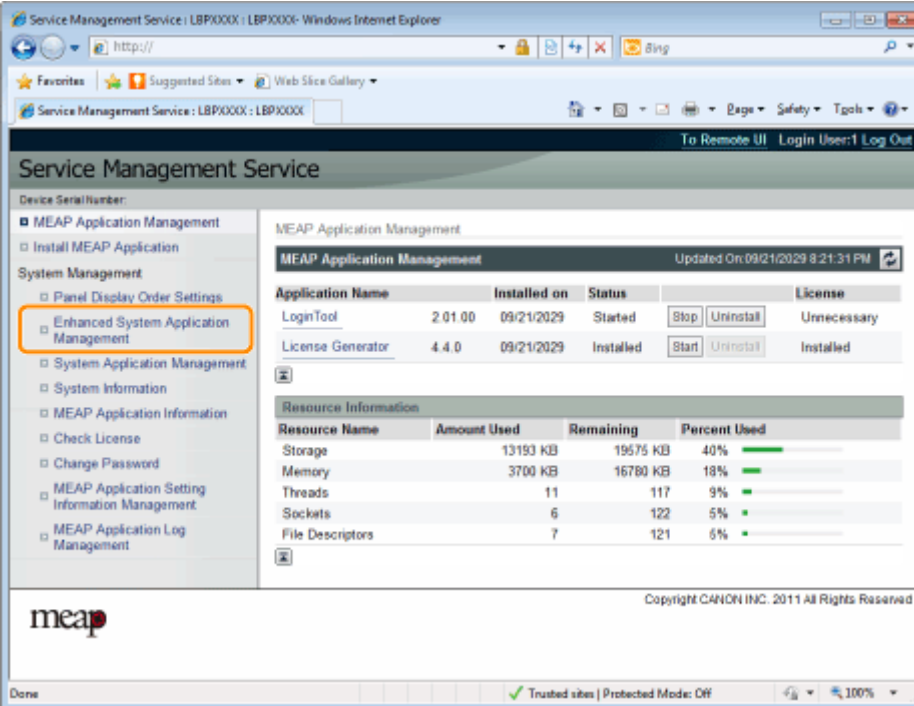

The screenshot shows the Service Management Service web interface in a Windows Internet Explorer browser. The page title is "Service Management Service". On the left sidebar, under "System Management", the "Enhanced System Application Management" option is highlighted with an orange box. The main content area displays "MEAP Application Management" with a table of installed applications and a "Resource Information" section.

Application Name	Installed on	Status	License
LoginTool	2.01.00 09/21/2029	Started	Unnecessary
License Generator	4.4.0 09/21/2029	Installed	Installed

Resource Name	Amount Used	Remaining	Percent Used
Storage	13153 KB	19575 KB	40%
Memory	3700 KB	16780 KB	18%
Threads	11	117	9%
Sockets	6	122	5%
File Descriptors	7	121	6%

3 Set [Enhanced System Application File Path] and [License File Path].

Either select the file by clicking [Browse...], or enter the location where the file is stored.

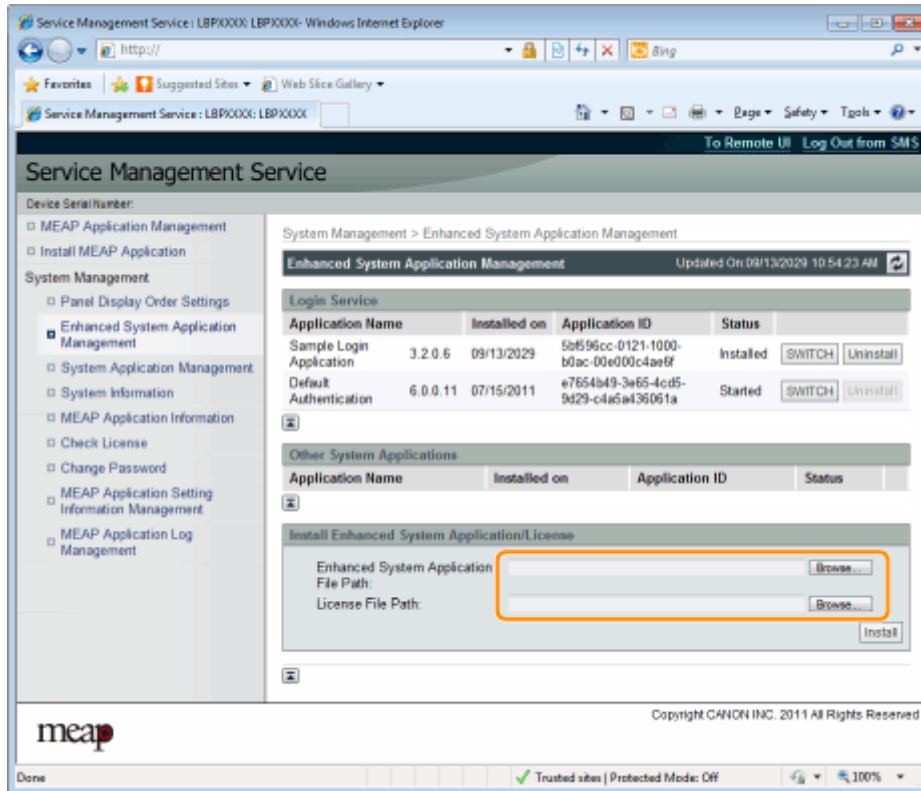

[Enhanced System Application File Path]	Specify a file with a "jar" extension.
[License File Path]	Specify a file with a "lic" extension.

IMPORTANT

When specifying a file
Specify both the application file and the license file.

4 Click [Install].

Service Management Service : LBPXXXX: LBPXXXX- Windows Internet Explorer

http://

Service Management Service : LBPXXXX: LBPXXXX

To Remote UI Log Out from SMS

Service Management Service

Device Serial Number:

- MEAP Application Management
- Install MEAP Application

System Management

- Panel Display Order Settings
- Enhanced System Application Management
- System Application Management
- System Information
- MEAP Application Information
- Check License
- Change Password
- MEAP Application Setting Information Management
- MEAP Application Log Management

System Management > Enhanced System Application Management

Enhanced System Application Management

Updated On: 09/13/2029 10:54:23 AM

Login Service

Application Name	Installed on	Application ID	Status		
Sample Login Application	3.2.0.6 09/13/2029	5b596cc-0121-1000-b0ac-00e000c4ae8f	Installed	SWITCH	Uninstall
Default Authentication	6.0.0.11 07/15/2011	e7654b49-3e65-4cd5-9d29-c4a5a436061a	Started	SWITCH	Uninstall

Other System Applications

Application Name	Installed on	Application ID	Status
------------------	--------------	----------------	--------

Install Enhanced System Application(License)

Enhanced System Application File Path:

License File Path:

Copyright CANON INC. 2011 All Rights Reserved

meap

Done Trusted sites | Protected Mode: Off 100%

5 Confirm the information on the install confirmation page, and then click [Yes].

When the [License Agreement] appears, confirm the information, and then click [I Accept].

→ The installation begins.

Uninstalling Enhanced System Applications

OXW7-015

NOTE

Deleting License Files

There is no need to delete license files before uninstalling enhanced system applications.

1 Start SMS (Service Management Service).

▶ " Launching SMS (Log in)(P. 9) "

2 Click [Enhanced System Application Management].

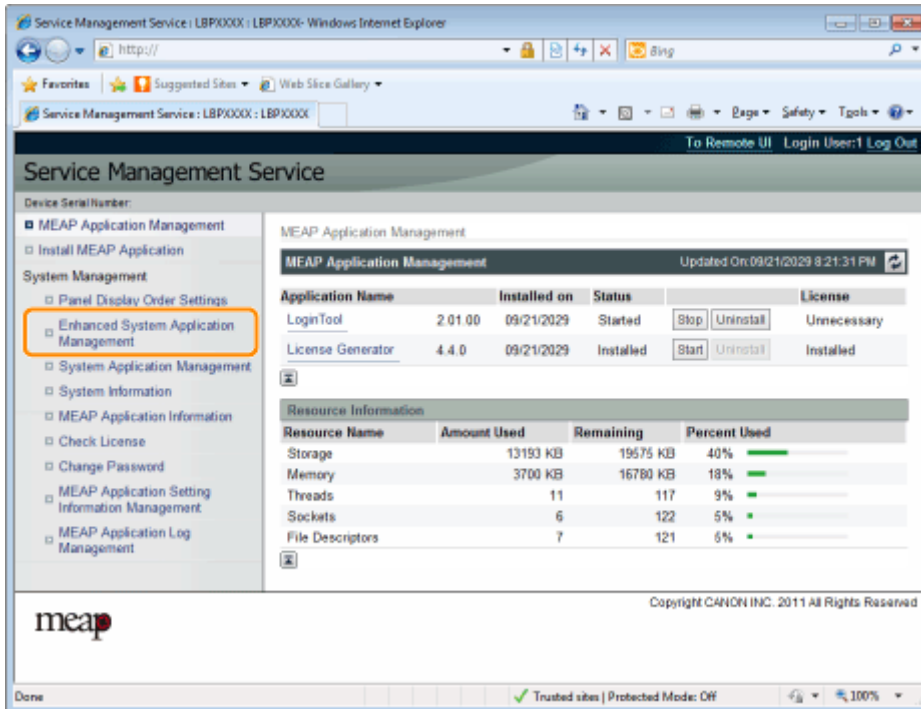

The screenshot shows the Service Management Service web interface. The left sidebar contains a navigation menu with the following items:

- MEAP Application Management
 - Install MEAP Application
- System Management
 - Panel Display Order Settings
 - Enhanced System Application Management** (highlighted with a red box)
 - System Application Management
 - System Information
 - MEAP Application Information
 - Check License
 - Change Password
 - MEAP Application Setting Information Management
 - MEAP Application Log Management

The main content area displays the MEAP Application Management section, updated on 09/21/2029 8:21:31 PM. It contains a table of installed applications:

Application Name	Installed on	Status	License
LoginTool	2 01 00 09/21/2029	Started	Unnecessary
License Generator	4 4 0 09/21/2029	Installed	Installed

Below the table is a Resource Information section with the following data:

Resource Name	Amount Used	Remaining	Percent Used
Storage	13193 KB	19575 KB	40%
Memory	3700 KB	16780 KB	18%
Threads	11	117	9%
Sockets	6	122	5%
File Descriptors	7	121	6%

The interface also includes a 'meap' logo and a copyright notice: Copyright CANON INC. 2011 All Rights Reserved.

3 Click [Uninstall] for the application to uninstall.

† Applications with [Uninstall] grayed out cannot be deleted.

4 Click [Yes].

→ The uninstall begins.

Checking Information

0XW7-016

➤ **Checking System Information(P. 63)**

➤ **Checking Application
Information(P. 65)**

➤ **Checking License Files(P. 66)**

Checking System Information

0XW7-017

You can check the version information of platforms such as Java virtual machine and version information, date of installation and status of system applications.

1 Start SMS (Service Management Service).

▶ " Launching SMS (Log in)(P. 9) "

2 Click [System Information].

The screenshot shows the Service Management Service web interface in a Windows Internet Explorer browser. The page title is "Service Management Service". The left sidebar contains a navigation menu with "System Information" highlighted. The main content area displays "System Management > System Information" and "System Information" updated on 00212029 0:22:07 PM. Below this, there are two tables: "Platform Information" and "System Application Information".

Name	Version
MEAP Specifications	15.18.19.25.26.27.29.34.39.45.47.50.51.52.54.55.57.58.60.61.62.63.74
MEAP Contents	01.32
Java Virtual Machine	06.00.3

Application Name	Installed on	Application ID	Status	
DSL Installer Service	3.0.4.6	07/15/2011	2ca34a18-7f8a-4fd9-8de9-511a2963b733	Started
SMS Installer Service	3.1.0.27	07/15/2011	c70590d0-c601-49ef-9c23-3d9e452194db	Started
Service Management Service	2.11.0.13	07/15/2011	c6b78400-9a49-45a7-a08a-9aa393e62287	Started

Click [Display Details] to check detailed information.

The screenshot shows a web browser window displaying the Service Management Service interface. The browser address bar shows 'http://'. The page title is 'Service Management Service'. The left sidebar contains a navigation menu with the following items:

- Device Serial Number
- MEAP Application Management
 - Install MEAP Application
- System Management
 - Panel Display Order Settings
 - Enhanced System Application Management
 - System Application Management
 - System Information**
 - MEAP Application Information
 - Check License
 - Change Password
 - MEAP Application Setting Information Management
 - MEAP Application Log Management

The main content area is titled 'System Management > System Information' and 'System Information' (Updated On: 09/21/2029 9:22:07 PM). It contains two sections:

Platform Information

Name	Version
MEAP Specifications	15, 18, 19, 25, 26, 27, 29, 34, 39, 45, 47, 50, 51, 52, 54, 55, 57, 58, 60, 61, 62, 63, 74
MEAP Contents	01.32
Java Virtual Machine	06.00.3

System Application Information

A 'Display Details' link is highlighted with a red box. Below it is a table of installed services:

Application Name	Version	Installed on	Application ID	Status
DSL Installer Service	3.0.4.6	07/15/2011	2ca34a18-7f8a-4fd9-bde9-511a2963b733	Started
SMS Installer Service	3.1.0.27	07/15/2011	c70590d0-c691-49ef-9c23-3d9e452194db	Started
Service Management Service	2.11.0.13	07/15/2011	c6b78400-9a49-45a7-a08a-9aa393e62287	Started

The footer of the page includes the 'meap' logo and the text 'Copyright CANON INC. 2011 All Rights Reserved'. The browser status bar at the bottom shows 'Done', 'Trusted sites | Protected Mode: Off', and '100%' zoom.

Checking Application Information

OXW7-018

You can check the information about installed or uninstalled applications (except for system applications).

1 Start SMS (Service Management Service).

▶ " Launching SMS (Log in)(P. 9) "

2 Click [MEAP Application Information].

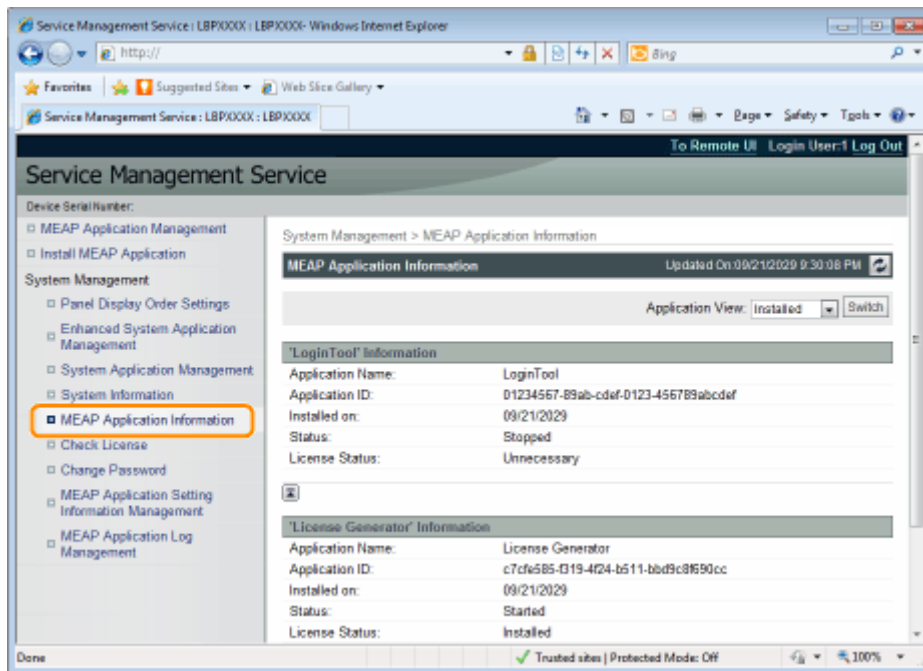

3 Information about applications is displayed.

(1) Select [Installed] or [Uninstalled].

(2) Click [Switch].

[Installed]	Information about installed applications (except for system applications) is displayed.
[Uninstalled]	Information about uninstalled applications (except for system applications) is displayed.

Checking License Files

0XW7-019

You can check the content of the license file before it is installed.

1 Start SMS (Service Management Service).

▶ " Launching SMS (Log in)(P. 9) "

2 Click [Check License].

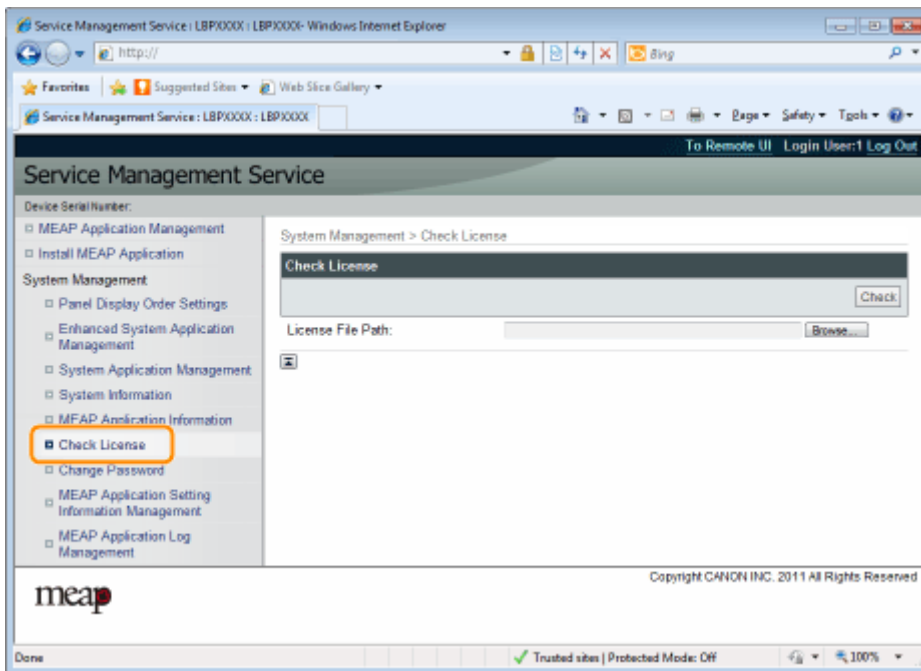

3 Either select the file by clicking [Browse], or enter the location where the file is stored.

4 Click [Check].

→ The content of the license file is displayed.

Changing the SMS Password

0XW7-01A

IMPORTANT

SMS Password

- To prevent unauthorized access, we recommend that the administrator change the password before SMS use is begun.
- This password is to prevent unauthorized operation of the printer. Do not let anyone know except the administrator.
- Make sure that you do not forget your password. If you forget your password, you will not be able to use SMS. If this happens, contact your local dealer.

1 Start SMS (Service Management Service).

" Launching SMS (Log in)(P. 9) "

2 Click [Change Password].

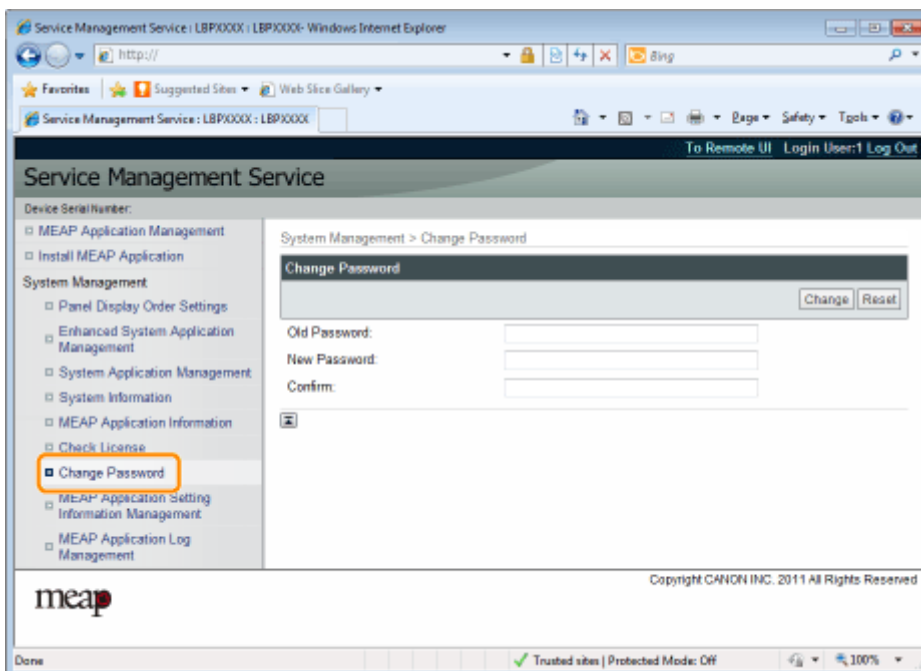

3 Set the password.

- (1) Set the password.
- (2) Click [Change].

† Enter between 8 and 32 alphanumeric characters (a to z, A to Z, and 0 to 9) for the password.

[Old Password]	Enter the password that is currently used.
[New Password]	Enter the new password.

System Settings

[Confirm]	Enter the same password again in [New Password].
-----------	--

Deleting the MEAP Application Setting Information

0XW7-01C

Deletes the application data.

1 Start SMS (Service Management Service).

☛ " Launching SMS (Log in)(P. 9) "

2 Click [MEAP Application Setting Information Management].

The screenshot shows the Service Management Service web interface. The left sidebar contains a navigation menu with the following items:

- MEAP Application Management
 - Install MEAP Application
- System Management
 - Panel Display Order Settings
 - Enhanced System Application Management
 - System Application Management
 - System Information
 - MEAP Application Information
 - Check License
 - Change Password
 - MEAP Application Setting Information Management** (highlighted with an orange box)
 - MEAP Application Log Management

The main content area displays the MEAP Application Management page. It includes a table of installed applications:

Application Name	Installed on	Status	License
LoginTool	2.01.00 09/21/2029	Started	Unnecessary
License Generator	4.4.0 09/21/2029	Installed	Installed

Below the table is a 'Resource Information' section with a table showing system resource usage:

Resource Name	Amount Used	Remaining	Percent Used
Storage	13193 KB	19575 KB	40%
Memory	3700 KB	16780 KB	18%
Threads	11	117	9%
Sockets	6	122	5%
File Descriptors	7	121	6%

The interface also includes a 'MEAP Application Management' header with a 'Delete' button and a 'Resource Information' section with a 'Delete' button. The footer shows the MEAP logo and copyright information: Copyright CANON INC. 2011 All Rights Reserved.

3 Select the check box for the application whose setting information you wish to delete, and then click [Delete].

Click [Select All] to select all of the applications.

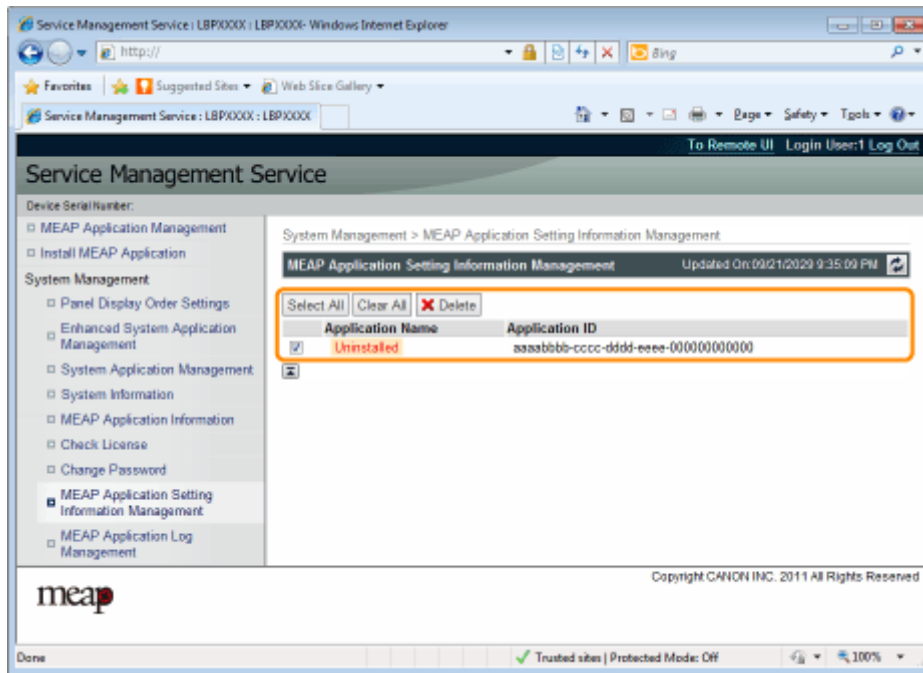

4 Click [Yes].

→ The setting information of the application is deleted.

Managing MEAP Application Log Data

0XW7-01E

It downloads and deletes log data obtained by MEAP applications.

➤ **Downloading Log Data(P. 72)**

➤ **Deleting Log Data(P. 74)**

Downloading Log Data

OXW7-01F

1 Start SMS (Service Management Service).

▶ " Launching SMS (Log in)(P. 9) "

2 Click [MEAP Application Log Management].

The screenshot shows the Service Management Service web interface in Internet Explorer. The left sidebar contains a navigation menu with the following items:

- MEAP Application Management
- Install MEAP Application
- System Management
 - Panel Display Order Settings
 - Enhanced System Application Management
 - System Application Management
 - System Information
 - MEAP Application Information
 - Check License
 - Change Password
 - MEAP Application Setting Information Management
 - MEAP Application Log Management (highlighted with an orange box)

The main content area displays the MEAP Application Management page, which includes a table of installed applications and a resource information section.

Application Name	Installed on	Status	License
LoginTool	2.01.00 09/21/2029	Stated	Unnecessary
License Generator	4.4.0 09/21/2029	Installed	Installed

Resource Name	Amount Used	Remaining	Percent Used
Storage	13193 KB	19575 KB	49%
Memory	3700 KB	16780 KB	18%
Threads	11	117	9%
Sockets	6	122	5%
File Descriptors	7	121	5%

3 Click [Download Application Logs].

The screenshot shows the Service Management Service web interface with the MEAP Application Log Management page selected. The left sidebar navigation menu is the same as in the previous screenshot, but the 'MEAP Application Log Management' item is now expanded and highlighted with an orange box.

The main content area displays the MEAP Application Log Management page, which includes the following options:

- Download Application Logs (highlighted with an orange box)
- Delete Application Logs

4 Follow the on-screen instructions and specify a file storage directory.

→ The log file is saved.

Deleting Log Data

OXW7-01H

1 Start SMS (Service Management Service).

▶ " Launching SMS (Log in)(P. 9) "

2 Click [MEAP Application Log Management].

The screenshot shows the Service Management Service web interface in Internet Explorer. The left sidebar contains a navigation menu with the following items:

- MEAP Application Management
 - Install MEAP Application
- System Management
 - Panel Display Order Settings
 - Enhanced System Application Management
 - System Application Management
 - System Information
 - MEAP Application Information
 - Check License
 - Change Password
 - MEAP Application Setting Information Management
 - MEAP Application Log Management (highlighted with a red box)

The main content area displays the MEAP Application Management page, which includes a table of installed applications and a resource information section.

Application Name	Installed on	Status	License
LoginTool	2.01.00 09/21/2029	Started	Unnecessary
License Generator	4.4.0 09/21/2029	Installed	Installed

Resource Name	Amount Used	Remaining	Percent Used
Storage	13193 KB	19575 KB	49%
Memory	3700 KB	16780 KB	18%
Threads	11	117	9%
Sockets	6	122	5%
File Descriptors	7	121	5%

3 Click [Delete Application Logs].

The screenshot shows the Service Management Service web interface with the MEAP Application Log Management page selected. The left sidebar is the same as in the previous screenshot. The main content area displays the MEAP Application Log Management page with the following options:

- Download Application Logs
- Delete Application Logs (highlighted with a red box)

4 Click [Yes].

→ The log data is deleted.

List of Error Messages (MEAP)

List of Error Messages (MEAP)	77
Errors Relating to the [Login] Page	79
Errors Relating to the [MEAP Application Management] Page	81
Errors Relating to the [Install MEAP Application] Page	83
Errors Relating to the [Authentication Information Settings] Page	88
Errors Relating to the [License Management] Page	89
Errors Relating to the [Enhanced System Application Management] Page	91
Errors Relating to the [Check License] and [Change Password] Pages	97
Errors Relating to the [MEAP Application Setting Information Management] Page	99
Errors Relating to the [MEAP Application Log Management] Page	100
Other Errors	101

List of Error Messages (MEAP)

0XW7-01J

This section describes how to handle error messages that are displayed when logging in to or operating SMS.

The error messages are divided into separate pages. Click the following links and perform the necessary actions.

➤ **Errors Relating to the [Login]
Page(P. 79)**

➤ **Errors Relating to the [MEAP
Application Management] Page(P. 81)**

➤ **Errors Relating to the [Install MEAP
Application] Page(P. 83)**

➤ **Errors Relating to the
[Authentication Information Settings]
Page(P. 88)**

➤ **Errors Relating to the [License
Management] Page(P. 89)**

➤ **Errors Relating to the [Enhanced
System Application Management]
Page(P. 91)**

➤ **Errors Relating to the [Check
License] and [Change Password]
Pages(P. 97)**

❖ **Errors Relating to the [MEAP Application Setting Information Management] Page(P. 99)**

❖ **Errors Relating to the [MEAP Application Log Management] Page(P. 100)**

❖ **Other Errors(P. 101)**

Errors Relating to the [Login] Page

0XW7-01K

- < The specified file does not exist or the file path is incorrect. Try to specify the path again.(P. 79) >
- < The contents of the specified file are incorrect or information is missing. Check the file.(P. 79) >
- < The specified switch license file cannot be used for password initialization. Try to specify the file again. (P. 79) >
- < Cannot initialize password because a used switch license file is specified. Try to specify the file again. (P. 79) >
- < Cannot initialize the password because another application is being installed, or the firmware being updated. Please wait a moment and then try again.(P. 79) >
- < You do not have permissions to use Service Management Service. Log in with administrator rights.(P. 80) >
- < Cannot login because another user is logged in or logout operations have not been successfully performed. Please wait a moment and then try this operation again.(P. 80) >
- < Error: <Error Details>(P. 80) >

The specified file does not exist or the file path is incorrect. Try to specify the path again.

Problem	The file does not exist on the specified path or the file path is incorrect.
Action	Specify the file path correctly.

The contents of the specified file are incorrect or information is missing. Check the file.

Problem	The specified file is not a switch license file.
Action	Check to make sure that the specified file is a switch license file for password initialization.
Problem	Information is missing from the specified file.
Action	The password cannot be initialized using the specified file. Check the content of the file.

The specified switch license file cannot be used for password initialization. Try to specify the file again.

Problem	The specified file is not a switch license file for initializing the password.
Action	Specify a switch license file for initializing the password.

Cannot initialize password because a used switch license file is specified. Try to specify the file again.

Problem	The specified license file has already been installed. License files that have been installed once cannot be installed again.
Action	Since the specified license file cannot be installed, specify another file.

Cannot initialize the password because another application is being installed, or the firmware being updated. Please wait a moment and then try again.

Problem	Either it is installed in another application outside of SMS, or it cannot initialize the password because the firmware is being updated.
----------------	---

Action	Wait until the processing stops before initializing the password.
---------------	---

You do not have permissions to use Service Management Service. Log in with administrator rights.

Problem	Only users with administrator rights can log in to SMS with the user name and password that they use for logging in to the printer. The user trying to log in cannot do so because they do not have administrator rights.
Action	Log in again with the user name and password of a user with administrator rights.

Cannot login because another user is logged in or logout operations have not been successfully performed. Please wait a moment and then try this operation again.

Problem	Cannot log in for a period of time because either another user is logged in or when the user was logged in before, the logout procedure was not performed properly.
Action	If another user is logged in, wait until the user logs out. If another user is not logged in, wait for the lock to be cancelled.

Error: <Error Details>

Problem	An error has occurred for some reason. See <Error Details> for details.
Action	If the solutions given in <Error Details> are unclear, contact your local authorized Canon dealer or sales representatives.

Errors Relating to the [MEAP Application Management] Page

OXW7-01L

- < Cannot start this application because there is no distributable software in the application. Get a distributable software.(P. 81) >
- < Cannot start this application because the number of bootable applets has exceeded the limit. Start this application after stopping other applications.(P. 81) >
- < A license is needed to start this application. Try to start it again after installing a license.(P. 81) >
- < Cannot start this application because system resources (memory, threads, sockets, file descriptors, disk space, or screen size) required to start the application may not be available. <Resources>(P. 81) >
- < Cannot uninstall this application because the license file has not been deleted. Uninstall the application after deleting the license in the [License Management] page.(P. 82) >
- < The name listed in the file for the application and the applet name to register with Applet Viewer Service are different. Check the file.(P. 82) >
- < Cannot start this application because application setting information is being processed. Please wait a moment and then try again.(P. 82) >
- < Error: <Error Details>(P. 82) >

Cannot start this application because there is no distributable software in the application. Get a distributable software.

Problem	The application cannot be started because it does not contain any redistributable modules.
Action	Contact the application developer.

Cannot start this application because the number of bootable applets has exceeded the limit. Start this application after stopping other applications.

Problem	The application that you are attempting to launch contains applets. If the application was launched, the number of applets that would be booted on the system would exceed the limit (five applets), so the application cannot be launched.
Action	First, reduce the number of applets running on the system by stopping an application running on the system which includes an applet, and then restart the application.

A license is needed to start this application. Try to start it again after installing a license.

Problem	Cannot start the application because a license file is not installed.
Action	Install the license file, and then restart the application.

Cannot start this application because system resources (memory, threads, sockets, file descriptors, disk space, or screen size) required to start the application may not be available. <Resources>

Problem	The application cannot be started because the system resources for opening the application may not be available to be allocated.
Action	Restart this application after stopping other applications. It may be able to start this time.

Cannot uninstall this application because the license file has not been deleted. Uninstall the application after deleting the license in the [License Management] page.

Problem	The application cannot be uninstalled because the license file for the application still exists inside the printer.
Action	Uninstall the application after deleting the license on the [License Management] page.

The name listed in the file for the application and the applet name to register with Applet Viewer Service are different. Check the file.

Problem	The application cannot be started because the applet name the application is trying to register in the Applet Viewer Service differs from the applet name included in the application file.
Action	Since it is necessary to make corrections to the application file, contact the application developer.

Cannot start this application because application setting information is being processed. Please wait a moment and then try again.

Problem	The application cannot be started because application data is being deleted.
Action	After deletion of application data completes, launch the application again.

Error: <Error Details>

Problem	An error has occurred for some reason. See <Error Details> for details.
Action	If the solutions given in <Error Details> are unclear, contact your local authorized Canon dealer or sales representatives.

Errors Relating to the [Install MEAP Application] Page

0XW7-01R

- < The file for the application to install does not exist or the file path is incorrect. Try to specify the path again.(P. 83) >
- < The file for the license to install does not exist or the file path is incorrect. Try to specify the path again.(P. 83) >
- < The manifest is not listed in the specified file. Check the file.(P. 84) >
- < The contents of the file for the application to install are incorrect or information is missing. Check the file.(P. 84) >
- < The contents of the file for the license to install are incorrect or information is missing. Check the file.(P. 84) >
- < The following information is missing in file for the specified application. Check the file. <Missing information>(P. 84) >
- < The following information in the specified application is incorrect. Check the file. <Inaccurate information>(P. 84) >
- < Cannot install this application because a code signing has not been confirmed to be valid. Get a valid code signing.(P. 84) >
- < Cannot install this license because the specified application and license do not correspond. Try to specify a path for the license file again.(P. 85) >
- < The number of applications that can be installed has exceeded the limit. Try to install this application after uninstalling other applications.(P. 85) >
- < Cannot install this license because the number of license file ID logs that can be saved has exceeded the limit. Contact your service representative.(P. 85) >
- < Cannot install because a used license file is specified. Try to specify the file again.(P. 85) >
- < To install the specified application, a license file must be installed at the same time. Specify a license file.(P. 85) >
- < The specified file is a system application. Install the application from the [Enhanced System Application Management] page.(P. 85) >
- < The specified application does not require a license.(P. 85) >
- < The specified license does not match this device. Specify an installable license.(P. 86) >
- < The specified application does not support this device.(P. 86) >
- < Cannot install this application because an applet included in the specified application has exceeded the area that can be displayed in the device panel.(P. 86) >
- < The specified file is an update file. Stop the application that you want update and then install the file.(P. 86) >
- < Cannot install the application because the license requirement is different. Uninstall the specified application, and then try to install the application again.(P. 86) >
- < Cannot install this application because storage space has been exceeded. Uninstall other applications and then try to install it again.(P. 86) >
- < Could not cancel installation. Installation has been successfully completed.(P. 86) >
- < This application does not support the MEAP version of the device. Contact your service representative after checking the application version.(P. 87) >
- < The specified application cannot be installed on this device.(P. 87) >
- < The process is canceled because the system has been shut down. Restart the system, and then perform the process again.(P. 87) >
- < Cannot install the application or license because another application is being installed, or the firmware being updated. Please wait a moment and then try again.(P. 87) >
- < Error: <Error Details>(P. 87) >

The file for the application to install does not exist or the file path is incorrect. Try to specify the path again.

Problem	The specified file does not exist or the file path is incorrect.
Action	Specify the file path correctly.

The file for the license to install does not exist or the file path is incorrect. Try to specify the path again.

Problem	The license file does not exist on the specified path or the file path is incorrect.
Action	Specify the file path correctly.

The manifest is not listed in the specified file. Check the file.

Problem	A manifest does not exist for the file specified as the application file.
Action	This application cannot be installed. Contact the application developer.

The contents of the file for the application to install are incorrect or information is missing. Check the file.

Problem	Either the content of the files specified as application files is not correct or information is missing.
Action	This application file cannot be installed. Check the file. If there are no problems with the files, contact the application developer or the application support help desk.

The contents of the file for the license to install are incorrect or information is missing. Check the file.

Problem	Either the content of the files specified as license files is not correct or information is missing.
Action	This license file cannot be installed. Check the file. If there are no problems with the files, contact the application developer or the application support help desk.

**The following information is missing in file for the specified application. Check the file.
<Missing information>**

Problem	The application cannot be installed because required information is not included in the application file.
Action	Check the file. If there are no problems with the files, contact the application developer or the application support help desk concerning the <Missing Information>.

**The following information in the specified application is incorrect. Check the file.
<Inaccurate information>**

Problem 1	<Inaccurate information> in the application file cannot be recognized as correct information.
Action	Contact the application developer or the application support help desk.
Problem 2	If the <Inaccurate information> is the MEAP Specifications, the application's MEAP specification values and the printer's MEAP specification values do not match.
Action	Contact your local authorized Canon dealer or sales representatives.

Cannot install this application because a code signing has not been confirmed to be valid. Get a valid code signing.

Problem 1	Cannot confirm that there is a valid code signature inside the application file.
Action	Perform the correct code signing operation for the application.
Problem 2	The file may have been altered.
Action	Contact the application developer.

Cannot install this license because the specified application and license do not correspond. Try to specify a path for the license file again.

Problem	The application cannot be installed because the specified license file does not correspond to the specified application.
Action	Specify the license file that corresponds to the application.

The number of applications that can be installed has exceeded the limit. Try to install this application after uninstalling other applications.

Problem	The maximum number of applications that can be installed is eight. You are attempting to install an application that will exceed that number.
Action	You can install it if you first uninstall another installed application (unless it is a system application).

Cannot install this license because the number of license file ID logs that can be saved has exceeded the limit. Contact your service representative.

Problem	The license file cannot be installed because the number of license file ID information logs contained in the license file exceeds the number that can be saved.
Action	Contact your local authorized Canon dealer or sales representatives.

Cannot install because a used license file is specified. Try to specify the file again.

Problem	License files that have been installed once cannot be installed again. The specified license file has already been installed.
Action	Since the specified license file cannot be installed, specify another file.

To install the specified application, a license file must be installed at the same time. Specify a license file.

Problem	You cannot install the application unless you specify the license file that corresponds to the application at the same time.
Action	Specify the corresponding license file when specifying the application, and then install them.

The specified file is a system application. Install the application from the [Enhanced System Application Management] page.

Problem	The specified file is a system application. It cannot be installed from this [Install MEAP Application] page.
Action	Install it from the [Enhanced System Application Management] page.

The specified application does not require a license.

Problem	An application file and license file were specified, but the specified application file does not require a license file.
Action	Install the application without specifying a license file.

The specified license does not match this device. Specify an installable license.

Problem	License files contain the serial number information of printers in which the license file can be installed. The specified license cannot be installed because it does not contain the printer's serial number information.
Action	Specify a license file that matches the printer's serial number.

The specified application does not support this device.

Problem	Some applications can only be installed in certain printer models. It cannot be installed in this model.
Action	Specify an application that supports this printer.

Cannot install this application because an applet included in the specified application has exceeded the area that can be displayed in the device panel.

Problem	The application cannot be installed because the display area of an applet included in the application exceeds the area that can be displayed on the operation panel of the printer.
Action	Install an application that contains applets that support this printer.

The specified file is an update file. Stop the application that you want update and then install the file.

Problem	The specified application file is a file for updating an application which is already installed. It is necessary to stop the application which is to be updated before updating.
Action	Stop the application that you want to update, and then perform the update again.

Cannot install the application because the license requirement is different. Uninstall the specified application, and then try to install the application again.

Problem	You have tried to upgrade an application which is already installed using a version of the same application with different license requirements.
Action	Upgrade using the same license conditions.

Cannot install this application because storage space has been exceeded. Uninstall other applications and then try to install it again.

Problem	The application cannot be installed because there is not enough free storage capacity.
Action	Make storage capacity available by uninstalling an application that is not being used.

Could not cancel installation. Installation has been successfully completed.

Problem	The [Cancel] button was pressed when the installation operation could not be cancelled.
Action	Disable the license file, download it from the [License Management] page, and then uninstall it.

This application does not support the MEAP version of the device. Contact your service representative after checking the application version.

Problem	The specified application cannot be installed because it does not support the MEAP version on this printer.
Action	Contact the application developer.

The specified application cannot be installed on this device.

Problem	The specified application cannot be installed because there is not enough memory in the printer.
Action	Contact your local authorized Canon dealer or sales representatives.

The process is canceled because the system has been shut down. Restart the system, and then perform the process again.

Problem	The installation could not be completed because it conflicted with a system shutdown.
Action	Restart the printer and perform the install again.

Cannot install the application or license because another application is being installed, or the firmware being updated. Please wait a moment and then try again.

Problem	Either it is installed in another application outside of SMS, or the application cannot be installed because the firmware has been updated.
Action	Wait until the processing stops before installing the application.

Error: <Error Details>

Problem	An error has occurred for some reason. See <Error Details> for details.
Action	If the solutions given in <Error Details> are unclear, contact your local authorized Canon dealer or sales representatives.

Errors Relating to the [Authentication Information Settings] Page

OXW7-01S

- < Settings are incorrect.(P. 88) >
- < The [Department ID] is incorrect. Enter an integer for the [Department ID].(P. 88) >
- < The [Department ID] is not entered.(P. 88) >
- < Could not set authentication information because an error occurred.(P. 88) >
- < Could not delete authentication information because an error occurred.(P. 88) >

Settings are incorrect.

- Check to see if the password is incorrect.
- Enter Dept. ID within 7 digits.
- Check to see if the Department. ID is registered with the device.

Problem	Cannot set authentication information because either the Dept. ID entered does not exist, or the PIN was entered incorrectly.
Action	Enter a Dept. ID and PIN that are registered in the printer.

The [Department ID] is incorrect. Enter an integer for the [Department ID].

Problem	The Dept. ID that was entered is a positive integer, but the registered Dept. ID is not a positive integer.
Action	Enter the correct Dept. ID that is registered in the device.

The [Department ID] is not entered.

Problem	The Dept. ID is blank.
Action	Specify a Dept. ID.

Could not set authentication information because an error occurred.

Problem	An error has occurred for some reason, so authentication information could not be set.
Action	Contact your local authorized Canon dealer or sales representatives.

Could not delete authentication information because an error occurred.

Problem	An error has occurred for some reason, so authentication information could not be deleted.
Action	Contact your local authorized Canon dealer or sales representatives.

Errors Relating to the [License Management] Page

0XW7-01U

- < The specified file does not exist or the file path is incorrect. Try to specify the path again.(P. 89) >
- < The contents of the file for the license to install are incorrect or information is missing. Check the file.(P. 89) >
- < Cannot install this license because the specified license does not correspond to this application. Try to specify a path for the license file again.(P. 89) >
- < Cannot install this license because the number of license file ID logs that can be saved has exceeded the limit. Contact your service representative.(P. 89) >
- < Cannot install because a used license file is specified. Try to specify the file again.(P. 89) >
- < The specified license does not match this device. Specify an installable license.(P. 90) >
- < Could not cancel installation. Installation has been successfully completed.(P. 90) >
- < Cannot install the license because another application is being installed, or the firmware being updated. Please wait a moment and then try again.(P. 90) >
- < Cannot disable the license file because this application has been started. Disable the license file after stopping the application.(P. 90) >
- < Error: <Error Details>(P. 90) >

The specified file does not exist or the file path is incorrect. Try to specify the path again.

Problem	The file does not exist on the specified path or the file path is incorrect.
Action	Specify the file path correctly.

The contents of the file for the license to install are incorrect or information is missing. Check the file.

Problem	Either the content of the file is not correct or information is missing.
Action	This license file cannot be installed. Contact the application developer.

Cannot install this license because the specified license does not correspond to this application. Try to specify a path for the license file again.

Problem	The specified license file does not correspond to the application, so they cannot be installed.
Action	Specify the license file that corresponds to the application. Check to make sure that the manifest file listed inside the license file is correct.

Cannot install this license because the number of license file ID logs that can be saved has exceeded the limit. Contact your service representative.

Problem	The license file cannot be installed because the number of license file ID information logs contained in the license file exceeds the number that can be saved.
Action	Contact your local authorized Canon dealer or sales representatives.

Cannot install because a used license file is specified. Try to specify the file again.

Problem	According to the specifications, a license file which is already installed cannot be installed again. The specified license file has already been installed.
Action	Since the specified license file cannot be installed, specify another file.

The specified license does not match this device. Specify an installable license.

Problem	License files contain lists of printers in which they can be installed. The specified license file cannot be installed in this printer.
Action	Specify a license file that can be installed in this printer.

Could not cancel installation. Installation has been successfully completed.

Problem	The [Cancel] button was pressed when the installation operation could not be cancelled.
Action	Disable the license file, download it from the [License Management] page, and then uninstall it.

Cannot install the license because another application is being installed, or the firmware being updated.

Please wait a moment and then try again.

Problem	Either it is installed in another application outside of SMS, or the license file cannot be installed because the firmware has been updated.
Action	Wait until the processing stops before installing the license file.

Cannot disable the license file because this application has been started. Disable the license file after stopping the application.

Problem	You cannot disable a license if the corresponding application is still running.
Action	Stop the application that corresponds to the license before disabling the license.

Error: <Error Details>

Problem	An error has occurred for some reason. See <Error Details> for details.
Action	If the solutions given in <Error Details> are unclear, contact the application developer.

Errors Relating to the [Enhanced System Application Management] Page

0XW7-01W

- < Cannot start this application because there is no distributable software in the application. Get a distributable software.(P. 92) >
- < Cannot start this application because the number of bootable applets has exceeded the limit. Start this application after stopping other applications.(P. 92) >
- < Cannot start this application because system resources (memory, threads, sockets, file descriptors, disk space, or screen size) required to start the application may not be available. <Resources>(P. 92) >
- < The name listed in the file for the application and the applet name to register with Applet Viewer Service are different. Check the file.(P. 92) >
- < The following login services cannot be uninstalled: (P. 92)
 - The currently set login service
 - Login services that will be enabled after the device is restarted
 - Default Authentication login services
 The currently set login service can be uninstalled after the device is restarted.>
- < The file for the application to install does not exist or the file path is incorrect. Try to specify the path again. (P. 92) >
- < The manifest is not listed in the specified file. Check the file.(P. 93) >
- < The file for the license to install does not exist or the file path is incorrect. Try to specify the path again.(P. 93) >
- < The contents of the file for the application to install are incorrect or information is missing. Check the file.(P. 93) >
- < The contents of the file for the license to install are incorrect or information is missing. Check the file.(P. 93) >
- < Cannot install this application because a code signing has not been confirmed to be valid. Get a valid code signing.(P. 93) >
- < Cannot install this license because the specified application and license do not correspond. Try to specify a path for the license file again.(P. 93) >
- < The specified file is not system application. Check the file.(P. 93) >
- < Cannot install this license because the number of license file ID logs that can be saved has exceeded the limit. Contact your service representative.(P. 94) >
- < Cannot install because a used license file is specified. Try to specify the file again.(P. 94) >
- < To install the specified application, a license file must be installed at the same time. Specify a license file.(P. 94) >
- < The following information in the specified application is incorrect. Check the file. <Inaccurate information>(P. 94) >
- < The following information is missing in file for the specified application. Check the file. <Missing information>(P. 94) >
- < The specified application does not support this device. (P. 94) >
- < The specified license does not match this device. Specify an installable license.(P. 94) >
- < Cannot install this application because an applet included in the specified application has exceeded the area that can be displayed in the device panel.(P. 95) >
- < The specified file is an update file. Stop the application that you want update and then install the file.(P. 95) >
- < The specified file is an update file for a login service that is currently set. Switch to another login service, restart the device, and then install the file.(P. 95) >
- < Cannot install this application because storage space has been exceeded. Uninstall other applications and then try to install it again.(P. 95) >
- < Could not cancel installation. Installation has been successfully completed.(P. 95) >
- < The process is canceled because the system has been shut down. Restart the system, and then perform the process again.(P. 95) >
- < Cannot install the application or license because another application is being installed, or the firmware being updated. Please wait a moment and then try again. (P. 95) >
- < Error: <Error Details>(P. 96) >

Cannot start this application because there is no distributable software in the application. Get a distributable software.

Problem	The application cannot be started because it does not contain any redistributable modules.
Action	Contact the application developer.

Cannot start this application because the number of bootable applets has exceeded the limit. Start this application after stopping other applications.

Problem	The application that you are attempting to launch contains applets. If the application was launched, the number of applets that would be booted on the system would exceed the limit (five applets), so the application cannot be launched.
Action	First, reduce the number of applets running on the system by stopping an application running on the system which includes an applet, and then restart the application.

Cannot start this application because system resources (memory, threads, sockets, file descriptors, disk space, or screen size) required to start the application may not be available. <Resources>

Problem	The application cannot be started because the system resources for opening the application may not be available to be allocated.
Action	Restart this application after stopping other applications. It may be able to start this time.

The name listed in the file for the application and the applet name to register with Applet Viewer Service are different. Check the file.

Problem	The application cannot be started because the applet name the application is trying to register in the Applet Viewer Service differs from the applet name included in the application file.
Action	Since it is necessary to make corrections to the application file, contact the application developer.

The following login services cannot be uninstalled:

- The currently set login service
- Login services that will be enabled after the device is restarted
- Default Authentication login services

The currently set login service can be uninstalled after the device is restarted.

Problem	The currently set login service, a login service that will be enabled after restarting the machine, and the Default Authentication login service cannot be uninstalled.
Action	Do not uninstall the currently set login service, a login service that will be enabled after restarting the machine, or the Default Authentication login service. To uninstall the currently set login service, uninstall it after restarting the machine.

The file for the application to install does not exist or the file path is incorrect. Try to specify the path again.

Problem	The specified file does not exist or the file path is incorrect.
Action	Specify the file path correctly.

The manifest is not listed in the specified file. Check the file.

Problem	A manifest does not exist for the file specified as the application file.
Action	This application cannot be installed. Contact the application developer.

The file for the license to install does not exist or the file path is incorrect. Try to specify the path again.

Problem	The specified file does not exist or the file path is incorrect.
Action	Specify the file path correctly.

The contents of the file for the application to install are incorrect or information is missing. Check the file.

Problem	Either the content of the files specified as application files is not correct or information is missing.
Action	This application file cannot be installed. Check the file. If there are no problems with the files, contact the application developer or the application support help desk.

The contents of the file for the license to install are incorrect or information is missing. Check the file.

Problem	Either the content of the files specified as license files is not correct or information is missing.
Action	This license file cannot be installed. Check the file. If there are no problems with the files, contact the application developer or the application support help desk.

Cannot install this application because a code signing has not been confirmed to be valid. Get a valid code signing.

Problem 1	Cannot confirm that there is a valid code signature inside the application file.
Action	Perform the correct code signing operation for the application.
Problem 2	The file may have been altered.
Action	Contact the application developer.

Cannot install this license because the specified application and license do not correspond. Try to specify a path for the license file again.

Problem	The application cannot be installed because the specified license file does not correspond to the specified application.
Action	Specify the license file that corresponds to the application.

The specified file is not system application. Check the file.

Problem	The specified file is not system application. It cannot be installed from the [Enhanced System Application Management] page.
Action	Install it from the [Install MEAP Application] page.

Cannot install this license because the number of license file ID logs that can be saved has exceeded the limit. Contact your service representative.

Problem	The license file cannot be installed because the number of license file ID information logs contained in the license file exceeds the number that can be saved.
Action	Contact your local authorized Canon dealer or sales representatives.

Cannot install because a used license file is specified. Try to specify the file again.

Problem	License files that have been installed once cannot be installed again. The specified license file has already been installed.
Action	Since the specified license file cannot be installed, specify another file.

To install the specified application, a license file must be installed at the same time. Specify a license file.

Problem	You cannot install the application unless you specify the license file that corresponds to the application at the same time.
Action	Specify the corresponding license file when specifying the application, and then install them.

**The following information in the specified application is incorrect. Check the file.
<Inaccurate information>**

Problem 1	<Inaccurate information> in the application file cannot be recognized as correct information.
Action	Contact the application developer or the application support help desk.
Problem 2	If the <Inaccurate information> is the MEAP Specifications, the application's MEAP specification values and the printer's MEAP specification values do not match.
Action	Contact your local authorized Canon dealer or sales representatives.

**The following information is missing in file for the specified application. Check the file.
<Missing information>**

Problem	The application cannot be installed because required information is not included in the application.
Action	Check the file. If there are no problems with the files, contact the application developer or the application support help desk concerning the <Missing Information>.

The specified application does not support this device.

Problem	Some applications can only be installed in certain printer models. It cannot be installed in this model.
Action	Specify an application that supports this printer.

The specified license does not match this device. Specify an installable license.

Problem	License files contain the serial number information of printers in which the license file can be installed. The specified license cannot be installed because it does not contain the printer's serial number information.
----------------	--

Action	Specify a license file that matches the serial number of this printer.
---------------	--

Cannot install this application because an applet included in the specified application has exceeded the area that can be displayed in the device panel.

Problem	The application cannot be installed because the display area of an applet included in the application exceeds the area that can be displayed on the operation panel of the printer.
Action	Install an application that contains applets that support this printer.

The specified file is an update file. Stop the application that you want update and then install the file.

Problem	The specified application file is a file for updating an application which is already installed. It is necessary to stop the application which is to be updated before updating.
Action	Stop the application that you want to update, and then perform the update again.

The specified file is an update file for a login service that is currently set. Switch to another login service, restart the device, and then install the file.

Problem	Although the specified application file is an update file for the login service that is currently set, it cannot update a login service that has already started.
Action	To install the update file for the login service, start another login service, and then install the update file.

Cannot install this application because storage space has been exceeded. Uninstall other applications and then try to install it again.

Problem	The application cannot be installed because there is not enough free storage capacity.
Action	Make storage capacity available by uninstalling an application that is not being used.

Could not cancel installation. Installation has been successfully completed.

Problem	The [Cancel] button was pressed when the installation operation could not be cancelled.
Action	Disable the license file, download it from the [License Management] page, and then uninstall it.

The process is canceled because the system has been shut down. Restart the system, and then perform the process again.

Problem	The installation could not be completed because it conflicted with a system shutdown.
Action	Restart the printer and perform the install again.

Cannot install the application or license because another application is being installed, or the firmware being updated. Please wait a moment and then try again.

Problem	Either it is installed in another application outside of SMS, or the application cannot be installed because the firmware has been updated.
Action	Wait until the processing stops before installing the application.

Error: <Error Details>

Problem	An error has occurred for some reason. See <Error Details> for details.
Action	If the solutions given in <Error Details> are unclear, contact your local authorized Canon dealer or sales representatives.

Errors Relating to the [Check License] and [Change Password] Pages

OXW7-01X

- < The specified file does not exist or the file path is incorrect. Try to specify the path again.(P. 97) >
- < The contents of the specified file are incorrect or information is missing. Check the file.(P. 97) >
- < The specified switch license file cannot be used to delete the license file ID log. Try to specify the path again.(P. 97) >
- < The specified license is already installed. Installed license file information cannot be displayed.(P. 97) >
- < Cannot perform the operation because another application is being installed, or the firmware being updated. Please wait a moment and then try again.(P. 97) >
- < The old password is incorrect.(P. 98) >
- < The new password is incorrect. Enter the password with 8 to 32 single-byte alphanumeric characters.(P. 98) >
- < The new password and password to confirm do not match.(P. 98) >
- < Error: <Error Details>(P. 98) >

The specified file does not exist or the file path is incorrect. Try to specify the path again.

Problem	The file does not exist on the specified path or the file path is incorrect.
Action	Specify the file path correctly.

The contents of the specified file are incorrect or information is missing. Check the file.

Problem 1	The content of the file is not correct. (A file other than a license file was specified.)
Action	Check to make sure that the specified file is a license file.
Problem 2	Information is missing from the file.
Action	Check the content of the file.

The specified switch license file cannot be used to delete the license file ID log. Try to specify the path again.

Problem	The specified file is not a switch license file for deleting license file ID logs.
Action	Try specifying the file path for the switch license for deleting license file ID logs.

The specified license is already installed. Installed license file information cannot be displayed.

Problem	Information about license files that have already been installed in this printer cannot be displayed.
Action	Specify another license file.

Cannot perform the operation because another application is being installed, or the firmware being updated.

Please wait a moment and then try again.

Problem	Either it is installed in another application outside of SMS, or the license file information cannot be displayed because the firmware has been updated.
Action	Wait until the processing stops before displaying the license information.

The old password is incorrect.

Problem	The text string entered as the current password is different from the current password.
Action	Enter the correct password.

The new password is incorrect. Enter the password with 8 to 32 single-byte alphanumeric characters.

Problem	The new password has under 8 characters or more than 33 characters. Illegal characters that cannot be used in passwords have been used.
Action	Enter a new password of between 8 and 32 alphanumeric characters (a to z, A to Z, and 0 to 9).

The new password and password to confirm do not match.

Problem	The password cannot be changed because the new password and the confirmation password do not match.
Action	Enter a new password and the same text string as the confirmation password.

Error: <Error Details>

Problem	An error has occurred for some reason. See <Error Details> for details.
Action	If the solutions given in <Error Details> are unclear, contact your local authorized Canon dealer or sales representatives.

Errors Relating to the [MEAP Application Setting Information Management] Page

OXW7-01Y

- < Cannot delete the setting information for the selected applications because it is in use by currently running applications. Stop the following applications, or stop all applications except for login services, and then delete the setting information. <Application Name>(P. 99) >
- < Could not delete MEAP application setting information because an error occurred.(P. 99) >

Cannot delete the setting information for the selected applications because it is in use by currently running applications.

Stop the following applications, or stop all applications except for login services, and then delete the setting information.

<Application Name>

Problem	The application is in one of the following states. <ul style="list-style-type: none"> • Started • Starting • Stopping
Action	Return to the previous page using the [Back] button, bring the applications corresponding to the error message to other state than "Started," "Starting" or "Stopping," and then try deletion again.

Could not delete MEAP application setting information because an error occurred.

Problem	An error has occurred for some reason, so the setting information could not be deleted.
Action	Return to the previous page using the [Back] button.

Errors Relating to the [MEAP Application Log Management] Page

- [< Cannot download application logs because application logs do not exist. \(P. 100\) >](#)
- [< Could not delete application logs because an error occurred.\(P. 100\) >](#)
- [< Could not download application logs because an error occurred.\(P. 100\) >](#)

Cannot download application logs because application logs do not exist.

Problem	The application log does not exist.
Action	Return to the previous page using the [Back] button.

Could not download application logs because an error occurred.

Problem	An error has occurred for some reason, so the log could not be downloaded.
Action	Return to the previous page using the [Back] button.

Could not delete application logs because an error occurred.

Problem	An error has occurred for some reason, so the log could not be deleted.
Action	Return to the previous page using the [Back] button.

Other Errors

0XW7-021

- [< Cannot find the specified application. It may have been uninstalled by another user.\(P. 101\) >](#)

Cannot find the specified application. It may have been uninstalled by another user.

Problem	The application for the attempted operation does not exist.
Action	Return to the previous page using the [Back] button.

Using This Guide

Using This Guide	103
Operating Environment of This Guide	104
Screen Layout of This Guide	105
Top Page	106
Topic Page	107
Site Map	108
Search Method	109
Viewing This Guide	110

Using This Guide

0XW7-022

This chapter describes how to use this guide.

❖ **Operating Environment of This Guide(P. 104)**

❖ **Screen Layout of This Guide(P. 105)**

▶ **Top Page(P. 106)**

▶ **Topic Page(P. 107)**

▶ **Site Map(P. 108)**

▶ **Search Method(P. 109)**

❖ **Viewing This Guide(P. 110)**

<To find the desired content>

- **Selecting between the category icons**

From the top page, select a category icon you want.

❖ " **Top Page(P. 106)** "

- **Searching from the site map**

On the site map, you can view the list of whole sections of this guide sorted by category. You can directly display sections in a category.

❖ " **Site Map(P. 108)** "

- **Whole text search function**

You can search by keyword in this guide. You can display the desired description from the search results by entering a keyword you want to search. This function supports AND search.

❖ " **Search Method(P. 109)** "

Operating Environment of This Guide

0XW7-023

You need a Web browser to use this guide. Operation of the following Web browsers is guaranteed.

Windows

- Internet Explorer 6.0 or later
- Firefox 2.x or later

Mac OS

- Safari 3.x or later
- Firefox 3.x or later

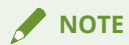

Enabling the script function

Enable the script function for a Web browser before using this guide.

Screen Layout of This Guide

0XW7-024

This section describes the screen layout of this guide.

The page displayed right after this guide starts is called "Top Page" and the guide description is called "Topic Page" in this section.

"Site map" is displayed from [Site map] which is located on the upper right of this guide.

The search panel is used to make search through this guide.

The screen layout is different for each page, so click the following links to see the instruction.

➤ **Top Page(P. 106)**

➤ **Topic Page(P. 107)**

➤ **Site Map(P. 108)**

➤ **Search Method(P. 109)**

Top Page

0XW7-025

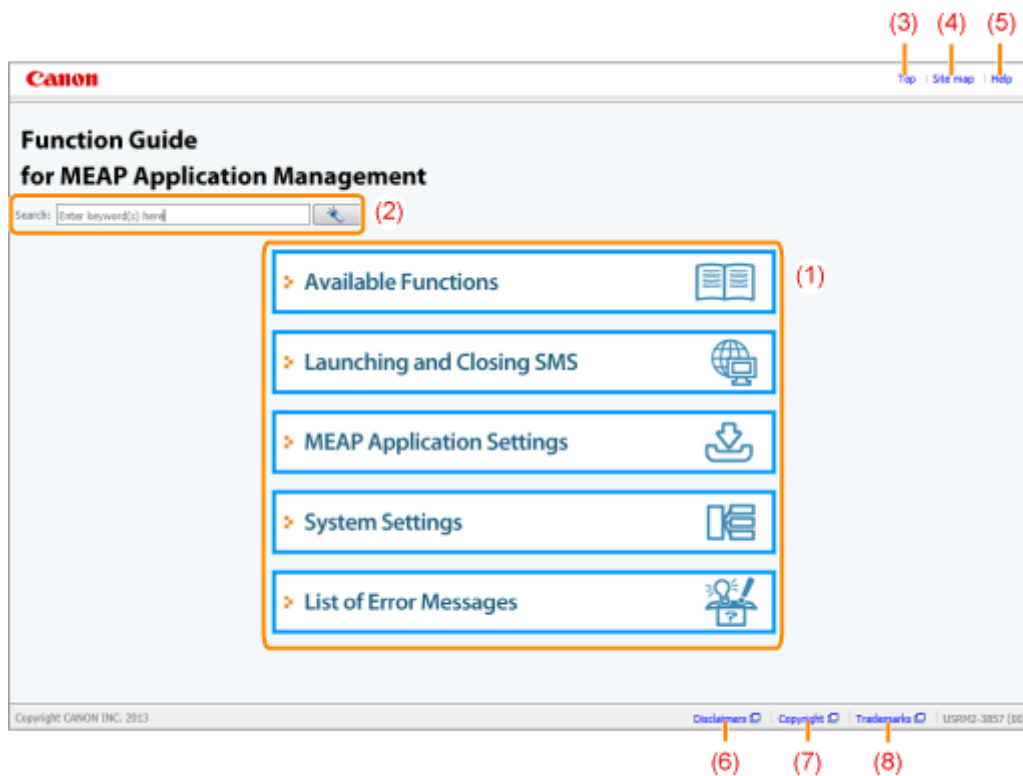

(1) Select from functions

The instructions of each function and operation method are described.

(2) [Search]

The search panel is displayed by entering keyword(s) and clicking [].

For details, see " **Search Method(P. 109)** ."

(3) [Top]

The top page of this guide is displayed.

(4) [Site map]

The entire contents of this guide are displayed.

(5) [Help]

How to use this guide is displayed.

(6) [Disclaimers]

The disclaimers are displayed.

(7) [Copyright]

The information of copyrights is displayed.

(8) [Trademarks]



The trademarks are displayed.

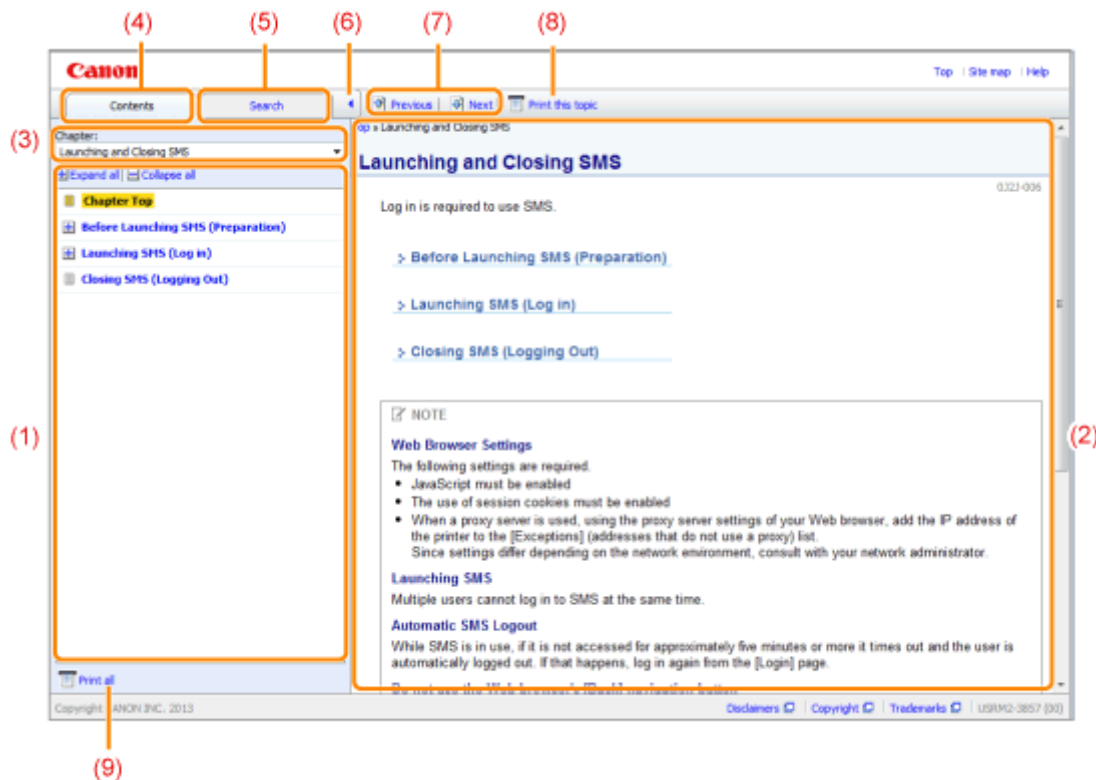

Topic Page

OXW7-026



(1) Chapter contents

This is the list of the contents in the chapter. Clicking each item displays the description in the topic page. Click [] to expand a menu, and click [] to collapse a menu.

Alternatively, click [ Expand all] to expand all menus, and click [ Collapse all] to collapse all menus.

(2) Topic page

The descriptions of each item are displayed.

The current location of the displayed topic is displayed at the upper left of the topic page. Click a link to move to a higher level.

(3) [Chapter] menu

You can select a different chapter from the pull-down menu.

(4) [Contents] tab

Click to display the chapter contents panel.

(5) [Search] tab

Click to display the search panel.

For details, see " **Search Method(P. 109)** ."

(6) []

Click to display or hide the chapter contents panel/search panel.

(7) [Previous]/[Next]

Click to move to the previous or next topic.

(8) [Print this topic]

Prints only the topic page currently displayed.

(9) [Print all]

Prints all the contents in a chapter.

Site Map

OXW7-027

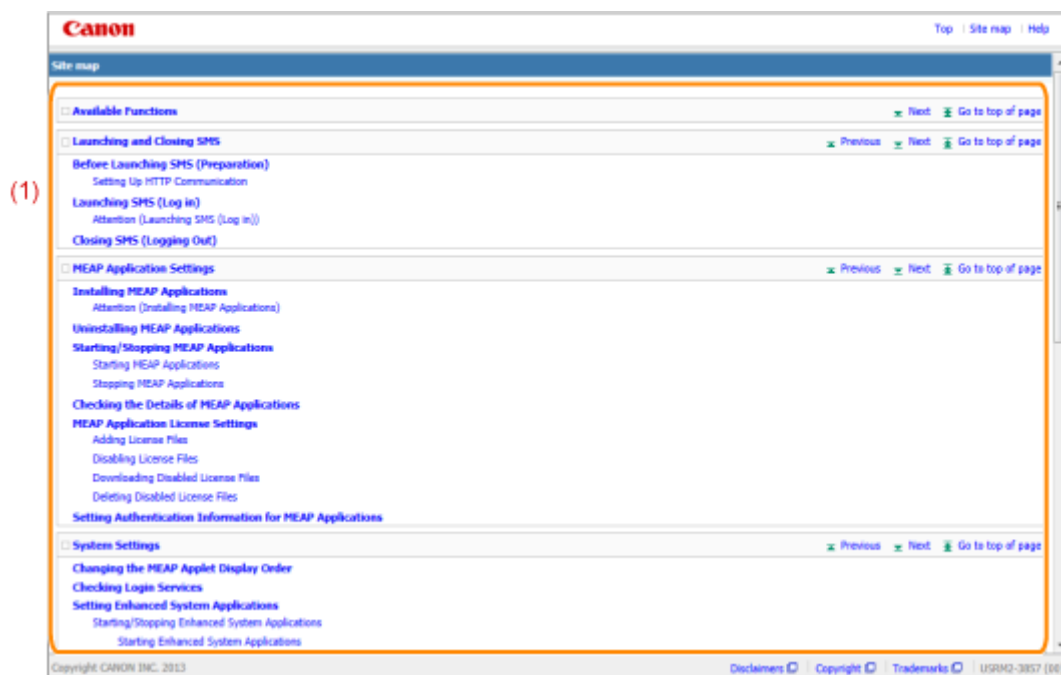

(1) Whole contents

Shows the all chapters and sections of this guide. Click an item to view the contents.

Search Method

0XW7-028

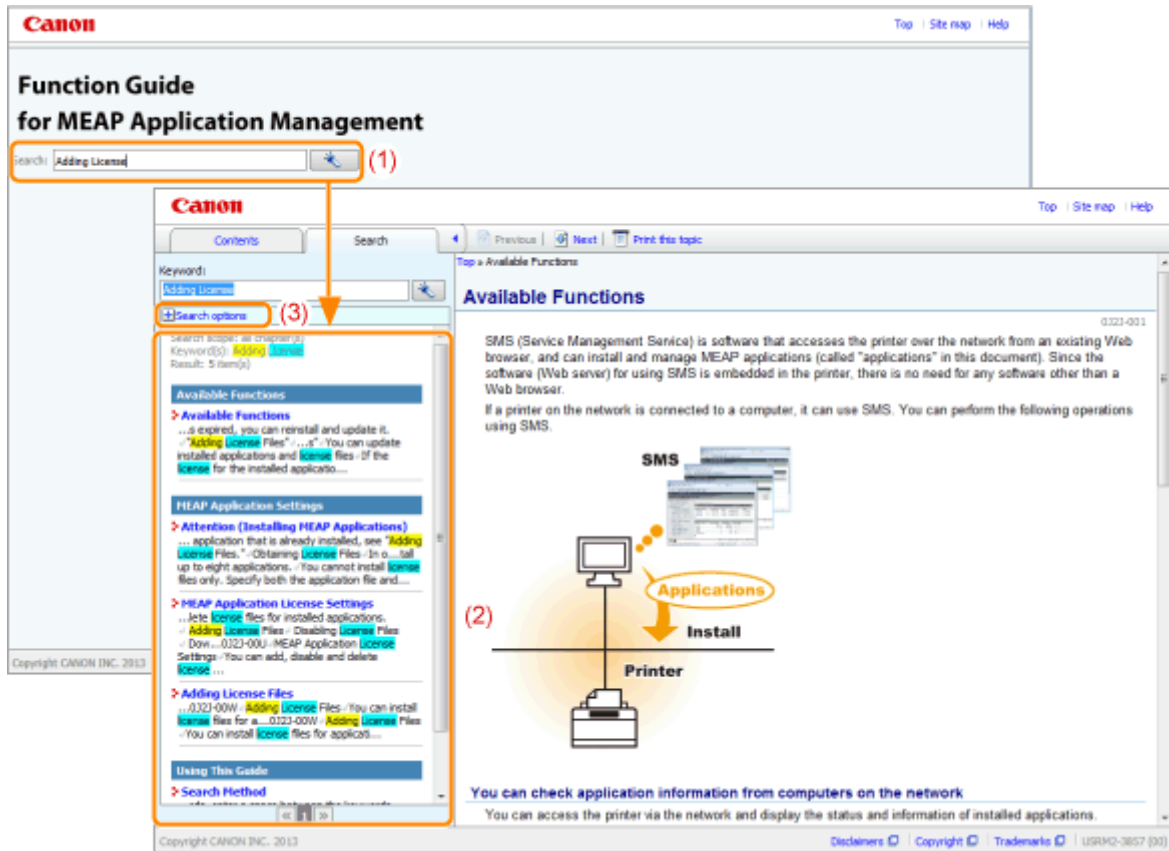

(1) Search



Entering a character string in [Search] on the top page or in the [Keyword] text box on the search panel and then clicking [] displays the search results.

The AND search is available in this guide so you can refine the search results by entering two or more keywords. When entering keywords, enter a space between the keywords.

- **Example:** Adding License (if you want to display pages which include words, "Adding" and "License")

(2) Search result

The search results for a keyword are displayed.

If there are more than 10 search results, you can see the other results by clicking [], [], or the number which is located below the result.

(3) [Search options]

Click to display the search options.

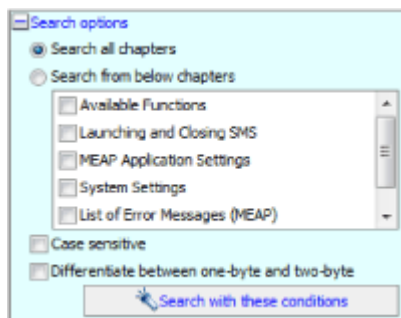

The search options can be used to specify the chapter to search, case sensitivity, and whether to differentiate between one- and two-byte characters.

Click [Search with these conditions] to search with the specified conditions.

Viewing This Guide

0XW7-029

Symbols Used in This Guide

The following symbols are used in this Guide to mark descriptions of handling restrictions, precautions, and instructions that should be observed for your safety.

IMPORTANT

Indicates operational requirements and restrictions. Be sure to read these items carefully to operate the machine correctly, and avoid damage to the machine or property.

NOTE

Indicates a clarification of an operation, or contains additional explanations for a procedure. Reading these notes is highly recommended.

Keys and Buttons Used in This Guide

The following are examples of how control panel keys and on-screen buttons are depicted in this guide.

Type	Depiction in This Guide	Example
Control panel keys	[Key name] keys	[Network] key
Settings displayed on the control panel	<Setting name shown in the display>	<On>
Buttons on computer operation screen and so on	[Button name and so on]	[OK]

Screenshots Used in This Guide

The contents of the screenshots used in this guide are the default settings.

Depending on the system configuration, the contents of the screenshots may partly differ.

Disclaimer

Disclaimer 112

Disclaimer

0XW7-02A

The information in this manual is subject to change without notice.

CANON INC. MAKES NO WARRANTY OF ANY KIND WITH REGARD TO THIS MATERIAL, EITHER EXPRESS OR IMPLIED, EXCEPT AS PROVIDED HEREIN, INCLUDING WITHOUT LIMITATION, THEREOF, WARRANTIES AS TO MARKETABILITY, MERCHANTABILITY, FITNESS FOR A PARTICULAR PURPOSE OF USE OR AGAINST INFRINGEMENT OF ANY PATENT. CANON INC. SHALL NOT BE LIABLE FOR ANY DIRECT, INCIDENTAL, OR CONSEQUENTIAL DAMAGES OF ANY NATURE, OR LOSSES OR EXPENSES RESULTING FROM THE USE OF THIS MATERIAL.

Trademarks

Trademarks 114

Trademarks

0XW7-02E

- "MEAP" is a trademark of CANON Inc., referring to an "application platform" for Canon multifunction and single function printers.
- Apple, AppleTalk, EtherTalk, LocalTalk, Mac, Mac OS, and Safari are trademarks of Apple Inc., registered in the U.S. and other countries.
- Microsoft, Windows, Windows Vista, Windows Server, and Internet Explorer are either registered trademarks or trademarks of Microsoft Corporation in the United States and/or other countries.
- This product contains the Universal Font Scaling Technology or UFST® under license from Monotype Imaging, Inc. UFST® is a trademark of Monotype Imaging, Inc. registered in the United States Patent and Trademark Office and may be registered in certain jurisdictions.
- UFST: Copyright© 1989 - 1996, 1997, 2003, 2004, 2008, all rights reserved, by Monotype Imaging Inc.



- Java and all Java based trademarks and logos are trademarks or registered trademarks of Oracle and/or its affiliates.



- Adobe, PostScript, and the PostScript logo are either registered trademarks or trademarks of Adobe Systems Incorporated in the United States and/or other countries.
- Copyright© 2007 -08 Adobe Systems Incorporated. All rights reserved.
- Protected by U.S. Patents 5,737,599; 5,781,785; 5,819,301; 5,929,866; 5,943,063; 6,073,148; 6,515,763; 6,639,593; 6,754,382; 7,046,403; 7,213,269; 7,242,415; Patents pending in the U.S. and other countries.
- All instances of the name PostScript in the text are references to the PostScript language as defined by Adobe Systems Incorporated unless otherwise stated. The name PostScript also is used as a product trademark for Adobe Systems' implementation of the PostScript language interpreter.
- Except as otherwise stated, any reference to a "PostScript printing device," "PostScript display device," or similar item refers to a printing device, display device or item (respectively) that contains PostScript technology created or licensed by Adobe Systems Incorporated and not to devices or items that purport to be merely compatible with the PostScript language.
- Adobe, the Adobe logo, PostScript, the PostScript logo, and PostScript 3 are either registered trademarks or trademarks of Adobe Systems Incorporated in the United States and/or other countries.
- Linux is a registered trademark of Linus Torvalds. Microsoft and Windows are either registered trademarks or trademarks of Microsoft Corporation in the United States and/or other countries.

Trademarks

- All other trademarks are the property of their respective owners.
- All other product and brand names are registered trademarks, trademarks or service marks of their respective owners.

This Font Software is licensed under the SIL Open Font License, Version 1.1.

This license is copied below, and is also available with a FAQ at: <http://scripts.sil.org/OFL>

SIL OPEN FONT LICENSE Version 1.1 - 26 February 2007

PREAMBLE

The goals of the Open Font License (OFL) are to stimulate worldwide development of collaborative font projects, to support the font creation efforts of academic and linguistic communities, and to provide a free and open framework in which fonts may be shared and improved in partnership with others.

The OFL allows the licensed fonts to be used, studied, modified and redistributed freely as long as they are not sold by themselves. The fonts, including any derivative works, can be bundled, embedded, redistributed and/or sold with any software provided that any reserved names are not used by derivative works. The fonts and derivatives, however, cannot be released under any other type of license. The requirement for fonts to remain under this license does not apply to any document created using the fonts or their derivatives.

DEFINITIONS

"Font Software" refers to the set of files released by the Copyright Holder(s) under this license and clearly marked as such. This may include source files, build scripts and documentation.

"Reserved Font Name" refers to any names specified as such after the copyright statement(s).

"Original Version" refers to the collection of Font Software components as distributed by the Copyright Holder(s).

"Modified Version" refers to any derivative made by adding to, deleting, or substituting -- in part or in whole -- any of the components of the Original Version, by changing formats or by porting the Font Software to a new environment.

"Author" refers to any designer, engineer, programmer, technical writer or other person who contributed to the Font Software.

PERMISSION & CONDITIONS

Permission is hereby granted, free of charge, to any person obtaining a copy of the Font Software, to use, study, copy, merge, embed, modify, redistribute, and sell modified and unmodified copies of the Font Software, subject to the following conditions:

- 1) Neither the Font Software nor any of its individual components, in Original or Modified Versions, may be sold by itself.
- 2) Original or Modified Versions of the Font Software may be bundled, redistributed and/or sold with any software, provided that each copy contains the above copyright notice and this license. These can be included either as stand-alone text files, human-readable headers or in the appropriate machine-readable metadata fields within text or binary files as long as those fields can be easily viewed by the user.
- 3) No Modified Version of the Font Software may use the Reserved Font Name(s) unless explicit written permission is granted by the corresponding Copyright Holder. This restriction only applies to the primary font name as presented to the users.
- 4) The name(s) of the Copyright Holder(s) or the Author(s) of the Font Software shall not be used to promote, endorse or advertise any Modified Version, except to acknowledge the contribution(s) of the Copyright Holder(s) and the Author(s) or with their explicit written permission.
- 5) The Font Software, modified or unmodified, in part or in whole, must be distributed entirely under this license, and must not be distributed under any other license. The requirement for fonts to remain under this license does not apply to any document created using the Font Software.

TERMINATION

This license becomes null and void if any of the above conditions are not met.

DISCLAIMER

THE FONT SOFTWARE IS PROVIDED "AS IS", WITHOUT WARRANTY OF ANY KIND, EXPRESS OR IMPLIED, INCLUDING BUT NOT LIMITED TO ANY WARRANTIES OF MERCHANTABILITY, FITNESS FOR A PARTICULAR PURPOSE AND NONINFRINGEMENT OF COPYRIGHT, PATENT, TRADEMARK, OR OTHER RIGHT. IN NO EVENT SHALL THE COPYRIGHT HOLDER BE LIABLE FOR ANY CLAIM, DAMAGES OR OTHER LIABILITY, INCLUDING ANY GENERAL, SPECIAL, INDIRECT, INCIDENTAL, OR CONSEQUENTIAL DAMAGES, WHETHER IN AN ACTION OF CONTRACT, TORT OR OTHERWISE, ARISING FROM, OUT OF THE USE OR INABILITY TO USE THE FONT SOFTWARE OR FROM OTHER DEALINGS IN THE FONT SOFTWARE.