

MICROWAVE STERILISER

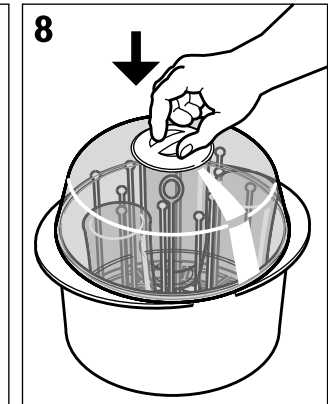

PHILIPS

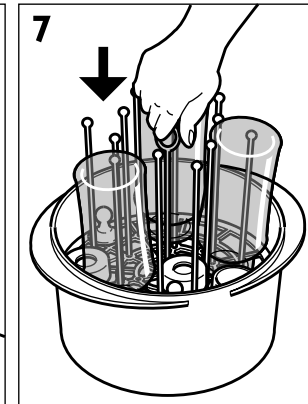
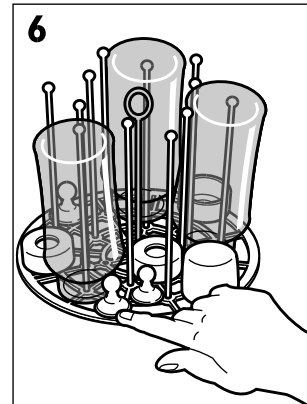
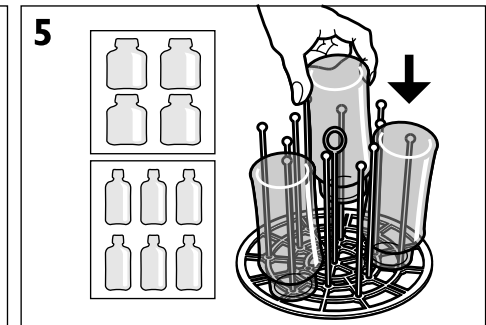
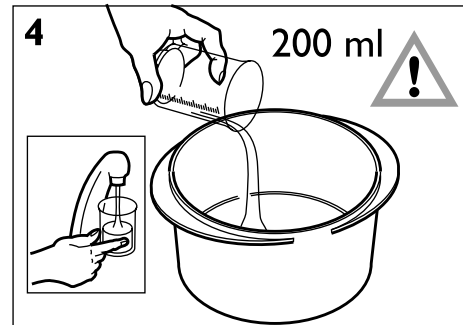
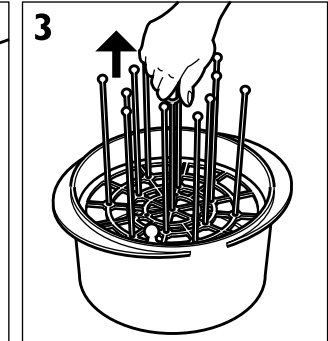
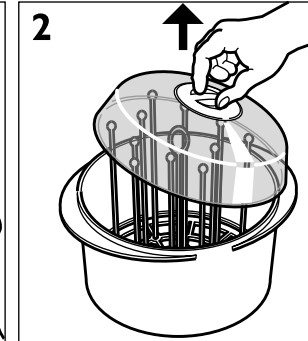
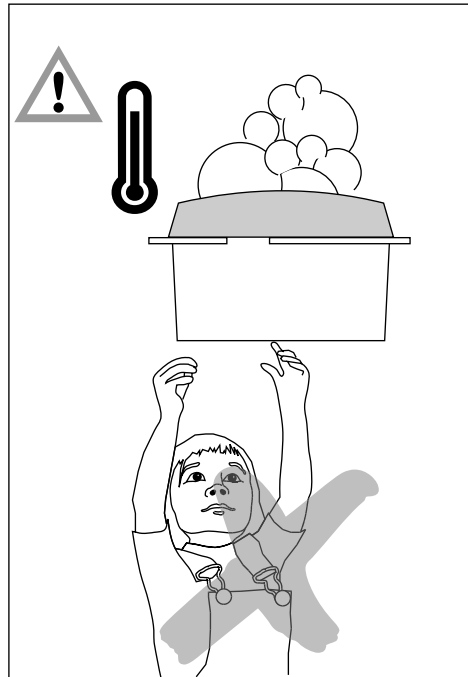
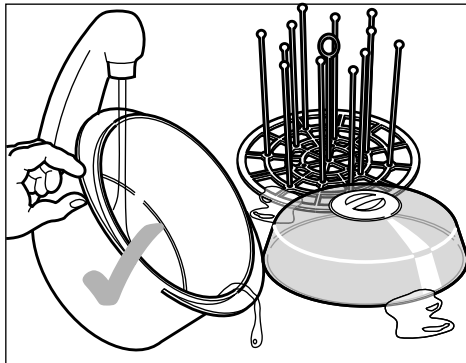
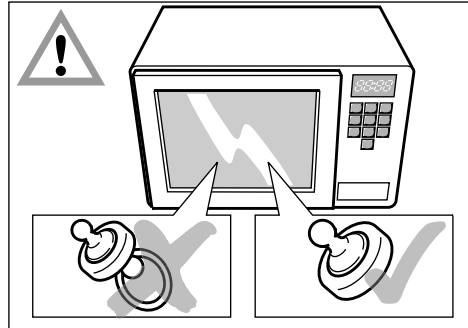
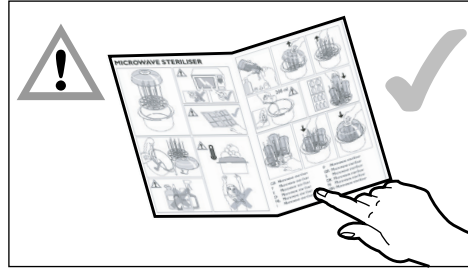
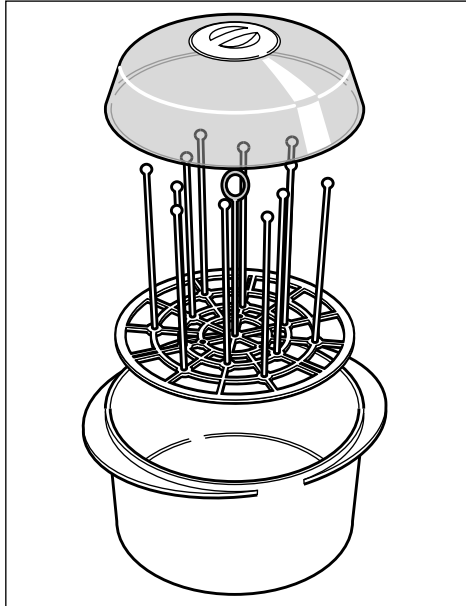
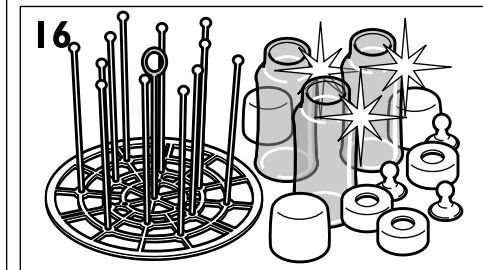
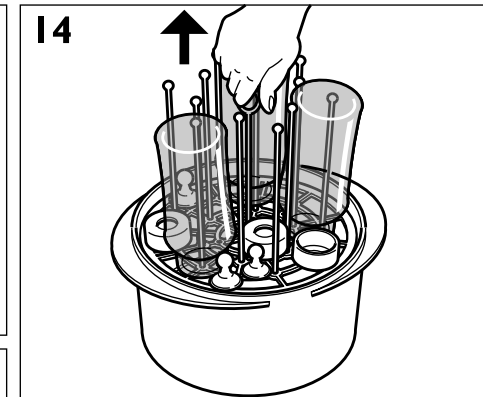
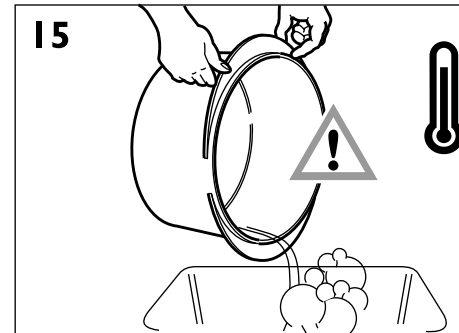
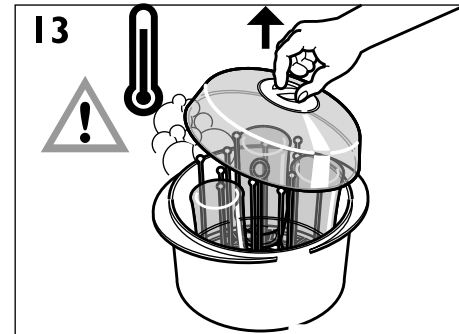
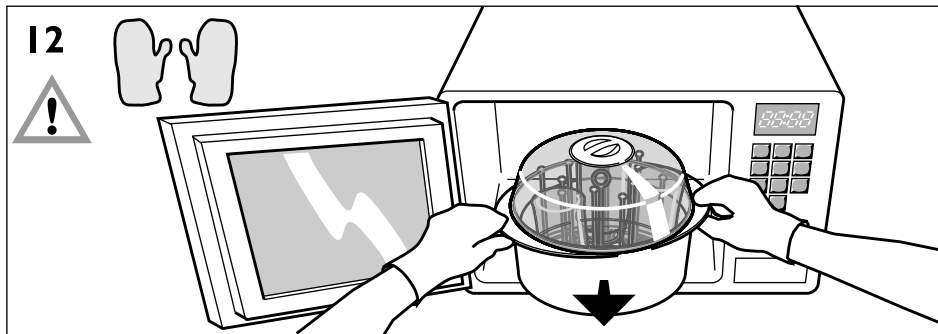
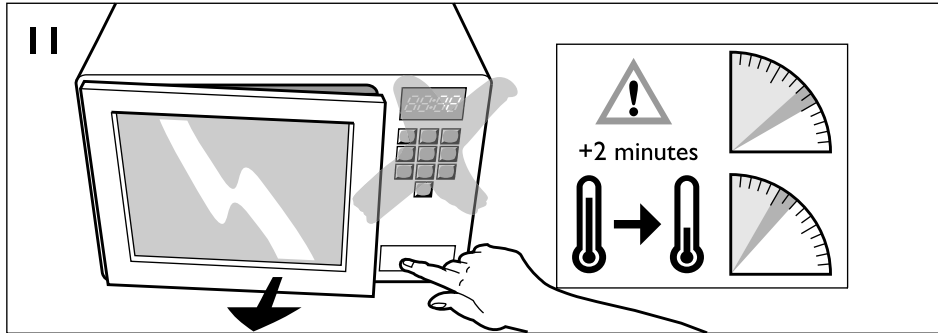
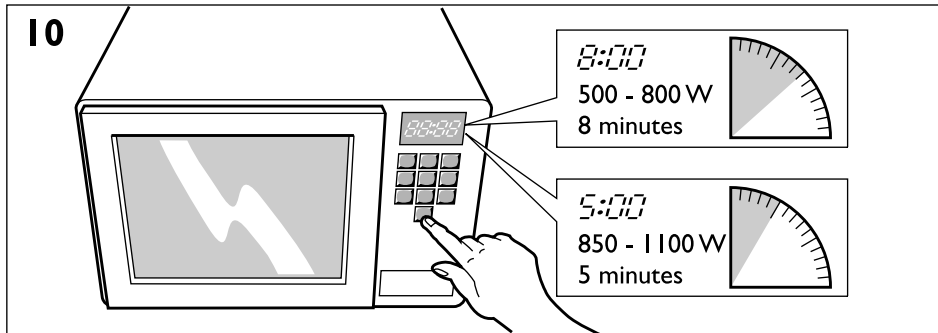
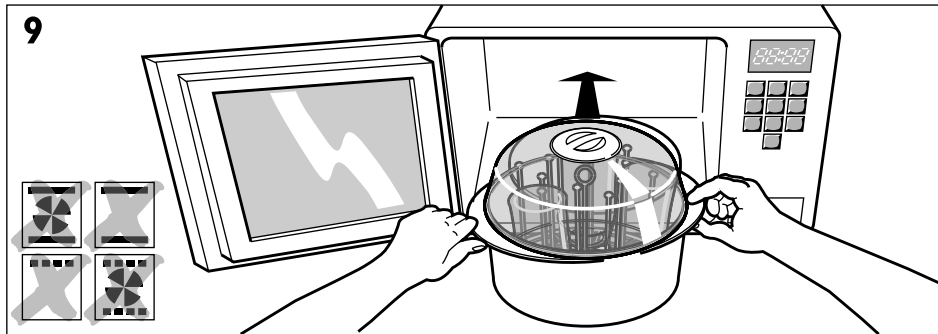

GB: Sterilising means destroying harmful bacteria. It does NOT mean sterilisation according to clinical standards.

F: La stérilisation signifie la destruction des bactéries nuisibles. Cela ne signifie PAS la stérilisation selon les normes cliniques.

E: Esterilizar significa destruir las bacterias. Esto NO corresponde a la esterilización según los criterios clínicos.

D: Desinfizieren bedeutet, schädliche Bakterien abzutöten. Dabei handelt es sich NICHT um eine Desinfektion im klinischen Sinn.

NL: Onder steriliseren wordt het vernietigen van schadelijke bacteriën verstaan. Er wordt NIET sterilisatie volgens klinische normen onder verstaan.

I: Sterilizzare significa distruggere i batteri dannosi. NON significa quindi sterilizzare in conformità agli standard clinici.

P: Esterilização significa destruição de bactérias prejudiciais. Não significa esterilização de acordo com os padrões clínicos.

GR: Αποστείρωση σημαίνει εξόντωση βλαβερών βακτηριδίων. Ο όρος .ΕΝ χρησιμοποιείται σύμφωνα με την κλινική του έννοια.

S: Sterilisering innebär här att ta kål på skadliga bakterier vid. Det innebär INTE vad man menar med sterilisering i kliniska sammanhang.

DK: Sterilisering betyder bekæmpelse af skadelige bakterier. Det betyder IKKE sterilisering efter kliniske standarder.

N: Sterilisering i denne sammenheng innbærer å drepe skadelige bakterier. Det betyr IKKE sterilisering i henhold til kliniske standarder.

FIN: Sterilointi tarkoittaa vahingollisten bakteerien. Se ei tarkoita kliinisten normien mukaista sterilointia.