

Quick Reference

Copy

Making copies

- 1 Load an original document into the ADF tray or on the scanner glass.

Note: To avoid a cropped image, make sure that the original document and output have the same paper size.

- 2 From the home screen, touch **Copy**, and then specify the number of copies.

If necessary, adjust the copy settings.

- 3 Copy the document.

Note: To make a quick copy, from the control panel, press



Copying on both sides of the paper

- 1 Load an original document into the ADF tray or on the scanner glass.

- 2 From the home screen, touch **Copy > Sides**.

- 3 Adjust the settings.

- 4 Copy the document.

Copying multiple pages onto a single sheet

- 1 Load an original document into the ADF tray or on the scanner glass.

- 2 From the home screen, touch **Copy > Pages per Side**.

- 3 Adjust the settings.

- 4 Copy the document.

Fax

Sending a fax

Using the control panel

- 1 Load the original document into the ADF tray or on the scanner glass.

- 2 From the home screen, touch **Fax**, and then enter the needed information.

- 3 If necessary, configure other fax settings.

- 4 Send the fax job.

Using the computer

Note: Make sure that the Universal Fax driver is installed.

For Windows users

- 1 With a document open, click **File > Print**.

- 2 Select the printer, and then click **Properties, Preferences, Options, or Setup**.

- 3 Click **Fax > Enable fax**, and then enter the recipient number.

- 4 If necessary, configure other fax settings.

- 5 Send the fax job.

For Macintosh users

- 1 With a document open, choose **File > Print**.

- 2 Select the printer and enter the recipient number.

- 3 If necessary, configure other fax settings.

- 4 Send the fax job.

E-mail

Sending an e-mail

- 1 Load an original document into the ADF tray or on the scanner glass.

- 2 From the home screen, touch **E-mail**, and then enter the needed information.

- 3 If necessary, configure the output file type settings.

- 4 Send the e-mail.

Print

Printing from a computer

Note: For labels, card stock, and envelopes, set the paper size and type in the printer before printing the document.

- 1 From the document that you are trying to print, open the Print dialog.

- 2 If necessary, adjust the settings.

- 3 Print the document.

Printing from a mobile device

Printing from a mobile device using Google Cloud Print

Google Cloud Print™ is a printing service that allows you to print to any Google Cloud Print-ready printer.

Before you begin, make sure that:

- The printer is registered to the Google Cloud Print server.
- The Cloud Print plugin is downloaded from the Google Play™ store and is enabled in the mobile device.

- 1 From your Android™ mobile device, open a document or select a document from your file manager.



- 2 Tap  > **Print**.

- 3 Select a printer, and then tap .

Printing from a mobile device using Mopria Print Service

Mopria® Print Service is a mobile printing solution for mobile devices running on Android version 5.0 or later. It allows you to print directly to any Mopria-certified printer.

Note: Make sure that you download the Mopria Print Service application from the Google Play store and enable it in the mobile device.

- 1 From your Android mobile device, launch a compatible application or select a document from your file manager.
- 2 Tap  > **Print**.
- 3 Select a printer, and then adjust the settings, if necessary.
- 4 Tap .

Printing from a mobile device using AirPrint

The AirPrint software feature is a mobile printing solution that allows you to print directly from Apple devices to an AirPrint-certified printer.

Notes:



- Make sure that the Apple device and the printer are connected to the same network. If the network has multiple wireless hubs, then make sure that both devices are connected to the same subnet.
 - This application is supported only in some Apple devices.
- 1 From your mobile device, select a document from your file manager or launch a compatible application.

- 2 Tap  > **Print**.
- 3 Select a printer, and then adjust the settings, if necessary.
- 4 Print the document.

Printing from a mobile device using Wi-Fi Direct®

Wi-Fi Direct® is a printing service that lets you print to any Wi-Fi Direct-ready printer.

Note: Make sure that the mobile device is connected to the printer wireless network. For more information, see [“Connecting a mobile device to the printer” on page 5](#).

- 1 From your mobile device, launch a compatible application or select a document from your file manager.
- 2 Depending on your mobile device, do one of the following:
 - Tap  > **Print**.
 - Tap  > **Print**.
 - Tap  > **Print**.
- 3 Select a printer, and then adjust the settings, if necessary.
- 4 Print the document.

Printing confidential and other held jobs

For Windows users

- 1 With a document open, click **File** > **Print**.
- 2 Click **Properties, Preferences, Options, or Setup**.
- 3 Click **Print and Hold**.
- 4 Select **Use Print and Hold**, and then assign a user name.
- 5 Select the print job type (Confidential, Repeat, Reserve, or Verify).
If the print job is confidential, then enter a four-digit PIN.
- 6 Click **OK** or **Print**.
- 7 From the printer home screen, release the print job.
 - For confidential print jobs, navigate to:
Held jobs > select your user name > **Confidential** > enter the PIN > select the print job > configure the settings > **Print**
 - For other print jobs, navigate to:
Held jobs > select your user name > select the print job > configure the settings > **Print**

For Macintosh users

- 1 With a document open, choose **File** > **Print**.
If necessary, click the disclosure triangle to see more options.
- 2 From the print options or Copies & Pages menu, choose **Job Routing**.

- 3 Select the print job type (Confidential, Repeat, Reserve, or Verify).
If the print job is confidential, then assign a user name and a four-digit PIN.
- 4 Click **OK** or **Print**.
- 5 From the printer home screen, release the print job.
 - For confidential print jobs, navigate to:
Held jobs > select your user name > **Confidential** > enter the PIN > select the print job > configure the settings > **Print**
 - For other print jobs, navigate to:
Held jobs > select your user name > select the print job > configure the settings > **Print**

Maintain the printer

Replacing the toner cartridge

- 1 Open the front door.

Warning—Potential Damage: To prevent damage from electrostatic discharge, touch any exposed metal frame of the printer before accessing or touching interior areas of the printer.

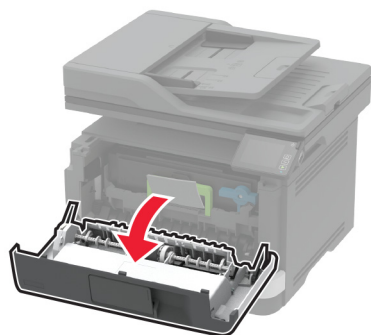
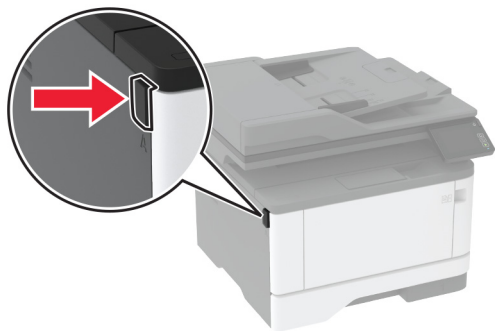

2 Remove the imaging unit.

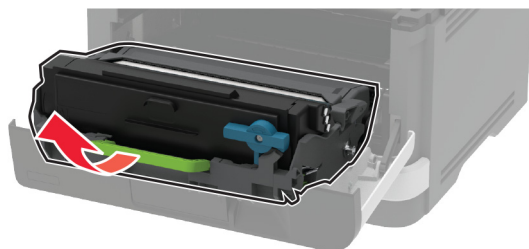

3 Twist the blue latch, and then remove the used toner cartridge from the imaging unit.

Warning—Potential Damage: Do not expose the imaging unit to direct light for more than 10 minutes. Extended exposure to light may cause print quality problems.

Warning—Potential Damage: Do not touch the photoconductor drum. Doing so may affect the quality of future print jobs.

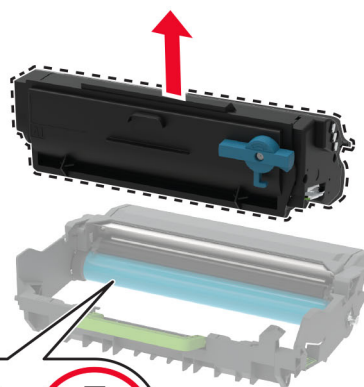
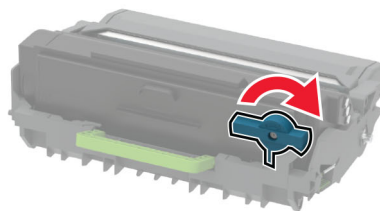

4 Unpack the new toner cartridge.

5 Shake the toner cartridge to redistribute the toner.

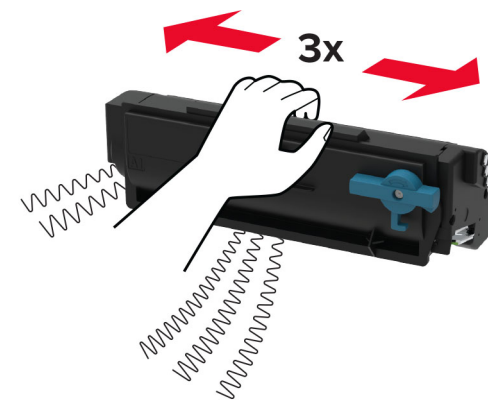

6 Insert the new toner cartridge into the imaging unit until it clicks into place.

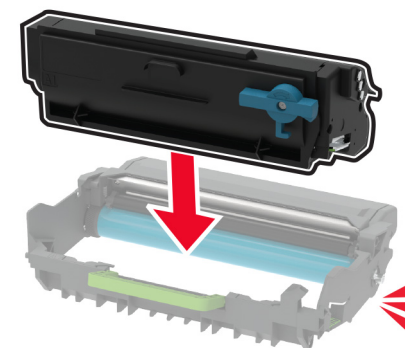

7 Insert the imaging unit.

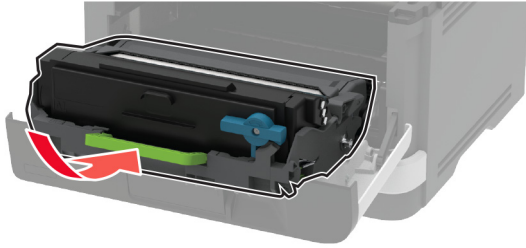

8 Close the door.

Cleaning the scanner

1 Open the scanner cover.

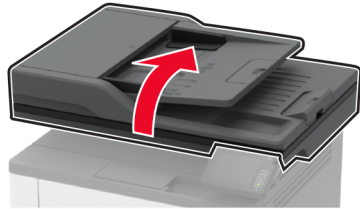

2 Using a damp, soft, lint-free cloth, wipe the following areas:

- ADF glass pad

Note: In some printer models, this location has an ADF glass instead of a pad.

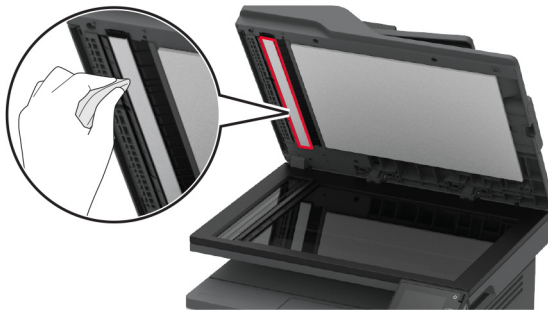

- Scanner glass pad



- ADF glass



- Scanner glass



3 Close the scanner cover.

Loading trays

1 Remove the tray.

Note: To avoid paper jams, do not remove the tray while the printer is busy.



2 Adjust the guides to match the size of the paper that you are loading.

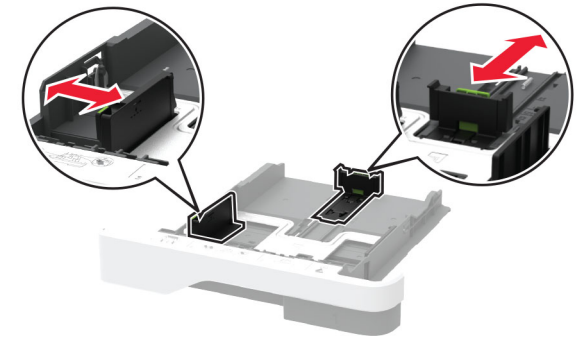

3 Flex, fan, and align the paper edges before loading.

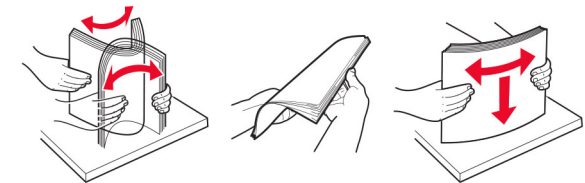

- 4 Load the paper stack with the printable side facedown, and then make sure that the guides fit snugly against the paper.

Notes:

- Load letterhead facedown with the header toward the front of the tray for one-sided printing.
- Load letterhead faceup with the header toward the back of the tray for two-sided printing.
- Do not slide paper into the tray.
- To avoid paper jams, make sure that the stack height is below the maximum paper fill indicator.



- 5 Insert the tray.

If necessary, set the paper size and paper type from the control panel to match the paper loaded.

Loading the multipurpose feeder

- 1 Open the multipurpose feeder.

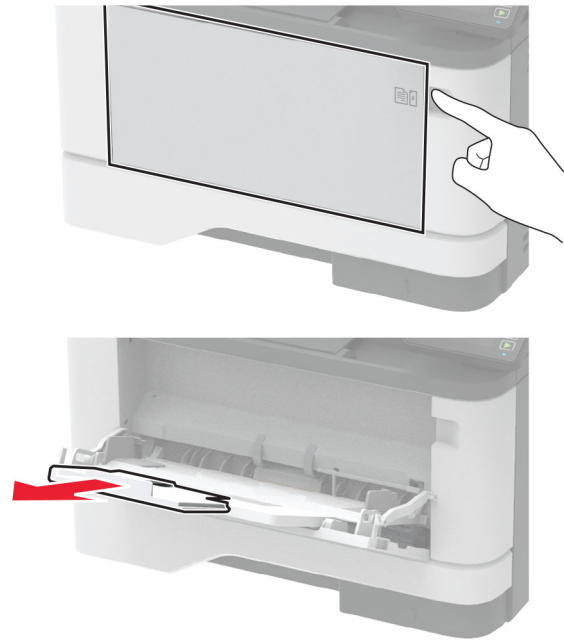

- 2 Flex, fan, and align the paper edges before loading.

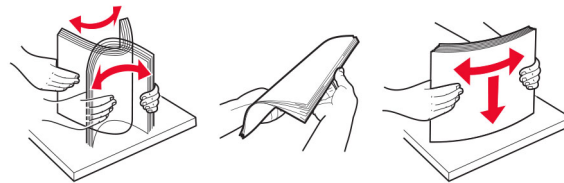

- 3 Load paper with the printable side faceup.

Notes:

- Load letterhead faceup with the header toward the rear of the printer for one-sided printing.
- Load letterhead facedown with the header toward the front of the printer for two-sided printing.
- Load envelopes with the flap facedown on the left side.

Warning—Potential Damage: Do not use envelopes with stamps, clasps, snaps, windows, coated linings, or self-stick adhesives.

- 4 Adjust the guide to match the size of the paper that you are loading.

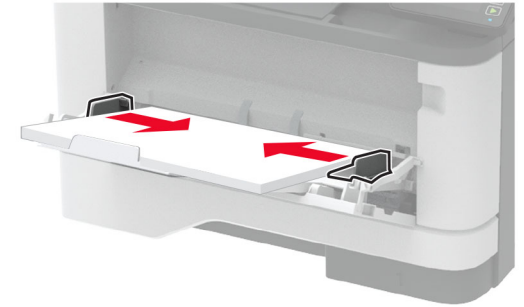

- 5 From the control panel, set the paper size and paper type to match the paper loaded.

Setting the paper size and type

- 1 From the home screen, navigate to:

Settings > Paper > Tray Configuration > Paper Size/Type > select a paper source

- 2 Set the paper size and type.

Connecting a mobile device to the printer

Before connecting your mobile device, make sure to do the following:

- Enable Wi-Fi Direct in the printer. From the control panel, navigate to: **Settings > Network/Ports > Wireless > Enable Wi-Fi Direct.**
- Show the preshared key (PSK) on the Network Setup Page. From the control panel, navigate to: **Settings > Network/Ports > Wi-Fi Direct > Show PSK on Setup Page.**
- Print the Network Setup Page. From the control panel, navigate to: **Settings > Reports > Network > Network Setup Page.**

Connecting using Wi-Fi Direct

- 1 From the mobile device, go to the settings menu.
- 2 Enable Wi-Fi, and then tap **Wi-Fi Direct**.
- 3 Select the printer SSID.
- 4 Confirm the connection on the printer control panel.

Connecting using Wi-Fi

- 1 From the mobile device, go to the settings menu.
- 2 Tap **Wi-Fi**, and then select the printer SSID.

Note: The string **DIRECT-xy** (where **x** and **y** are two random characters) is added before the SSID.

- 3 Enter the PSK.

Note: The PSK is the password.

Notes:

- You can change the SSID on the control panel. Navigate to: **Settings > Network/Ports > Wi-Fi Direct > SSID**.
- You can also change the PSK on the control panel. Navigate to: **Settings > Network/Ports > Wi-Fi Direct > Set PSK**.

Clearing jams

Avoiding jams

Load paper properly

- Make sure that the paper lies flat in the tray.

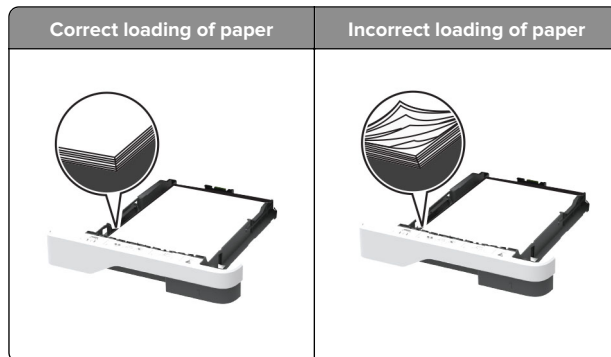

- Do not load or remove a tray while the printer is printing.
- Do not load too much paper. Make sure that the stack height is below the maximum paper fill indicator.
- Do not slide paper into the tray. Load paper as shown in the illustration.

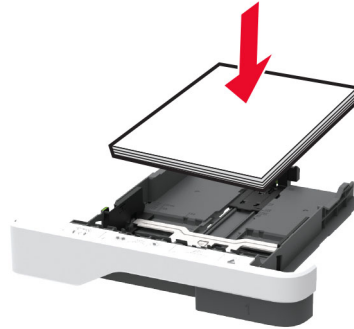

- Make sure that the paper guides are positioned correctly and are not pressing tightly against the paper or envelopes.
- Push the tray firmly into the printer after loading paper.

Use recommended paper

- Use only recommended paper or specialty media.
- Do not load paper that is wrinkled, creased, damp, bent, or curled.
- Flex, fan, and align the paper edges before loading.

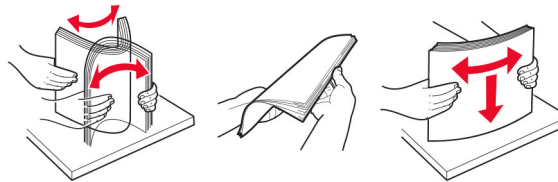

- Do not use paper that has been cut or trimmed by hand.
- Do not mix paper sizes, weights, or types in the same tray.
- Make sure that the paper size and type are set correctly on the computer or printer control panel.
- Store paper according to manufacturer recommendations.

Identifying jam locations

Notes:

- When Jam Assist is set to On, the printer flushes blank pages or pages with partial prints after a jammed page has been cleared. Check your printed output for blank pages.
- When Jam Recovery is set to On or Auto, the printer reprints jammed pages.

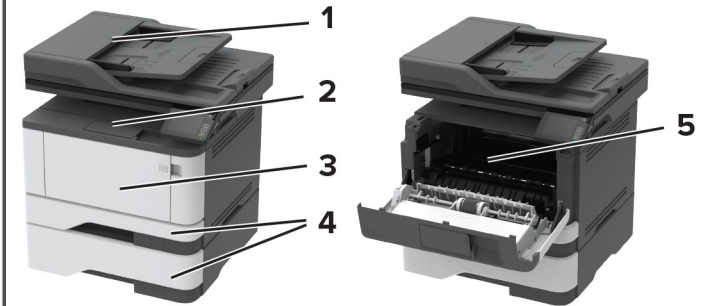

	Jam locations
1	Automatic document feeder
2	Standard bin
3	Multipurpose feeder
4	Trays
5	Duplex unit
6	Rear door

Paper jam in the automatic document feeder

- 1 Remove all original documents from the ADF tray.
- 2 Open the ADF cover.

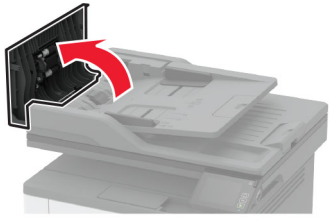

- 3 Remove the jammed paper.

Note: Make sure that all paper fragments are removed.

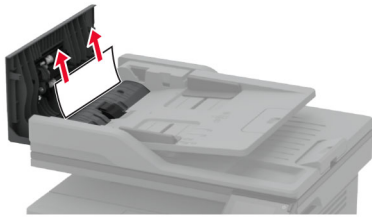

- 4 Close the ADF cover.

Paper jam in the standard bin

- 1 Raise the scanner, and then remove the jammed paper.

Note: Make sure that all paper fragments are removed.

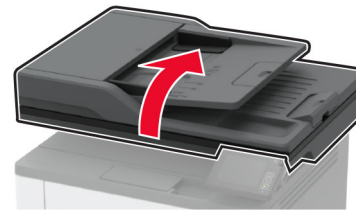

- 2 Lower the scanner.

Paper jam in the multipurpose feeder

- 1 Remove paper from the multipurpose feeder.

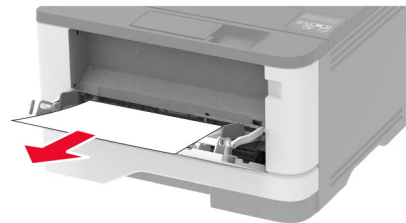

- 2 Remove the jammed paper.

Note: Make sure that all paper fragments are removed.

- 3 Close the multipurpose feeder.

- 4 Open the front door.

Warning—Potential Damage: To prevent damage from electrostatic discharge, touch any exposed metal frame of the printer before accessing or touching interior areas of the printer.

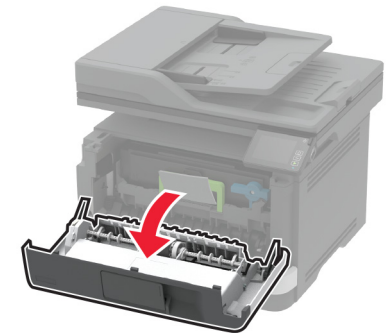
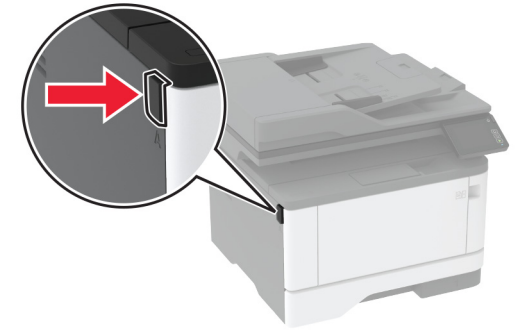

- 5 Remove the imaging unit.



Warning—Potential Damage: Do not expose the imaging unit to direct light for more than 10 minutes. Extended exposure to light may cause print quality problems.

Warning—Potential Damage: Do not touch the photoconductor drum. Doing so may affect the quality of future print jobs.



6 Remove the jammed paper.

CAUTION—HOT SURFACE: The inside of the printer might be hot. To reduce the risk of injury from a hot component, allow the surface to cool before touching it.

Note: Make sure that all paper fragments are removed.



7 Insert the imaging unit.

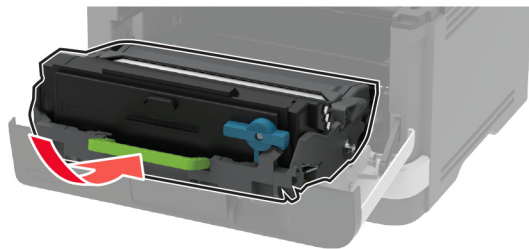

8 Close the door.

9 Open the multipurpose feeder.

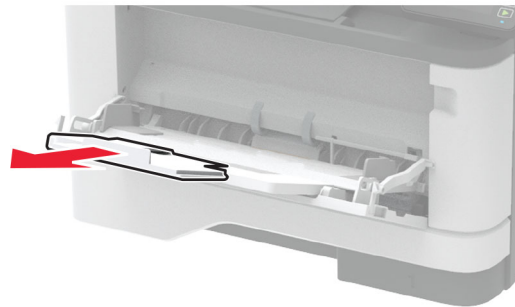

10 Flex, fan, and align the paper edges before loading.

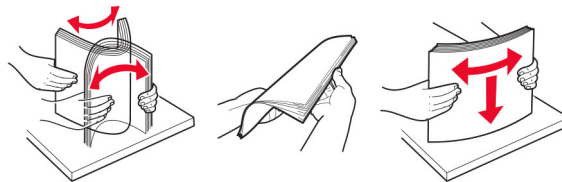

11 Reload paper.

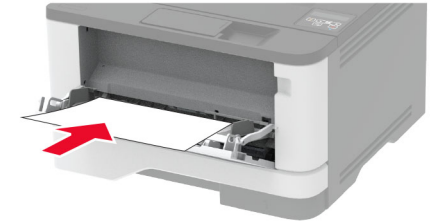

Paper jam in trays

1 Remove the tray.

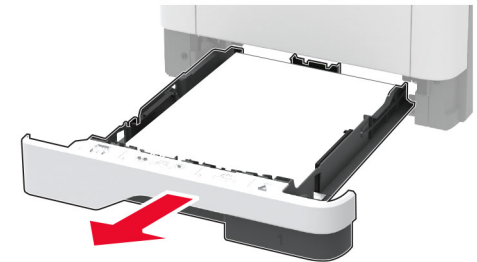

2 Open the front door.

Warning—Potential Damage: To prevent damage from electrostatic discharge, touch any exposed metal frame of the printer before accessing or touching interior areas of the printer.

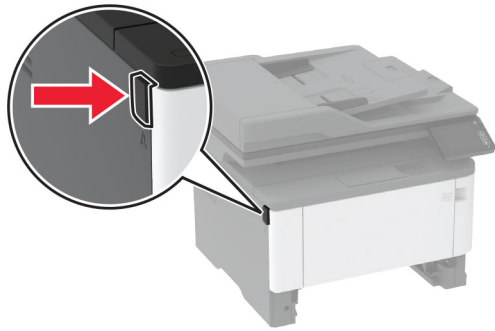

Warning—Potential Damage: Do not touch the photoconductor drum. Doing so may affect the quality of future print jobs.



CAUTION—HOT SURFACE: The inside of the printer might be hot. To reduce the risk of injury from a hot component, allow the surface to cool before touching it.

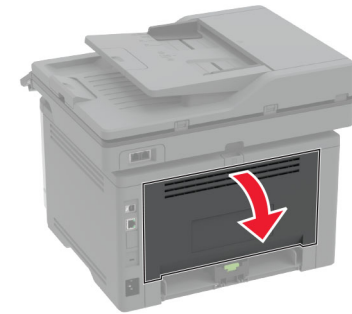

3 Remove the imaging unit.

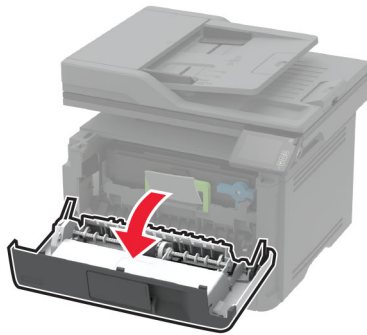

4 Remove the jammed paper.

CAUTION—HOT SURFACE: The inside of the printer might be hot. To reduce the risk of injury from a hot component, allow the surface to cool before touching it.

Note: Make sure that all paper fragments are removed.

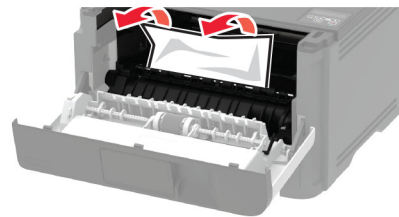

8 Remove the jammed paper.

Note: Make sure that all paper fragments are removed.

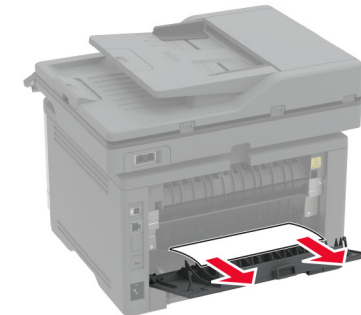

9 Close the rear door.

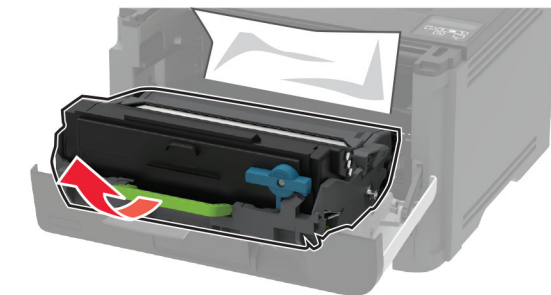

Warning—Potential Damage: Do not expose the imaging unit to direct light for more than 10 minutes. Extended exposure to light may cause print quality problems.

5 Insert the imaging unit.

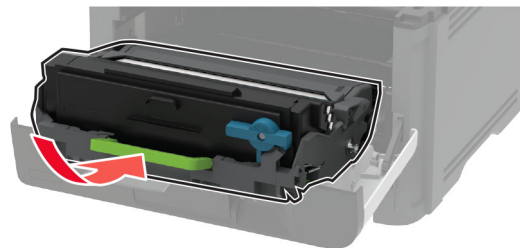

6 Close the front door, and then insert the tray.

7 Open the rear door.

10 Remove the optional tray.



11 Remove the jammed paper.

Note: Make sure that all paper fragments are removed.

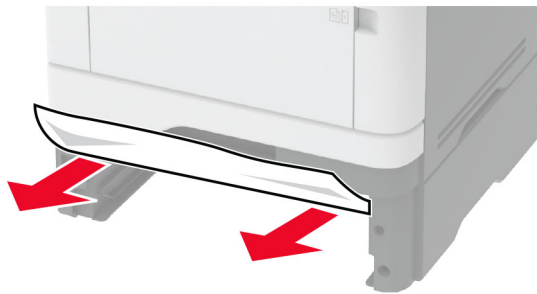

12 Insert the tray.

Paper jam in the duplex unit

1 Open the front door.

Warning—Potential Damage: To prevent damage from electrostatic discharge, touch any exposed metal frame of the printer before accessing or touching interior areas of the printer.

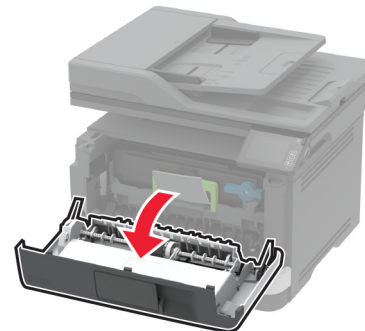
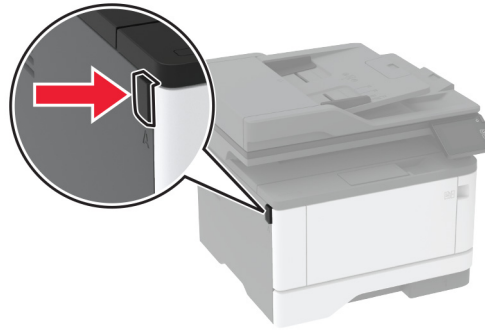

2 Remove the imaging unit.



Warning—Potential Damage: Do not expose the imaging unit to direct light for more than 10 minutes. Extended exposure to light may cause print quality problems.

Warning—Potential Damage: Do not touch the photoconductor drum. Doing so may affect the quality of future print jobs.



3 Remove the jammed paper.

CAUTION—HOT SURFACE: The inside of the printer might be hot. To reduce the risk of injury from a hot component, allow the surface to cool before touching it.

Note: Make sure that all paper fragments are removed.



4 Insert the imaging unit.

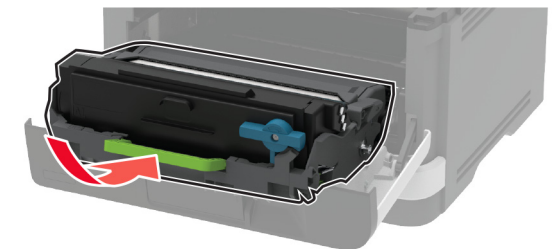

5 Close the door.

6 Remove the tray.



7 Push the duplex unit latch to open the duplex unit.

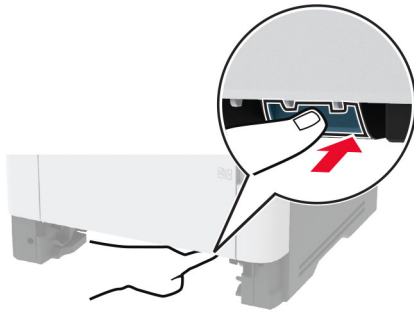

8 Remove the jammed paper.

Note: Make sure that all paper fragments are removed.

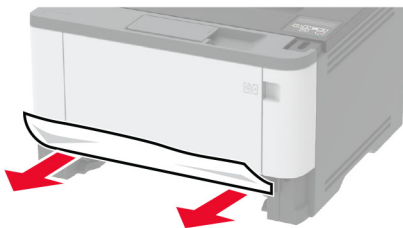

9 Close the duplex unit.

10 Insert the tray.

Paper jam in the rear door

1 Open the front door.

Warning—Potential Damage: To prevent damage from electrostatic discharge, touch any exposed metal frame of the printer before accessing or touching interior areas of the printer.

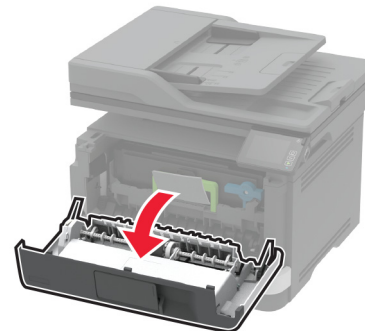
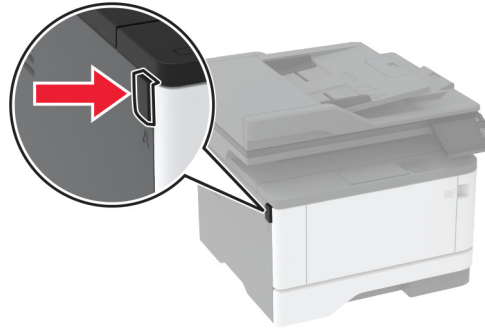

2 Remove the imaging unit.

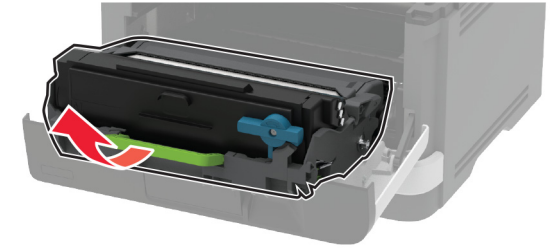

Warning—Potential Damage: Do not expose the imaging unit to direct light for more than 10 minutes. Extended exposure to light may cause print quality problems.

Warning—Potential Damage: Do not touch the photoconductor drum. Doing so may affect the quality of future print jobs.



3 Open the rear door.

 **CAUTION—HOT SURFACE:** The inside of the printer might be hot. To reduce the risk of injury from a hot component, allow the surface to cool before touching it.



4 Remove the jammed paper.

Note: Make sure that all paper fragments are removed.

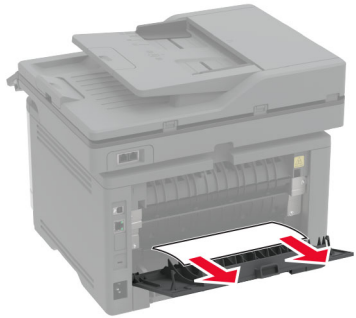

5 Close the rear door.

6 Insert the imaging unit.

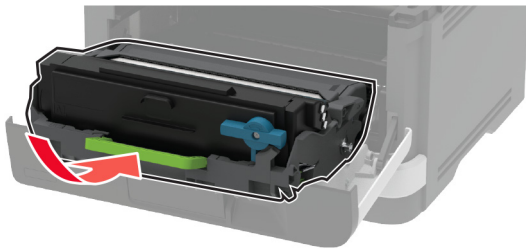

7 Close the front door.