

ViewSonic®



> **ViewBoard IFP50-3 series**

Commercial Touch Display

Quick Start Guide

Startvejledning

Snelle gebruikshandleiding

Pikakäynnistysopas

Guide de démarrage rapide

Schnellstartanleitung

Panduan Ringkas

Hurtigstartveiledning

Skrócona instrukcja obsługi

Краткое руководство

Guía rápida de inicio

Snabbstartsguide

คู่มือเริ่มต้นฉบับย่อ

快速入門手冊

Hızlı Başlangıç Kılavuzu

요약 설명서



> Package Contents

- Power cable (ship by region)
- Remote control
- AAA battery x 2
- USB cable
- Touch Pen
- Quick start guide
- RS232 adapter
- Clamp x 5
- Camera Plate
- Screw
- Signal cable compatible with HDMI

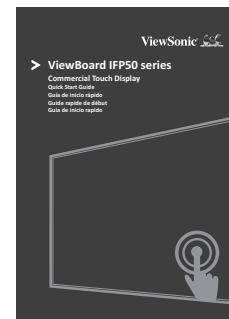
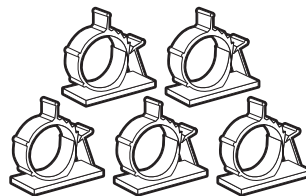
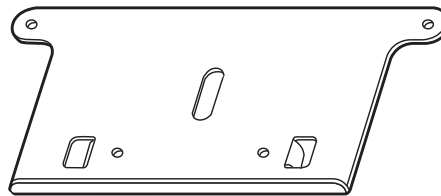
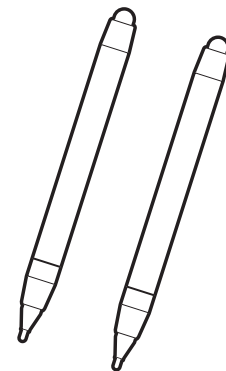
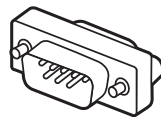
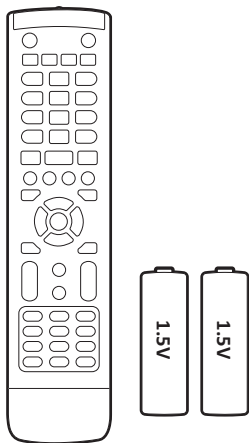
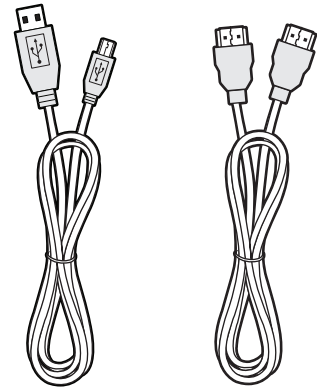
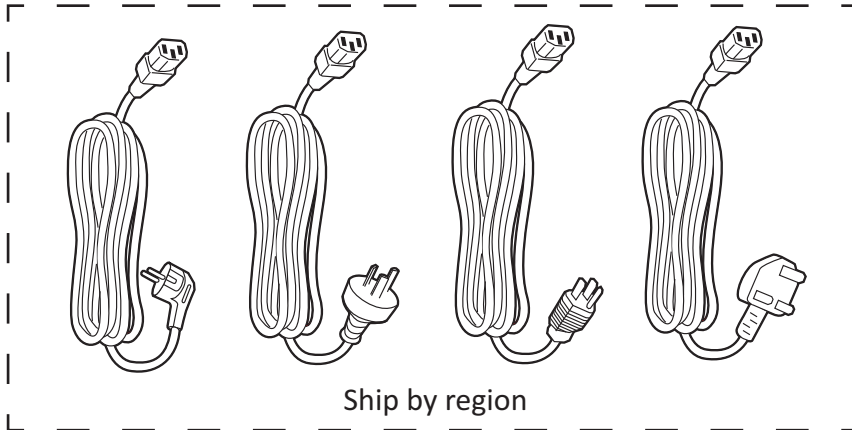

➤ Wall Mount Kit Specifications (VESA)

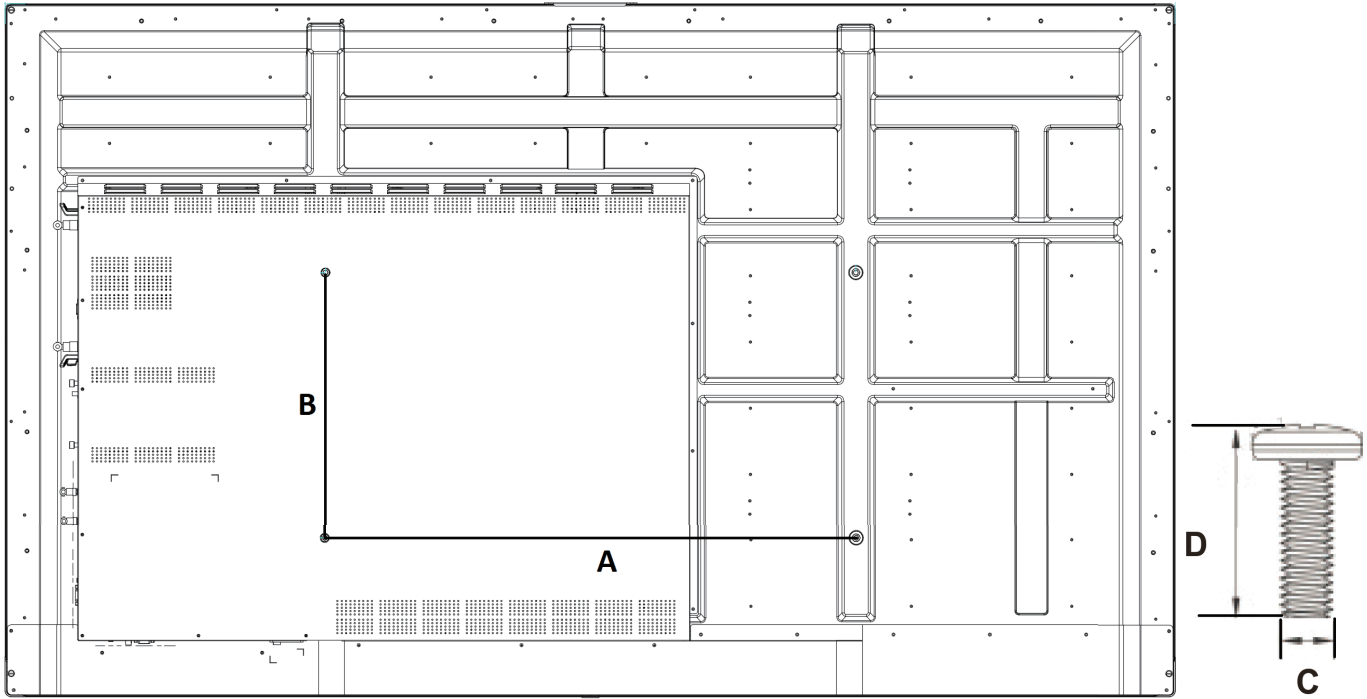

inch	VESA Spec. (A x B)	Standard Screw (C x D)	Quantity
IFP5550 - 55"	400 x 200 mm	M8 x 25 mm	4
IFP6550 - 65"	600 x 400 mm	M8 x 25 mm	4
IFP7550 - 75"	800 x 400 mm	M8 x 25 mm	4
IFP8650 - 86"	800 x 600 mm	M8 x 25 mm	4

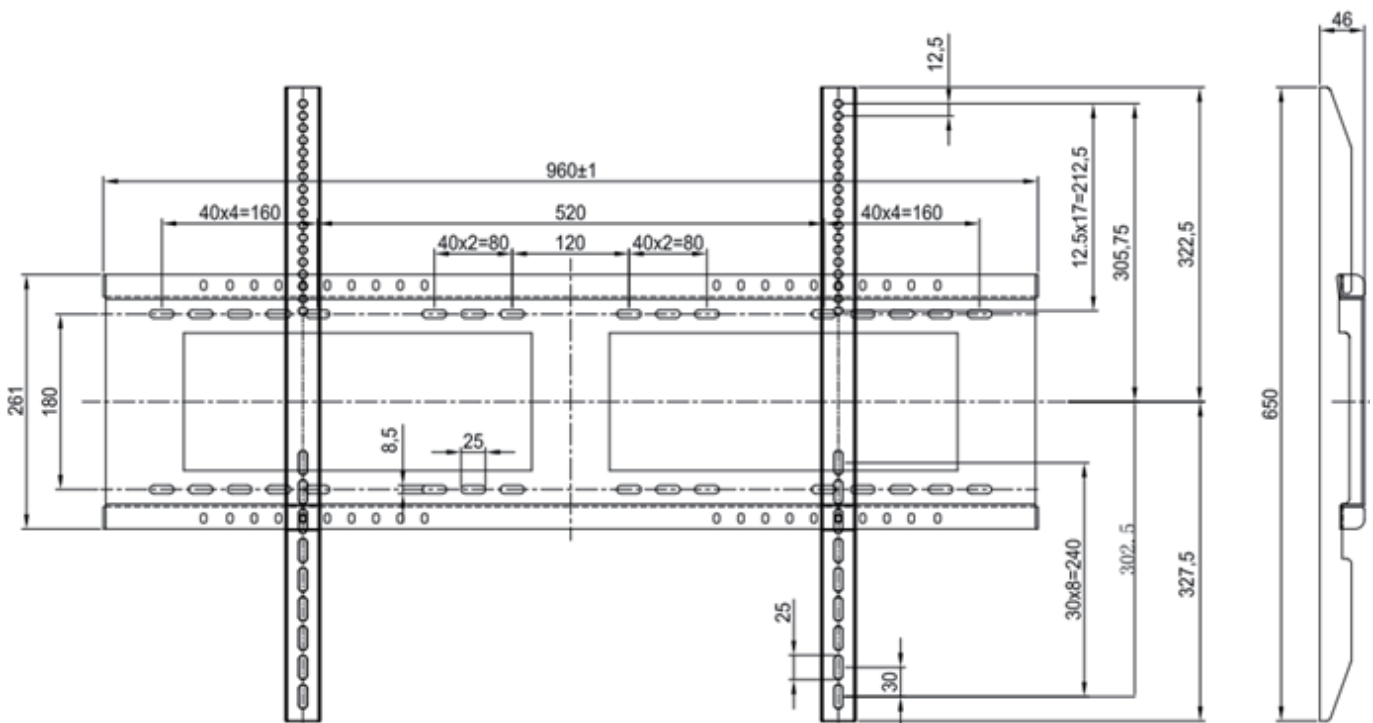

> Installation Environment Attention

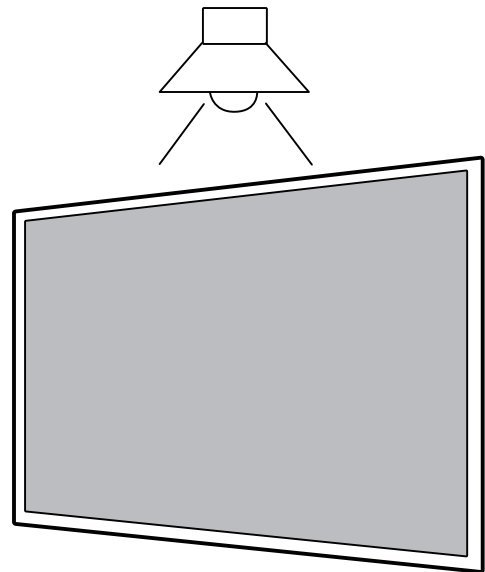
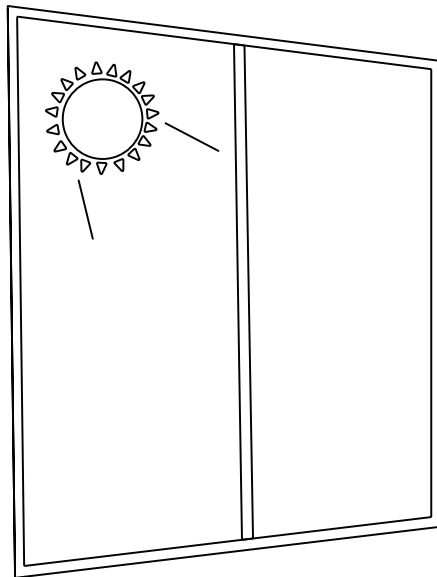
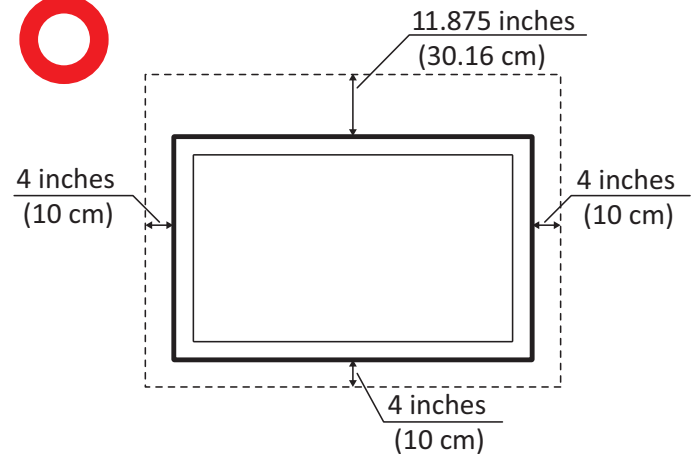
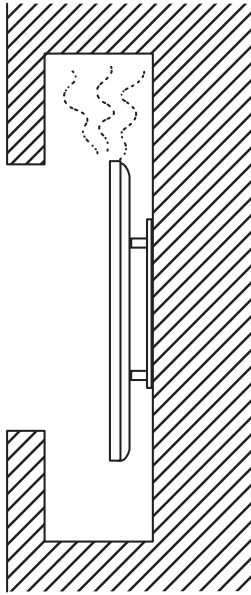

> Control Panel Overview

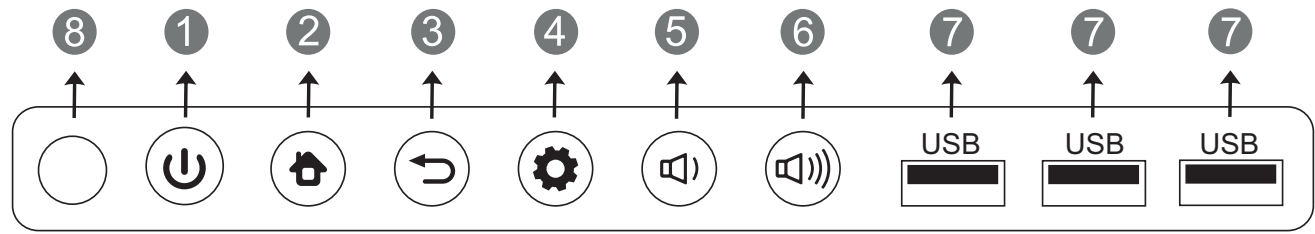

Item	Description
1	Press the key to turn on the device Press the key to turn off/on the display backlight only Press and hold the key to turn off the device
2	Back to Embedded player main interface
3	Return to Embedded player previous level
4	Call up function menu
5	Decrease volume
6	Increase volume
7	USB port for Embedded Player and internal PC
8	Receives signals from the remote control

> I/O port

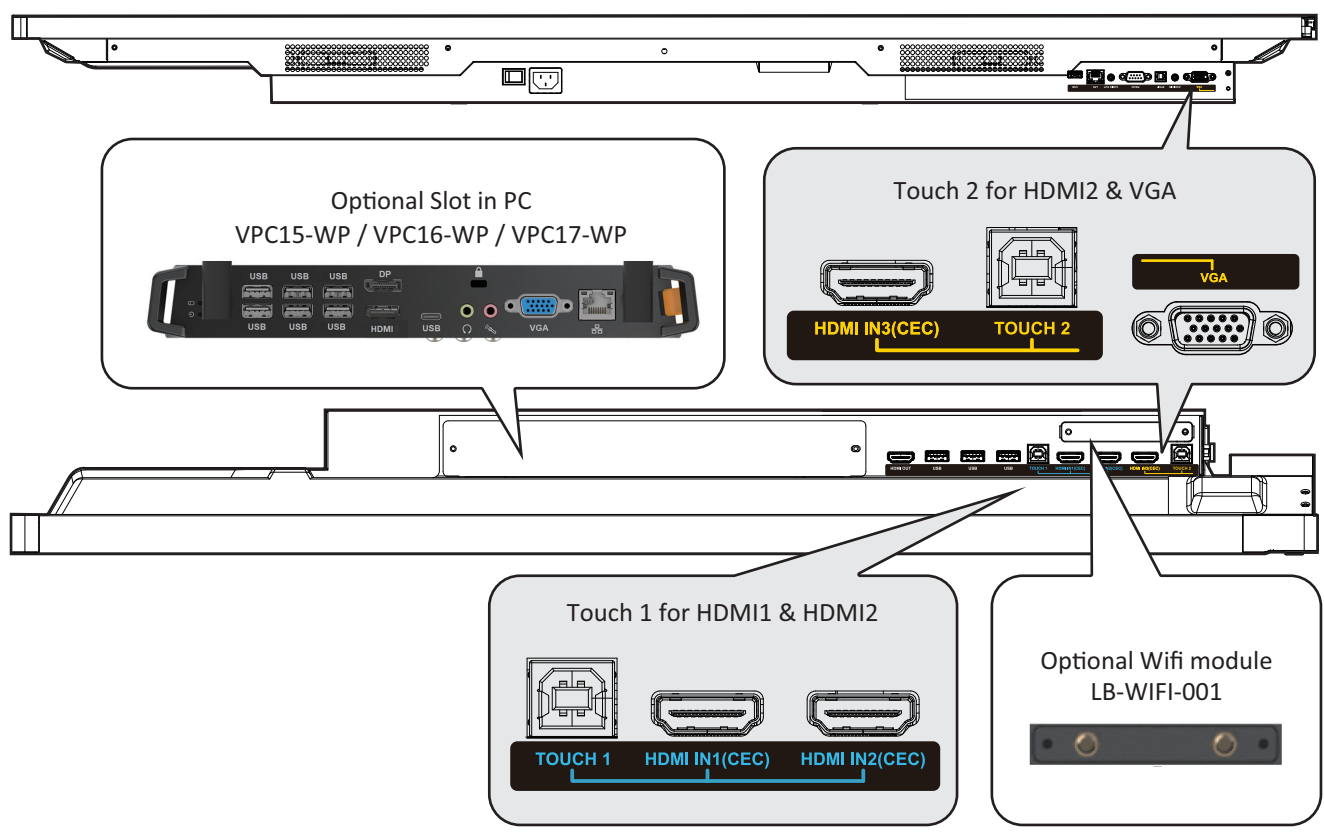

> Remote Control Overview

- 1 Press to turn the display ON/OFF
- 2 Mute / Unmute
- 3 **DISPLAY**
Display information of the current input source
- 4 **P.MODE**
Blank screen
- 5 **FREEZE**
Freeze screen
- 6 **Numeric button**
Numeric input button
- 7 **-/--/ALT+TAB**
Press to switch between PC applications
- 8 **0**
Numeric input button
- 9 / ALT+F4
Close current PC window
- 10 **INPUT**
Source selection button
- 11 **MENU**
Press to display Menu
- 12 **RED+ALT**
Screen capture
- 13 **GREEN+TAB**
PC 'Tab' button
- 14 **YELLOW+DESKTOP**
Switch to slot in PC desktop
- 15 **BLUE+BACKSPACE**
PC 'Backspace' button
- 16 **START / D. MENU**
PC 'Windows' button
- 17 / D.TITLE
PC 'Menu' button
- 18 Press to scroll up
- 19 Press to scroll left
- 20 Press to scroll right
- 21 Press to scroll down
- 22 **ENTER**
Enter button. Press it to select options.
- 23 / D. USB
Writing software startup
- 24 **ESC / EXIT / D. SETUP**
Shortcut button to exit dialog boxes
- 25 **EPG**
Back
- 26 **FAV / SPACE**
PC 'Space' button
- 27 **CH. + / CH. -**
CH+ : PC previous page
CH- : PC next page
- 28 **VOL+ / VOL-**
Increase / Decrease volume
- 29 **F1**
Windows F1 Function
- 30 **F2**
Windows F2 Function
- 31 **F3**
Windows F3 Function
- 32 **F4**
Windows F4 Function
- 33 **F5**
Windows F5 Function
- 34 **F6**
Windows F6 Function
- 35 **F7**
Windows F7 Function
- 36 **F8**
Windows F8 Function
- 37 **F9**
Windows F9 Function
- 38 **F10**
Windows F10 Function
- 39 **F11**
Windows F11 Function
- 40 **F12**
Windows F12 Function

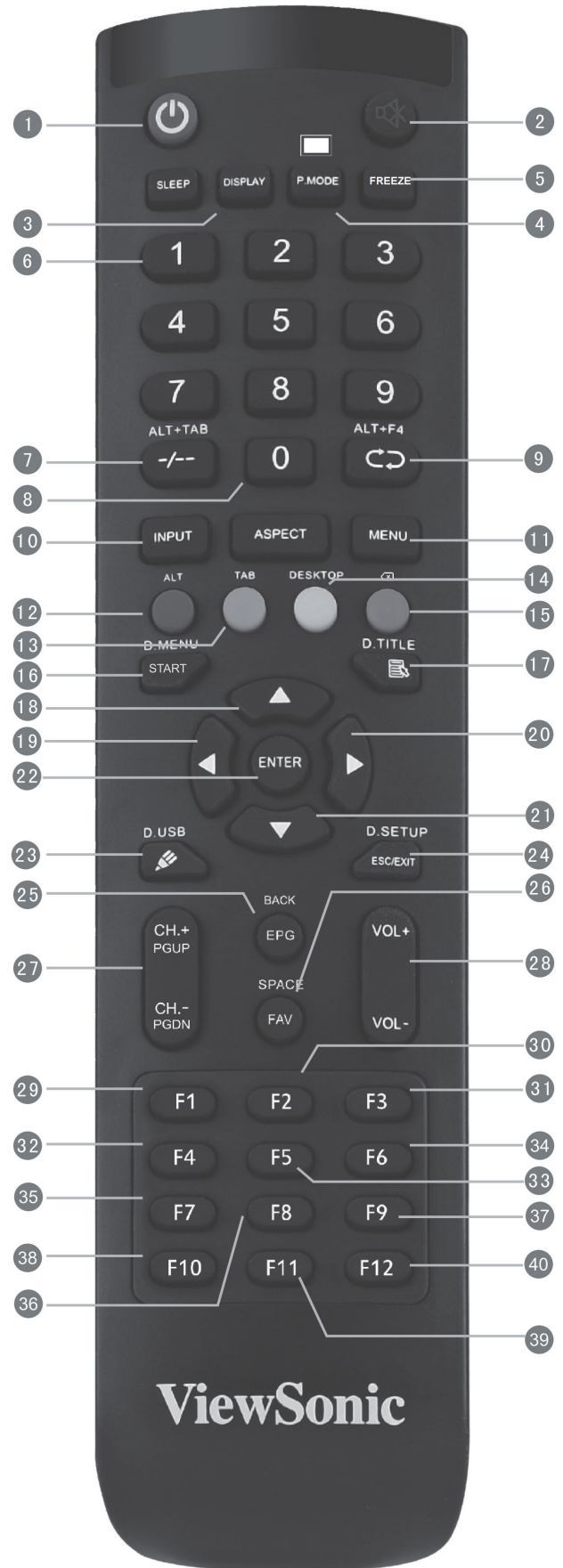

> Connecting an External PC

- To display video and sound from an external PC follow the instructions below:

Note: External PCs can also be connected to the display via HDMI cable.

 - Connect a VGA cable (15-pin) from your external PC to the VGA IN port on the display.
 - Connect an audio cable from the AUDIO OUT port on your external PC to the AUDIO IN port on the display.
- Connect a USB cable to the external PC from the TOUCH OUT port of the display.

Note: For optimal results, select 1920x1080p as the external computer's input resolution.

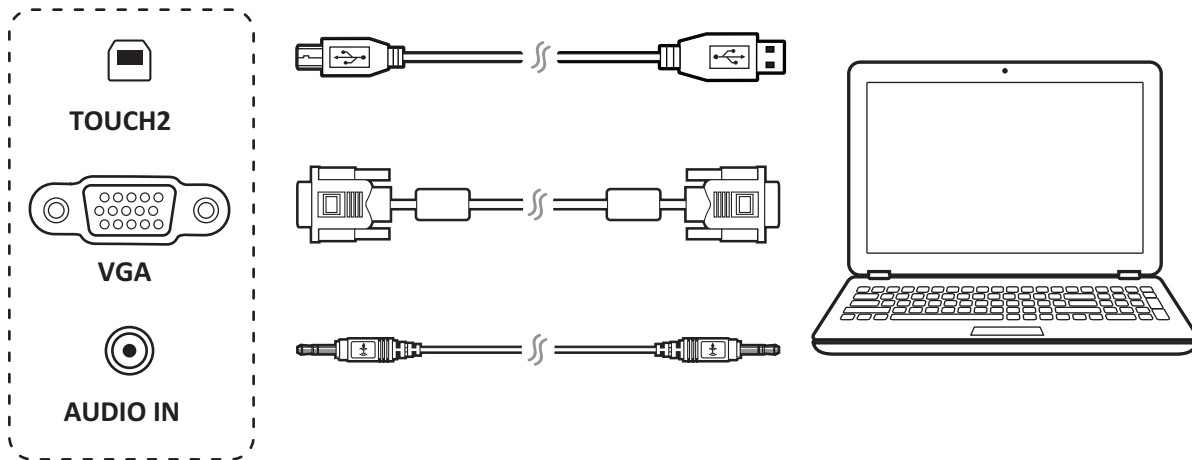

> RS232 Connections

When you use an RS232 serial port cable to connect your display to an external computer, certain functions can be controlled by the PC, including power on/off, volume adjustment and more.

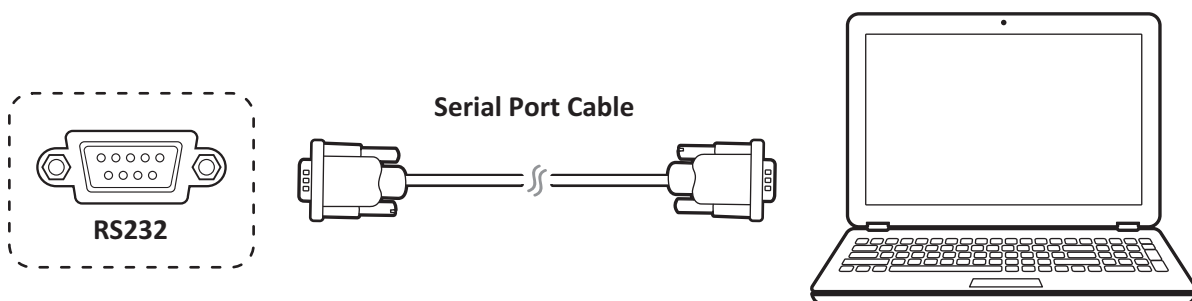

> Connecting USB Peripherals

1. USB Peripherals: Plug the USB device cable into the USB IN port.
2. Networking and modem cables: Plug the router cable into the LAN IN port.
3. Microphone: Plug the microphone cable into the MIC port.

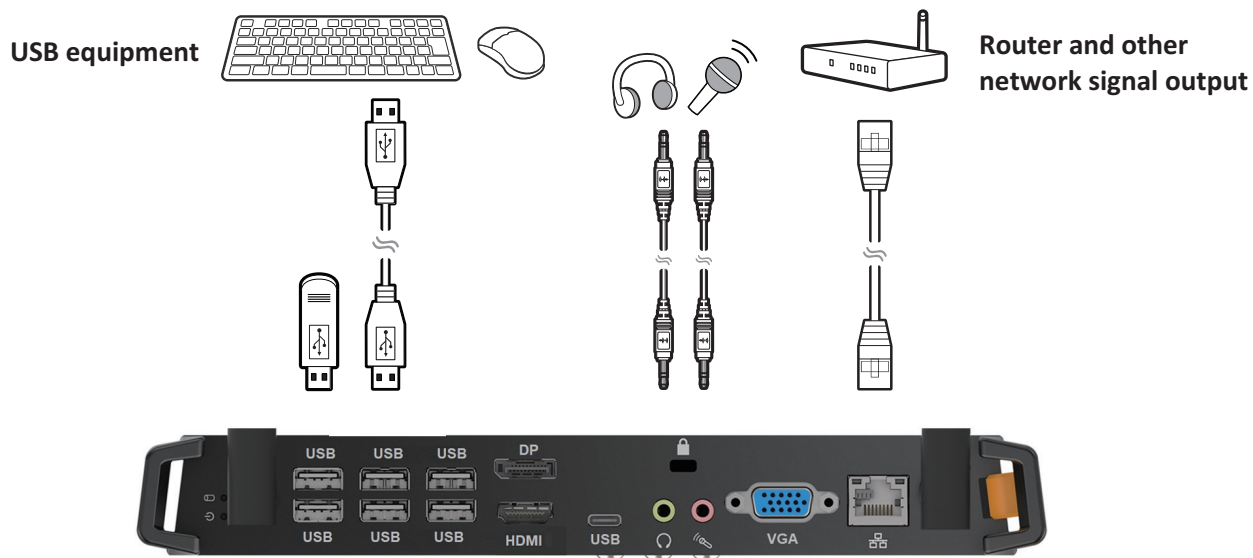

> HDMI Connections

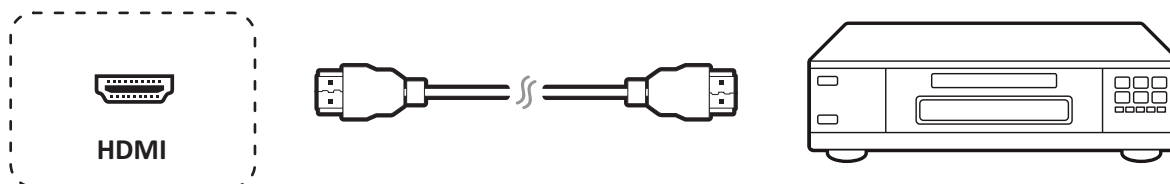

> Start to Use

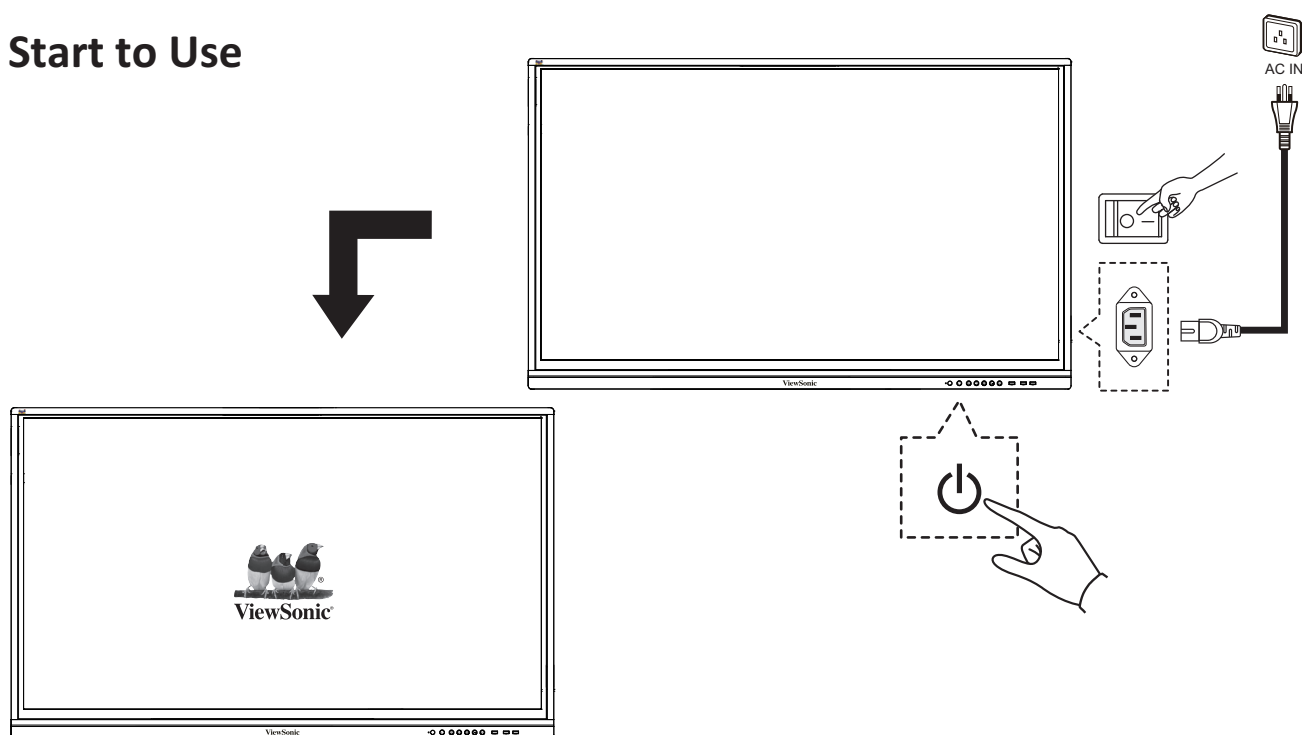



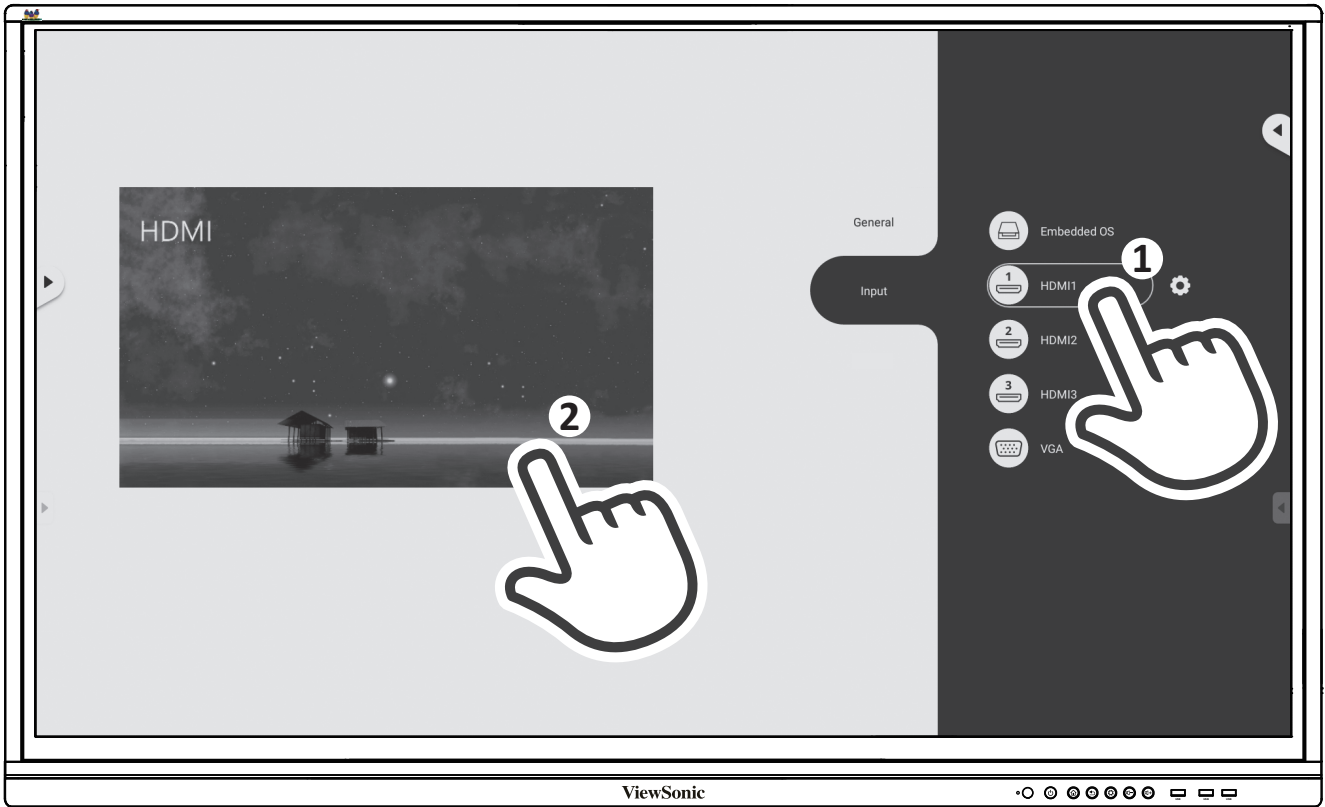
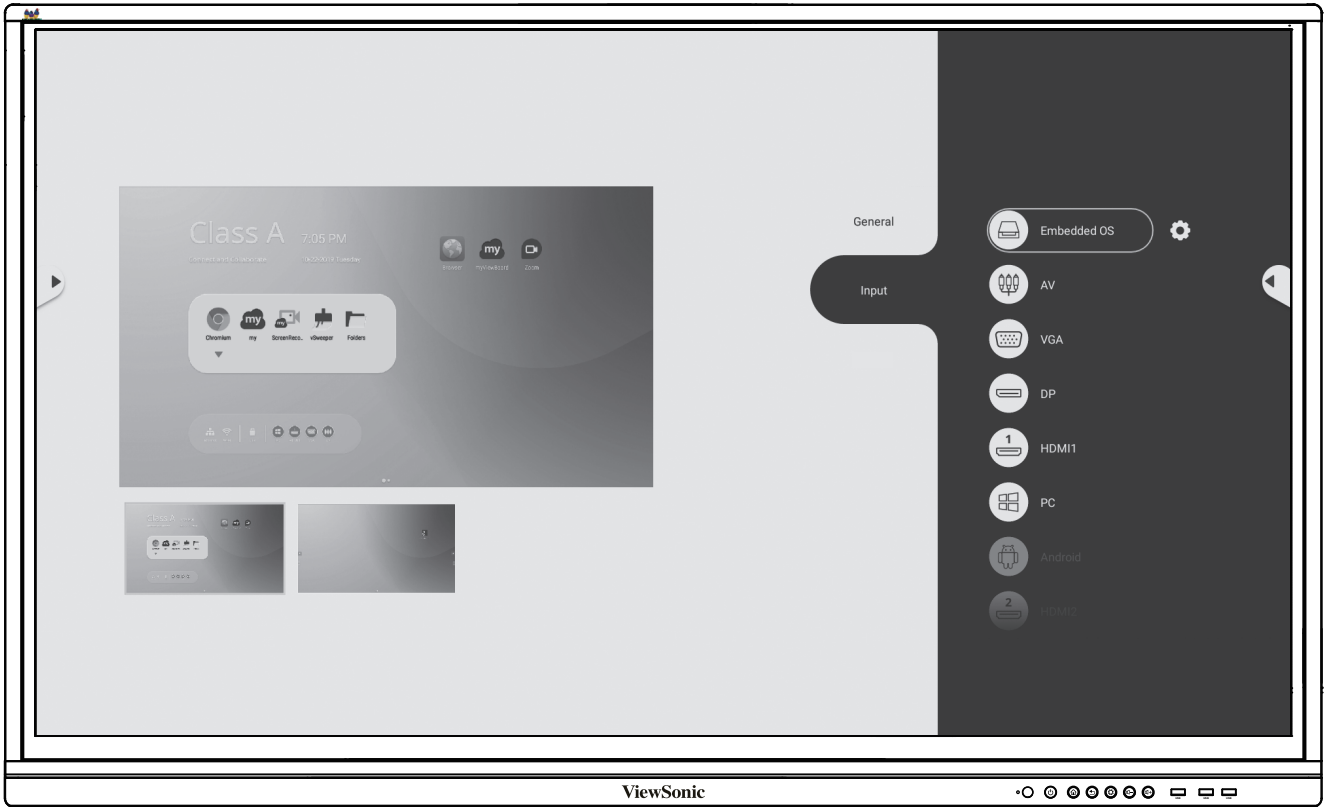

> Compliance Statement

FCC Compliance Statement: This device complies with part 15 of FCC Rules. Operation is subject to the following two conditions: (1) this device may not cause harmful interference, and (2) this device must accept any interference received, including interference that may cause undesired operation.

Industry Canada ICES-003 Compliance: CAN ICES-3 (B)/NMB-3(B)



ViewSonic Corporation (US/Canada/Latin America)

 : www.viewsonic.com/support/product-registration



United States

 1-800-688-6688

 customerservice@viewsonic.com

Canada

 1-866-463-4775

 customerservice@viewsonic.com

Puerto Rico & Virgin Islands

 <http://www.viewsonic.com/la/soporte/servicio-tecnico> (Español)

Latin America

 <http://www.viewsonic.com/la/soporte/servicio-tecnico-la/>



ViewSonic Support Center



Optional Accessory

> Pakkens indhold

- Strømkabel (leveres i henhold til region)
- Fjernbetjening
- AAA-batterier x 2
- USB-kabel
- Touch-pen
- Startvejledning
- RS232-adapter
- Klemme x 5
- Kameraplade
- Skrue
- Signalkabel, der er kompatibelt med HDMI

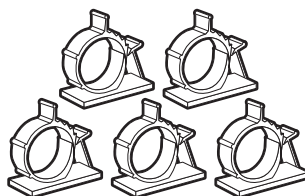
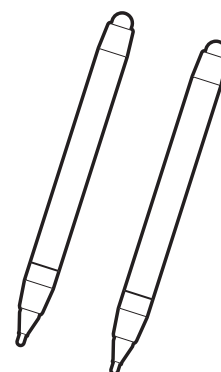
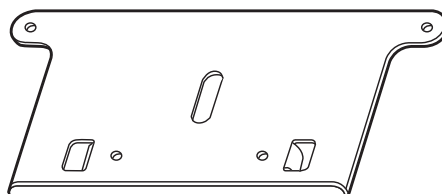
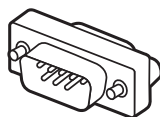
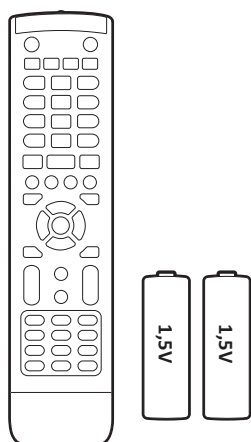
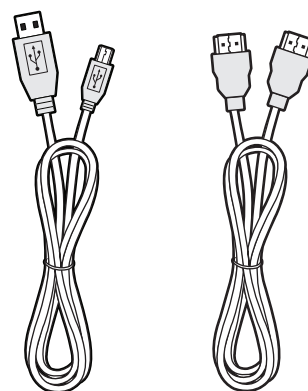
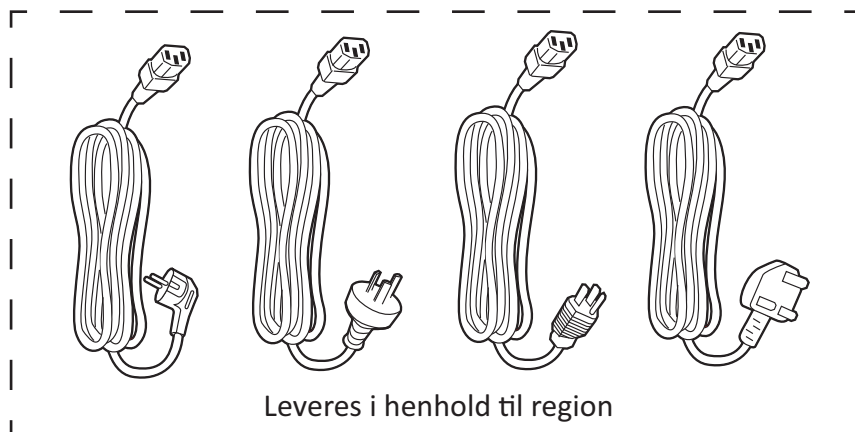

➤ Specifikationer til vægophænget (VESA)

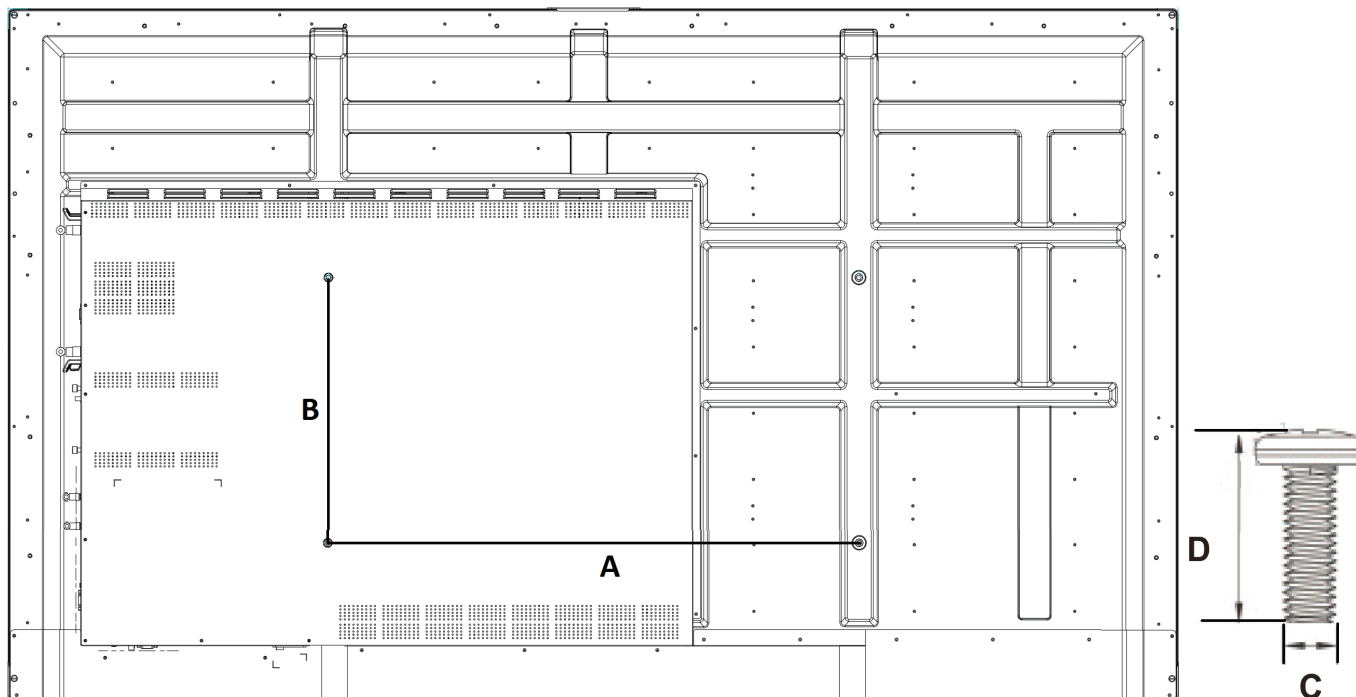

tommer	VESA-spec. (A x B)	Standardskrue (C x D)	Antal
IFP5550 - 55"	400 x 200 mm	M8 x 25 mm	4
IFP6550 - 65"	600 x 400 mm	M8 x 25 mm	4
IFP7550 - 75"	800 x 400 mm	M8 x 25 mm	4
IFP8650 - 86"	800 x 600 mm	M8 x 25 mm	4

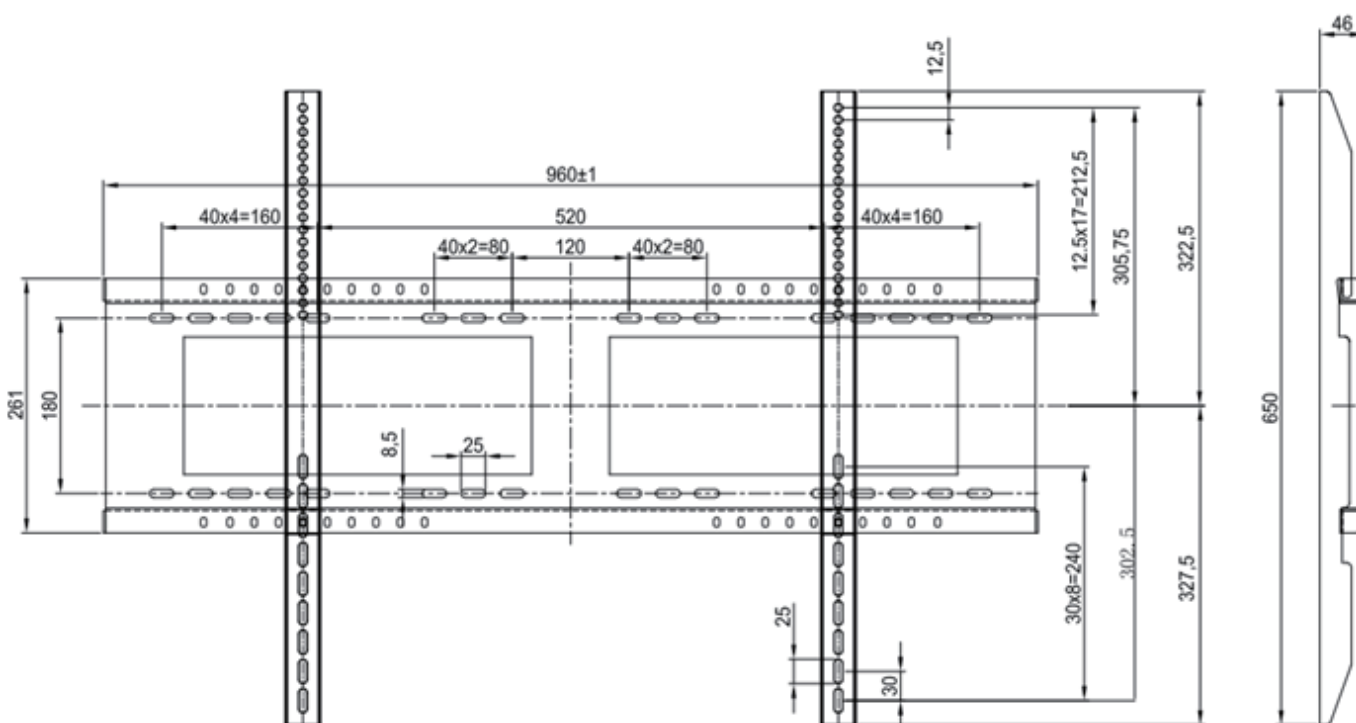

> Miljømæssige oplysninger vedrørende installeringen

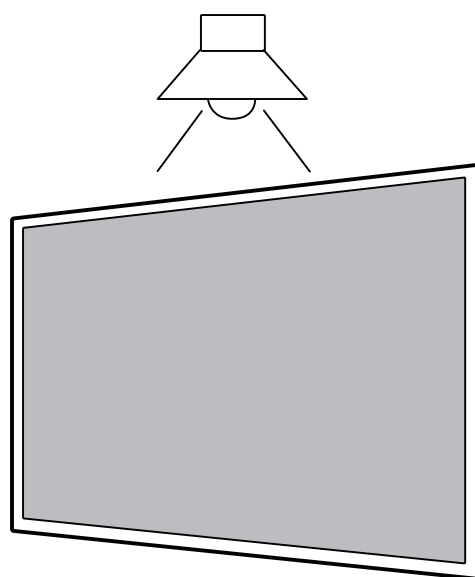
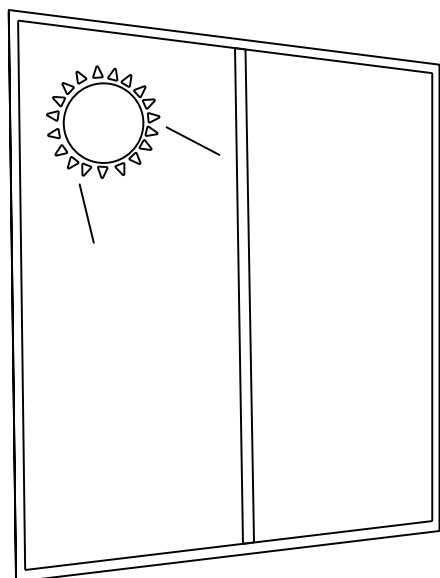
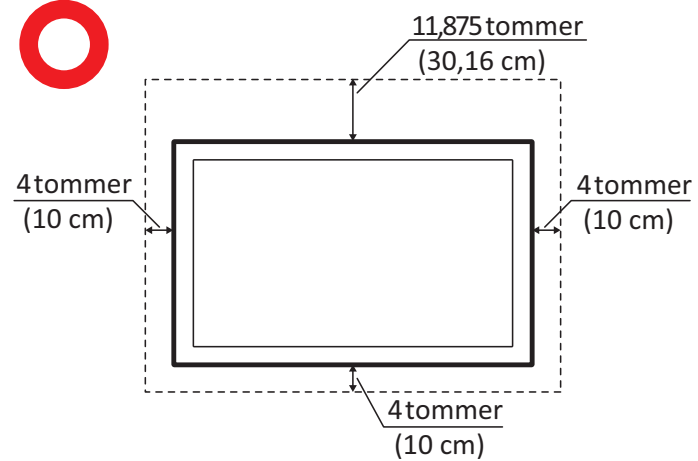
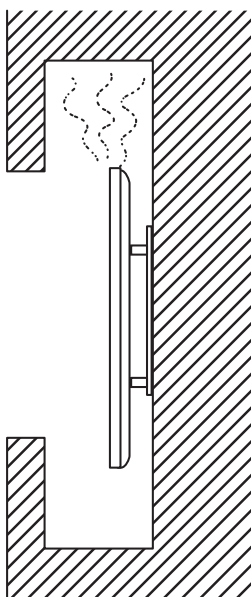

> Oversigt over betjeningspanelet

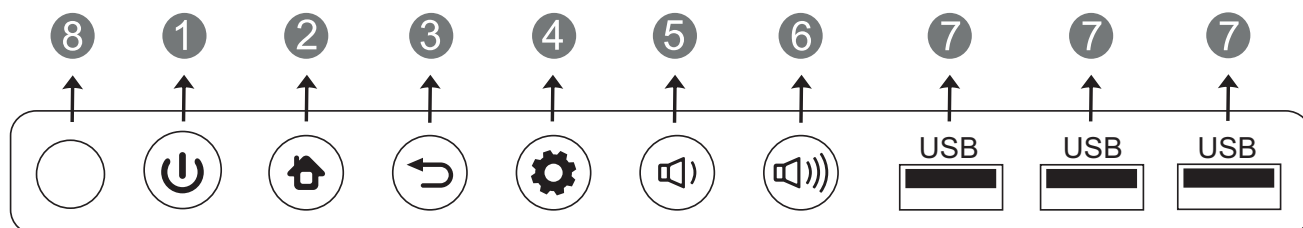

Punkt	Beskrivelse
1	Tryk på knappen for, at tænde enheden Tryk på knappen for kun at slukke/tænde skærmens baggrundsls Hold knappen nede, for at slukke enheden
2	Tilbage til indlejret afspiller på hovedgrænseflade
3	Gå tilbage til forrige niveau i den indlejrede afspiller
4	Opkaldsmenu
5	Skru ned for lydstyrken
6	Skru op for lydstyrken
7	USB-port til indlejret afspiller og intern pc
8	Modtager signaler fra fjernbetjeningen

> I/O-port

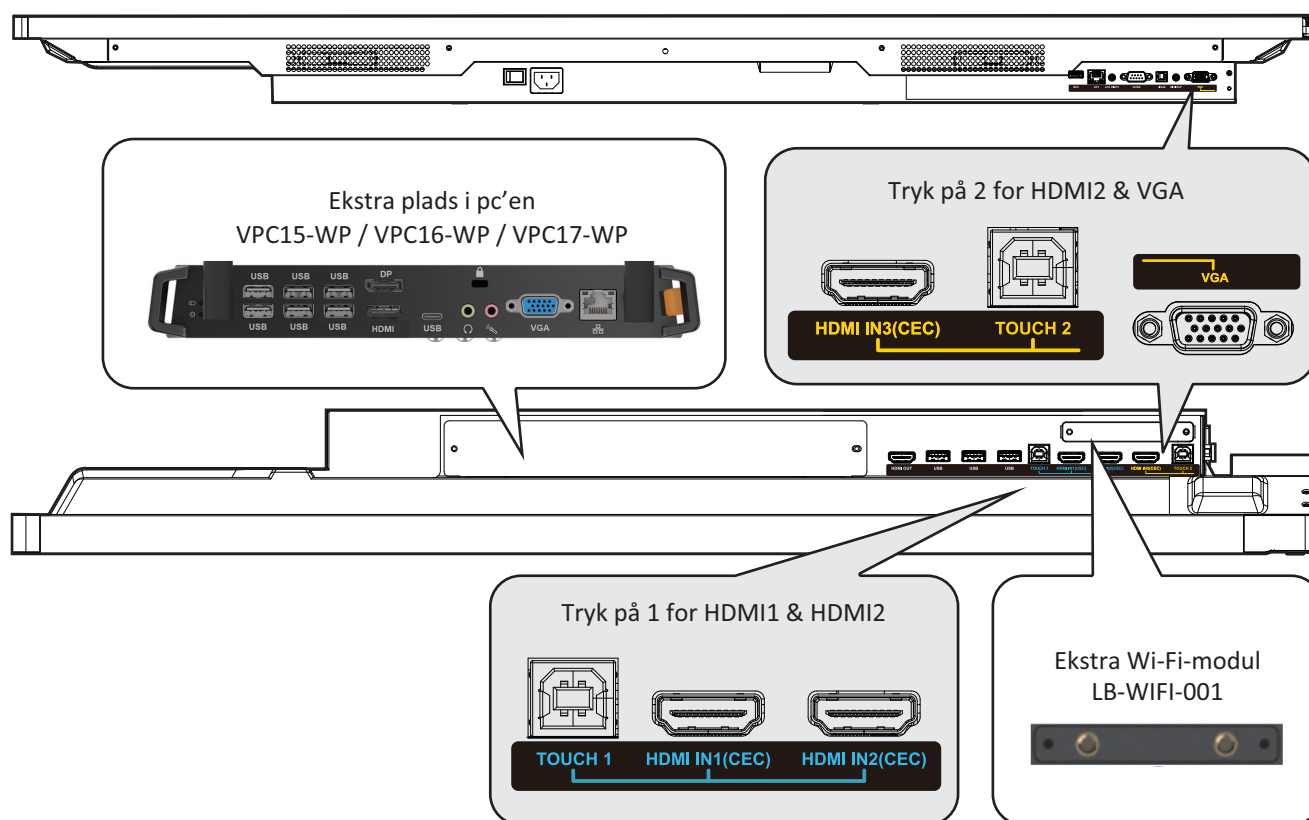

➤ Oversigt over fjernbetjeningen

1 

Trykkes, for at tænde/slukke skærmen

2 

Slå lyden til og fra

3 DISPLAY

Vis oplysninger om den aktuelle indgangskilde

4 P.MODE

Blank skærm

5 FREEZE

Sæt skærm på pause

6 Numeric button

Taltaster

7 - / -- / ALT+TAB

Trykkes, for at skifte mellem pc-programmerne

8 0

Taltaster

9  / ALT+F4

Luk det aktuelle pc-vindue

10 INPUT

Knap til valg af kilde

11 MENU

Trykkes, for at se menuen

12 RED+ALT

Skærmoptagelse

13 GREEN+TAB

Knap, der virker som tasten 'Tab' på en pc

14 YELLOW+DESKTOP

Skift til pladsen på pc-skrivebordet

15 BLUE+BACKSPACE

Knap, der virker som tasten 'Tilbage' på en pc

16 START / D. MENU

Knap, der virker som tasten 'Windows' på en pc

17  / D.TITLE

Knap, der virker som tasten 'Menu' på en pc

18 

Trykkes, for at rulle op

19 

Trykkes, for at rulle til venstre

20 

Trykkes, for at rulle til højre

21 

Trykkes, for at rulle ned

22 ENTER

Enter-tast Trykkes, for at vælge et punkt.

23  / D. USB

Skrivning af software-opstart

24 ESC / EXIT / D. SETUP

Genvejsknap for at afslutning af dialogboks

25 EPG

Tilbage

26 FAV / SPACE

Knap, der virker som tasten 'Mellemrum' på en pc

27 CH. + / CH. -

Kanal+ : Forrige side på en pc
Kanal- : Næste side på en pc

28 VOL+ / VOL-

Skru op/ned for lydstyrken

29 F1

Windows F1-funktion

30 F2

Windows F2-funktion

31 F3

Windows F3-funktion

32 F4

Windows F4-funktion

33 F5

Windows F5-funktion

34 F6

Windows F6-funktion

35 F7

Windows F7-funktion

36 F8

Windows F8-funktion

37 F9

Windows F9-funktion

38 F10

Windows F10-funktion

39 F11

Windows F11-funktion

40 F12

Windows F12-funktion

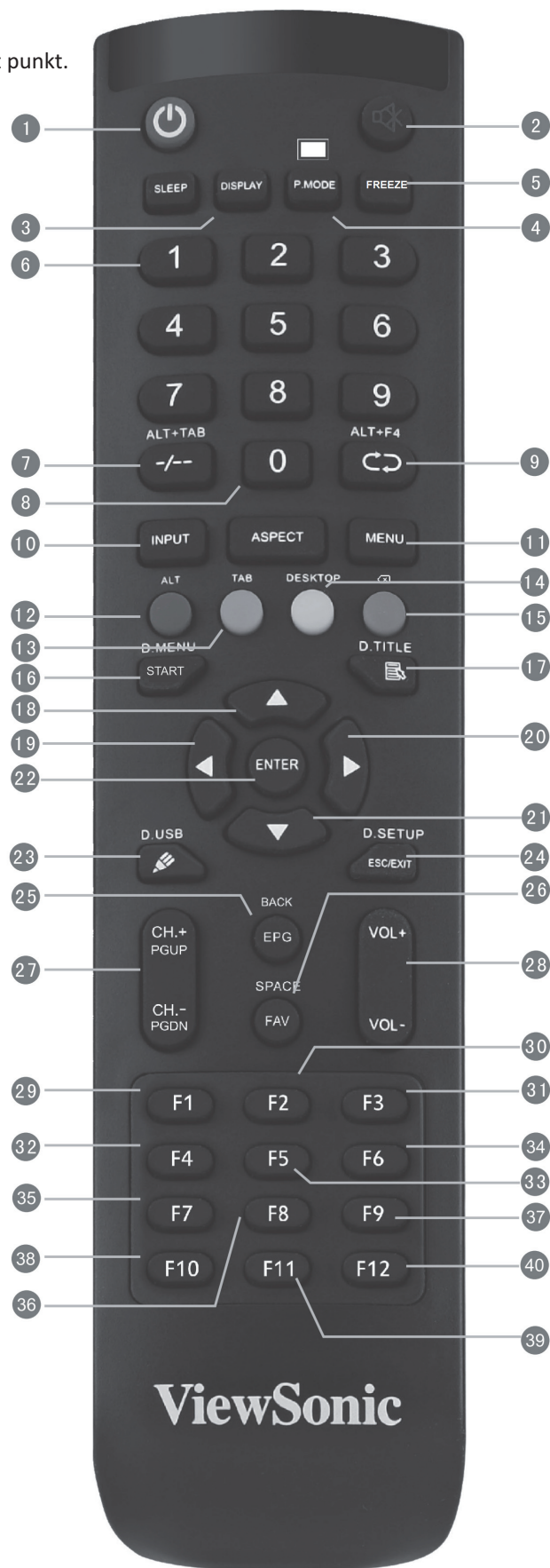

> Tilslutning af en ekstern pc

1. Følg nedenstående vejledning for at vise video og lyd fra en ekstern pc:

Bemærk: Det er også muligt, at tilslutte en ekstern pc til skærmen med et HDMI-kabel.

- Tilslut et VGA-kabel (15 stikben) fra din eksterne pc til VGA-indgangsstikket på skærmen.
- Tilslut et lyd kabel fra lydudgangsstikket på din eksterne pc til lydindgangsstikket på skærmen.

2. Tilslut et USB-kabel til den eksterne pc fra TOUCH OUT-porten på skærmen.

Bemærk: For at opnå et optimalt resultat, skal du vælge 1920 x 1080p som opløsning på den eksterne computer.

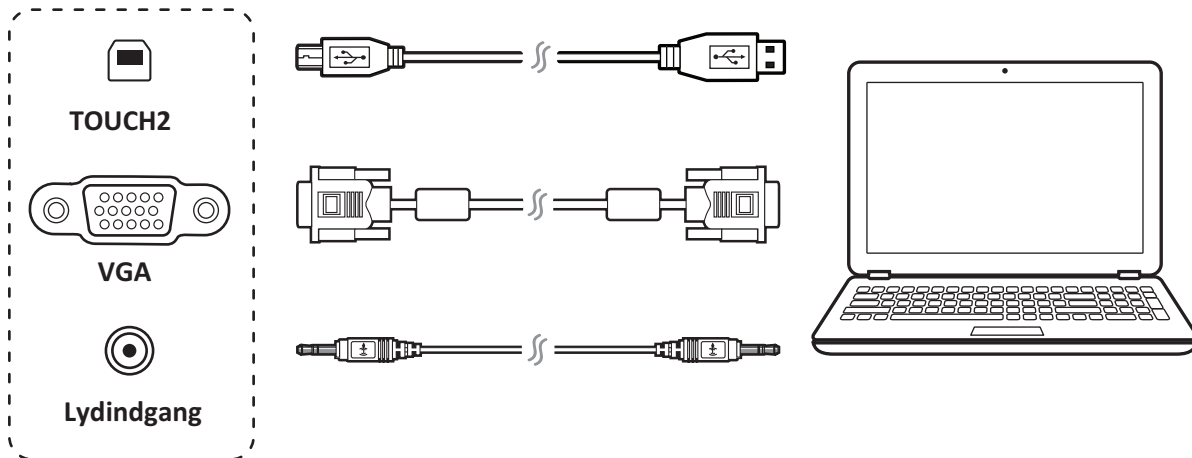

> RS232-tilslutninger

Når du bruger et RS232 serielt portkabel til at forbinde din skærm til en ekstern computer, kan nogle af funktionerne styres på pc'en. Det er funktioner som tænd/sluk, lydstyrkejustering og mere.

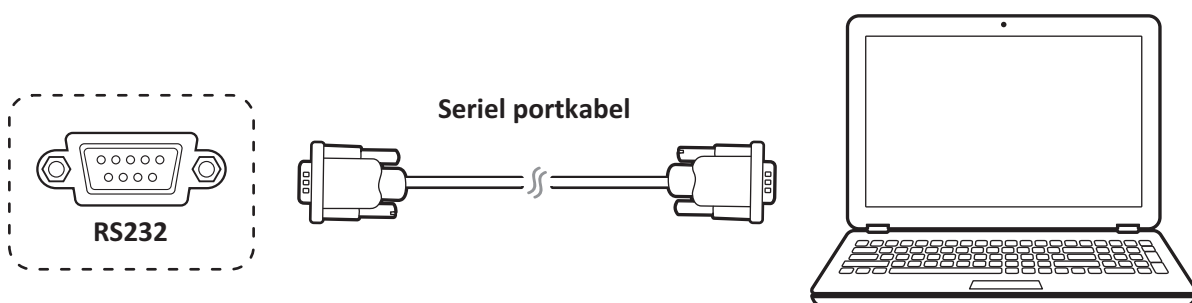

> Tilslutning til eksterne USB-enheder

1. Eksterne USB-enheder: Slut kablet fra USB-enheten til USB IN-porten.
2. Netværks- og modemkabler: Slut routerkablet til LAN IN-porten.
3. Mikrofon: Slut mikrofonkablet til mikrofonstikket.

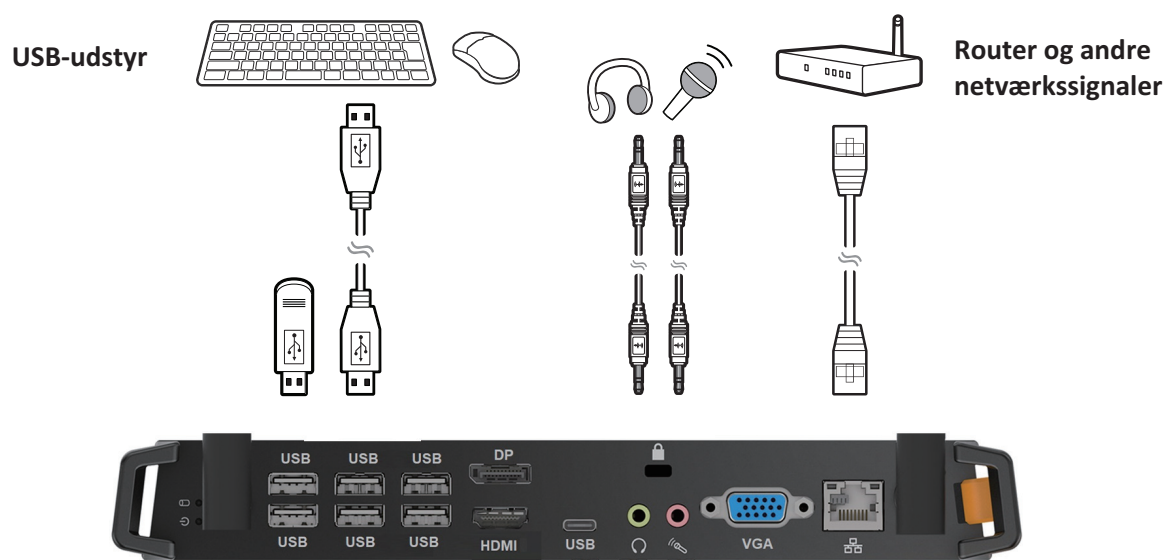

> HDMI-tilslutninger

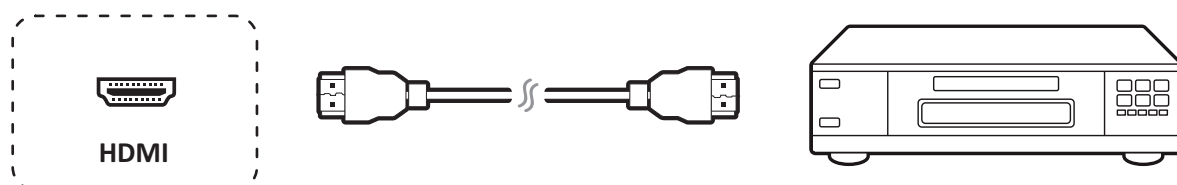

> Sådan kommer du i gang

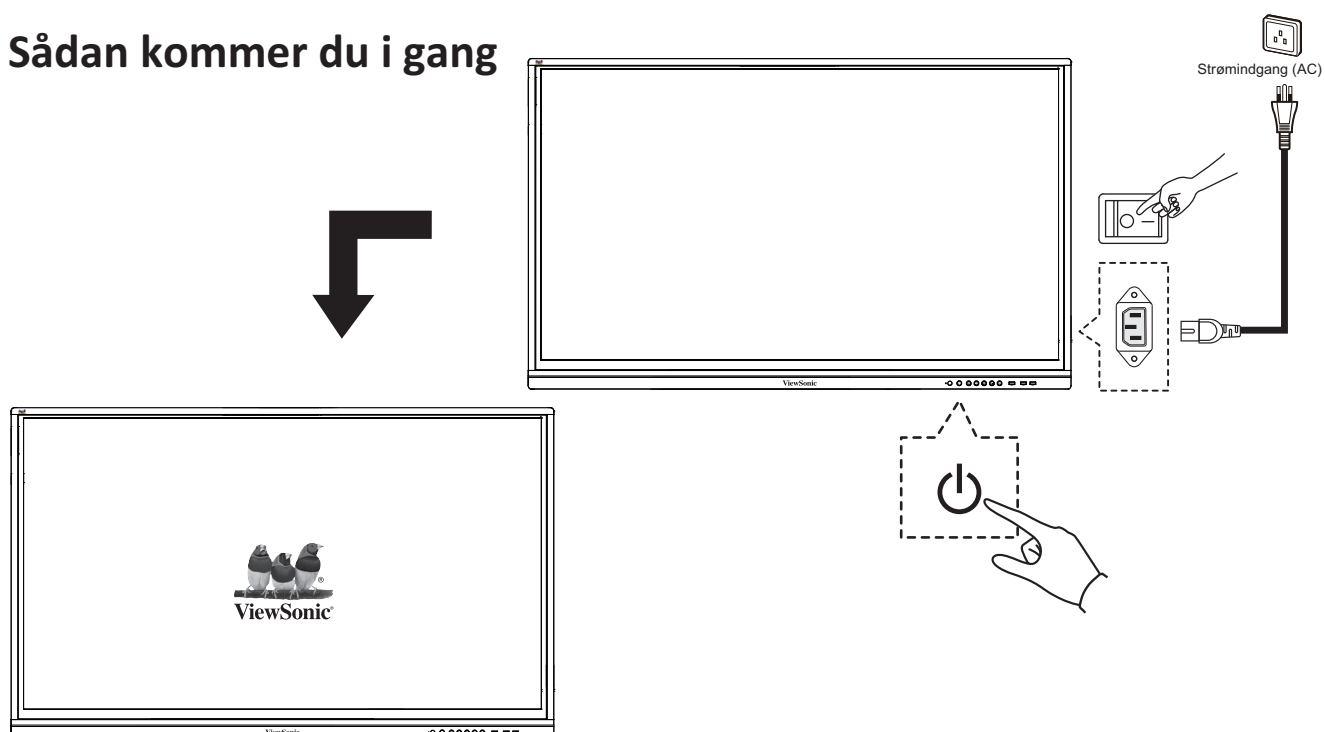



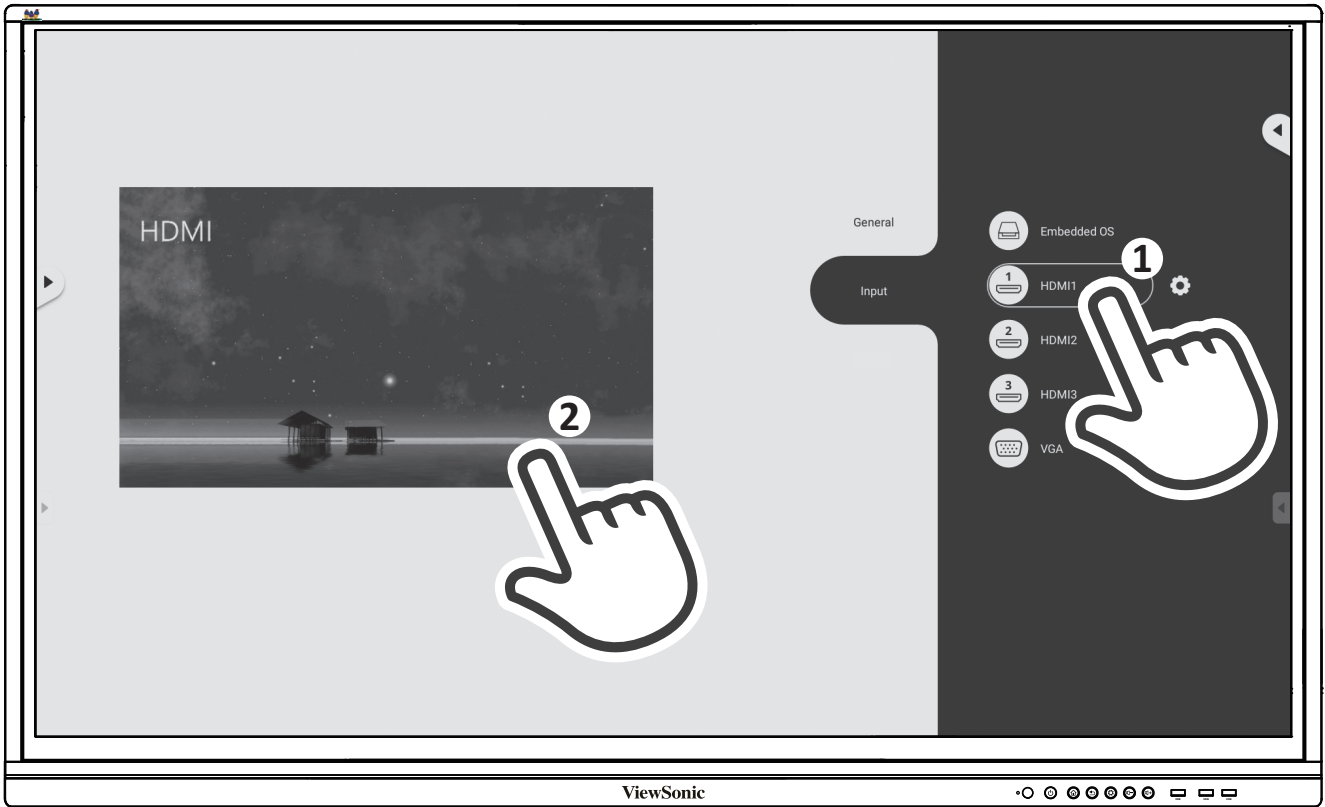
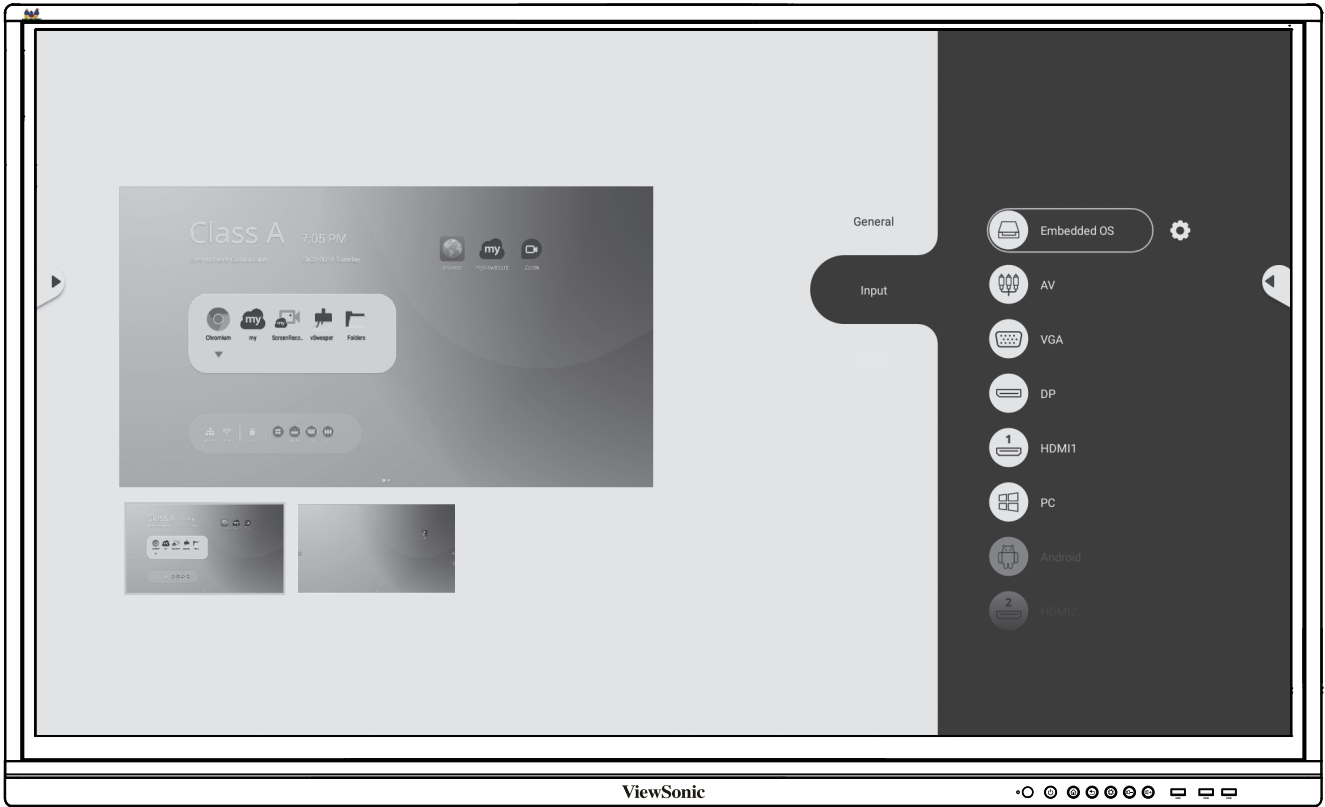

> Overensstemmelseserklæring

Overensstemmelseserklæring fra FCC: Denne enhed overholder stk. 15 i FCC-reglerne. Driften er underlagt følgende to betingelser: (1) Denne enhed må ikke forårsage skadelig interferens, og (2) denne enhed skal acceptere enhver modtaget interferens, herunder interferens, der kan forårsage uønsket drift.

Overholdelse af reglerne fra Industry Canada ICES-003: CAN ICES-3 (B)/NMB-3(B)



ViewSonic Corporation (US/Canada/Sydamerika)

 : www.viewsonic.com/support/product-registration



USA

 1-800-688-6688

 customerservice@viewsonic.com

Canada

 1-866-463-4775

 customerservice@viewsonic.com

Puerto Rico og Jomfruøerne

 <http://www.viewsonic.com/la/soporte/servicio-tecnico> (Español)

Sydamerika

 <http://www.viewsonic.com/la/soporte/servicio-tecnico-la/>



ViewSonic supportcenter



Ekstra tilbehør

➤ Inhoud van verpakking

- Stroomkabel (verzenden per regio)
- Afstandsbediening
- AAA-batterij x 2
- USB-kabel
- Aanraakpen
- Snelstartgids
- RS232-adapter
- Klem x 5
- Cameraplaat
- Schroef
- Signaalkabel compatibel met HDMI

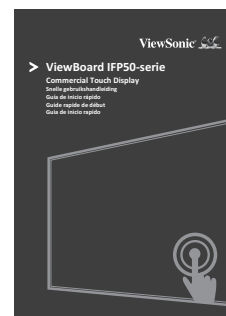
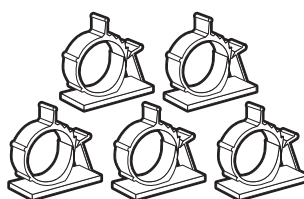
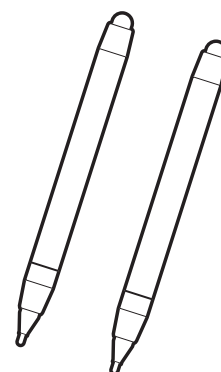
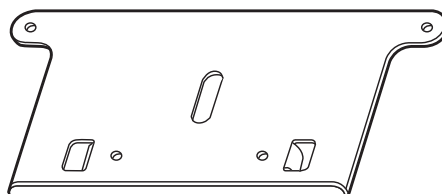
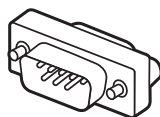
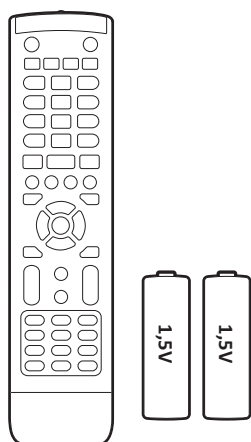
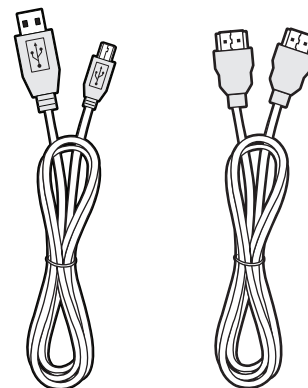
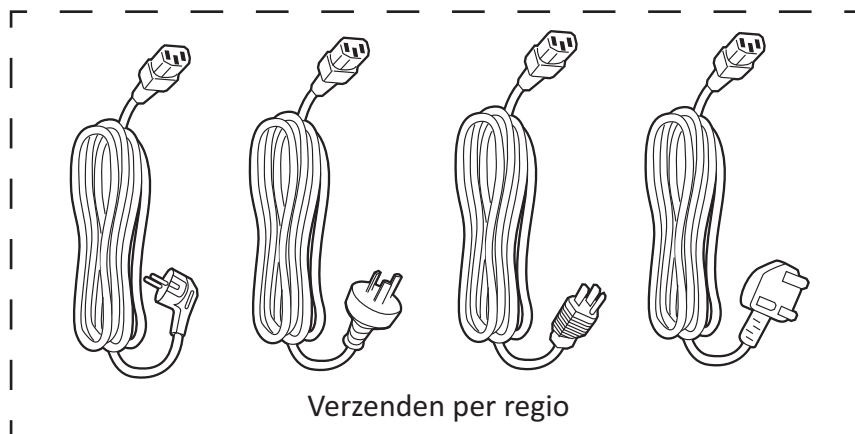

➤ Specificaties voor het monteren aan de muur (VESA)

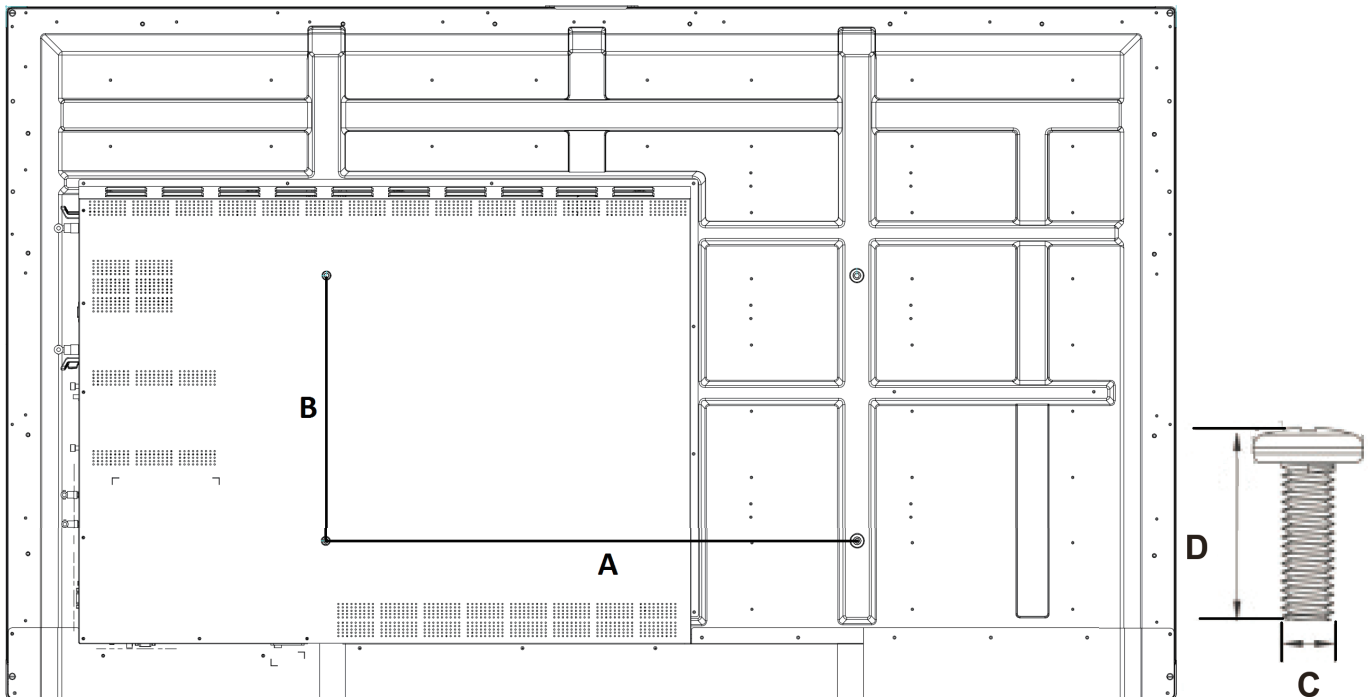

inch	VESA Spec. (A x B)	Standaardschroef (C x D)	Hoeveelheid
IFP5550 - 55"	400 x 200 mm	M8 x 25 mm	4
IFP6550 - 65"	600 x 400 mm	M8 x 25 mm	4
IFP7550 - 75"	800 x 400 mm	M8 x 25 mm	4
IFP8650 - 86"	800 x 600 mm	M8 x 25 mm	4

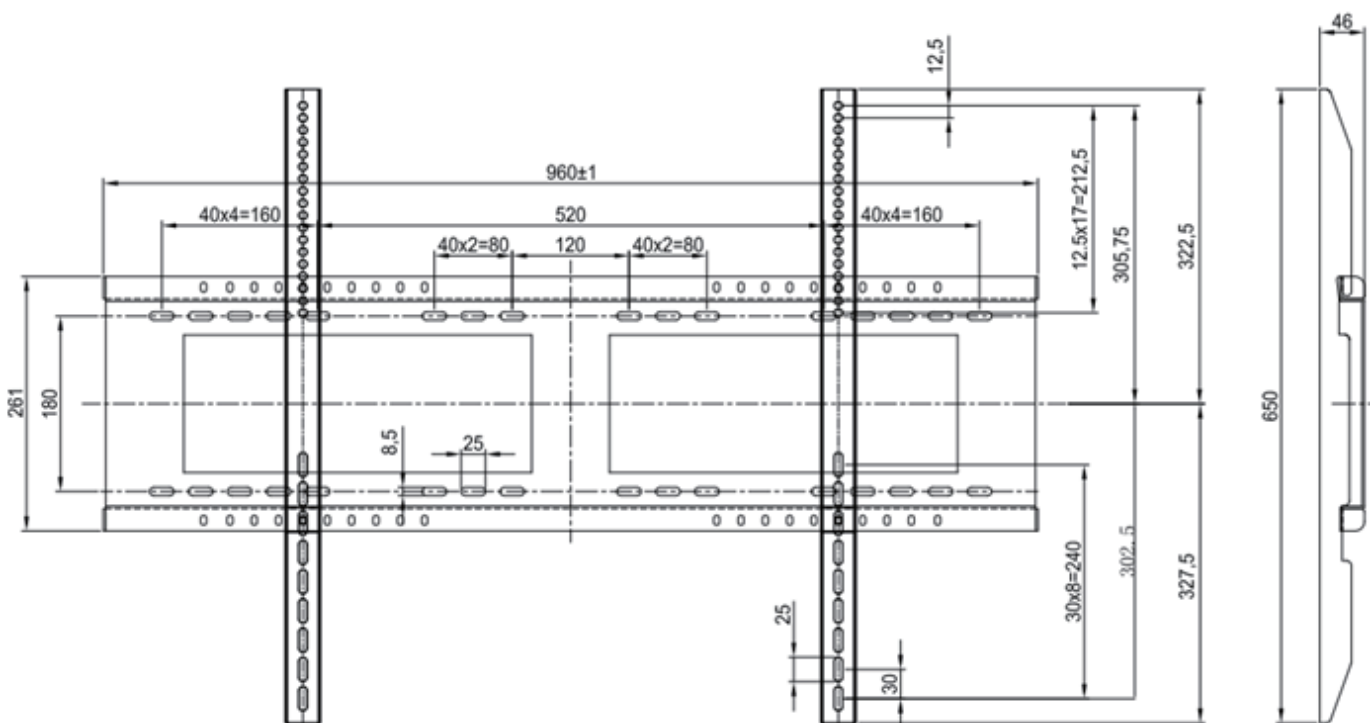

> Aandacht voor installatie-omgeving

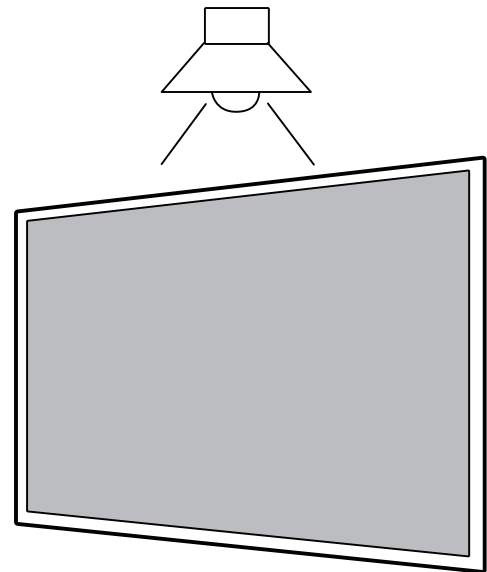
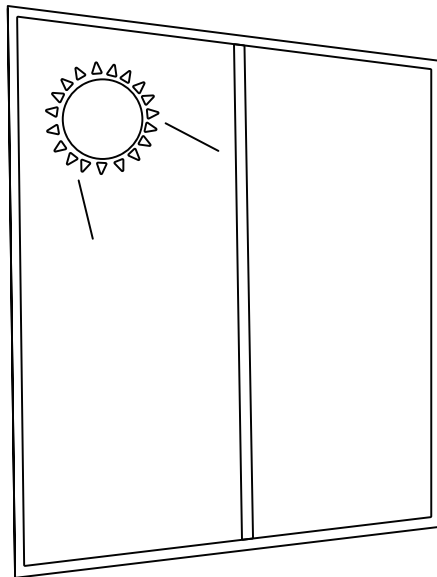
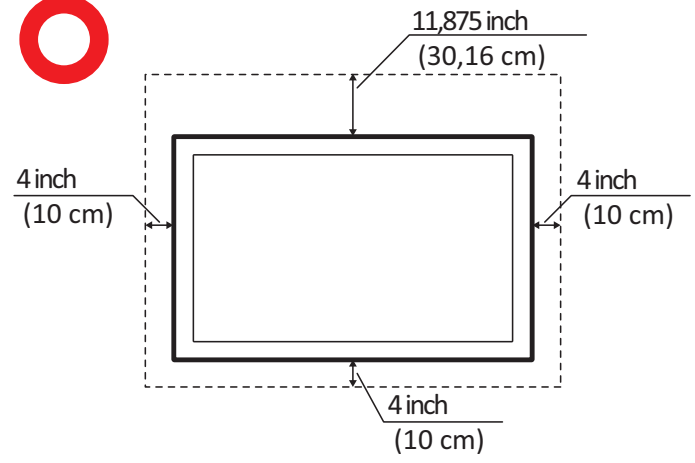
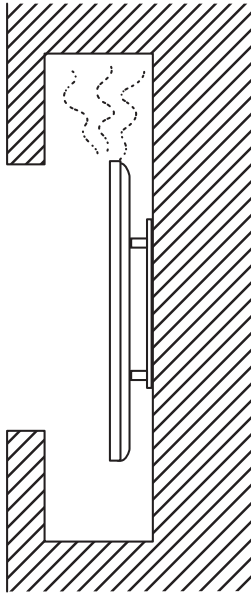

> Overzicht bedieningspaneel

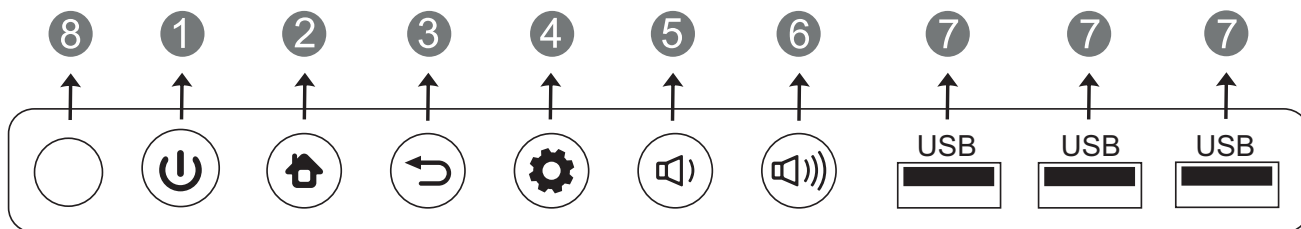

Item	Omschrijving
1	Druk op de knop om het apparaat in te schakelen Druk op de knop om alleen de achtergrondverlichting van het display uit/in te schakelen Druk op de knop en blijf drukken om het apparaat uit te schakelen
2	Terug naar hoofdinterface van ingebedde speler
3	Terug naar vorige niveau van ingebedde speler
4	Funciemenu oproepen
5	Volume zachter zetten
6	Volume harder zetten
7	USB-poort voor ingebouwde speler en interne PC
8	Ontvangt signalen van de afstandsbediening

> I/O-poort

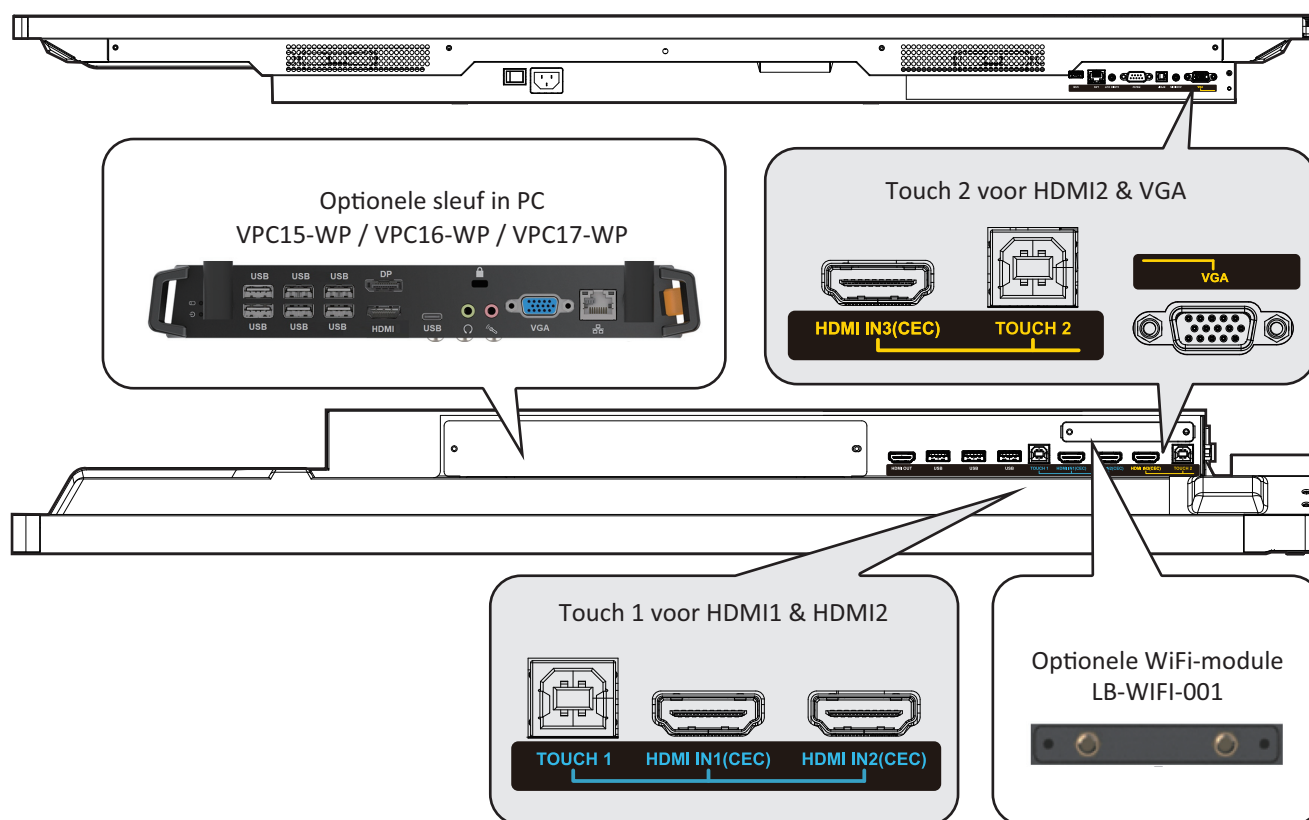

> Overzicht afstandsbediening

- 1 Druk hierop om de display AAN/UIT te zetten
- 2 Dempen / Dempen ongedaan maken
- 3 **DISPLAY** Geef informatie weer van de huidige invoerbron
- 4 **P.MODE** Leeg scherm
- 5 **FREEZE** Scherm pauzeren
- 6 **Numeric button** Numerieke invoerknop
- 7 **-/--/ALT+TAB** Druk om te schakelen tussen PC-toepassingen
- 8 **0** Numerieke invoerknop
- 9 Huidige PC-venster sluiten
- 10 **INPUT** Bronselectieknop
- 11 **MENU** Druk om menu weer te geven
- 12 **RED+ALT** Scherm vastleggen
- 13 **GREEN+TAB** 'Tabblad'-knop PC
- 14 **YELLOW+DESKTOP** Schakel over naar sleuf in PC-desktop
- 15 **BLUE+BACKSPACE** 'Backspace'-knop PC
- 16 **START / D. MENU** 'Windows'-knop PC
- 17 'Menu'-knop PC
- 18 Druk om omhoog te scrollen
- 19 Druk om naar links te scrollen
- 20 Druk om naar rechts te scrollen
- 21 Druk om omlaag te scrollen
- 22 **ENTER** Enter-knop. Druk erop om opties te selecteren.
- 23 Opstarten schrijfsoftware
- 24 **ESC / EXIT / D. SETUP** Snelkoppelingsknop voor afsluiten dialoogvensters
- 25 **EPG** Terug
- 26 **FAV / SPACE** 'Spatie'-knop PC
- 27 **CH. + / CH. -** CH+ : Vorige pagina PC
CH- : Volgende pagina PC
- 28 **VOL+ / VOL-** Volume hoger/lager
- 29 **F1** Windows F1-functie
- 30 **F2** Windows F2-functie
- 31 **F3** Windows F3-functie
- 32 **F4** Windows F4-functie
- 33 **F5** Windows F5-functie
- 34 **F6** Windows F6-functie
- 35 **F7** Windows F7-functie
- 36 **F8** Windows F8-functie
- 37 **F9** Windows F9-functie
- 38 **F10** Windows F10-functie
- 39 **F11** Windows F11-functie
- 40 **F12** Windows F12-functie

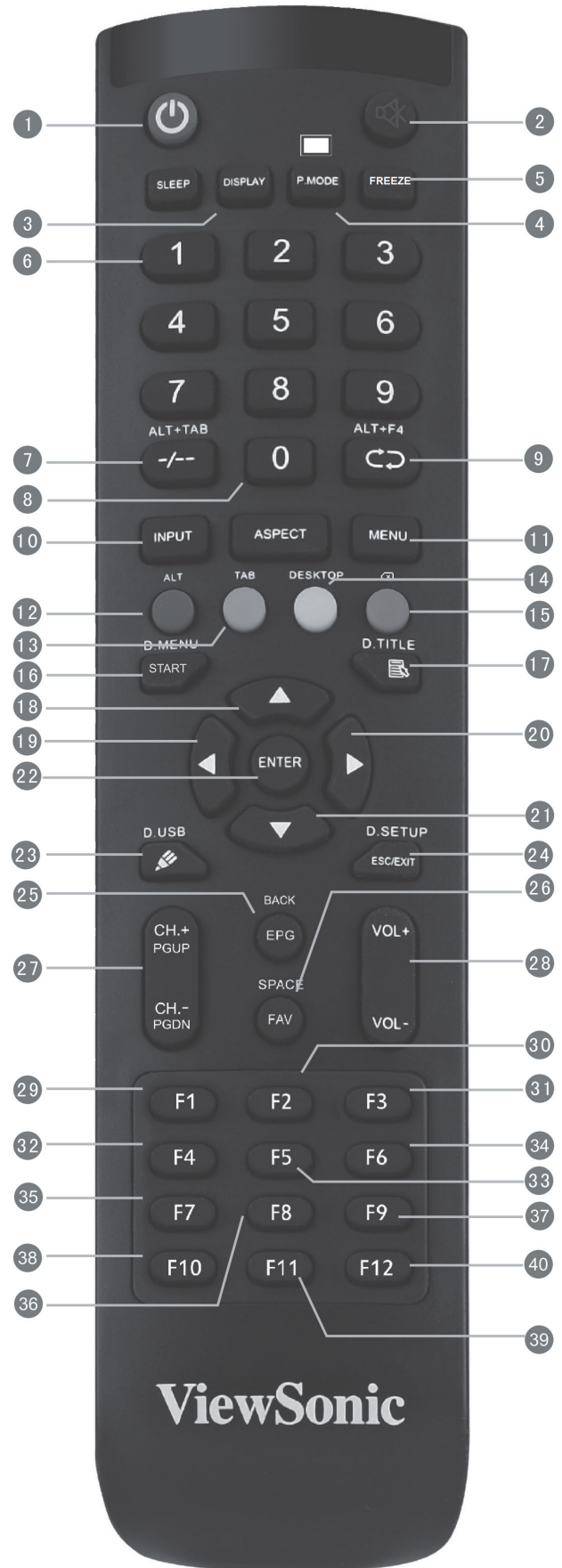

> Een externe PC aansluiten

1. Voor het weergeven van video en geluid van een externe PC, volgt u de onderstaande instructies:
Opmerking: Externe Pc's kunnen ook worden aangesloten op het display via de HDMI-kabel.
 - Verbind een VGA-kabel (15 pinnen) van uw externe PC naar de VGA IN-poort op de display.
 - Verbind een audiokabel van de AUDIO OUT-poort op uw externe PC met de AUDIO IN-poort op de display.
2. Verbind een USB-kabel met de externe PC vanaf de TOUCH OUT-poort van de display.
Opmerking: Selecteer voor optimale resultaten 1920x1080p als ingangsresolutie van de externe computer.

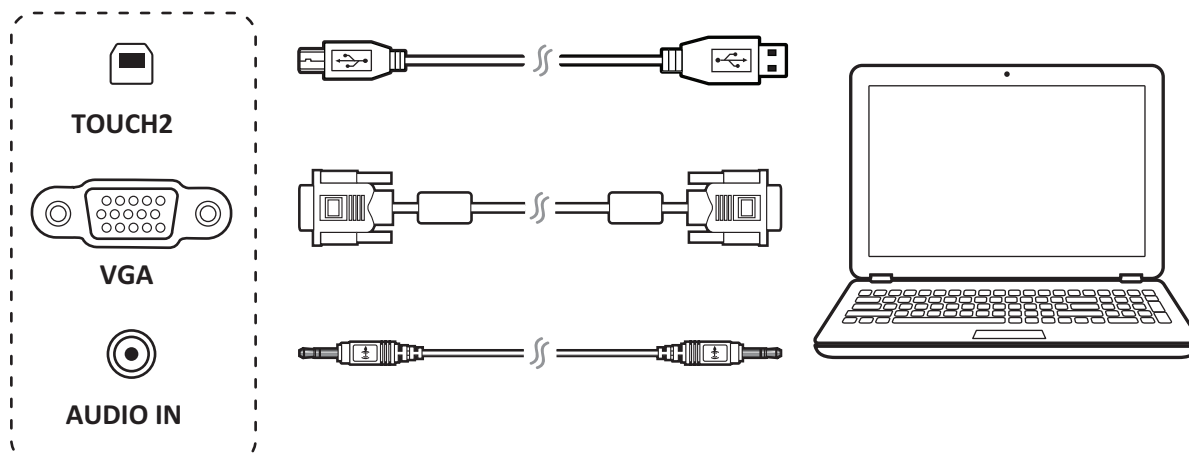

> RS232-verbindingen

Als u een seriële RS232-poortkabel gebruikt om uw display te verbinden met een externe computer kunnen bepaalde functies worden geregeld door de PC met inbegrip van aan/uitschakelen, volume regelen en meer.

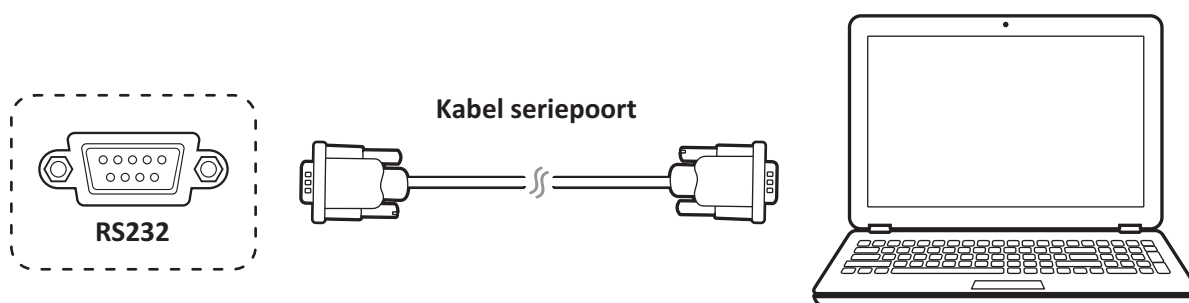

> USB-randapparatuur aansluiten

1. USB-randapparatuur: Stop de kabel van het USB-apparaat in de USB IN-poort.
2. Netwerk- en modemkabels: Stop de kabel van de router in de LAN IN-poort.
3. Microfoon: Stop de kabel van de microfoon in de MIC-poort.

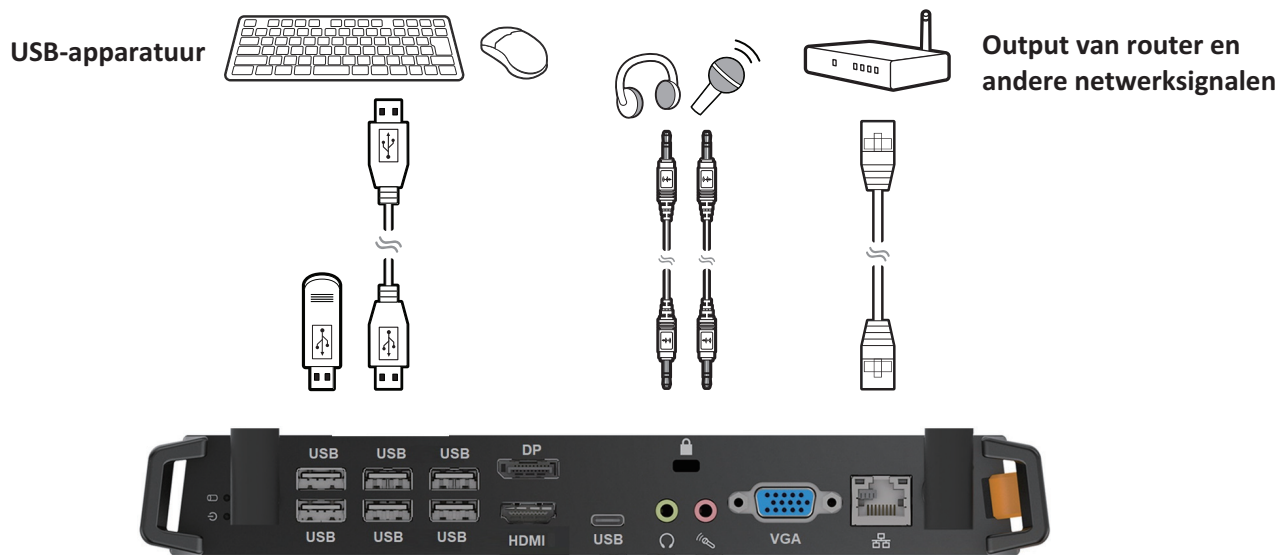

> HDMI-verbindingen

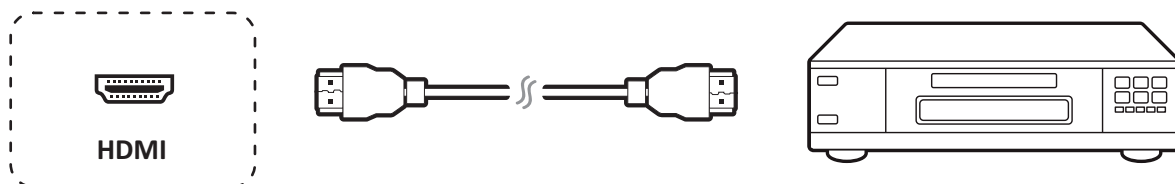

> Beginnen met gebruik

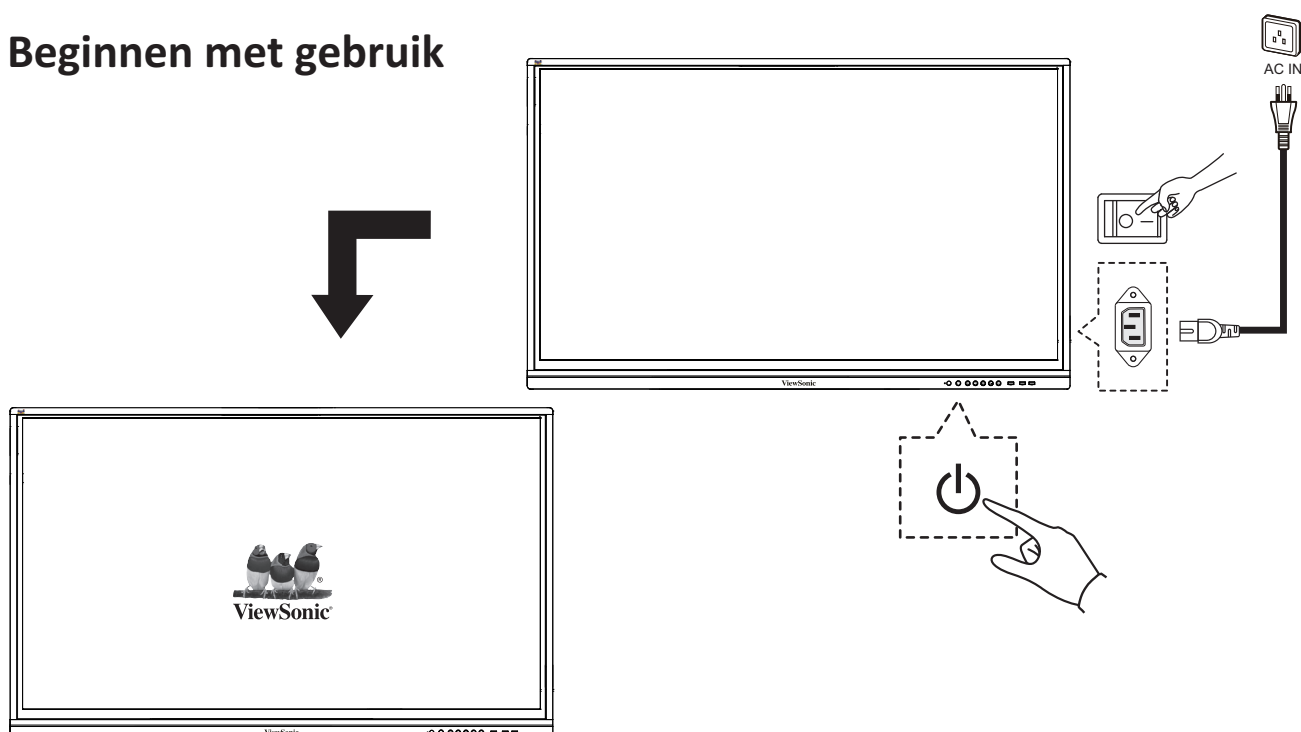



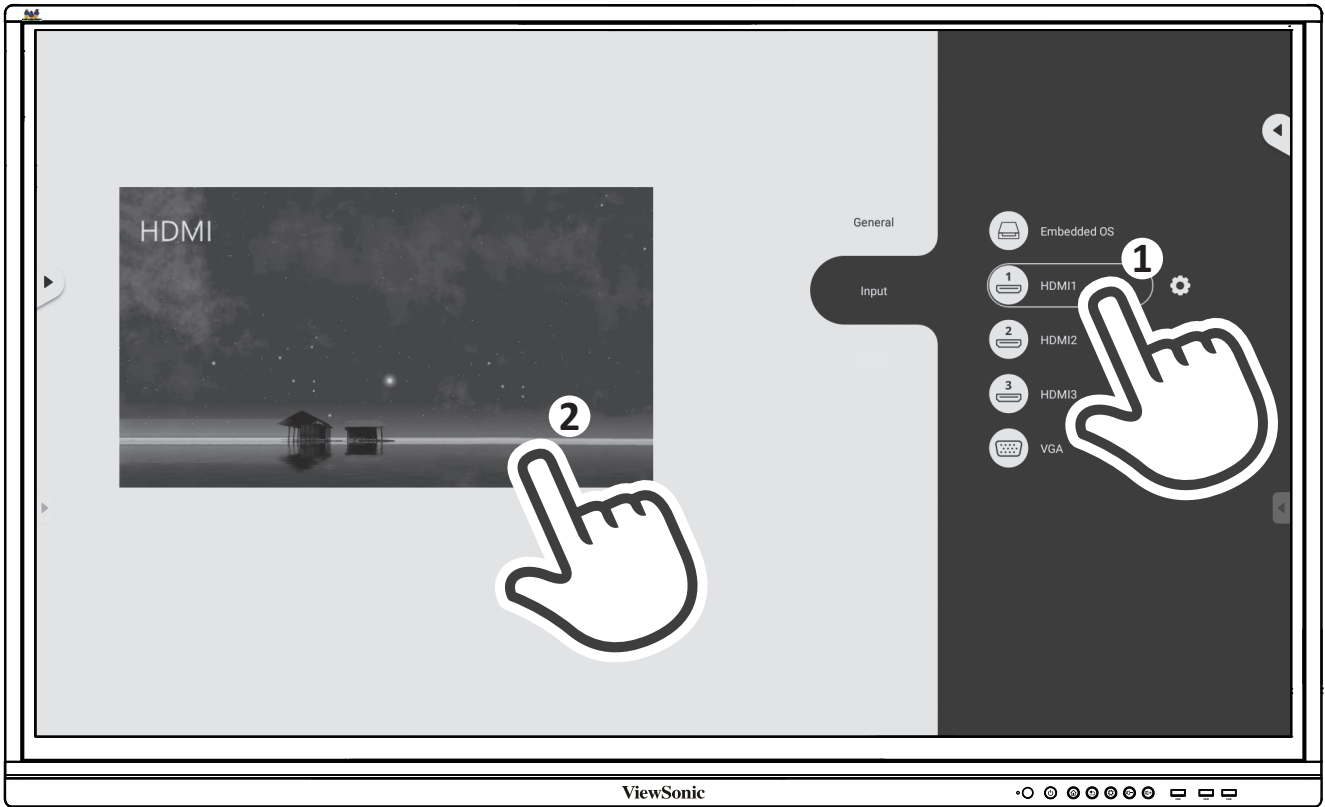
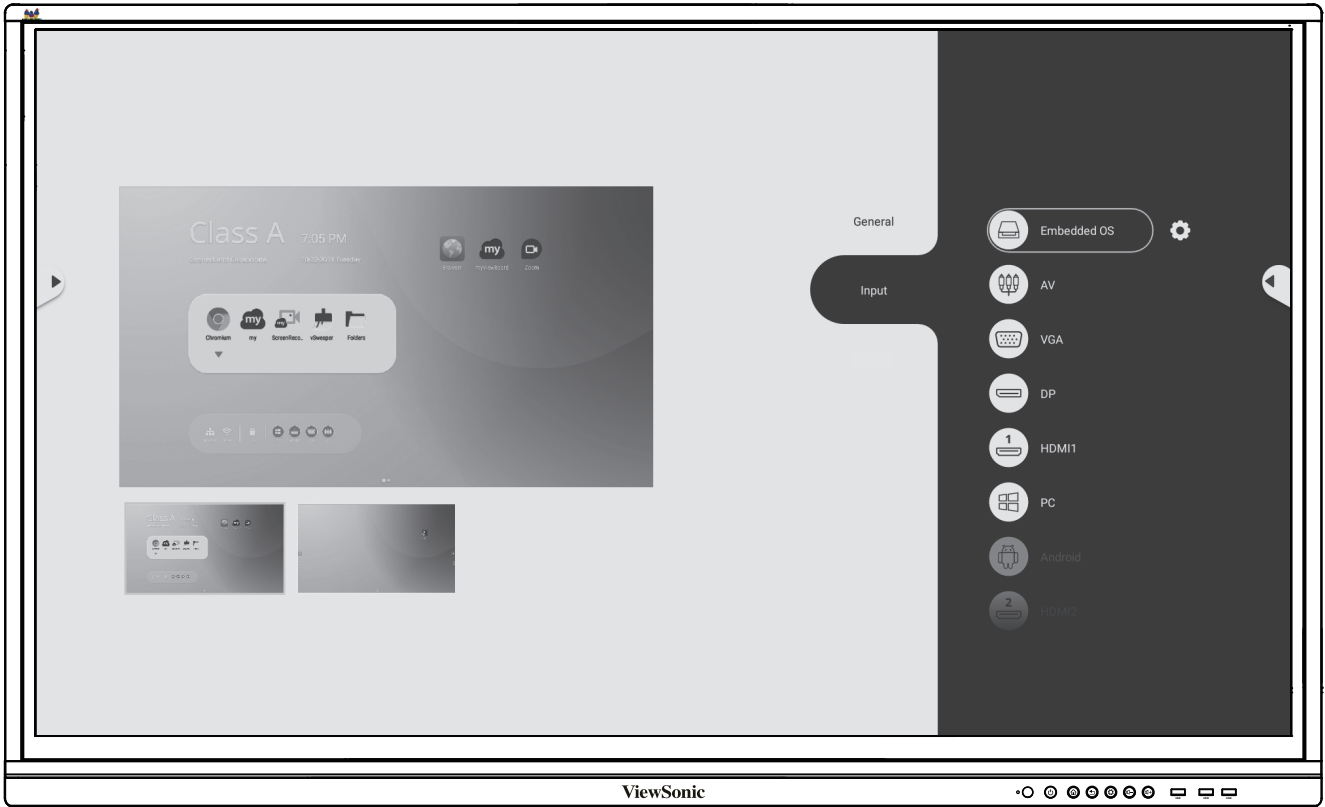

> Nalevingsverklaring

FCC-nalevingsverklaring: Dit apparaat voldoet aan Deel 15 van de FCC-voorschriften. De bediening moet beantwoorden aan de volgende twee voorwaarden: (1) dit apparaat mag geen schadelijke ruis veroorzaken en (2) dit apparaat dient ontvangen ruis te accepteren, inclusief ruis die ongewenste werking kan veroorzaken.

Industry Canada ICES-003-naleving: CAN ICES-3 (B)/NMB-3(B)



ViewSonic Corporation (VS/Canada/Latijns-Amerika)

 : www.viewsonic.com/support/product-registration



Verenigde Staten

 1-800-688-6688

 customerservice@viewsonic.com

Canada

 1-866-463-4775

 customerservice@viewsonic.com

Puerto Rico & Virgin Islands

 <http://www.viewsonic.com/la/soporte/servicio-tecnico> (Español)

Latijns-Amerika

 <http://www.viewsonic.com/la/soporte/servicio-tecnico-la/>



➤ Pakkauksen sisältö

- Virtakaapeli (toimitus alueittain)
- Kaukosäädin
- AAA-paristo x 2
- USB-kaapeli
- Kosketuskynä
- Pikaopas
- RS232-sovitin
- Kiristin x 5
- Kameral levy
- Ruuvi
- HDMI-yhteensopiva signaali-kaapeli

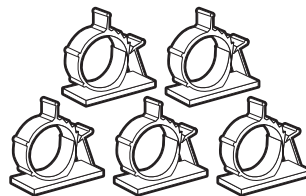
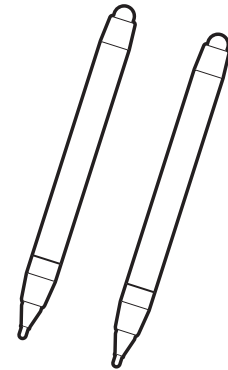
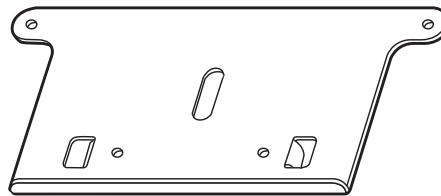
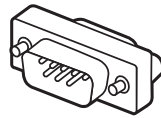
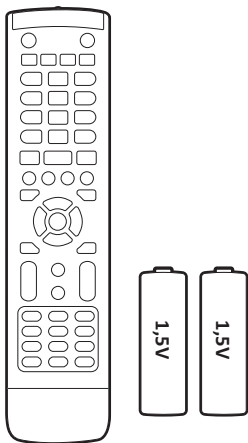
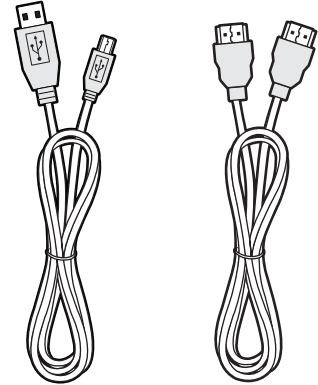
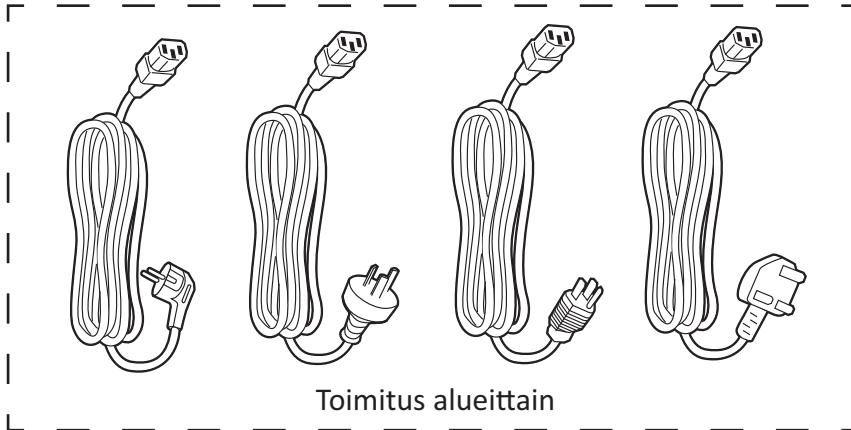

➤ Seinäkiinnityssarjan tekniset tiedot (VESA)

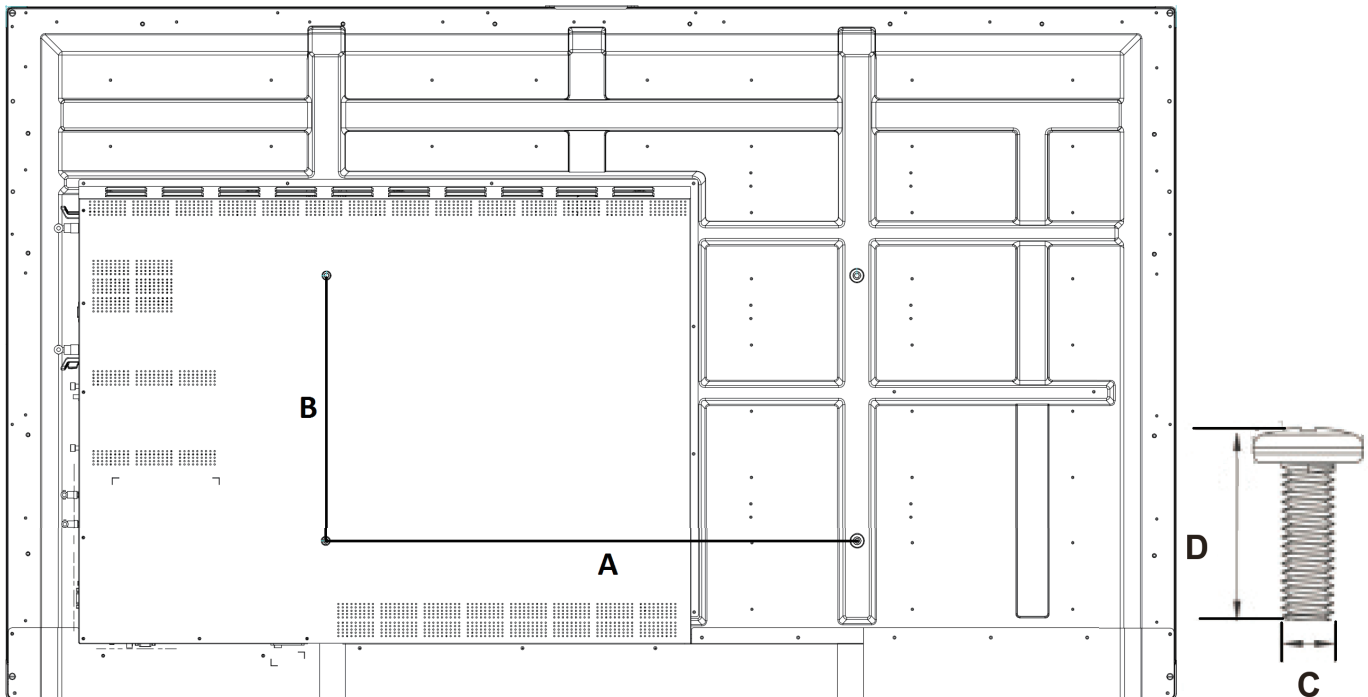

tuumaa	VESA-tiedot (A x B)	Vakioruuvi (C x D)	Määrä
IFP5550 - 55"	400 x 200 mm	M8 x 25 mm	4
IFP6550 - 65"	600 x 400 mm	M8 x 25 mm	4
IFP7550 - 75"	800 x 400 mm	M8 x 25 mm	4
IFP8650 - 86"	800 x 600 mm	M8 x 25 mm	4

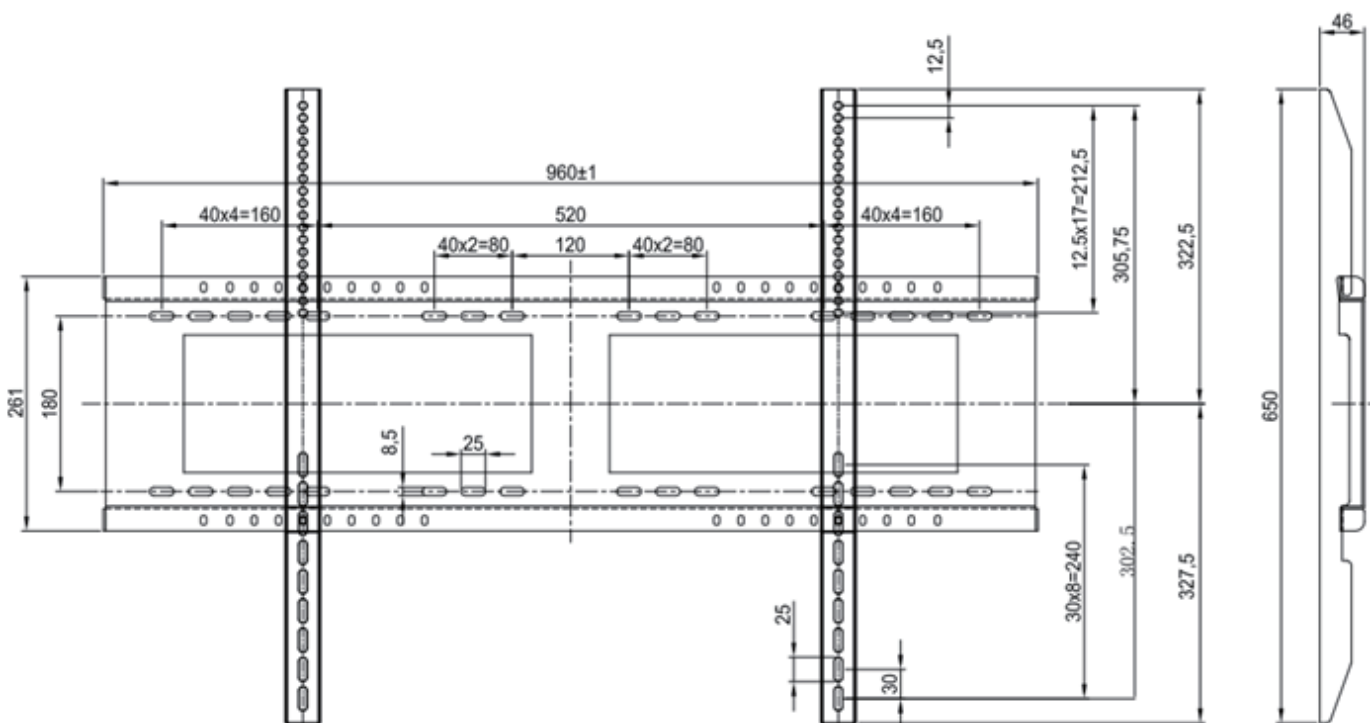

> Asennusympäristöhuomioita

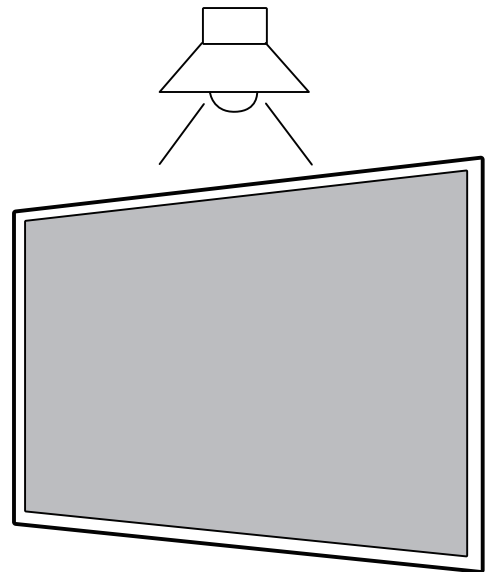
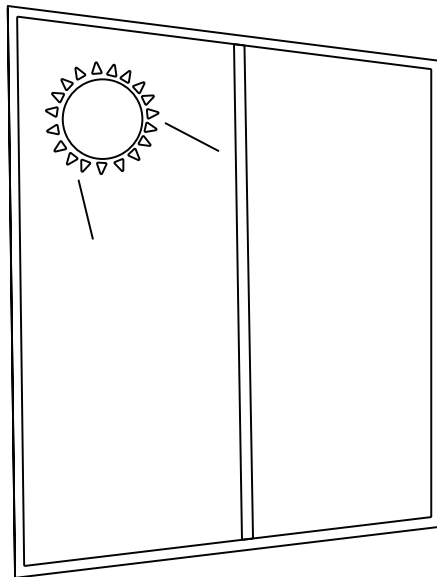
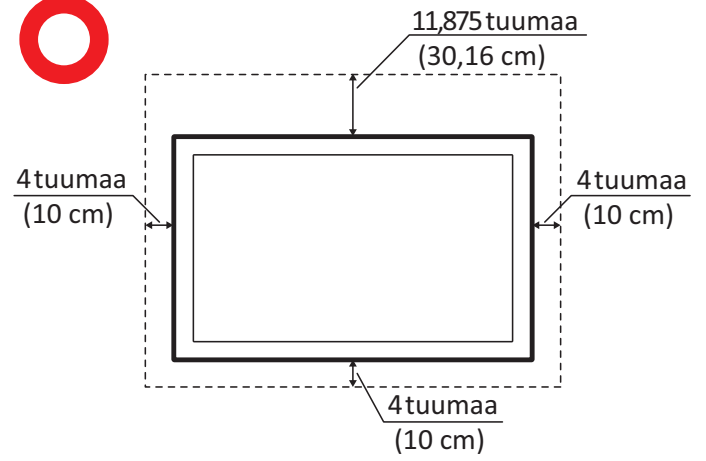
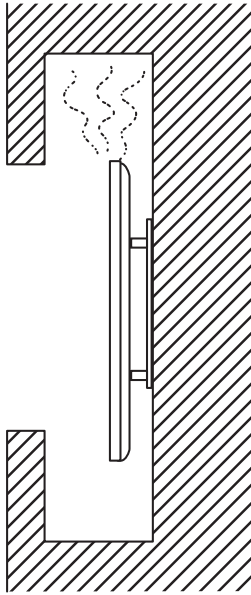

> Ohjauspaneelin yleiskatsaus

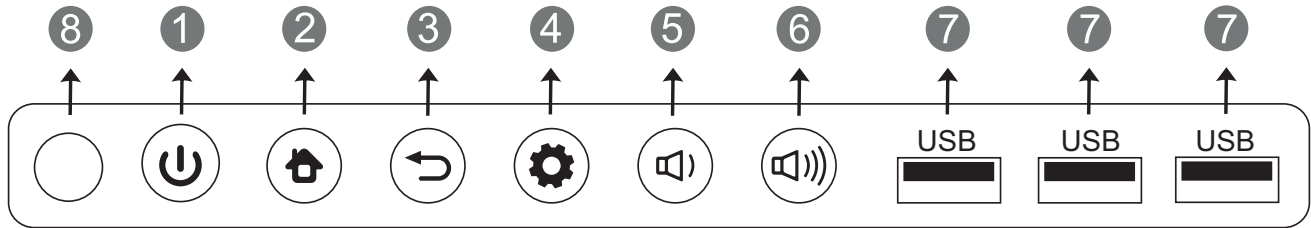

Nimike	Kuvaus
1	Paina näppäintä käynnistääksesi laitteen Paina näppäintä kytkeäksesi päälle/pois ainoastaan näytön taustavalon Pidä näppäintä painettuna kytkeäksesi laitteen pois päältä
2	Takaisin sisäisen soittimen pääkäyttöliittymään
3	Paluu sisäisen soittimen edelliselle tasolle
4	Siirry toimintovalikkoon
5	Pienentää äänenvoimakkuutta
6	Suurennna äänenvoimakkuutta
7	USB-portti sisäiselle soittimelle ja sisäiselle PC:lle
8	Vastaanottaa signaaleita kaukosäätimestä

> I/O-portti

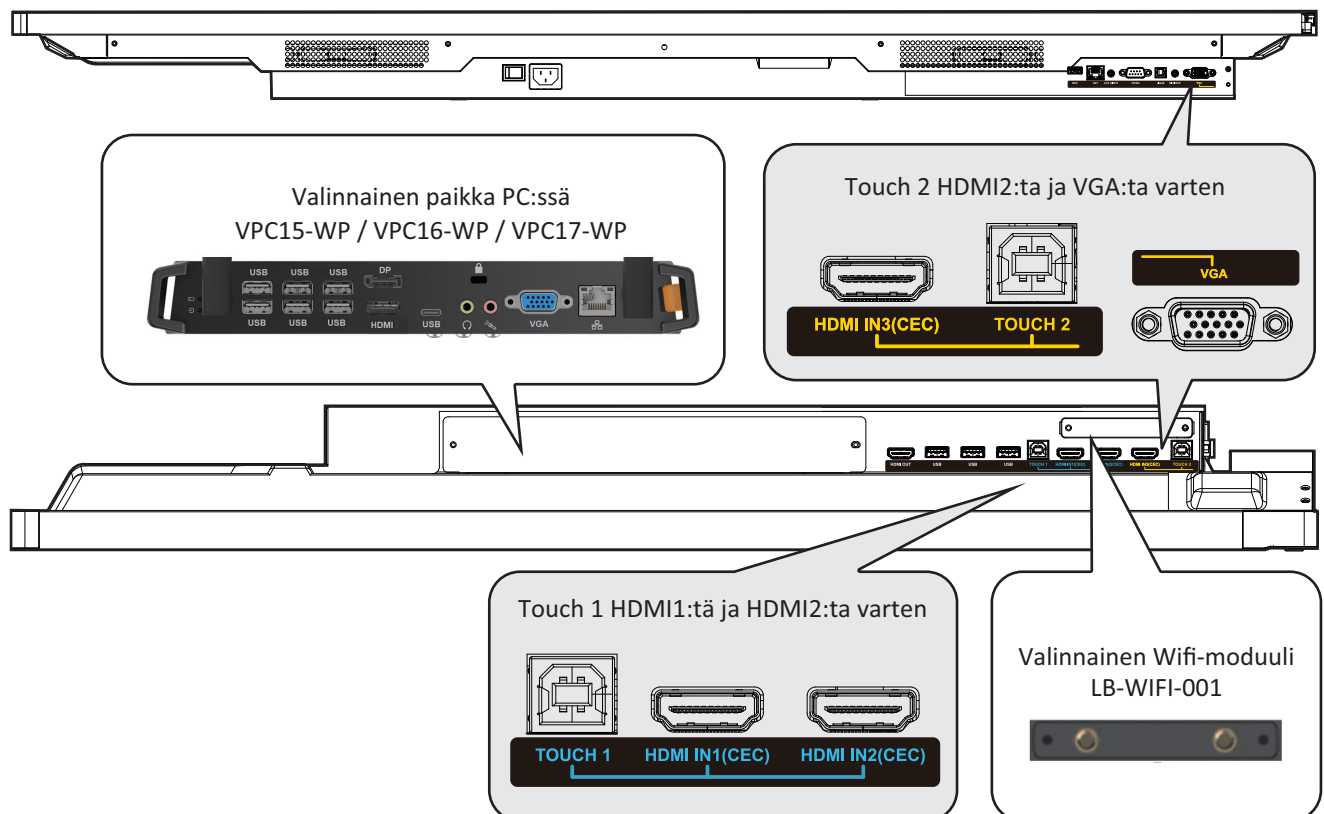

> Kaukosäätimen leiskatsaus

- 1 Paina kytkeäksesi näytön PÄÄLLE/POIS
- 2 Mykistä / Poista mykistys
- 3 **DISPLAY** Näytä nykyisen tulolähteen tiedot
- 4 **P.MODE** Tyhjä näyttö
- 5 **FREEZE** Pysäytä näyttö
- 6 **Numeric button** Numerosyöttöpainike
- 7 **- / -- / ALT+TAB** Paina vaihtaaksesi PC-sovellusten välillä
- 8 **0** Numerosyöttöpainike
- 9 Sulje nykyinen PC-ikkuna
- 10 **INPUT** Lähteen valintapainike
- 11 **MENU** Paina näyttääksesi valikon
- 12 **RED+ALT** Ruudunkaappaus
- 13 **GREEN+TAB** PC:n Välilehtipainike
- 14 **YELLOW+DESKTOP** Kytke tehdäksesi tilaa PC:n työpöydälle
- 15 **BLUE+BACKSPACE** PC:n askelpalautinpainike
- 16 **START / D. MENU** PC:n Windows-painike
- 17 PC:n Valikkopainike
- 18 Paina vierittääksesi ylös
- 19 Paina vierittääksesi vasemmalle
- 20 Paina vierittääksesi oikealle
- 21 Paina vierittääksesi alas
- 22 **ENTER** Enter-painike. Paina sitä valitaksesi valintoja.
- 23 Kirjoitusohjelmiston käynnistys
- 24 **ESC / EXIT / D. SETUP** Pikavalintapainike valintaikkunoista poistumiseen
- 25 **EPG** Takaisin
- 26 **FAV / SPACE** PC:n Välilyöntipainike
- 27 **CH. + / CH. -** CH+: PC:n edellinen sivu
CH-: PC:n seuraava sivu
- 28 **VOL+ / VOL-** Lisää/Vähennä äänenvoimakkuutta
- 29 **F1** Windowsin F1-toiminto
- 30 **F2** Windowsin F2-toiminto
- 31 **F3** Windowsin F3-toiminto
- 32 **F4** Windowsin F4-toiminto
- 33 **F5** Windowsin F5-toiminto
- 34 **F6** Windowsin F6-toiminto
- 35 **F7** Windowsin F7-toiminto
- 36 **F8** Windowsin F8-toiminto
- 37 **F9** Windowsin F9-toiminto
- 38 **F10** Windowsin F10-toiminto
- 39 **F11** Windowsin F11-toiminto
- 40 **F12** Windowsin F12-toiminto

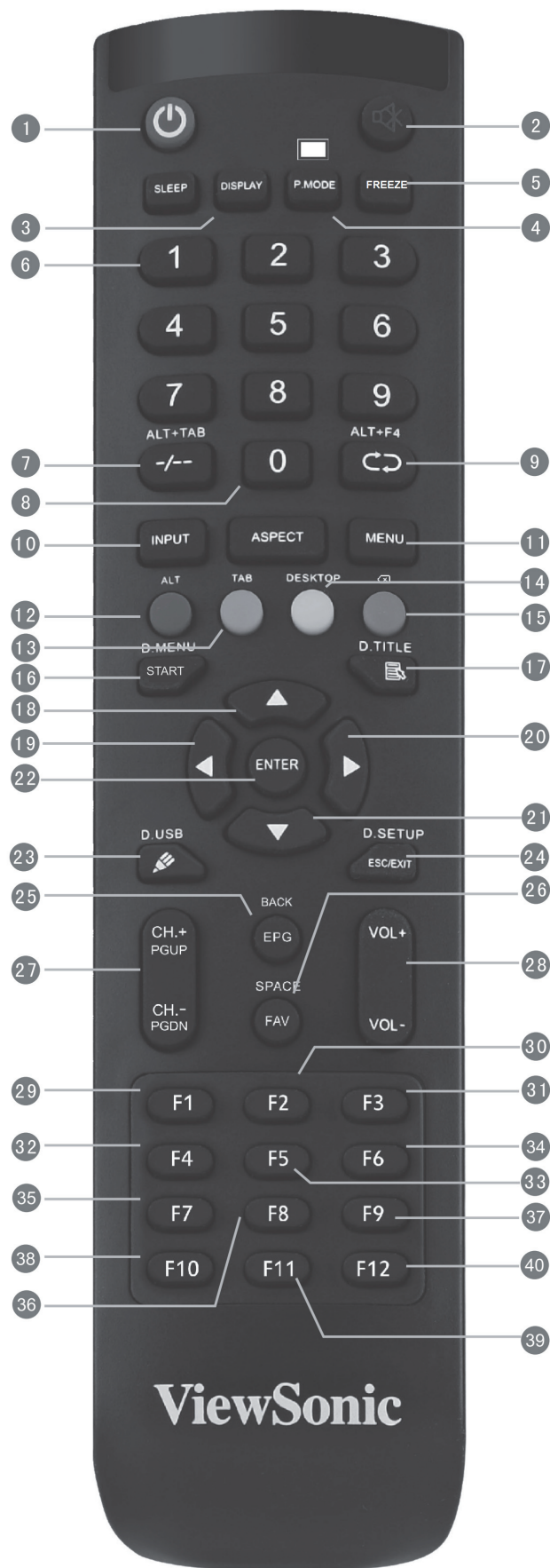

> Ulkoisen PC:n liittäminen

1. Toistaaksesi videota ja ääntä ulkoisesta PC:stä, toimi seuraavien ohjeiden mukaisesti:

Huomautus: Ulkoiset PC:t voi liittää näyttöön myös HDMI-kaapelilla.

- Liitä VGA-kaapeli (15-nastainen) ulkoisesta PC:stä näytön VGA IN -porttiin.
- Liitä audiokaapeli ulkoisen PC:n AUDIO OUT -portista näytön AUDIO IN -porttiin.

2. Liitä USB-kaapeli ulkoiseen PC:hen näytön TOUCH OUT -porttiin.

Huomautus: Saadaksesi parhaat tulokset, valitse ulkoisen tietokoneen tuloresoluutioksi 1920x1080p.

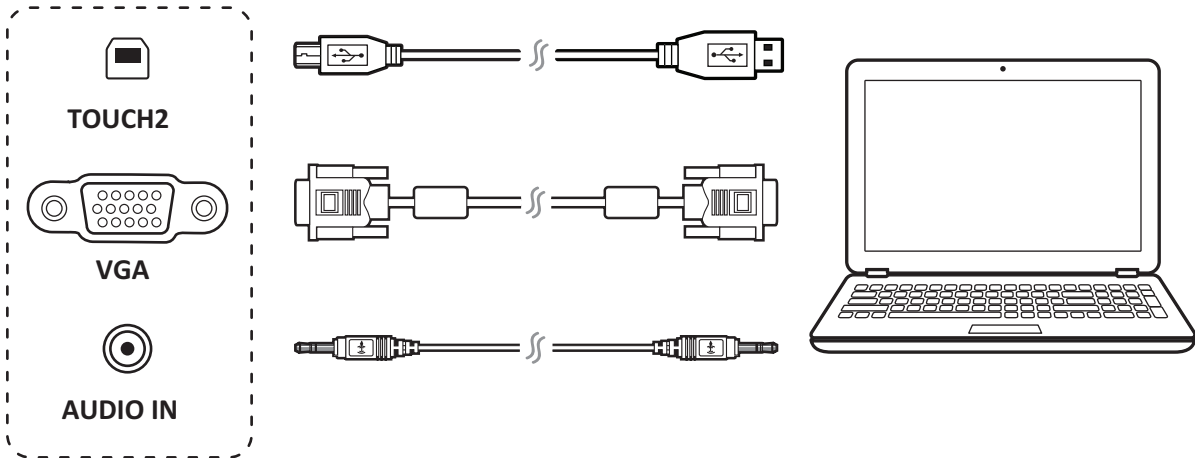

> RS232-yhteydet

Kun käytät RS232-sarjaporttikaapelia näytön liittämiseen ulkoiseen tietokoneeseen, tiettyjä toimintoja voi ohjata PC:llä, mukaan lukien virta päälle/pois, äänenvoimakkuuden säätö jne.

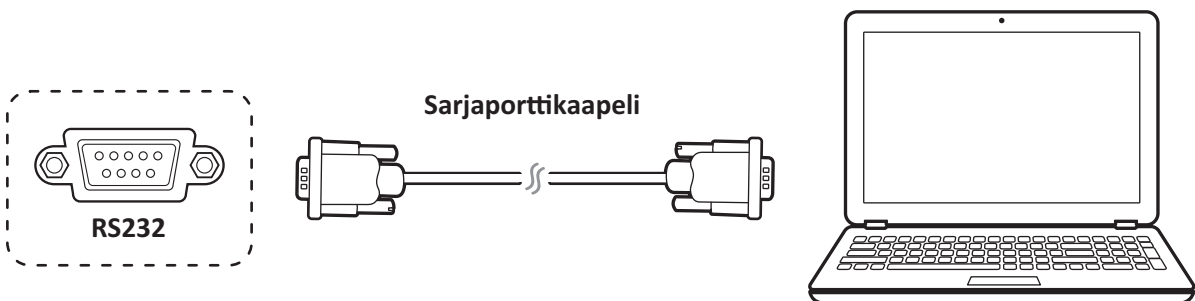

> USB-ohjelaitteiden liittäminen

1. USB-ohjelaitteet: Liitä USB-laitteen kaapeli USB IN -porttiin.
2. Verkko ja modeemikaapelit: Liitä reititinkaapeli LAN IN -porttiin.
3. Mikrofoni: Liitä mikrofoni kaapeli MIC-porttiin.

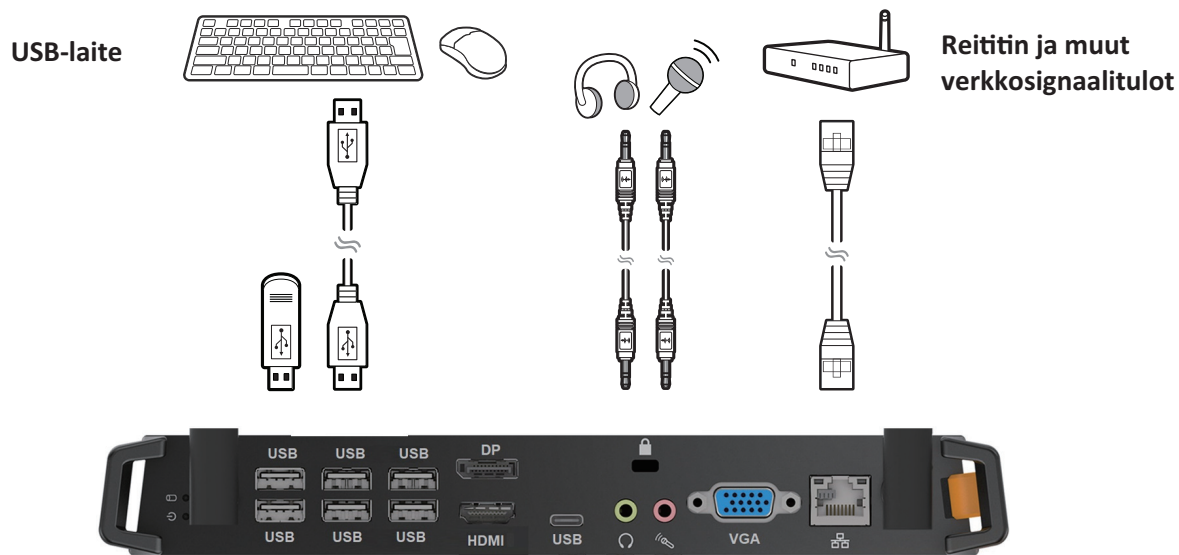

> HDMI-yhteydet

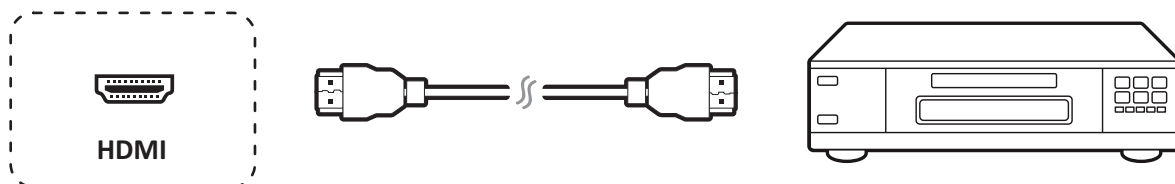

> Aloita käyttö

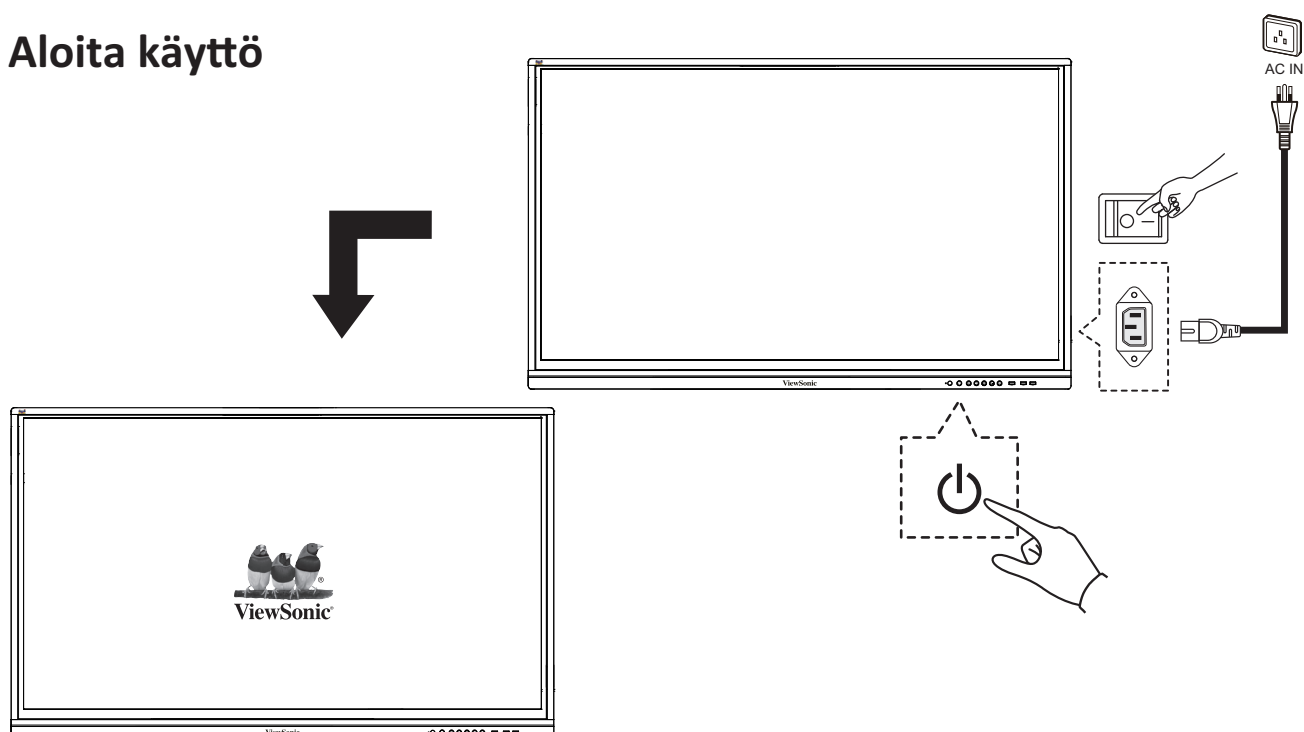



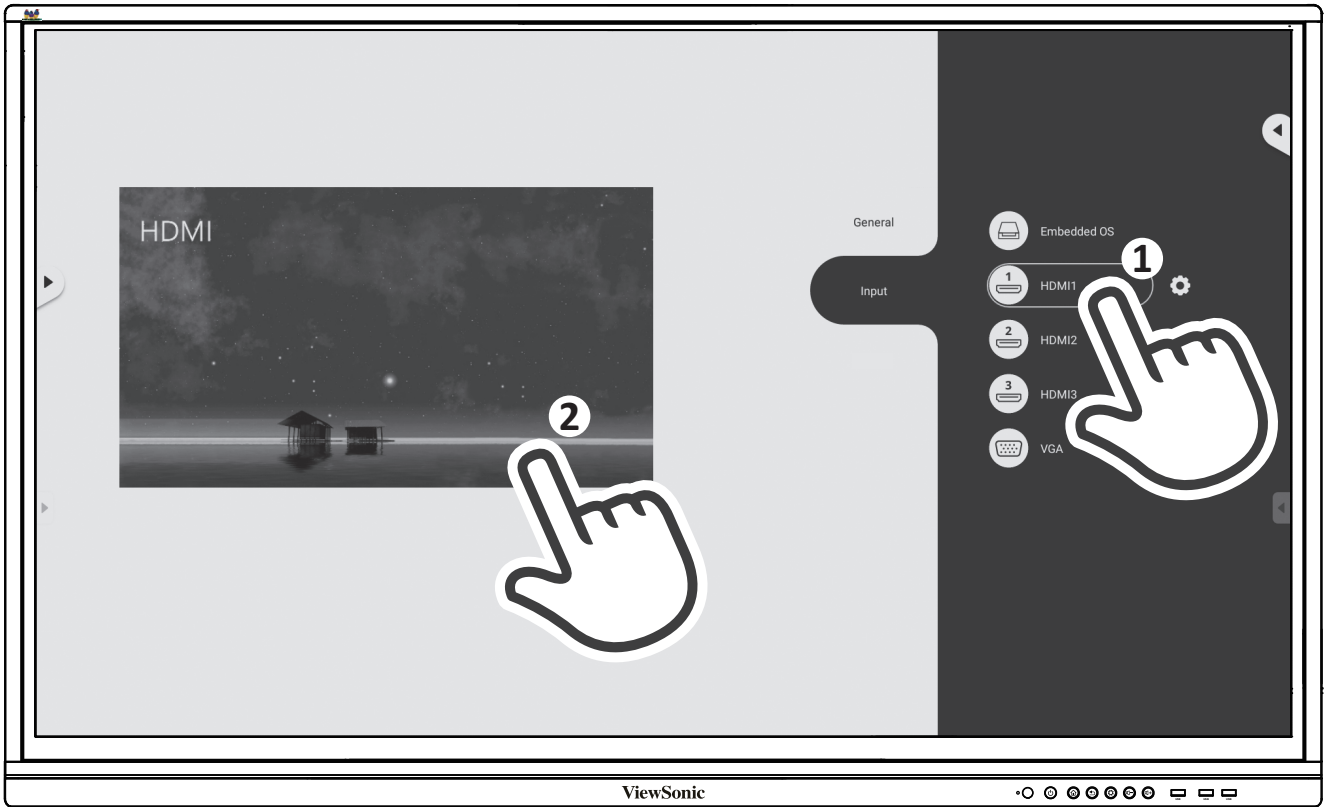
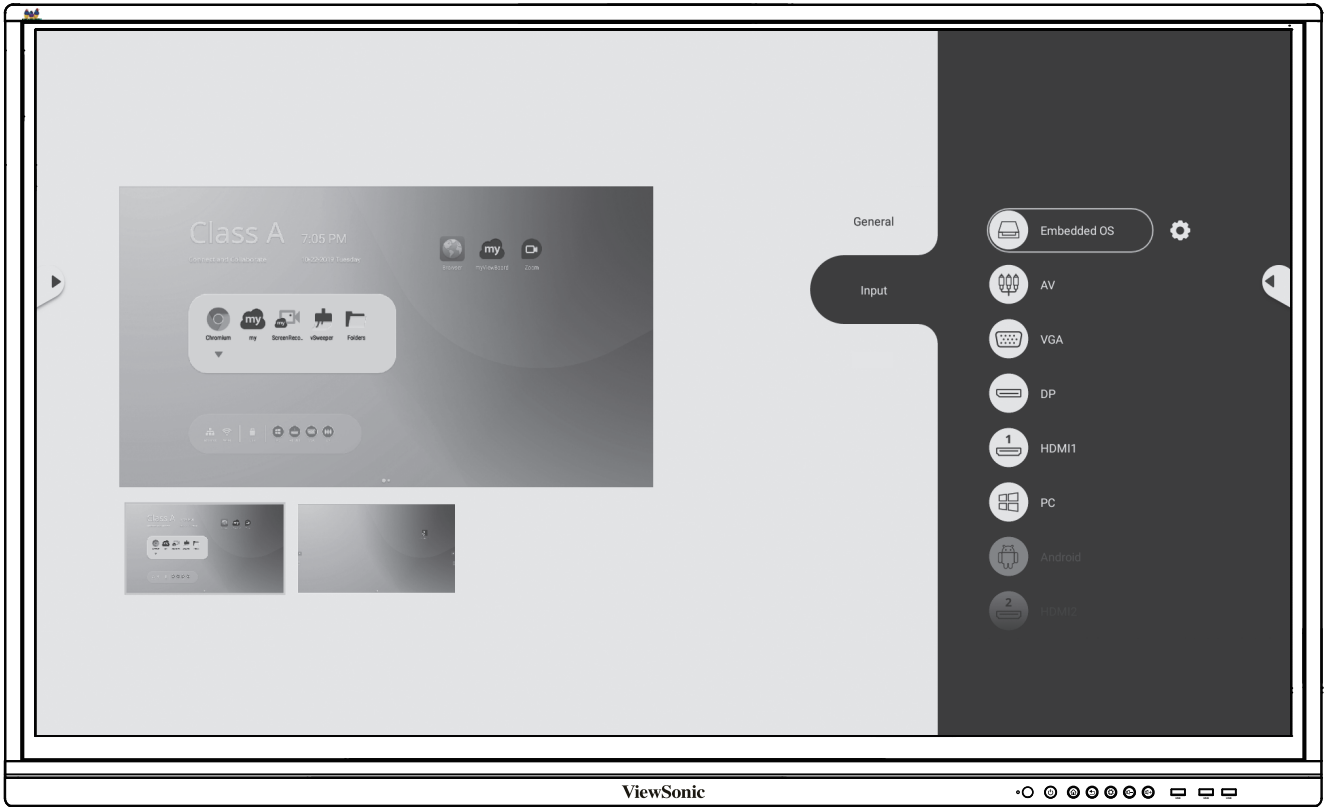

> Yhteensopivuusilmoitus

FCC-yhdenmukaisuusilmoitus: Laite on FCC-sääntöjen osan 15 mukainen. Laitteen käyttöä koskevat seuraavat kaksi ehtoa: (1) tämä laite saattaa aiheuttaa haitallista häiriötä, ja (2) tämän laitteen tulee vastaanottaa siihen tuleva häiriö, mukaan lukien häiriöt, joka voivat aiheuttaa ei-toivottuja toimintoja.
Industry Canada ICES-003 -yhdenmukaisuus: CAN ICES-3 (B)/NMB-3(B)



ViewSonic Corporation (Yhdysvallat/Kanada/ Latinalainen Amerikka)

 : www.viewsonic.com/support/product-registration



Yhdysvallat

 1-800-688-6688

 customerservice@viewsonic.com

Kanada

 1-866-463-4775

 customerservice@viewsonic.com

Puerto Rico ja Neitsytsaaret

 <http://www.viewsonic.com/la/soporte/servicio-tecnico> (Español)

Latinalainen Amerikka

 <http://www.viewsonic.com/la/soporte/servicio-tecnico-la/>



ViewSonic-tukikeskus



Valinnainen lisävaruste

➤ Contenu de la boîte

- Câble d'alimentation (varie selon la région)
- Télécommande
- 2 piles AAA
- Câble USB
- Stylet tactile
- Guide de démarrage rapide
- Adaptateur RS232
- 5 piles Pince
- Plaque de caméra
- Vis
- Câble de signal compatible avec HDMI

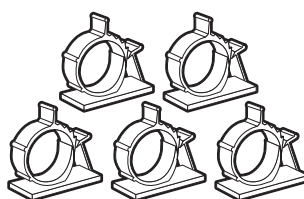
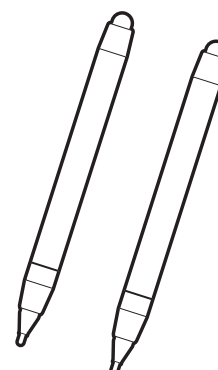
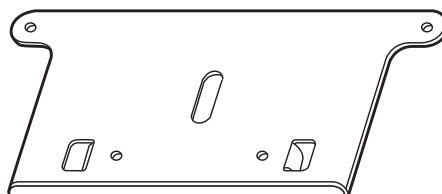
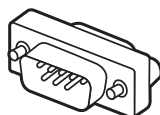
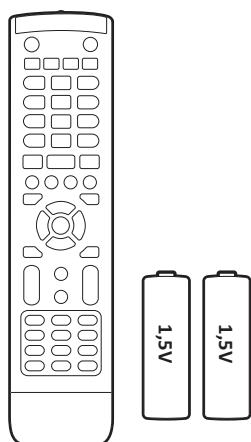
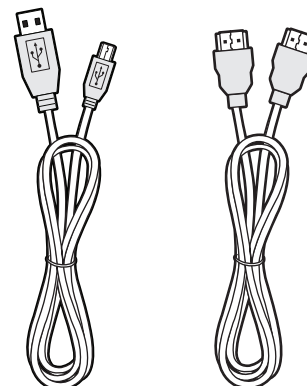
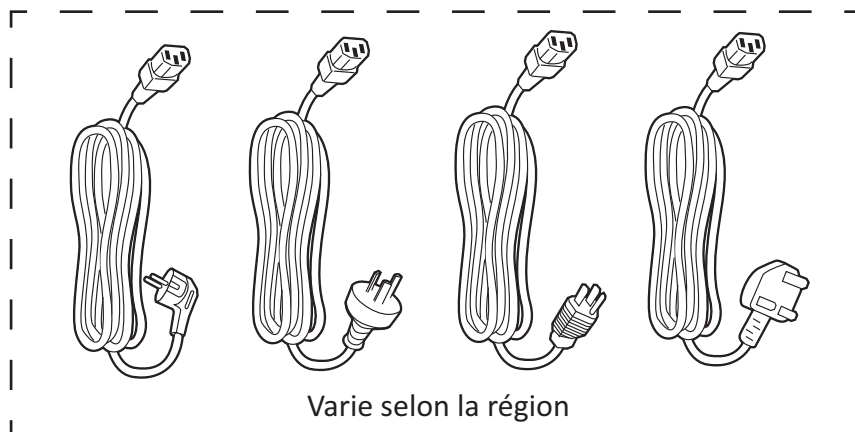

➤ Spécifications du kit de montage mural

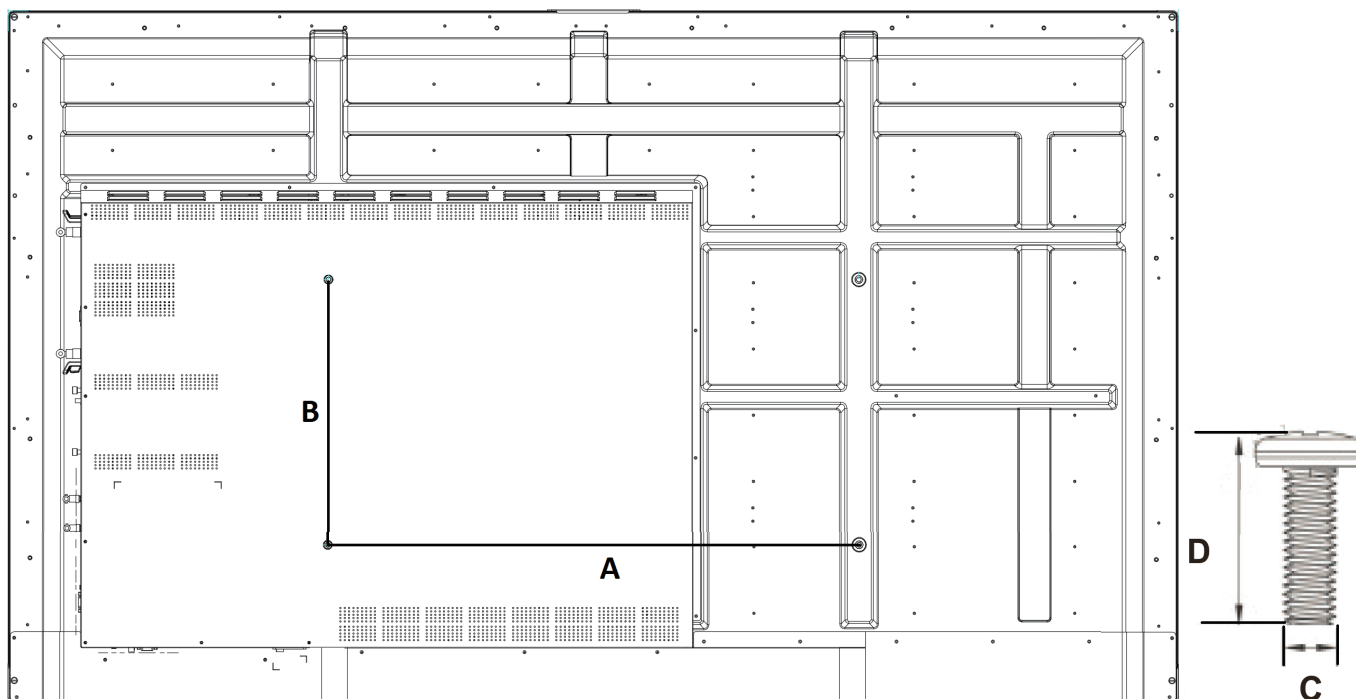

Pouces	Spéc. VESA (A x B)	Vis standard (C x D)	Quantité
IFP5550 - 55"	400 x 200 mm	M8 x 25 mm	4
IFP6550 - 65"	600 x 400 mm	M8 x 25 mm	4
IFP7550 - 75"	800 x 400 mm	M8 x 25 mm	4
IFP8650 - 86"	800 x 600 mm	M8 x 25 mm	4

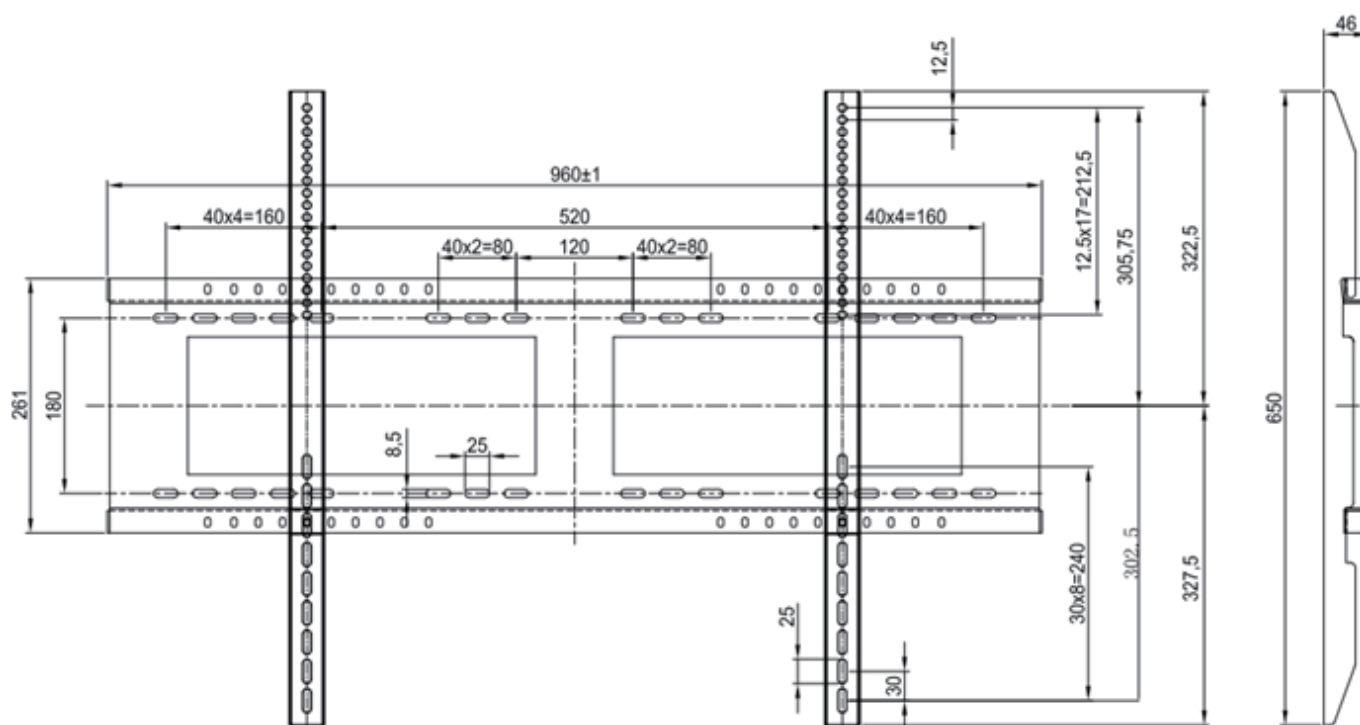

➤ Mise en garde relative à l'environnement d'installation

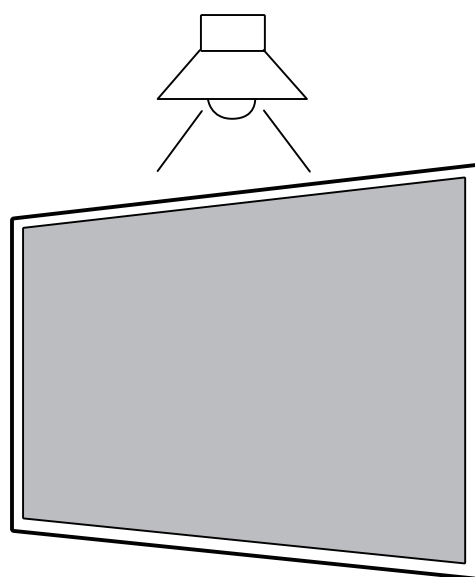
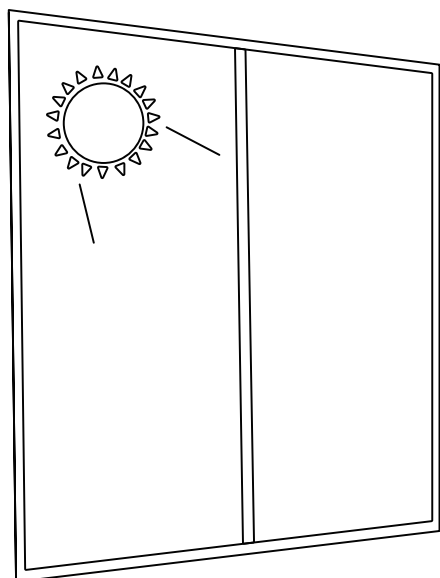
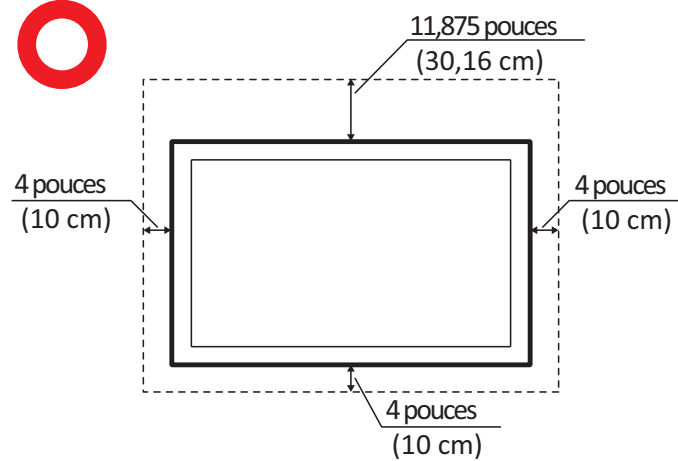
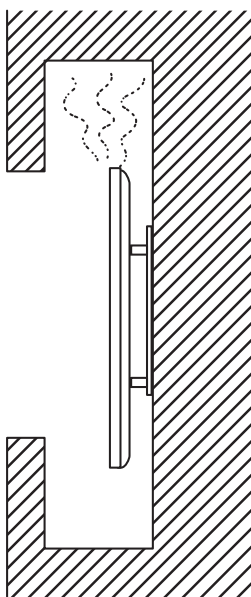

> Présentation du panneau de commandes

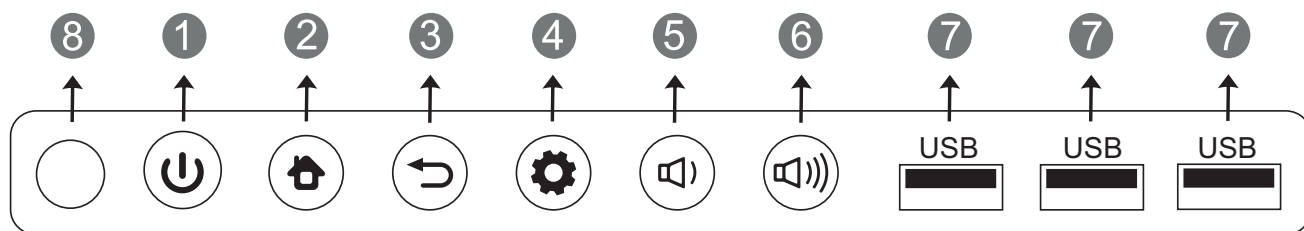





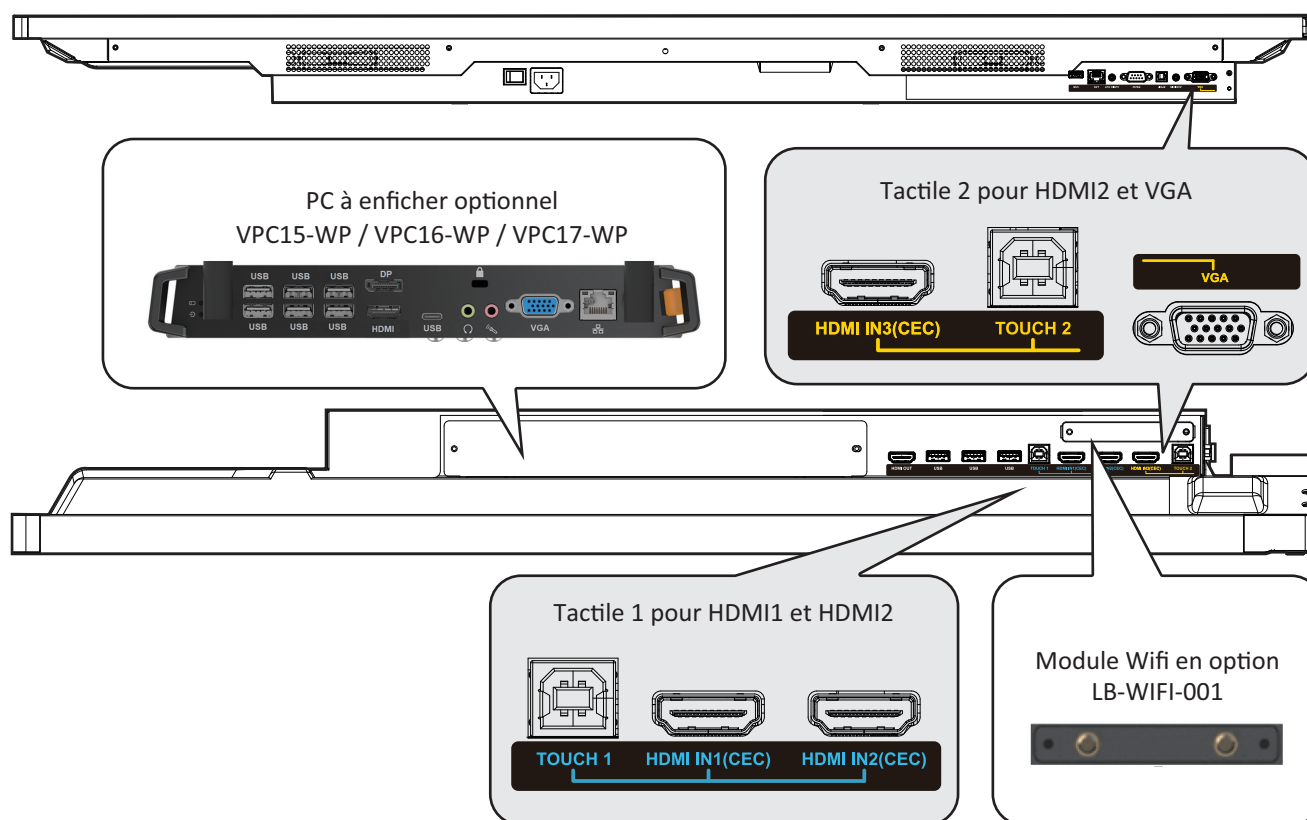



Élément	Description
1	Appuyez pour allumer l'appareil Appuyez sur la touche pour désactiver/activer uniquement le rétroéclairage de l'écran Appuyez en maintenez enfoncé pour éteindre l'appareil
2	Retour à l'interface principale du lecteur intégré
3	Revenir au niveau précédent du lecteur intégré
4	Menu de la fonction d'appel
5	Baisser le volume
6	Augmenter le volume
7	Port USB pour Embedded Player et PC interne
8	Reçois les signaux provenant de la télécommande.

> Port E/S



➤ Présentation de la télécommande

- 1**  Appuyez pour allumer ou éteindre l'écran MARCHE/ARRÊT
- 2**  Muet / Son
- 3** **DISPLAY**
Affichage des informations sur la source d'entrée sélectionnée
- 4** **P.MODE**
Écran vide
- 5** **FREEZE**
Écran figé
- 6** **Numeric button**
Touche de saisie numérique
- 7** **- / -- / ALT+TAB**
Appuyer pour basculer entre les applications pour ordinateur
- 8** **0**
Touche de saisie numérique
- 9**  / ALT+F4
Fermer la fenêtre PC actuelle
- 10** **INPUT**
Touche de sélection de la source
- 11** **MENU**
Appuyez pour afficher le Menu
- 12** **RED+ALT**
Capture d'écran
- 13** **GREEN+TAB**
Touche 'Onglet' PC
- 14** **YELLOW+DESKTOP**
Passer à l'emplacement sur le bureau PC
- 15** **BLUE+BACKSPACE**
Touche 'Retour arrière' PC
- 16** **START / D. MENU**
Touche 'Windows' PC
- 17**  / D.TITLE
Touche 'Menu' PC
- 18**  Appuyez pour faire défiler vers le haut
- 19**  Appuyez pour faire défiler vers la gauche
- 20**  Appuyez pour faire défiler vers la droite
- 21**  Appuyez pour faire défiler vers le bas
- 22** **ENTER**
Touche Entrée. Appuyer sur cette touche pour sélectionner des options.
- 23**  / D. USB
Initialisation de l'écriture de logiciel
- 24** **ESC / EXIT / D. SETUP**
Touche de raccourci pour quitter les boîtes de dialogue
- 25** **EPG**
Retour
- 26** **FAV / SPACE**
Touche 'Espace' PC
- 27** **CH. + / CH. -**
CH+ : Page précédente PC
CH- : Page suivante PC
- 28** **VOL+ / VOL-**
Augmenter / diminuer le volume
- 29** **F1**
Fonction F1 Windows
- 30** **F2**
Fonction F2 Windows
- 31** **F3**
Fonction F3 Windows
- 32** **F4**
Fonction F4 Windows
- 33** **F5**
Fonction F5 Windows
- 34** **F6**
Fonction F6 Windows
- 35** **F7**
Fonction F7 Windows
- 36** **F8**
Fonction F8 Windows
- 37** **F9**
Fonction F9 Windows
- 38** **F10**
Fonction F10 Windows
- 39** **F11**
Fonction F11 Windows
- 40** **F12**
Fonction F12 Windows

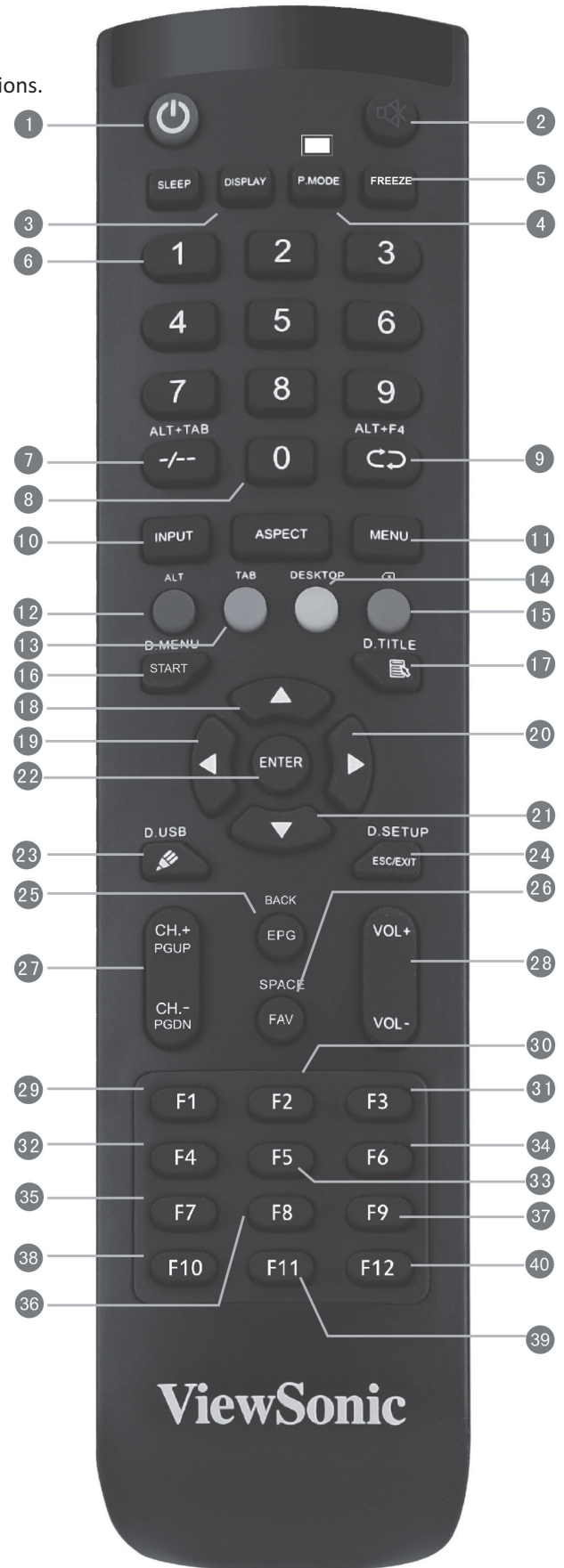

> Connexion d'un ordinateur externe

1. Pour afficher la vidéo et générer le son provenant d'un ordinateur externe, suivez les instructions ci-dessous :

Remarque : Il est également possible de connecter des ordinateurs externes à l'écran à l'aide d'un câble HDMI.

- Connectez un câble VGA (15 broches) entre l'ordinateur externe et le port VGA IN de l'écran.
- Connectez un câble audio entre le port AUDIO OUT de votre ordinateur externe et le port AUDIO IN de l'écran.

2. Connectez un câble USB entre l'ordinateur externe et le port TOUCH OUT de l'écran.

Remarque : Pour des résultats optimaux, sélectionnez 1920x1080p comme résolution d'entrée de l'ordinateur externe.

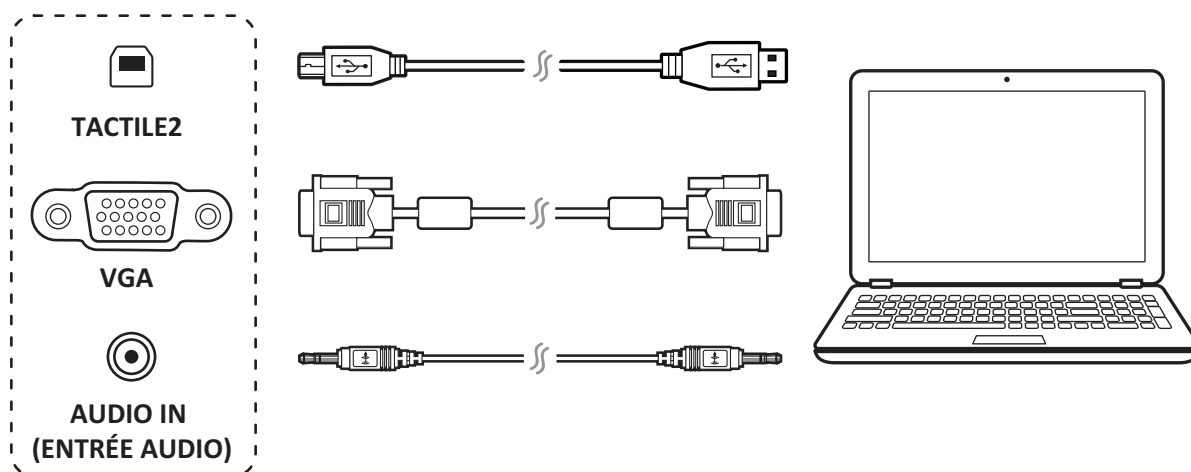

> Connexions RS232

Lorsque vous utilisez un câble de port série RS232 pour connecter votre écran à un ordinateur externe, certaines fonctions peuvent être contrôlées depuis l'ordinateur, y compris marche/arrêt, le réglage du volume.

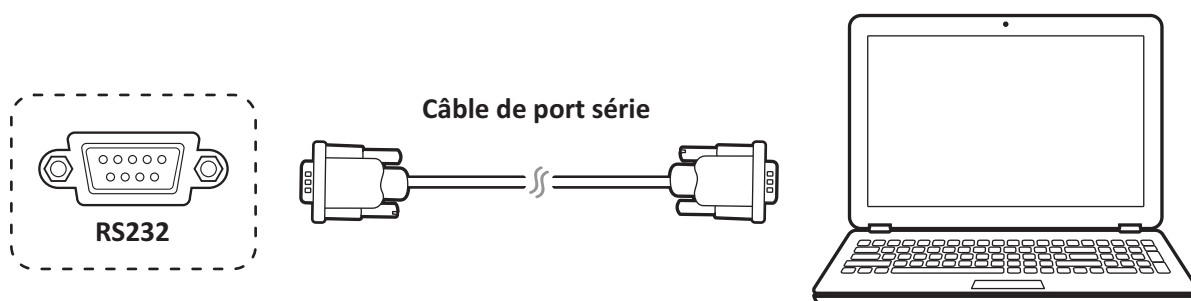

> Connexion de périphériques USB

1. Périphériques USB : Branchez le câble du périphérique USB dans le port USB IN.
2. Câbles de réseau et de modem : Branchez le câble du routeur dans le port LAN IN.
3. Microphone : Branchez le câble du microphone dans le port MIC.

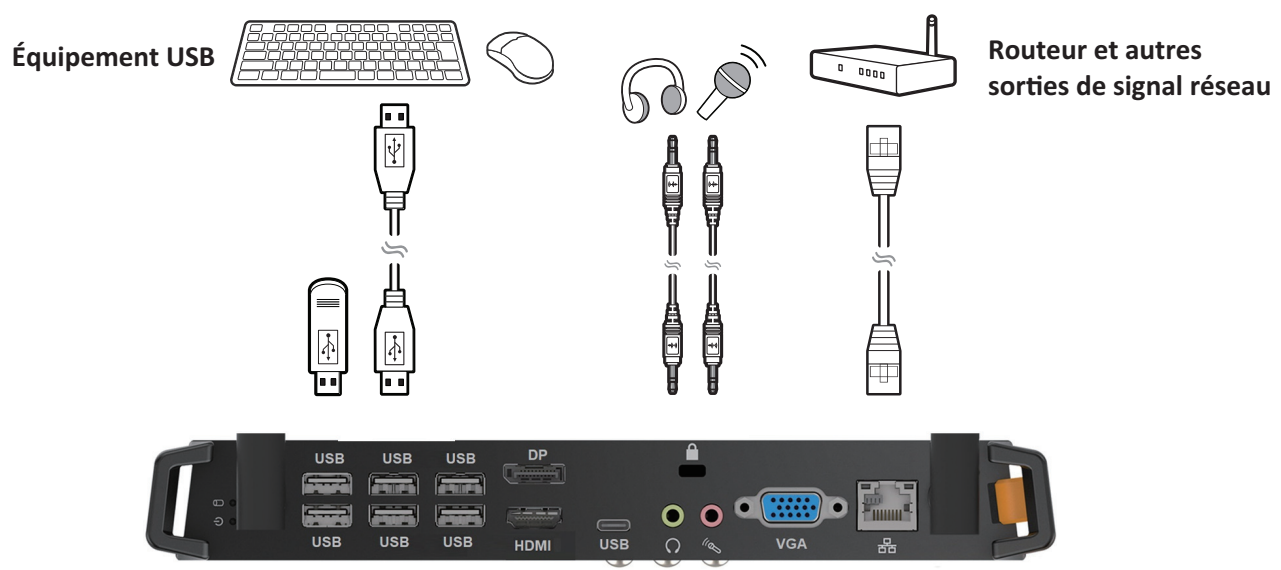

> Connexions HDMI

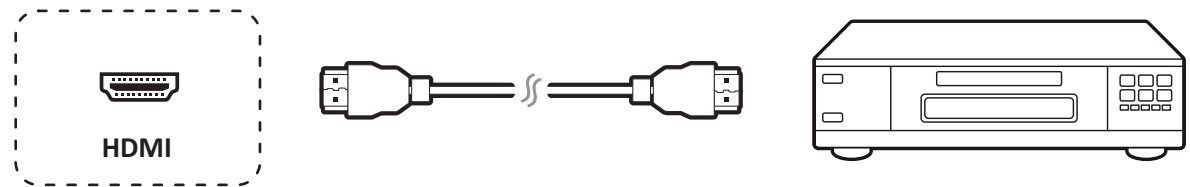

> Commencer l'utilisation

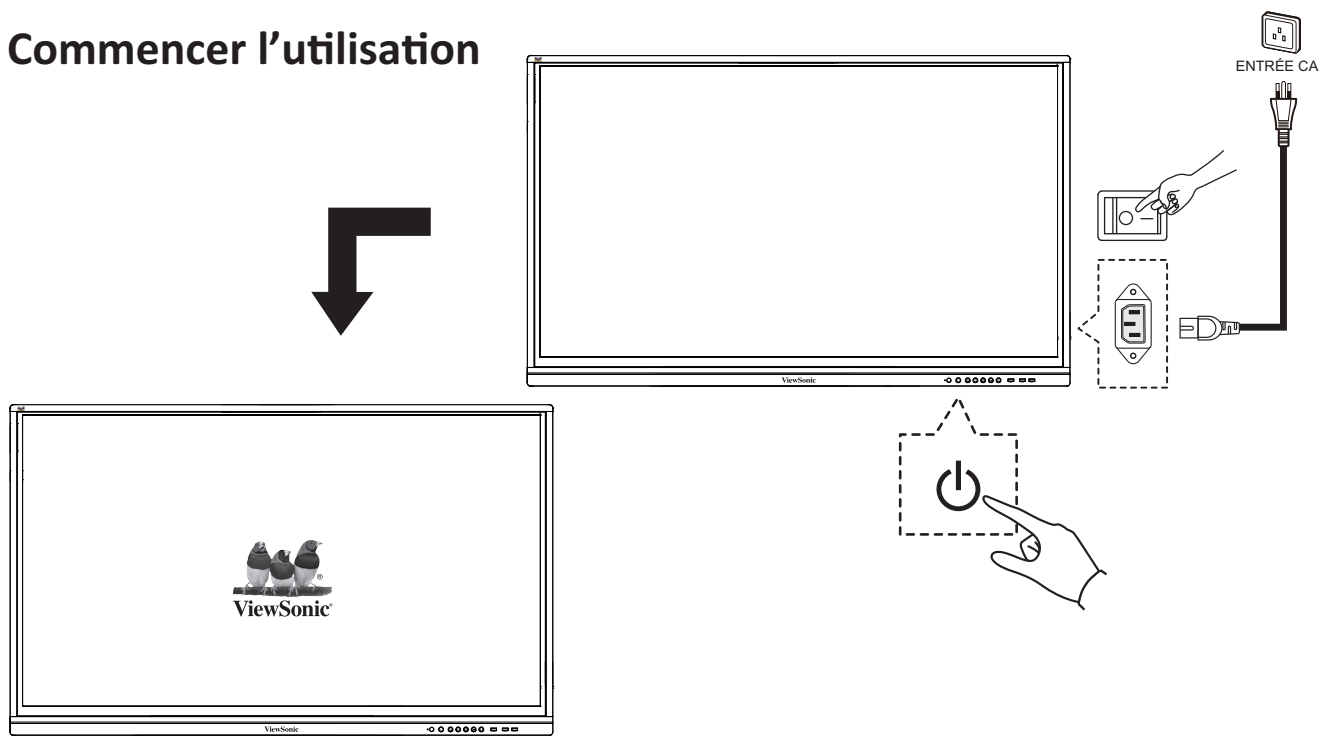



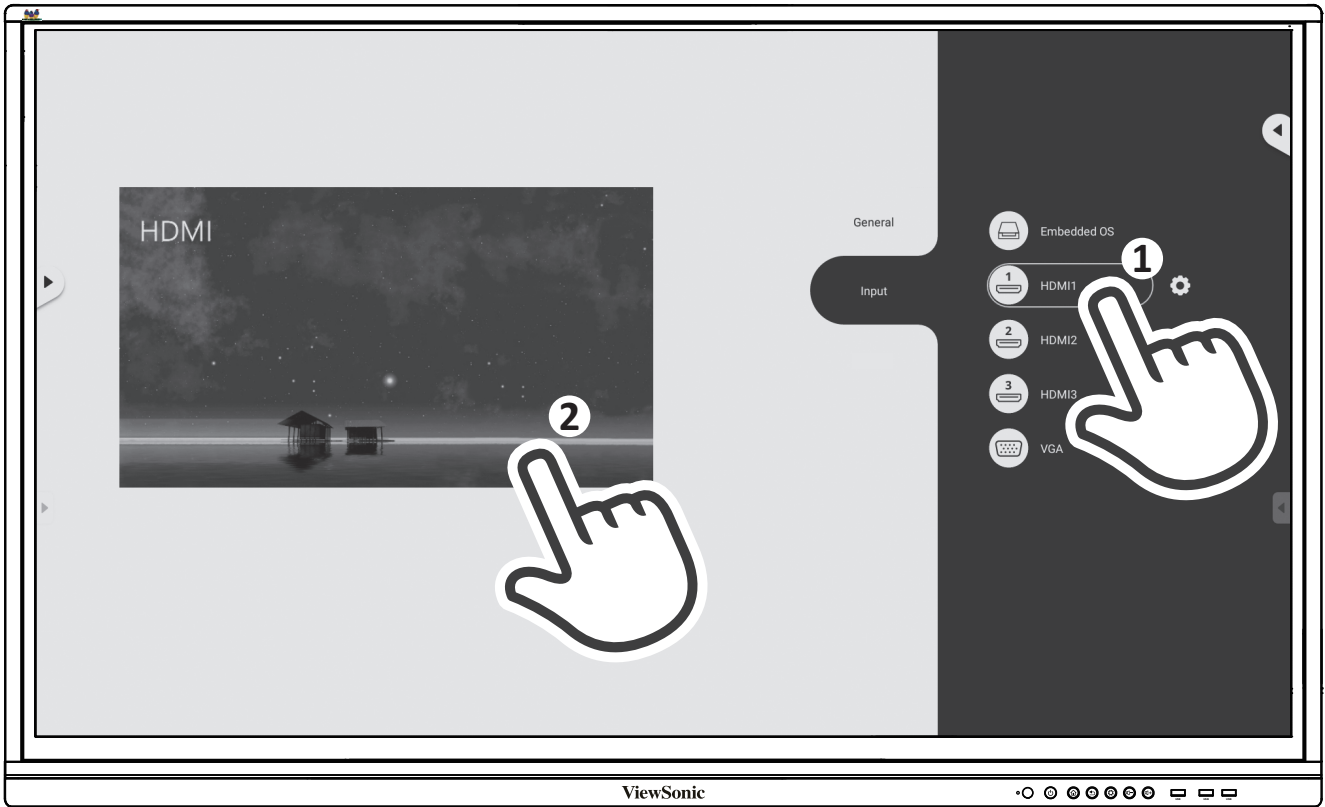
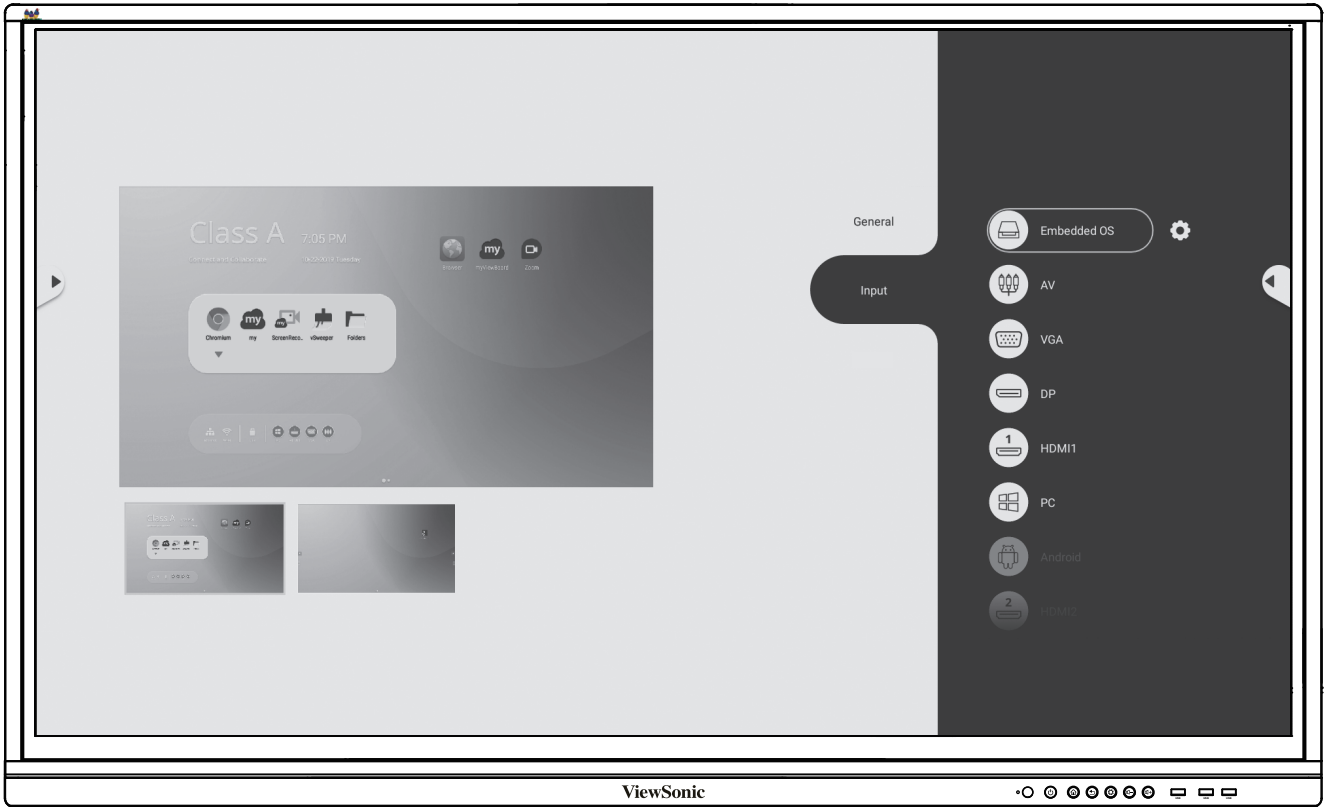

> Déclaration de conformité

Déclaration de conformité à la FCC : Cet appareil est conforme à l'article 15 des Règlements FCC. Son utilisation est soumise aux deux conditions suivantes : (1) cet appareil ne doit pas causer d'interférence nuisible et (2) cet appareil doit accepter toutes les interférences reçues, y compris les interférences pouvant causer un fonctionnement non souhaité.

Conformité à Industry Canada ICES-003 : CAN ICES-3 (B)/NMB-3(B)



ViewSonic Corporation (US/Canada/Amérique latine)

 : www.viewsonic.com/support/product-registration



États-Unis

 1-800-688-6688

 customerservice@viewsonic.com

Canada

 1-866-463-4775

 customerservice@viewsonic.com

Puerto Rico et îles Vierges

 <http://www.viewsonic.com/la/soporte/servicio-tecnico> (Español)

Amérique latine

 <http://www.viewsonic.com/la/soporte/servicio-tecnico-la/>



> Lieferumfang

- Netzkabel (je nach Region unterschiedlich)
- Fernbedienung
- 2 AAA-Batterien
- USB-Kabel
- Touch-Stift
- Schnellstartanleitung
- RS232-Adapter
- Klammer x 5
- Kameraplatte
- Schraube
- Mit HDMI kompatibles Signalkabel

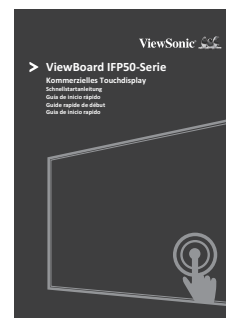
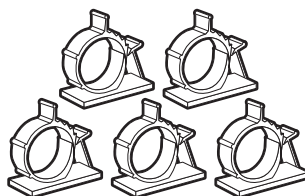
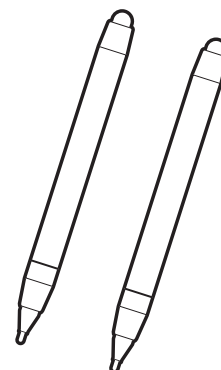
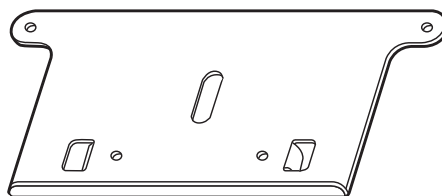
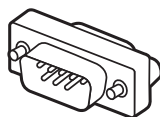
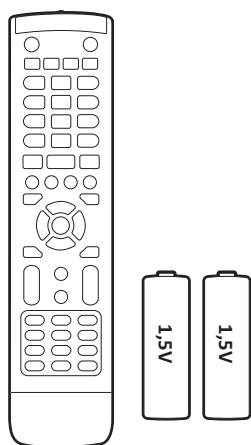
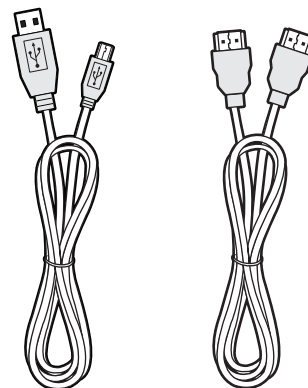
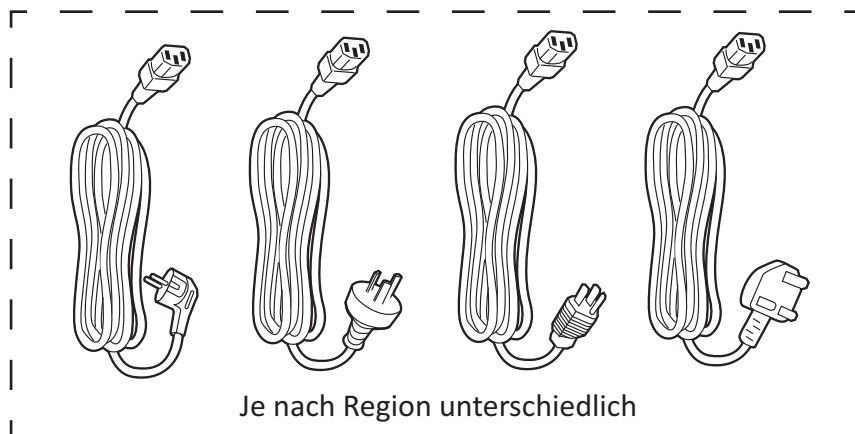

➤ Wandmontageset – Spezifikationen (VESA)

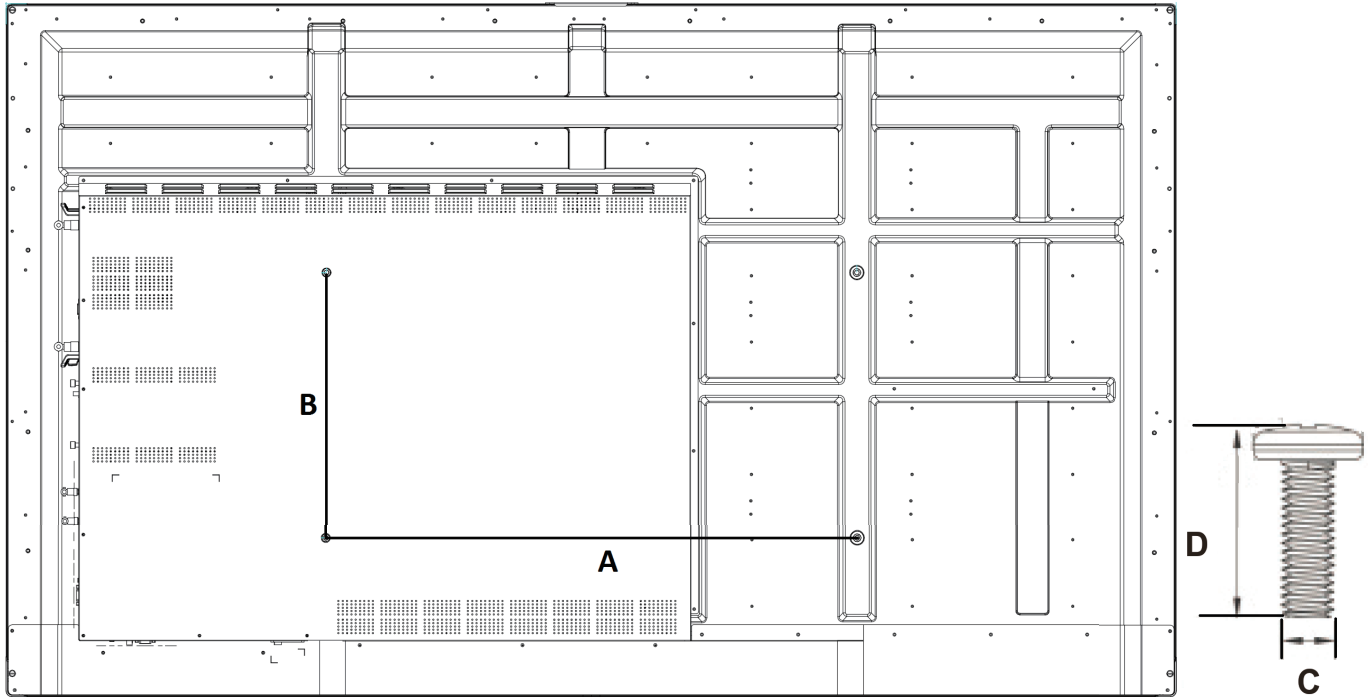

Zoll	VESA-Spezifikationen (A × B)	Standardschraube (C × D)	Menge
IFP5550 - 55"	400 × 200 mm	M8 x 25 mm	4
IFP6550 - 65"	600 × 400 mm	M8 x 25 mm	4
IFP7550 - 75"	800 × 400 mm	M8 x 25 mm	4
IFP8650 - 86"	800 × 600 mm	M8 x 25 mm	4

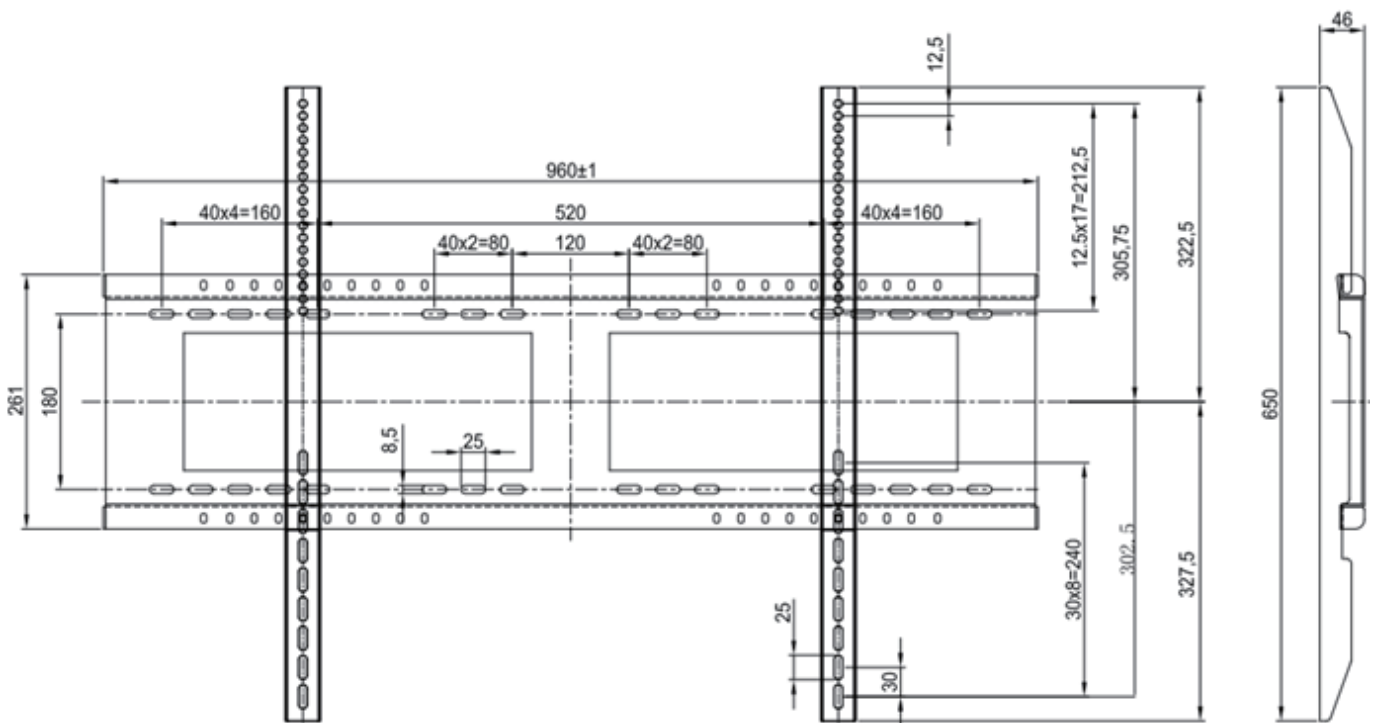

> Warnhinweise zur Installationsumgebung

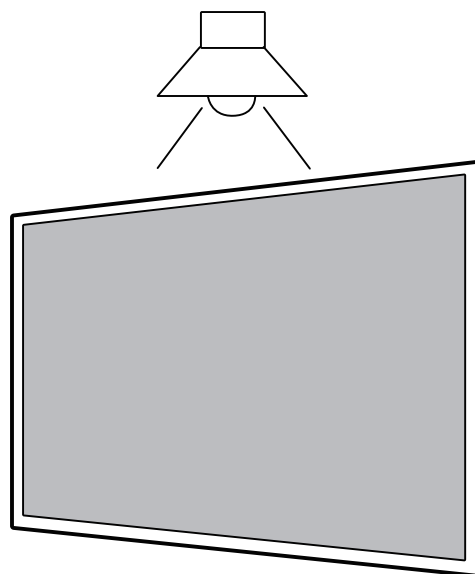
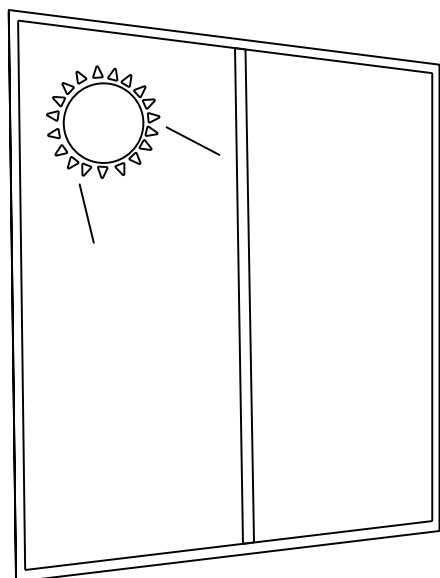
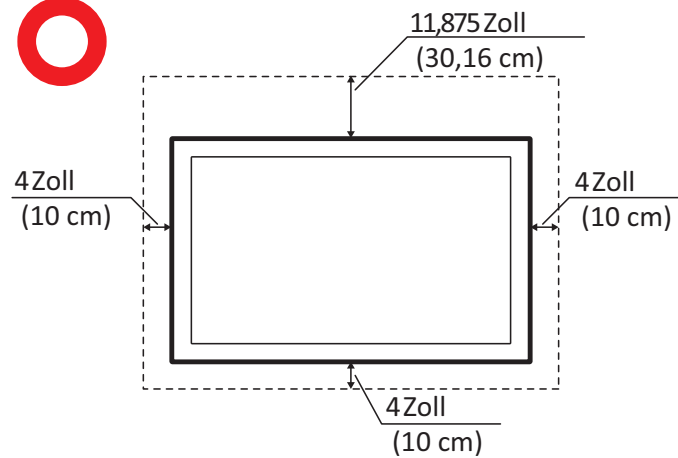
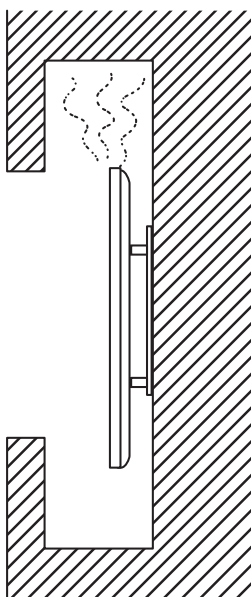

> Bedienfeldübersicht

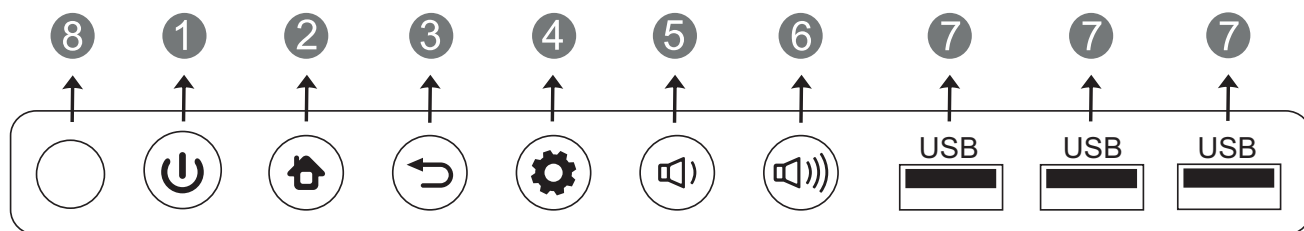





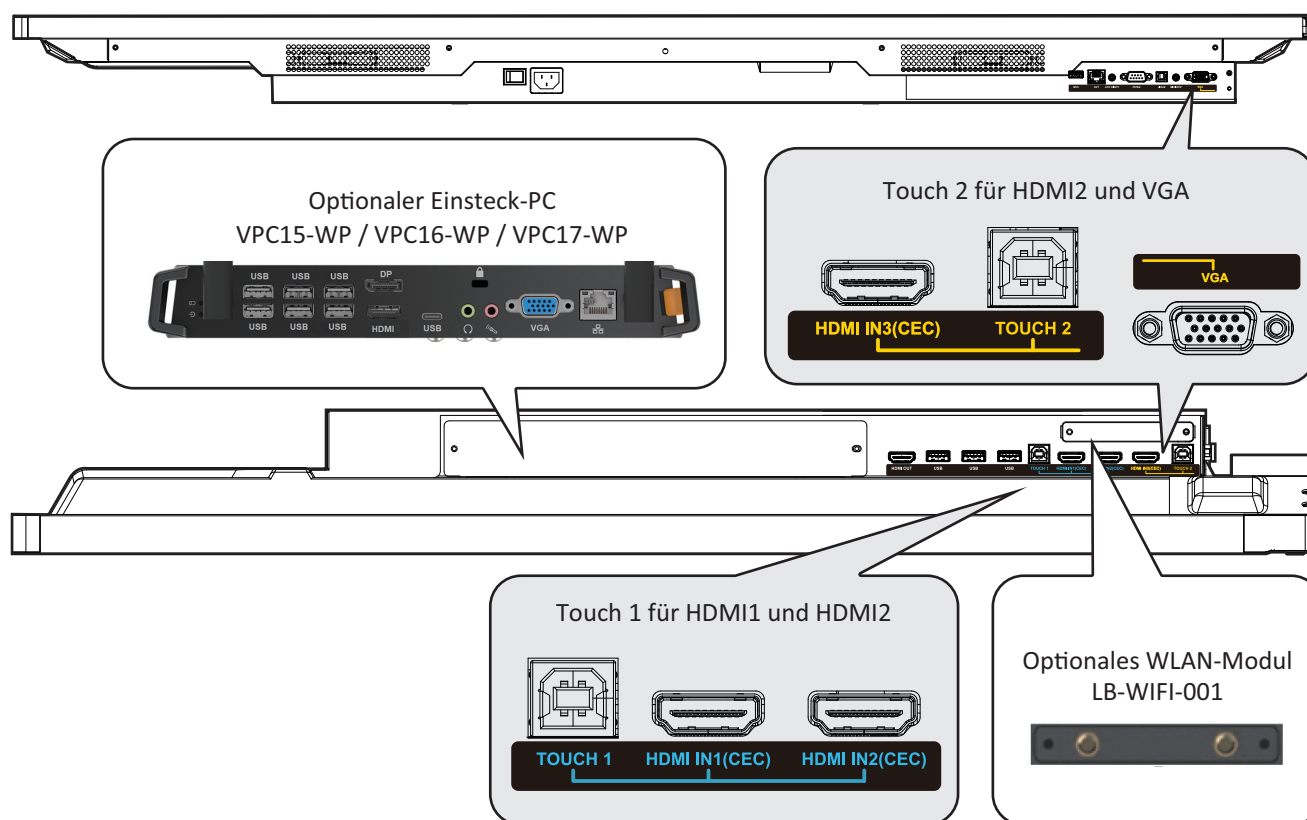



Element	Beschreibung
1	Kurz drücken: Zum Einschalten des Gerätes. Taste zum alleinigen Ein-/Aus-switchen der Anzeigehintergrundbeleuchtung drücken Gedrückt halten: Schaltet das Gerät ab.
2	Zurück zur Hauptschnittstelle des eingebetteten Players
3	Zurück zur vorherigen Ebene des eingebetteten Players
4	Funktionsmenü aufrufen.
5	Verringert die Lautstärke
6	Erhöht die Lautstärke
7	USB-Port für Embedded Player und internen PC
8	Empfängt Signale der Fernbedienung.

> I/O-Anschlüsse



> Übersicht über die Fernbedienung

- 1  Zum Ein- oder Ausschalten der Anzeige drücken
- 2  Stummschaltung ein / aus
- 3 **DISPLAY** Zeigt Informationen zur aktuellen Eingangsquelle.
- 4 **P.MODE** Leeranzeige
- 5 **FREEZE** Bildschirm einfrieren
- 6 **Numeric button** Zifferneingabetaste
- 7 **- / -- / ALT+TAB** Zum Umschalten zwischen PC-Anwendungen.
- 8 **0** Zifferneingabetaste
- 9  / ALT+F4 Aktuelles PC-Fenster schließen
- 10 **INPUT** Quellenauswahl Taste
- 11 **MENU** Zur Anzeige des Menüs drücken
- 12 **RED+ALT** Bildschirmaufnahme
- 13 **GREEN+TAB** PC-Tab-Taste
- 14 **YELLOW+DESKTOP** Zum Einsteck-PC-Desktop wechseln
- 15 **BLUE+BACKSPACE** PC-Backspace-Taste
- 16 **START / D. MENU** PC-Windows-Taste
- 17  / D.TITLE PC-Menü-Taste
- 18  Zum Hochblättern drücken
- 19  Zum Linksblättern drücken
- 20  Zum Rechtsblättern drücken
- 21  Zum Herunterblättern drücken
- 22 **ENTER** Enter-Taste. Zur Auswahl von Optionen drücken.
- 23  / D. USB Scheibsoftware starten
- 24 **ESC / EXIT / D. SETUP** Schnell taste zum Verlassen von Dialogfenstern
- 25 **EPG** Zurück
- 26 **FAV / SPACE** PC-Leertaste
- 27 **CH. + / CH. -** CH +: PC vorherige Seite
CH -: PC nächste Seite
- 28 **VOL+ / VOL-** Lautstärke erhöhen / verringern
- 29 **F1** Windows-F1-Funktion
- 30 **F2** Windows-F2-Funktion
- 31 **F3** Windows-F3-Funktion
- 32 **F4** Windows-F4-Funktion
- 33 **F5** Windows-F5-Funktion
- 34 **F6** Windows-F6-Funktion
- 35 **F7** Windows-F7-Funktion
- 36 **F8** Windows-F8-Funktion
- 37 **F9** Windows-F9-Funktion
- 38 **F10** Windows-F10-Funktion
- 39 **F11** Windows-F11-Funktion
- 40 **F12** Windows-F12-Funktion

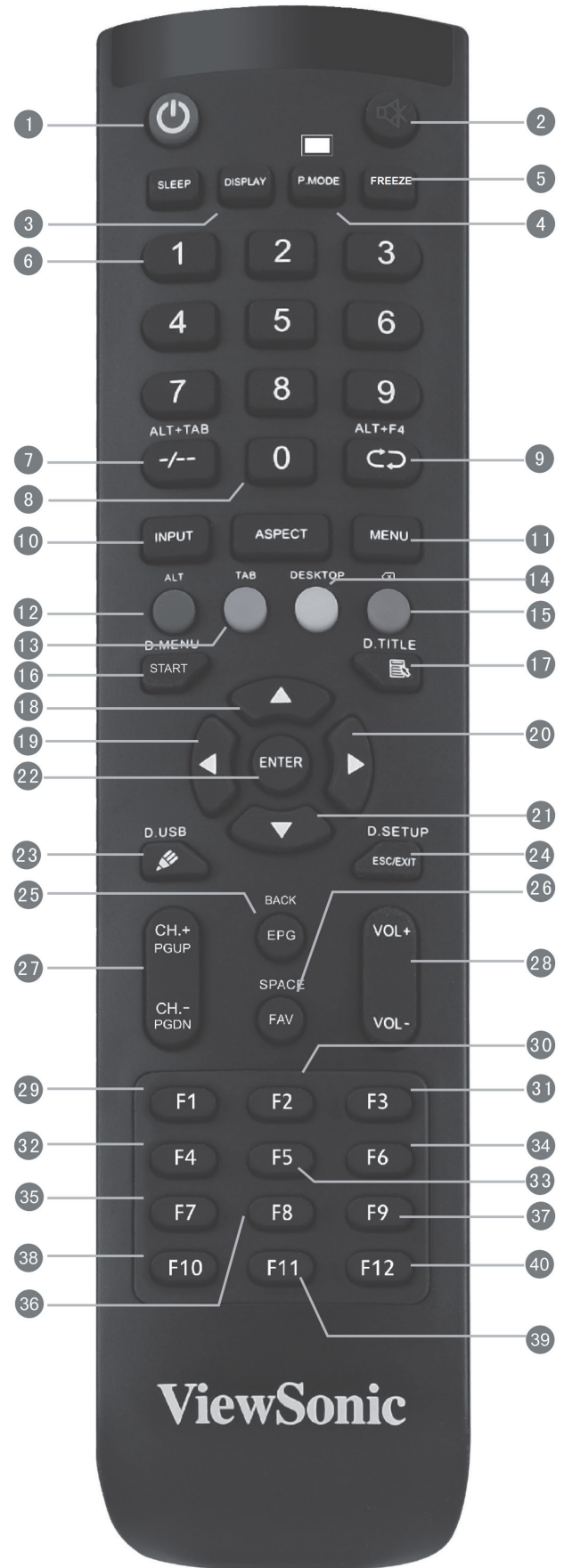

> Einen externen PC anschließen

- Bitte führen Sie die folgenden Schritte aus, wenn Sie Bild und Ton eines externen PCs wiedergeben möchten:

Hinweis: Sie können externe PCs auch per HDMI-Kabel anschließen.

- Verbinden Sie den externen PC über ein (15-poliges) VGA-Kabel mit dem VGA-Eingang (VGA IN) des Displays.
- Schließen Sie den Audioausgang des externen PCs über ein Audiokabel an den Audioeingang (AUDIO IN) des Displays an.

- Verbinden Sie den externen PC per USB-Kabel mit dem Touch-Ausgang (TOUCH OUT) des Displays.

Hinweis: Ein optimales Bild erzielen Sie, wenn Sie am PC 1920 × 1080 als Auflösung einstellen.

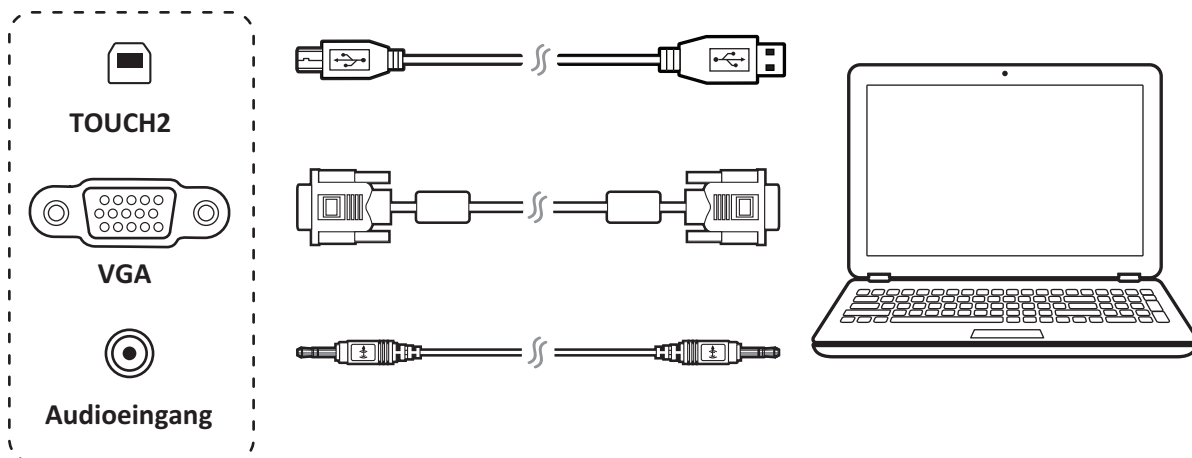

> RS-232-Verbindungen

Wenn Sie Ihr Display über ein serielles RS232-Kabel mit einem externen Computer verbinden, können Sie bestimmte Funktionen per PC steuern – beispielsweise Ein-/Ausschalten, Lautstärkeregelung und mehr.

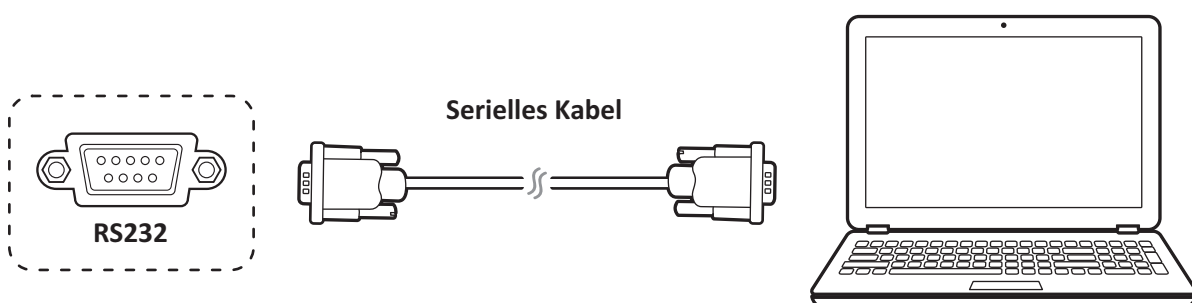

> USB-Peripherie anschließen

1. USB-Peripherie: Verbinden Sie den USB-Stecker des Gerätes mit dem USB-Port (USB IN).
2. Netzwerk- und Modemkabel: Schließen Sie das Router-Kabel an den LAN-Anschluss (LAN IN) an.
3. Mikrofon: Verbinden Sie den Mikrofonstecker mit dem Mikrofoneingang (MIC).

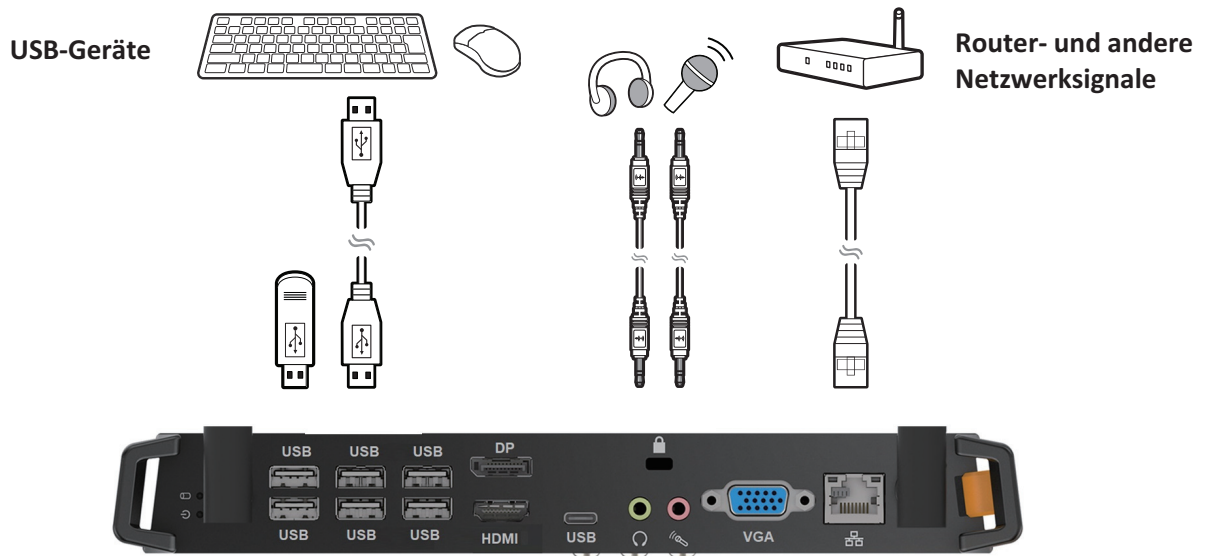

> HDMI-Verbindungen

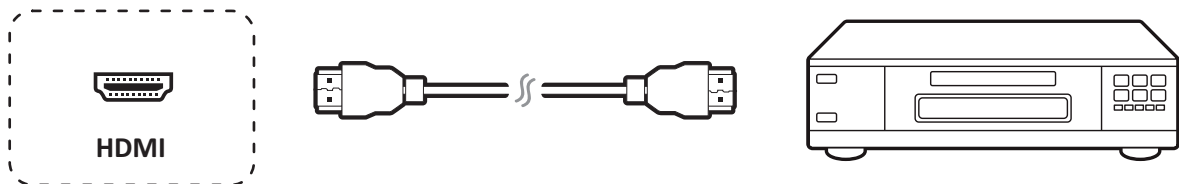

> Mit der Nutzung beginnen

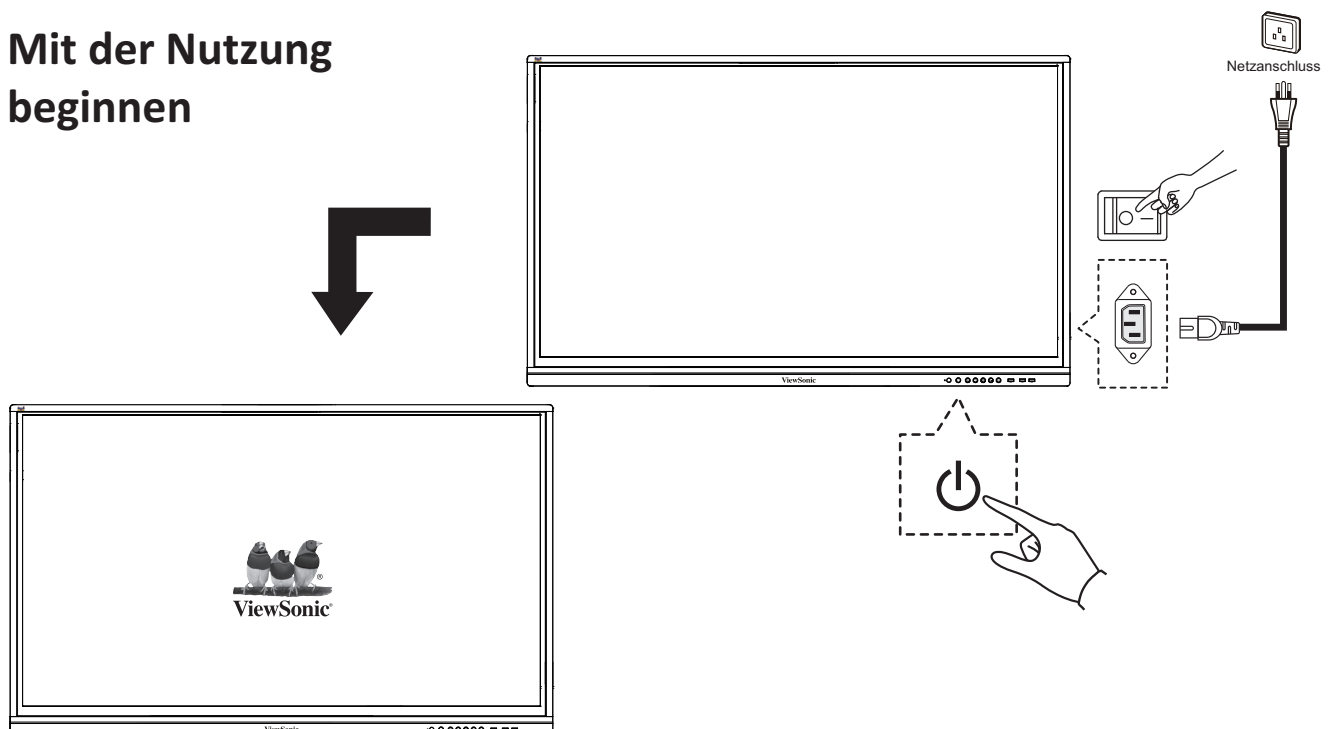



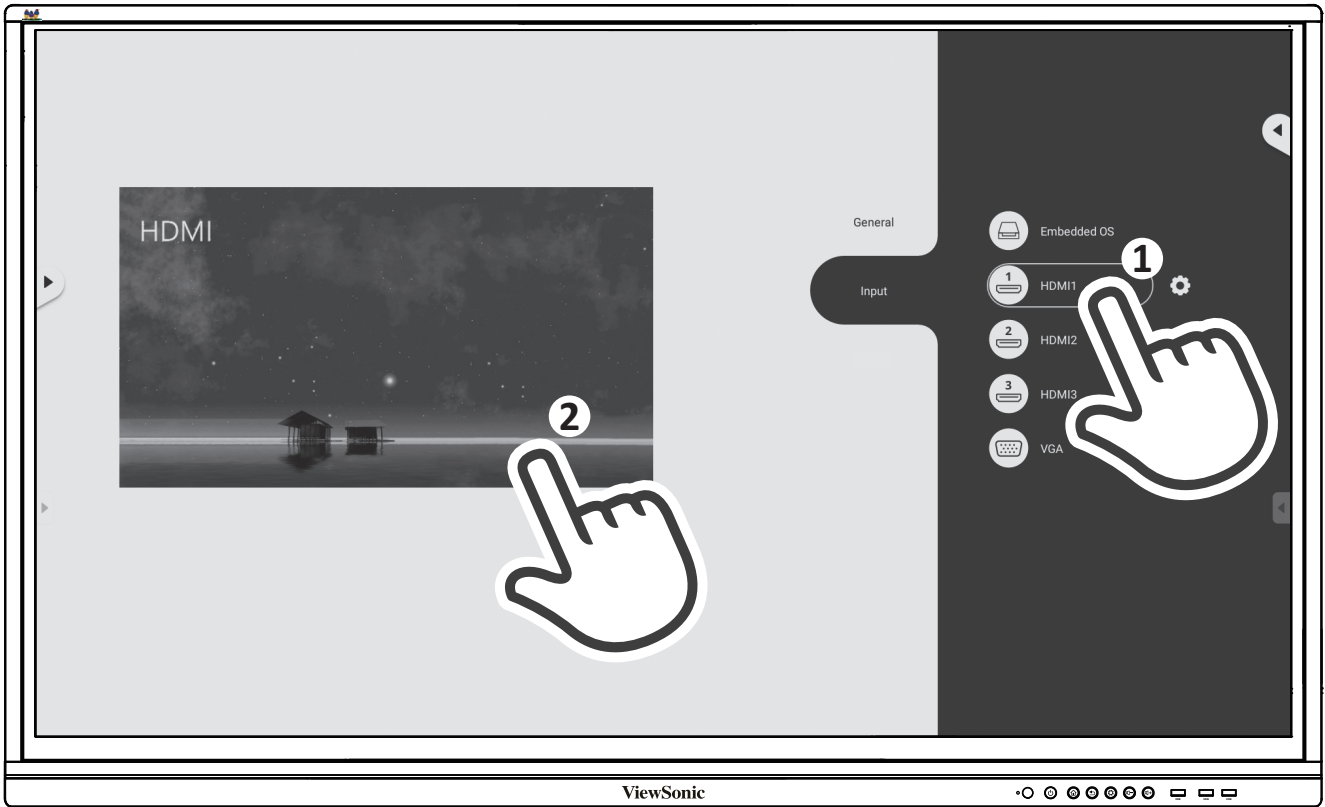
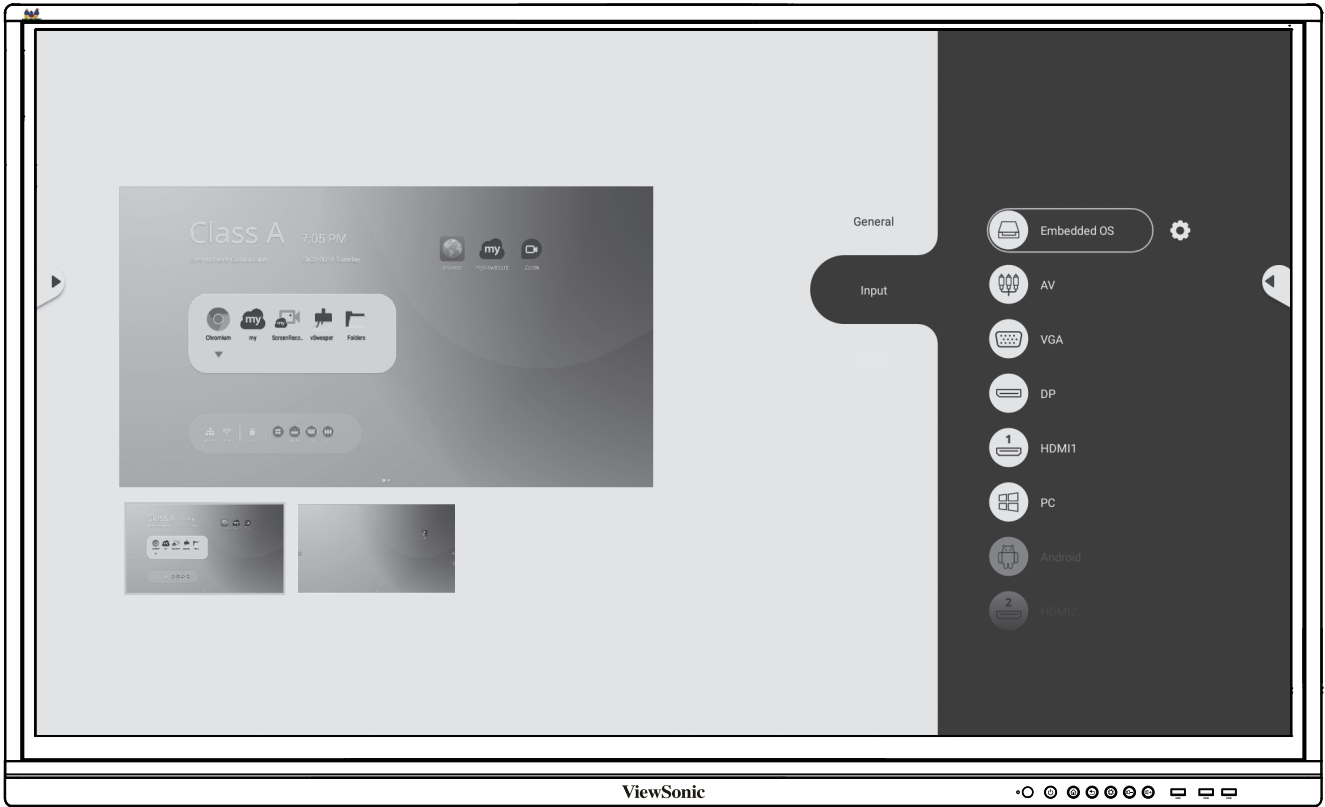

> Konformitätserklärung

FCC-Erklärung: Dieses Gerät erfüllt Teil 15 der FCC-Regularien. Der Betrieb unterliegt den folgenden beiden Voraussetzungen: (1) Dieses Gerät darf keine Störungen verursachen, und (2) dieses Gerät muss jegliche empfangenen Störungen hinnehmen, einschließlich Störungen, die zu unbeabsichtigtem Betrieb führen können.

Konformität mit Industry Canada ICES-003: CAN ICES-3 (B)/NMB-3(B)



ViewSonic Corporation (USA/Kanada/Lateinamerika)



: www.viewsonic.com/support/product-registration



Vereinigte Staaten



1-800-688-6688



customerservice@viewsonic.com

Kanada



1-866-463-4775



customerservice@viewsonic.com

Puerto Rico und Jungferninseln



<http://www.viewsonic.com/la/soporte/servicio-tecnico> (Español)

Lateinamerika



<http://www.viewsonic.com/la/soporte/servicio-tecnico-la/>



ViewSonic-Kundencenter



Optionales Zubehör

> Isi Kemasan

- Kabel daya (dikirim berdasarkan wilayah)
- Remote control
- Baterai AAA x 2
- Kabel USB
- Touch Pen
- Panduan ringkas
- Adaptor RS232
- Kelem x 5
- Pelat Kamera
- Sekrup
- Kabel sinyal yang kompatibel dengan HDMI

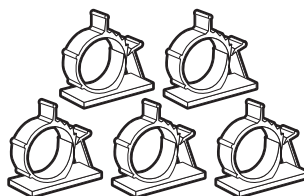
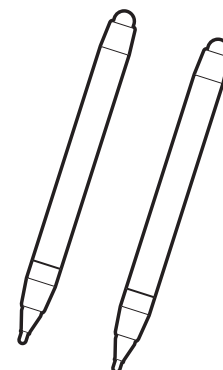
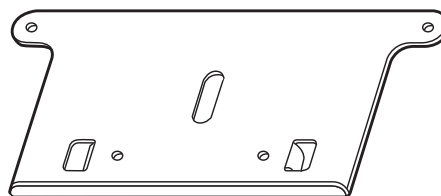
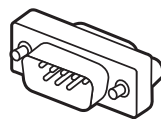
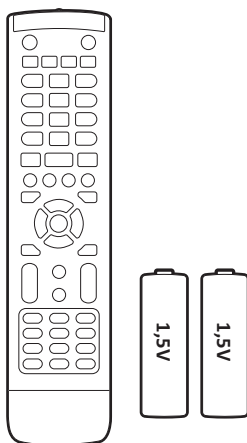
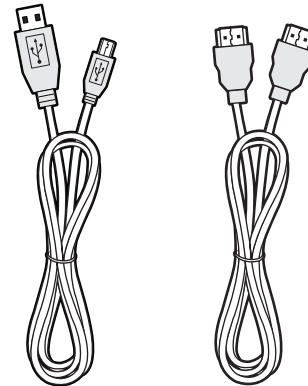
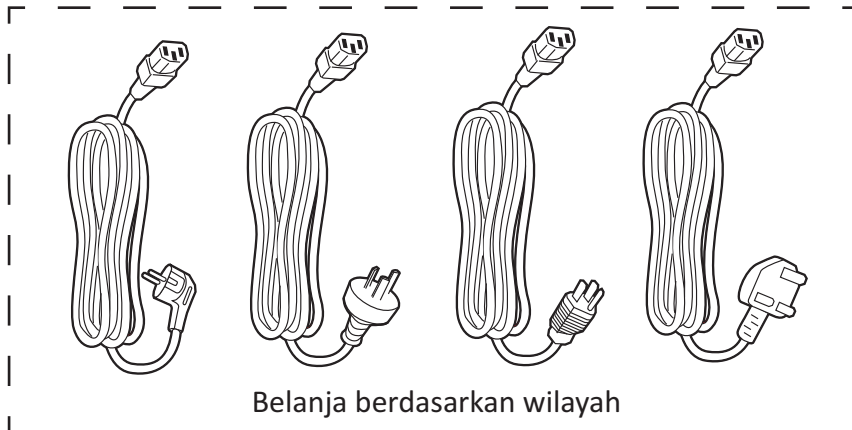

➤ Spesifikasi Kit Pemasangan Dinding (VESA)

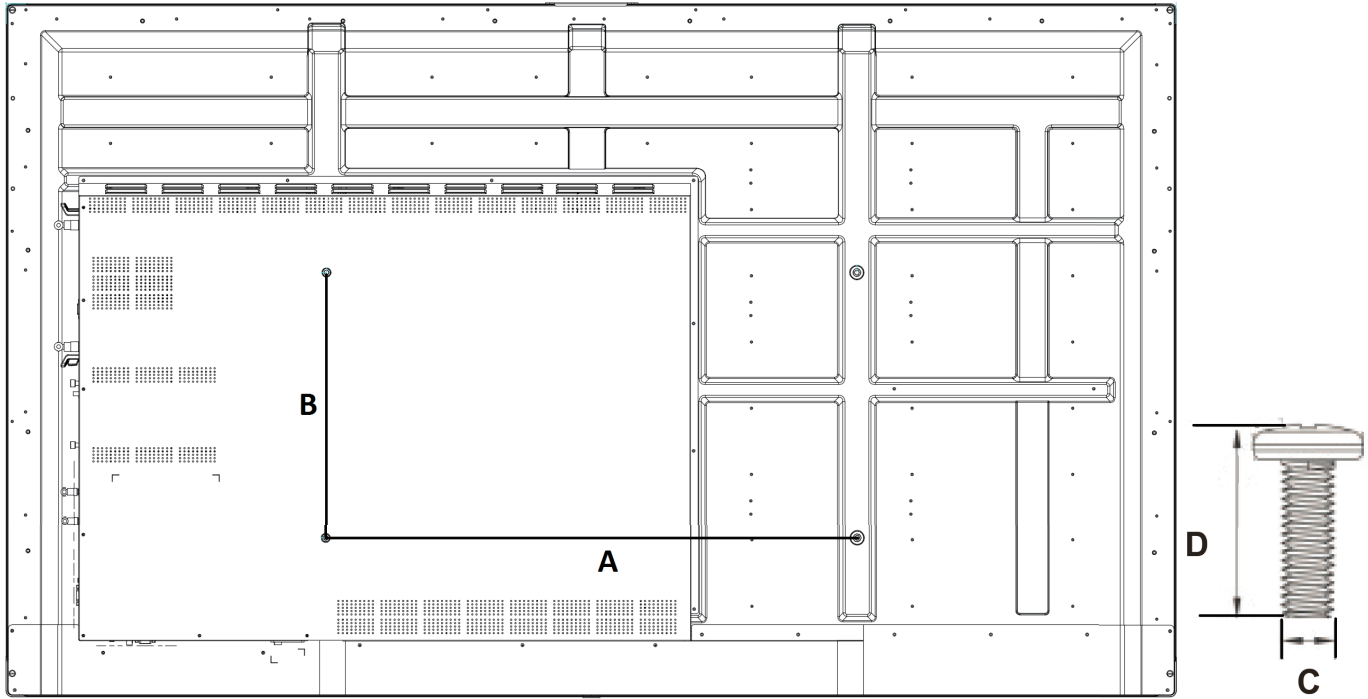

inci	Spek VESA (A x B)	Sekrup Standar (C x D)	Jumlah
IFP5550 - 55"	400 x 200 mm	M8 x 25 mm	4
IFP6550 - 65"	600 x 400 mm	M8 x 25 mm	4
IFP7550 - 75"	800 x 400 mm	M8 x 25 mm	4
IFP8650 - 86"	800 x 600 mm	M8 x 25 mm	4

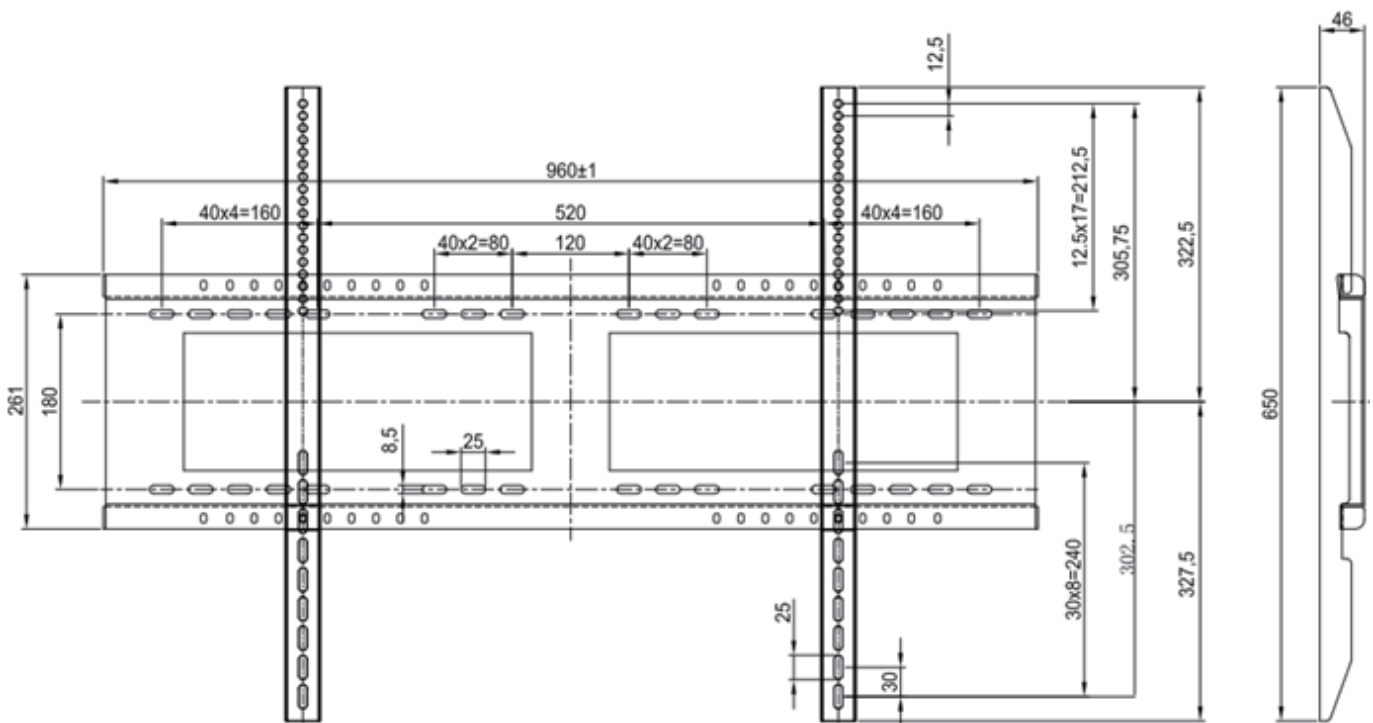

> Perhatian Lingkungan Pemasangan

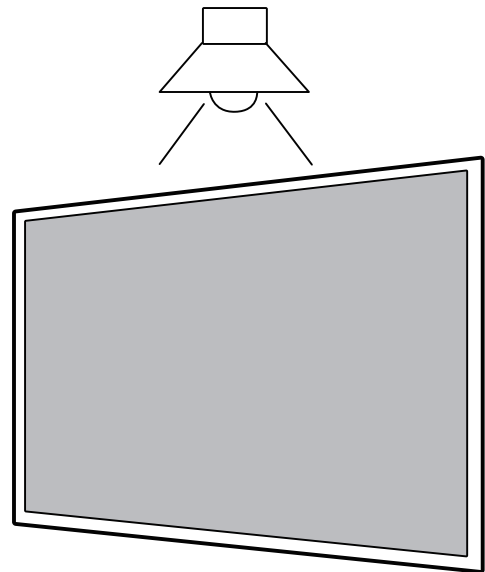
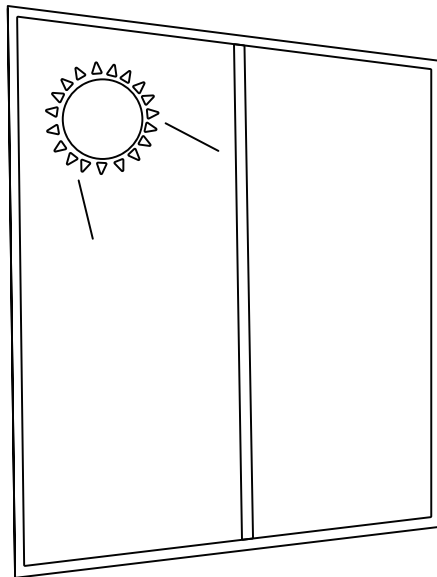
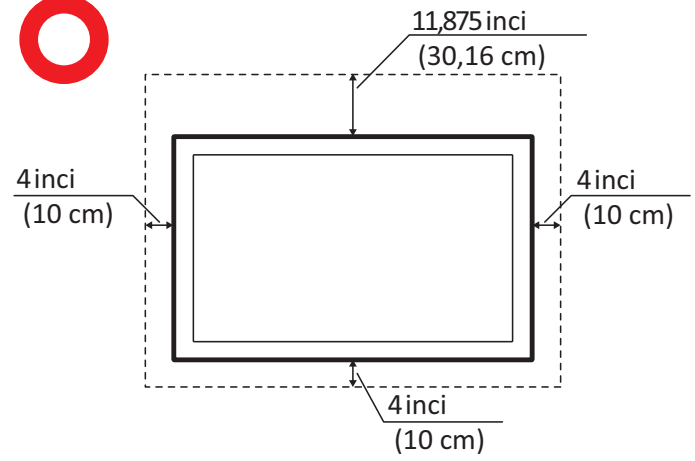
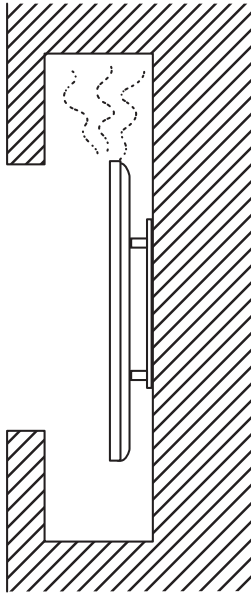

> Ikhtisar Panel Kontrol

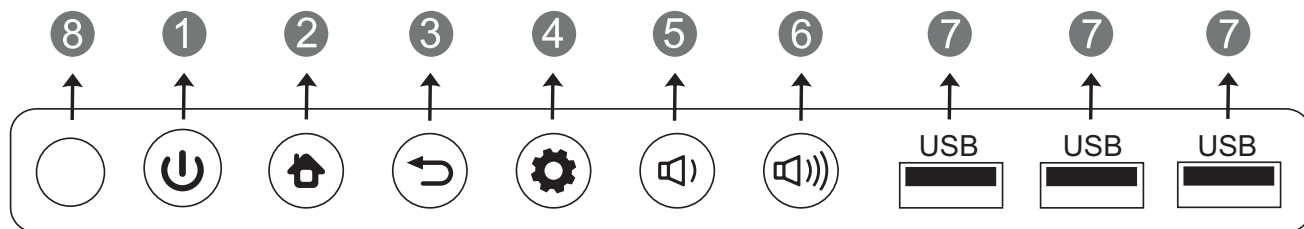



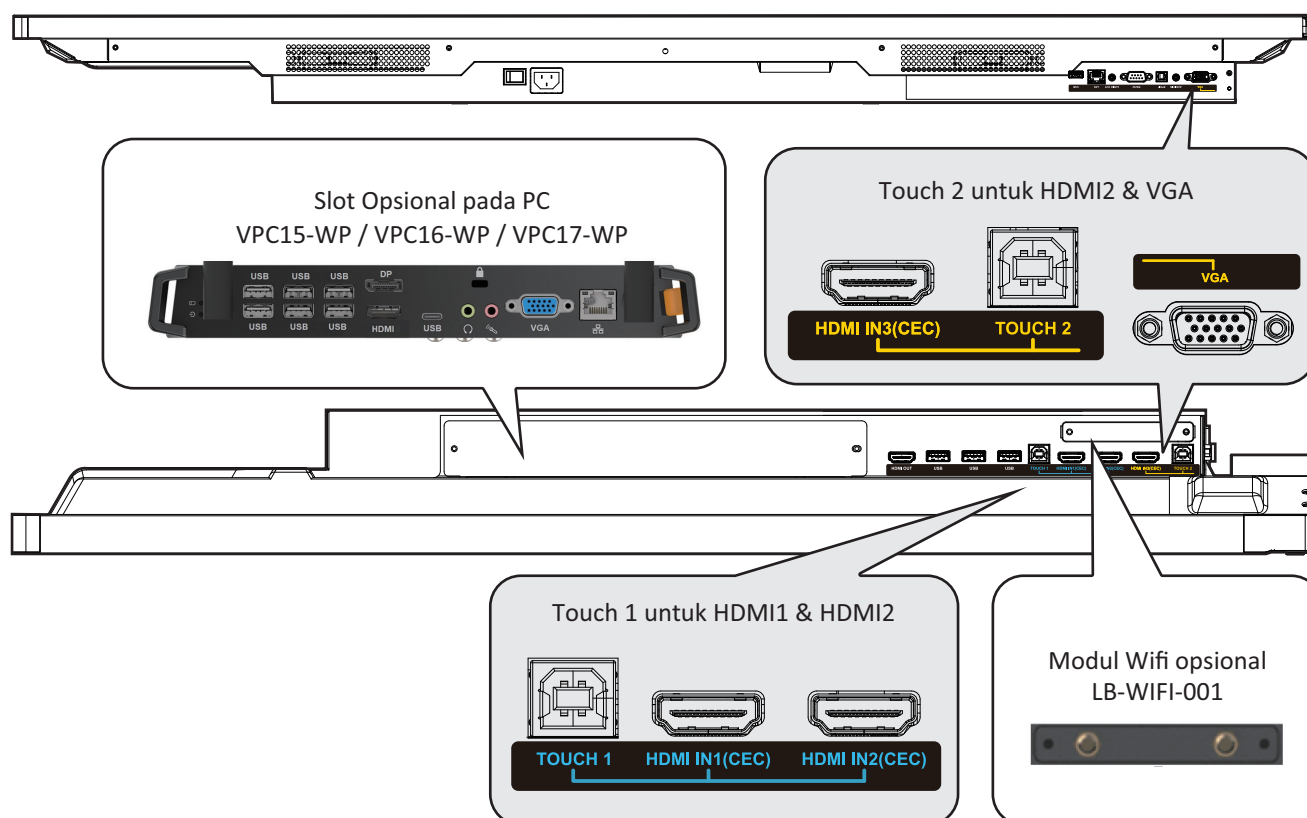

Item	Keterangan
1	Tekan tombol untuk menghidupkan perangkat Tekan tombol untuk mematikan/menghidupkan lampu latar layar saja Tekan lalu tahan tombol untuk menonaktifkan perangkat
2	Mundur ke antarmuka utama pemutar Tertanam
3	Kembali ke tingkat sebelumnya pemutar Tertanam
4	Panggil menu fungsi
5	Memperkecil volume
6	Memperbesar volume
7	Port USB untuk Pemutar Tertanam dan PC internal
8	Menerima sinyal dari remote control

> Port I/O



➤ Ikhtisar Remote Control

- | | |
|--|---|
| 1  | 22 ENTER |
| Tekan untuk MENGHIDUPKAN/
MEMATIKAN layar | Tombol Enter. Tekan untuk
memilih pilihan. |
| 2  | 23  / D. USB |
| Senyap/Tidak senyap | Startup software menulis |
| 3 DISPLAY | 24 ESC / EXIT / D. SETUP |
| Menampilkan informasi sumber
input saat ini | Tombol pintasan untuk keluar
dari kotak dialog |
| 4 P.MODE | 25 EPG |
| Layar kosong | Kembali |
| 5 FREEZE | 26 FAV / SPACE |
| Bekukan layar | Tombol 'Spasi' PC |
| 6 Numeric button | 27 CH. + / CH. - |
| Layar hitam | CH+ : Halaman sebelumnya PC
CH- : Halaman berikutnya PC |
| 7 - / -- / ALT+TAB | 28 VOL+ / VOL- |
| Tekan untuk beralih aplikasi PC | Memperbesar/Memperkecil
volume suara |
| 8 0 | 29 F1 |
| Layar hitam | Fungsi F1 Windows |
| 9  / ALT+F4 | 30 F2 |
| Tutup jendela PC saat ini | Fungsi F2 Windows |
| 10 INPUT | 31 F3 |
| Tombol pemilihan sumber | Fungsi F3 Windows |
| 11 MENU | 32 F4 |
| Tekan untuk menampilkan Menu | Fungsi F4 Windows |
| 12 RED+ALT | 33 F5 |
| Screen capture (Rekaman layar) | Fungsi F5 Windows |
| 13 GREEN+TAB | 34 F6 |
| Tombol 'Tab' PC | Fungsi F6 Windows |
| 14 YELLOW+DESKTOP | 35 F7 |
| Pindah ke desktop PC slot-in | Fungsi F7 Windows |
| 15 BLUE+BACKSPACE | 36 F8 |
| Tombol 'Backspace' PC | Fungsi F8 Windows |
| 16 START / D. MENU | 37 F9 |
| Tombol 'Windows' PC | Fungsi F9 Windows |
| 17  / D.TITLE | 38 F10 |
| Tombol 'Menu' PC | Fungsi F10 Windows |
| 18 ▲ | 39 F11 |
| Tekan untuk menggulir ke atas | Fungsi F11 Windows |
| 19 ◀ | 40 F12 |
| Tekan untuk menggulir ke kiri | Fungsi F12 Windows |
| 20 ▶ | |
| Tekan untuk menggulir ke kanan | |
| 21 ▼ | |
| Tekan untuk menggulir ke bawah | |

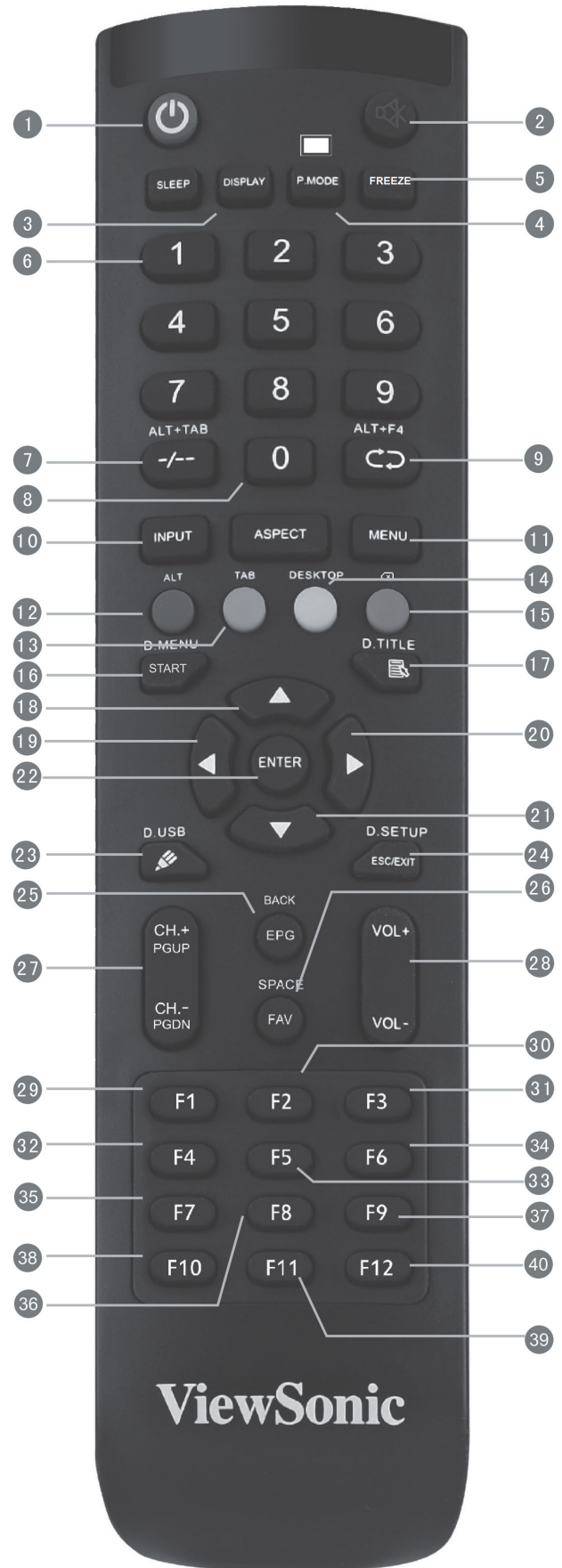

> Menyambungkan PC Eksternal

1. Untuk menampilkan video dan suara dari PC eksternal, ikuti petunjuk di bawah ini:

Catatan: PC Eksternal juga bisa disambungkan ke layar melalui kabel HDMI.

- Sambungkan kabel VGA (15-pin) dari PC eksternal Anda ke port VGA IN pada layar.
- Sambungkan kabel audio dari port AUDIO OUT pada PC eksternal Anda ke port AUDIO IN pada layar.

2. Sambungkan kabel USB ke PC eksternal dari port TOUCH OUT layar.

Catatan: Untuk hasil yang optimal, pilih 1920x1080p sebagai resolusi input komputer eksternal.

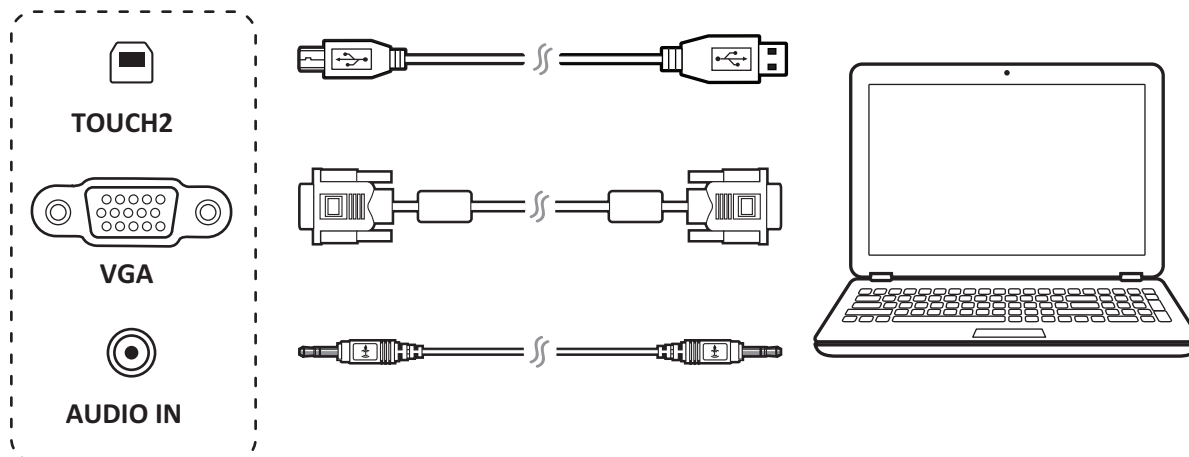

> Sambungan RS232

Ketika Anda menggunakan kabel port seri RS232 untuk menyambungkan layar Anda ke komputer eksternal, fungsi-fungsi tertentu bisa dikendalikan oleh PC, termasuk daya hidup/mati, pengaturan volume, dan banyak lagi.

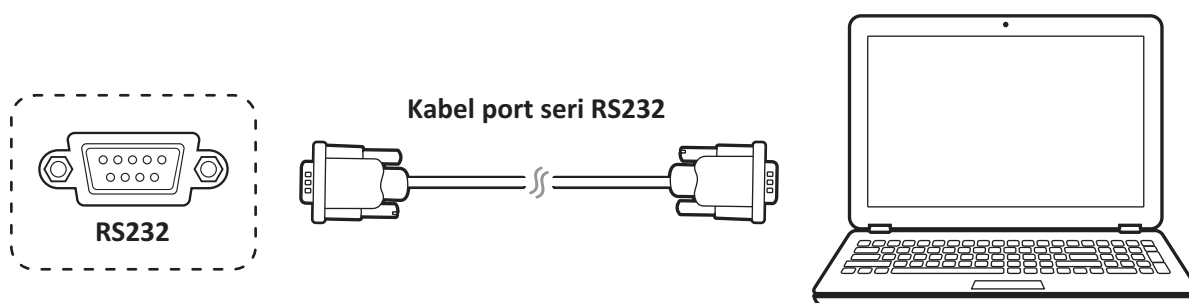

> Menyambungkan Periferal USB

1. Periferal USB: Colokkan kabel perangkat USB ke port USB IN.
2. Kabel jaringan dan modem Colokkan kabel router ke port LAN IN.
3. Mikrofon: Colokkan kabel mikrofon ke port MIC.

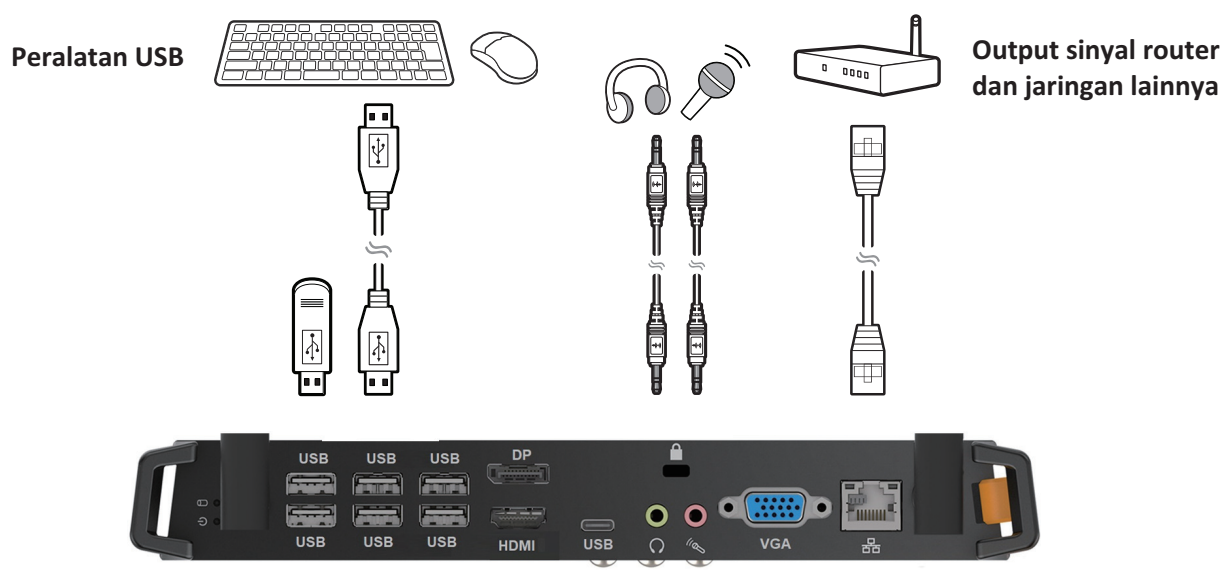

> Sambungan HDMI

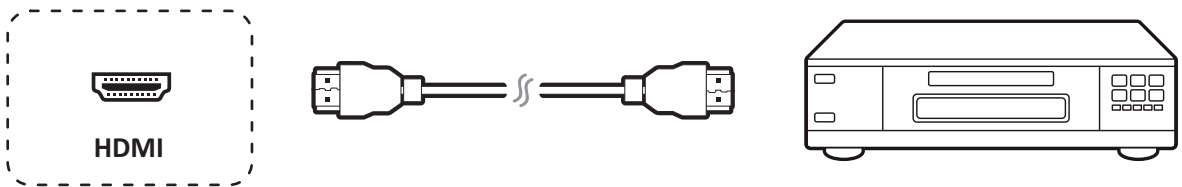

> Mulai Menggunakan

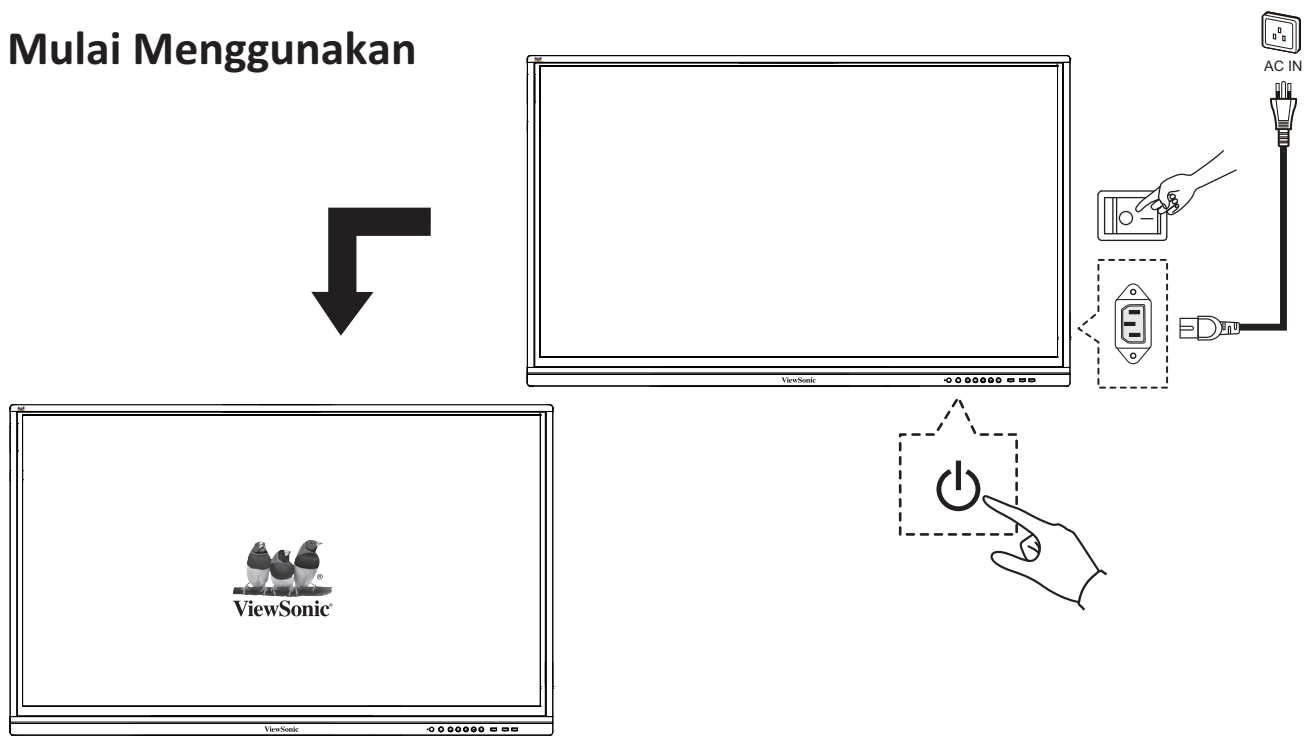



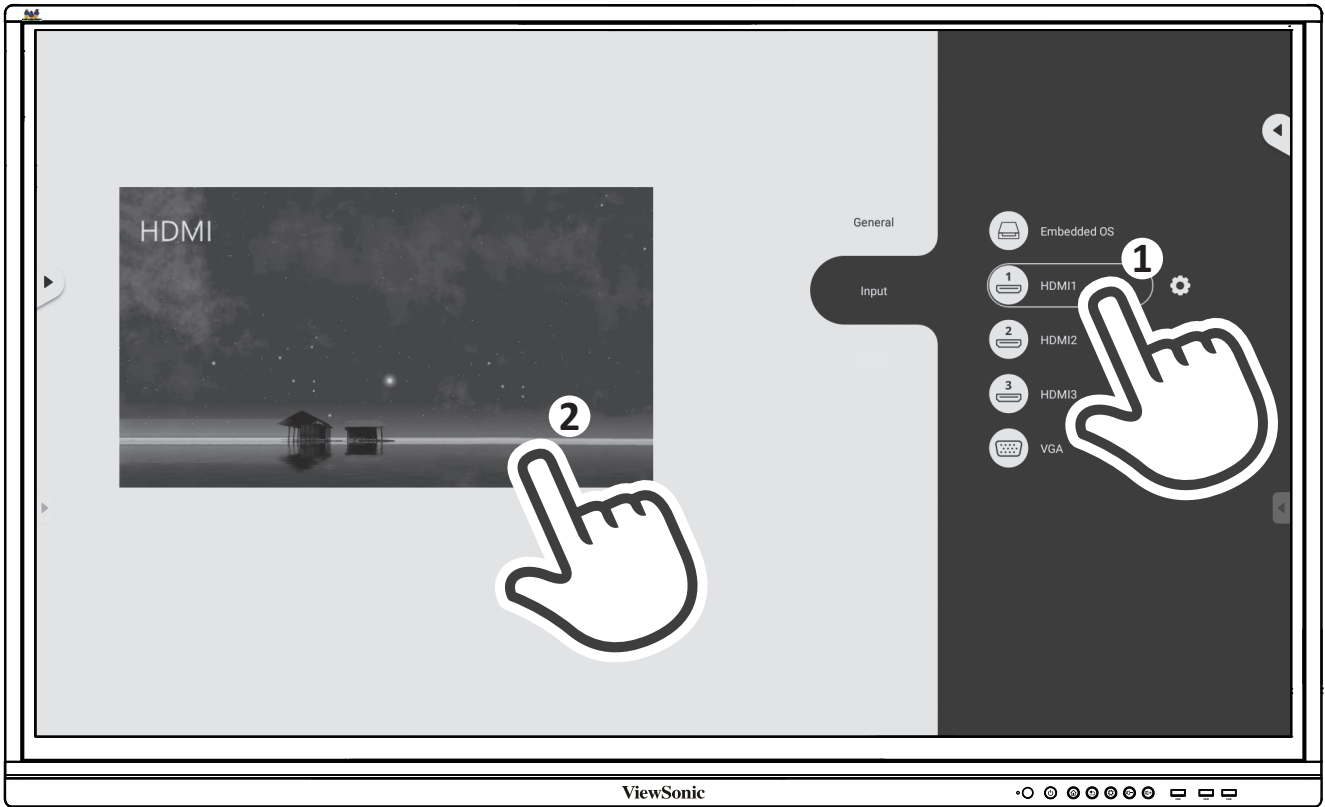
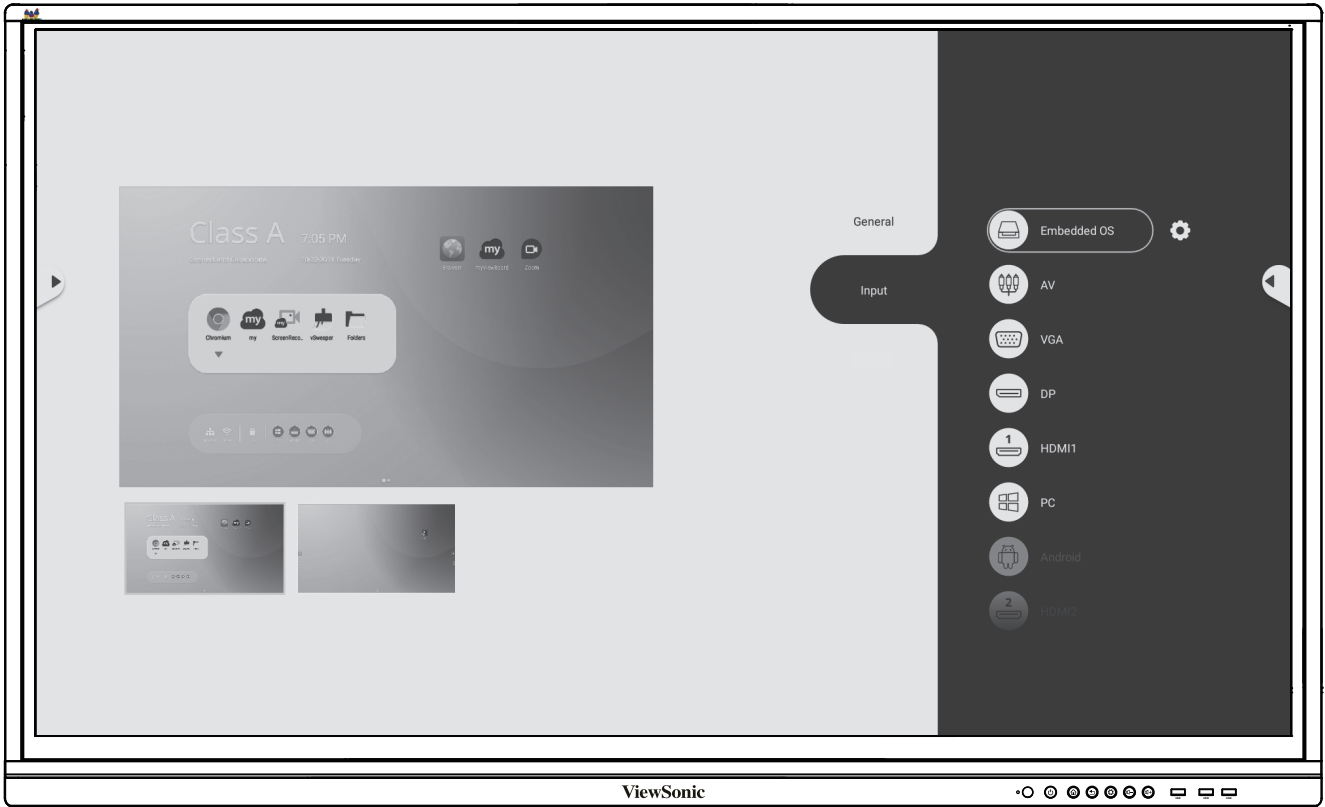

> Pernyataan Kesesuaian

Pernyataan Kesesuaian FCC: Perangkat ini sesuai dengan pasal 15 Peraturan FCC. Pengoperasian harus memenuhi dua kondisi sebagai berikut: (1) perangkat ini tidak boleh menimbulkan interferensi berbahaya, dan (2) perangkat ini harus menerima semua interferensi yang ditangkap, termasuk interferensi yang dapat mengakibatkan pengoperasian yang tidak diinginkan.

Kepatuha terhadap Industry Canada ICES-003: CAN ICES-3 (B)/NMB-3(B)



ViewSonic Corporation (A.S./Kanada/Amerika Latin)

 : www.viewsonic.com/support/product-registration



Amerika Serikat

 1-800-688-6688

 customerservice@viewsonic.com

Kanada

 1-866-463-4775

 customerservice@viewsonic.com

Puerto Riko & Kepulauan Virgin

 <http://www.viewsonic.com/la/soporte/servicio-tecnico> (Español)

Amerika Latin

 <http://www.viewsonic.com/la/soporte/servicio-tecnico-la/>



Pusat Dukungan ViewSonic



Aksesori Tambahan

Hak Cipta © 2020 ViewSonic Corporation. Semua hak dilindungi undang-undang.

IFP50-3 series_QSG_1b_IND_20200210

> Innholdet i pakken

- Strømkabel (i henhold til område)
- Fjernkontroll
- AAA-batteri x 2
- USB-kabel
- Berøringspenn
- Hurtigstartveiledning
- RS232-adapter
- Klemme x 5
- Kameraplate
- Skruer
- Signalkabel kompatibel med HDMI

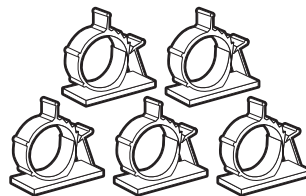
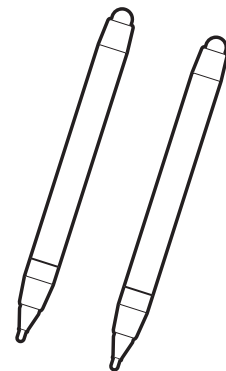
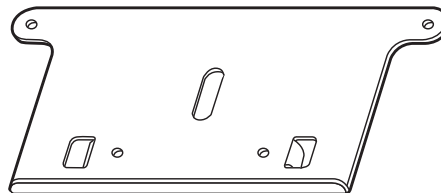
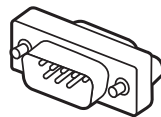
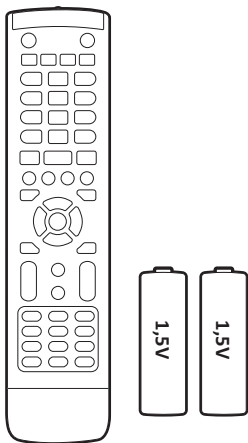
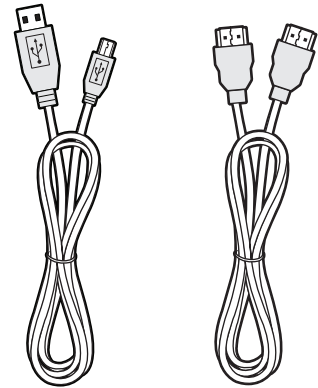
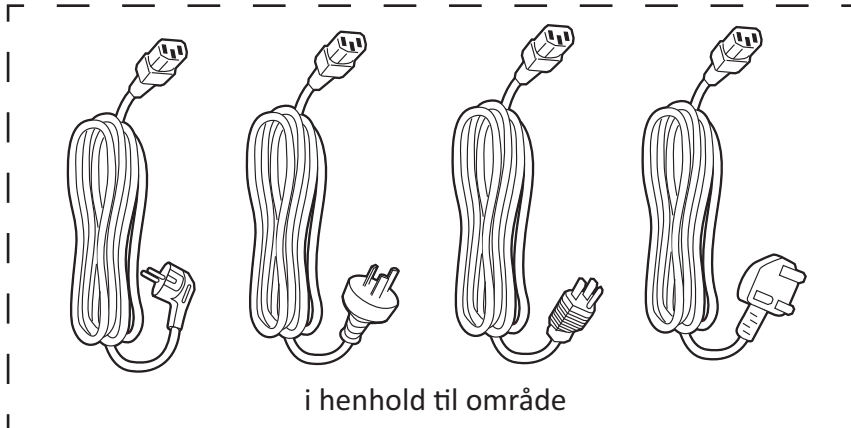

➤ Spesifikasjoner for veggmonteringssett (VESA)

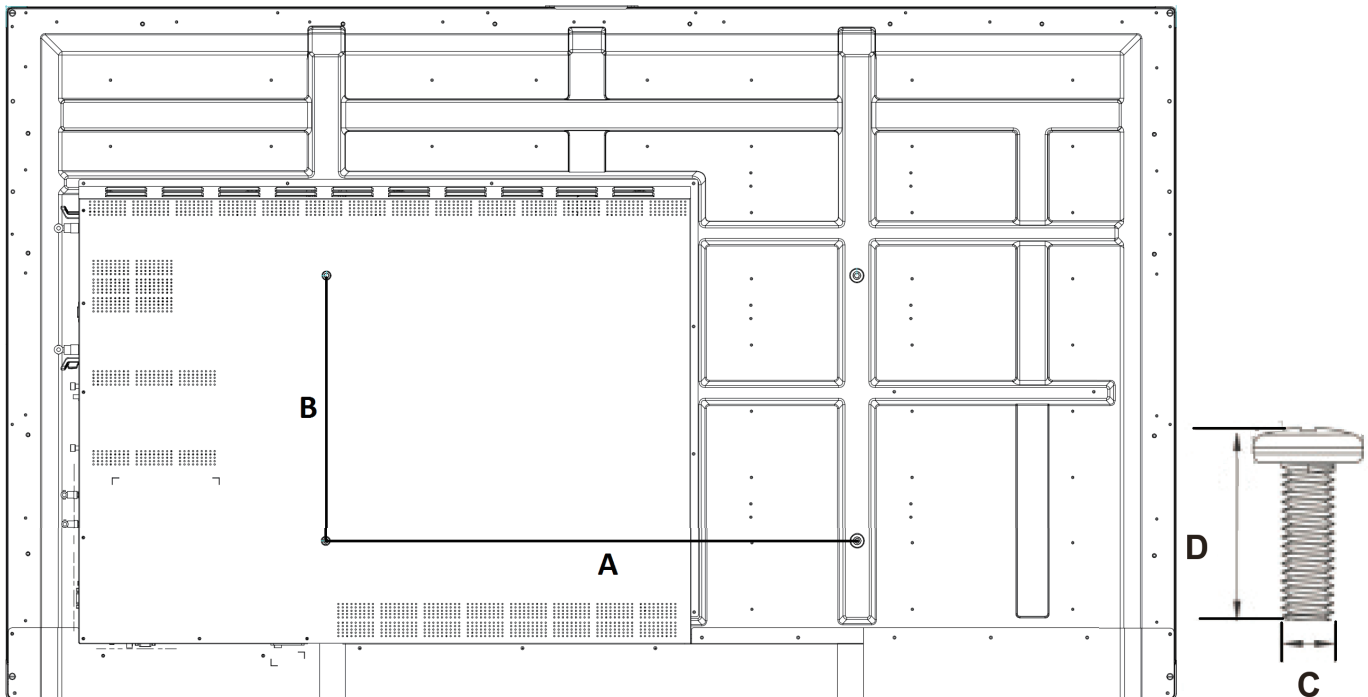

tomme	VESA-spes. (A x B)	Standardskrue (C x D)	Antall
IFP5550 - 55"	400 x 200 mm	M8 x 25 mm	4
IFP6550 - 65"	600 x 400 mm	M8 x 25 mm	4
IFP7550 - 75"	800 x 400 mm	M8 x 25 mm	4
IFP8650 - 86"	800 x 600 mm	M8 x 25 mm	4

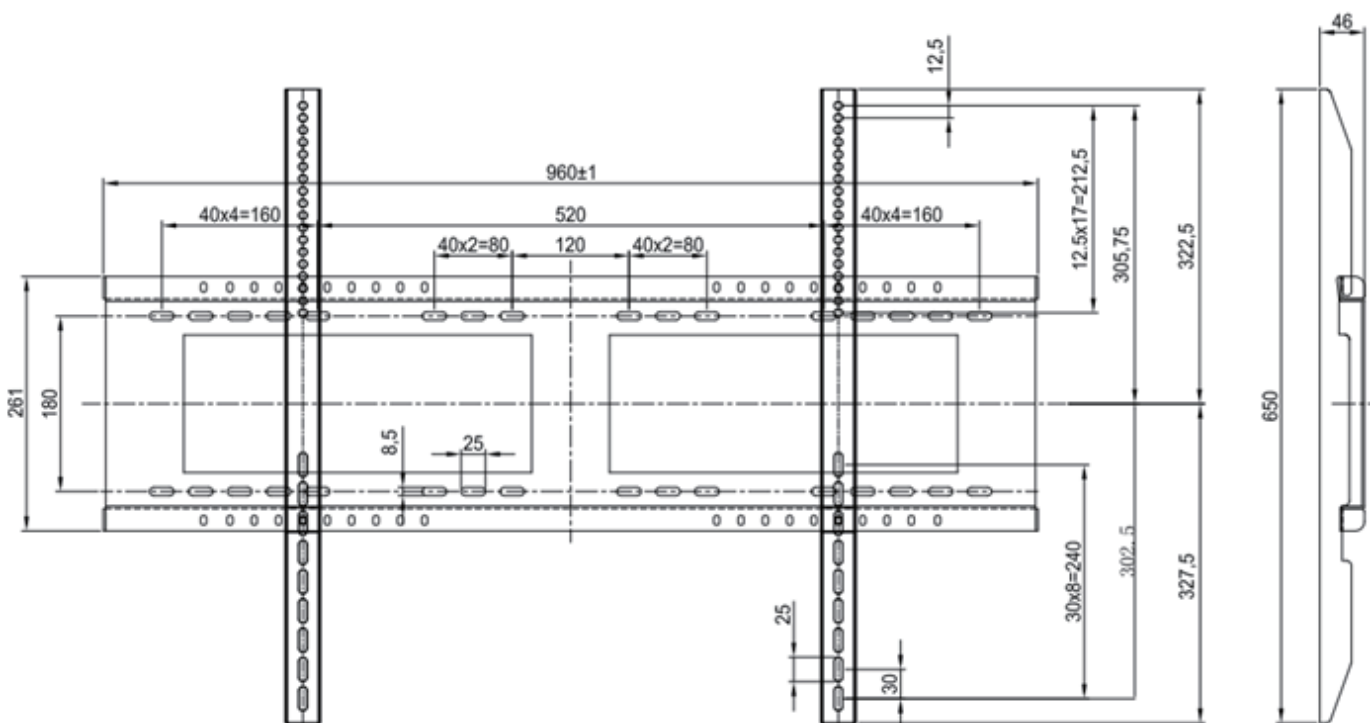

> Obs om installasjonsmiljø

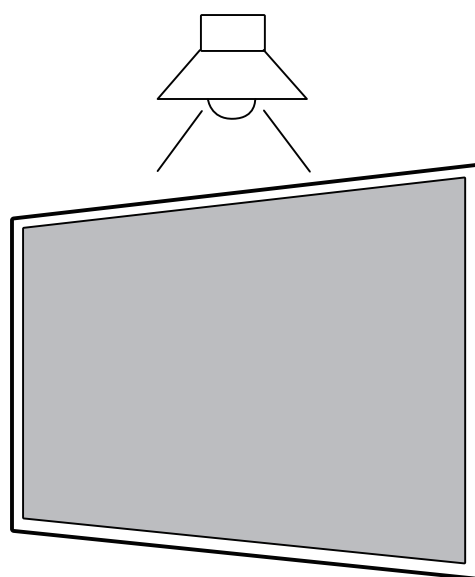
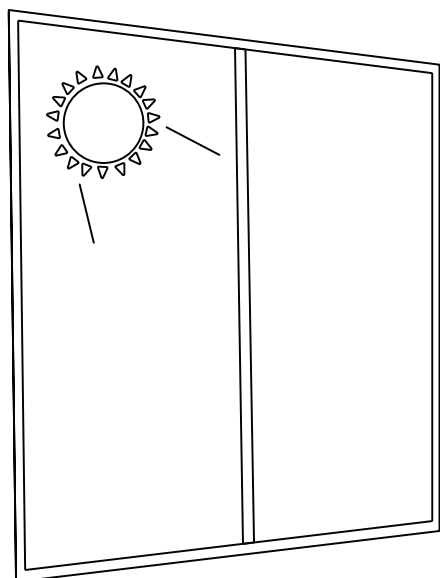
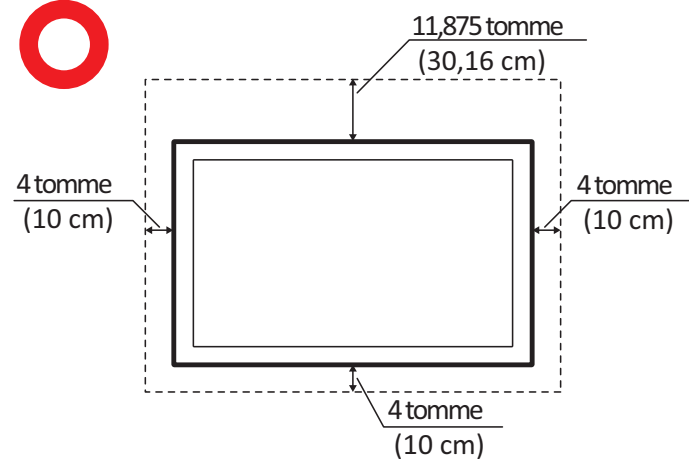
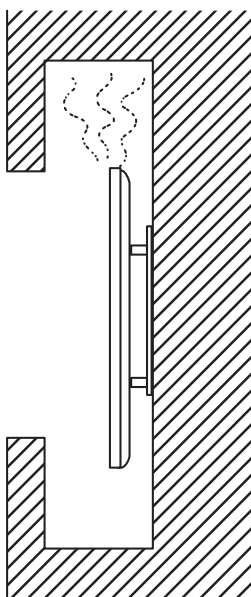

> Oversikt over kontrollpanel

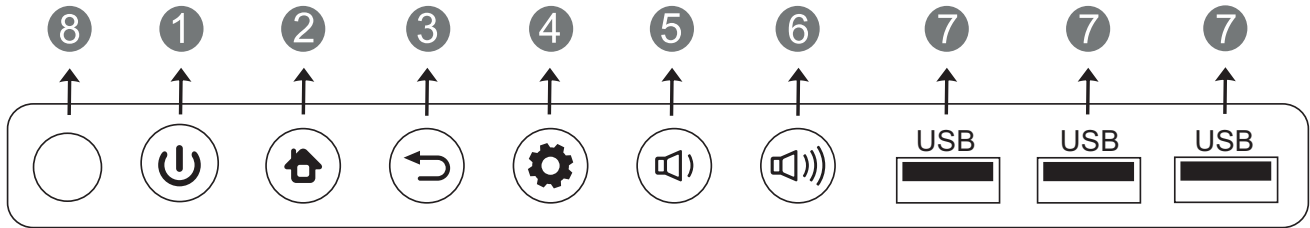





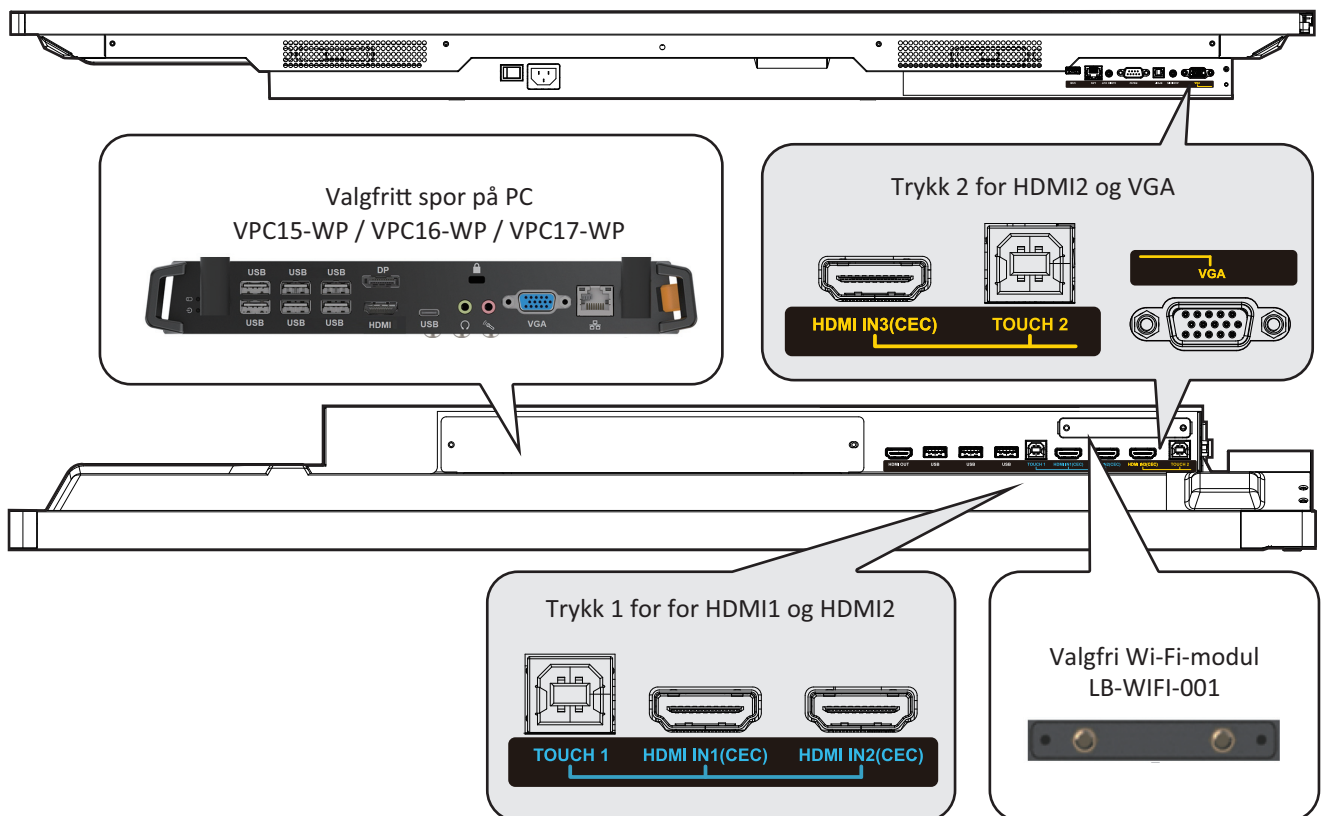



Element	Beskrivelse
1	Trykk knappen for å slå på enheten Trykk knappen for bare å slå av/på baklyset på skjermen Trykk og hold inne knappen for å slå av enheten
2	Gå tilbake til hovedgrensesnittet til den innebygde spilleren
3	Gå tilbake til forrige nivå til den innebygde spilleren
4	Hent funksjonsmeny
5	Reduser volum
6	Øk volum
7	USB-port for innebygd spiller og intern PC
8	Mottar signaler fra fjernkontrollen

> I/U-port



➤ Oversikt over fjernkontroll

- | | |
|--|---|
| 1  | 22 ENTER |
| Trykk for å slå skjermen PÅ/AV | Enter-knapp. Trykk for å velge alternativer. |
| 2  | 23  / D. USB |
| Demp / Slå av demping | Start skriveprogramvare |
| 3 DISPLAY | 24 ESC / EXIT / D. SETUP |
| Vis informasjon om gjeldende inngangskilde | Snarveisknapp for å avslutte dialogbokser |
| 4 P.MODE | 25 EPG |
| Tøm skjerm | Tilbake |
| 5 FREEZE | 26 FAV / SPACE |
| Frys skjerm | PC «Mellomrom»-knapp |
| 6 Numeric button | 27 CH. + / CH. - |
| Tallknapper | Kanal +: PC forrige side |
| 7 - / -- / ALT+TAB | Kanal -: PC neste side |
| Trykk for å veksle mellom PC-programmer | 28 VOL+ / VOL- |
| 8 0 | Øk/senk volumet |
| Tallknapper | 29 F1 |
| 9  / ALT+F4 | Windows F1-funksjon |
| Lukk gjeldende PC-vindu | 30 F2 |
| 10 INPUT | Windows F2-funksjon |
| Kildevalg-knapp | 31 F3 |
| 11 MENU | Windows F3-funksjon |
| Trykk for å vise meny | 32 F4 |
| 12 RED+ALT | Windows F4-funksjon |
| Skjermopptak | 33 F5 |
| 13 GREEN+TAB | Windows F5-funksjon |
| PC «Tab»-knapp | 34 F6 |
| 14 YELLOW+DESKTOP | Windows F6-funksjon |
| Bytt til spor på PC-skrivebordet | 35 F7 |
| 15 BLUE+BACKSPACE | Windows F7-funksjon |
| PC «Backspace»-knapp | 36 F8 |
| 16 START / D. MENU | Windows F8-funksjon |
| PC «Windows»-knapp | 37 F9 |
| 17  / D.TITLE | Windows F9-funksjon |
| PC «Meny»-knapp | 38 F10 |
| 18  | Windows F10-funksjon |
| Trykk for å rulle opp | 39 F11 |
| 19  | Windows F11-funksjon |
| Trykk for å rulle til venstre | 40 F12 |
| 20  | Windows F12-funksjon |
| Trykk for å rulle til høyre | |
| 21  | |
| Trykk for å rulle ned | |

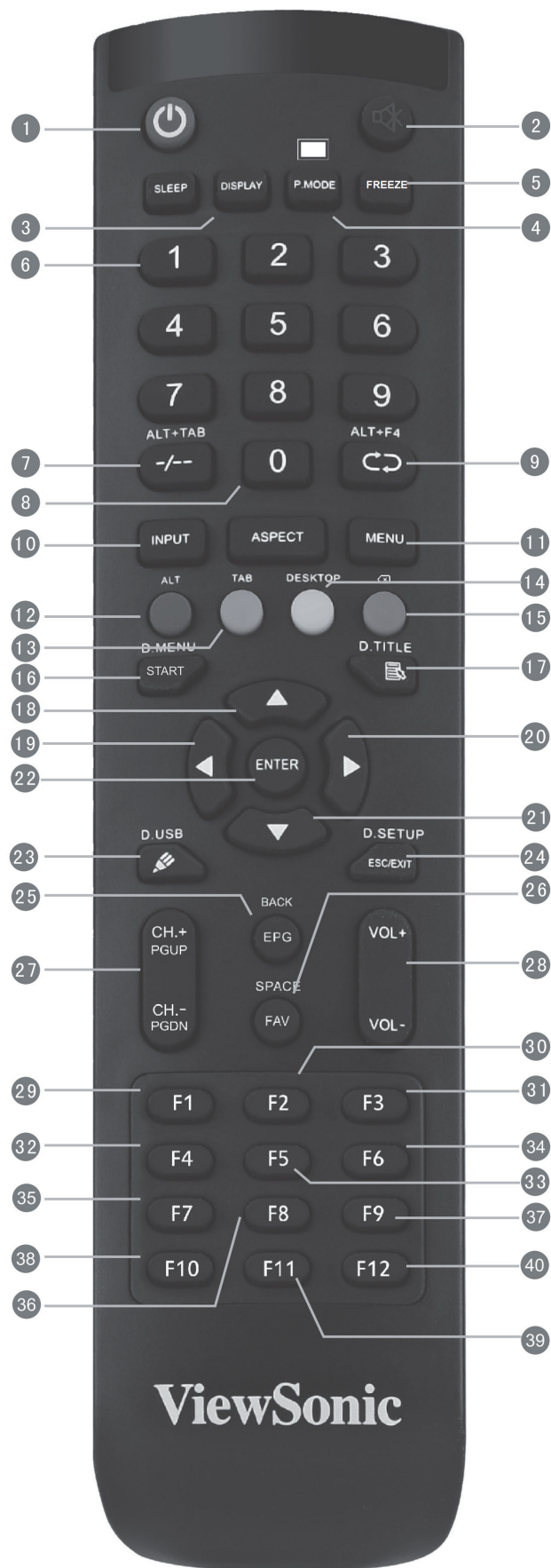

> Koble til en ekstern PC

1. Følg instruksjonene nedenfor for å vise video og lyd fra en ekstern PC:

Merk: Eksterne PC-er kan også kobles til skjermen via HDMI-kabel.

- Koble en VGA-kabel (15-pinner) fra den eksterne PC-en til VGA IN-porten på skjermen.
- Koble en lyd kabel fra AUDIO OUT-porten på den eksterne PC-en til AUDIO IN-porten på skjermen.

2. Koble en USB-kabel til den eksterne PC-en fra TOUCH OUT-porten på skjermen.

Merk: For best resultat velger du 1920x1080p som inngangssoppløsning på den eksterne datamaskinen.

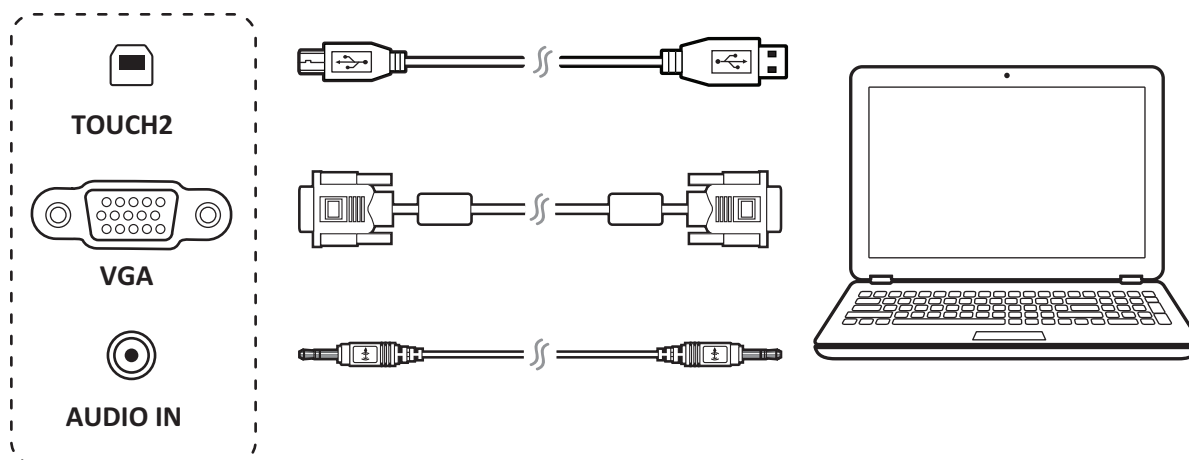

> RS232-tilkoblinger

Når du bruker en RS232-seriellportkabel for å koble skjermen til en ekstern datamaskin, kan noen funksjoner styres av PC-en, inkludert strøm på/av, volumjustering og mer.

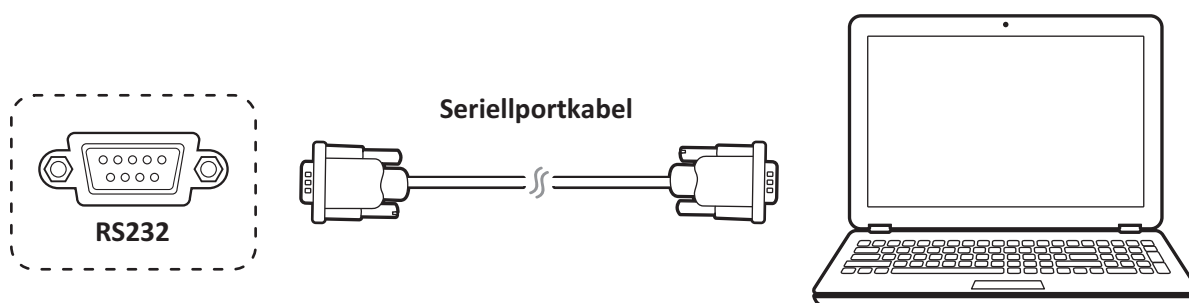

> Koble til USB-utstyr

1. USB-utstyr: Sett kabelen til USB-enheten i USB IN-porten.
2. Nettverks- og modemkabler: Sett ruterkabelen inn i LAN IN-porten.
3. Mikrofon: Sett mikrofonkabelen inn i MIC-porten.

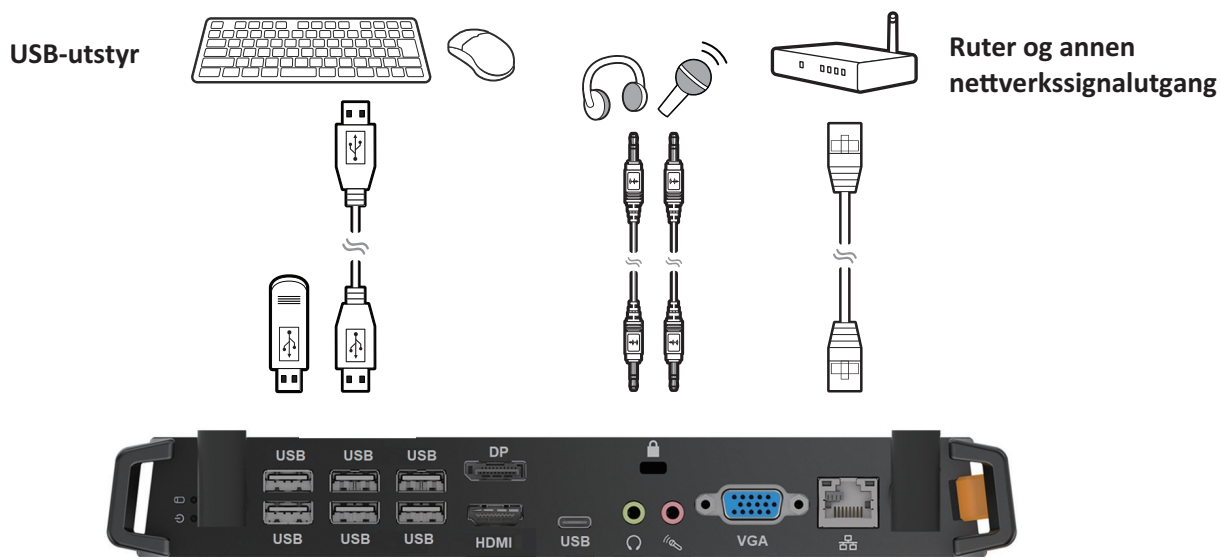

> HDMI-tilkoblinger

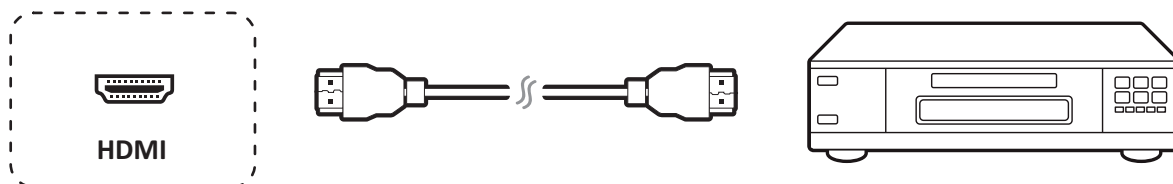

> Start å bruke

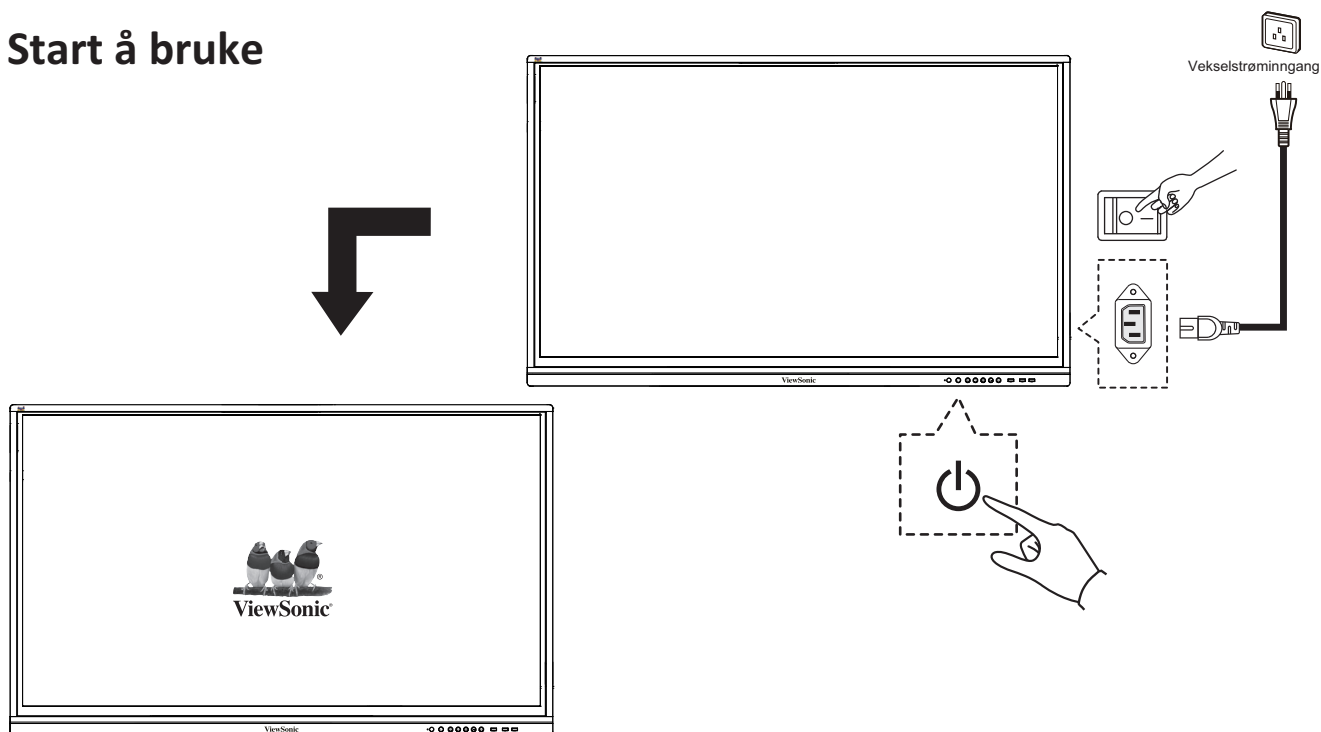



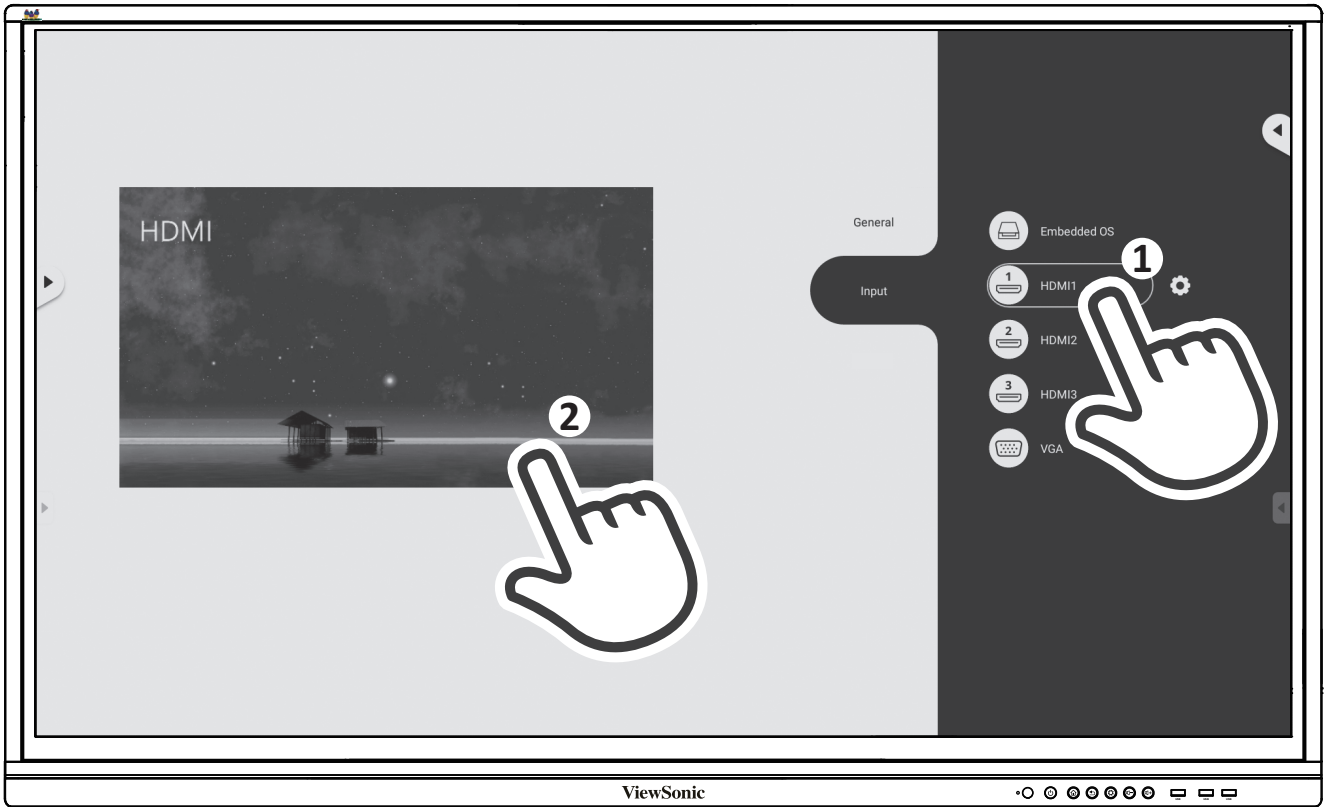
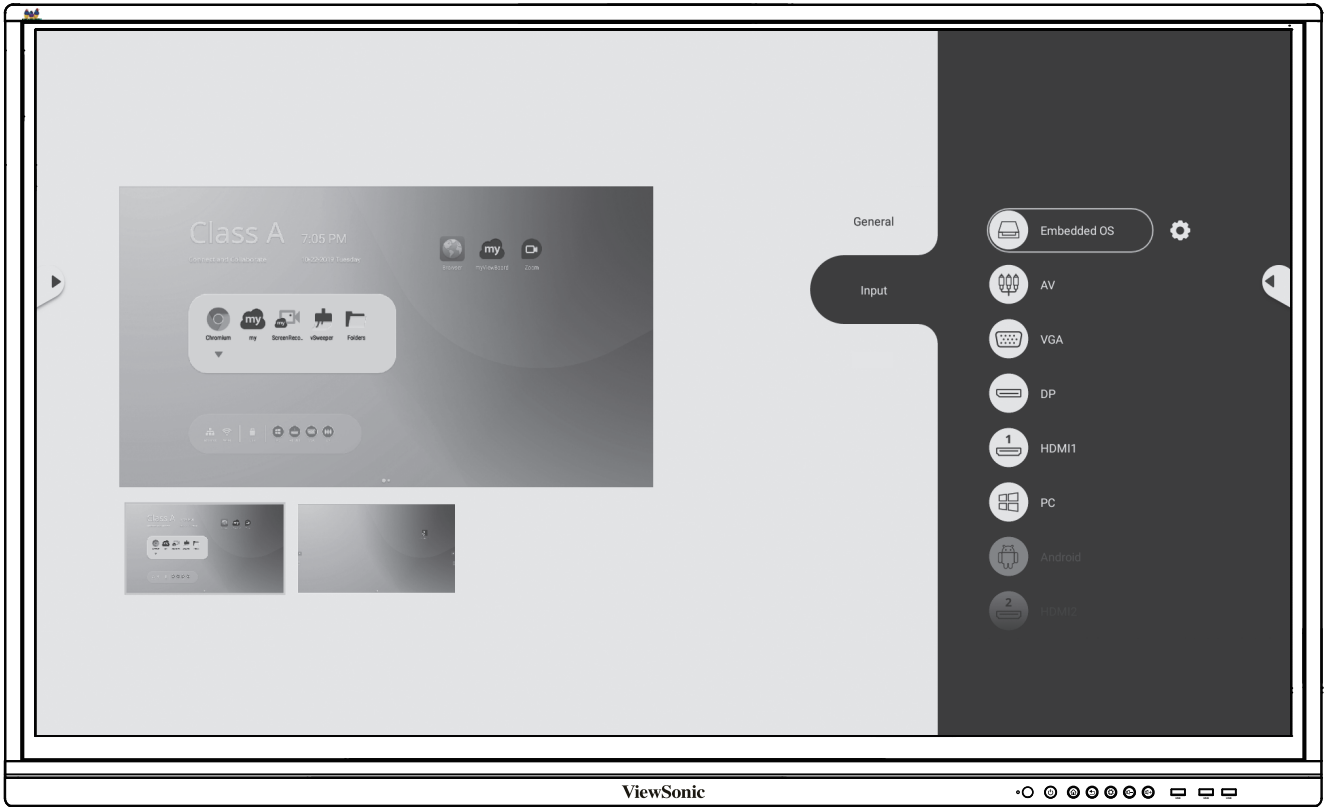

> Samsvarserklæring

FCC-samsvarserklæring: Denne enheten samsvarer med del 15 i FCC-reglene. Bruk er underlagt følgende to betingelser: (1) Denne enheten skal ikke forårsake skadelig interferens, og (2) denne enheten må godta all mottatt interferens, inkludert interferens som kan forårsake uønsket drift.

Samsvar med Industry Canada ICES-003: CAN ICES-3 (B)/NMB-3(B)



ViewSonic Corporation (USA/Canada/Latinamerika)



: www.viewsonic.com/support/product-registration



USA



1-800-688-6688



customerservice@viewsonic.com

Canada



1-866-463-4775



customerservice@viewsonic.com

Puerto Rico og Jomfruøyene



<http://www.viewsonic.com/la/soporte/servicio-tecnico> (Español)

Latinamerika



<http://www.viewsonic.com/la/soporte/servicio-tecnico-la/>



ViewSonic's støttesenter



Valgfritt tilbehør

➤ Zawartość opakowania

- Kabel zasilający (dostawa zależy od regionu)
- Pilot
- Bateria AAA x 2
- Kabel USB
- Pióro dotykowe
- Instrukcja szybkiego uruchomienia
- Adapter RS232
- Zacisk x 5
- Płyta kamery
- Śruba
- Kabel sygnałowy jest zgodny z HDMI

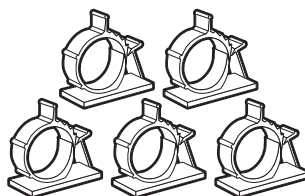
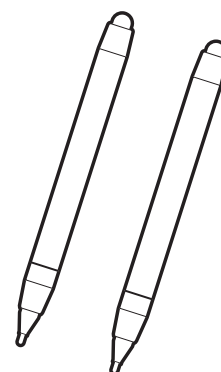
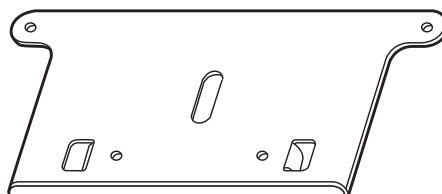
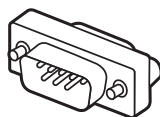
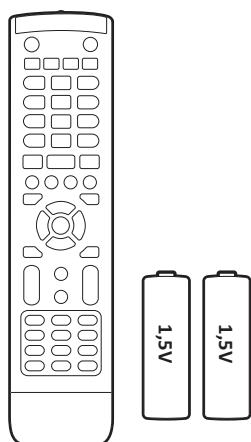
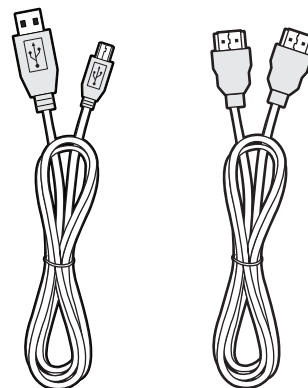
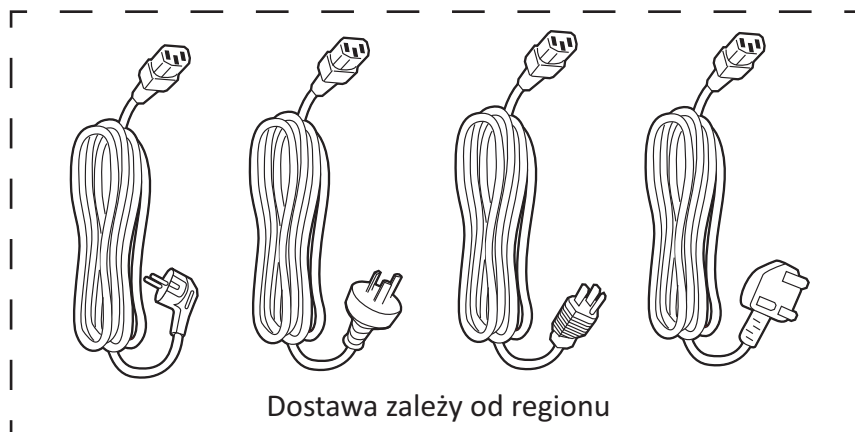

➤ Specyfikacje zestawu do montażu na ścianie (VESA)

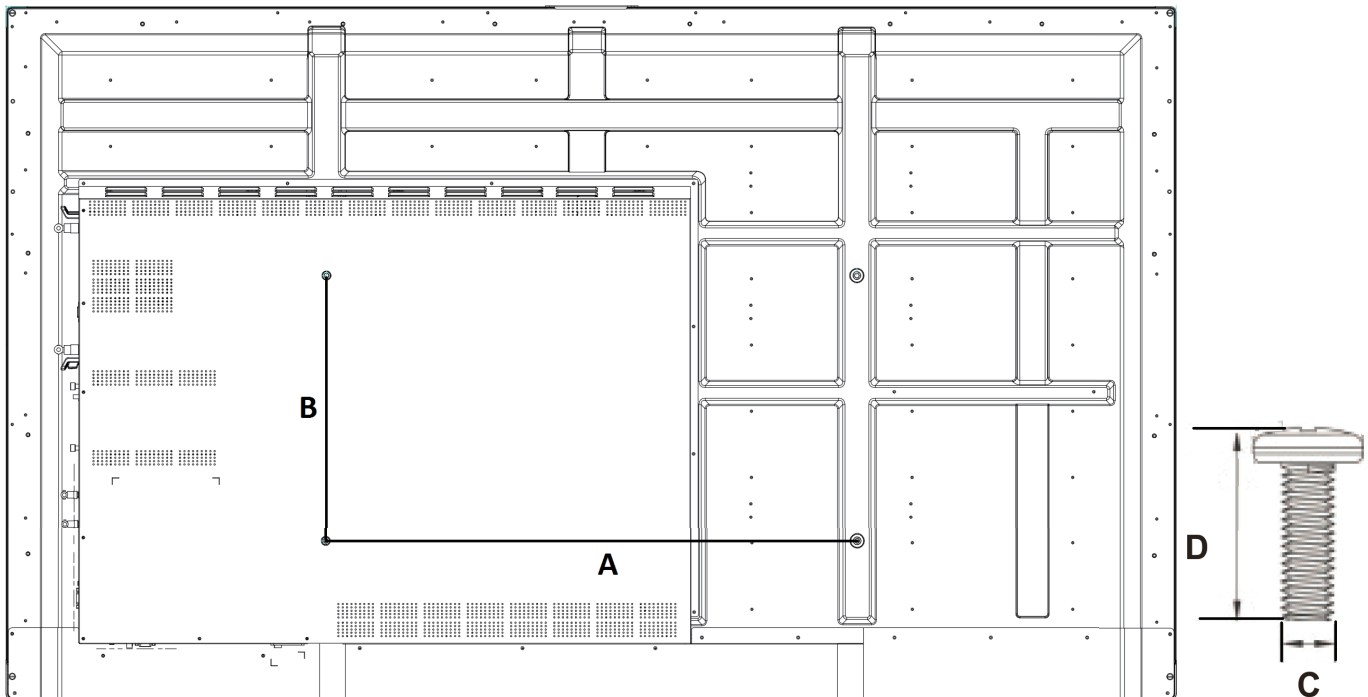

cale	Specyfikacje VESA. (A x B)	Standardowa śruba (C x D)	Liczba
IFP5550 - 55"	400 x 200 mm	M8 x 25 mm	4
IFP6550 - 65"	600 x 400 mm	M8 x 25 mm	4
IFP7550 - 75"	800 x 400 mm	M8 x 25 mm	4
IFP8650 - 86"	800 x 600 mm	M8 x 25 mm	4

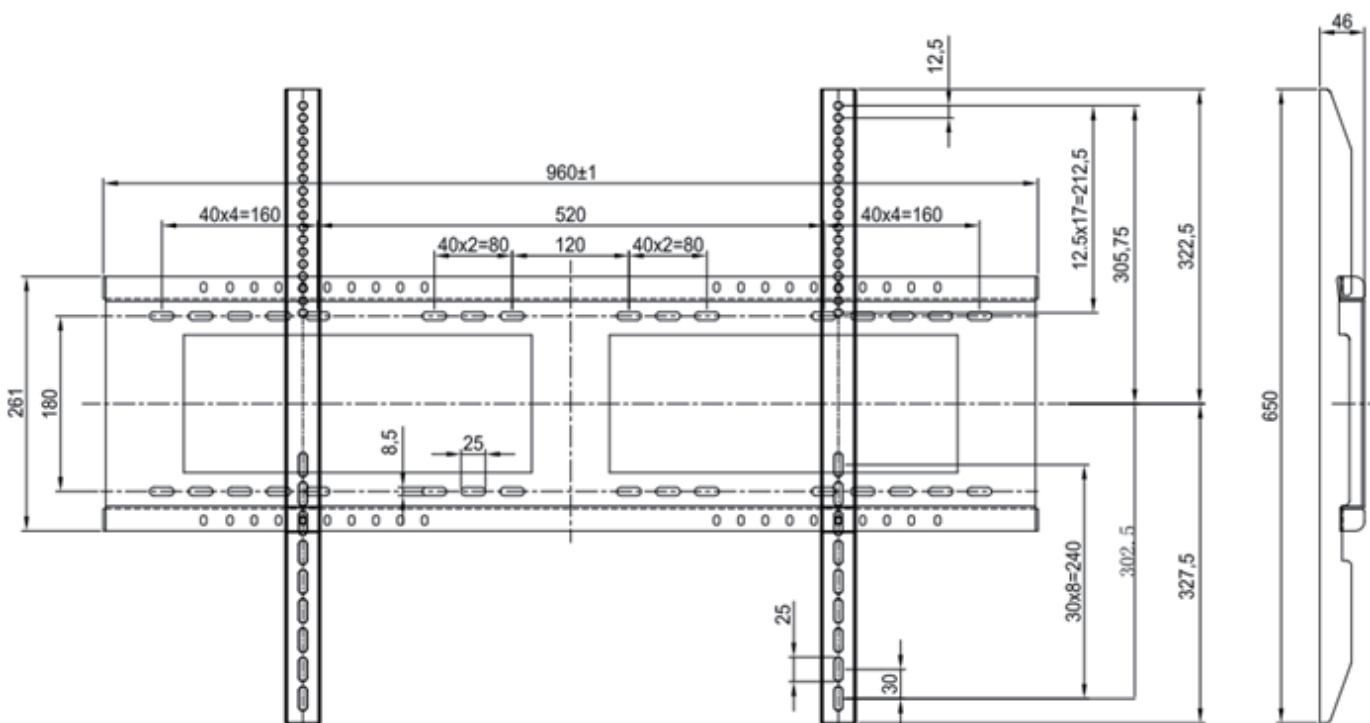

> Zachowanie uwagi podczas instalacji na zewnątrz

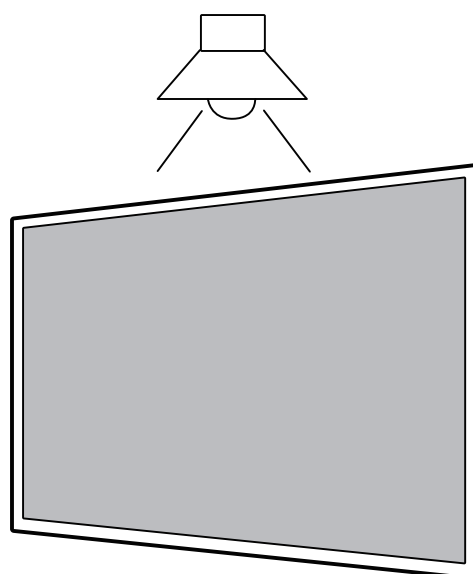
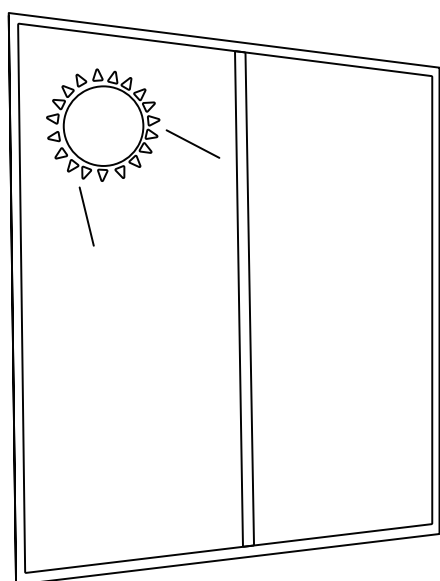
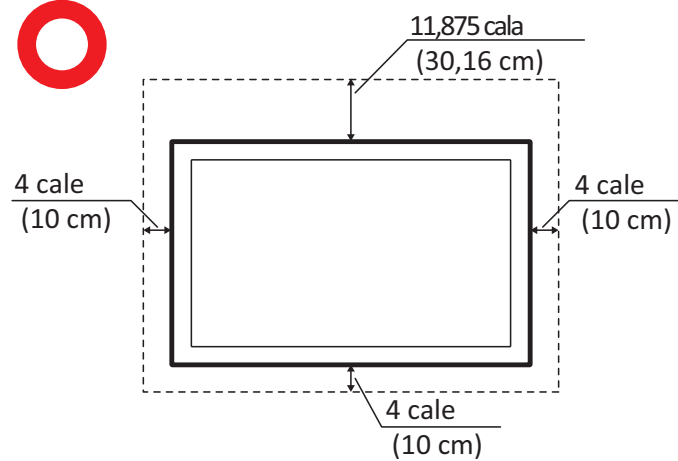
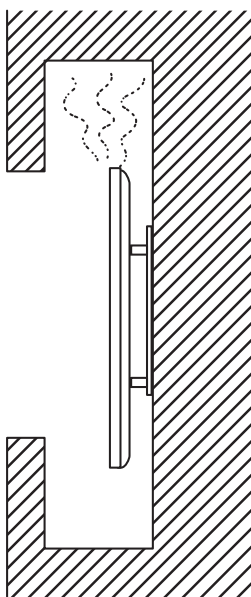

➤ Przegląd panela sterowania

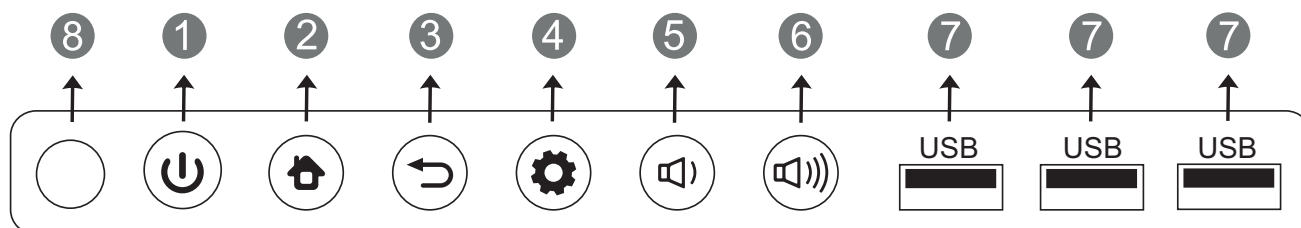

Element	Opis
1	Naciśnij ten przycisk, aby włączyć urządzenie Naciśnij ten przycisk, aby wyłączyć/włączyć tylko podświetlenie Naciśnij i przytrzymaj ten przycisk, aby wyłączyć urządzenie
2	Powrót do głównego interfejsu wbudowanego odtwarzacza
3	Powrót do poprzedniego poziomu menu wbudowanego odtwarzacza
4	Przywołanie menu funkcji
5	Zmniejszenie głośności
6	Zwiększenie głośności
7	Port USB dla wbudowanego odtwarzacza i wewnętrznego komputera PC
8	Odbiór sygnałów z pilota

➤ Port I/O (We/Wy)

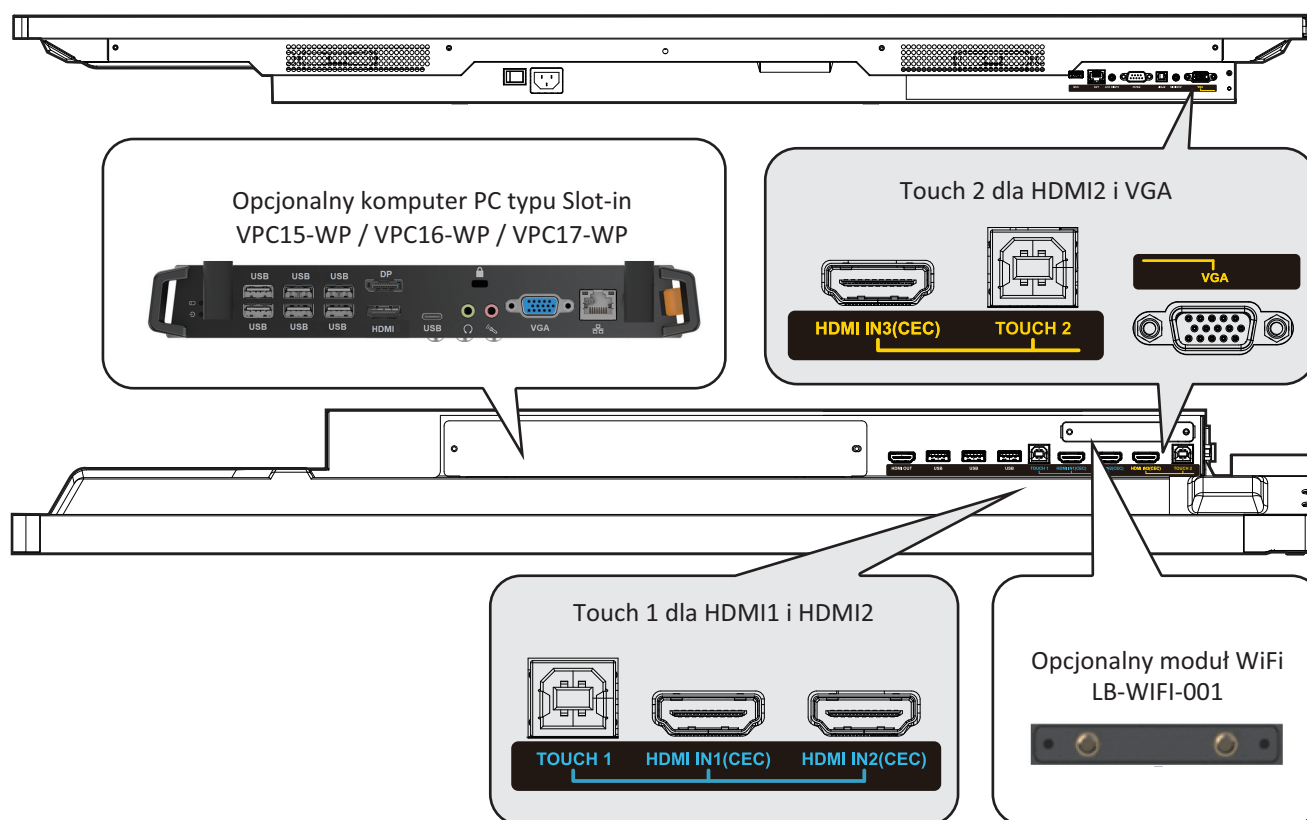

> Przegląd pilota

- 1**  Naciśnij, aby WŁĄCZYĆ/WYŁĄCZYĆ wyświetlacz
- 2**  Wyciszenie/Wyłączenie wyciszenia
- 3** **DISPLAY**
Wyświetlanie informacji o bieżącym źródle wejścia
- 4** **P.MODE**
Pusty ekran
- 5** **FREEZE**
Zatrzymaj ekran
- 6** **Numeric button**
Przycisk wprowadzania wartości numerycznych
- 7** **-/--/ALT+TAB**
Naciśnij, aby przełączyć pomiędzy aplikacjami PC
- 8** **0**
Przycisk wprowadzania wartości numerycznych
- 9**  / **ALT+F4**
Zamykanie bieżącego okna PC
- 10** **INPUT**
Przycisk wyboru źródła
- 11** **MENU**
Naciśnij, aby wyświetlić Menu
- 12** **RED+ALT**
Przechwytywanie ekranu
- 13** **GREEN+TAB**
Przycisk PC 'Tab'
- 14** **YELLOW+DESKTOP**
Przełączenie na źródło komputera PC typu Slot-in
- 15** **BLUE+BACKSPACE**
Przycisk PC 'Backspace'
- 16** **START / D. MENU**
Przycisk PC 'Windows'
- 17**  / **D.TITLE**
Przycisk PC 'Menu'
- 18**  Naciśnij, aby przewinąć w górę
- 19**  Naciśnij, aby przewinąć w lewo
- 20**  Naciśnij, aby przewinąć w prawo
- 21**  Naciśnij, aby przewinąć w dół
- 22** **ENTER**
Przycisk Enter. Naciśnij w celu wyboru opcji.
- 23**  / **D. USB**
Uruchamianie oprogramowania do pisania
- 24** **ESC / EXIT / D. SETUP**
Przycisk skrótu do wychodzenia z okien dialogowych
- 25** **EPG**
Do tyłu
- 26** **FAV / SPACE**
Przycisk PC 'Spacja'
- 27** **CH. + / CH. -**
CH+ : Poprzednia strona PC
CH- : Następna strona PC
- 28** **VOL+ / VOL-**
Zwiększenie/zmniejszenie głośności
- 29** **F1**
Funkcja F1 Windows
- 30** **F2**
Funkcja F2 Windows
- 31** **F3**
Funkcja F3 Windows
- 32** **F4**
Funkcja F4 Windows
- 33** **F5**
Funkcja F5 Windows
- 34** **F6**
Funkcja F6 Windows
- 35** **F7**
Funkcja F7 Windows
- 36** **F8**
Funkcja F8 Windows
- 37** **F9**
Funkcja F9 Windows
- 38** **F10**
Funkcja F10 Windows
- 39** **F11**
Funkcja F11 Windows
- 40** **F12**
Funkcja F12 Windows

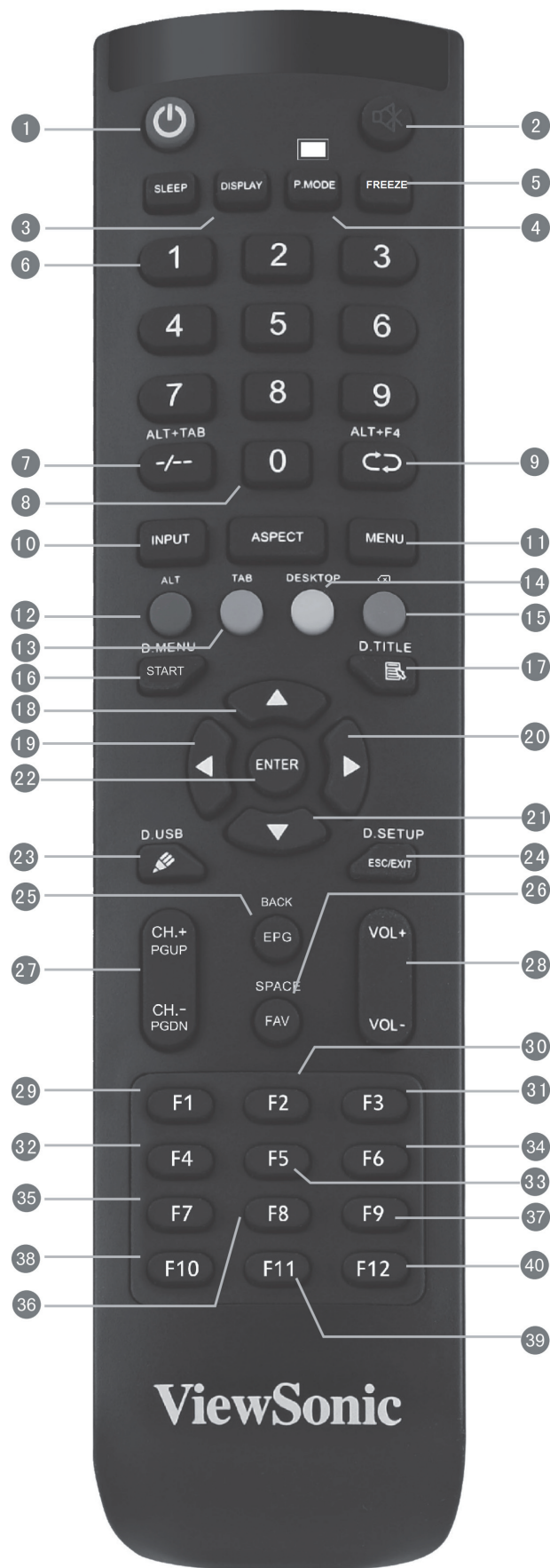

> Podłączanie zewnętrznego komputera PC

1. Aby wyświetlić wideo i dźwięk z zewnętrznego komputera PC, należy wykonać zamieszczone poniżej instrukcje:

Uwaga: Zewnętrzne komputery PC można także podłączyć do wyświetlacza kablem HDMI.

- Podłącz kabel VGA (15-pinowy) z zewnętrznego komputera PC do złącza VGA IN (Wejście VGA) na wyświetlaczu.
- Podłącz kabel audio od portu AUDIO OUT (Wyjście audio) zewnętrznego komputera PC do portu AUDIO IN (Wejście audio) wyświetlacza.

2. Podłącz kabel USB do zewnętrznego komputera PC z portu TOUCH OUT (Wyjście sygnału dotykowego) wyświetlacza.

Uwaga: Dla zapewnienia optymalnych rezultatów, jako rozdzielczość wejścia zewnętrznego komputera, wybierz 1920x1080p.

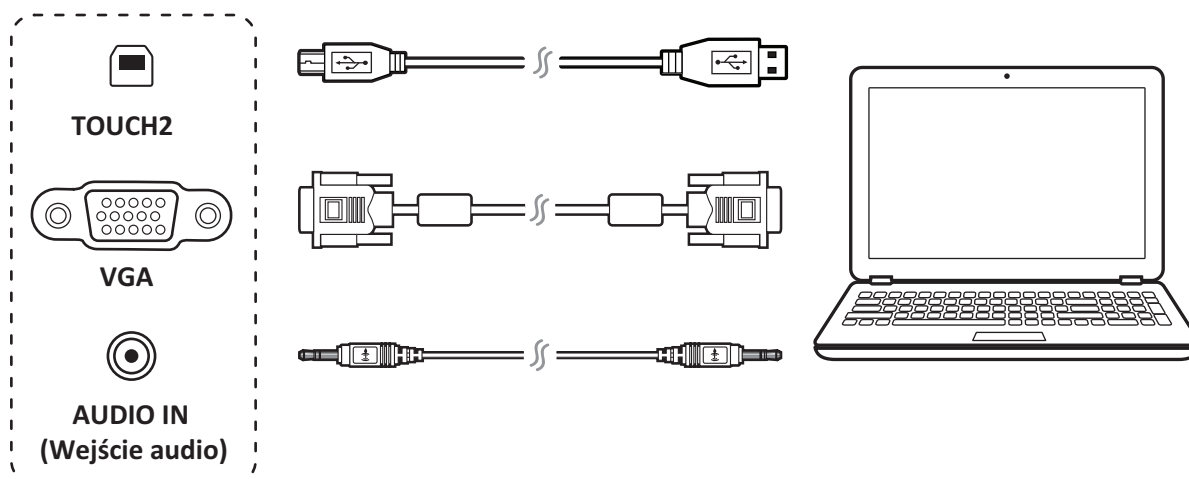

> Połączenia RS232

Gdy do połączenia wyświetlacza z zewnętrznym komputerem używany jest kabel portu szeregowego RS232, niektórymi funkcjami można sterować przez komputer PC, włącznie z włączeniem/wyłączeniem zasilania, regulacją głośności i więcej.

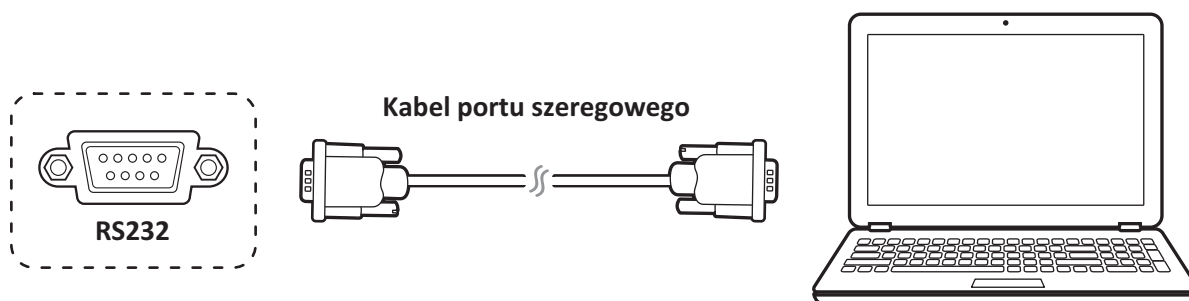

> Podłączanie peryferyjnych urządzeń USB

1. Peryferyjne urządzenia USB: Podłącz kabel urządzenia USB do portu USB IN (Wejście USB).
2. Kable sieciowe i modemowe: Podłącz kabel routera do portu LAN IN (Wejście LAN).
3. Mikrofon: Podłącz kabel mikrofonu do portu MIC (Mikrofon).

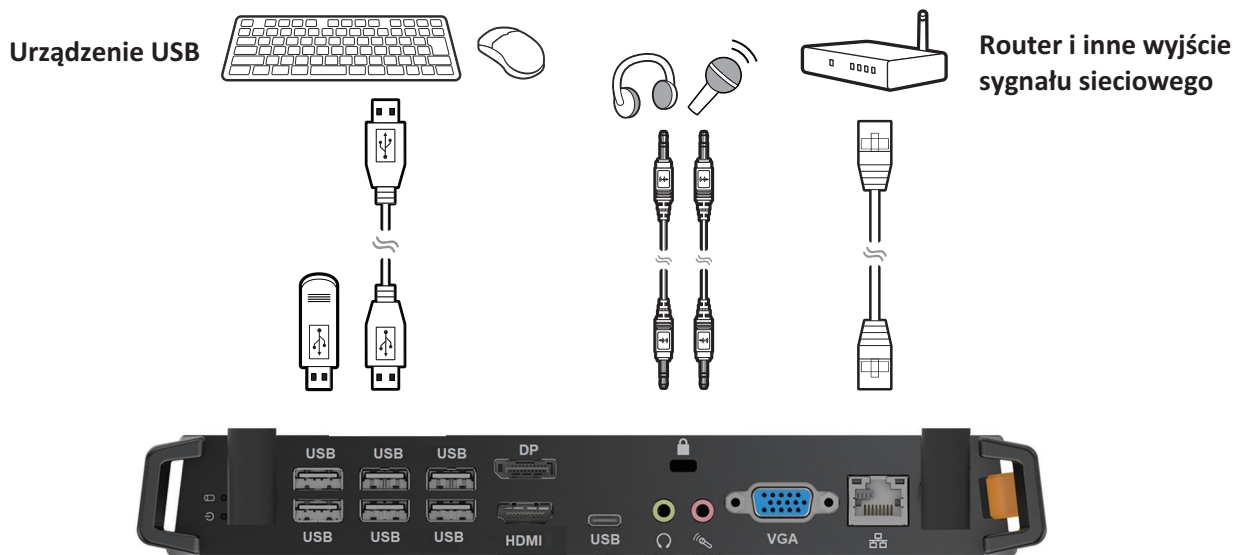

> Połączenia HDMI

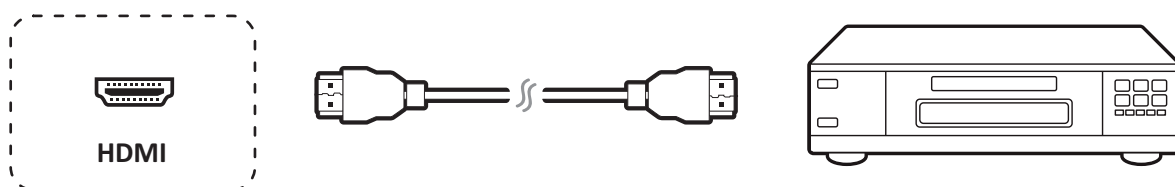

> Rozpoczęcie używania

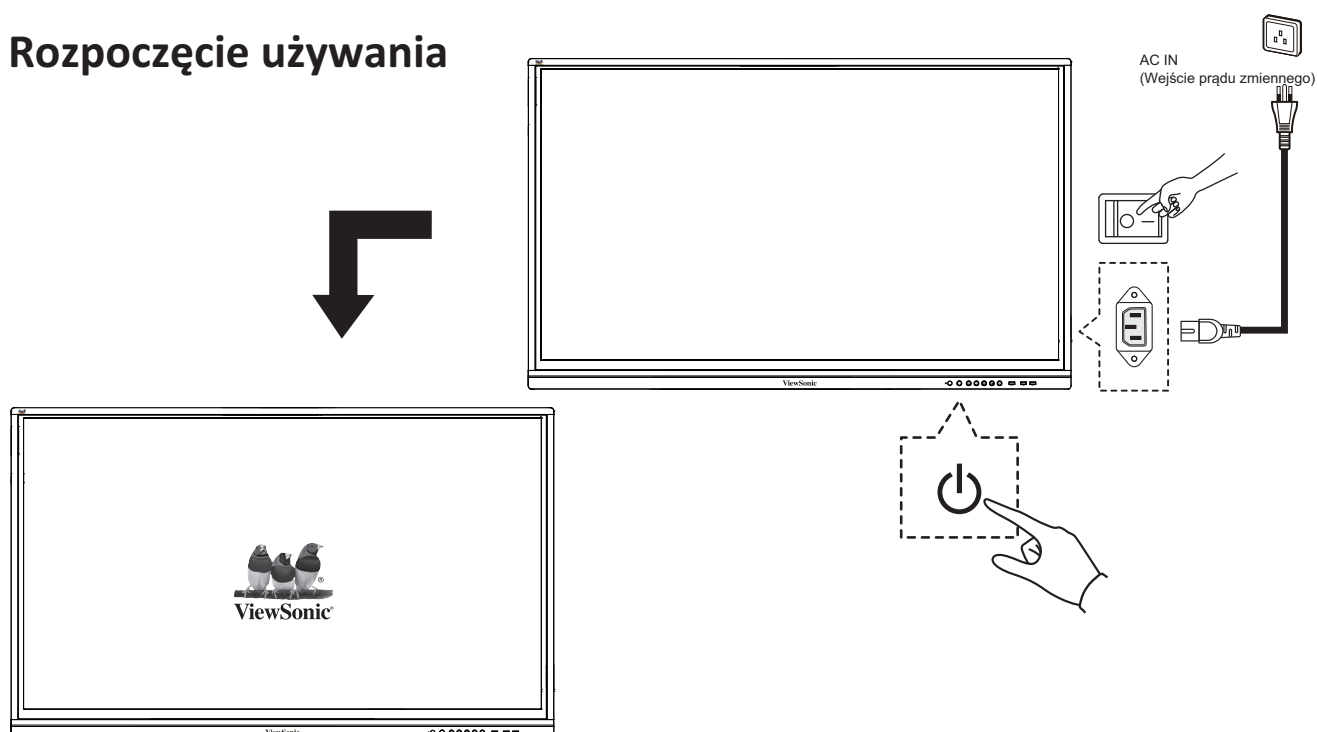



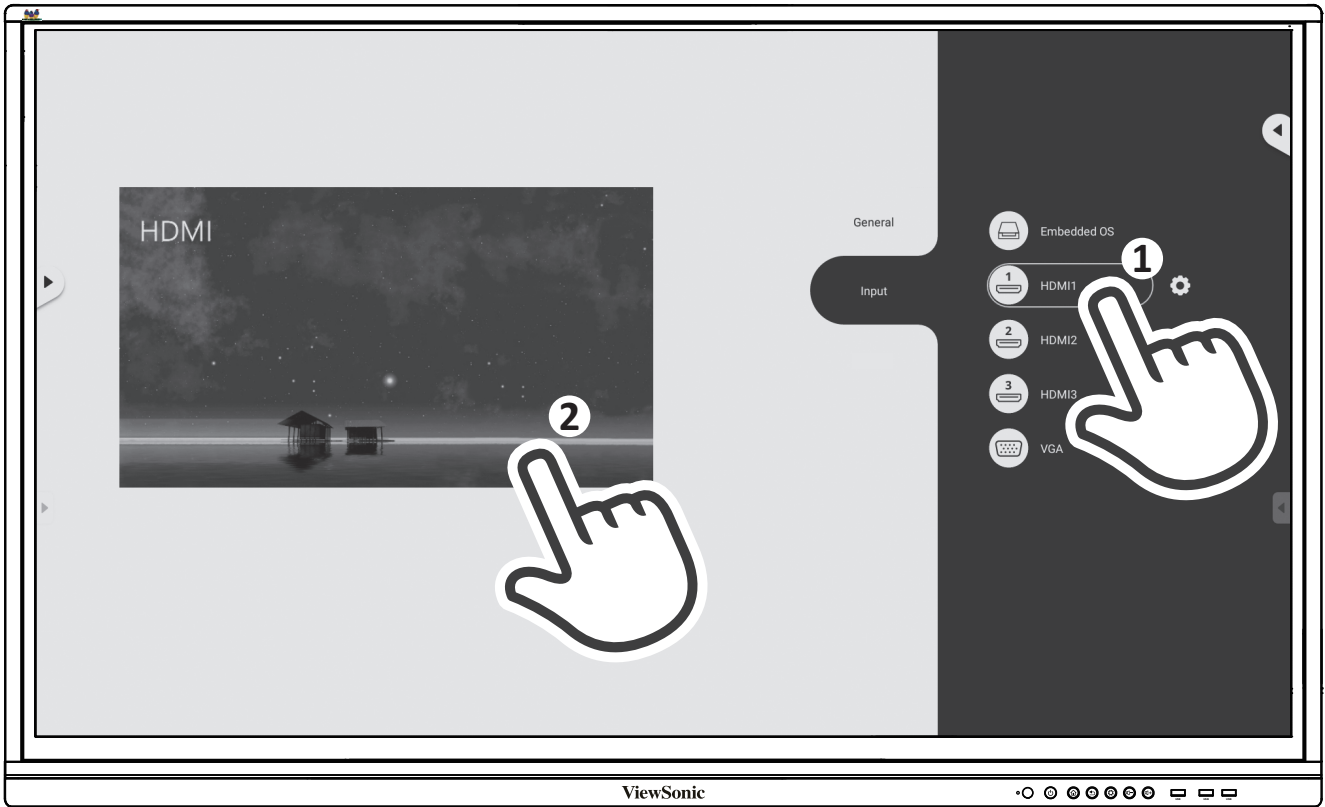
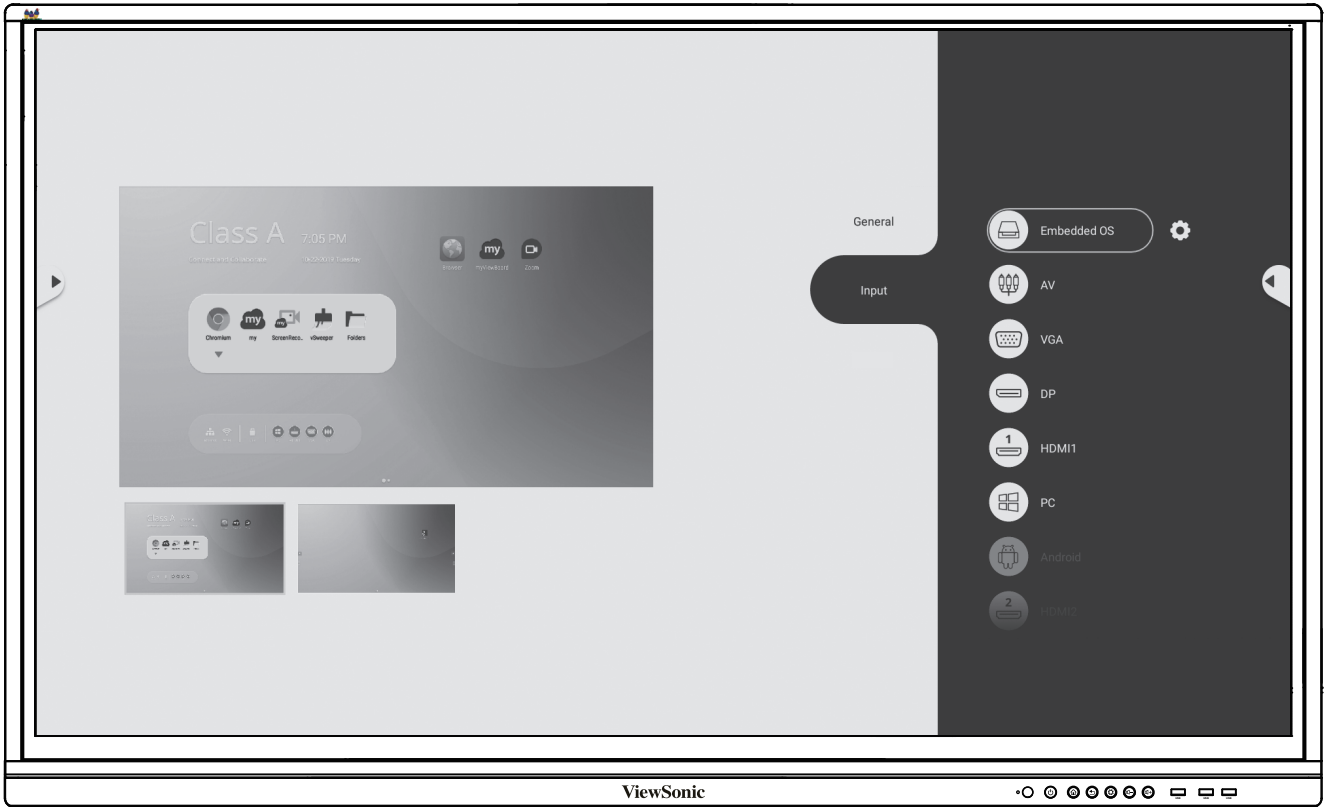

> Oświadczenie o zgodności

Oświadczenie o zgodności z FCC: To urządzenie jest zgodne z częścią 15 przepisów FCC. Jego działanie podlega następującym dwóm warunkom: (1) to urządzenie nie może powodować szkodliwych zakłóceń oraz (2) to urządzenie musi akceptować wszystkie odbierane zakłócenia, włącznie z zakłóceniami, które mogą powodować nieoczekiwane działanie.

Zgodność z przepisami Industry Canada ICES-003: CAN ICES-3 (B)/NMB-3(B)



ViewSonic Corporation (USA/Kanada/Ameryka Łacińska)



: www.viewsonic.com/support/product-registration



Stany Zjednoczone



1-800-688-6688



customerservice@viewsonic.com

Kanada



1-866-463-4775



customerservice@viewsonic.com

Portoryko i Wyspy Dziewicze



<http://www.viewsonic.com/la/soporte/servicio-tecnico> (Español)

Ameryka Łacińska



<http://www.viewsonic.com/la/soporte/servicio-tecnico-la/>



Centrum obsługi ViewSonic



Akcesoria opcjonalne

➤ Комплектация

- Кабель питания (в соответствии со стандартами страны)
- Пульт ДУ
- Батарейки типа AAA - 2 шт.
- Кабель USB
- Сенсорное перо
- Краткое руководство
- Адаптер RS232
- Зажим - 5 шт.
- Пластина камеры
- Винт
- Сигнальный кабель, совместимый с интерфейсом HDMI

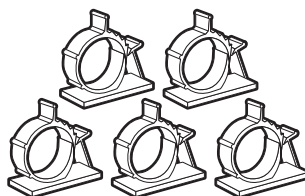
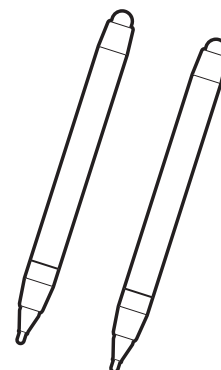
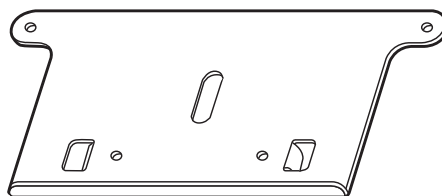
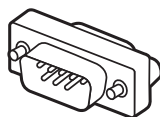
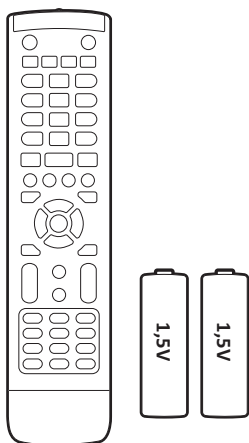
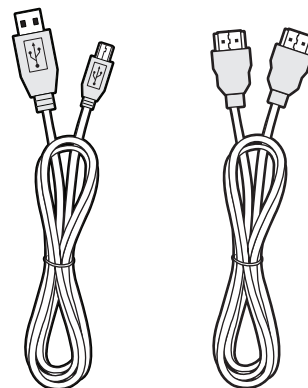

➤ Характеристики комплекта для крепления на стену (VESA)

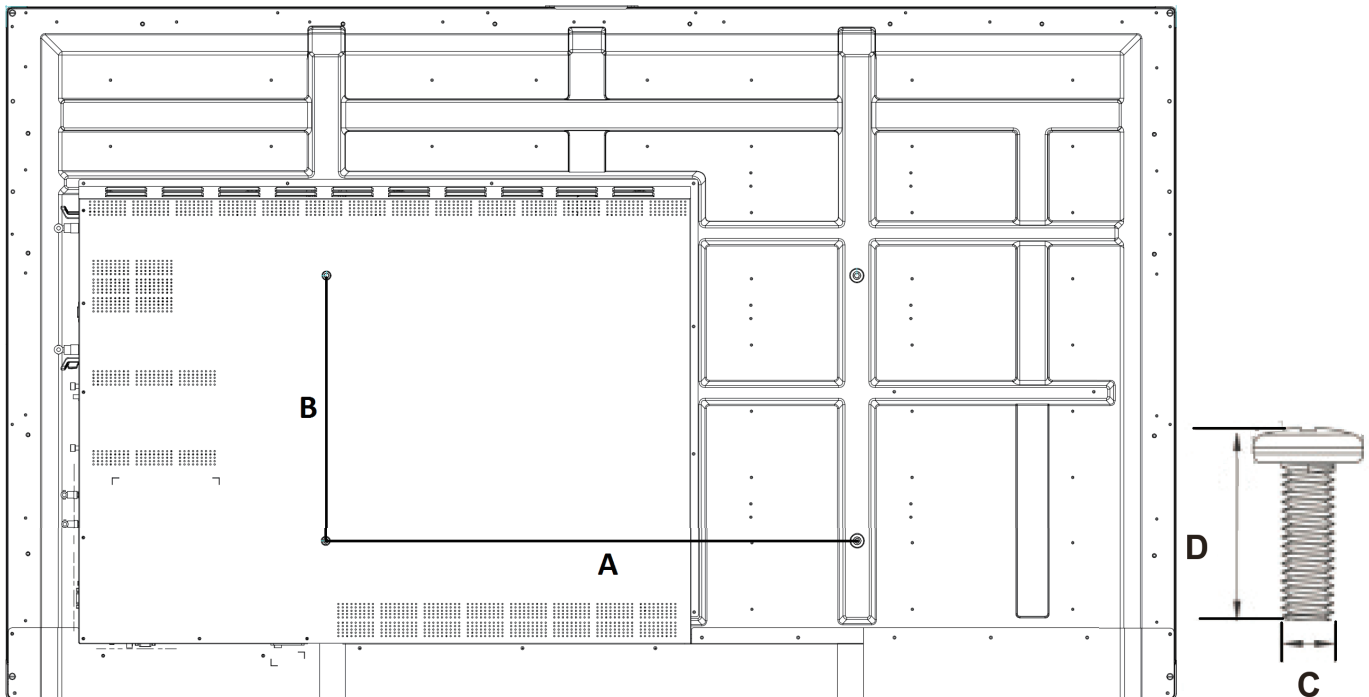

Дюйм.	Параметры VESA (A x B)	Стандартный винт (C x D)	Количество
IFP5550 - 55"	400 x 200 мм	M8 - 25 мм	4
IFP6550 - 65"	600 x 400 мм	M8 - 25 мм	4
IFP7550 - 75"	800 x 400 мм	M8 - 25 мм	4
IFP8650 - 86"	800 x 600 мм	M8 - 25 мм	4

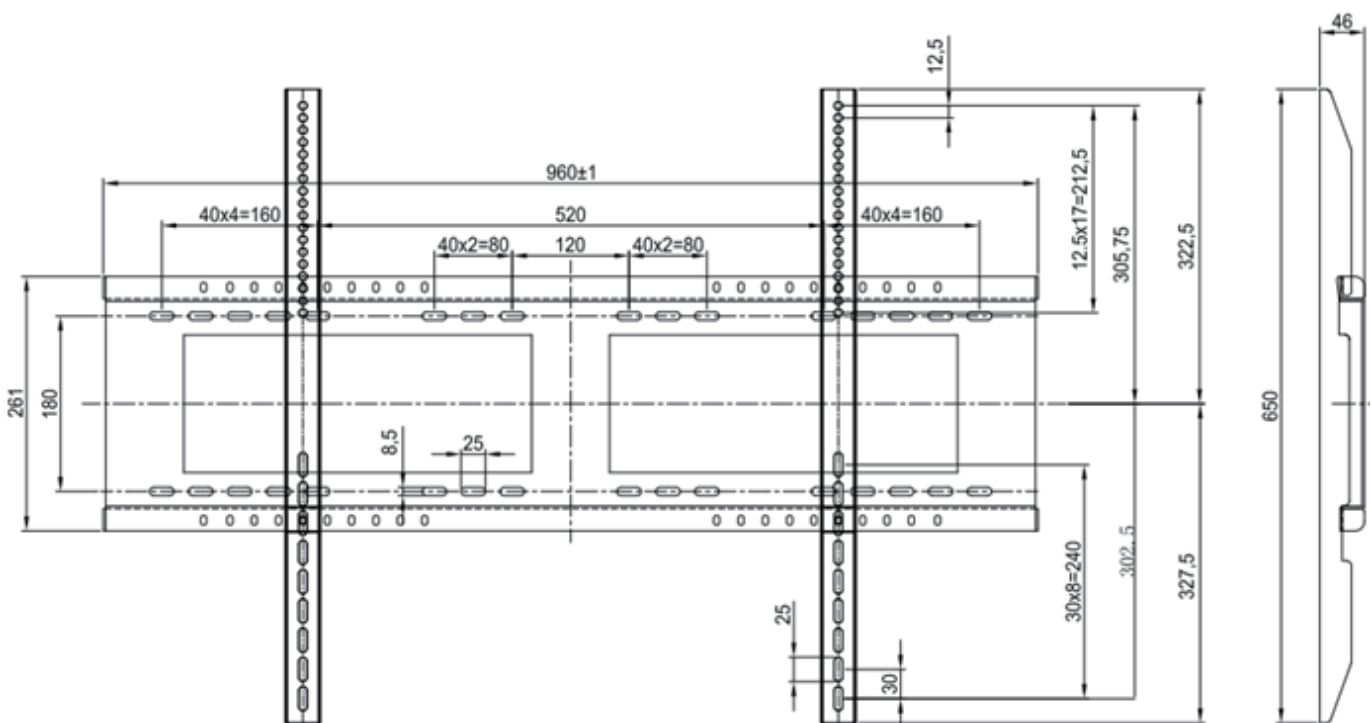

➤ Условия установки

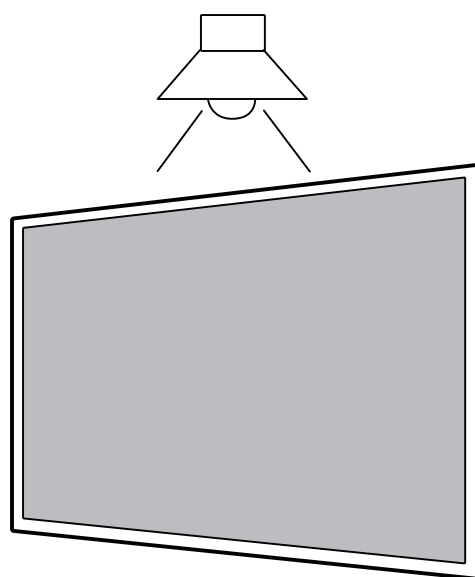
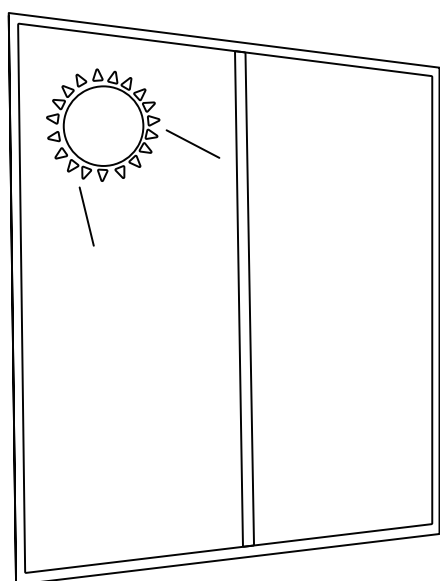
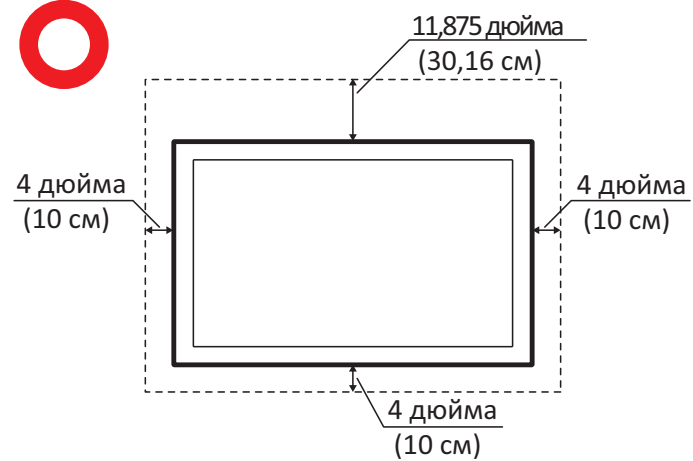
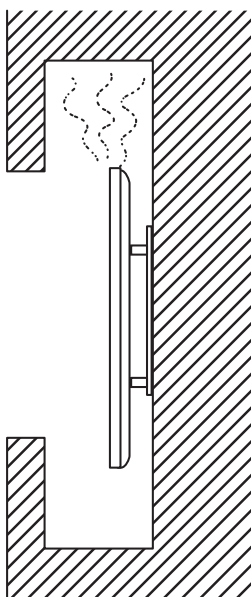

➤ Обзор панели управления

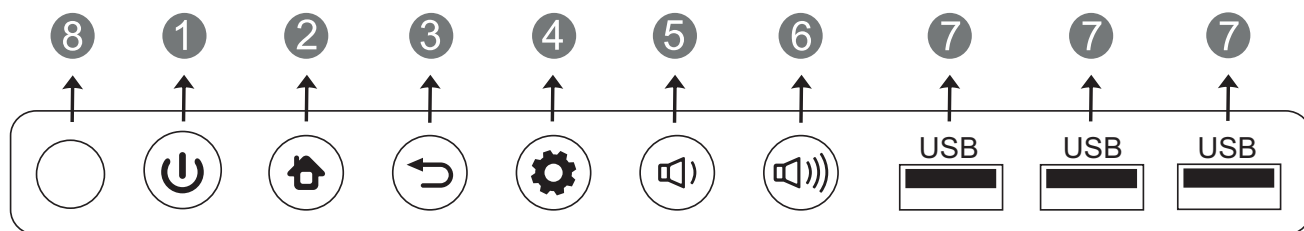





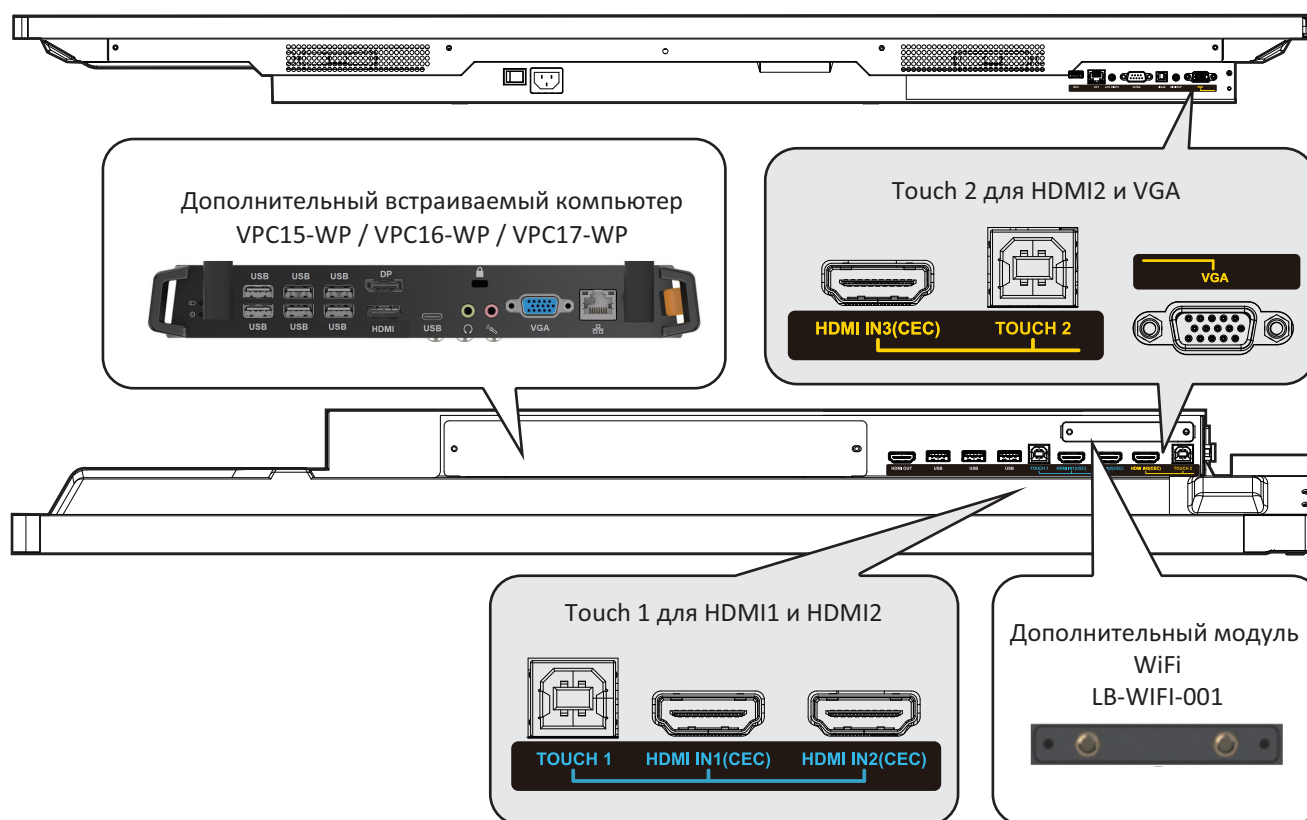



Пункт	Описание
1	Нажмите данную кнопку для включения устройства Нажмите данную кнопку для включения/отключения только подсветки дисплея Нажмите данную кнопку для выключения устройства
2	Возврат к главному интерфейсу встроенного проигрывателя
3	Возврат на предыдущий уровень встроенного проигрывателя
4	Вызов меню функций
5	уменьшение уровня громкости
6	увеличение уровня громкости
7	USB порт для встроенного проигрывателя и внутреннего ПК
8	Принимает сигналы с пульта ДУ

➤ Порт ввода-вывода



> Обзор пульта ДУ

- | | |
|--|---|
| 1  | 22 ENTER |
| Нажмите для включения или выключения экрана | Кнопка ввода. Нажимайте ее для выбора вариантов. |
| 2  | 23  / D. USB |
| Отключение звука / включение звука | Запуск ПО для письма |
| 3 DISPLAY | 24 ESC / EXIT / D. SETUP |
| Отображение информации о текущем источнике входного сигнала | Кнопка-ярлык для выхода из диалоговых окон |
| 4 P.MODE | 25 EPG |
| Пустой экран | Назад |
| 5 FREEZE | 26 FAV / SPACE |
| Стоп-кадр | Клавиша «Пробел» ПК |
| 6 Numeric button | 27 CH. + / CH. - |
| Кнопки ввода цифр | CH+ : Предыдущая страница ПК
CH- : Следующая страница ПК |
| 7 - / -- / ALT+TAB | 28 VOL+ / VOL- |
| Нажмите для переключения между приложениями на ПК | Увеличение / уменьшение уровня громкости |
| 8 0 | 29 F1 |
| Кнопки ввода цифр | Функция F1 Windows |
| 9  / ALT+F4 | 30 F2 |
| Закрывать текущее окно ПК | Функция F2 Windows |
| 10 INPUT | 31 F3 |
| Кнопка выбора источника | Функция F3 Windows |
| 11 MENU | 32 F4 |
| Нажмите для отображения меню | Функция F4 Windows |
| 12 RED+ALT | 33 F5 |
| Захват экрана | Функция F5 Windows |
| 13 GREEN+TAB | 34 F6 |
| Клавиша «Tab» на ПК | Функция F6 Windows |
| 14 YELLOW+DESKTOP | 35 F7 |
| Переключение источника на встраиваемый компьютер | Функция F7 Windows |
| 15 BLUE+BACKSPACE | 36 F8 |
| Клавиша «Backspace» на ПК | Функция F8 Windows |
| 16 START / D. MENU | 37 F9 |
| Клавиша «Windows» на ПК | Функция F9 Windows |
| 17  / D.TITLE | 38 F10 |
| Клавиша «Menu» на ПК | Функция F10 Windows |
| 18  | 39 F11 |
| Нажмите для прокрутки вверх | Функция F11 Windows |
| 19  | 40 F12 |
| Нажмите для прокрутки влево | Функция F12 Windows |
| 20  | |
| Нажмите для прокрутки вправо | |
| 21  | |
| Нажмите для прокрутки вниз | |

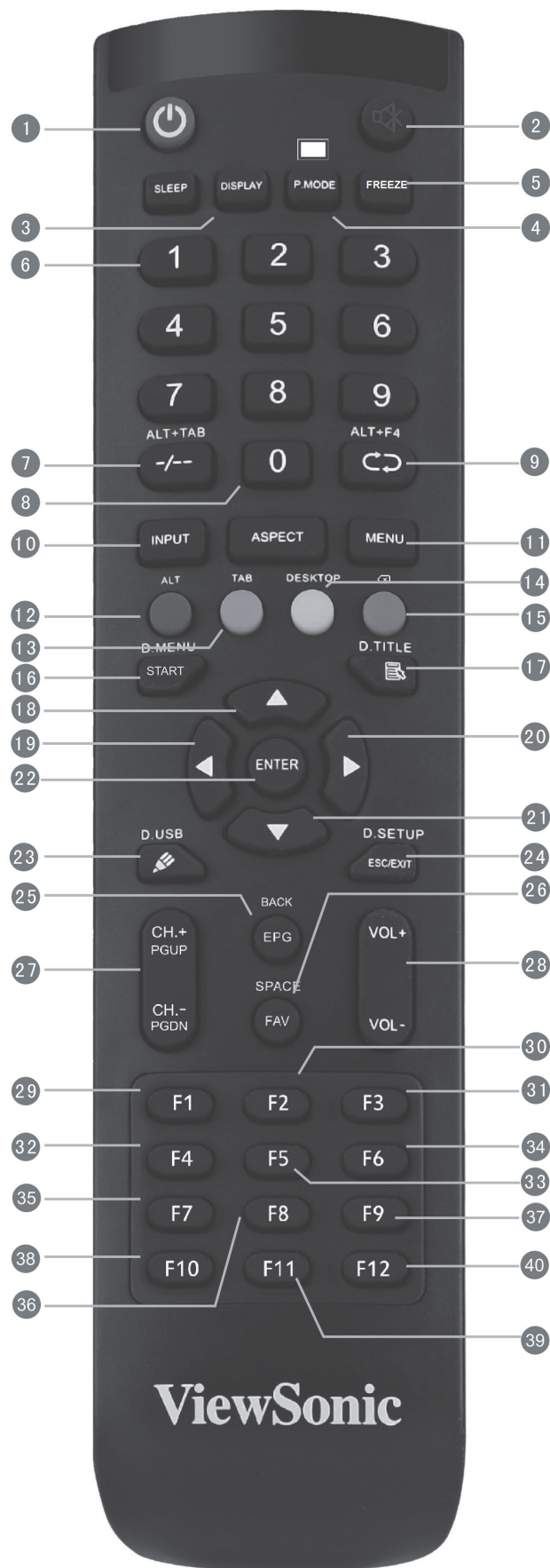

> Подключение внешнего ПК

1. Для вывода видео и звука с внешнего ПК выполните следующие указания.
Примечание: Внешние ПК также могут быть подсоединены к дисплею через кабель HDMI.
 - Соедините кабелем VGA (15-контактным) внешний ПК и порт VGA IN на дисплее.
 - Соедините аудиокабелем порт AUDIO OUT на внешнем ПК и порт AUDIO IN на дисплее.
2. Соедините кабелем USB внешний ПК и порт TOUCH OUT дисплея.
Примечание: Для получения оптимального результата, выберите 1920x1080p в качестве разрешения сигнала, поступающего с внешнего компьютера.

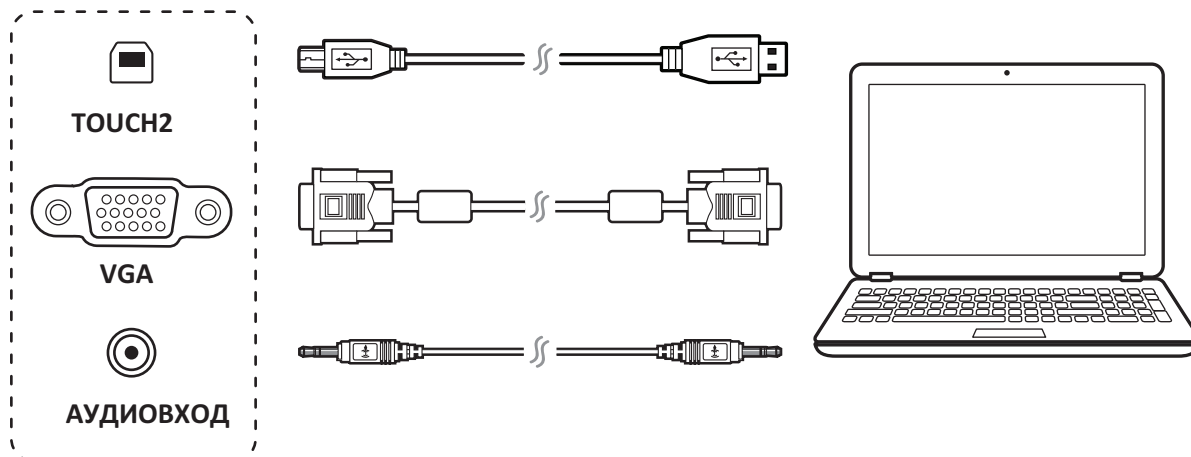

> Подключения RS232

При использовании кабеля последовательного интерфейса RS232 для соединения дисплея с внешним компьютером через ПК можно будет управлять некоторыми функциями, в том числе включением и выключением питания, регулировкой уровня громкости и др.



➤ Подключение периферийных устройств USB

1. Периферия с интерфейсом USB: вставьте кабель устройства с интерфейсом USB в порт USB IN.
2. Подключение к сети и кабели модемов: подключите кабель от маршрутизатора к порту LAN IN.
3. Микрофон: подключите кабель микрофона к порту MIC.

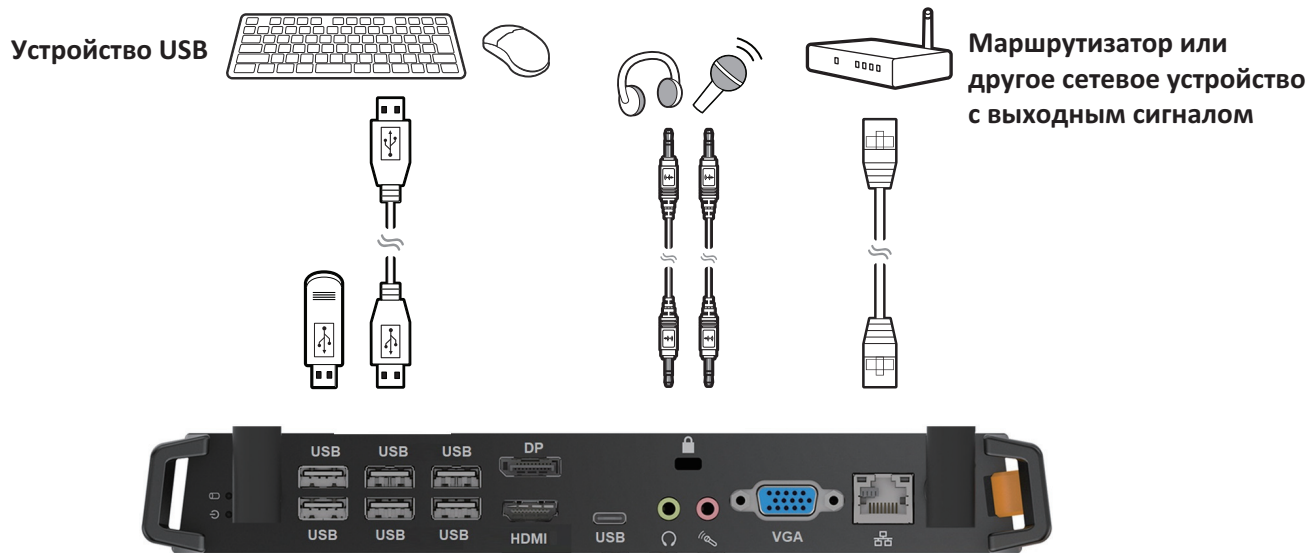

➤ Подключения HDMI

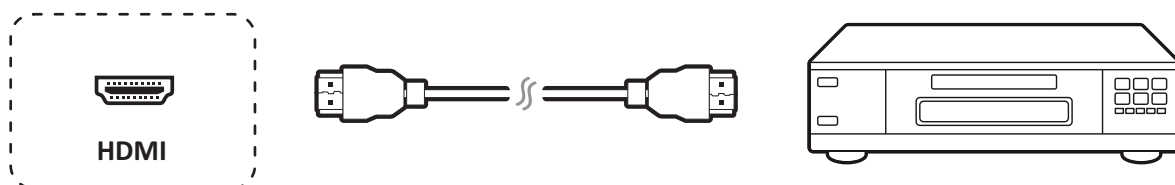

➤ Подготовка к работе

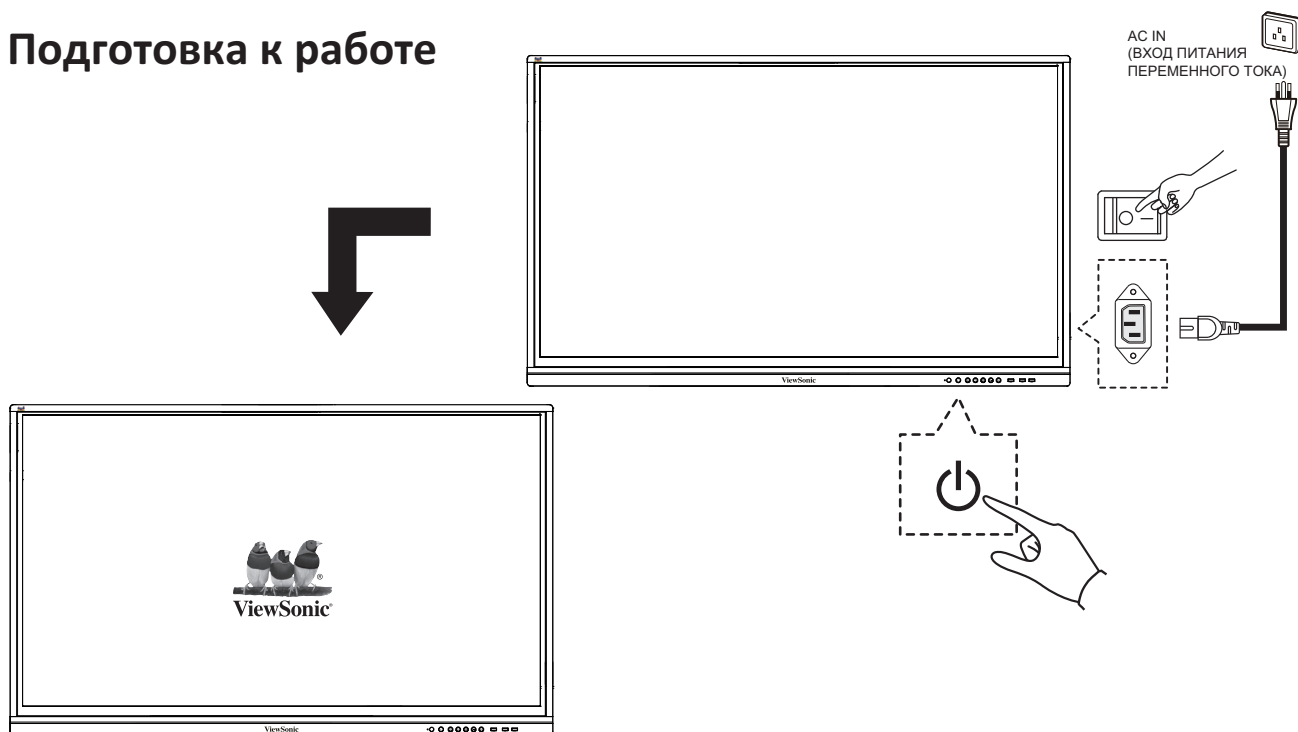



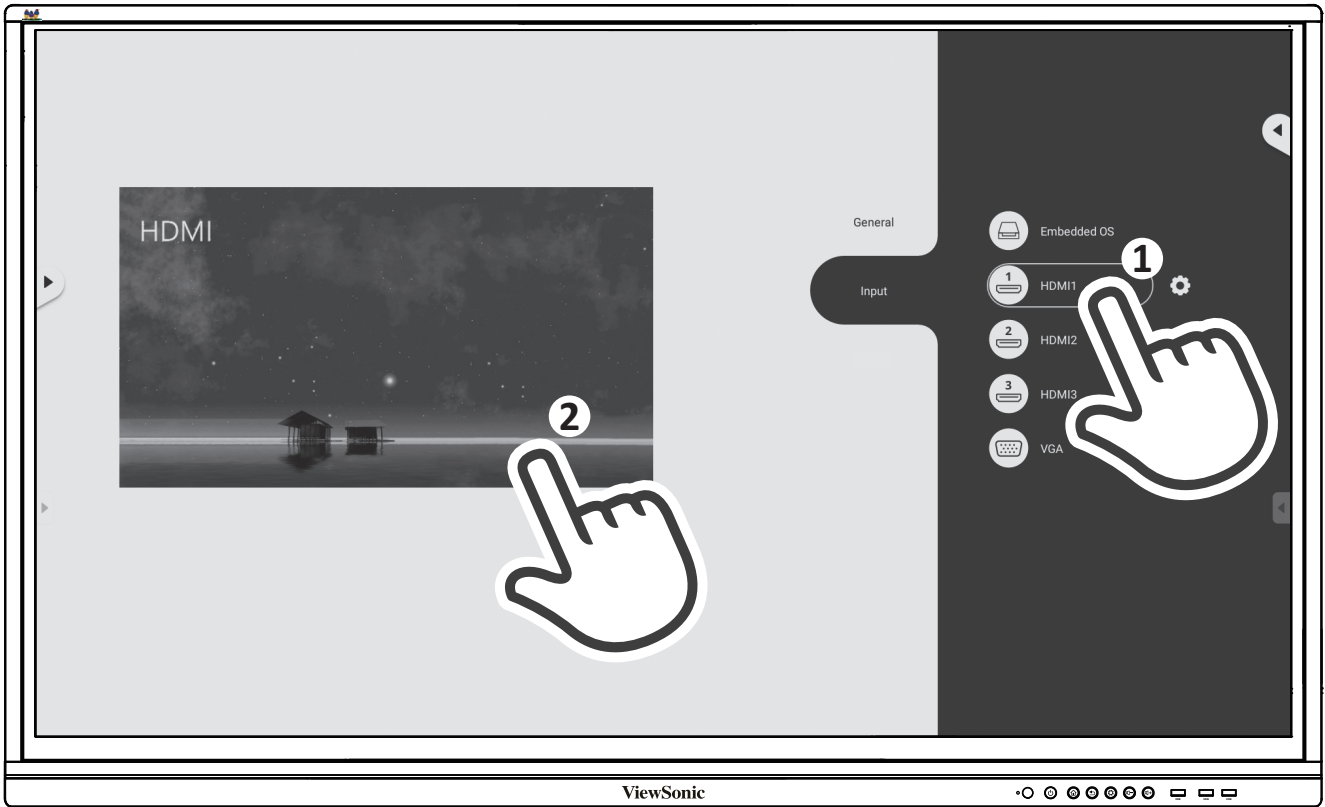
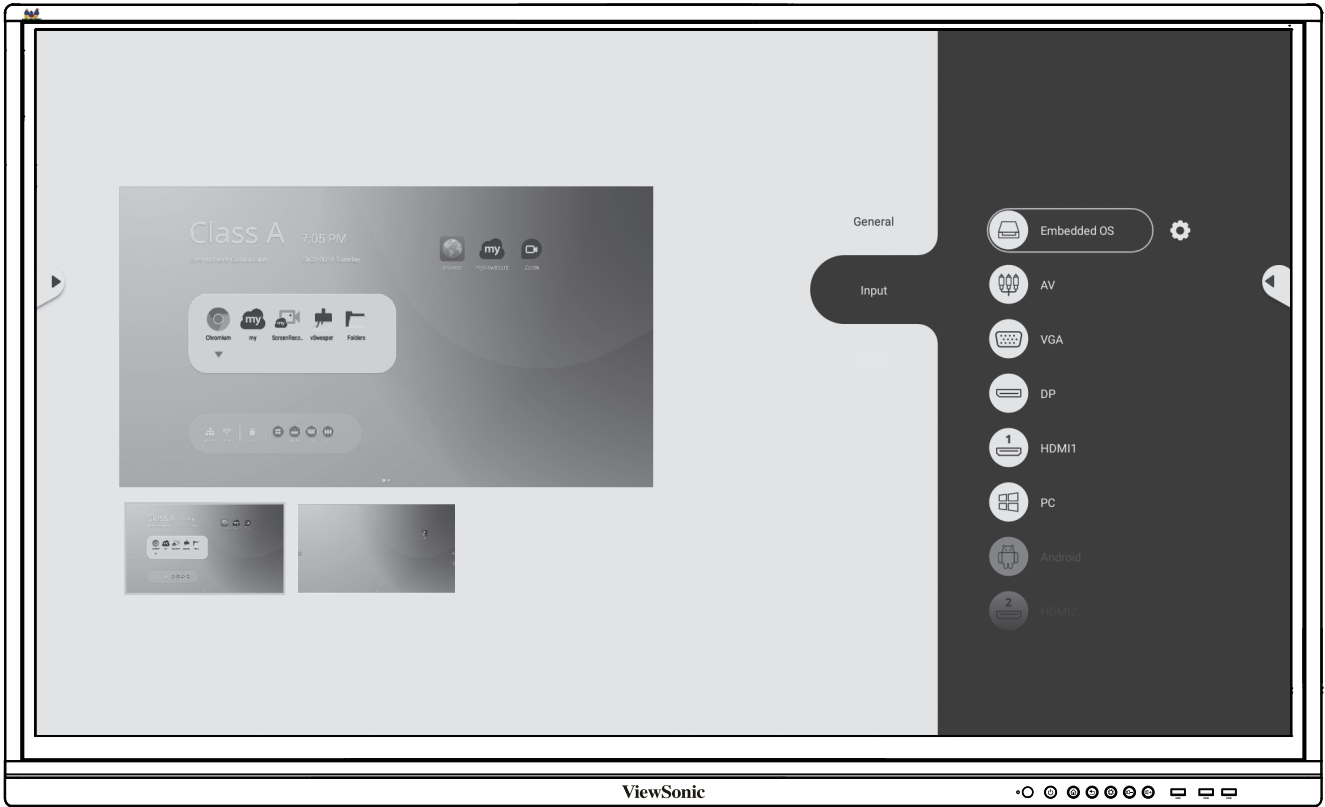

> Соответствие стандартам

Соответствие требованиям ФКС США: Данное устройство соответствует требованиям правил FCC, часть 15. При использовании устройства должны соблюдаться два следующих условия: (1) данное устройство не должно быть источником помех; (2) данное устройство должно быть устойчивым к помехам, создаваемым другими приборами, включая такие помехи, которые могут стать причиной его неправильной работы.

Соответствие промышленному стандарту Канады ICES-003: CAN ICES-3 (B)/NMB-3(B)



Корпорация ViewSonic (США/ Канада/ Латинская Америка)

 : www.viewsonic.com/support/product-registration



США

 1-800-688-6688

 customerservice@viewsonic.com

Канада

 1-866-463-4775

 customerservice@viewsonic.com

Пуэрто-Рико и Виргинские острова

 <http://www.viewsonic.com/la/soporte/servicio-tecnico> (Español)

Латинская Америка

 <http://www.viewsonic.com/la/soporte/servicio-tecnico-la/>



Центр поддержки
ViewSonic



Дополнительная
принадлежность

➤ Contenido del paquete

- Cable de alimentación (envío por región)
- Mando a distancia
- Pila de tipo AAA x 2
- Cable USB
- Lápiz táctil
- Guía de inicio rápido
- Adaptador RS232
- Abrazadera x 5
- Placa de la cámara
- Tornillo
- Compatible con el cable de señal con HDMI

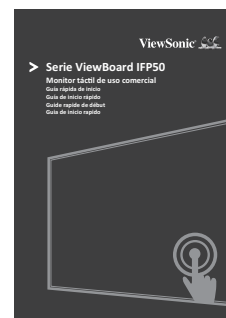
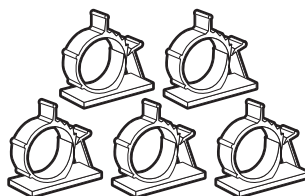
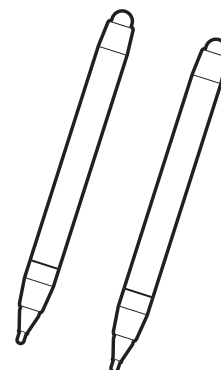
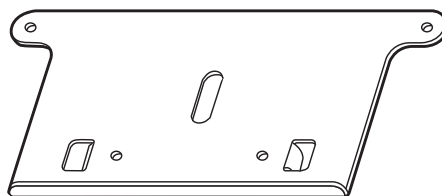
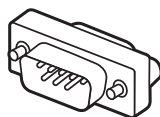
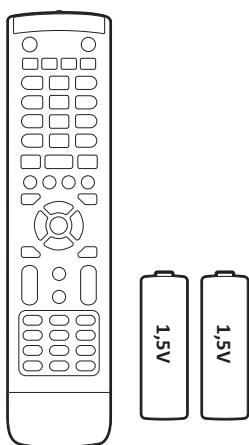
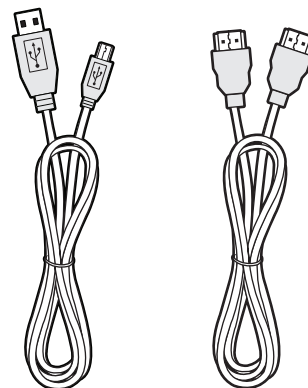
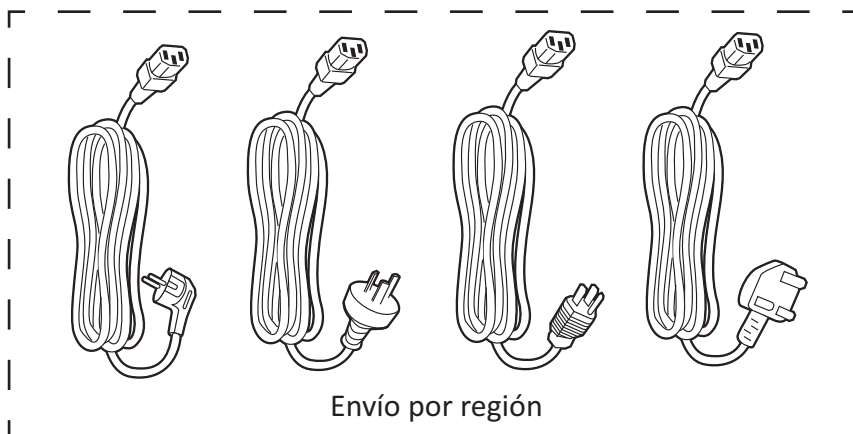

➤ Especificaciones del kit de instalación en pared (VESA)

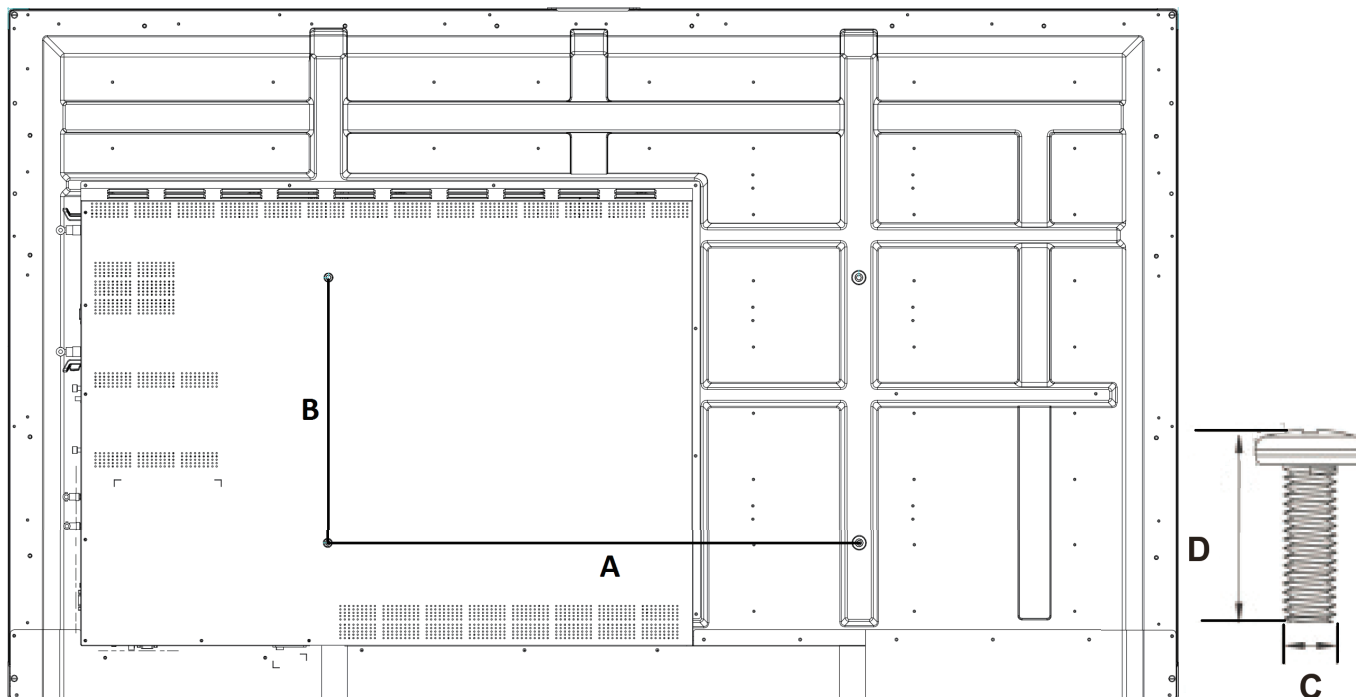

Pulgada	Especificaciones VESA (A x B)	Tornillo estándar (C x D)	Cantidad
IFP5550 - 55"	400 x 200 mm	M8 x 25 mm	4
IFP6550 - 65"	600 x 400 mm	M8 x 25 mm	4
IFP7550 - 75"	800 x 400 mm	M8 x 25 mm	4
IFP8650 - 86"	800 x 600 mm	M8 x 25 mm	4

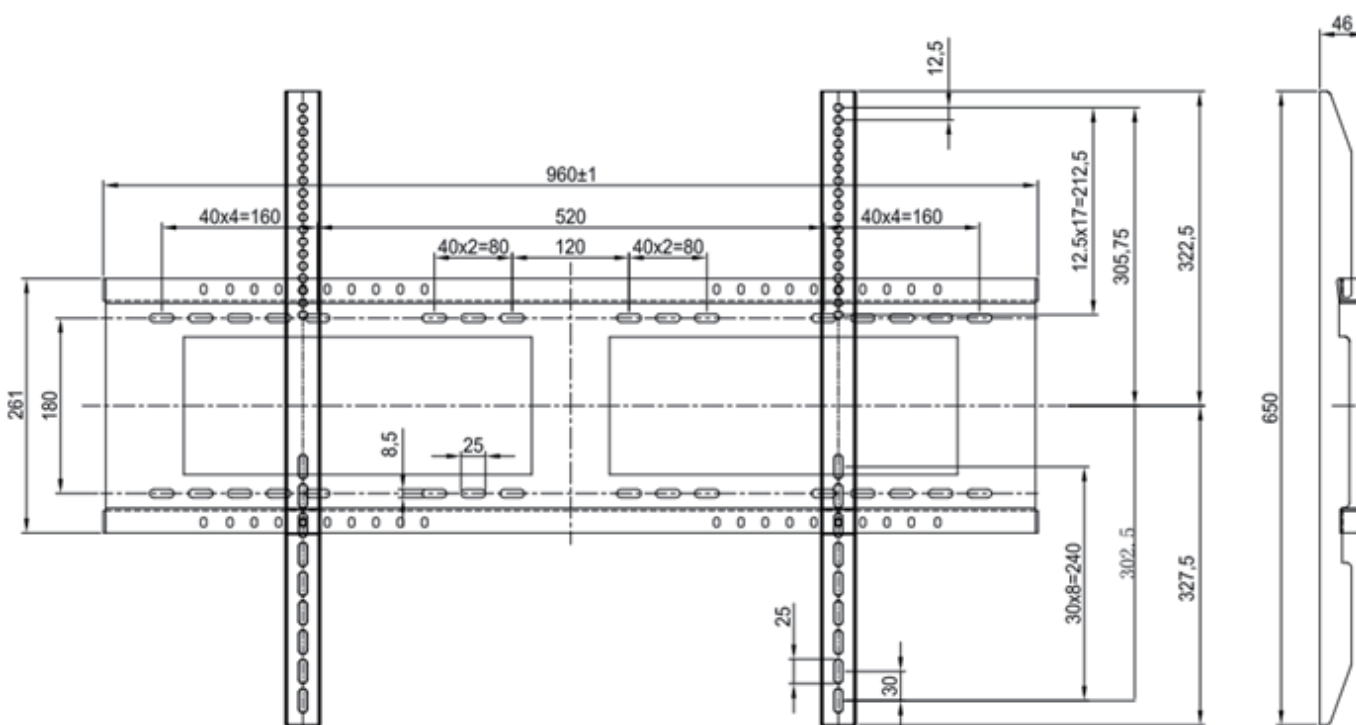

➤ Atención al entorno de instalación

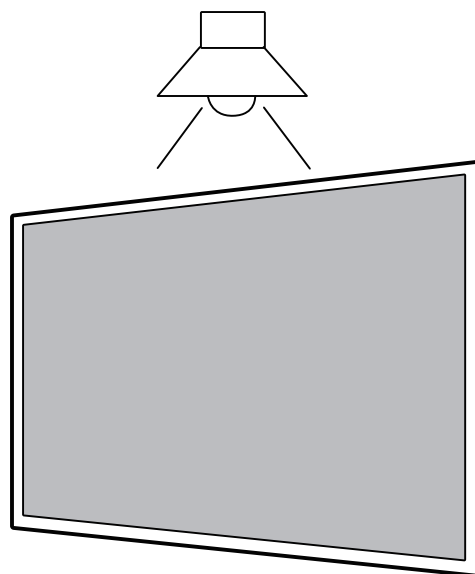
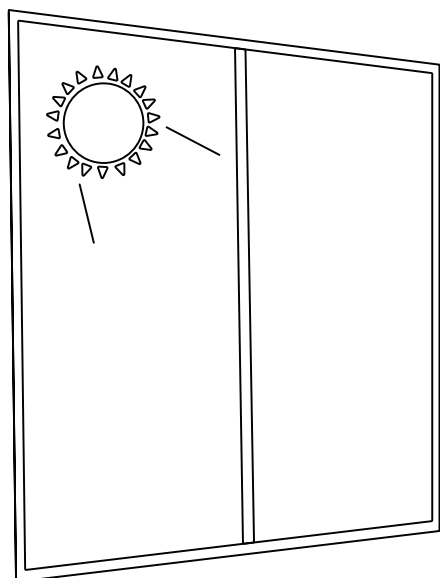
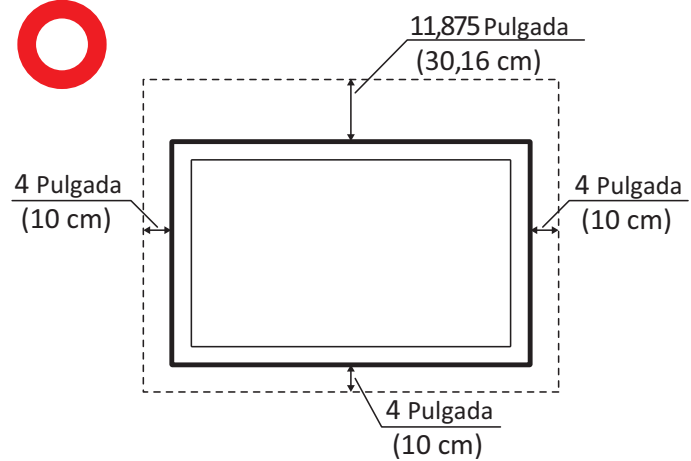
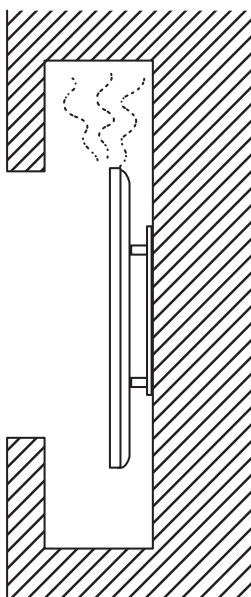

> Información general del panel de Control

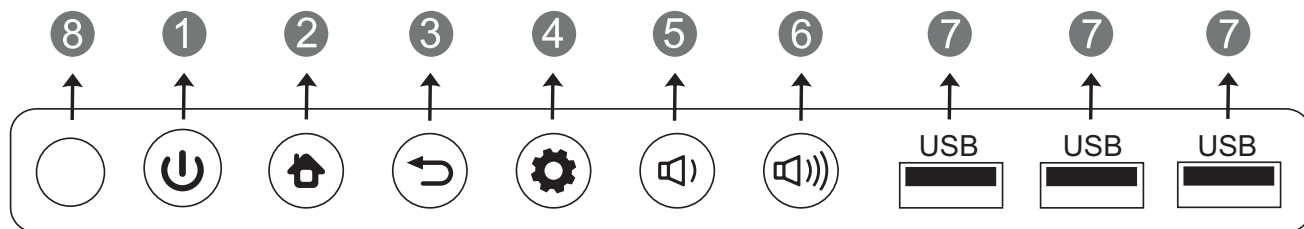

Elemento	Descripción
1	Presione el botón para encender el dispositivo. Presione el botón para apagar o encender solamente la retroiluminación de la pantalla Presione sin soltar el botón para apagar el dispositivo.
2	Permite volver a la interfaz principal de Embedded player
3	Permite volver al nivel anterior de Embedded player.
4	Permite llamar a la función de menú.
5	Permite bajar el volumen.
6	Permite subir el volumen.
7	Puerto USB para Embedded Player y PC interno
8	Recibe las señales del mando a distancia.

> Puerto de E/S

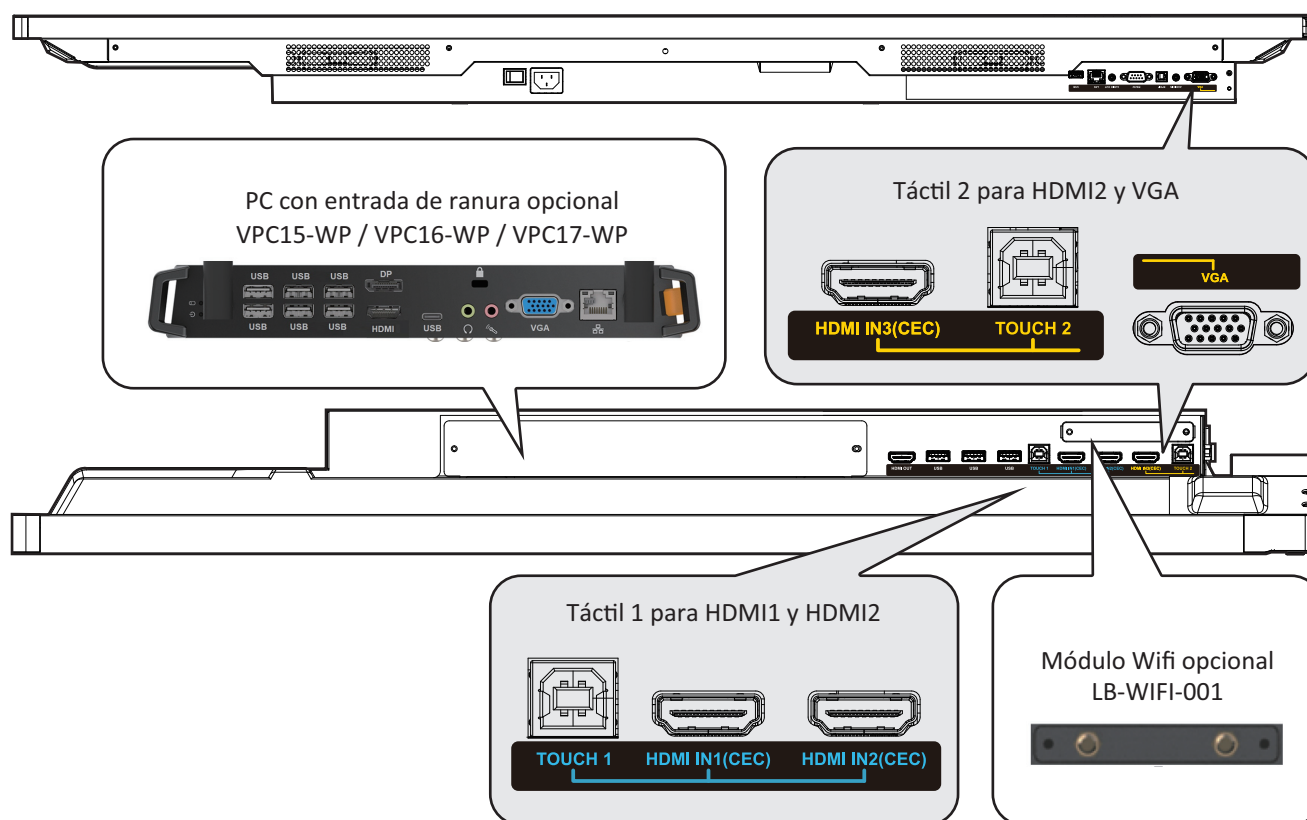

➤ Información general del mando a distancia

1

Presión este botón para ENTENDER O APAGAR la pantalla

2

Silencio/Desactivar silencio

3 DISPLAY

Permite mostrar información de la fuente de entrada actual.

4 P.MODE

Pantalla en blanco

5 FREEZE

Congelar pantalla

6 Numeric button

Botón de entrada numérica

7 - / -- / ALT+TAB

Presione este botón para cambiar entre aplicaciones de PC.

8 0

Botón de entrada numérica

9

Permite cerrar la ventana de PC actual.

10 INPUT

Botón de selección de fuente

11 MENU

Presione este botón para mostrar el menú.

12 RED+ALT

Captura de pantalla

13 GREEN+TAB

Botón 'Tabulador' del equipo

14 YELLOW+DESKTOP

Cambiar al escritorio del módulo de PC de acoplamiento por ranura

15 BLUE+BACKSPACE

Botón 'Retrosceso' del equipo

16 START / D. MENU

Botón 'Windows' del equipo

17

Botón 'Menú' del equipo

18

Presionar para desplazarse hacia arriba

19

Presionar para desplazarse hacia la izquierda

20

Presionar para desplazarse hacia la derecha

21

Presionar para desplazarse hacia abajo

22 ENTER

Botón Intro. Presiónelo para seleccionar opciones.

23

Inicio del software de escritura

24 ESC / EXIT / D. SETUP

Botón de acceso directo para salir de los cuadros de dialogo

25 EPG

Atrás

26 FAV / SPACE

Botón 'Espacio' del equipo

27 CH. + / CH. -

CANAL +: Página anterior del equipo
CANAL -: Página siguiente del equipo

28 VOL+ / VOL-

Subir o bajar volumen

29 F1

Función F1 de Windows

30 F2

Función F2 de Windows

31 F3

Función F3 de Windows

32 F4

Función F4 de Windows

33 F5

Función F5 de Windows

34 F6

Función F6 de Windows

35 F7

Función F7 de Windows

36 F8

Función F8 de Windows

37 F9

Función F9 de Windows

38 F10

Función F10 de Windows

39 F11

Función F11 de Windows

40 F12

Función F12 de Windows

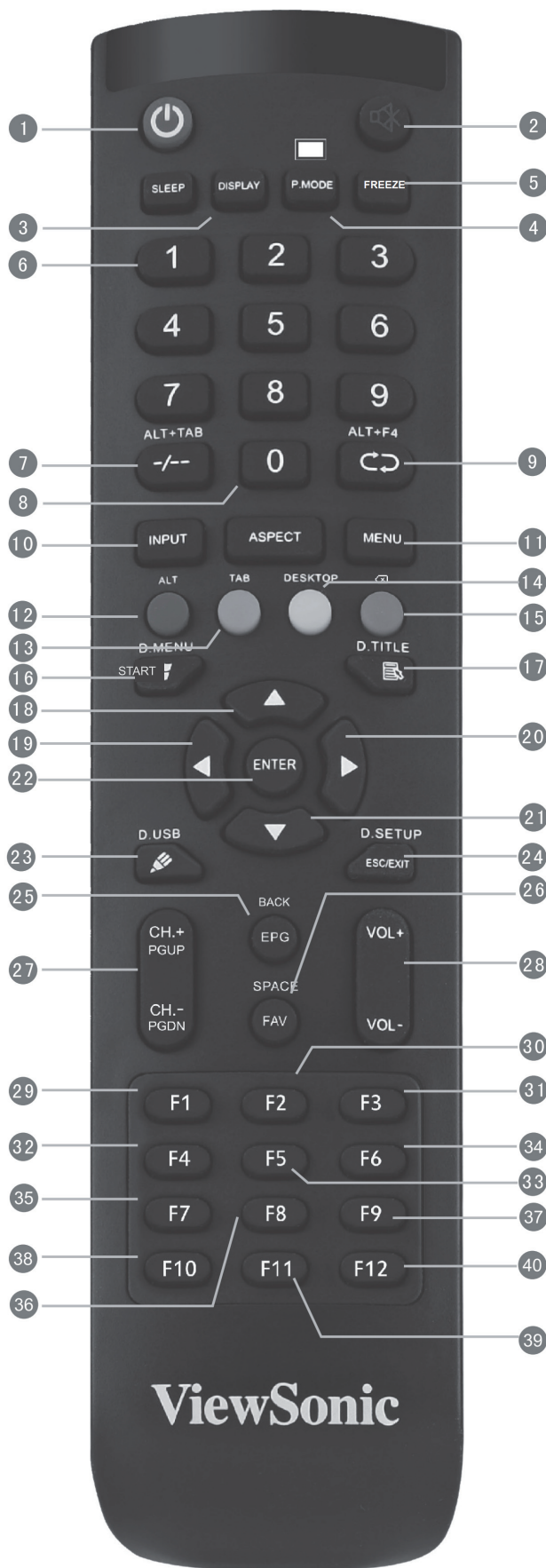

> Conectar un equipo externo

1. Para mostrar vídeo y sonido desde un equipo externo, siga las instrucciones que se indican a continuación:

Nota: Los equipos externos también se pueden conectar a la pantalla a través del cable HDMI.

 - Conecte un cable VGA (15 contactos) desde el equipo externo al puerto ENTRADA VGA de la pantalla.
 - Conecte un cable de audio desde el puerto SALIDA DE AUDIO del equipo externo al puerto ENTRADA DE AUDIO de la pantalla.
2. Conecte un cable USB al equipo externo desde el puerto SALIDA TÁCTIL de la pantalla.

Nota: Para obtener unos resultados óptimos, seleccione 1920x1080p como la resolución de entrada del equipo externo.

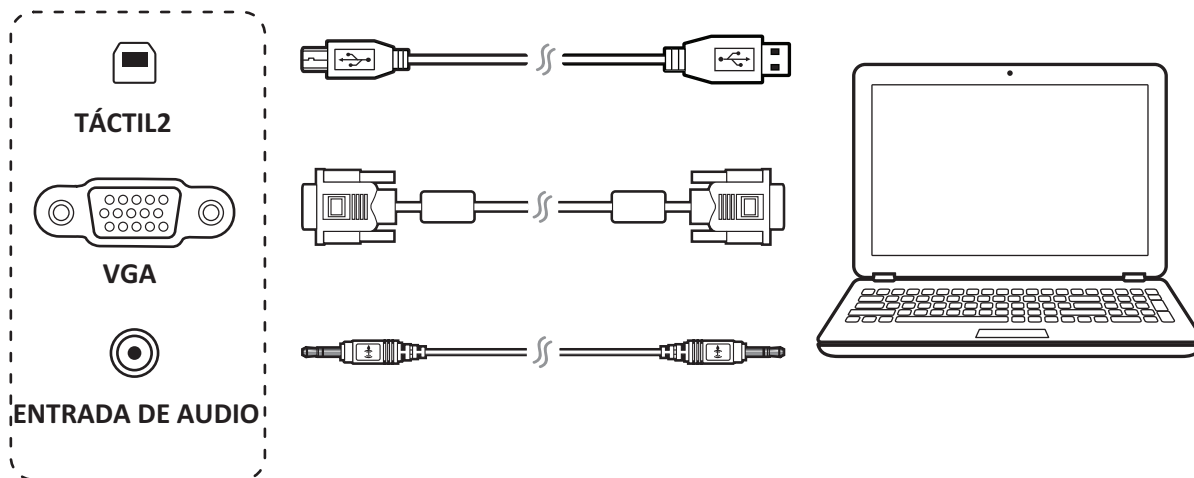

> Conexiones RS232

Cuando utilice un cable de puerto serie RS232 para conectar la pantalla a un equipo externo, determinadas funciones se pueden controlar mediante su PC, como el encendido y apagado de la alimentación, el ajuste de volumen, etc.

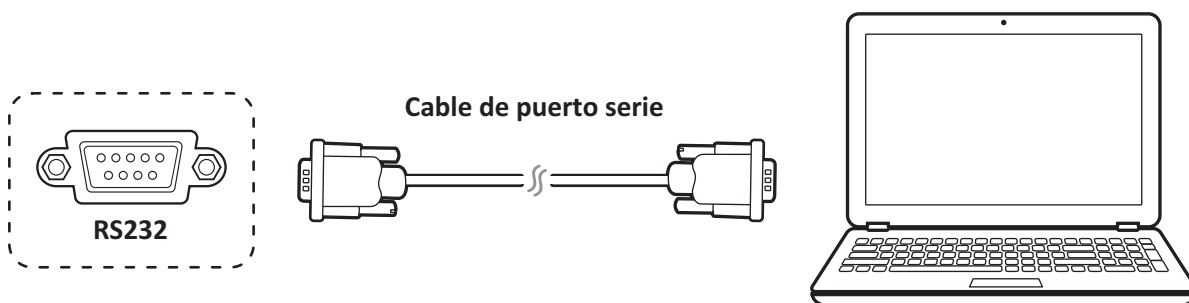

> Conectar periféricos USB

1. Periféricos USB: enchufe el cable del dispositivo USB en el puerto ENTRADA USB.
2. Cables para conexión en red y del módem: enchufe el cable del enrutador en el puerto ENTRADA LAN.
3. Micrófono: enchufe el cable del micrófono en el puerto MIC.

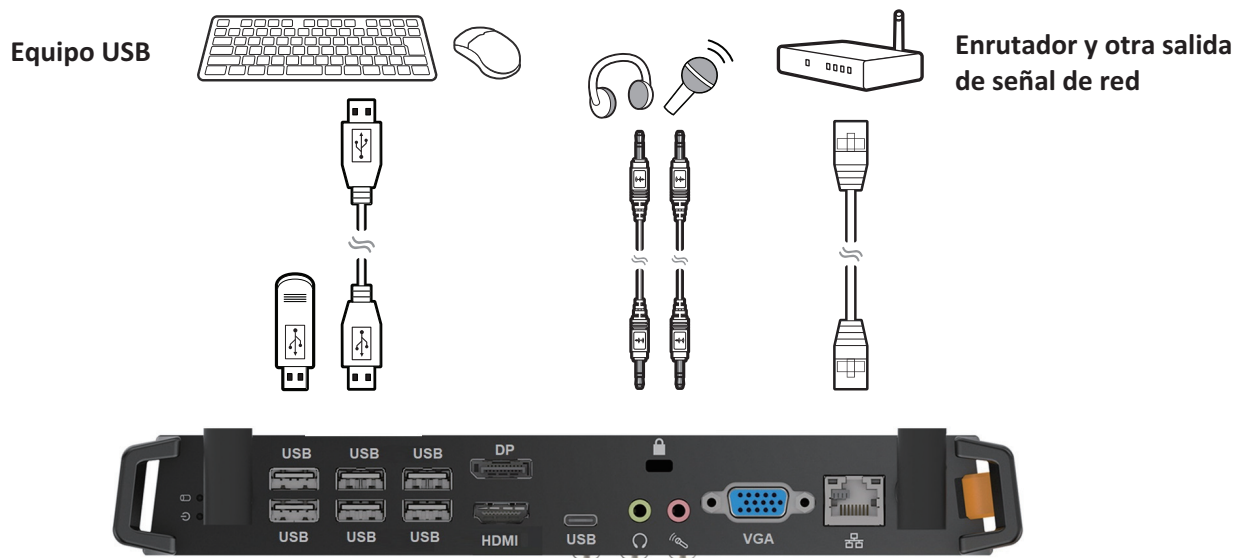

> Conexiones HDMI

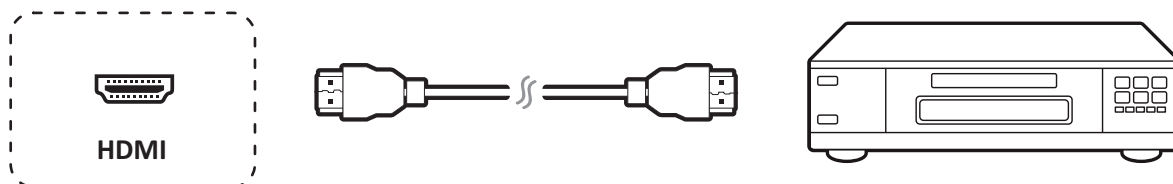

> Comenzar a usar

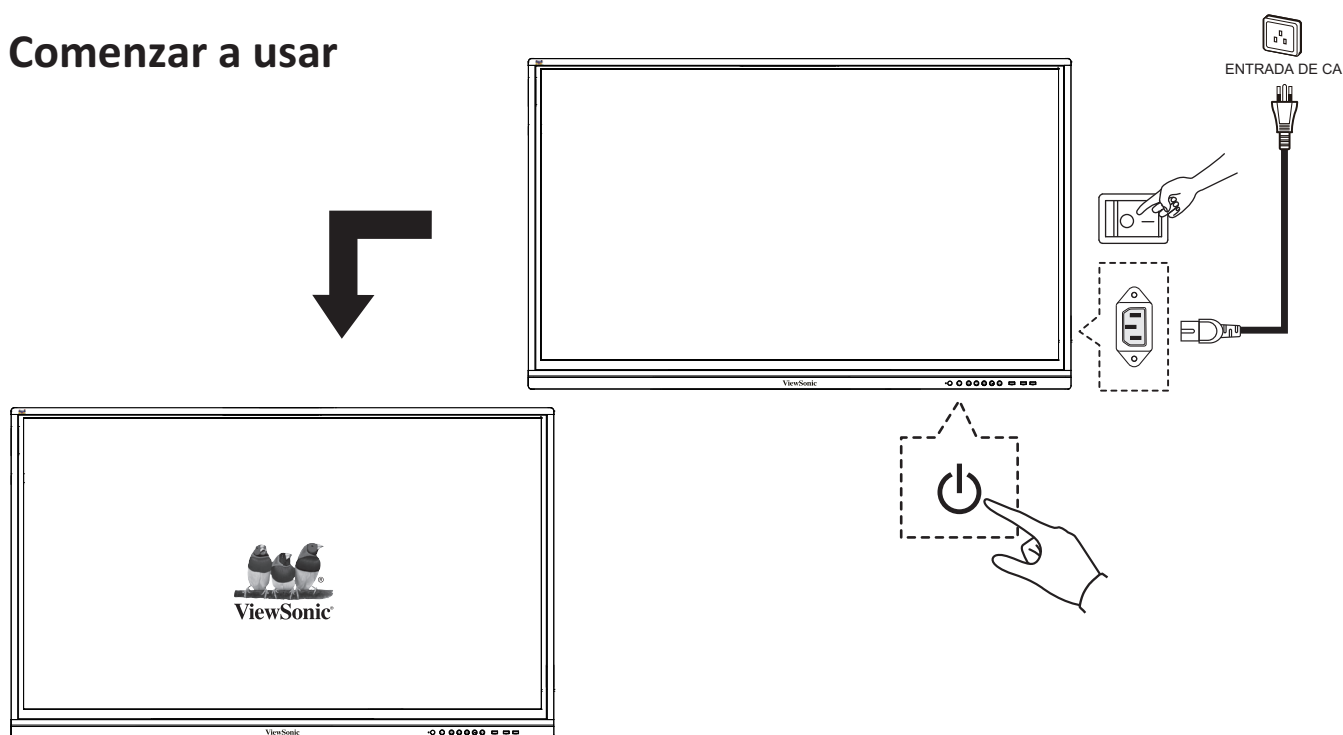



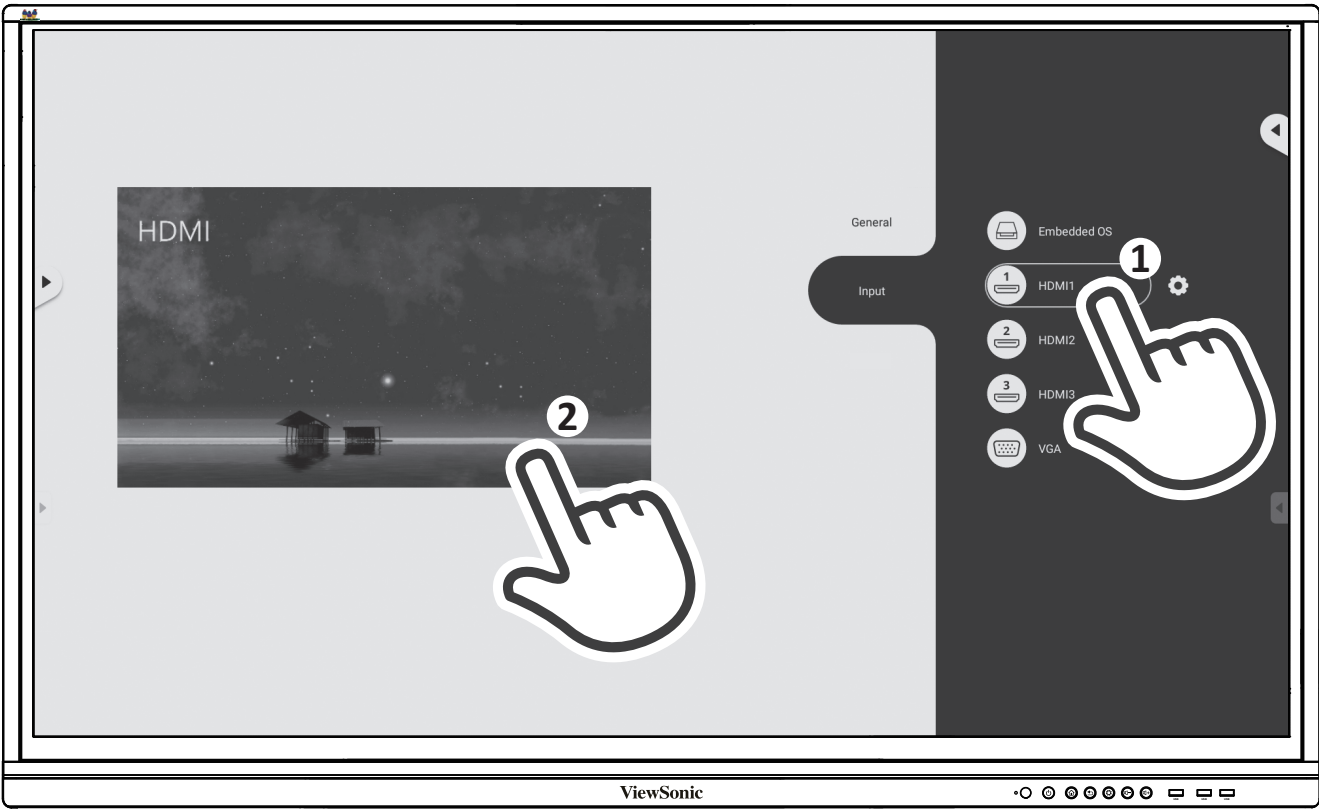
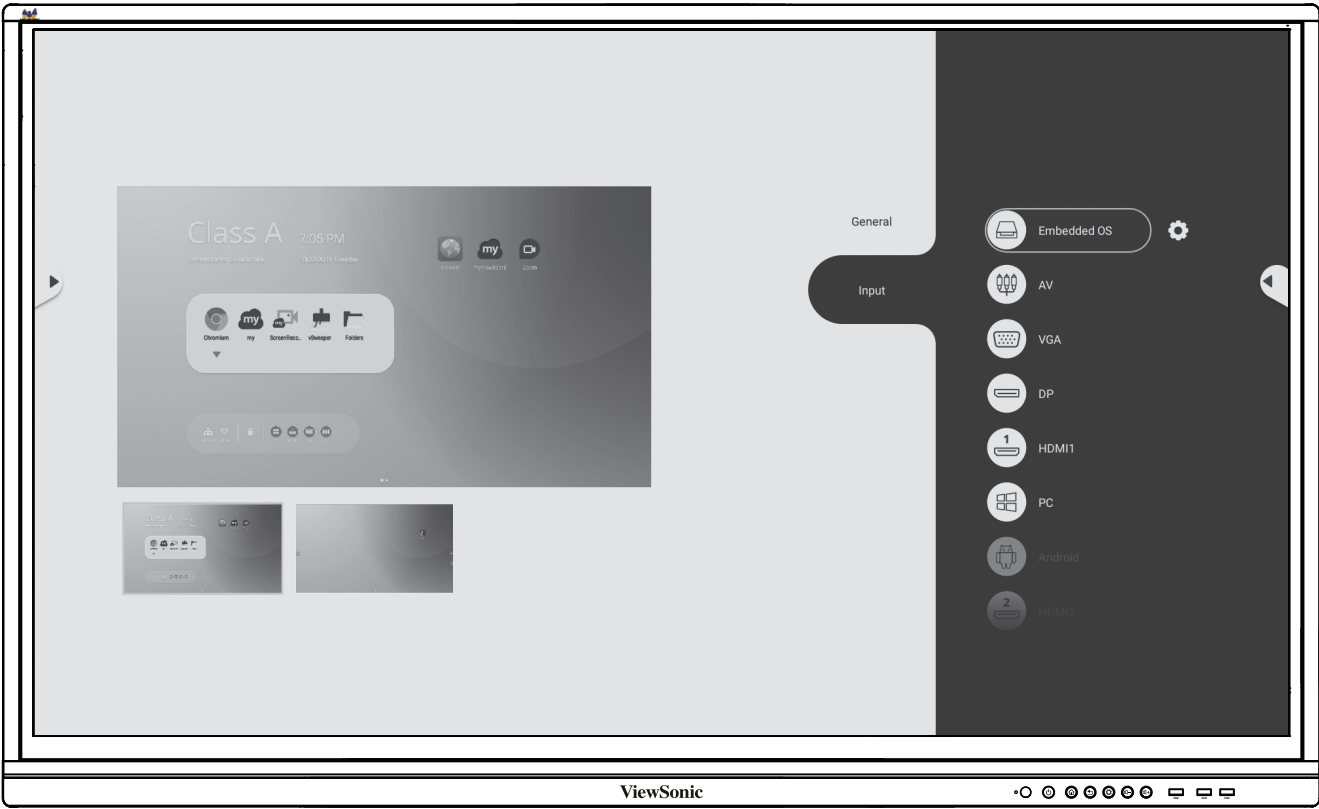

> Declaración de conformidad

Declaración de cumplimiento de la FCC: Este dispositivo cumple el Apartado 15 de las normas FCC. El funcionamiento está sujeto a las siguientes dos condiciones: (1) este dispositivo no deberá causar interferencias perjudiciales y (2) este dispositivo deberá aceptar cualquier interferencia que reciba, incluidas interferencias que puedan causar un funcionamiento no deseado.

Cumplimiento del estándar Industry Canada ICES-003: CAN ICES-3 (B)/NMB-3(B)



ViewSonic Corporation (EE. UU./Canadá/América Latina)



: www.viewsonic.com/support/product-registration



Estados Unidos



1-800-688-6688



customerservice@viewsonic.com

Canadá



1-866-463-4775



customerservice@viewsonic.com

Puerto Rico e Islas Vírgenes



<http://www.viewsonic.com/la/soporte/servicio-tecnico> (Español)

América Latina



<http://www.viewsonic.com/la/soporte/servicio-tecnico-la/>



Centro de soporte técnico
de ViewSonic



Accesorios opcionales

> Paketets innehåll

- Strömkabel (medföljer efter region)
- Fjärrkontroll
- AAA-batteri x 2
- USB-kabel
- Pekpenna
- Snabbstartsguide
- RS232-adapter
- Klämma x 5
- Kameraplatta
- Skruv
- Signalkabel kompatibel med HDMI

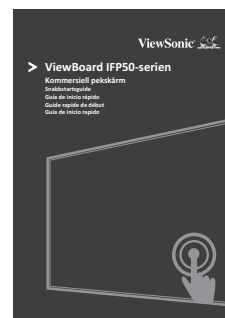
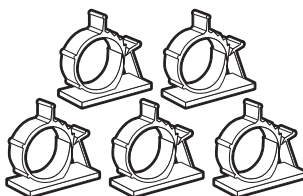
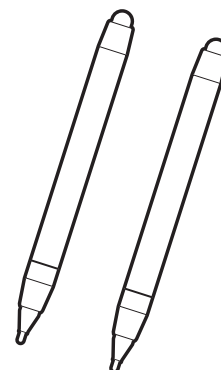
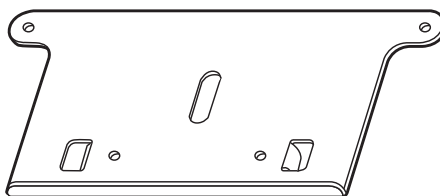
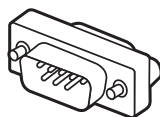
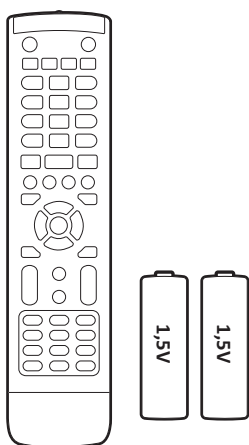
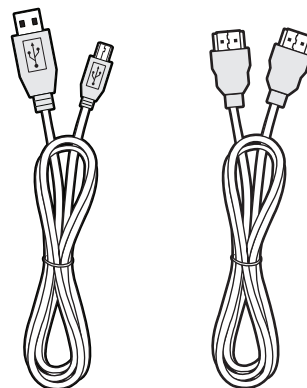
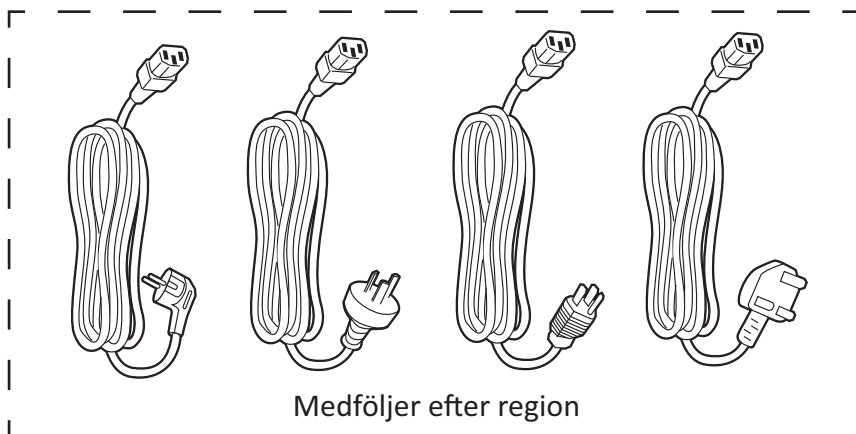

➤ Specifikationer för väggmonteringsatts (VESA)

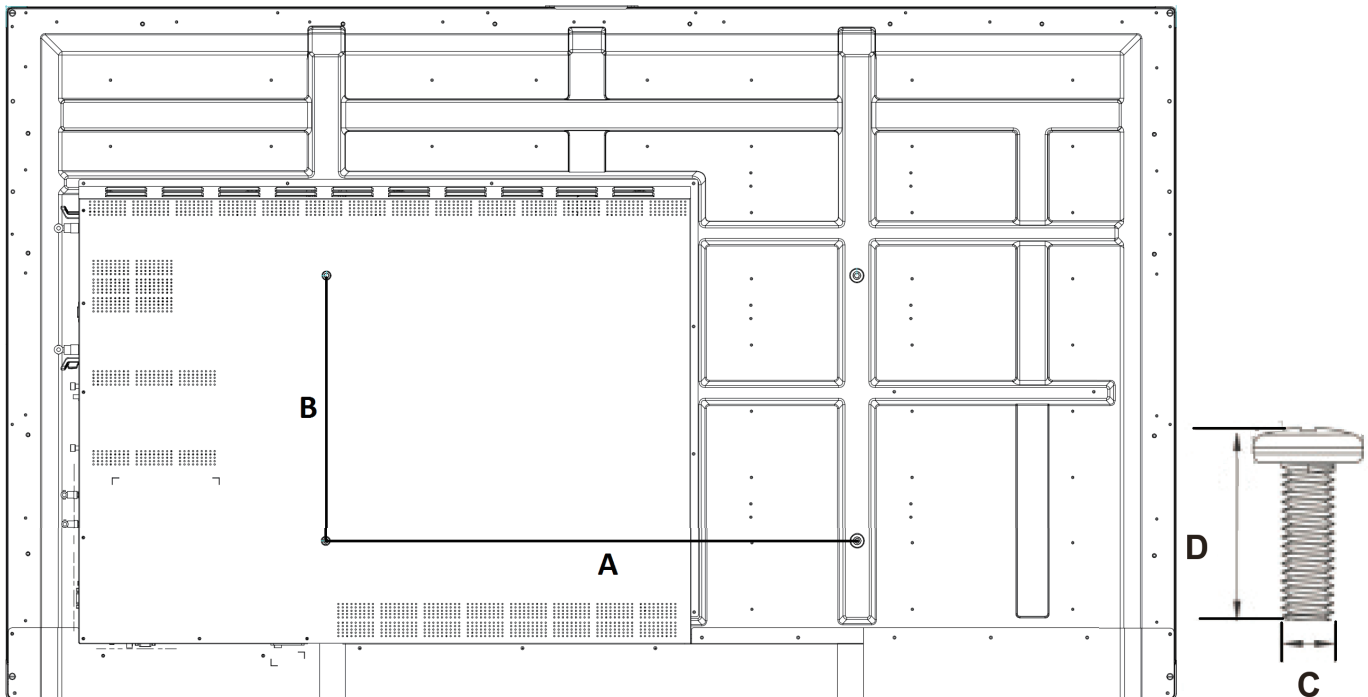

tum	VESA Spec. (A x B)	Standardskruv (C x D)	Antal
IFP5550 - 55"	400 x 200 mm	M8 x 25 mm	4
IFP6550 - 65"	600 x 400 mm	M8 x 25 mm	4
IFP7550 - 75"	800 x 400 mm	M8 x 25 mm	4
IFP8650 - 86"	800 x 600 mm	M8 x 25 mm	4

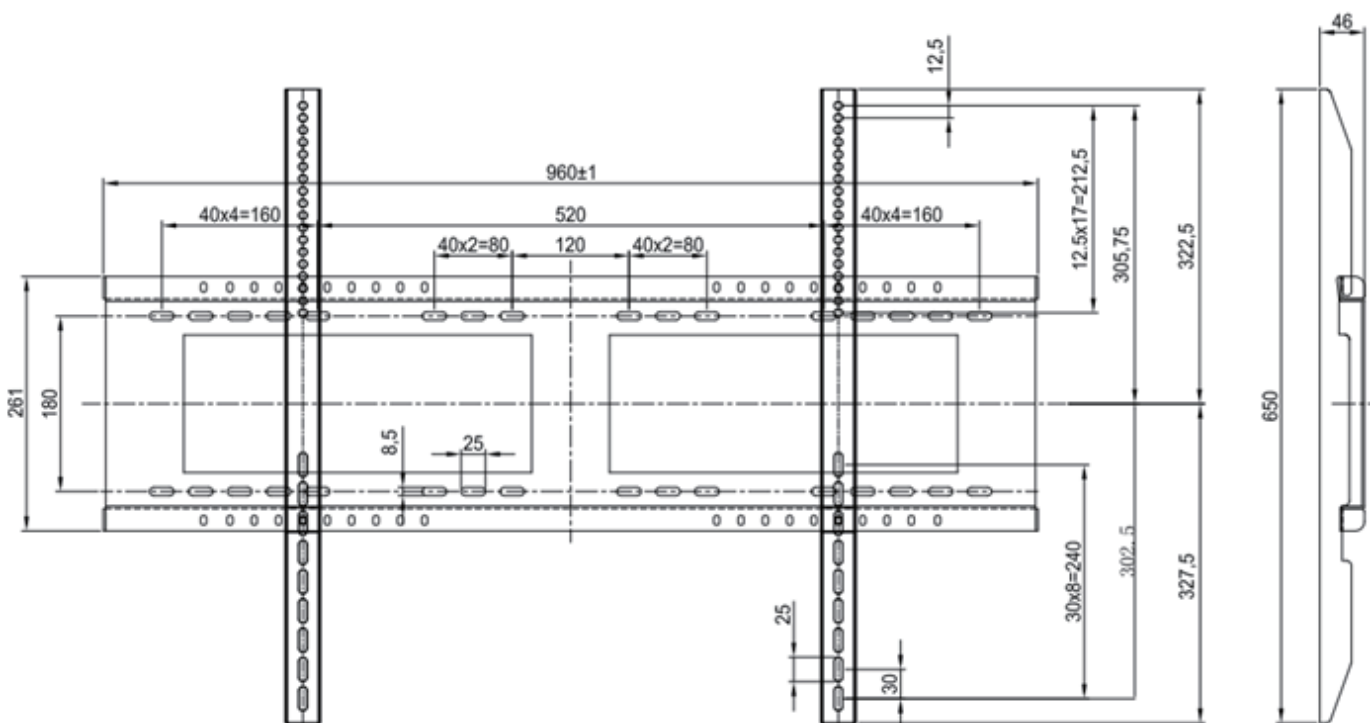

> Miljöuppmärksamhet vid installation

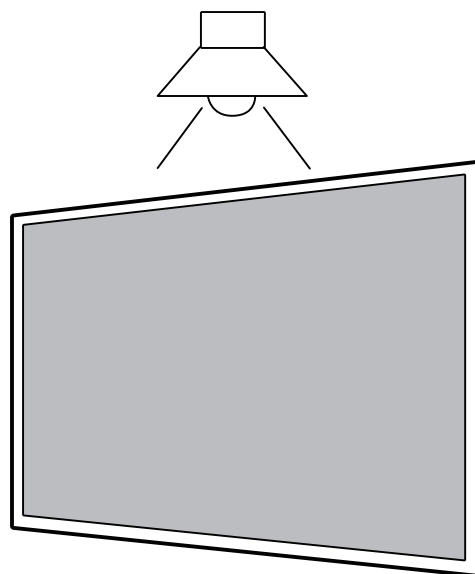
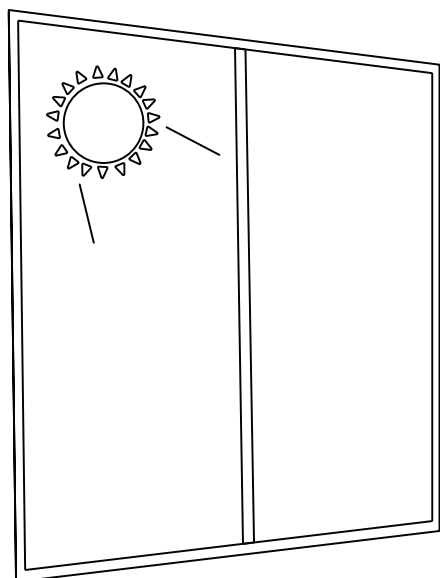
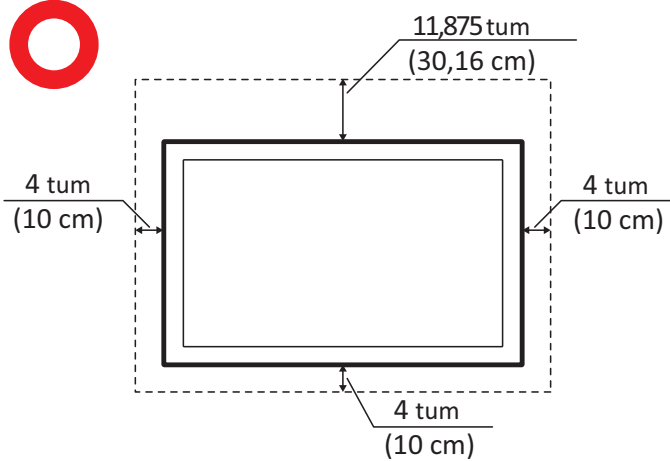
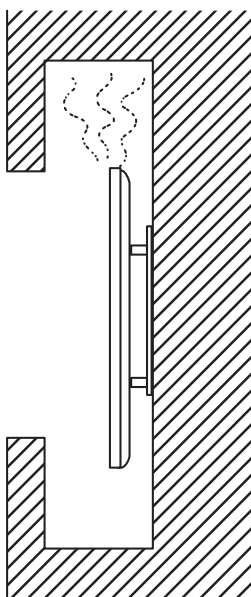

> Översikt över kontrollpanelen

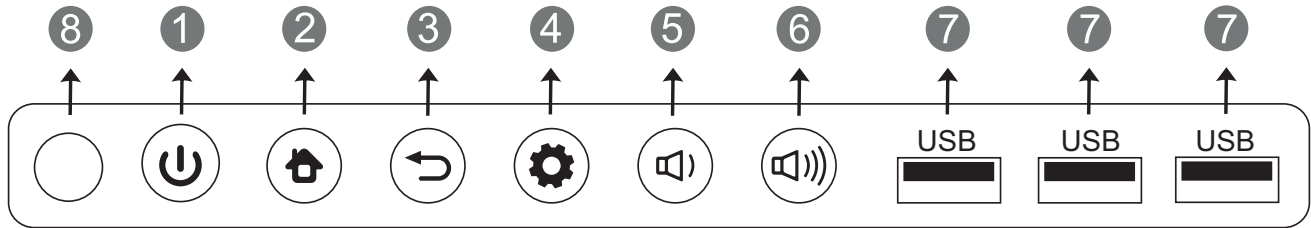





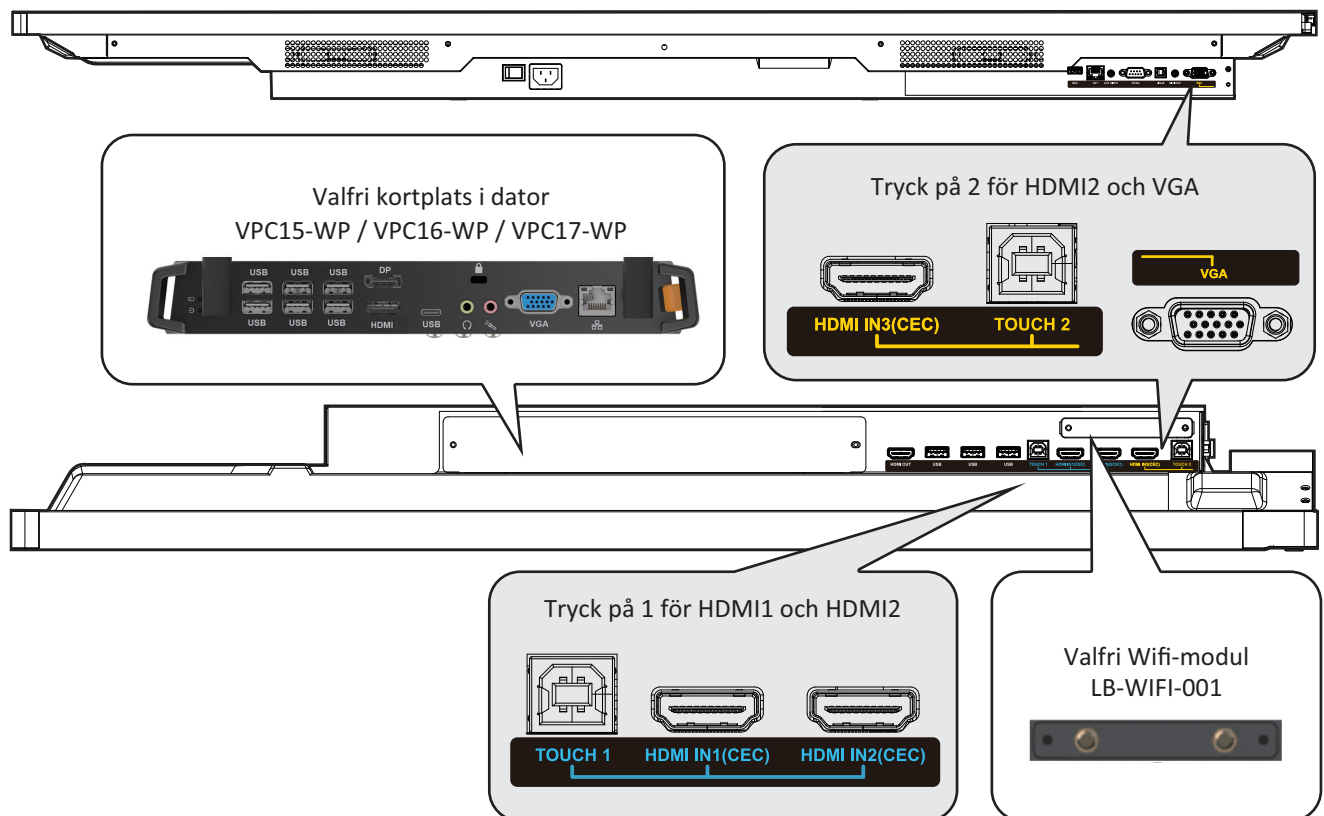



Objekt	Beskrivning
1	Tryck på knappen för att slå på enheten Tryck på knappen för att endast slå av/på skärmens bakgrundsbelysning Håll knappen intryckt för att stänga av enheten
2	Tillbaka till den inbyggda spelarens huvudgränssnitt
3	Återgå till den inbyggda spelarens föregående nivå
4	Funktionsmeny för uppringning
5	Sänk volymen
6	Öka volymen
7	USB-port för inbyggd spelare och intern dator
8	Tar emot signaler från fjärrkontrollen

> I/O-port



> Översikt över fjärrkontrollen

- | | |
|--|---|
| 1  | 22 ENTER |
| Tryck för att slå PÅ/AV skärmen | Enter-knapp. Tryck på den för att välja alternativ. |
| 2  | 23  / D. USB |
| Stäng av ljud/slå på ljud | Starta skrivprogramvara |
| 3 DISPLAY | 24 ESC / EXIT / D. SETUP |
| Visa information om den aktuella ingångskällan | Genvägsknapp för att avsluta dialogrutor |
| 4 P.MODE | 25 EPG |
| Tom skärm | Tillbaka |
| 5 FREEZE | 26 FAV / SPACE |
| Frys skärmen | PC 'Mellanslag'-knapp |
| 6 Numeric button | 27 CH. + / CH. - |
| Numerisk inmatningsknapp | CH+ : PC föregående sida
CH- : PC nästa sida |
| 7 - / -- / ALT+TAB | 28 VOL+ / VOL- |
| Tryck för att växla mellan PC-applikationer | Öka/minska volymen |
| 8 0 | 29 F1 |
| Numerisk inmatningsknapp | Windows F1-funktion |
| 9  / ALT+F4 | 30 F2 |
| Stäng det aktuella PC-fönstret | Windows F2-funktion |
| 10 INPUT | 31 F3 |
| Knapp för val av källa | Windows F3-funktion |
| 11 MENU | 32 F4 |
| Tryck för att visa menyn | Windows F4-funktion |
| 12 RED+ALT | 33 F5 |
| Skärmbild | Windows F5-funktion |
| 13 GREEN+TAB | 34 F6 |
| PC 'Flik'-knapp | Windows F6-funktion |
| 14 YELLOW+DESKTOP | 35 F7 |
| Byt till kortplats på PC-skrivbordet | Windows F7-funktion |
| 15 BLUE+BACKSPACE | 36 F8 |
| PC 'backslag'-knapp | Windows F8-funktion |
| 16 START / D. MENU | 37 F9 |
| PC 'Windows'-knapp | Windows F9-funktion |
| 17  / D.TITLE | 38 F10 |
| PC 'meny'-knapp | Windows F10-funktion |
| 18  | 39 F11 |
| Tryck för att bläddra uppåt | Windows F11-funktion |
| 19  | 40 F12 |
| Tryck för att bläddra till vänster | Windows F12-funktion |
| 20  | |
| Tryck för att bläddra till höger | |
| 21  | |
| Tryck för att bläddra nedåt | |

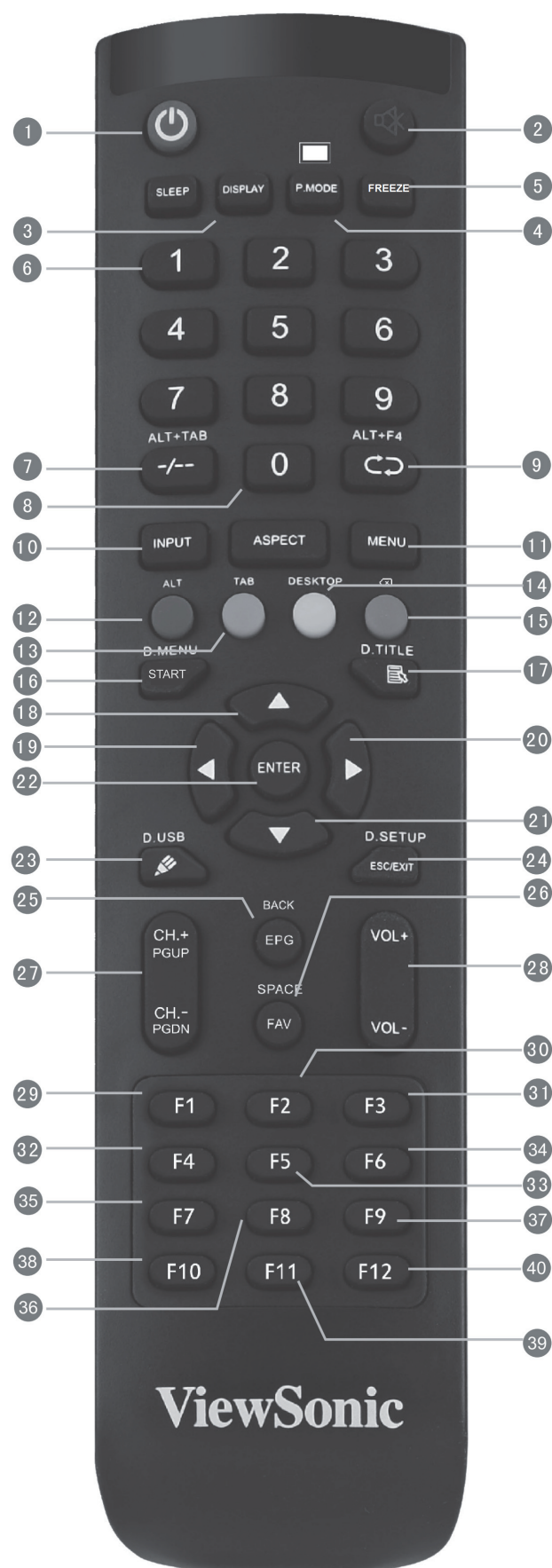

> Ansluta en extern dator

1. Följ instruktionerna nedan för att visa video och ljud från en extern dator:
Obs! Externa datorer kan också anslutas till skärmen via HDMI-kabeln.
 - Anslut en VGA-kabel (15-stift) från din externa dator till VGA IN-porten på skärmen.
 - Anslut en ljudkabel från AUDIO OUT-porten på din externa dator till AUDIO IN-porten på skärmen.
2. Anslut en USB-kabel till den externa datorn från TOUCH OUT-porten på skärmen.
Obs! För optimalt resultat, välj 1920 x 1080p som den externa datorns ingångsupplösning.

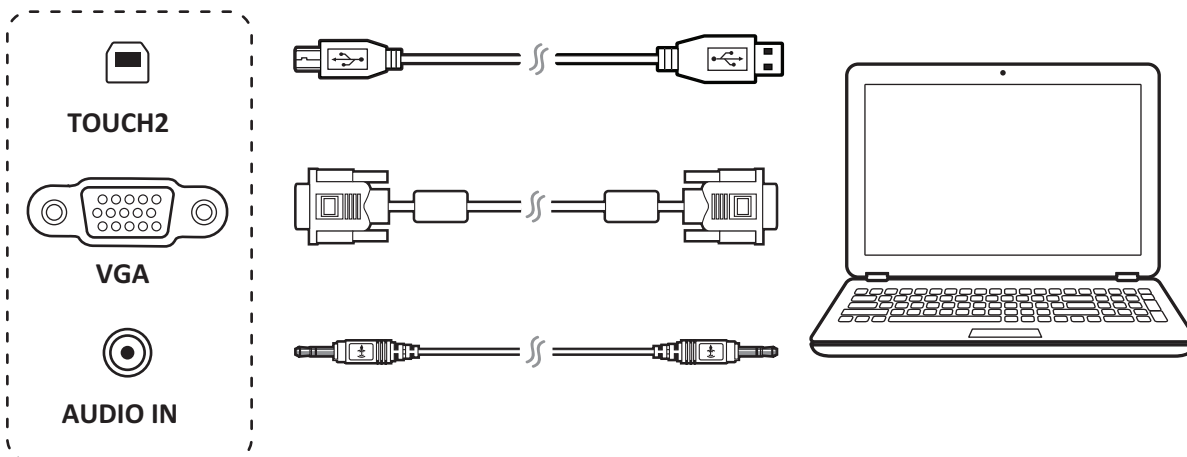

> RS232-anlutningar

När du använder en RS232 seriell portkabel för att ansluta din skärm till en extern dator kan vissa funktioner styras av datorn, inklusive ström på/av, volymjustering och mer.

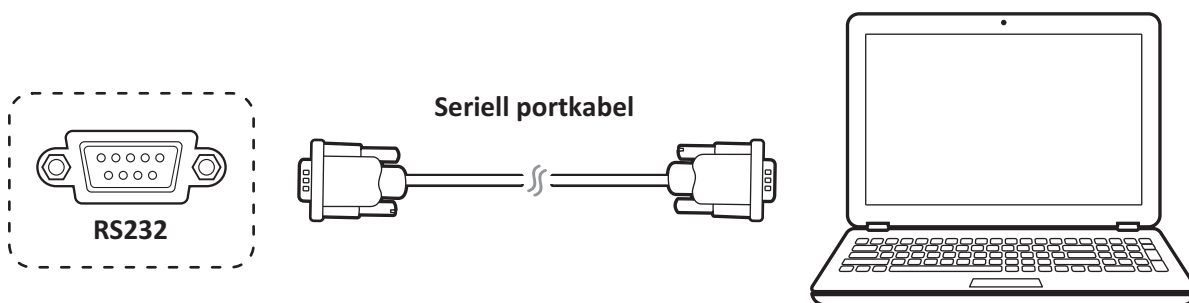

> Ansluta USB-kringutrustning

1. USB-kringutrustning: Anslut USB-enhetens kabel till USB IN-porten.
2. Nätverk och modemkablar: Anslut routerkabeln till LAN IN-porten.
3. Mikrofon: Anslut mikrofonkabeln till MIC-porten.

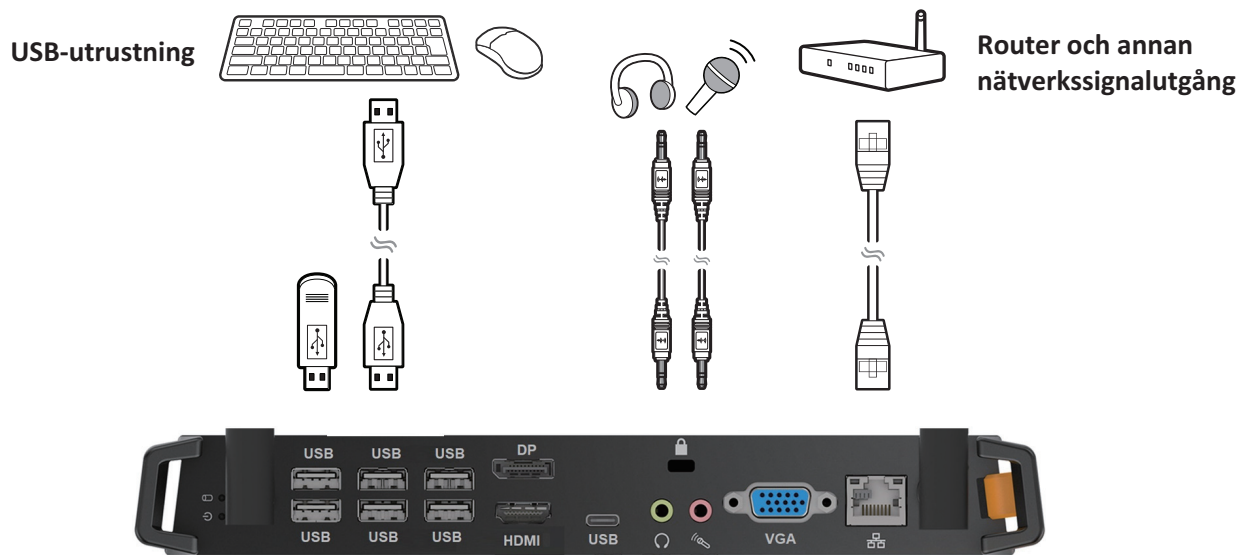

> HDMI-anlutningar

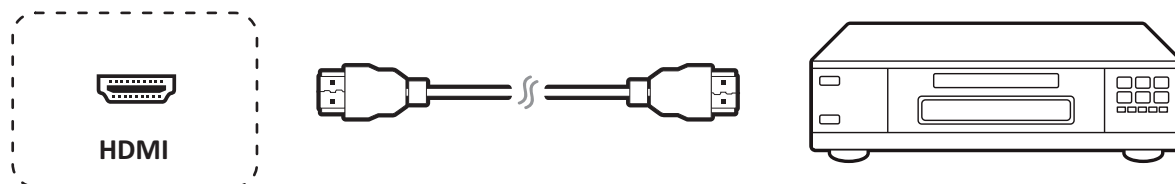

> Börja använda

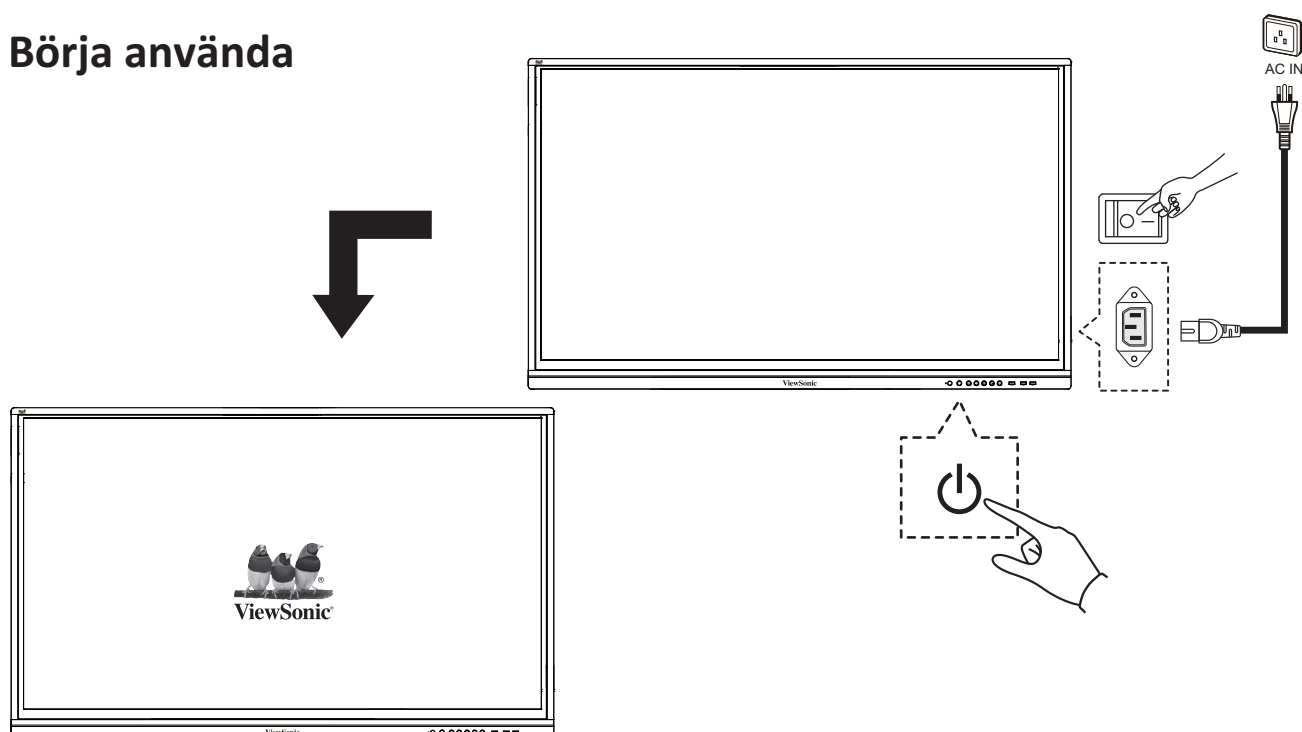



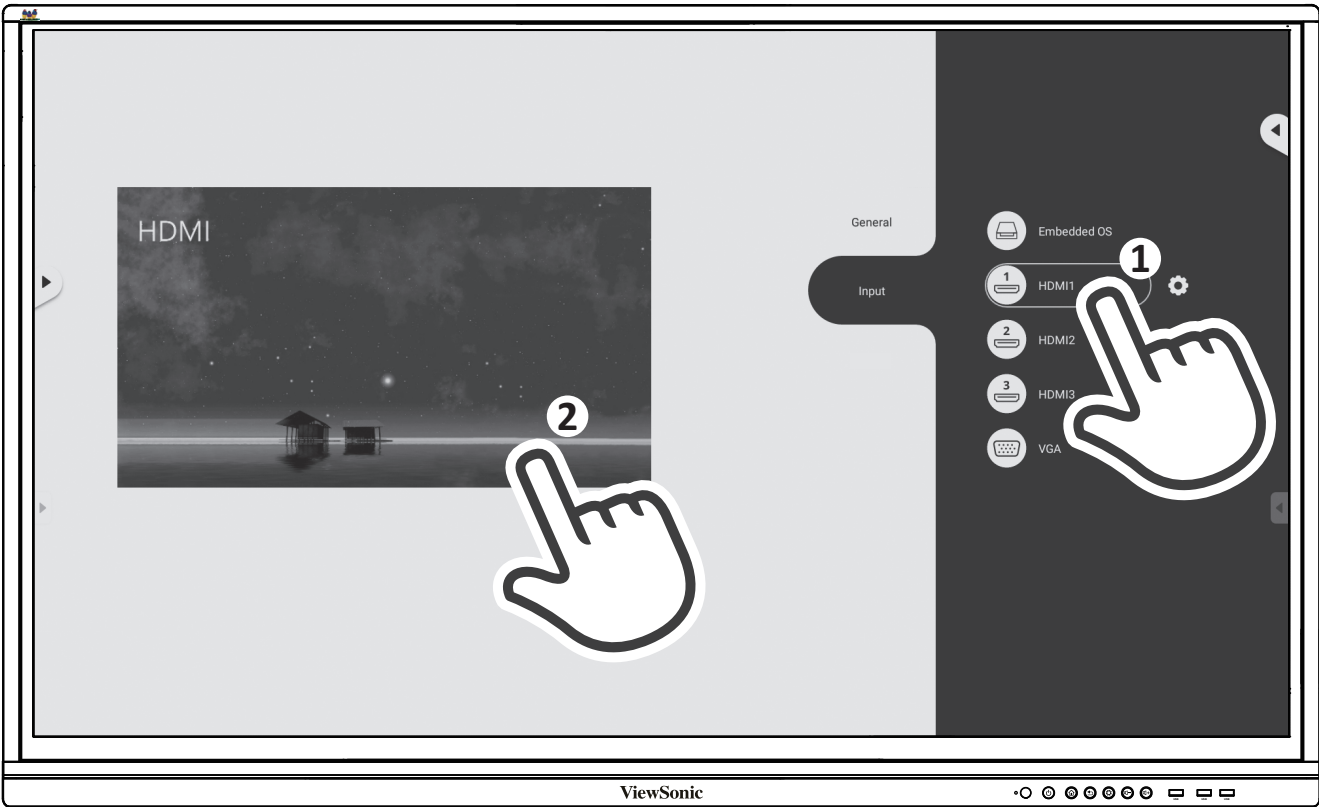
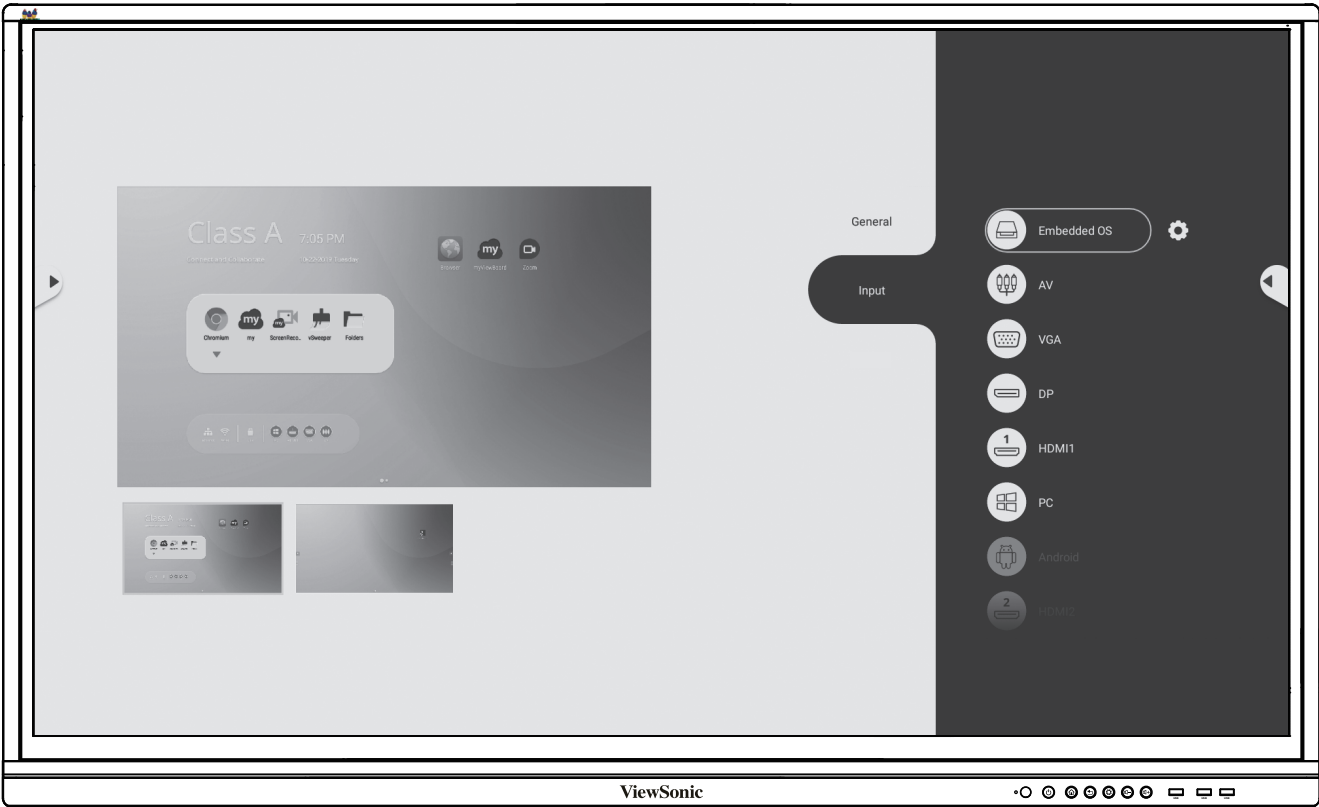

> Meddelande om efterlevnad

Uttalande gällande FCC-efterlevnad: Denna enhet överensstämmer med avsnitt 15 i FCC-reglerna. Användningen är underställd följande två villkor: (1) Enheten får inte orsaka skadliga störningar och (2) Denna enhet måste acceptera alla mottagna störningar, inklusive störningar som kan orsaka oönskad funktion.

Uttalande gällande Industry Canada ICES-003-efterlevnad: CAN ICES-3 (B)/NMB-3(B)



ViewSonic Corporation (USA/Kanada/Latinamerika)



: www.viewsonic.com/support/product-registration



United States

 1-800-688-6688

 customerservice@viewsonic.com

Canada

 1-866-463-4775

 customerservice@viewsonic.com

Puerto Rico och Jungfruöarna

 <http://www.viewsonic.com/la/soporte/servicio-tecnico> (Español)

Latin America

 <http://www.viewsonic.com/la/soporte/servicio-tecnico-la/>



ViewSonic Support Center



Extra tillbehör

> สิ่งต่างๆ ในกล่องบรรจุ

- สายไฟ (จัดส่งในบางภูมิภาค)
- รีโมทคอนโทรล
- แบตเตอรี่ AAA x 2
- สายเคเบิล USB
- ปากกาสัมผัส
- คู่มือเริ่มต้นอย่างรวดเร็ว
- อะแดปเตอร์ RS232
- ที่หนีบ x 5
- แผ่นก๊อกลง
- สกรู
- สายสัญญาณที่ใช้ได้กับ HDMI

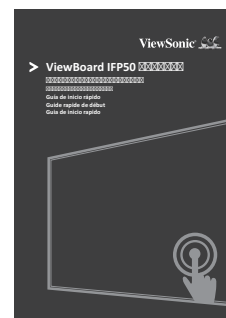
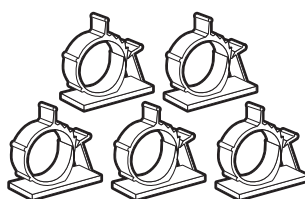
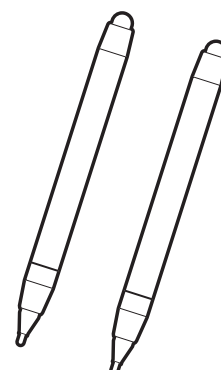
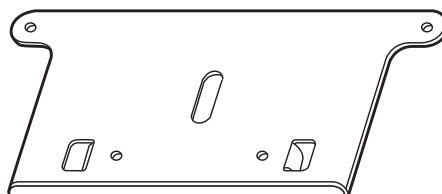
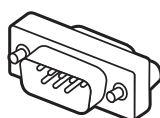
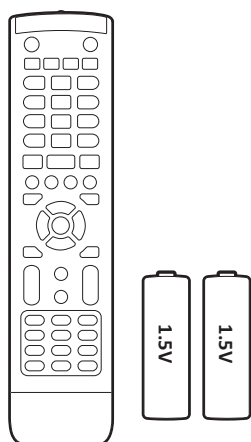
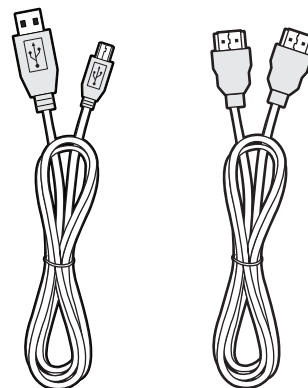

> ข้อมูลจำเพาะชุดยึดผนัง (VESA)

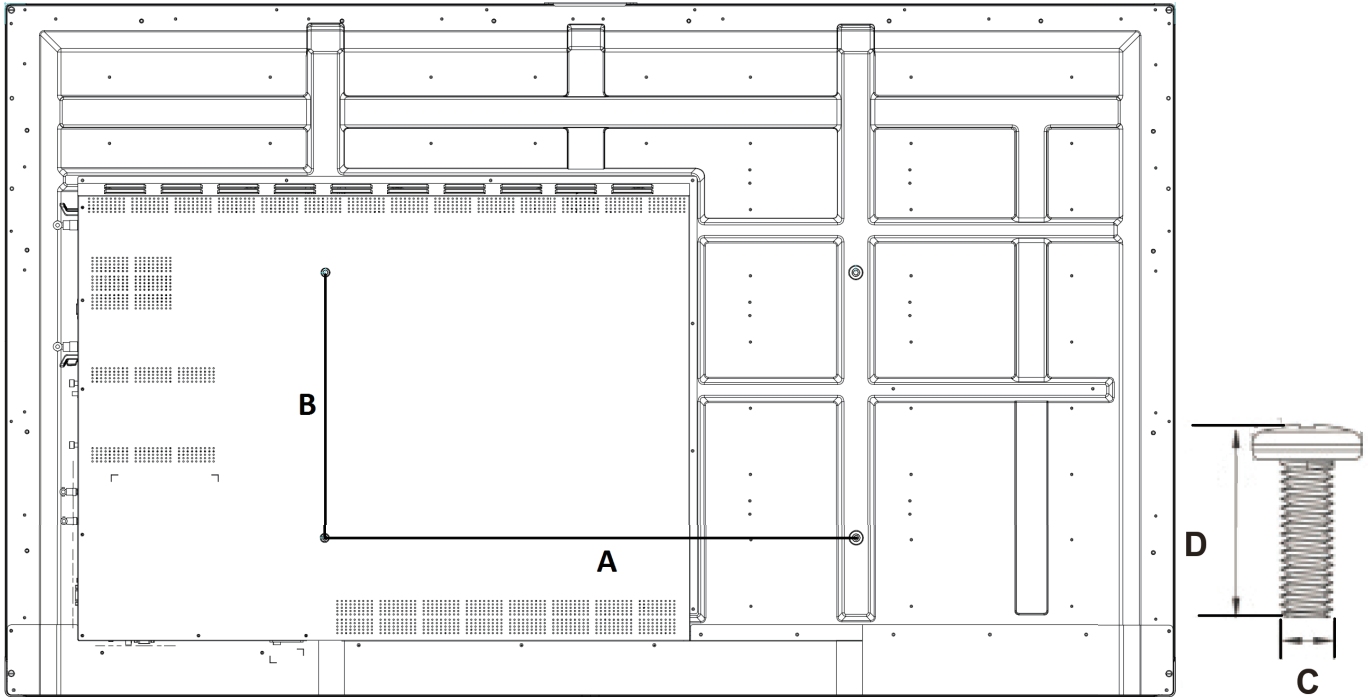

นิ้ว	ข้อมูลจำเพาะ VESA (A x B)	สกรูมาตรฐาน (C x D)	จำนวน
IFP5550 - 55"	400 x 200 มม.	M8 x 25 มม.	4
IFP6550 - 65"	600 x 400 มม.	M8 x 25 มม.	4
IFP7550 - 75"	800 x 400 มม.	M8 x 25 มม.	4
IFP8650 - 86"	800 x 600 มม.	M8 x 25 มม.	4

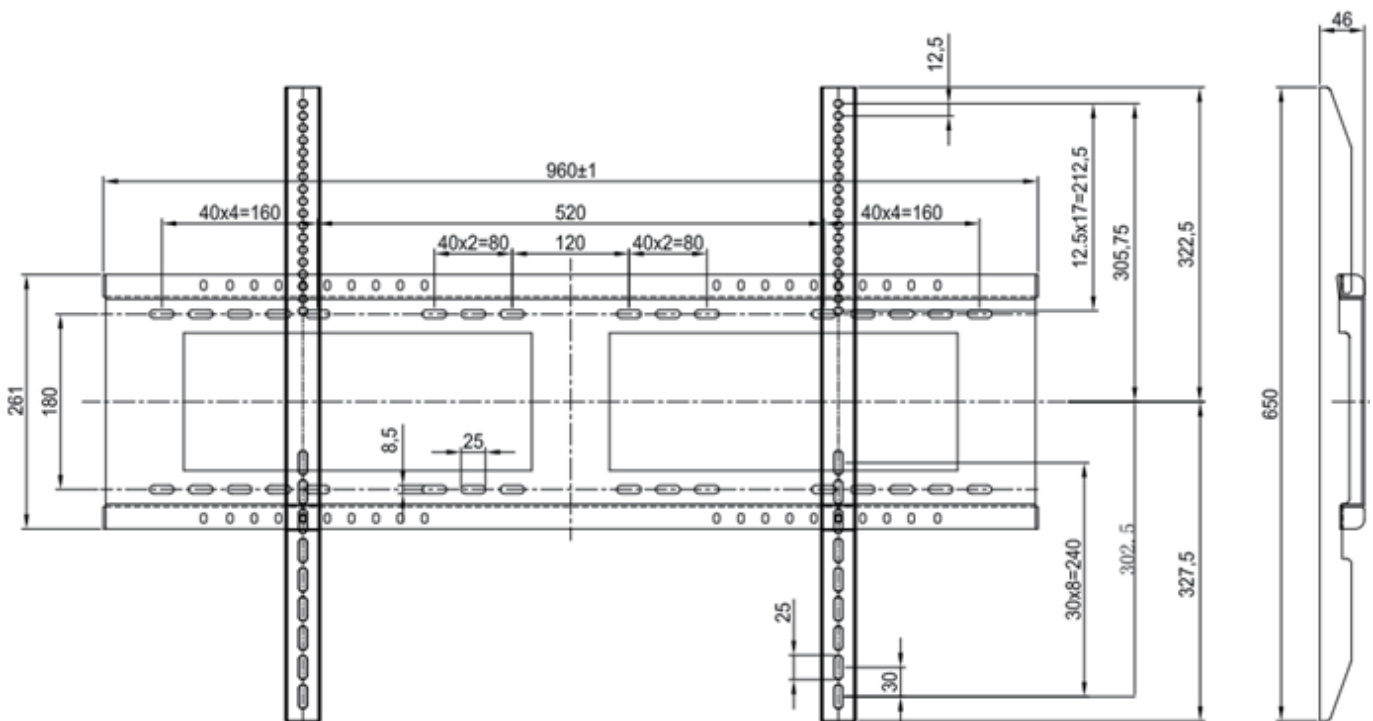

> ข้อความทราบเกี่ยวกับสิ่งแวดล้อมสำหรับการติดตั้ง

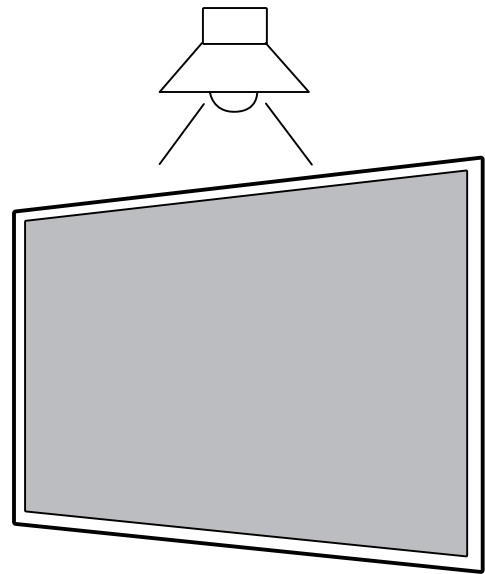
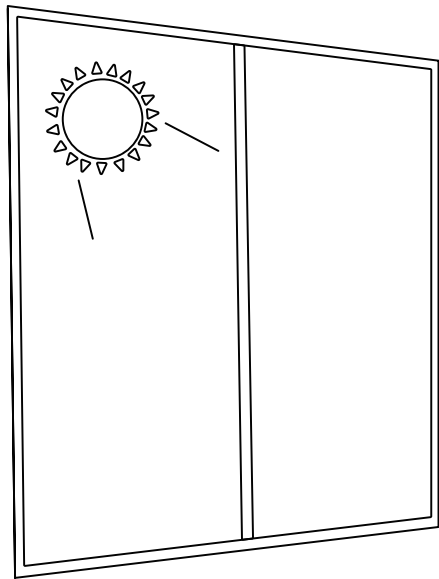
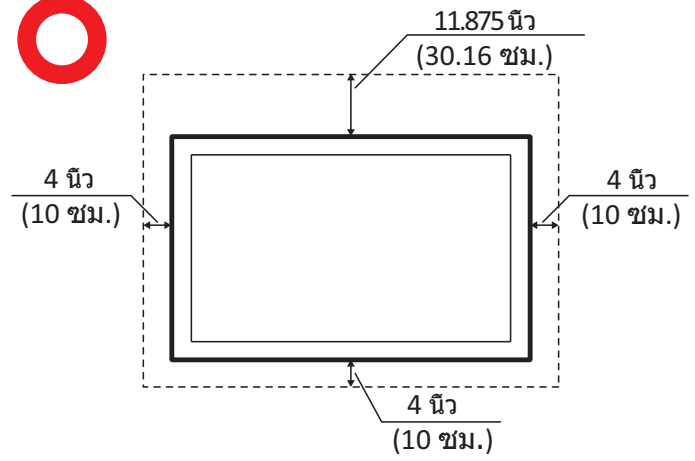
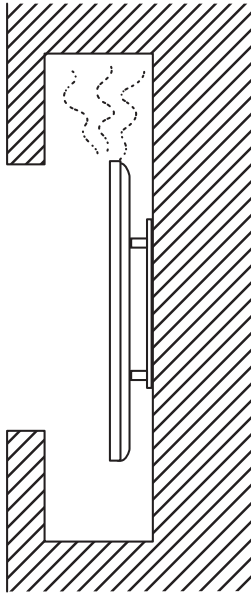

> ภาพรวมแผงควบคุม

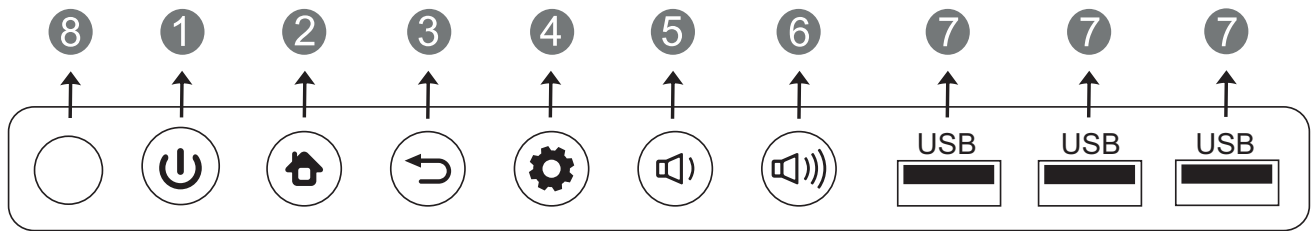





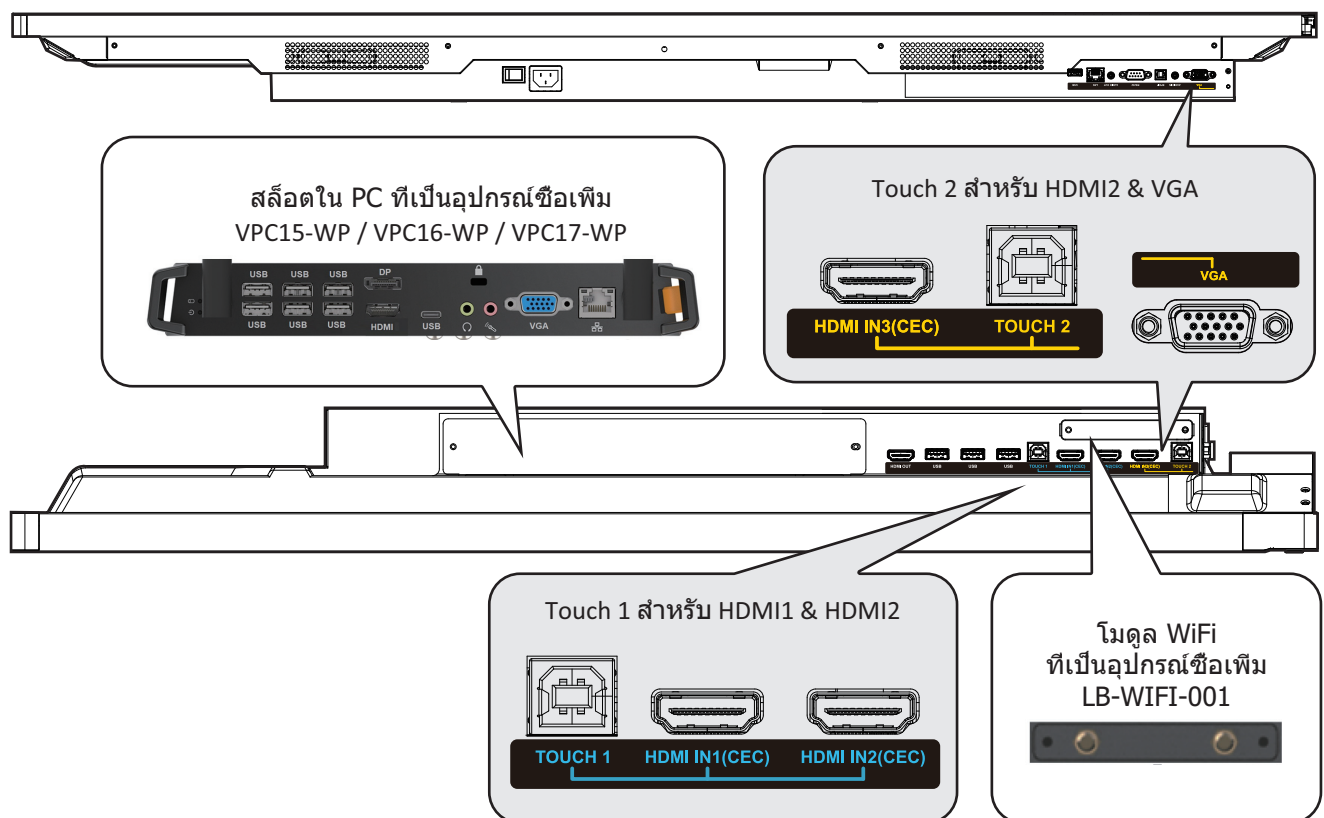

รายการ	คำอธิบาย
1	กดปุ่มนี้เพื่อเปิดเครื่องอุปกรณ์ กดปุ่มนี้เพื่อเปิด/ปิดไฟพื้นหลังการแสดงผลเท่านั้น กดปุ่มนี้ค้างเพื่อปิดเครื่องอุปกรณ์
2	กลับสู่อินเทอร์เฟซเครื่องเล่นหลัก
3	กลับสู่ระดับก่อนหน้าของเครื่องเล่น
4	เรียกเมนูฟังก์ชัน
5	ลดระดับเสียง
6	เพิ่มระดับเสียง
7	พอร์ต USB สำหรับเครื่องเล่นในตัว และ PC ภายใน
8	รับสัญญาณจากกริโมทคอนโทรล

> พอร์ต I/O



> ภาพรวมรีโมทคอนโทรล

- | | |
|--|---|
| 1  | 22 ENTER |
| กดเพื่อเปิด/ปิดจอแสดงผล | ปุ่ม Enter กดเพื่อเลือกตัวเลือก |
| 2  | 23  / D. USB |
| เปิดเสียง / เลิกปิดเสียง | เริ่มซอฟต์แวร์การเขียน |
| 3 DISPLAY | 24 ESC / EXIT / D. SETUP |
| แสดงข้อมูลของแหล่งสัญญาณปัจจุบัน | ปุ่มทางลัดเพื่อออกจากกล่องโต้ตอบ |
| 4 P.MODE | 25 EPG |
| หน้าจอว่าง | กลับ |
| 5 FREEZE | 26 FAV / SPACE |
| หยุดหน้าจอ | ปุ่ม 'Space' ของ PC |
| 6 Numeric button | 27 CH. + / CH. - |
| ปุ่มป้อนตัวเลข | CH+ : หน้าก่อนหน้าของ PC |
| 7 - / -- / ALT+TAB | CH- : หน้าถัดไปของ PC |
| กดเพื่อสลับระหว่างแอปพลิเคชัน PC | 28 VOL+ / VOL- |
| 8 0 | ปุ่มเพิ่ม / ลด |
| ปุ่มป้อนตัวเลข | 29 F1 |
| 9  / ALT+F4 | ฟังก์ชัน F1 ของ Windows |
| เปิดหน้าต่าง PC ปัจจุบัน | 30 F2 |
| 10 INPUT | ฟังก์ชัน F2 ของ Windows |
| ปุ่มเลือกสัญญาณ | 31 F3 |
| 11 MENU | ฟังก์ชัน F3 ของ Windows |
| กดเพื่อแสดงเมนู | 32 F4 |
| 12 RED+ALT | ฟังก์ชัน F4 ของ Windows |
| จับภาพหน้าจอ | 33 F5 |
| 13 GREEN+TAB | ฟังก์ชัน F5 ของ Windows |
| ปุ่ม 'Tab' ของ PC | 34 F6 |
| 14 YELLOW+DESKTOP | ฟังก์ชัน F6 ของ Windows |
| สลับไปยังเดสก์ทอป PC ในสล็อต | 35 F7 |
| 15 BLUE+BACKSPACE | ฟังก์ชัน F7 ของ Windows |
| ปุ่ม 'Backspace' ของ PC | 36 F8 |
| 16 START / D. MENU | ฟังก์ชัน F8 ของ Windows |
| ปุ่ม 'Windows' ของ PC | 37 F9 |
| 17  / D.TITLE | ฟังก์ชัน F9 ของ Windows |
| ปุ่ม 'Menu' ของ PC | 38 F10 |
| 18  | ฟังก์ชัน F10 ของ Windows |
| กดเพื่อเลื่อนขึ้น | 39 F11 |
| 19  | ฟังก์ชัน F11 ของ Windows |
| กดเพื่อเลื่อนไปทางซ้าย | 40 F12 |
| 20  | ฟังก์ชัน F12 ของ Windows |
| กดเพื่อเลื่อนไปทางขวา | |
| 21  | |
| กดเพื่อเลื่อนลง | |

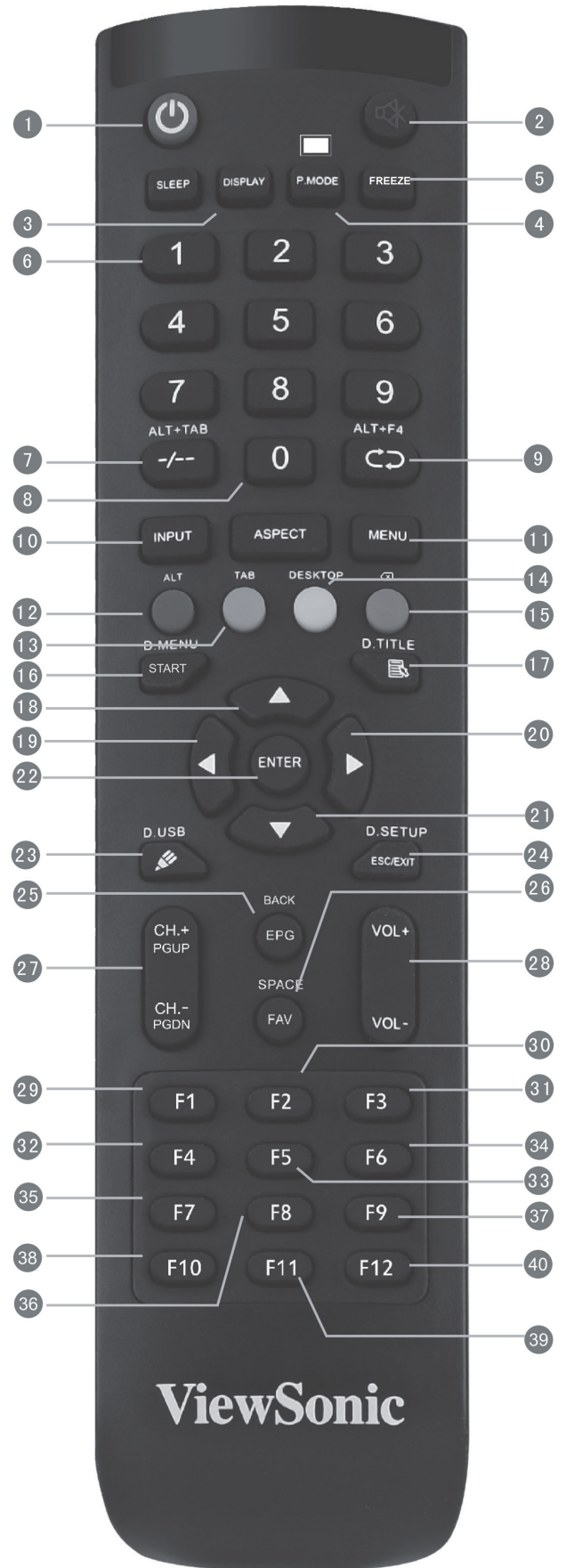

> การเชื่อมต่อกับ PC ภายนอก

1. หากต้องการแสดงวิดีโอและเสียงจาก PC ภายนอก ให้ปฏิบัติตามคำแนะนำด้านล่าง:
หมายเหตุ: สามารถเชื่อมต่อกับ PC ภายนอกผ่านทางสาย HDMI ได้ด้วย
 - เชื่อมต่อสายเคเบิล VGA (15 พิน) จาก PC ภายนอกของคุณไปยังพอร์ต VGA IN บนจอแสดงผล
 - เชื่อมต่อสายเคเบิลเสียงจากพอร์ต AUDIO OUT บน PC ภายนอกของคุณไปยังพอร์ต AUDIO IN บนจอแสดงผล
2. เชื่อมต่อสายเคเบิล USB ไปยัง PC ภายนอก จากพอร์ต TOUCH OUT ของจอแสดงผล
หมายเหตุ: เพื่อผลลัพธ์ที่ดีที่สุด ให้เลือกความละเอียดสัญญาณของเครื่องคอมพิวเตอร์ภายนอก เป็น 1920x1080p

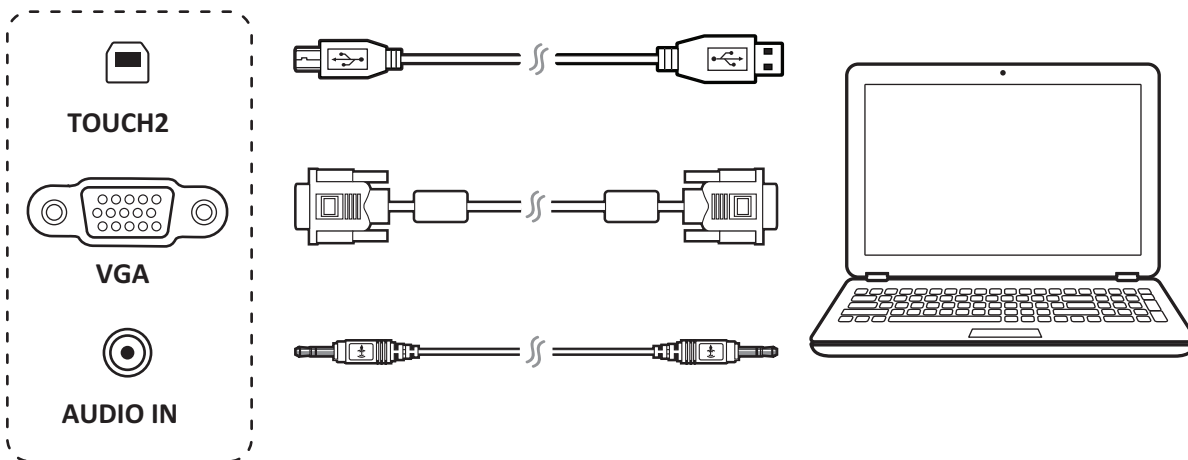

> การเชื่อมต่อ RS232

เมื่อคุณใช้สายเคเบิลพอร์ตอนุกรม RS232 เพื่อเชื่อมต่อจอแสดงผลไปยังคอมพิวเตอร์ภายนอก คุณจะ
สามารถควบคุมฟังก์ชันบางอย่างได้ด้วย PC ซึ่งประกอบด้วยการเปิด/ปิดเครื่อง การปรับระดับเสียง และอื่น ๆ

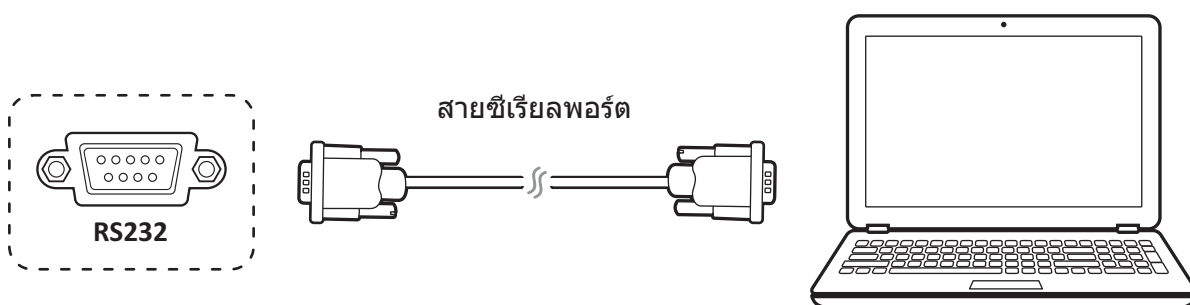

> การเชื่อมต่อกับอุปกรณ์ต่อพ่วง USB

1. อุปกรณ์ต่อพ่วง USB: เสียบสายเคเบิลอุปกรณ์ USB ลงในพอร์ต USB IN
2. สายเคเบิลเครือข่าย และโมเด็ม: เสียบสายเคเบิลเราเตอร์ลงในพอร์ต LAN IN
3. ไมโครโฟน: เสียบสายเคเบิลไมโครโฟนลงในพอร์ต MIC

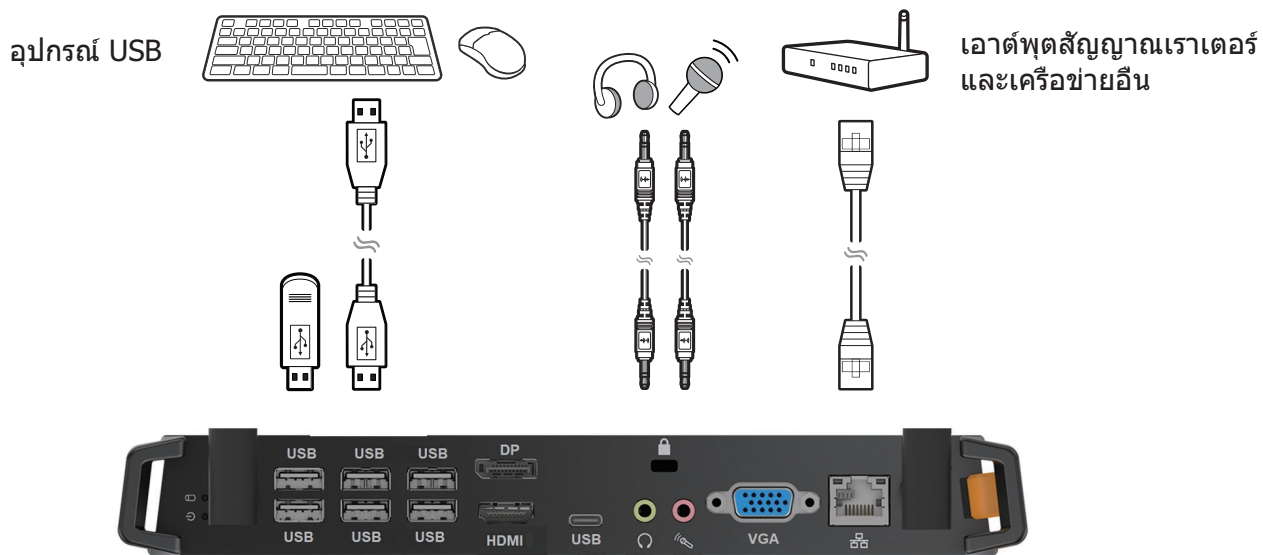

> การเชื่อมต่อ HDMI

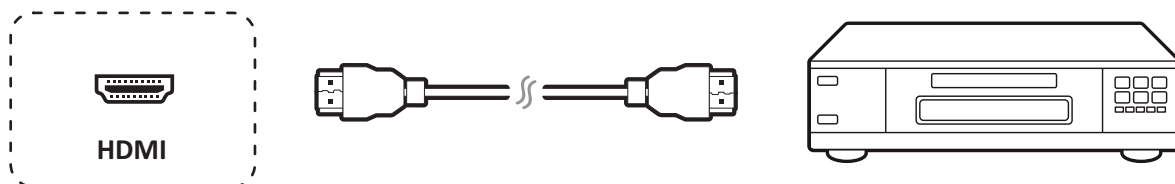

> เริ่มใช้งาน

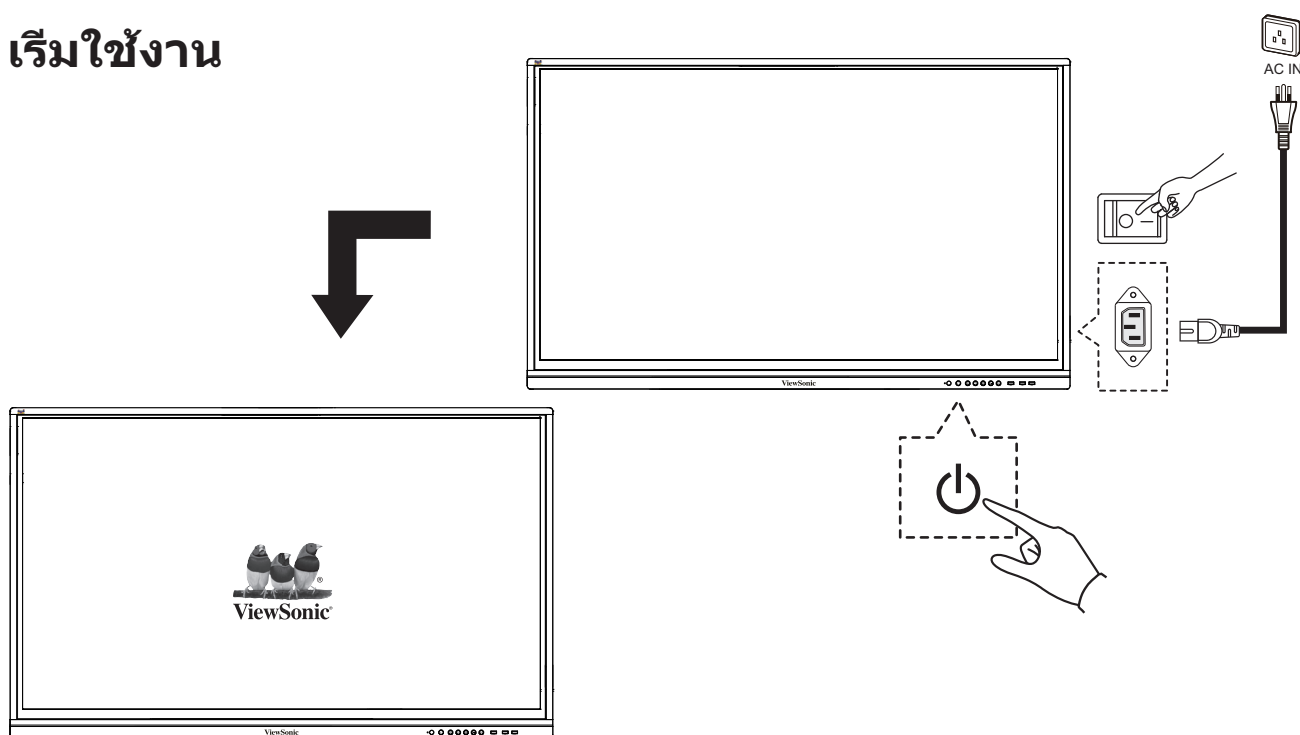



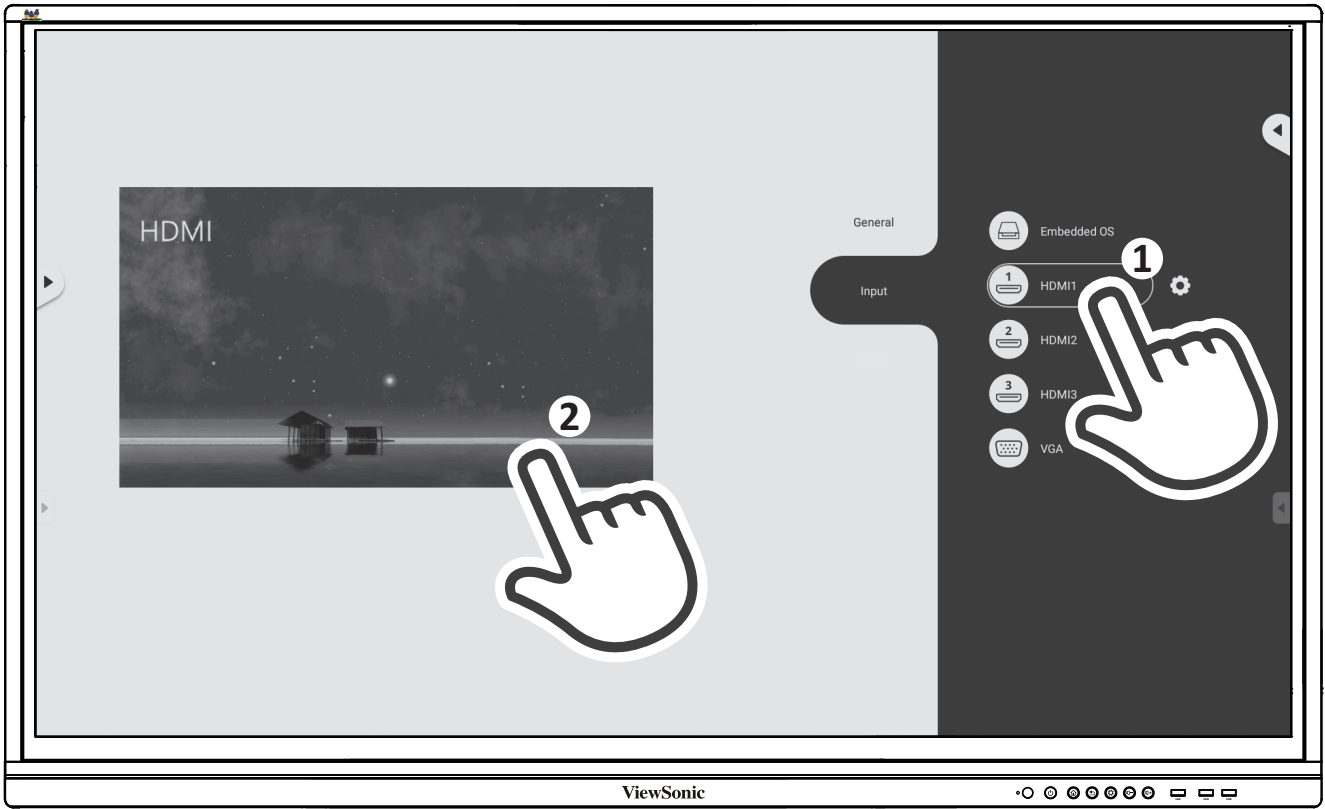
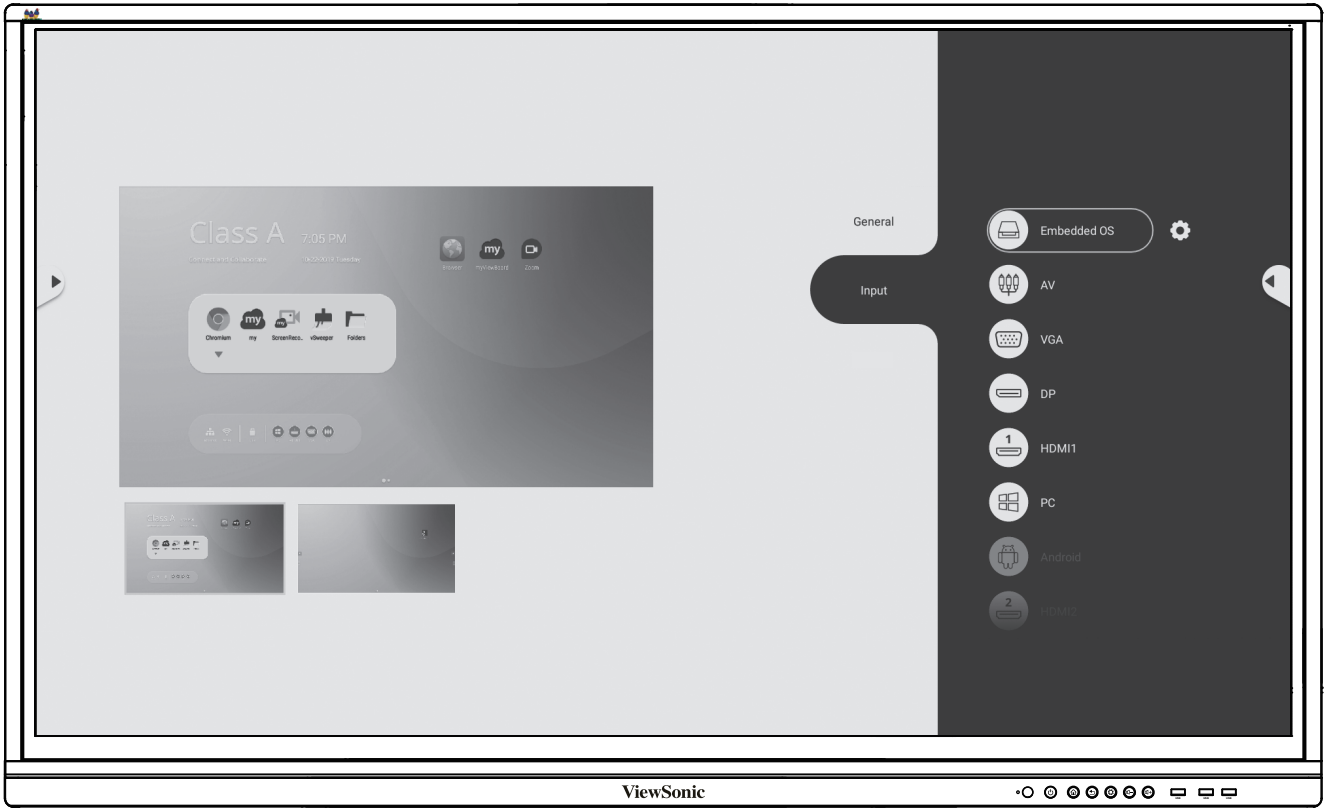

> คำแถลงเกี่ยวกับความสอดคล้อง

ถ้อยแถลงความสอดคล้องของ FCC: อุปกรณ์นี้มีคุณสมบัติตรงตามกฎข้อบังคับ FCC ส่วนที่ 15 การทำงานต้องเป็นไปตามเงื่อนไขสองข้อต่อไปนี้: (1) อุปกรณ์นี้ต้องไม่ก่อให้เกิดการรบกวนที่เป็นอันตราย และ (2) อุปกรณ์นี้ต้องทนต่อการรบกวนที่ได้รับ รวมทั้งการรบกวนที่อาจก่อให้เกิดการทำงานที่ไม่พึงประสงค์ มีคุณสมบัติตามข้อกำหนด Industry Canada ICES-003: CAN ICES-3 (B)/NMB-3(B)



ViewSonic Corporation (US/แคนาดา/ละตินอเมริกา)



: www.viewsonic.com/support/product-registration



สหรัฐอเมริกา

☎ 1-800-688-6688

✉ customerservice@viewsonic.com

แคนาดา

☎ 1-866-463-4775

✉ customerservice@viewsonic.com

เปอรโตริโก & หมู่เกาะเวอร์จิน

🏠 <http://www.viewsonic.com/la/soporte/servicio-tecnico> (Español)

ละตินอเมริกา

🏠 <http://www.viewsonic.com/la/soporte/servicio-tecnico-la/>



ศูนย์บริการสนับสนุน ViewSonic



อุปกรณ์เสริมซื้อเพิ่ม

➤ 包裝內容物

- 電源線 (依地區出貨)
- 遙控器
- AAA 電池 x 2
- USB 線
- 觸控筆
- 快速入門指南
- RS232 轉接器
- 線夾 x 5
- 攝影機板
- 螺絲
- 與 HDMI 相容的訊號線

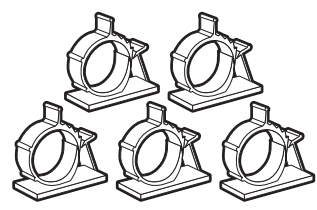
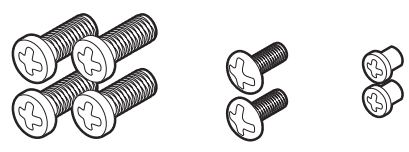
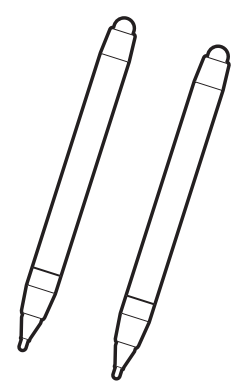
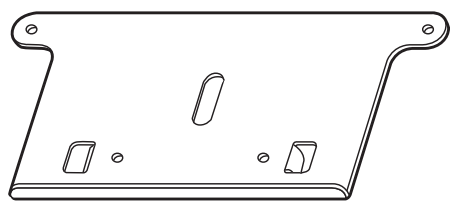
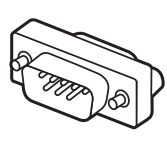
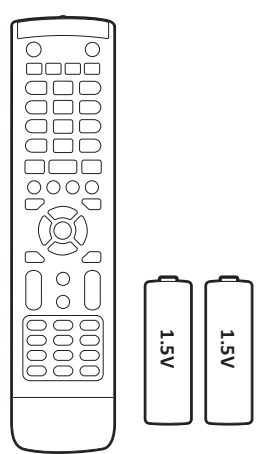
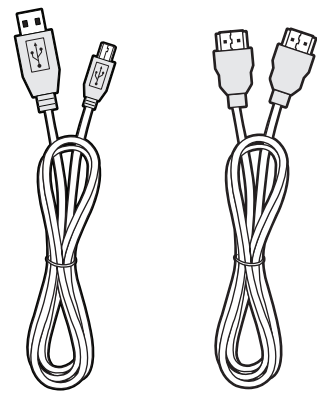
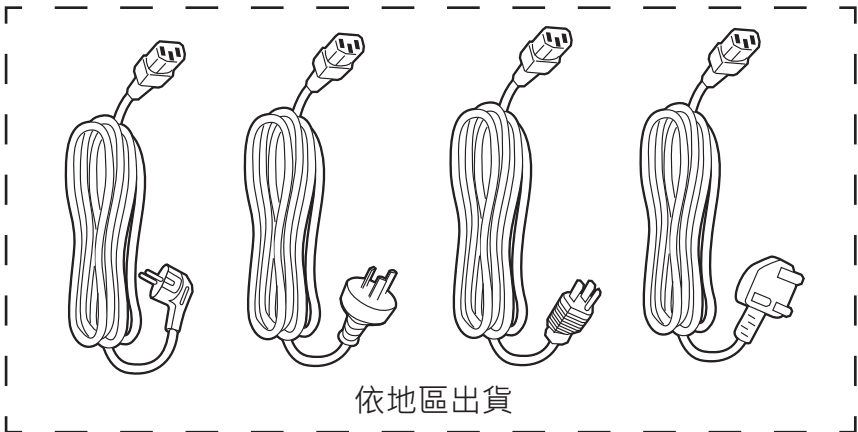

➤ 壁掛套件規格 (VESA)

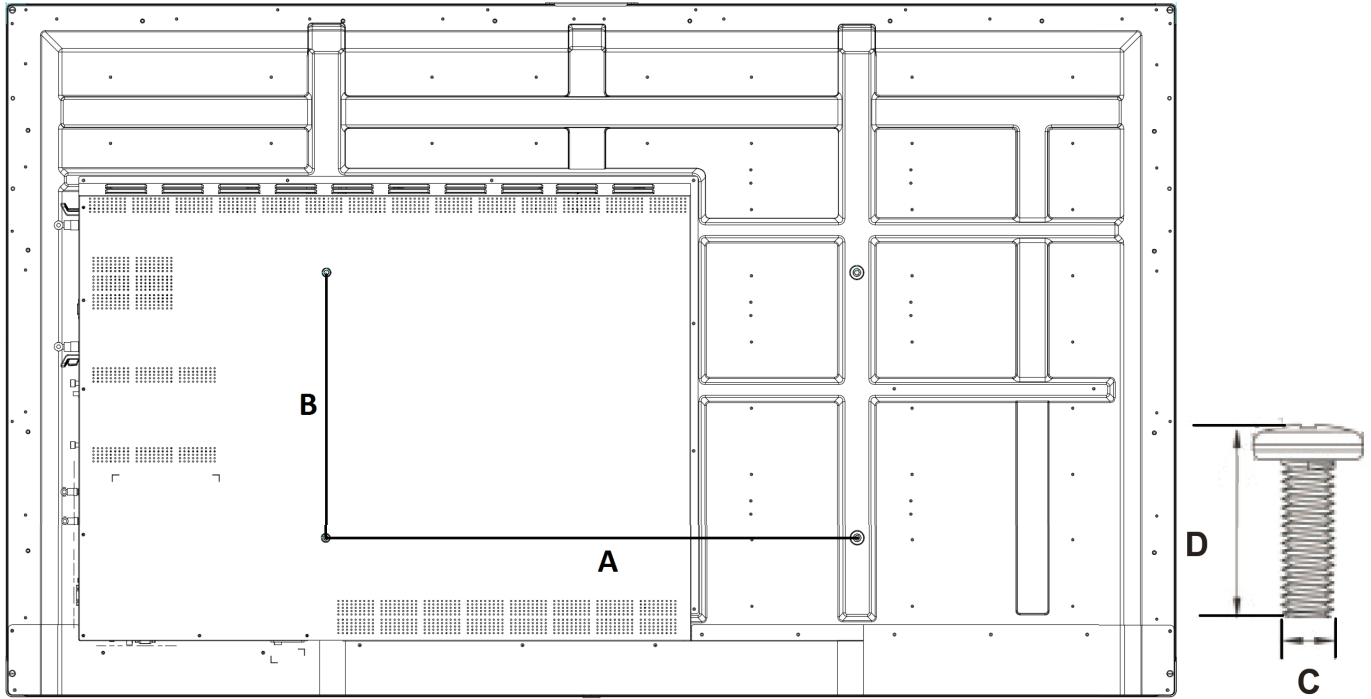

英寸	VESA 規格(A x B)	標準螺絲 (C x D)	數量
IFP5550 - 55"	400 x 200 mm	M8 x 25 mm	4
IFP6550 - 65"	600 x 400 mm	M8 x 25 mm	4
IFP7550 - 75"	800 x 400 mm	M8 x 25 mm	4
IFP8650 - 86"	800 x 600 mm	M8 x 25 mm	4

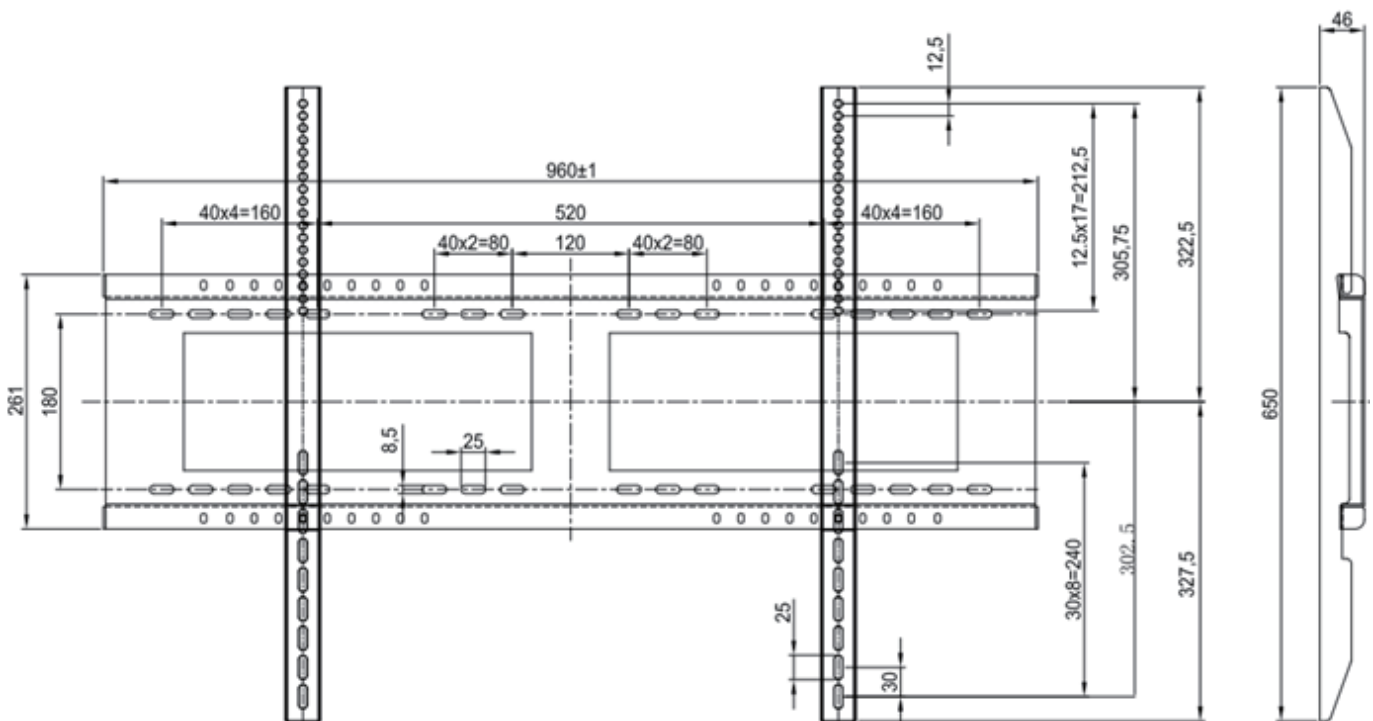

➤ 安裝環境注意

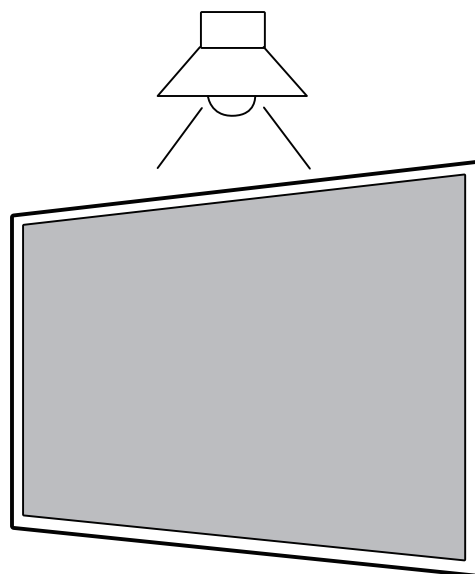
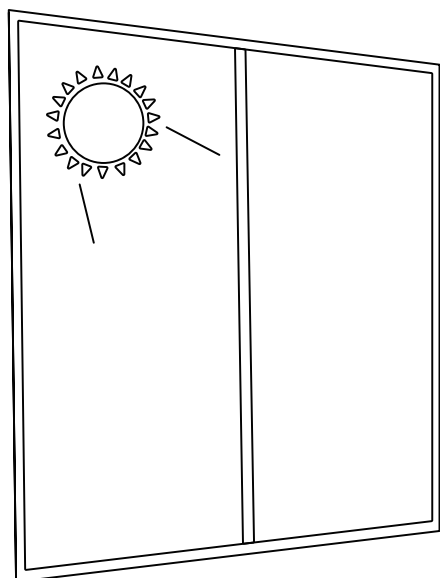
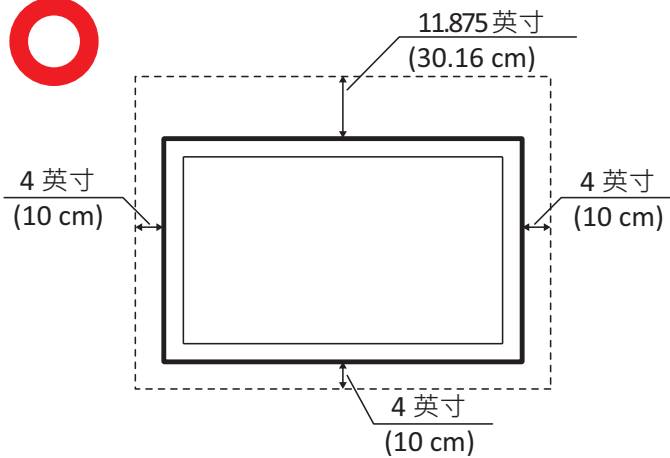
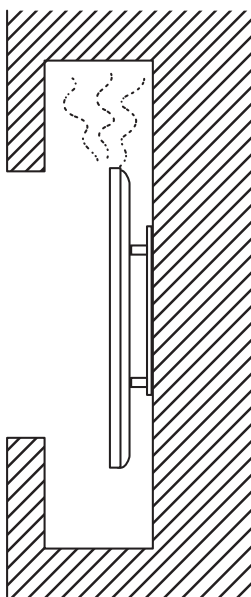

> 控制面板概觀

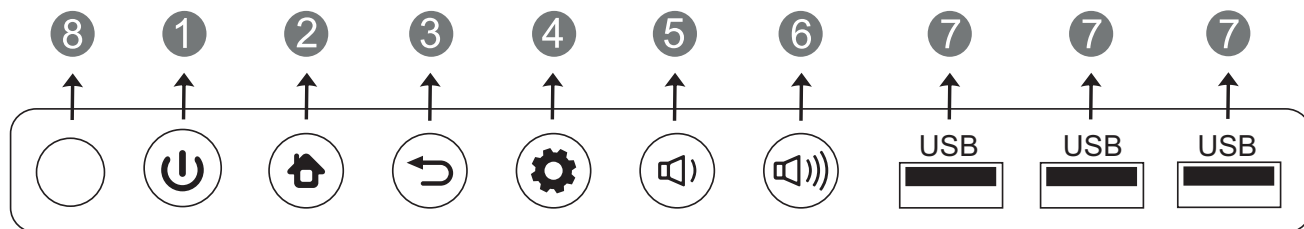

項目	說明
1	按下按鍵可開啟裝置 按下按鍵可開啟 / 關閉顯示器背光 按住按鍵可關閉裝置
2	返回嵌入式播放器主介面
3	回到嵌入式播放器上一層
4	調用功能選單
5	調低音量
6	調高音量
7	用於嵌入式播放器及內部 PC 的 USB 埠
8	接收遙控器的訊號

> I/O 連接埠

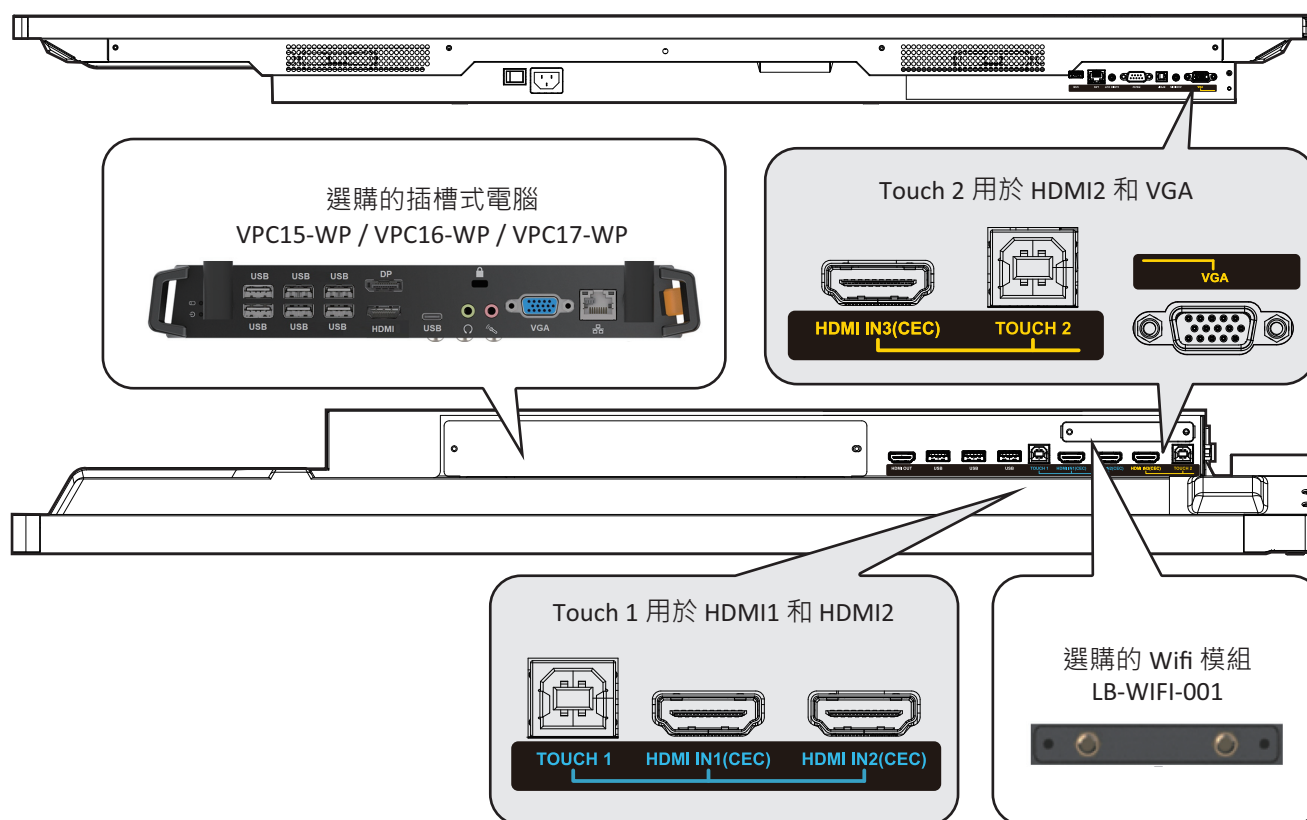

> 遙控器概觀

1 電源

按下可開啟 / 關閉顯示器

2 靜音

靜音 / 解除靜音

3 DISPLAY

顯示目前輸入來源的資訊

4 P.MODE

空白畫面

5 FREEZE

將畫面定格

6 Numeric button

數字輸入按鈕

7 -/--/ALT+TAB

按下可在電腦應用程式之間切換

8 0

數字輸入按鈕

9 關閉目前的 PC 視窗

關閉目前的 PC 視窗

10 INPUT

來源選擇按鈕

11 MENU

按下可顯示功能表

12 RED+ALT

畫面擷取

13 GREEN+TAB

PC「Tab」按鈕

14 YELLOW+DESKTOP

切換至插槽式 PC 桌面

15 BLUE+BACKSPACE

PC「Backspace」按鈕

16 START / D. MENU

PC「Windows」按鈕

17 鼠標 / D.TITLE

PC「Menu」按鈕

18 向上

按下可向上捲動

19 向左

按下可向左捲動

20 向右

按下可向右捲動

21 向下

按下可向下捲動

22 ENTER

輸入按鈕。按下可選擇選項。

23 書寫軟體啟動

書寫軟體啟動

24 ESC / EXIT / D. SETUP

用來退出對話方塊的捷徑按鈕

25 EPG

返回

26 FAV / SPACE

PC「Space」按鈕

27 CH. + / CH. -

CH+: PC 上一頁
CH-: PC 下一頁

28 VOL+ / VOL-

調高 / 調低音量

29 F1

Windows F1 功能

30 F2

Windows F2 功能

31 F3

Windows F3 功能

32 F4

Windows F4 功能

33 F5

Windows F5 功能

34 F6

Windows F6 功能

35 F7

Windows F7 功能

36 F8

Windows F8 功能

37 F9

Windows F9 功能

38 F10

Windows F10 功能

39 F11

Windows F11 功能

40 F12

Windows F12 功能

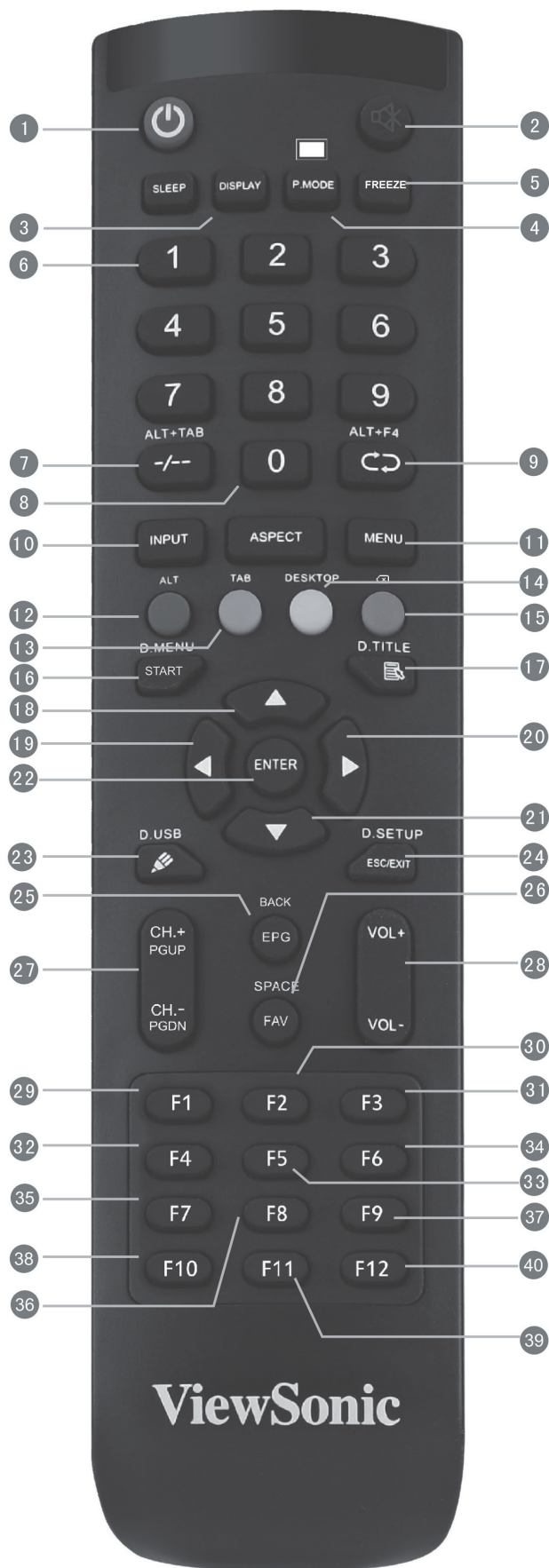

> 連接外部電腦

1. 若要顯示來自外部電腦的影像和聲音，請依照下述指示操作：
備註： 外部電腦也可以透過 HDMI 線連接至顯示器。
 - 將 VGA 線 (15 接腳) 從外部電腦連接到顯示器的 VGA IN 連接埠。
 - 將音訊線從外部電腦的 AUDIO OUT 連接埠連接到顯示器的 AUDIO IN 連接埠。
2. 將 USB 線從顯示器的 TOUCH OUT 連接埠連接到外部電腦。
備註： 為獲得最佳效果，請選擇 1920x1080p 做為電腦的輸入解析度。

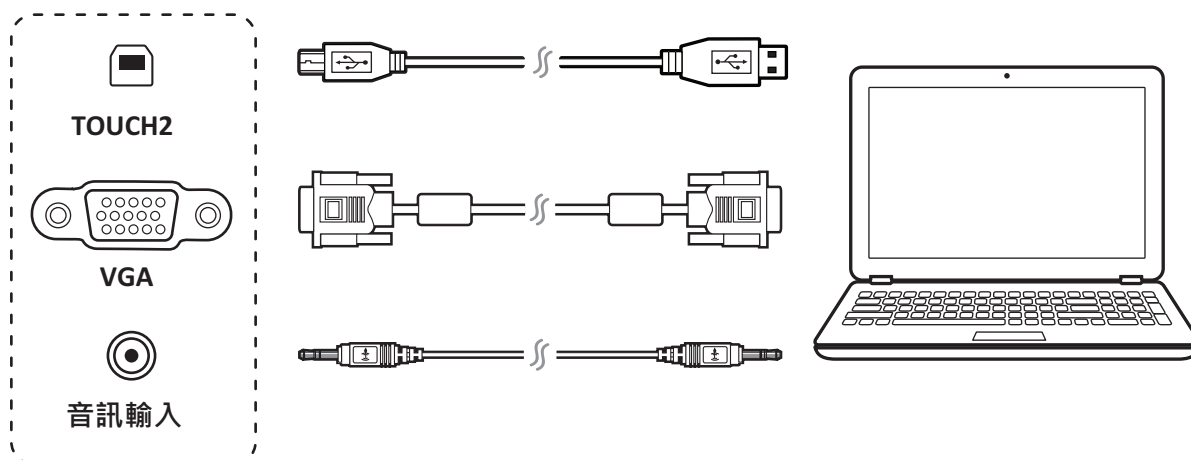

> RS232 連接

使用 RS232 序列埠連接線將顯示器連接至外部電腦時，可透過電腦控制某些功能，包括電源開啟

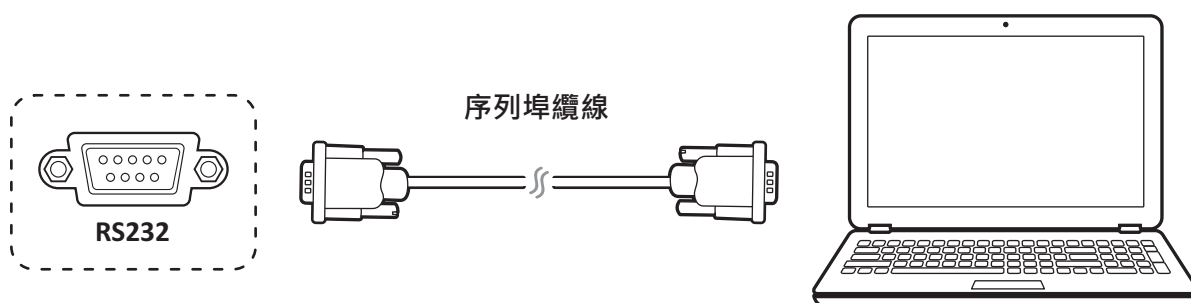

> 連接 USB 周邊裝置

1. USB 周邊裝置：將 USB 裝置連接線插入 USB IN 連接埠。
2. 網路和數據機連接線：將路由器連接線插入 LAN IN 連接埠。
3. 麥克風：將麥克風連接線插入 MIC 連接埠。

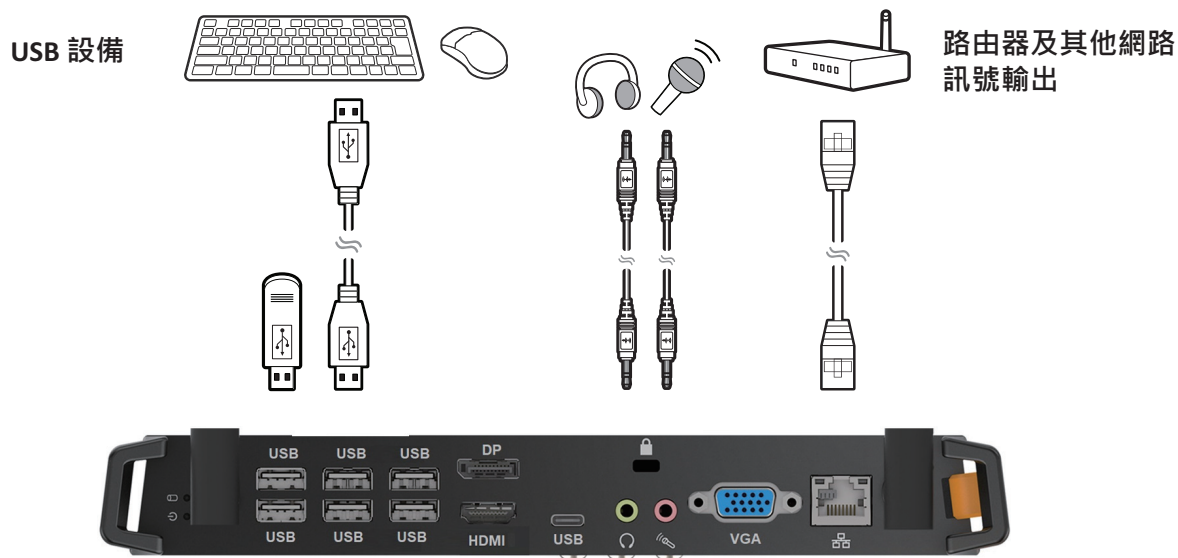

> HDMI 連接

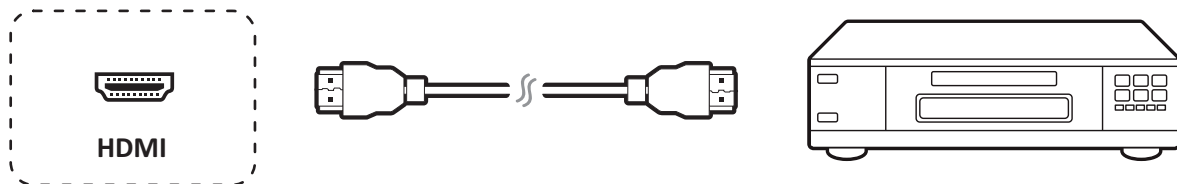

> 開始使用

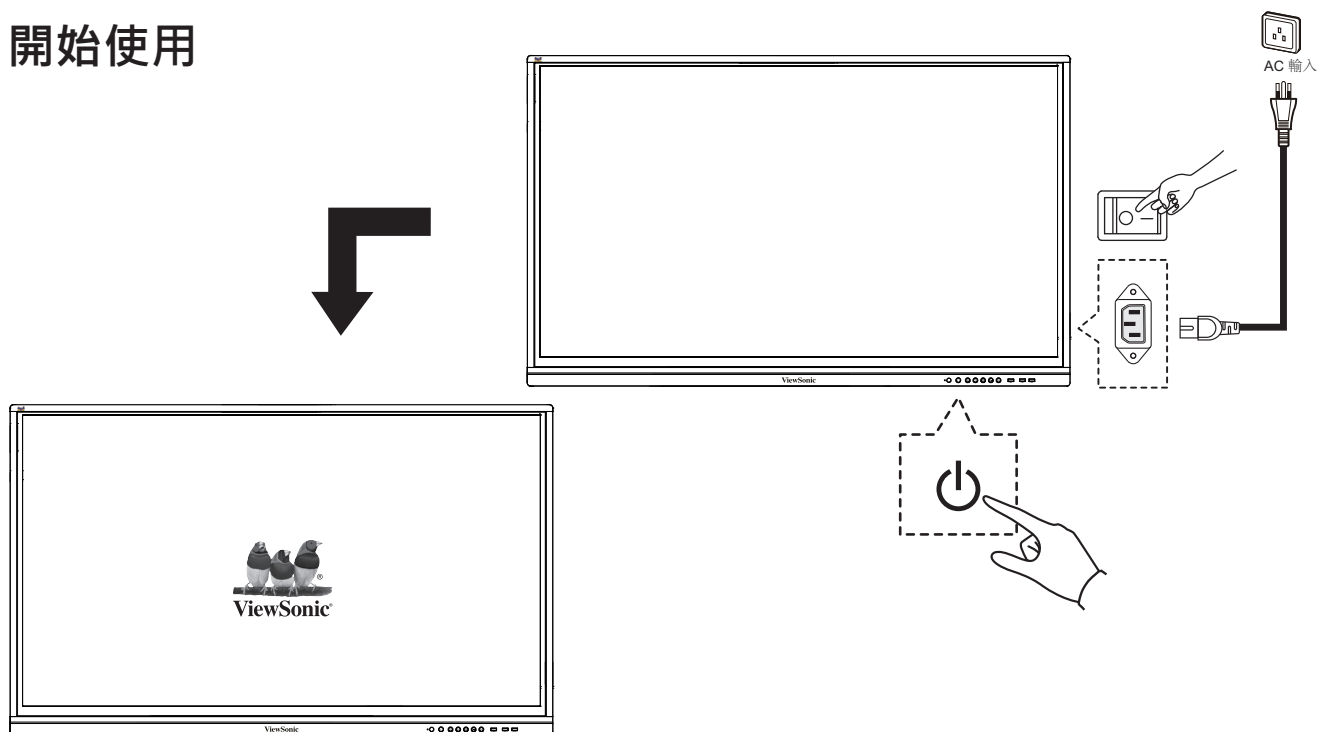



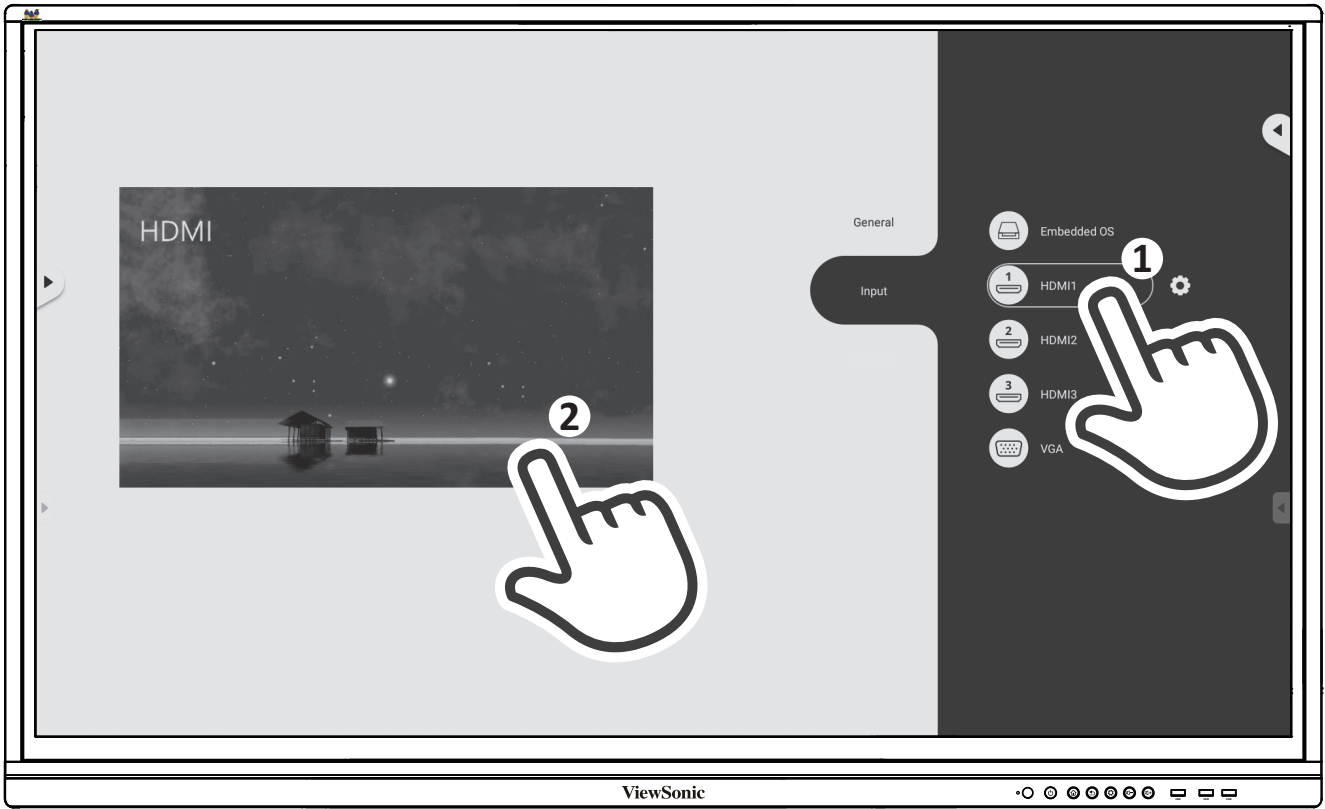
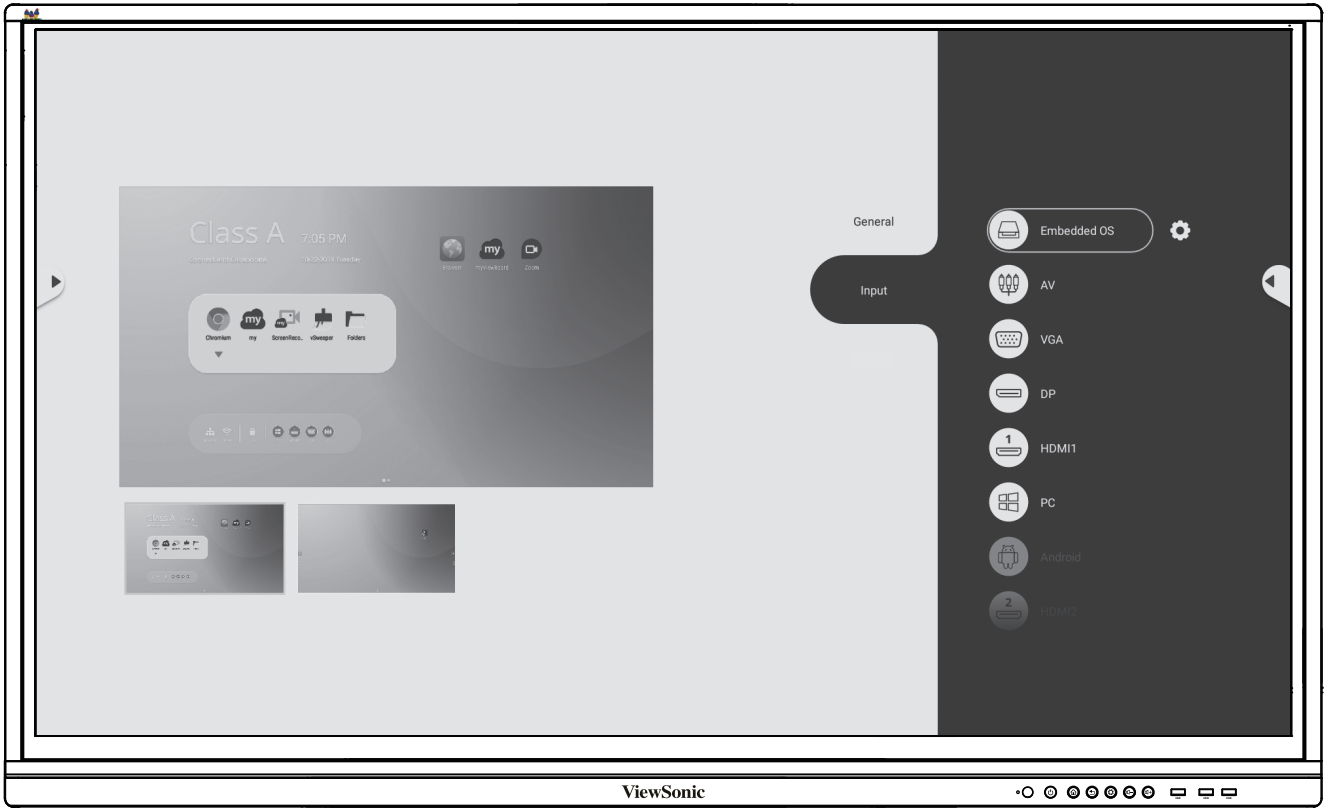

> 符合性聲明

FCC 符合性聲明：本設備符合 **FCC** 規則第 15 部分的規定。操作時有以下兩種情況：(1) 本裝置不會造成有害的干擾，以及 (2) 本裝置必須接受任何接收到的干擾，包括造成操作不良的干擾。
加拿大工業部 ICES-003 符合性： CAN ICES-3 (B)/NMB-3(B)



ViewSonic Corporation (美國 / 加拿大 / 拉丁美洲)

 : www.viewsonic.com/support/product-registration



美國

 1-800-688-6688

 customerservice@viewsonic.com

加拿大

 1-866-463-4775

 customerservice@viewsonic.com

波多黎各和維京群島

 <http://www.viewsonic.com/la/soporte/servicio-tecnico> (Español)

拉丁美洲

 <http://www.viewsonic.com/la/soporte/servicio-tecnico-la/>



ViewSonic 支援中心



選購配件

> Paket İçeriği

- Güç kablosu (bölgeye göre gönderilir)
- Uzaktan kumanda
- AAA pil x 2
- USB kablosu
- Dokunmatik Kalem
- Hızlı başlangıç kılavuzu
- RS232 adaptörü
- Kelepçe x 5
- Kamera Levhası
- Vida
- HDMI ile uyumlu sinyal kablosu

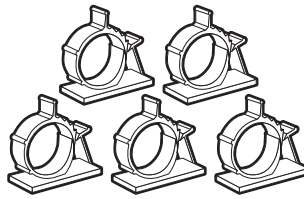
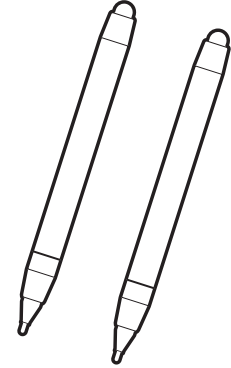
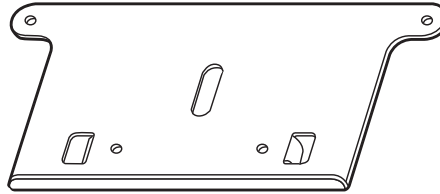
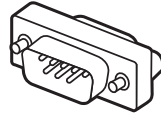
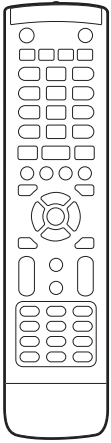
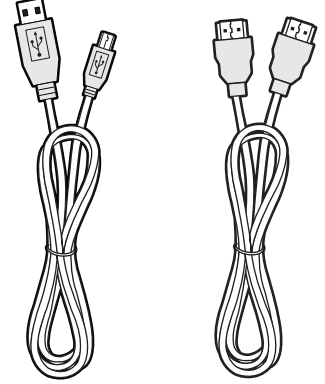
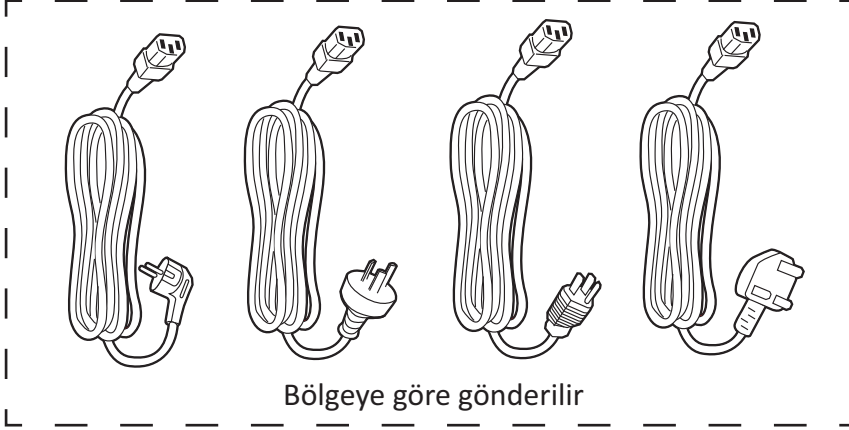

➤ Duvara Montaj Kitinin Özellikleri (VESA)

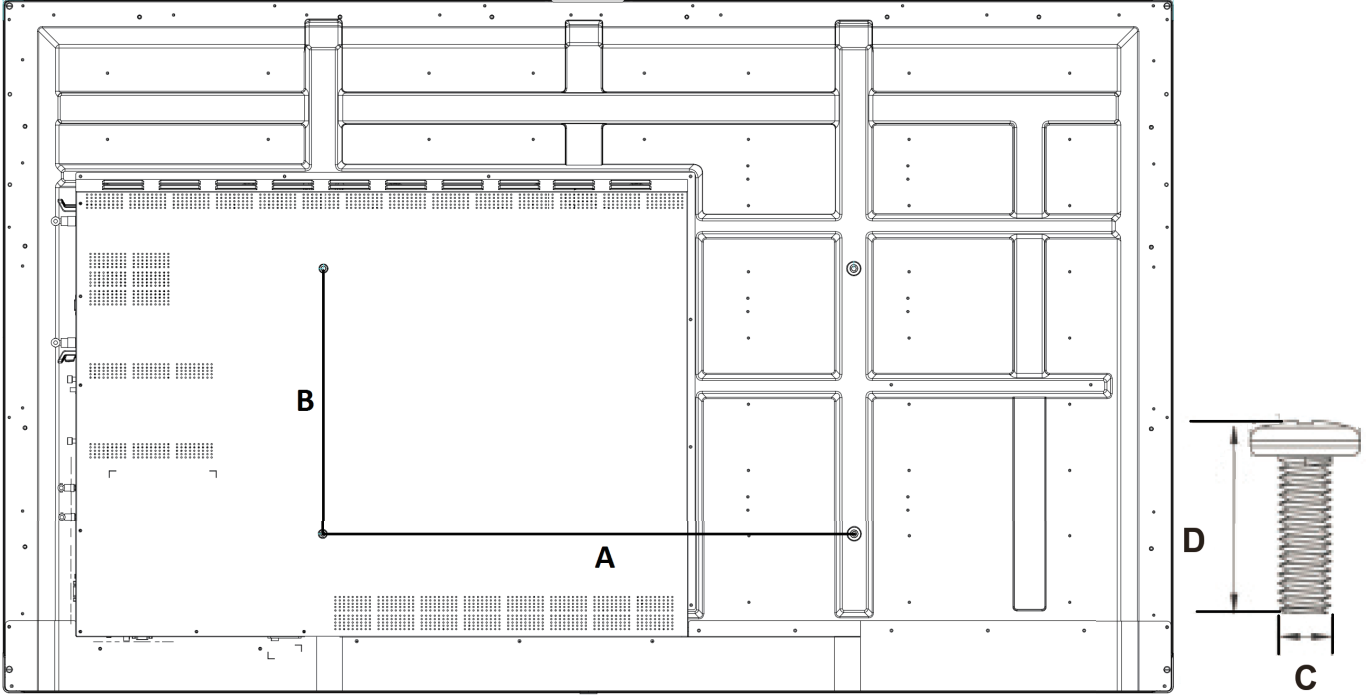

inç	VESA Özellik. (A x B)	Standart Vida (C x D)	Miktar
IFP5550 - 55"	400 x 200 mm	M8 x 25 mm	4
IFP6550 - 65"	600 x 400 mm	M8 x 25 mm	4
IFP7550 - 75"	800 x 400 mm	M8 x 25 mm	4
IFP8650 - 86"	800 x 600 mm	M8 x 25 mm	4

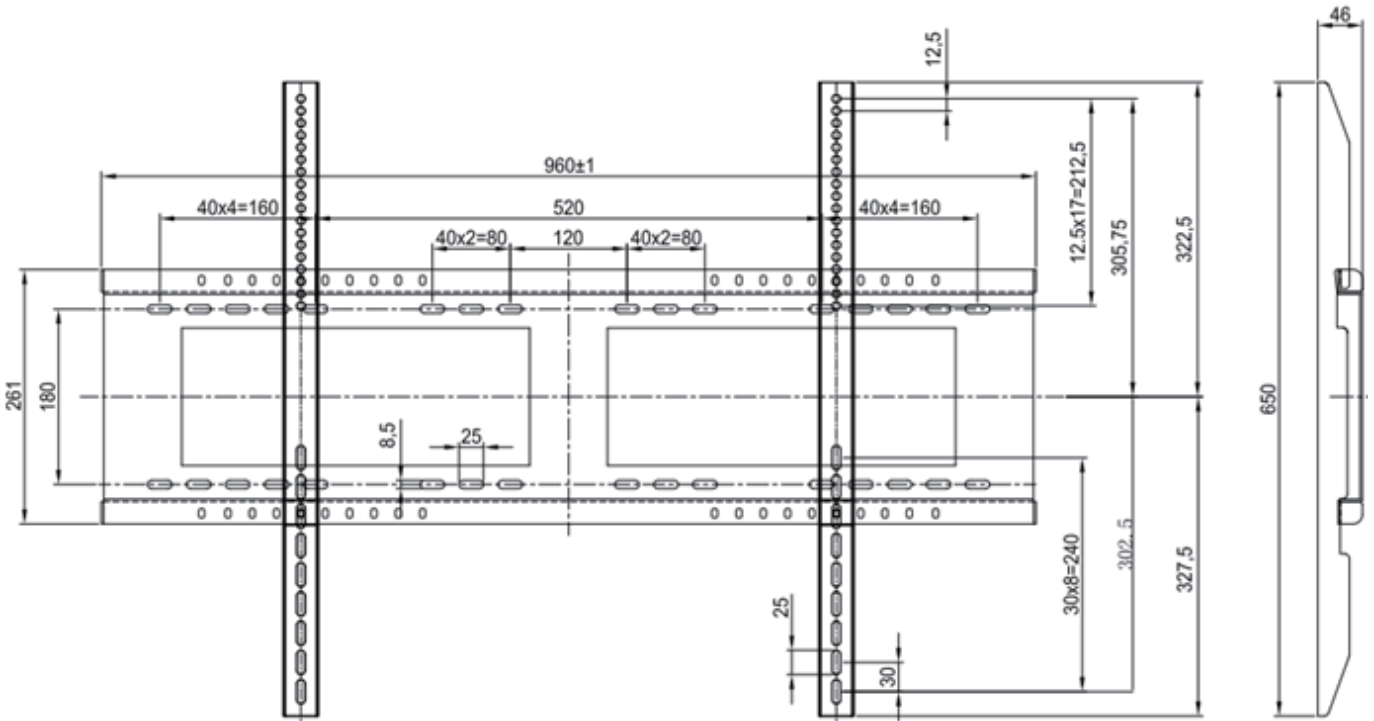

> Kurulum Ortamı Uyarısı

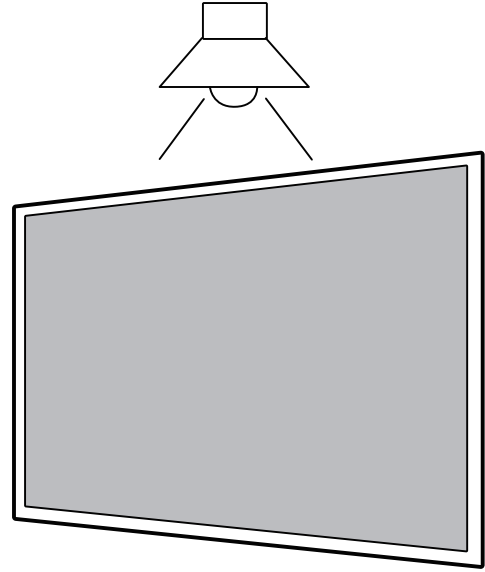
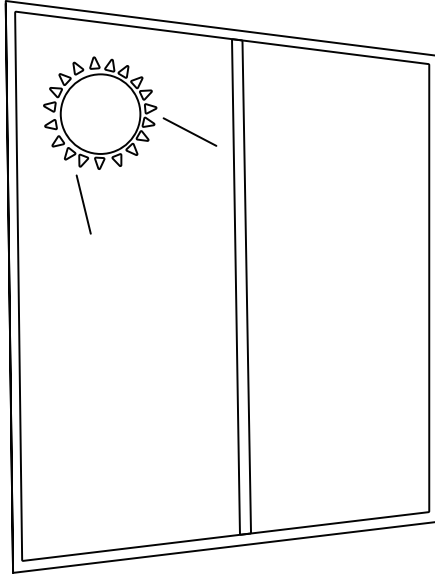
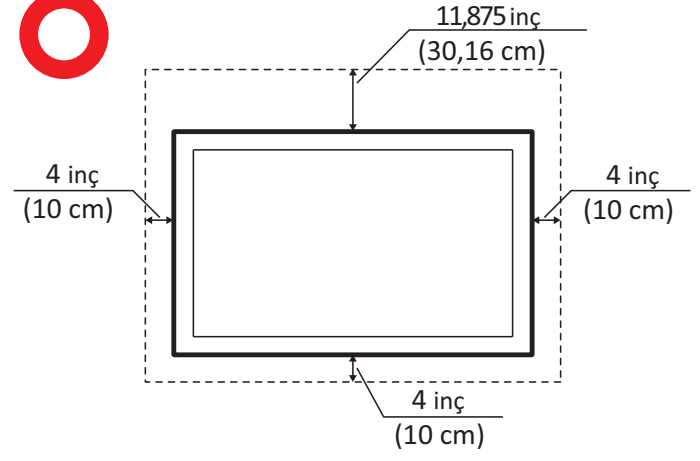
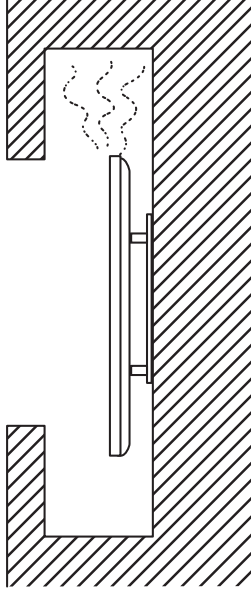

> Kontrol Paneline Genel Bakış

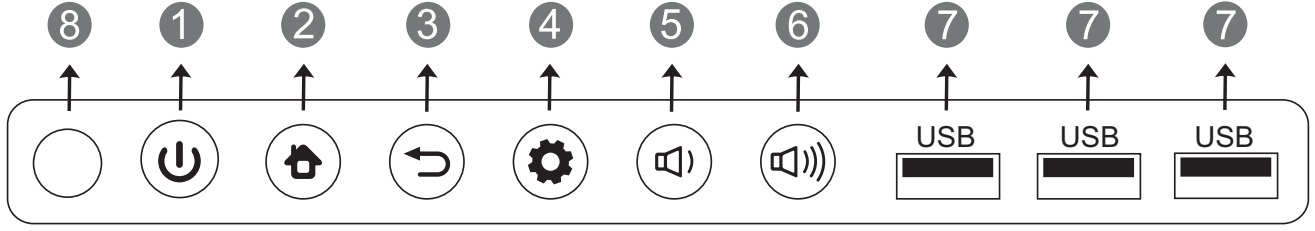

Öge	Açıklama
1	Cihazı açmak için tuşa basın Yalnız ekran arka ışığını açmak/kapatmak için tuşa basın Cihazı kapatmak için tuşu basılı tutun
2	Katıştırılmış oynatıcı ana arayüzüne geri gidin
3	Katıştırılmış oynatıcı önceki düzeyine geri gidin
4	İşlev menüsünü görüntüleyin
5	Ses düzeyini azaltın
6	Ses düzeyini artırın
7	Katıştırılmış Oynatıcı ve dahili PC için USB bağlantı noktası
8	Uzaktan kumandadan sinyalleri alır

> G/Ç bağlantı noktası

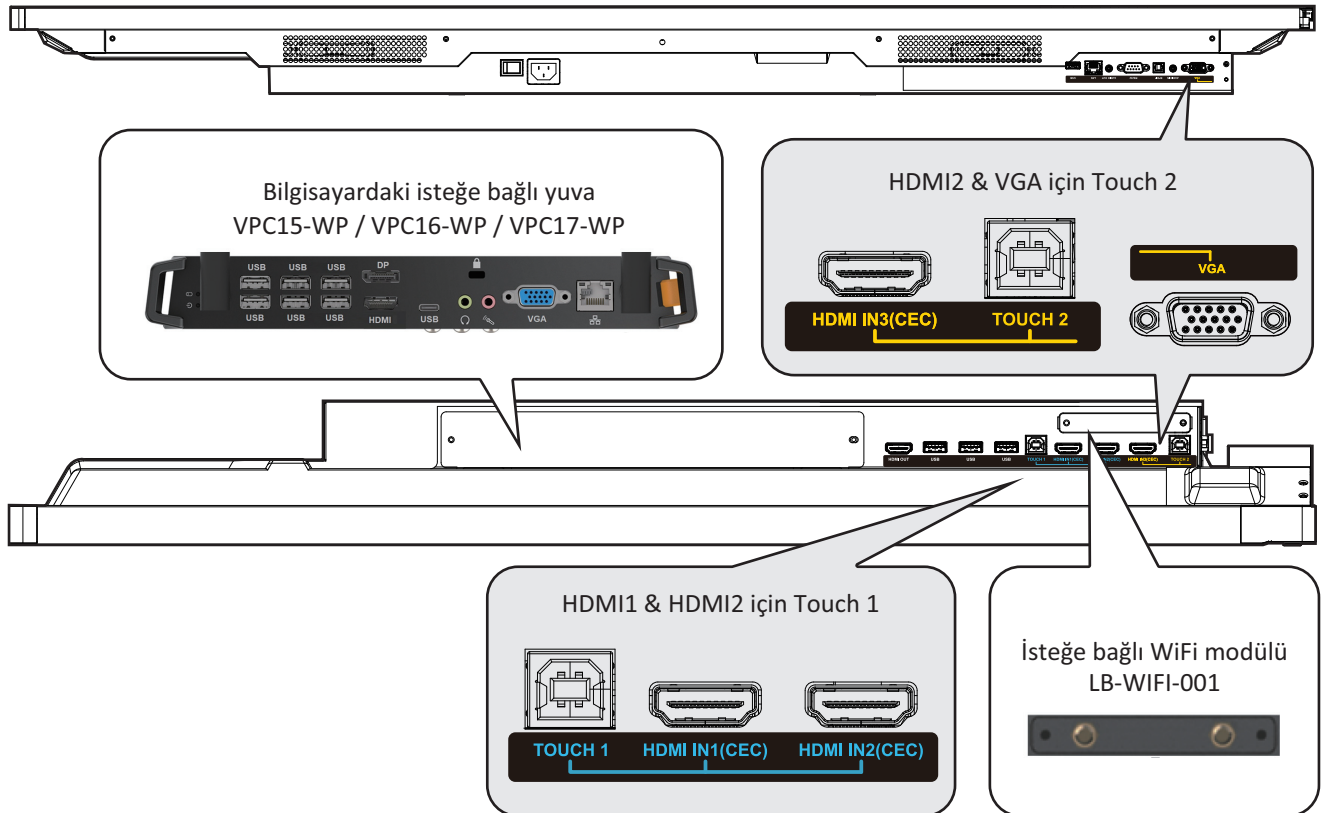

➤ Uzaktan Kumandaya Genel Bakış

1 

Ekranı AÇMAK/KAPATMAK için basın

2 

Sessiz / Ses Açık

3 DISPLAY

Geçerli geçerli giriş kaynağı bilgilerini görüntüle

4 P.MODE

Karanlık ekran

5 FREEZE

Ekranı dondur

6 Numeric button

Sayısal giriş düğmesi

7 - / -- / ALT+TAB

PC uygulamaları arasında geçiş için basın

8 0

Sayısal giriş düğmesi

9  / ALT+F4

Geçerli PC penceresini kapat

10 INPUT

Kaynak seçimi düğmesi

11 MENU

Menüyü görüntülemek için basın

12 RED+ALT

Ekran yakalama

13 GREEN+TAB

PC 'Tab' düğmesi

14 YELLOW+DESKTOP

PC masaüstündeki girişe geç

15 BLUE+BACKSPACE

PC 'Geri' düğmesi

16 START / D. MENU

PC 'Windows' düğmesi

17  / D.TITLE

PC 'Menü' düğmesi

18 

Yukarı kaydırmak için basın

19 

Sola kaydırmak için basın

20 

Sağa kaydırmak için basın

21 

Aşağı kaydırmak için basın

22 ENTER

Giriş düğmesi. Seçenekleri belirlemek için basın.

23  / D. USB

Yazılım başlatma yazılıyor

24 ESC / EXIT / D. SETUP

İletişim kutularından çıkmak için kısayol düğmesi

25 EPG

Geri

26 FAV / SPACE

PC 'Boşluk' düğmesi

27 CH. + / CH. -

CH+ : PC önceki sayfa
CH- : PC sonraki sayfa

28 VOL+ / VOL-

Sesi Artır / Azalt

29 F1

Windows F1 işlevi

30 F2

Windows F2 işlevi

31 F3

Windows F3 işlevi

32 F4

Windows F4 işlevi

33 F5

Windows F5 işlevi

34 F6

Windows F6 işlevi

35 F7

Windows F7 işlevi

36 F8

Windows F8 işlevi

37 F9

Windows F9 işlevi

38 F10

Windows F10 işlevi

39 F11

Windows F11 işlevi

40 F12

Windows F12 işlevi

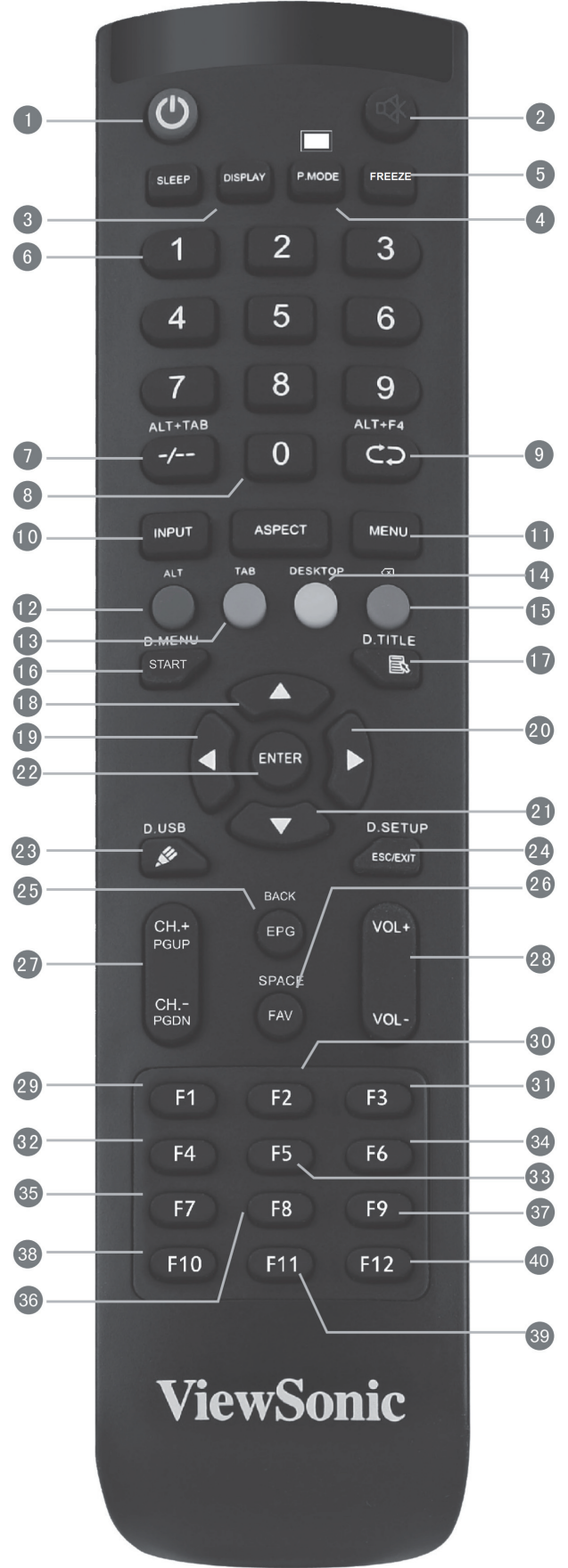

> Harici PC Bağlama

1. Harici PC'den video ve sesi görüntülemek için aşağıdaki talimatları izleyin:

Not: Harici PC'ler ekrana HDMI kablosu yoluyla da bağlanabilir.

- Bir VGA kablosunu (15 pin) harici PC'nizden ekrandaki VGA GİRİŞİ bağlantı noktasına bağlayın.
- Bir ses kablosunu harici PC'nizdeki SES ÇIKIŞI bağlantı noktasından ekrandaki SES GİRİŞİ bağlantı noktasına bağlayın.

2. Bir USB kablosunu harici PC'ye ekranın DOKUNMA ÇIKIŞI bağlantı noktasından bağlayın.
Not: Optimum sonuçlar için harici bilgisayarın giriş çözünürlüğü olarak 1920x1080p seçin.

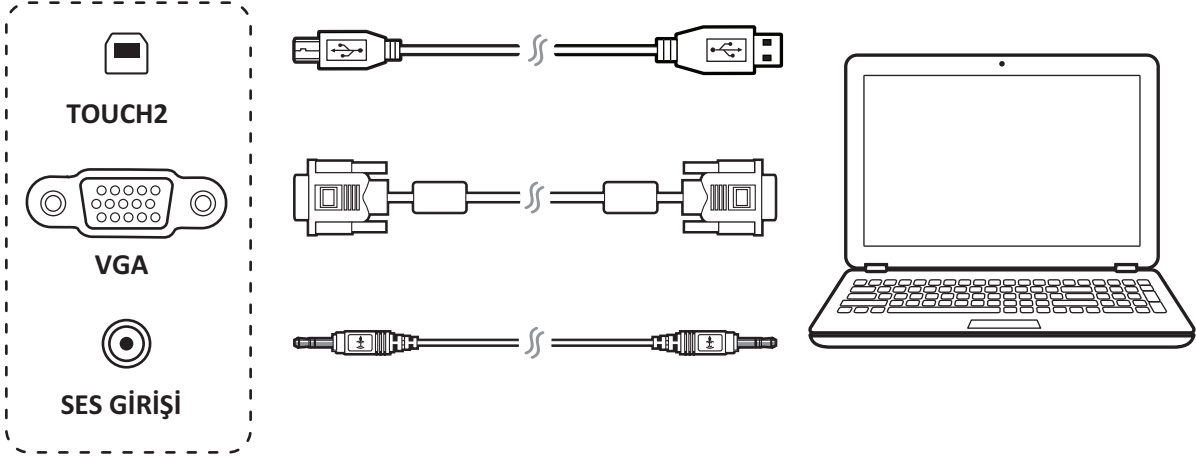

> RS232 Bağlantıları

Ekranınızı harici bir bilgisayara bağlamak için bir RS232 seri bağlantı noktası kablosu kullanırken, güç açma/kapatma, ses ayarı vb. dahil bazı işlevler PC ile kontrol edilebilir.

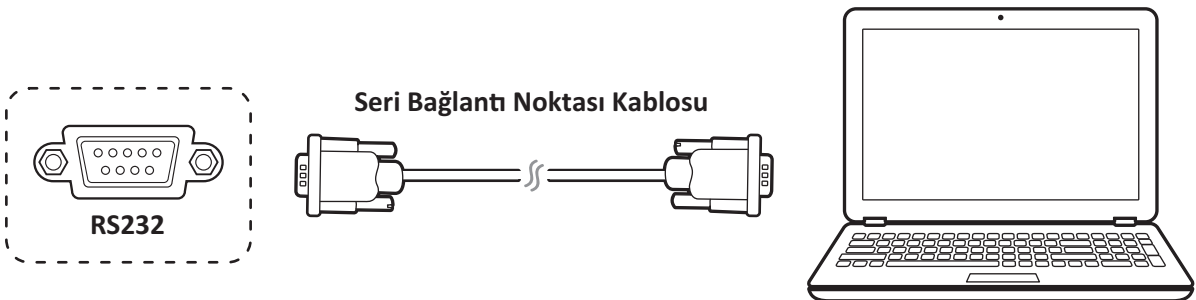

> USB Çevre Birimlerini Bağlama

1. USB Çevre Birimleri: USB cihazı kablosunu USB GİRİŞ bağlantı noktasına takın.
2. Ağ ve modem kabloları: Yönlendirici kablosunu LAN GİRİŞİ bağlantı noktasına takın.
3. Mikrofon: Mikrofon kablosunu MIC bağlantı noktasına takın.

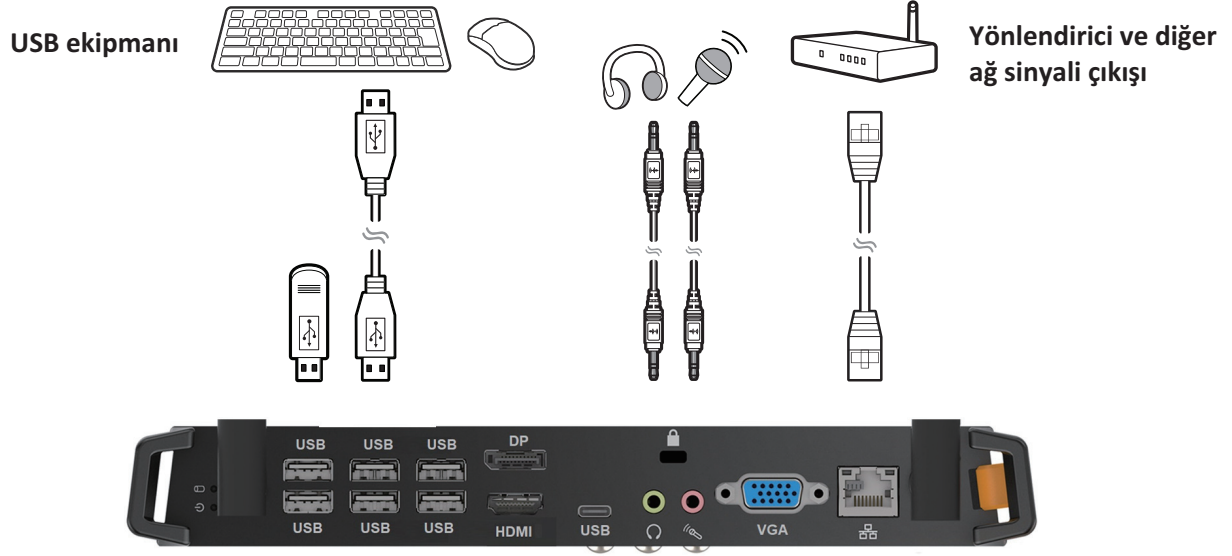

> HDMI Bağlantıları

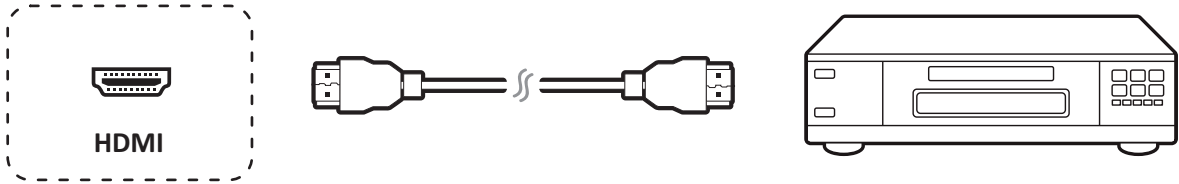

> Kullanıma Başla

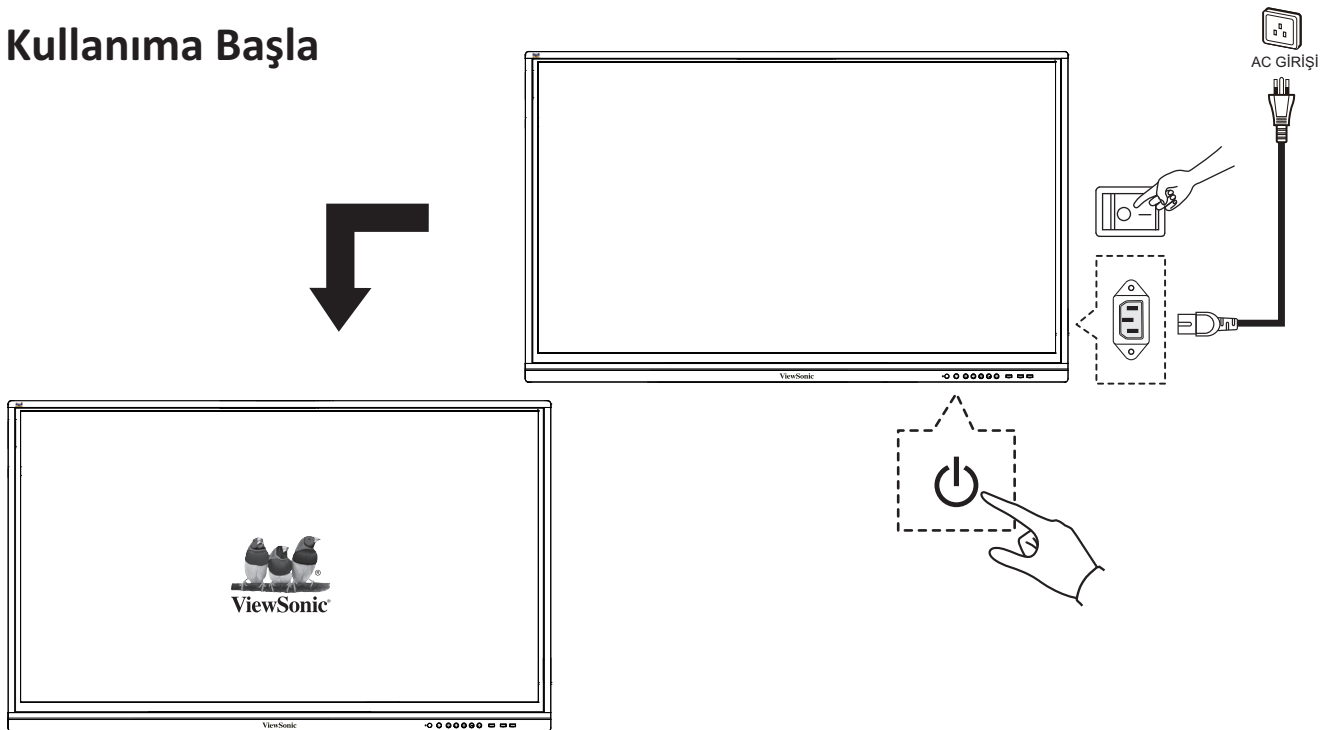



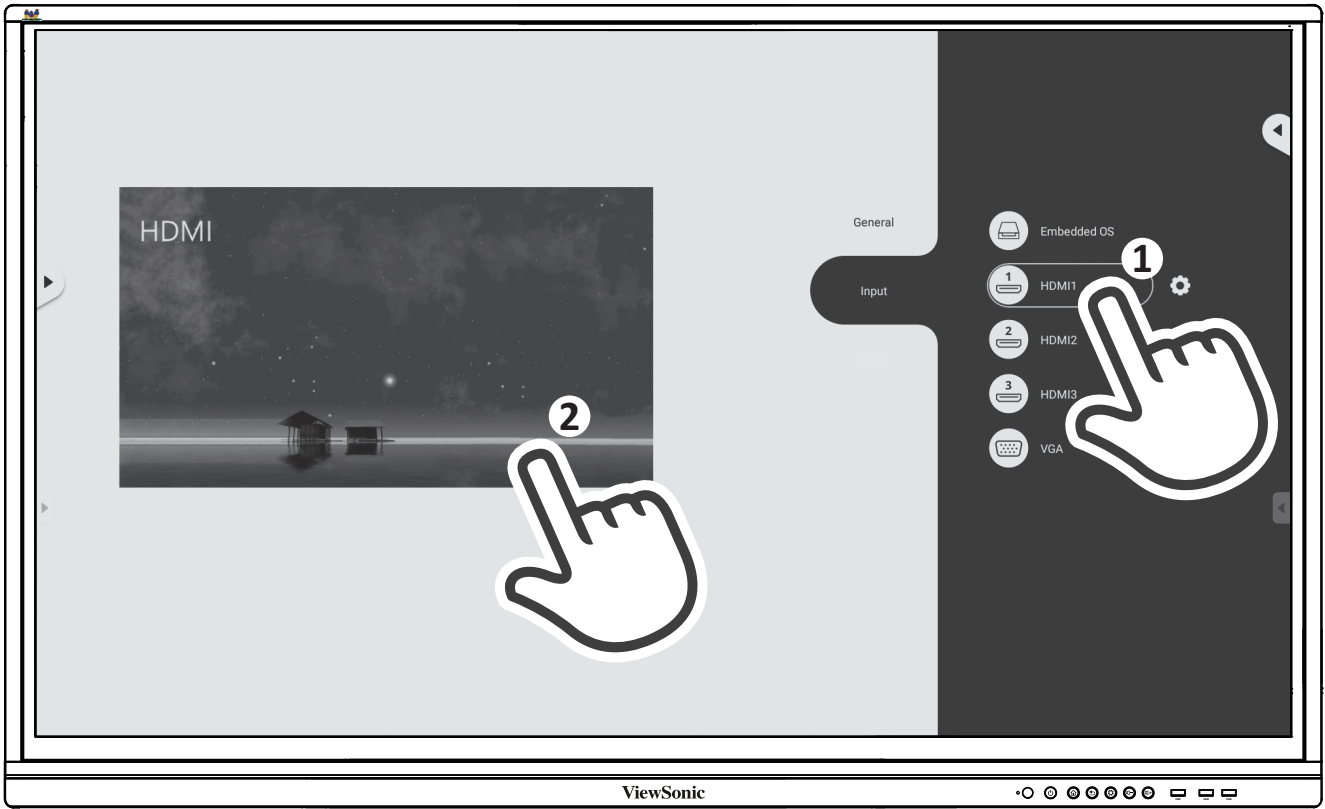
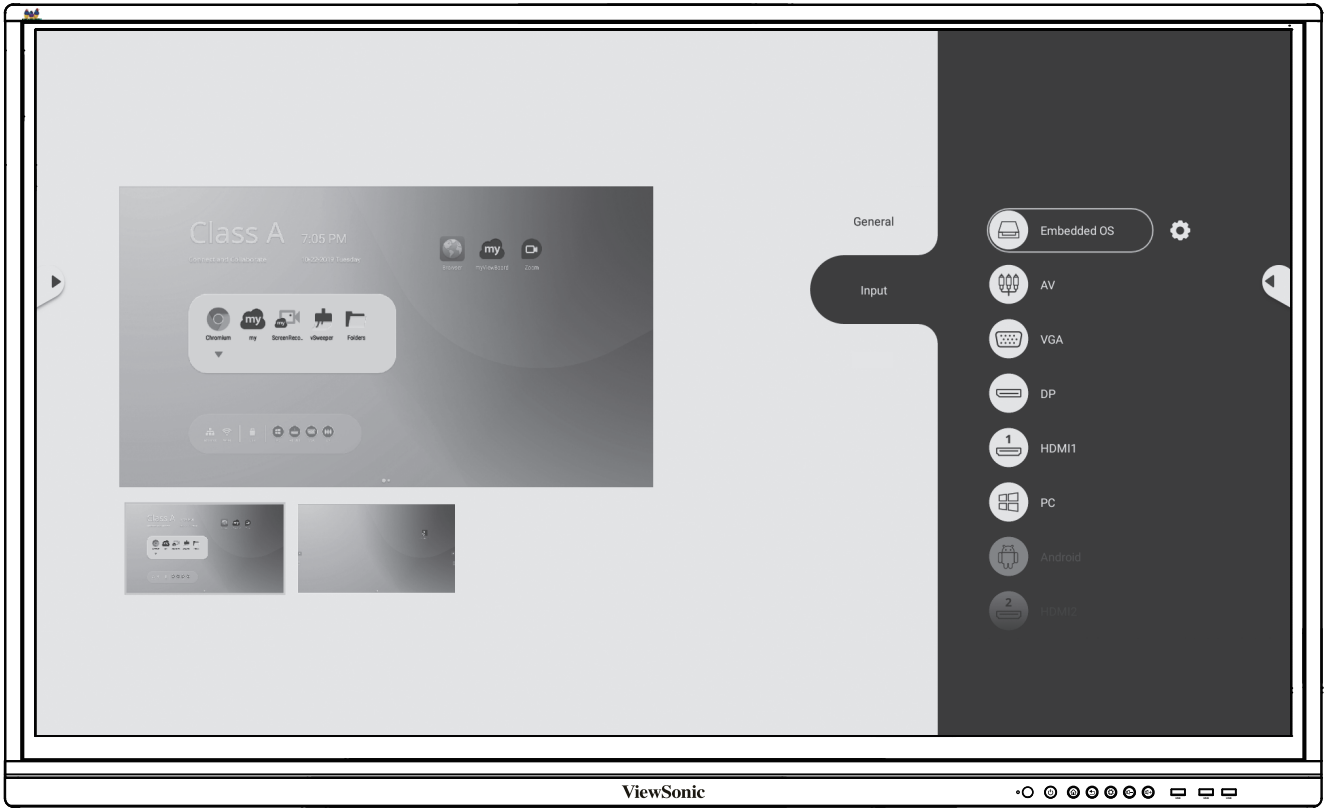

> Uyumluluk Bilgileri

FCC Uyumluluk Bildirimi: Bu aygıt, FCC Kuralları kısım 15'e uygundur. Kullanım aşağıdaki iki koşula bağlıdır: (1) Bu aygıt zararlı girişime neden olamaz ve (2) bu aygıt istenmeyen çalışmaya neden olabilen girişim dahil olmak üzere alınan her türlü girişimi kabul etmelidir.

Industry Canada ICES-003 Uyumu: CAN ICES-3 (B)/NMB-3(B)



ViewSonic Corporation (US/Kanada/Latin Amerika)



: www.viewsonic.com/support/product-registration



Amerika Birleşik Devletleri



1-800-688-6688



customerservice@viewsonic.com

Kanada



1-866-463-4775



customerservice@viewsonic.com

Porto Riko & Virgin Islands



<http://www.viewsonic.com/la/soporte/servicio-tecnico> (Español)

Latin Amerika



<http://www.viewsonic.com/la/soporte/servicio-tecnico-la/>



ViewSonic Destek Merkezi



İsteğe Bağlı Aksesuar

← محتويات العبوة

- مهايئ RS232
- عدد ٥ مشابك
- لوحة الكاميرا
- برغي
- كبل إشارة متوافق مع HDMI

- كبل طاقة (الشحن حسب المنطقة)
- وحدة تحكم عن بُعد
- عدد ٢ بطارية AAA
- كبل USB
- قلم اللمس
- دليل التشغيل السريع

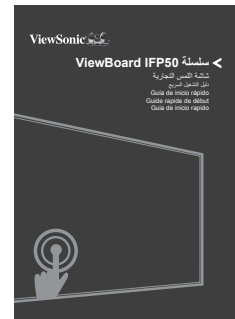
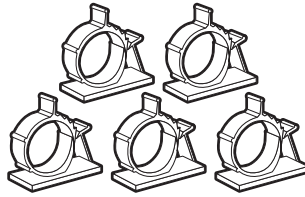
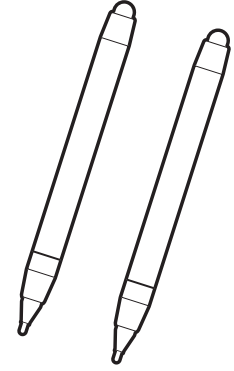
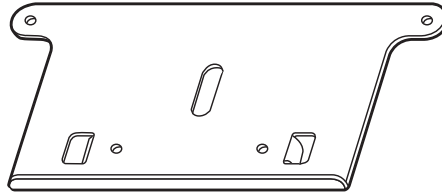
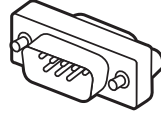
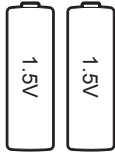
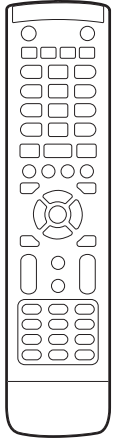
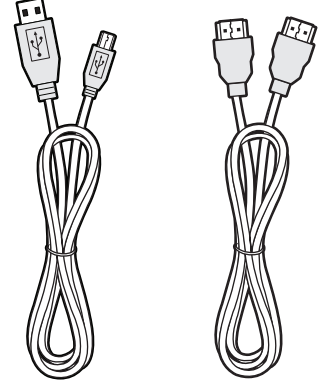
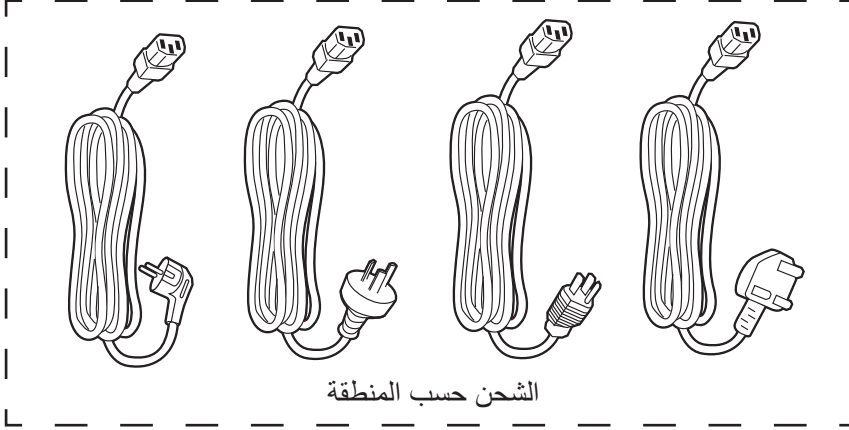

◀ مواصفات طاقم التثبيت بالحائط (VESA)

عربي

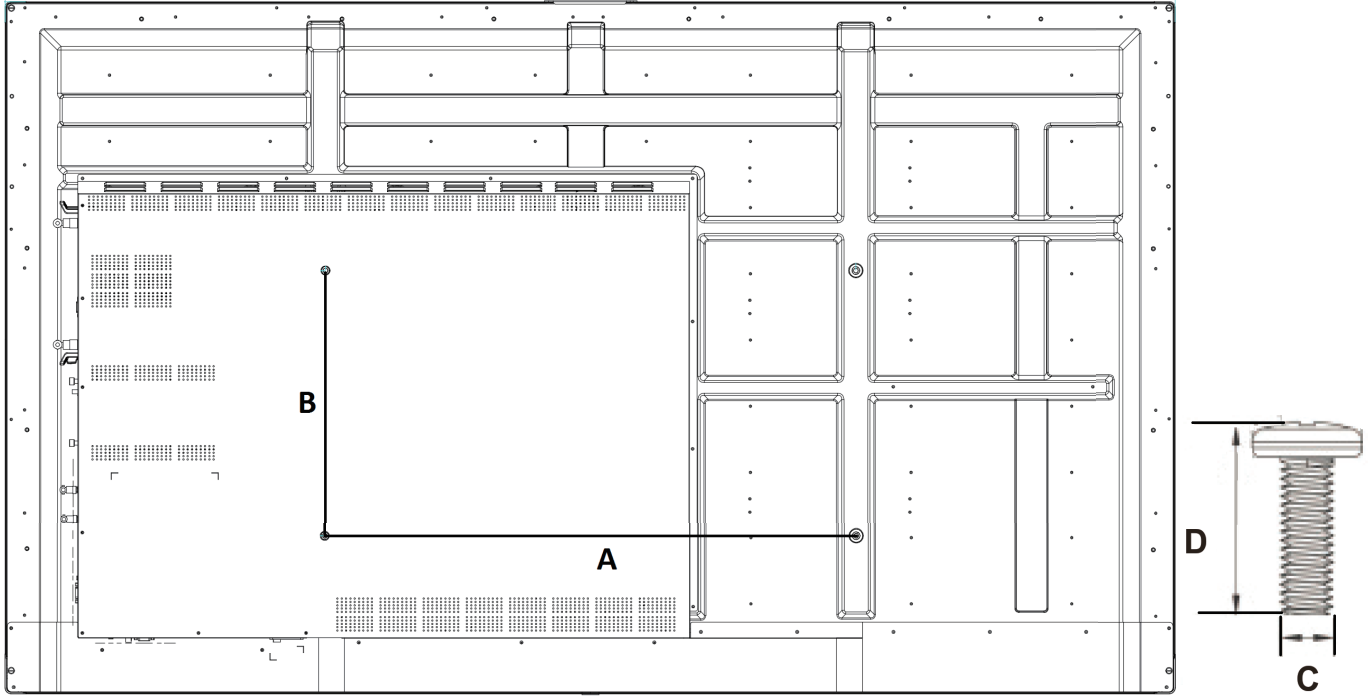

الكمية	برغي قياسي (C x D)	مواصفات VESA (A x B)	بوصة
٤	M8 x ٢٥ مم	٢٠٠ x ٤٠٠ مم	بوصة IFP5550 - 55
٤	M8 x ٢٥ مم	٤٠٠ x ٦٠٠ مم	بوصة IFP6550 - 65
٤	M8 x ٢٥ مم	٤٠٠ x ٨٠٠ مم	بوصة IFP7550 - 75
٤	M8 x ٢٥ مم	٦٠٠ x ٨٠٠ مم	بوصة IFP8650 - 86

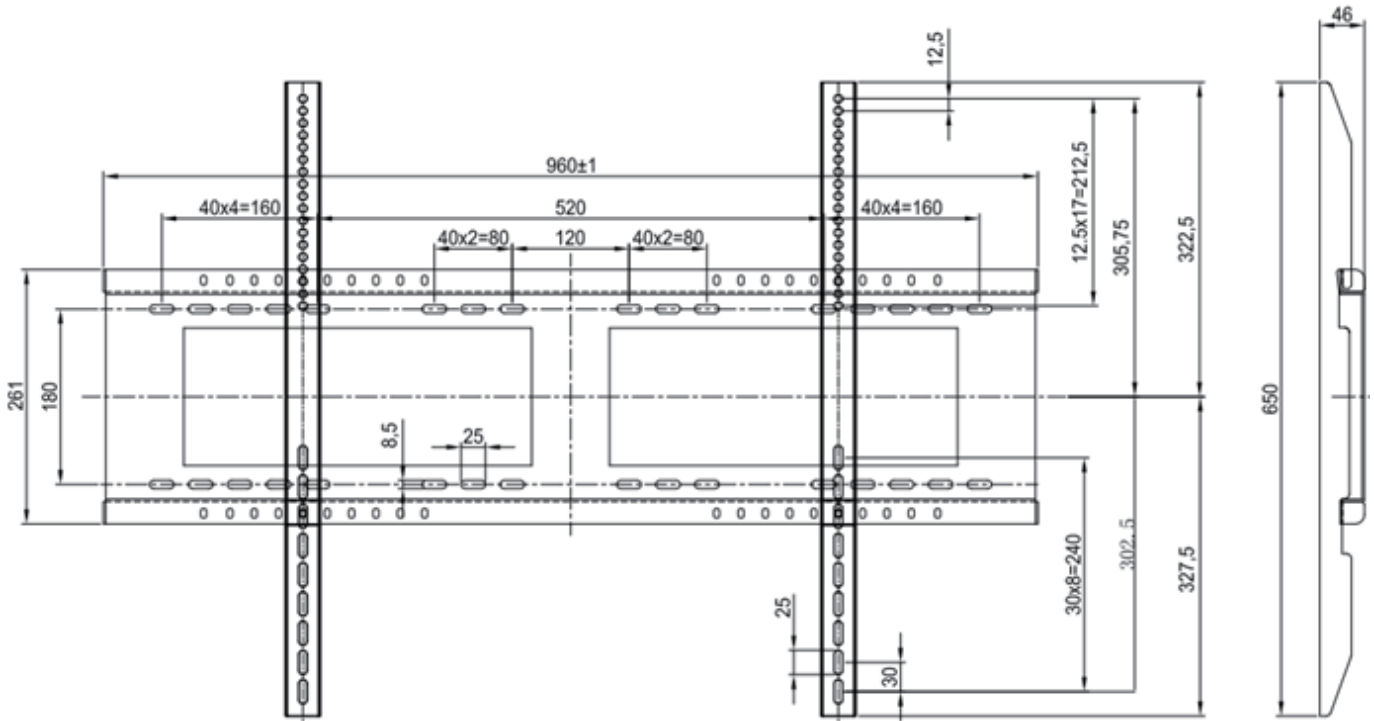

التبیهات الخاصة ببيئة التركيب <

عربي

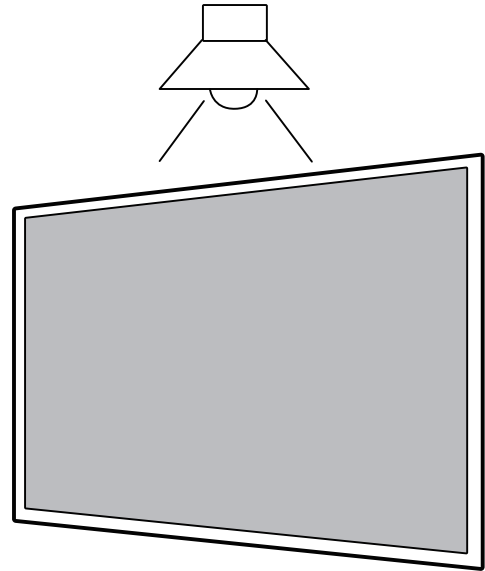
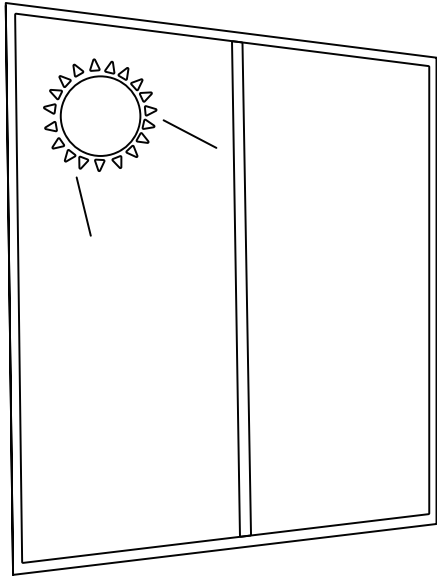
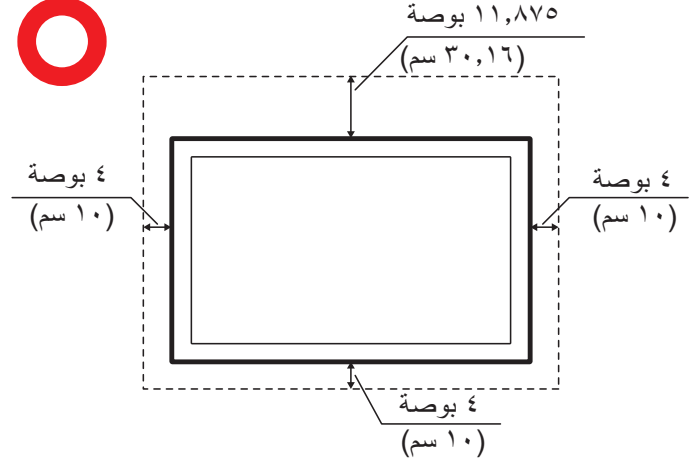
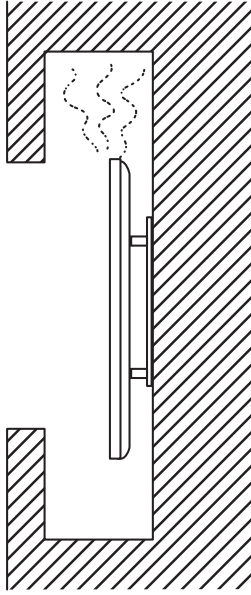

← نظرة عامة على لوحة التحكم

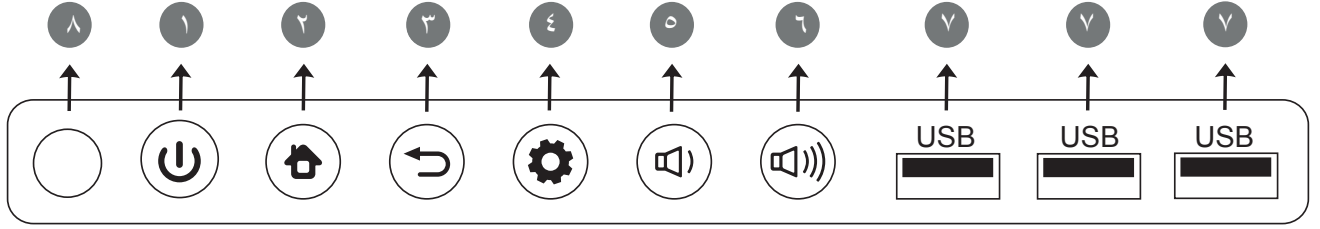

العنصر	الوصف
١	اضغط على هذا المفتاح لتشغيل الجهاز اضغط على هذا المفتاح لإيقاف تشغيل / تشغيل الإضاءة الخلفية للشاشة فقط اضغط مع الاستمرار على هذا المفتاح لإيقاف تشغيل الجهاز
٢	العودة إلى واجهة المشغل الرئيسية المضمنة
٣	الرجوع إلى المستوى السابق للمشغل المضمن
٤	الانتقال إلى وظيفة القائمة
٥	خفض مستوى الصوت
٦	زيادة مستوى الصوت
٧	منفذ USB للمشغل المضمن وجهاز الكمبيوتر الداخلي
٨	يستقبل الإشارات من وحدة التحكم عن بعد

← منفذ الدخل/الخروج

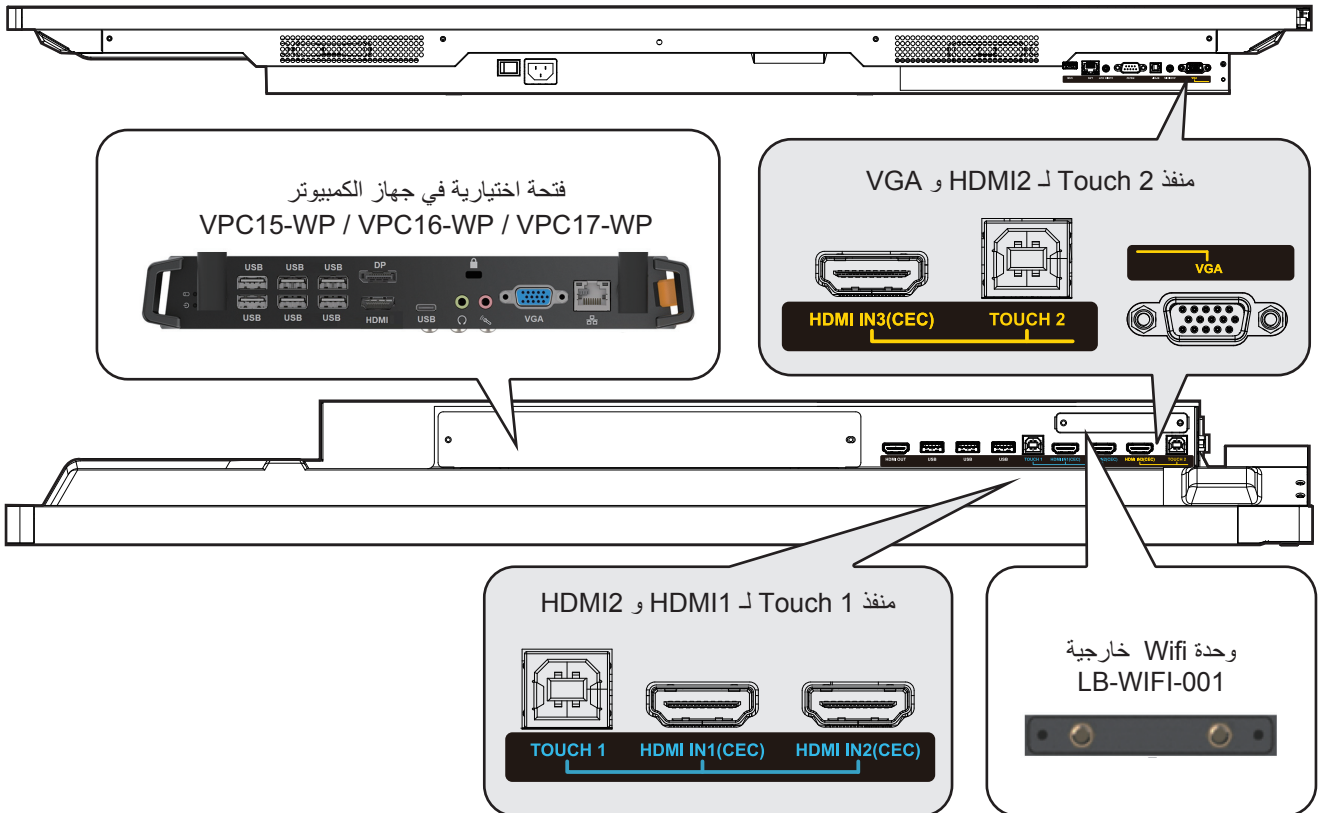

← نظرة عامة على وحدة التحكم عن بُعد

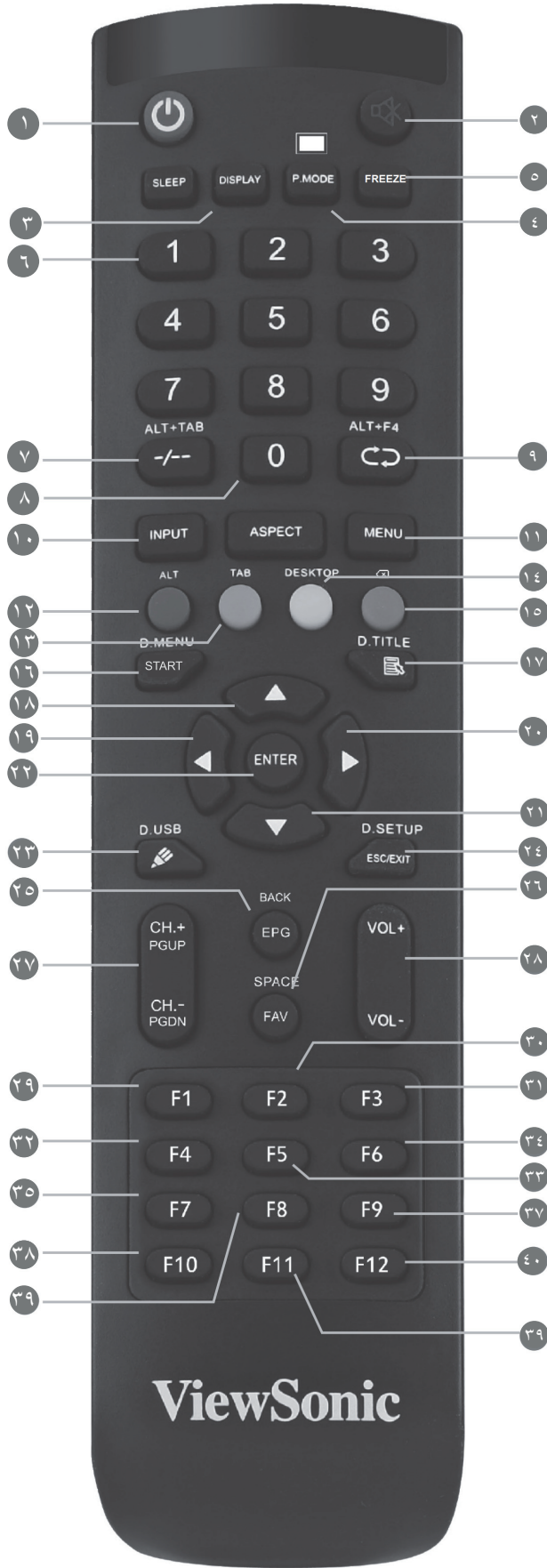

- 1 **POWER** 1
اضغط على هذا الزر لتشغيل الشاشة أو إيقاف تشغيلها
ON (تشغيل) / OFF (إيقاف)
- 2 **MUTE** 2
كتم الصوت / إلغاء كتم الصوت
- 3 **DISPLAY** 3
يعرض معلومات عن مصدر الدخل الحالي
- 4 **P.MODE** 4
يعرض شاشة فارغة
- 5 **FREEZE** 5
يقوم بتجميد الشاشة
- 6 **Numeric button** 6
زر الإدخال الرقمي
- 7 **- / -- / ALT+TAB** 7
اضغط على هذا الزر للتبديل بين تطبيقات جهاز الكمبيوتر
- 8 **0** 8
زر الإدخال الرقمي
- 9 **↻ / ALT+F4** 9
يقوم بإغلاق نافذة الكمبيوتر الحالية
- 10 **INPUT** 10
زر اختيار المصدر
- 11 **MENU** 11
اضغط على هذا الزر لعرض القائمة
- 12 **RED+ALT** 12
يقوم بالتقاط الشاشة
- 13 **GREEN+TAB** 13
زر 'علامة تبويب' جهاز الكمبيوتر
- 14 **YELLOW+DESKTOP** 14
التبديل إلى فتحة سطح مكتب الكمبيوتر
- 15 **BLUE+BACKSPACE** 15
زر 'مسافة للخلف' الخاص بجهاز الكمبيوتر
- 16 **START / D. MENU** 16
زر 'نظام التشغيل Windows' الخاص بجهاز الكمبيوتر
- 17 **📄 / D.TITLE** 17
زر 'قائمة' جهاز الكمبيوتر
- 18 **▲** 18
اضغط على هذا الزر للتمرير لأعلى
- 19 **◀** 19
اضغط على هذا الزر للتمرير لليسار
- 20 **▶** 20
اضغط على هذا الزر للتمرير لليمين
- 21 **▼** 21
اضغط على هذا الزر للتمرير لأسفل
- 22 **ENTER** 22
زر الإدخال، قم بالضغط عليه لتحديد الخيارات.
- 23 **🖱️ / D. USB** 23
بدء تشغيل برنامج الكتابة
- 24 **ESC / EXIT / D. SETUP** 24
زر اختصار للخروج من مربعات الحوار
- 25 **EPG** 25
رجوع
- 26 **FAV / SPACE** 26
زر 'مسافة' الخاص بجهاز الكمبيوتر
- 27 **CH. + / CH. -** 27
+CH : للرجوع إلى الصفحة السابقة على جهاز الكمبيوتر
-CH : للانتقال إلى الصفحة التالية على جهاز الكمبيوتر
- 28 **VOL+ / VOL-** 28
زيادة / خفض مستوى الصوت
- 29 **F1** 29
وظيفة F1 بنظام Windows
- 30 **F2** 30
وظيفة F2 بنظام Windows
- 31 **F3** 31
وظيفة F3 بنظام Windows
- 32 **F4** 32
وظيفة F4 بنظام Windows
- 33 **F5** 33
وظيفة F5 بنظام Windows
- 34 **F6** 34
وظيفة F6 بنظام Windows
- 35 **F7** 35
وظيفة F7 بنظام Windows
- 36 **F8** 36
وظيفة F8 بنظام Windows
- 37 **F9** 37
وظيفة F9 بنظام Windows
- 38 **F10** 38
وظيفة F10 بنظام Windows
- 39 **F11** 39
وظيفة F11 بنظام Windows
- 40 **F12** 40
وظيفة F12 بنظام Windows

توصيل جهاز كمبيوتر خارجي <

- ١- لعرض مقاطع الفيديو والمقاطع الصوتية من أي جهاز كمبيوتر خارجي، قم باتباع التعليمات الواردة أدناه:
 - ملاحظة: يمكن أيضًا توصيل أجهزة الكمبيوتر الخارجية بالشاشة عبر كبل HDMI.
 - قم بتوصيل كبل VGA (المكون من ١٥ سن) من جهاز الكمبيوتر الخارجي الخاص بك بمنفذ الدخل VGA IN الموجود على الشاشة.
 - قم بتوصيل كبل الصوت من منفذ الخرج AUDIO OUT الموجود بالكمبيوتر الخارجي بمنفذ الدخل AUDIO IN الموجود بالشاشة.
- ٢- قم بتوصيل كبل USB بالكمبيوتر الخارجي من منفذ الخرج TOUCH OUT الموجود بالشاشة.
 - ملاحظة: للحصول على أفضل النتائج، حدد ١٩٢٠ x ١٠٨٠ بكسل كدقة دخل للكمبيوتر الخارجي.

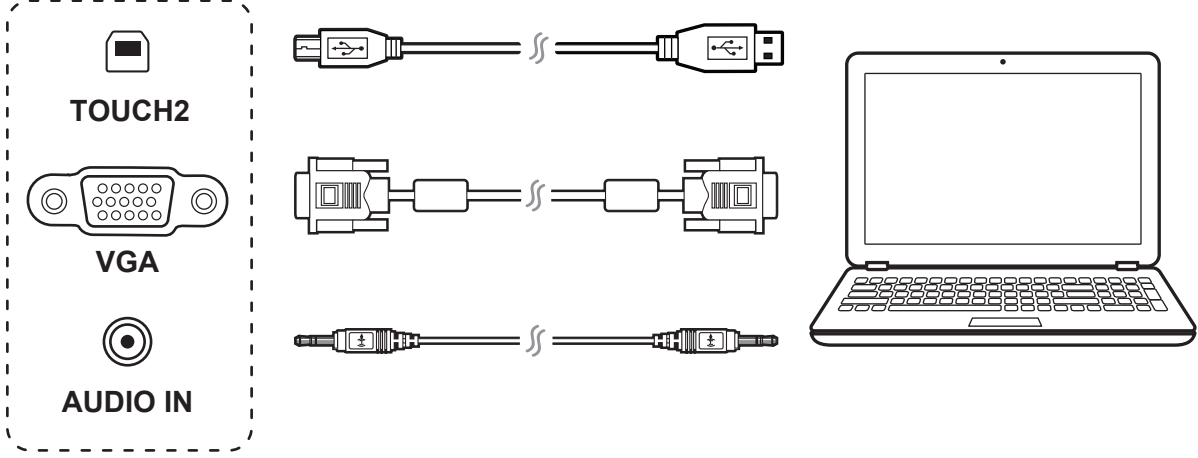

توصيلات RS232 <

عند استخدام كبل المنفذ التسلسلي RS232 لتوصيل شاشتك بجهاز كمبيوتر خارجي، فإنه يمكن التحكم في بعض الوظائف عن طريق جهاز الكمبيوتر، بما في ذلك التشغيل / إيقاف التشغيل وضبط مستوى الصوت وغير ذلك المزيد.

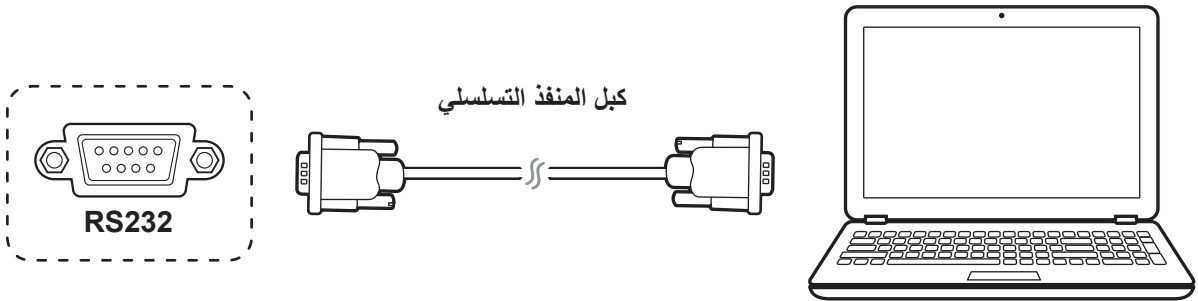

توصيل أجهزة USB الطرفية <

- ١- أجهزة USB الطرفية: قم بتوصيل كبل جهاز USB بمنفذ الدخل USB IN.
- ٢- كبلات المودم والشبكات: قم بتوصيل كبل التوجيه بمنفذ الدخل LAN IN.
- ٣- الميكروفون: قم بتوصيل كبل الميكروفون بمنفذ MIC.

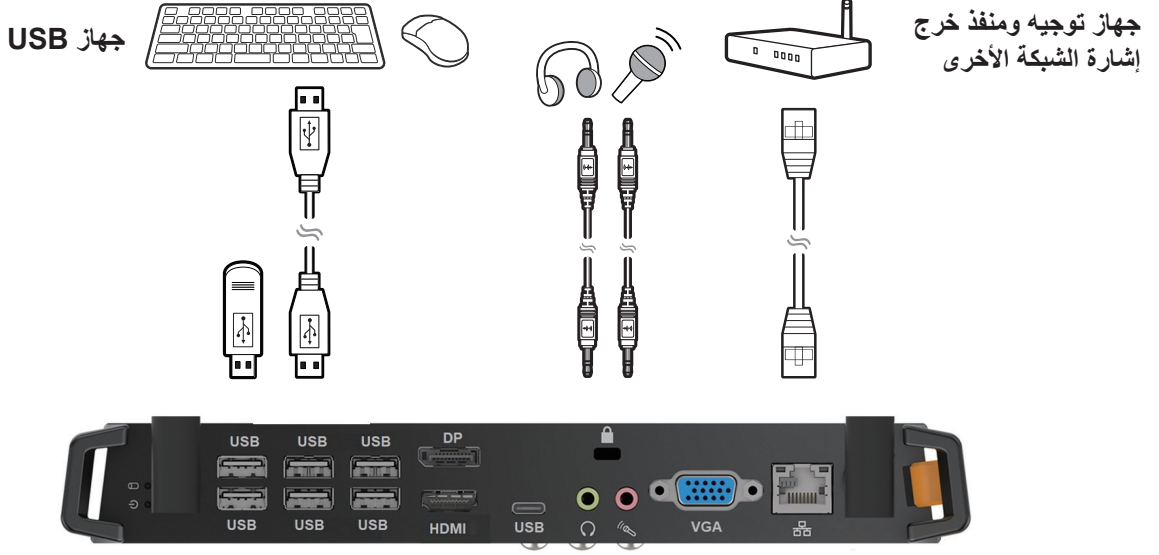

توصيلات HDMI <

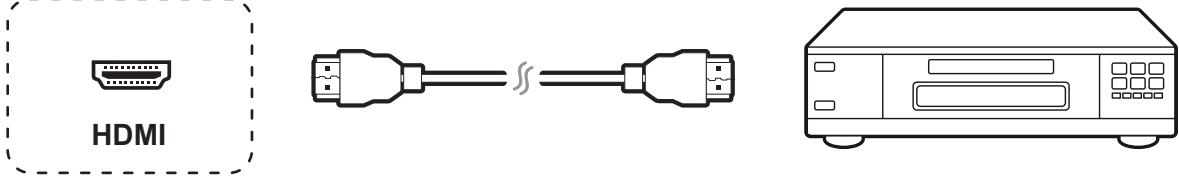

بدء الاستخدام <

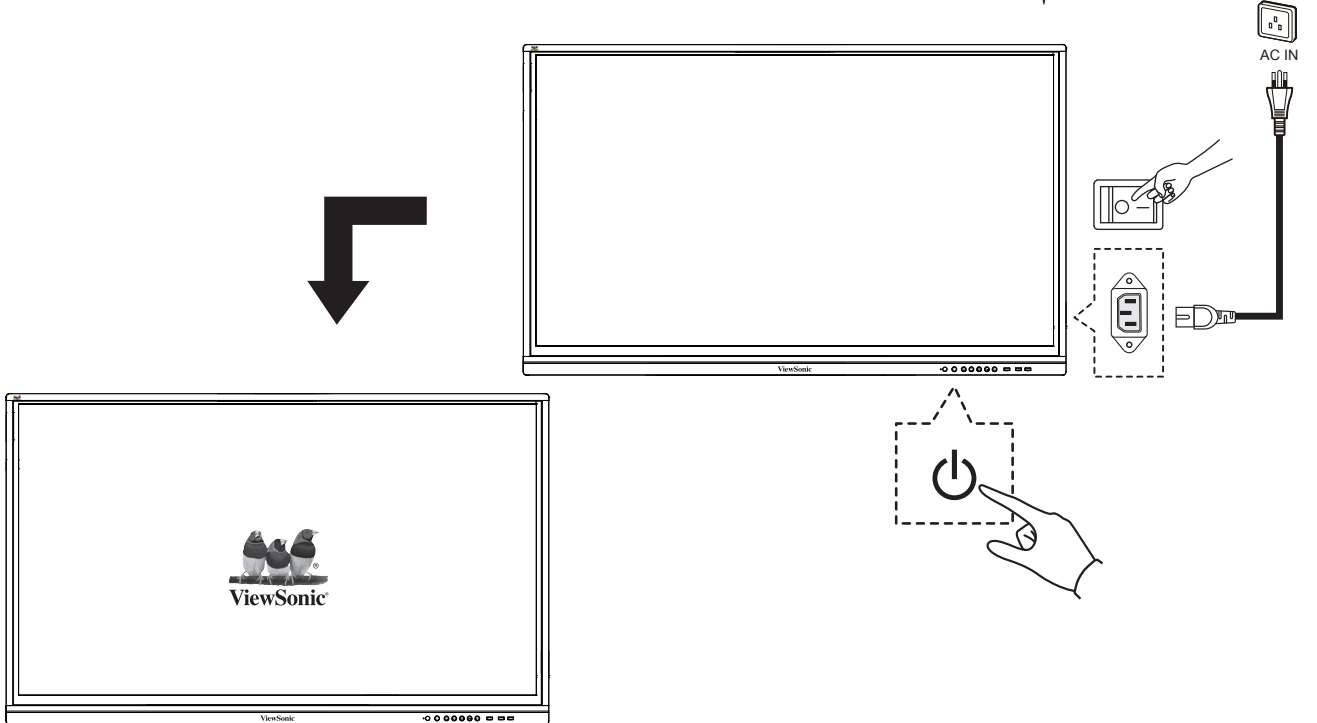



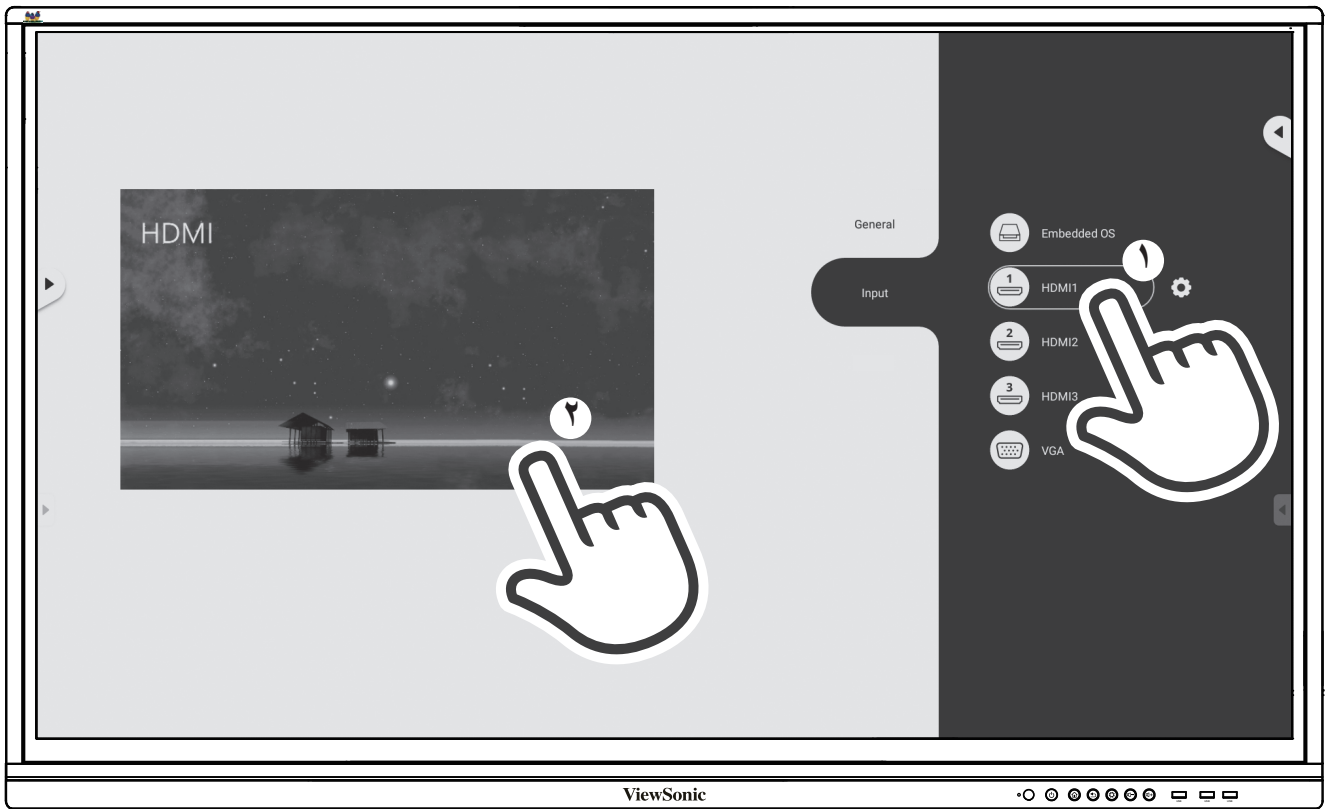
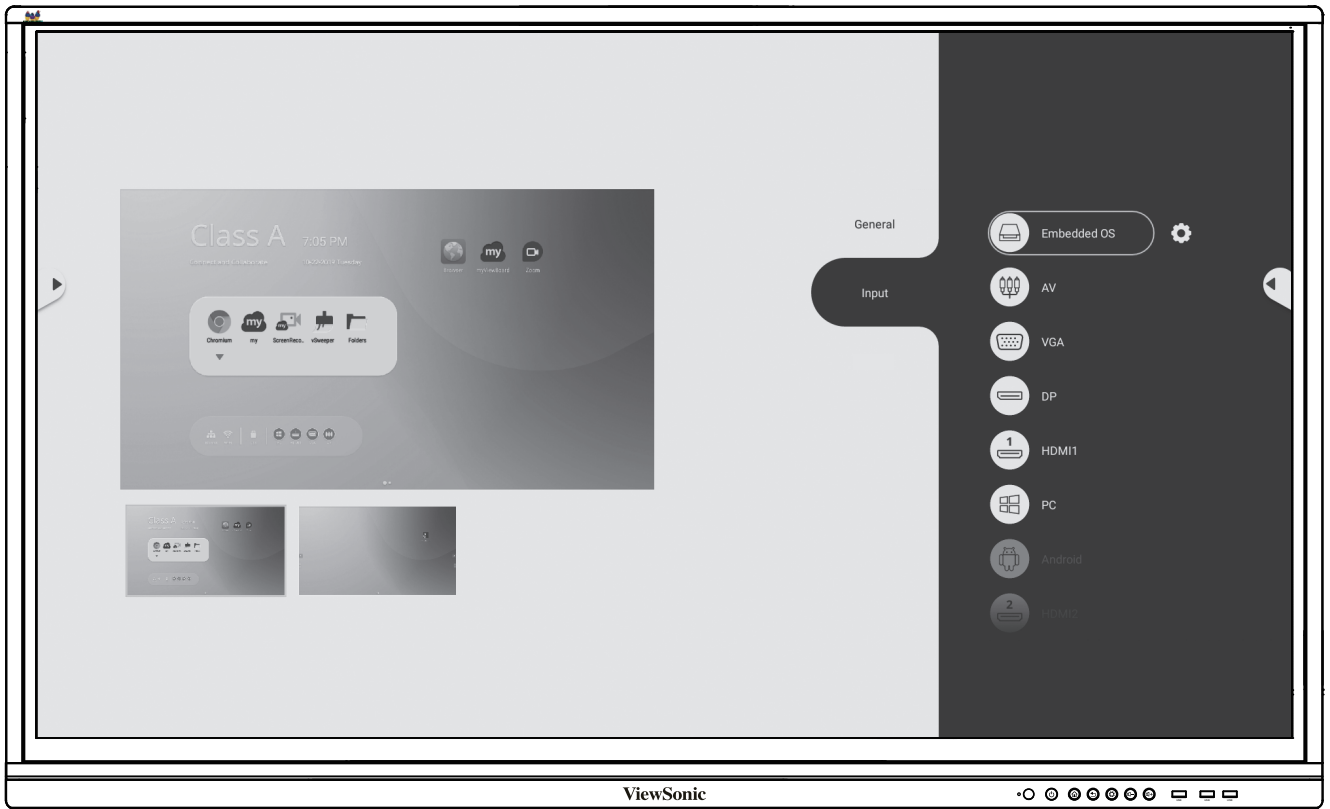

< بيان الامتثال

بيان لجنة الاتصالات الفيدرالية (FCC) لمعلومات التوافق: يتوافق هذا الجهاز مع الجزء ١٥ من قواعد لجنة الاتصالات الفيدرالية. ويخضع تشغيله إلى الشرطين التاليين: (١) ألا يتسبب هذا الجهاز في حدوث تداخل ضار، و(٢) أن يستقبل هذا الجهاز أي تداخل مستقبلي، بما في ذلك التداخل الذي قد يترتب عليه أوضاع تشغيل غير مرغوبة.

معييار الامتثال ICES-003 للصناعة الكندية: CAN ICES-3 (B)/NMB-3(B)

شركة ViewSonic (الولايات المتحدة / كندا / أمريكا اللاتينية)

www.viewsonic.com/support/product-registration : 



الولايات المتحدة

١-٨٠٠-٦٨٨-٦٦٨٨ 

customerservice@viewsonic.com 



كندا

١-٨٦٦-٤٦٣-٤٧٧٥ 

customerservice@viewsonic.com 

بورتوريكو وجزر فيرجن

http://www.viewsonic.com/la/soporte/servicio-tecnico (Español) 

أمريكا اللاتينية

http://www.viewsonic.com/la/soporte/servicio-tecnico-la/ 



الملحق الاختياري



مركز دعم ViewSonic

> 패키지 내용물

- 전원 케이블 (지역별로 달리 제공)
- 리모컨
- AAA 형 배터리 2 개
- USB 케이블
- 터치 펜
- 빠른 시작 가이드
- RS232 어댑터
- 클램프 5 개
- 카메라 플레이트
- 나사
- HDMI 와 호환되는 신호 케이블

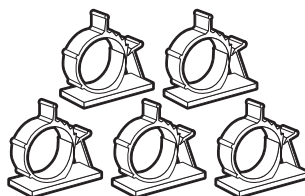
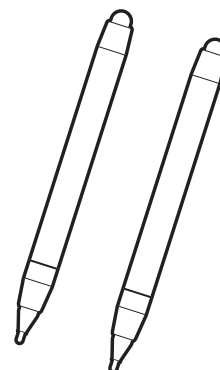
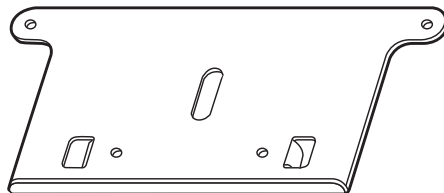
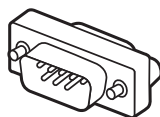
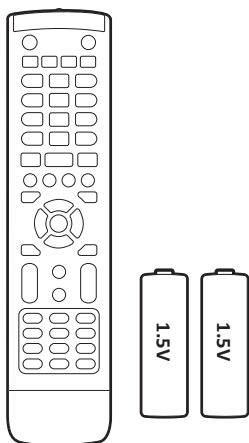
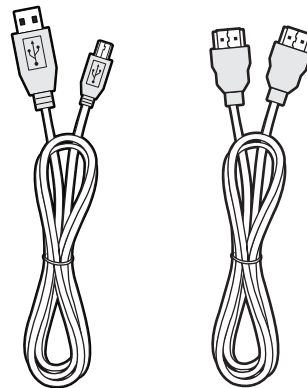

> 벽 장착 키트 사양 (VESA)

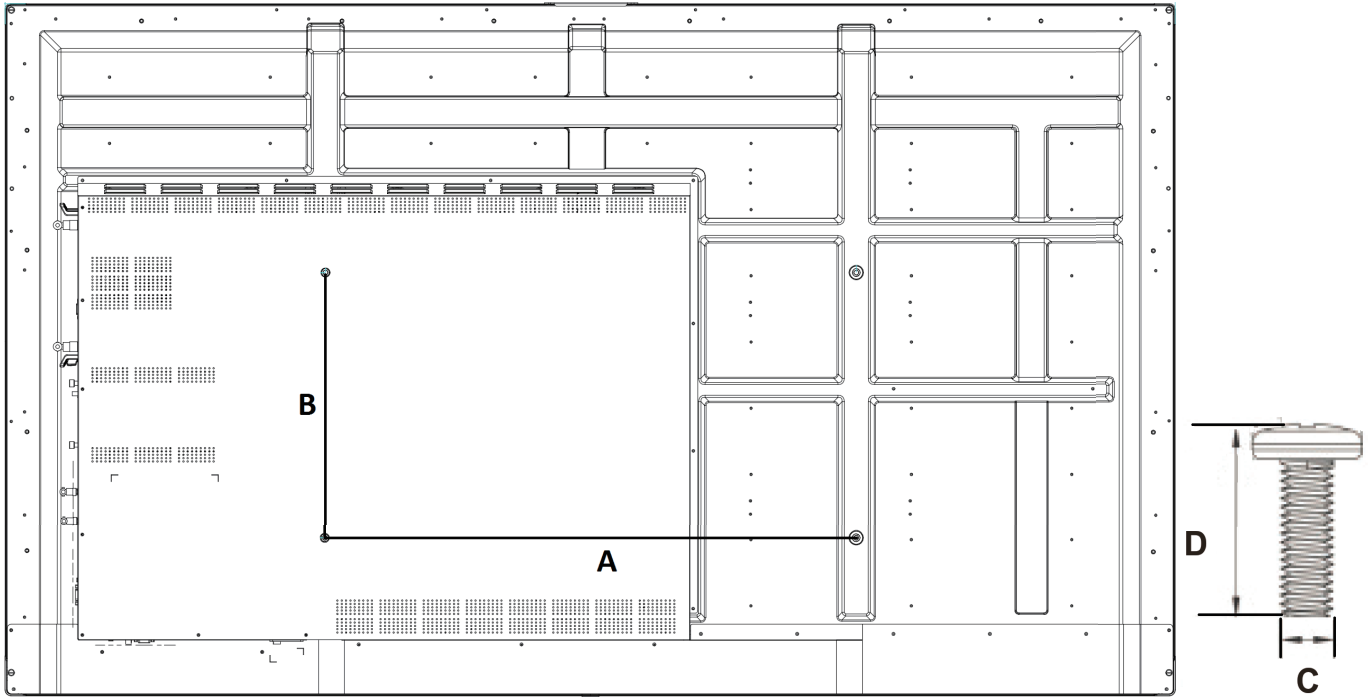

인치	VESA 사양 (A x B)	표준 나사 (C x D)	수량
IFP5550 - 55"	400 x 200 mm	M8 x 25 mm	4
IFP6550 - 65"	600 x 400 mm	M8 x 25 mm	4
IFP7550 - 75"	800 x 400 mm	M8 x 25 mm	4
IFP8650 - 86"	800 x 600 mm	M8 x 25 mm	4

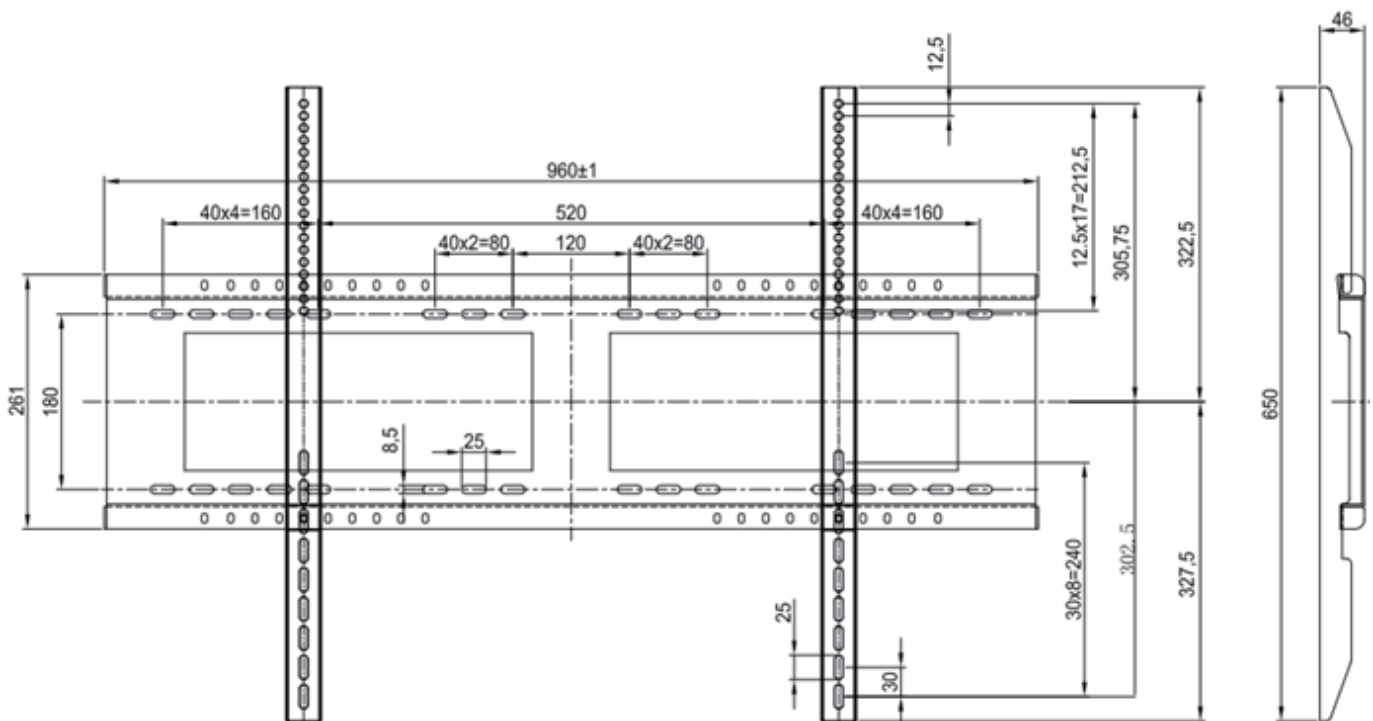

> 설치 환경 주의

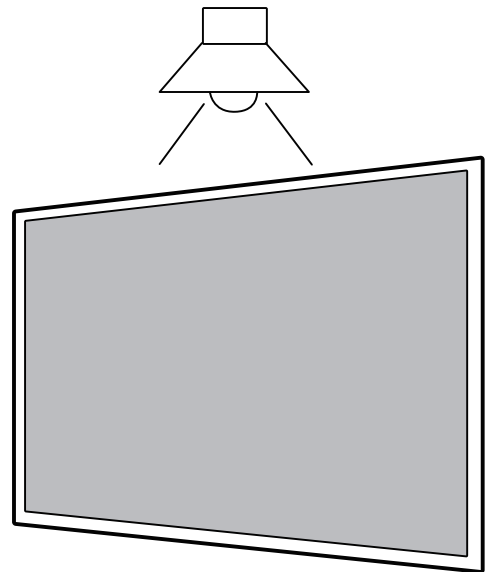
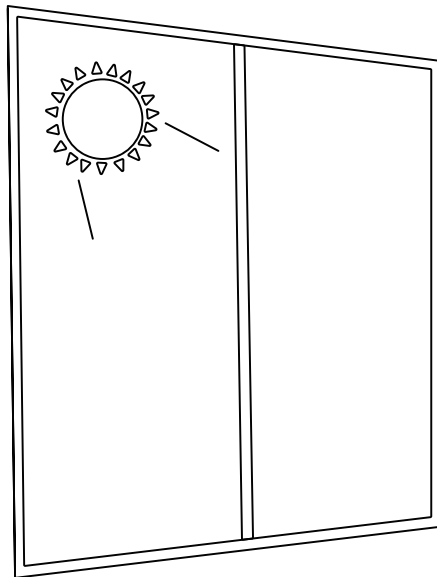
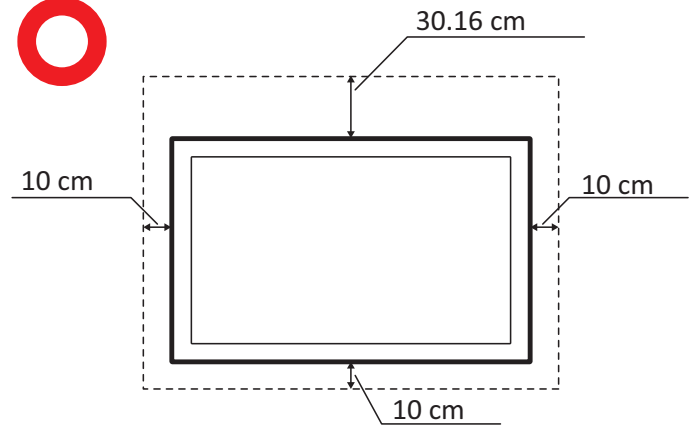
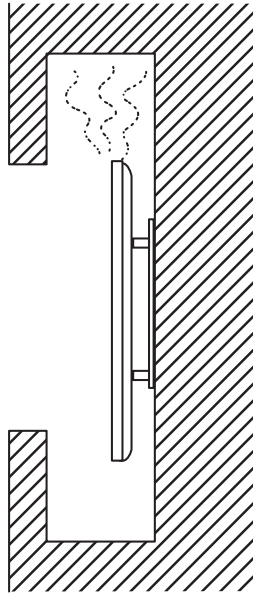

> 제어판 개요

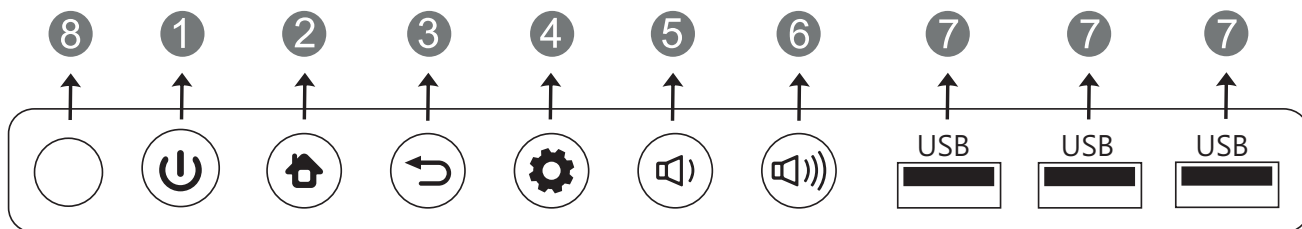

항목	설명
1	장치를 켜려면 이 키를 누릅니다 디스플레이 백라이트만 끄거나 켜려면 이 키를 누릅니다 장치를 끄려면 이 키를 길게 누릅니다
2	내장 플레이어 주 인터페이스로 돌아가기
3	내장 플레이어 이전 레벨로 돌아가기
4	기능 메뉴 불러오기
5	볼륨 낮추기
6	볼륨 높이기
7	내장된 플레이어 및 내부 PC 용 USB 포트
8	IR 리모컨으로 신호를 수신합니다

> I/O 포트

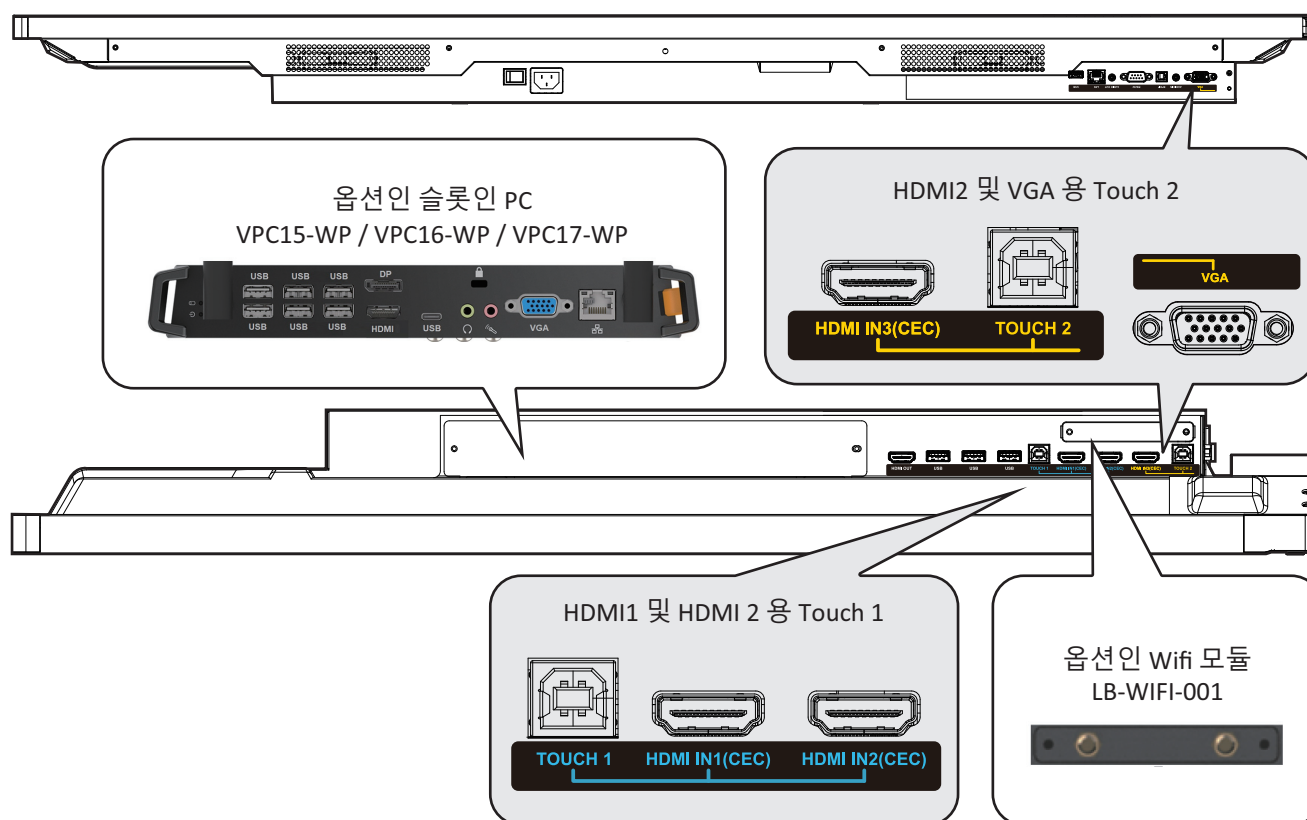

> 리모컨 개요

- 1  디스플레이를 끄거나 켜려면 누릅니다
- 2  음소거/음소거 해제
- 3 **DISPLAY** 현재 입력 소스의 디스플레이 정보
- 4 **P.MODE** 빈 화면
- 5 **FREEZE** 화면 정지
- 6 **Numeric button** 숫자 입력 버튼
- 7 **-/--/ALT+TAB** PC 애플리케이션 간에 전환하려면 누릅니다
- 8 **0** 숫자 입력 버튼
- 9  / **ALT+F4** 현재의 PC 창을 닫습니다
- 10 **INPUT** 소스 선택 버튼
- 11 **MENU** 메뉴를 표시하려면 누릅니다
- 12 **RED+ALT** 화면 캡처
- 13 **GREEN+TAB** PC 'Tab' 버튼
- 14 **YELLOW+DESKTOP** 슬롯인 PC 바탕 화면으로 전환합니다
- 15 **BLUE+BACKSPACE** PC 'Backspace' 버튼
- 16 **START / D. MENU** PC 'Windows' 버튼
- 17  / **D.TITLE** PC 'Menu' 버튼
- 18  위로 스크롤하려면 누릅니다
- 19  왼쪽으로 스크롤하려면 누릅니다
- 20  오른쪽으로 스크롤하려면 누릅니다
- 21  아래로 스크롤하려면 누릅니다
- 22 **ENTER** Enter 버튼. 옵션을 선택하려면 이 버튼을 누릅니다.
- 23  / **D.USB** 쓰기 소프트웨어 시작
- 24 **ESC / EXIT / D. SETUP** 대화 상자를 종료하는 바로 가기 버튼
- 25 **EPG** 뒤로
- 26 **FAV / SPACE** PC 'Space' 버튼
- 27 **CH. + / CH. -** CH+ : PC 이전 페이지
CH- : PC 다음 페이지
- 28 **VOL+ / VOL-** 볼륨 높이기/낮추기
- 29 **F1** Windows F1 기능
- 30 **F2** Windows F2 기능
- 31 **F3** Windows F3 기능
- 32 **F4** Windows F4 기능
- 33 **F5** Windows F5 기능
- 34 **F6** Windows F6 기능
- 35 **F7** Windows F7 기능
- 36 **F8** Windows F8 기능
- 37 **F9** Windows F9 기능
- 38 **F10** Windows F10 기능
- 39 **F11** Windows F11 기능
- 40 **F12** Windows F12 기능

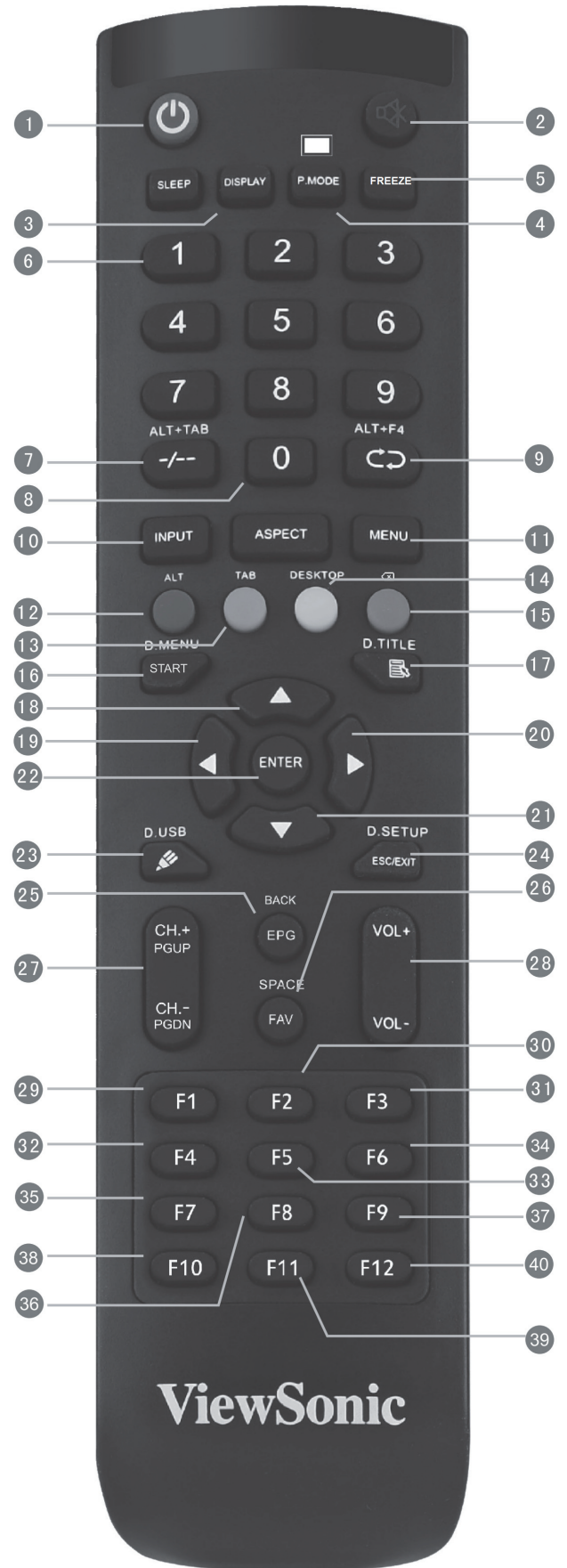

> 외부 PC 연결하기

1. 외부 PC의 비디오와 사운드를 재생하려면 아래의 지침을 따르십시오.
참고: 외부 PC는 또한 HDMI 케이블을 통해서도 디스플레이에 연결할 수 있습니다.
 - VGA 케이블 (15핀)로 외부 PC와 디스플레이의 VGA 입력 포트를 연결합니다.
 - 오디오 케이블로 외부 PC의 오디오 출력 포트와 디스플레이의 오디오 입력 포트를 연결합니다.
2. USB 케이블로 디스플레이의 터치 출력 포트와 외부 PC를 연결합니다.
참고: 최적의 결과를 얻으려면 외부 컴퓨터의 입력 해상도를 1920x1080p로 선택하십시오.

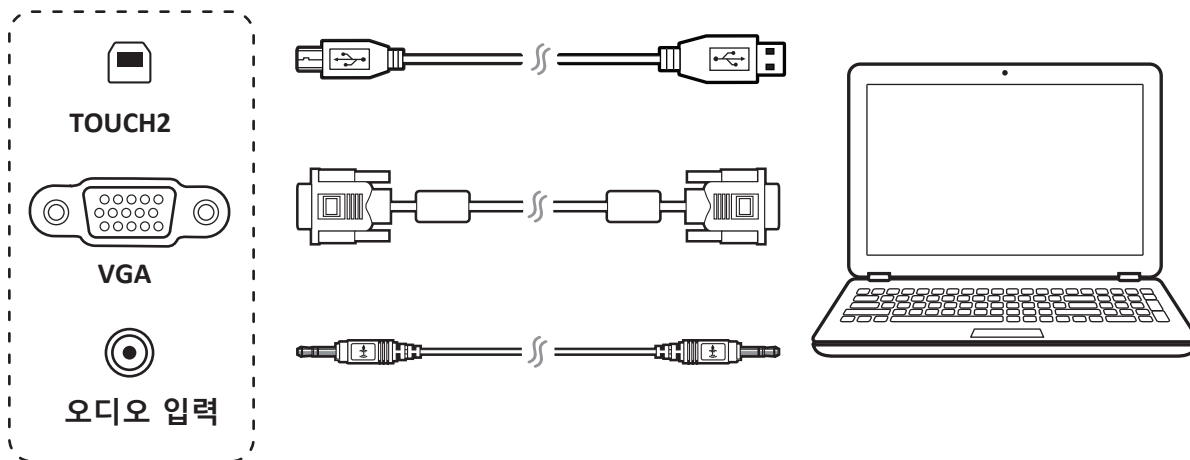

> RS232 연결

RS232 직렬 포트 케이블을 사용하여 디스플레이를 외부 컴퓨터에 연결하면 전원 켜기/끄기, 볼륨 조절 등 특정 기능을 PC에서 제어할 수 있습니다.

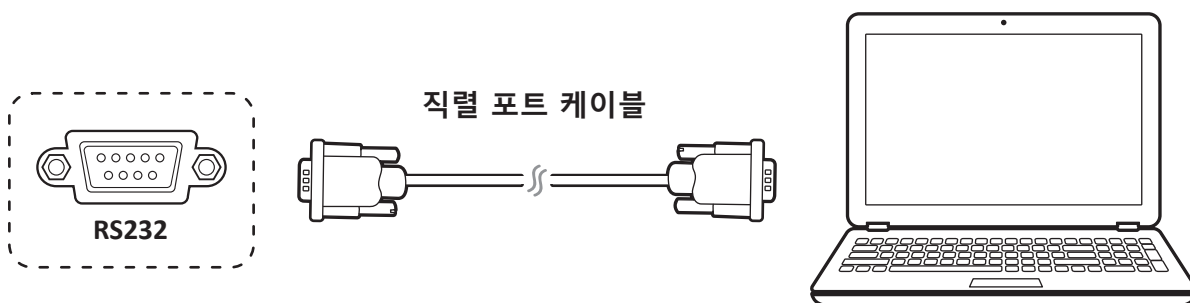

> USB 주변 장치 연결하기

1. USB 주변 장치: USB 장치 케이블을 USB 입력 포트에 꽂습니다.
2. 네트워킹 및 모뎀 케이블: 라우터 케이블을 LAN 입력 포트에 꽂습니다.
3. 마이크: 마이크 케이블을 MIC 포트에 꽂습니다.

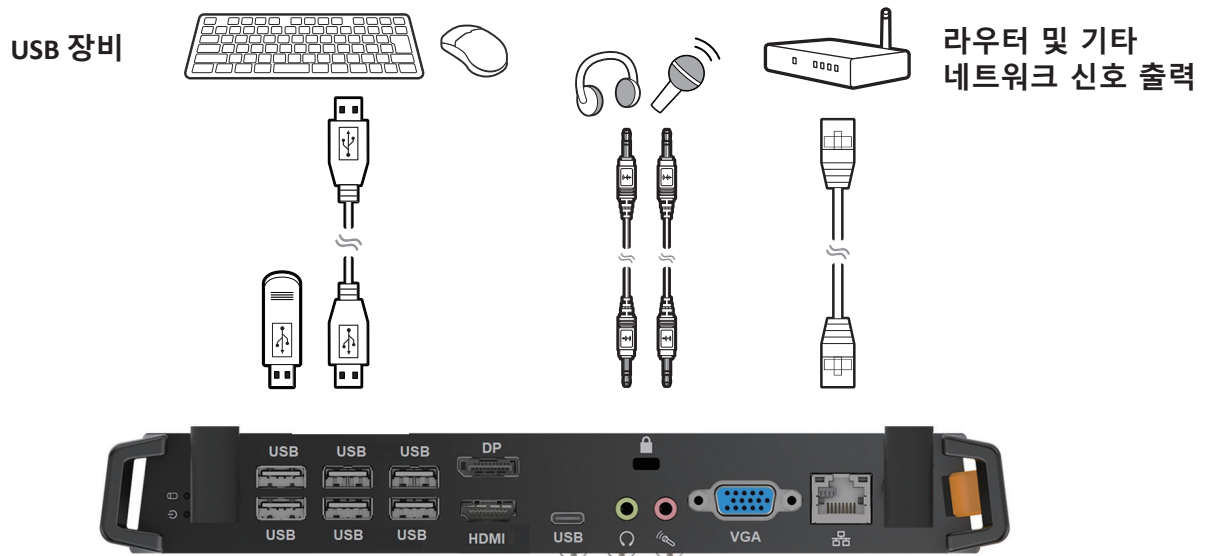

> HDMI 연결

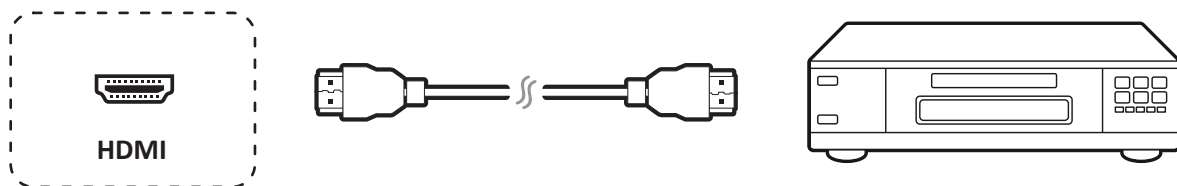

> 사용 시작하기

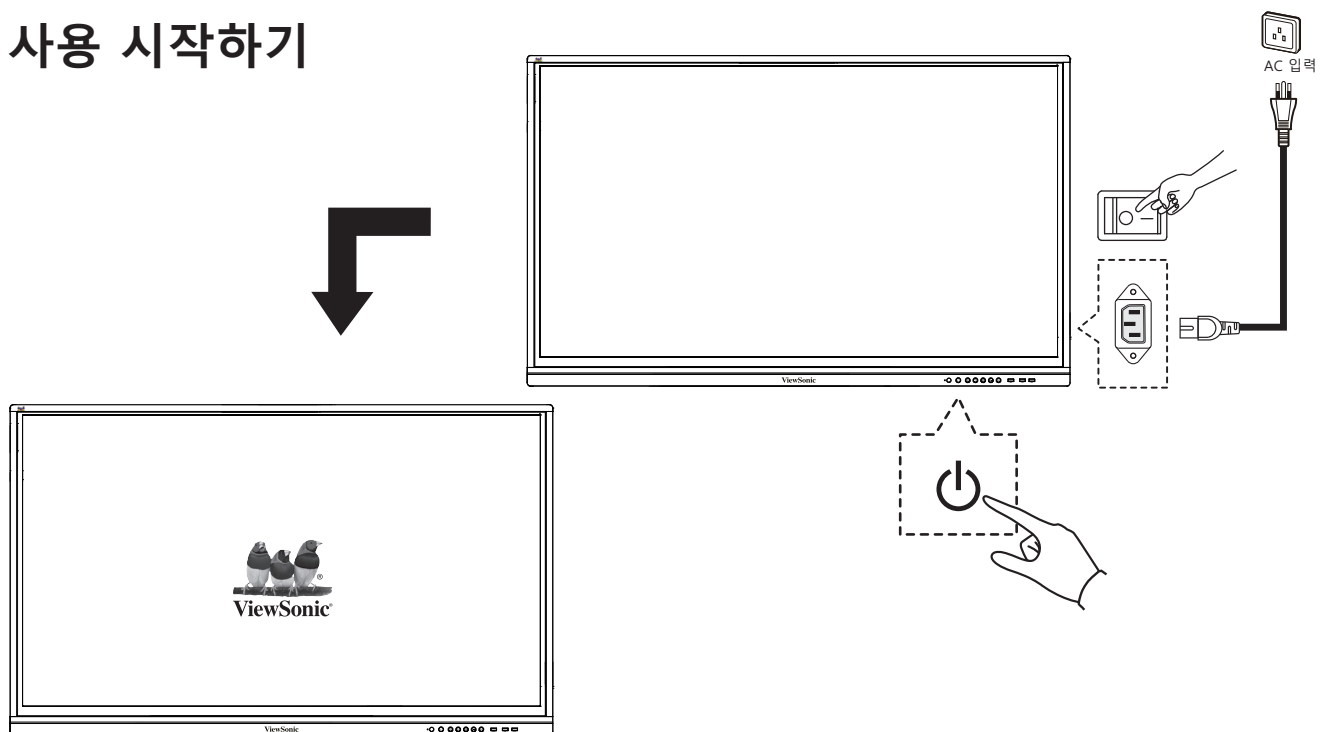



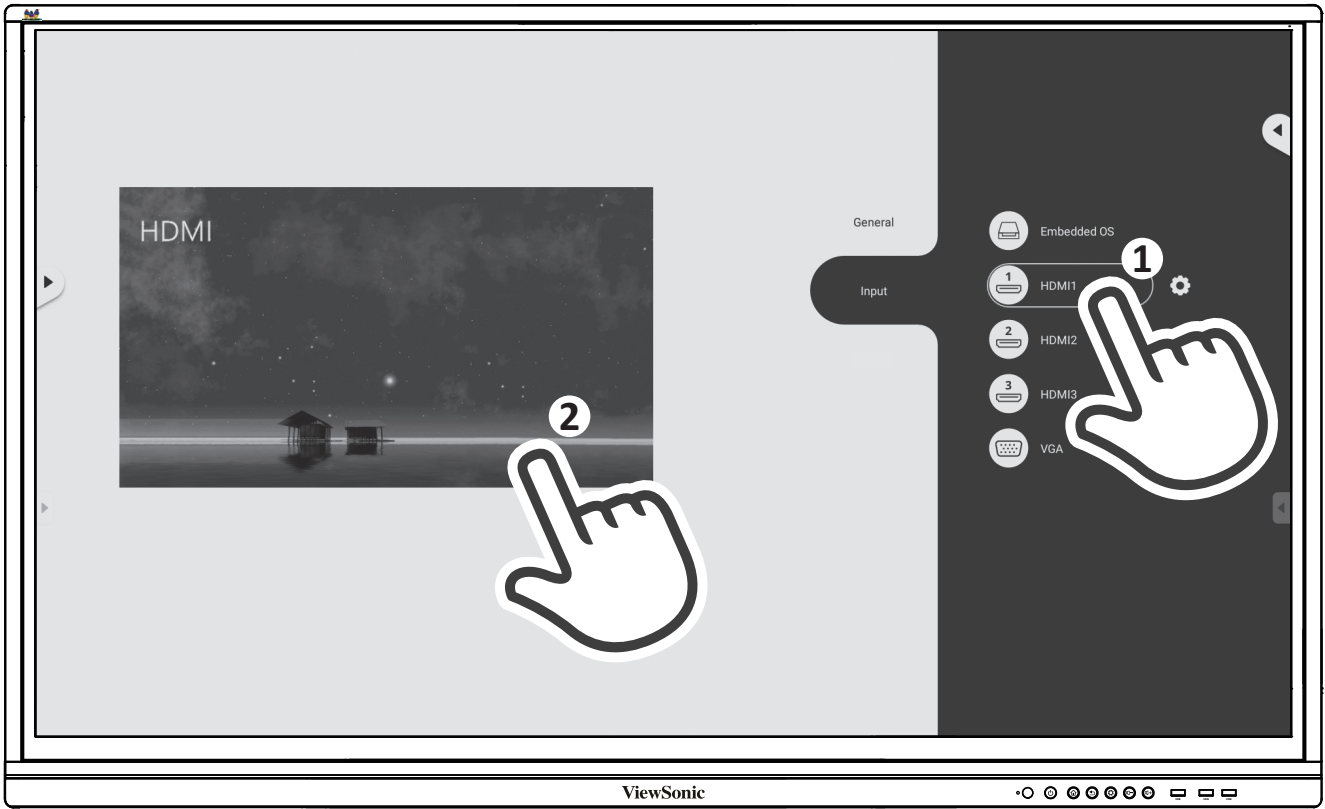
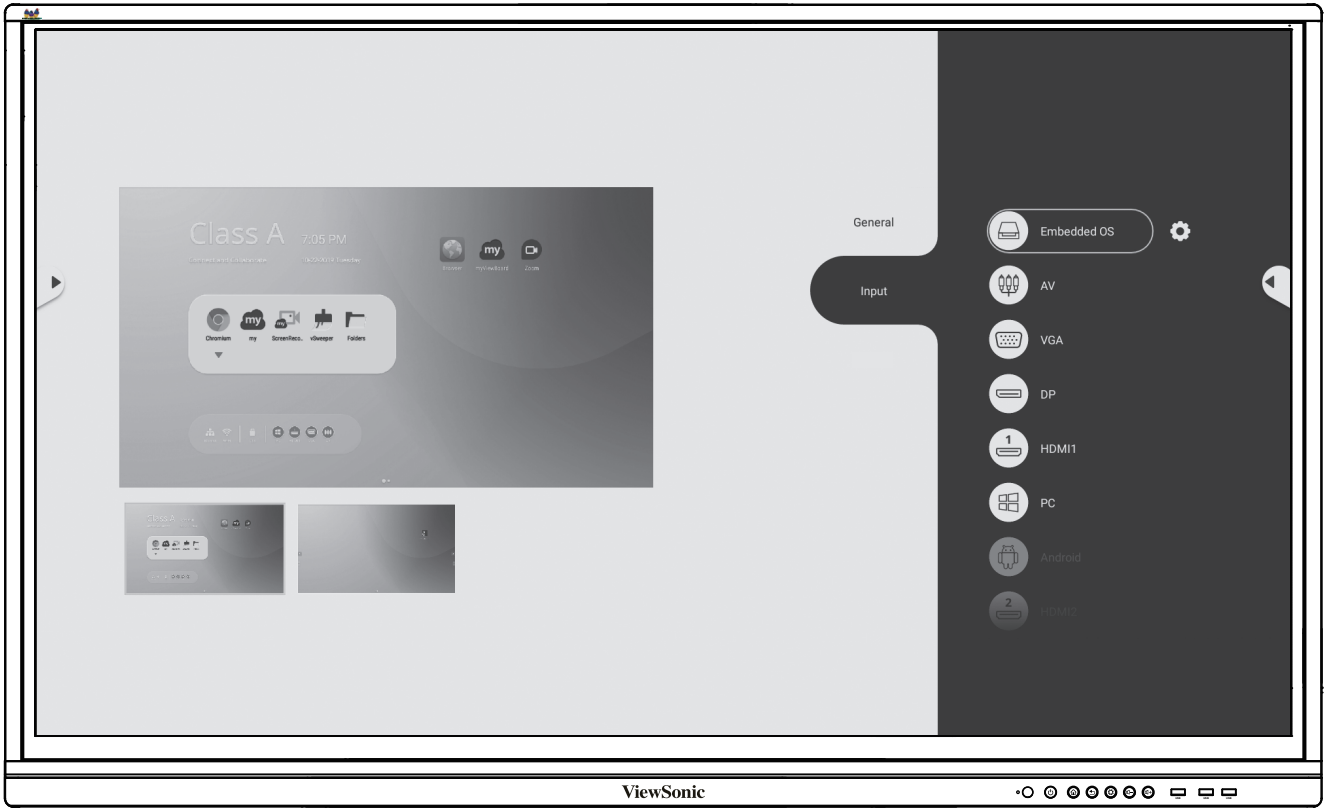

> 적합성 선언

FCC 적합성 선언: 본 장치는 FCC 규정 제 15 부를 준수합니다. 기기 작동에는 다음 두 가지 조건이 적용됩니다. (1) 이 장치는 유해한 간섭을 일으키지 않으며 (2) 이 장치는 원치 않는 작동을 일으킬 수 있는 간섭을 포함하여 어떤 간섭을 받더라도 이를 견딜 수 있어야 합니다.

캐나다 산업부 ICES-003 규정 준수: CAN ICES-3 (B)/NMB-3 (B)



ViewSonic Corporation (미국/캐나다/라틴 아메리카)

 : www.viewsonic.com/support/product-registration



미국

 1-800-688-6688

 customerservice@viewsonic.com

캐나다

 1-866-463-4775

 customerservice@viewsonic.com

푸에르토리코와 버진아일랜드

 <http://www.viewsonic.com/la/soporte/servicio-tecnico> (Español)

라틴 아메리카

 <http://www.viewsonic.com/la/soporte/servicio-tecnico-la/>



ViewSonic 지원 센터



부속품 (별매품)



ViewSonic®