

iDS-2CD7A46G0/P-IZHS(Y) 4 MP ANPR IR Varifocal Bullet Network Camera

DarkFighter



▪ DeepinView^{series}

- High quality imaging with 4 MP resolution
- Excellent low-light performance via DarkFighter technology
- Clear imaging against strong back light due to 140 dB WDR technology
- License Plate Recognition
- Efficient H.265+ compression technology to save bandwidth and storage
- 5 streams to meet a wide variety of applications
- Water and dust resistant (IP67) and vandal proof (IK10)





▪ **Function**

Road Traffic and Vehicle Detection

With embedded deep learning based license plate capture and recognition algorithms, the camera alone can achieve plate capture and recognition. The algorithm enjoys the high recognition accuracy of common plates and complex-structured plates, which is a great step forward comparing to traditional algorithms. Blocklist and allowlist are available for plate categorization and separate alarm triggering.

▪ Specification

Camera	
Image Sensor	1/1.8" Progressive Scan CMOS
Max. Resolution	2688 × 1520
Min. Illumination	Color: 0.0005 Lux @ (F1.2, AGC ON); B/W: 0.0001 Lux @ (F1.2, AGC ON), 0 Lux with IR
Shutter Time	1 s to 1/100,000 s
Day & Night	IR cut filter Blue glass module to reduce ghost phenomenon
Lens	
Focal Length & FOV	2.8 to 12 mm, horizontal FOV: 114.5° to 41.8°, vertical FOV: 59.3° to 23.6°, diagonal FOV: 141.1° to 48° 8 to 32 mm, horizontal FOV: 42.5° to 15.1°, vertical FOV: 23.3° to 8.64°, diagonal FOV: 49.6° to 17.3°
Focus	Auto, semi-auto, manual
Iris Type	P-iris
Aperture	2.8 to 12 mm: F1.2 to F2.5 8 to 32 mm: F1.7 to F1.73
Illuminator	
Supplement Light Type	IR
Supplement Light Range	2.8 to 12 mm: 50 m 8 to 32 mm: 100 m
Smart Supplement Light	Yes
IR Wavelength	850 nm
Video	
Main Stream	50 Hz: 25 fps (2688 × 1520, 2560 × 1440, 1920 × 1080, 1280 × 720) 60 Hz: 30 fps (2688 × 1520, 2560 × 1440, 1920 × 1080, 1280 × 720)
Sub-Stream	50 Hz: 25 fps (704 × 576, 640 × 480) 60 Hz: 30 fps (704 × 480, 640 × 480)
Third Stream	50 Hz: 25 fps (1920 × 1080, 1280 × 720, 704 × 576, 640 × 480) 60 Hz: 30 fps (1920 × 1080, 1280 × 720, 704 × 480, 640 × 480)
Fourth Stream	50 Hz: 25 fps (1920 × 1080, 1280 × 720, 704 × 576, 640 × 480) 60 Hz: 30 fps (1920 × 1080, 1280 × 720, 704 × 480, 640 × 480)
Fifth Stream	50 Hz: 25 fps (704 × 576, 640 × 480) 60 Hz: 30 fps (704 × 480, 640 × 480)
Video Compression	Main stream: H.265+/H.265/H.264+/H.264 Sub-stream/Third stream/Fourth stream/Fifth stream: H.265/H.264/MJPEG
Video Bit Rate	32 Kbps to 8 Mbps
H.264 Type	Baseline Profile/Main Profile/High Profile
H.265 Type	Main Profile
Bit Rate Control	CBR/VBR
Scalable Video Coding (SVC)	H.265 and H.264 encoding
Region of Interest (ROI)	4 fixed regions for each stream
Target Cropping	Yes

Audio	
Audio Type	Mono sound
Audio Compression	G.711/G.722.1/G.726/MP2L2/PCM/AAC/MP3
Audio Bit Rate	64 Kbps (G.711)/16 Kbps (G.722.1)/16 Kbps (G.726)/32 to 192 Kbps (MP2L2)/16 to 64 Kbps (AAC)/8 to 320 Kbps (MP3)
Audio Sampling Rate	8 kHz/16 kHz/32 kHz/44.1 kHz/48 kHz
Environment Noise Filtering	Yes
Network	
Protocols	TCP/IP, ICMP, HTTP, HTTPS, FTP, SFTP, SRTP, DHCP, DNS, DDNS, RTP, RTSP, RTCP, PPPoE, NTP, UPnP, SMTP, SNMP, IGMP, 802.1X, QoS, IPv6, UDP, Bonjour, SSL/TLS
Simultaneous Live View	Up to 20 channels
API	Open Network Video Interface (PROFILE S, PROFILE G, PROFILE T), ISAPI, SDK, ISUP
User/Host	Up to 32 users. 3 user levels: administrator, operator and user
Security	Password protection, complicated password, HTTPS encryption, 802.1X authentication (EAP-TLS, EAP-LEAP, EAP-MD5), watermark, IP address filter, basic and digest authentication for HTTP/HTTPS, WSSE and digest authentication for Open Network Video Interface, RTP/RTSP OVER HTTPS, Control Timeout Settings, Security Audit Log, TLS 1.2
Network Storage	NAS (NFS, SMB/CIFS), auto network replenishment (ANR) Together with high-end Hikvision memory card, memory card encryption and health detection are supported
Client	iVMS-4200, Hik-Connect, Hik-Central
Web Browser	Plug-in required live view: IE8+ Plug-in free live view: Chrome 57.0+, Firefox 52.0+, Safari 11+ Local service: Chrome 41.0+, Firefox 30.0+
Image	
Image Parameters Switch	Yes
Image Settings	Saturation, brightness, contrast, sharpness, gain, white balance adjustable by client software or web browser
Day/Night Switch	Day, Night, Auto, Schedule, Alarm Trigger, Video Trigger
Wide Dynamic Range (WDR)	140 dB
SNR	≥ 52 dB
Image Enhancement	BLC, HLC, Defog, 3D DNR
Picture Overlay	LOGO picture can be overlaid on video with 128 × 128 24bit bmp format
Image Stabilization	EIS
Interface	
Video Output	1 Vp-p Composite Output (75 Ω/CVBS) (Only for debugging)
Ethernet Interface	1 RJ45 10 M/100 M/1000 M self-adaptive Ethernet port
On-Board Storage	Built-in memory card slot, support microSD/microSDHC/microSDXC card, up to 256 GB
Audio	With -Y: 1 input (line in), 1 output (line out), 3.5 mm connector
Alarm	2 input, 2 outputs (max. 24 VDC, 1 A)
RS-485	With -Y: 1 RS-485 (half duplex, HIKVISION, Pelco-P, Pelco-D, self-adaptive)
Reset Key	Yes
Power Output	With -Y: 12 VDC, max. 100 mA

Event	
Basic Event	Motion detection, video tampering alarm, exception (network disconnected, IP address conflict, illegal login, abnormal reboot, HDD full, HDD error), video quality diagnosis, vibration detection
Smart Event	Intrusion detection, scene change detection, audio exception detection, defocus detection Line crossing detection, up to 4 lines configurable Intrusion detection, up to 4 regions configurable Region entrance detection, up to 4 regions configurable Region exiting detection, up to 4 regions configurable
Linkage	Upload to FTP/NAS/memory card, notify surveillance center, send email, trigger alarm output, trigger recording, trigger capture Trigger recording: memory card, network storage, pre-record and post-record Trigger captured pictures uploading: FTP, SFTP, HTTP, NAS, send email Trigger notification: HTTP, ISAPI, alarm output, send email
Deep Learning Function	
Perimeter Protection	Line crossing, intrusion, region entrance, region exiting Support alarm triggering by specified target types
Road Traffic and Vehicle Detection	Blocklist and allowlist: up to 10,000 records Captures vehicle that has no license plate Support license plate recognition of motorcycles (only in checkpoint scenario) Support vehicle attribute detection, including vehicle type, color, brand, etc. (City Street mode is recommended.)
General	
Power	12 VDC \pm 20%, 1.19 A, max. 14.28 W, three-core terminal block PoE: 802.3at, Type 2, Class 4, 42.5 V to 57 V), 0.396 A to 0.295 A, max. 16.8 W
Dimension	Without -Y: \varnothing 144 \times 347 mm (\varnothing 5.7" \times 13.7") With -Y: \varnothing 140 \times 351 mm (\varnothing 5.5" \times 13.8")
Package Dimension	405 \times 190 \times 180 mm (15.9" \times 7.5" \times 7.1")
Weight	Approx. 1950 g (4.2 lb.)
With Package Weight	Approx. 3070 g (6.7 lb.)
Storage Conditions	-30 $^{\circ}$ C to 60 $^{\circ}$ C (-22 $^{\circ}$ F to 140 $^{\circ}$ F). Humidity 95% or less (non-condensing)
Startup and Operating Conditions	-40 $^{\circ}$ C to 60 $^{\circ}$ C (-40 $^{\circ}$ F to 140 $^{\circ}$ F). Humidity 95% or less (non-condensing)
Language	33 languages: English, Russian, Estonian, Bulgarian, Hungarian, Greek, German, Italian, Czech, Slovak, French, Polish, Dutch, Portuguese, Spanish, Romanian, Danish, Swedish, Norwegian, Finnish, Croatian, Slovenian, Serbian, Turkish, Korean, Traditional Chinese, Thai, Vietnamese, Japanese, Latvian, Lithuanian, Portuguese (Brazil), Ukrainian
General Function	Anti-flicker, 5 streams, EPTZ, heartbeat, mirror, privacy mask, flash log, password reset via email, pixel counter

Approval	
EMC	FCC (47 CFR Part 15, Subpart B); CE-EMC (EN 55032: 2015, EN 61000-3-2:2019, EEN 61000-3-3:2013+A1:2019, EN 50130-4: 2011 +A1: 2014); RCM (AS/NZS CISPR 32: 2015); IC (ICES-003: Issue 7); KC (KN 32: 2015, KN 35: 2015)
Safety	UL (UL 62368-1); CB (IEC 62368-1:2014+A11); CE-LVD (EN 62368-1:2014/A11:2017); BIS (IS 13252(Part 1):2010/ IEC 60950-1 : 2005); LOA (IEC/EN 60950-1)
Environment	CE-RoHS (2011/65/EU); WEEE (2012/19/EU); Reach (Regulation (EC) No 1907/2006)
Protection	IK10 (IEC 62262:2002), IP67 (IEC 60529-2013)
Anti-Corrosion Protection	With -Y: NEMA 4X(NEMA 250-2018)
Automotive and Railway	EN50121-4
Other	PVC FREE

▪ Available Model

iDS-2CD7A46G0/P-IZHSY (2.8 to 12 mm, 8 to 32 mm)

iDS-2CD7A46G0/P-IZHS (2.8 to 12 mm, 8 to 32 mm)

▪ **Dimension**

-Y model:

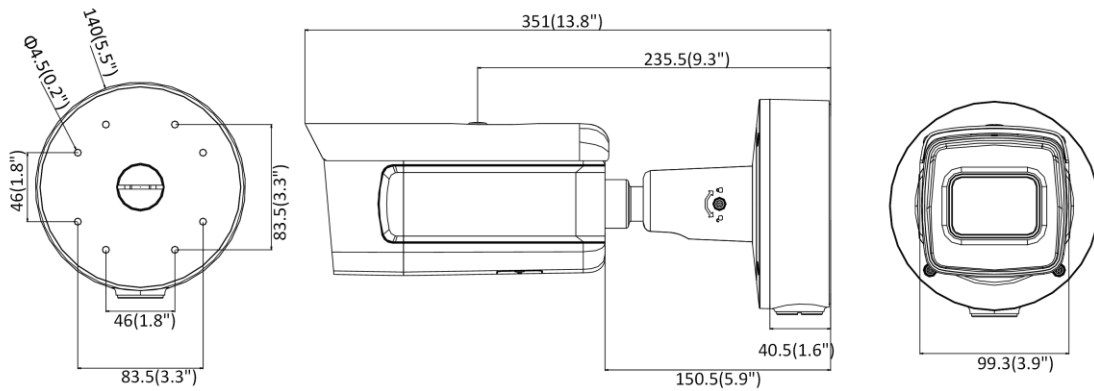



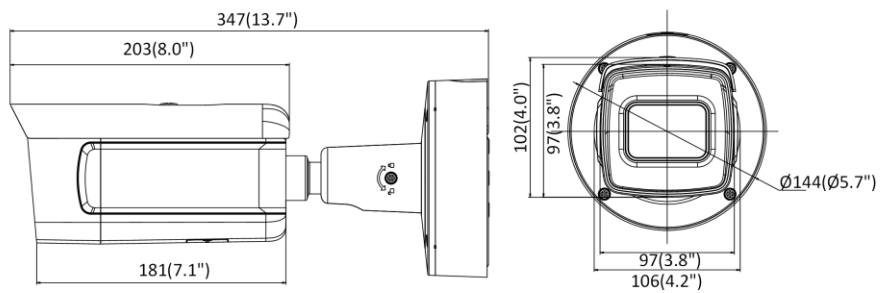

Without -Y model:



Unit: mm(inch)

▪ **Accessory**

▪ **Optional**

DS-1475ZJ-Y Vertical Pole Mount	DS-1475ZJ-SUS Vertical Pole Mount	DS-2251ZJ Pendant Mount	DS-1476ZJ-Y Corner Mount	DS-1476ZJ-SUS Corner Mount
				

Distributed by

**HIKVISION®****Headquarters**

No.555 Qianmo Road, Binjiang District,
Hangzhou 310051, China
T +86-571-8807-5998
overseasbusiness@hikvision.com

Hikvision USA
T +1-909-895-0400
sales.usa@hikvision.com

Hikvision Australia
T +61-2-8599-4233
salesau@hikvision.com

Hikvision India
T +91-22-28469900
sales@pramahikvision.com

Hikvision Canada
T +1-866-200-6690
sales.canada@hikvision.com

Hikvision Thailand
T +662-275-9949
sales.thailand@hikvision.com

Hikvision Europe
T +31-23-5542770
sales.eu@hikvision.com

Hikvision Italy
T +39-0438-6902
info.it@hikvision.com

Hikvision Brazil
T +55 11 3318-0050
Latam.support@hikvision.com

Hikvision Turkey
T +90 (216)521 7070- 7074
sales.tr@hikvision.com

Hikvision Malaysia
T +601-7652-2413
sales.my@hikvision.com

Hikvision UK & Ireland
T +01628-902140
sales.uk@hikvision.com

Hikvision South Africa
Tel: +27 (10) 0351172
sale.africa@hikvision.com

Hikvision France
T +33(0)1-85-330-450
info.fr@hikvision.com

Hikvision Kazakhstan
T +7-727-9730667
nikia.panfilov@hikvision.ru

Hikvision Vietnam
T +84-974270888
sales.vt@hikvision.com

Hikvision UAE
T +971-4-4432090
salesme@hikvision.com

Hikvision Singapore
T +65-6684-4718
sg@hikvision.com

Hikvision Spain
T +34-91-737-16-55
info.es@hikvision.com

Hikvision Tashkent
T +99-87-1238-9438
uzb@hikvision.ru

Hikvision Hong Kong
T +852-2151-1761
info.hk@hikvision.com

Hikvision Russia
T +7-495-669-67-99
saleru@hikvision.com

Hikvision Korea
T +82-(0)31-731-8817
sales.korea@hikvision.com

Hikvision Poland
T +48-22-460-01-50
info.pl@hikvision.com

Hikvision Indonesia
T +62-21-2933759
Sales.Indonesia@hikvision.com

Hikvision Colombia
sales.colombia@hikvision.com