

# BT4107

Ø50MM (2") POLE FOR FLOOR STANDS  
LENGTH: 0.75M (29.5")

## PARTS LIST

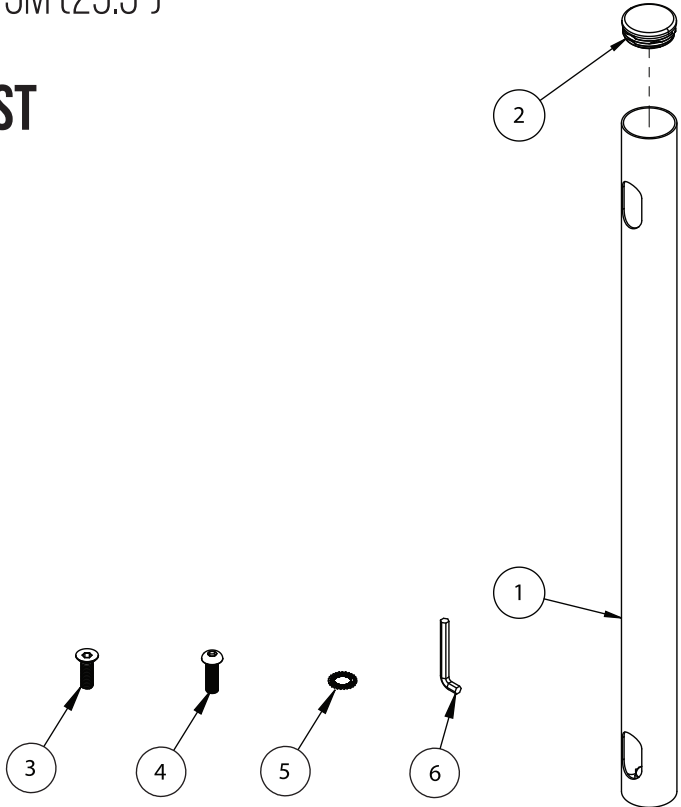

| ITEM | DESCRIPTION               | QTY |
|------|---------------------------|-----|
| 1    | Ø50mm POLE - LENGTH: 75cm | 1   |
| 2    | Ø50mm POLE END CAP        | 1   |
| 3    | M16 x 50mm CSK SCREW      | 1   |
| 4    | M16 x 50mm BUTTON SCREW   | 1   |
| 5    | M16 TOOTH WASHER          | 1   |
| 6    | 10AF HEX KEY              | 1   |

Please keep for future reference





# BT4107

Ø50MM (2") POLE  
LENGTH: 0.75M (29.5")

## PRODUCT DIMENSIONS

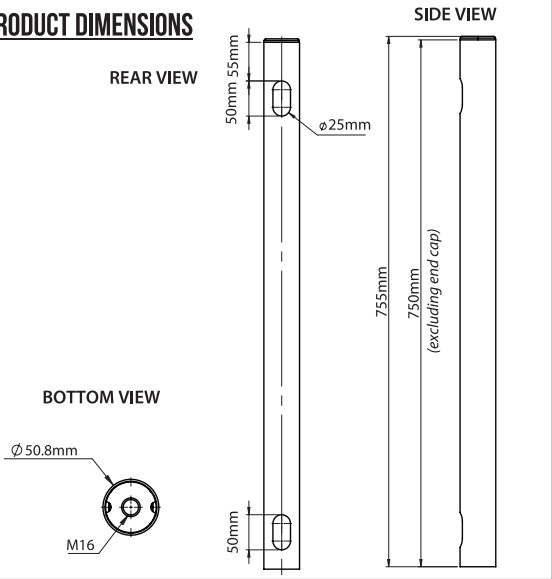

## EXAMPLE INSTALLATIONS

Note: Use a BT7052 collar to mount collar compatible mounts onto pole.

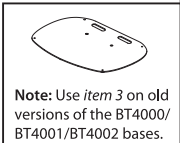
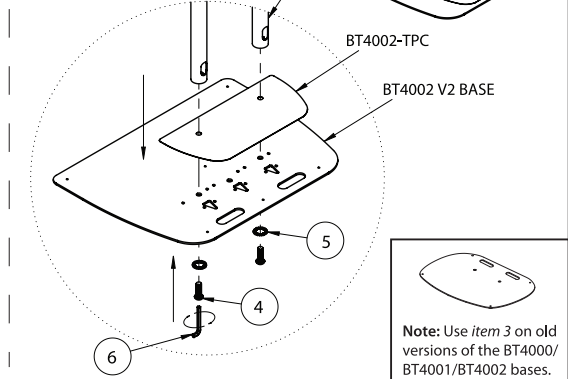
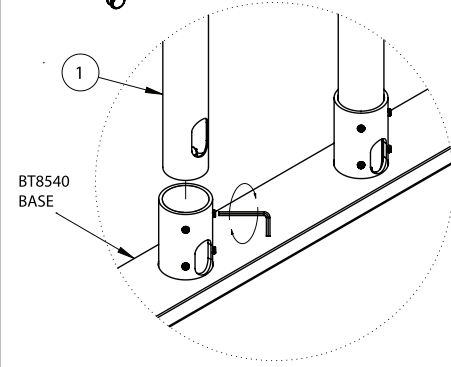
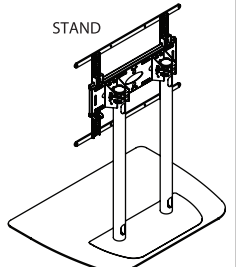
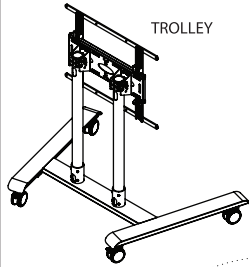

CONTACT:  
info@btechavmounts.com

©2021 B-Tech International Design & Manufacturing Ltd. All rights reserved.  
B-Tech AV Mounts is a division of B-Tech International Design & Manufacturing Ltd.  
B-Tech AV Mounts and the B-Tech logo are registered trade marks.  
All other brands and product names are trademarks of their respective owners.  
Photographs are for illustrative purposes only. E&OE.

AMA-BT4107-V1-1121-45 MADE IN VIETNAM

