



THE DISPLAY CHOICE
OF PROFESSIONALS™

www.agneovo.com

PN-55D3 LCD Display
User Manual

TABLE OF CONTENTS

SAFETY INFORMATION	1
CE Declaration of Conformity	1
Polish Center for Testing and Certification Notice	2
Electric, Magnetic and Electromagnetic Fields ("EMF")	3
Information for U.K. only.....	4
North Europe (Nordic Countries) Information.....	5
End-of-Life Disposal	6
WEEE.....	6
Turkey RoHS.....	7
Ukraine RoHS	7
PRECAUTIONS	8
Cautions When Setting Up	8
Cautions When Using.....	9
Cleaning and Maintenance.....	9
Notice for the LCD Display	10
CHAPTER 1: PRODUCT DESCRIPTION.....	11
1.1 Package Contents	11
1.2 Preparing for the Installation	12
1.3 Installing and Removing Table Stands (optional)	12
1.4 Wall Mounting Installation.....	13
1.4.1 VESA Grid	13
1.5 Mounting in Portrait Position	14
1.6 LCD Display Overview	15
1.6.1 Control Panel.....	15
1.6.2 Input/Output Terminals	16
1.7 Remote Control	18
1.7.1 General Functions	18
1.7.2 ID Remote Control.....	19
1.7.3 Inserting the Batteries in the Remote Control	20
1.7.4 Handling the Remote Control	20
1.7.5 Operating Range of the Remote Control.....	20
CHAPTER 2: MAKING CONNECTIONS.....	21
2.1 Connecting the Power	21
2.2 Connecting a Computer	22
2.2.1 Using VGA Input	22
2.2.2 Using DisplayPort Input.....	22
2.2.3 Using DVI Input	23
2.2.4 Using HDMI Input	23
2.3 Connecting External Equipment (AV Devices).....	24
2.3.1 Using HDMI Video Input.....	24
2.4 Connecting Audio Equipment.....	24
2.4.1 Connecting External Speakers	24
2.4.2 Connecting an External Audio Device	25

TABLE OF CONTENTS

2.5 Connecting USB Devices	25
2.6 Connecting Multiple Displays in a Daisy-chain Configuration	26
2.6.1 Display Control Connection	26
2.6.2 Digital Video Connection	26
2.7 IR Connection	27
2.8 IR Pass-Through Connection	27
2.9 Connecting to Wired Network	28
CHAPTER 3: USING THE LCD DISPLAY	29
3.1 Turning on the Power	29
3.2 Selecting the Input Source Signal	29
3.3 Adjusting the Volume	30
3.4 Changing the Picture Format	30
3.5 Using the Auto Adjustment Function	31
CHAPTER 4: ON SCREEN DISPLAY MENU	32
4.1 Using the OSD Menu	32
4.2 OSD Menu Tree	34
CHAPTER 5: ADJUSTING THE LCD DISPLAY	37
5.1 Picture Settings	37
5.2 Screen Settings	40
5.3 Audio Settings	42
5.4 Configuration1 Settings	44
5.5 Configuration2 Settings	48
5.6 Advanced Option	51
CHAPTER 6: APPENDIX	62
6.1 Warning Messages	62
6.2 Supported Resolution	63
6.3 Cleaning	64
6.4 Troubleshooting	65
6.5 Transporting the LCD Display	66
CHAPTER 7: SPECIFICATIONS	67
7.1 Display Specifications	67
7.2 Display Dimensions	68

SAFETY INFORMATION

CE Declaration of Conformity

This device complies with the requirements set out in the Council Directive on the Approximation of the Laws of the Member States relating to Electromagnetic Compatibility (2014/30/EU), Low-voltage Directive (2014/35/EU), RoHS directive (2011/65/EU) and Radio Equipment Directive (2014/53/EU).

This product has been tested and found to comply with the harmonized standards for Information Technology Equipment, these harmonized standards published under Directives of Official Journal of the European Union.



WARNING: This equipment is compliant with Class A of EN55032/CISPR 32. In a residential environment this equipment may cause radio interference.

SAFETY INFORMATION

Polish Center for Testing and Certification Notice

The equipment should draw power from a socket with an attached protection circuit (a three-prong socket). All equipment that works together (computer, display, printer, and so on) should have the same power supply source.

The phasing conductor of the room's electrical installation should have a reserve short-circuit protection device in the form of a fuse with a nominal value no larger than 16 amperes (A).

To completely switch off the equipment, the power supply cable must be removed from the power supply socket, which should be located near the equipment and easily accessible.

A protection mark "B" confirms that the equipment is in compliance with the protection usage requirements of standards PN-93/T-42107 and PN-89/E-06251.

Wymagania Polskiego Centrum Badań i Certyfikacji

Urządzenie powinno być zasilane z gniazda z przyłączonym obwodem ochronnym (gniazdo z kołkiem). Współpracujące ze sobą urządzenia (komputer, monitor, drukarka) powinny być zasilane z tego samego źródła.

Instalacja elektryczna pomieszczenia powinna zawierać w przewodzie fazowym rezerwową ochronę przed zwarciami, w postaci bezpiecznika o wartości znamionowej nie większej niż 16A (amperów).

W celu całkowitego wyłączenia urządzenia z sieci zasilania, należy wyjąć wtyczkę kabla zasilającego z gniazdka, które powinno znajdować się w pobliżu urządzenia i być łatwo dostępne.

Znak bezpieczeństwa "B" potwierdza zgodność urządzenia z wymaganiami bezpieczeństwa użytkownika zawartymi w PN-93/T-42107 i PN-89/E-06251.

Pozostałe instrukcje bezpieczeństwa

- Nie należy używać wtyczek adapterowych lub usuwać kołka obwodu ochronnego z wtyczki. Jeżeli konieczne jest użycie przedłużacza to należy użyć przedłużacza 3-żyłowego z prawidłowo połączonym przewodem ochronnym.
- System komputerowy należy zabezpieczyć przed nagłymi, chwilowymi wzrostami lub spadkami napięcia, używając eliminatora przepięć, urządzenia dopasowującego lub bezzakłóceńowego źródła zasilania.
- Należy upewnić się, aby nic nie leżało na kablach systemu komputerowego, oraz aby kable nie były umieszczone w miejscu, gdzie można byłoby na nie nadeptywać lub potykać się o nie.
- Nie należy rozlewać napojów ani innych płynów na system komputerowy.
- Nie należy wpychać żadnych przedmiotów do otworów systemu komputerowego, gdyż może to spowodować pożar lub porażenie prądem, poprzez zwarcie elementów wewnętrznych.
- System komputerowy powinien znajdować się z dala od grzejników i źródeł ciepła. Ponadto, nie należy blokować otworów wentylacyjnych. Należy unikać kładzenia luźnych papierów pod komputer oraz umieszczania komputera w ciasnym miejscu bez możliwości cyrkulacji powietrza wokół niego.

SAFETY INFORMATION

Electric, Magnetic and Electromagnetic Fields (“EMF”)

- We manufacture and sell many products targeted at consumers, which, like any electronic apparatus, in general have the ability to emit and receive electromagnetic signals.
- One of our leading Business Principles is to take all necessary health and safety measures for our products, to comply with all applicable legal requirements and to stay well within the EMF standards applicable at the time of producing the products.
- We are committed to develop, produce and market products that cause no adverse health effects.
- We confirm that if its products are handled properly for their intended use, they are safe to use according to scientific evidence available today.
- We play an active role in the development of international EMF and safety standards, enabling us to anticipate further developments in standardization for early integration in its products.

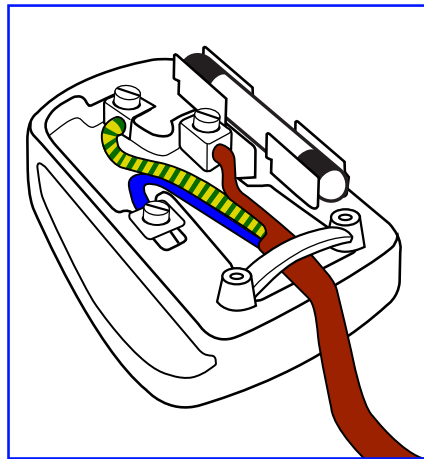

How to connect a plug

The wires in the mains lead are coloured in accordance with the following code:

BLUE - “NEUTRAL” (“N”)

BROWN - “LIVE” (“L”)

GREEN & YELLOW - “EARTH” (“E”)

- The GREEN & YELLOW wire must be connected to the terminal in the plug which is marked with the letter “E” or by the Earth symbol or coloured GREEN or GREEN & YELLOW.
- The BLUE wire must be connected to the terminal which is marked with the letter “N” or coloured BLACK.
- The BROWN wire must be connected to the terminal which marked with the letter “L” or coloured RED.

Before replacing the plug cover, make certain that the cord grip is clamped over the sheath of the lead - not simply over the three wires.

SAFETY INFORMATION

Information for U.K. only

WARNING - THIS APPLIANCE MUST BE EARTHED.

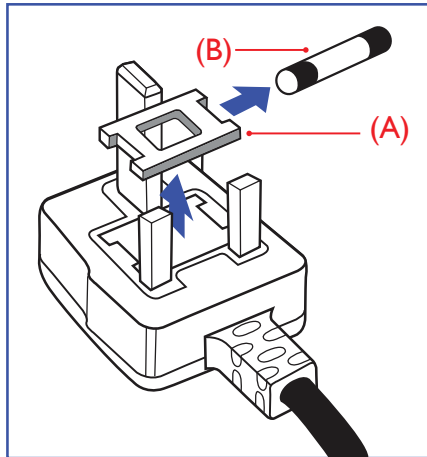

Important:

This apparatus is supplied with an approved moulded 13A plug. To change a fuse in this type of plug proceed as follows:

- 1 Remove fuse cover and fuse.
- 2 Fit new fuse which should be a BS 1362 5A, A.S.T.A. or BSI approved type.
- 3 Refit the fuse cover.

If the fitted plug is not suitable for your socket outlets, it should be cut off and an appropriate 3-pin plug fitted in its place.

If the mains plug contains a fuse, this should have a value of 5A. If a plug without a fuse is used, the fuse at the distribution board should not be greater than 5A.



Note:

The severed plug must be destroyed to avoid a possible shock hazard should it be inserted into a 13A socket elsewhere.

SAFETY INFORMATION

North Europe (Nordic Countries) Information

Placering/Ventilation

WARNING: FÖRSÄKRA DIG OM ATT HUVUDBRYTARE OCH UTTAG ÄR LÄTLTKOMLIGA, NÄR DU STÄLLER DIN UTRUSTNING PÅ PLATS.

Placering/Ventilation

ADVARSEL: SØRØG VED PLACERINGEN FOR, AT NETLEDNINGENS STIK OG STIKKONTAKT ER NEMT TILGÅNGELIGE.

Paikka/Ilmankierto

VAROITUS: SIJOITA LAITE SITEN, ETTÄ VERKKOJOHTO VOIDAAN TARVITTAESSA HELPOSTI IRROTTAA PISTORASIESTA.

Plassering/Ventilasjon

ADVARSEL: NØR DETTE UTSTYRET PLASSERES, MØ DU PASSE PÅ AT KONTAKTENE FOR STRØMTILFØRSEL ER LETTE Å NØ.

SAFETY INFORMATION

End-of-Life Disposal

Your new Public Information Display contains materials that can be recycled and reused. Specialized companies can recycle your product to increase the amount of reusable materials and to minimize the amount to be disposed of.

Please find out about the local regulations on how to dispose of your old display from your local dealer.

(For customers in Canada and U.S.A.)

This product may contain lead and/or mercury. Dispose of in accordance to local-state and federal regulations. For additional information on recycling contact www.eia.org (Consumer Education Initiative).

WEEE

Disposal of Waste Equipment by Users in Private Household in the European Union.



This symbol on the product or on its packaging indicates that this product must not be disposed of with your other household waste. Instead, it is your responsibility to dispose of your waste equipment by handing it over to a designated collection point for the recycling of waste electrical and electronic equipment. The separate collection and recycling of your waste equipment at the time of disposal will help to conserve natural resources and ensure that it is recycled in a manner that protects human health and the environment. For more information about where you can drop off your waste equipment for recycling, please contact your local city office, your household waste disposal service or the shop where you purchased the product.

For Private Households in the European Union. To help conserve natural resources and ensure the product is recycled in a manner that protects human health and the environment, we would like to bring your attention to the following:

- The crossed-out dustbin on the device or outer packaging indicates the product is compliant with European WEEE (Waste Electrical and Electronic Equipment) Directive
- Always dispose of the old devices separately from household waste
- Batteries should be removed beforehand and disposed separately to the right collection system
- You are responsible with regard to the deletion of personal data on old devices before disposal
- Private households can hand in their old devices free of charge
- For more information about where you can drop off your waste equipment for recycling, please contact your local city office, your household waste disposal service or the shop where you purchased the product

Attention users in United States:

Please dispose of according to all Local, State and Federal Laws. For the disposal or recycling information, contact: www.mygreenelectronics.com or www.eiae.org.

SAFETY INFORMATION

End of Life Directives-Recycling



Your new Public Information Display contains several materials that can be recycled for new users. Please dispose of according to all Local, State, and Federal laws.

Restriction on Hazardous Substances statement (India)

This product complies with the "India E-waste Rule 2011" and prohibits use of lead, mercury, hexavalent chromium, polybrominated biphenyls or polybrominated diphenyl ethers in concentrations exceeding 0.1 weight % and 0.01 weight % for cadmium, except for the exemptions set in Schedule 2 of the Rule.

E-Waste Declaration for India



This symbol on the product or on its packaging indicates that this product must not be disposed of with your other household waste. Instead it is your responsibility to dispose of your waste equipment by handing it over to a designated collection point for the recycling of waste electrical and electronic equipment. The separate collection and recycling of your waste equipment at the time of disposal will help to conserve natural resources and ensure that it is recycled in a manner that protects human health and the environment.

Batteries



For EU: The crossed-out wheeled bin implies that used batteries should not be put to the general household waste! There is a separate collection system for used batteries, to allow proper treatment and recycling in accordance with legislation.

Please contact your local authority for details on the collection and recycling schemes.

For Switzerland: The used battery is to be returned to the selling point.

For other non-EU countries: Please contact your local authority for correct method of disposal of the used battery.

According to EU directive 2006/66/EC, the battery can't be disposed improperly. The battery shall be separated to collect by local service.

Turkey RoHS

Türkiye Cumhuriyeti: EEE Yönetmeliğine Uygundur.

Ukraine RoHS

Обладнання відповідає вимогам Технічного регламенту щодо обмеження використання деяких небезпечних речовин в електричному та електронному обладнанні, затвердженого постановою Кабінету Міністрів України від 3 грудня 2008 № 1057.

PRECAUTIONS

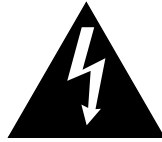

Symbols used in this manual

	This icon indicates the existence of a potential hazard that could result in personal injury or damage to the product.
	This icon indicates important operating and servicing information.

Notice

- Read this User Manual carefully before using the LCD display and keep it for future reference.
- The product specifications and other information provided in this User Manual are for reference only. All information is subject to change without notice. Updated content can be downloaded from our web site at www.agneovo.com.
- To protect your rights as a consumer, do not remove any stickers from the LCD display. Doing so may affect the determination of the warranty period.

Cautions When Setting Up

- Do not place the LCD display near heat sources, such as a heater, exhaust vent, or in direct sunlight.
- Do not cover or block the ventilation holes in the housing.
- Place the LCD display on a stable area. Do not place the LCD display where it may subject to vibration or shock.
- Place the LCD display in a well-ventilated area.
- Do not place the LCD display outdoors.
- To avoid the risk of shock or permanent damage to the set, do not expose the display to dust, rain, water or an excessively moist environment.
- Do not spill liquid or insert sharp objects into the LCD display through the ventilation holes. Doing so may cause accidental fire, electric shock or damage the LCD display.

PRECAUTIONS

Cautions When Using

- Use only the power cord supplied with the LCD display.
- The power outlet should be installed near the LCD display and be easily accessible.
- If an extension cord is used with the LCD display, ensure that the total current consumption plugged into the power outlet does not exceed the ampere rating.
- Do not allow anything to rest on the power cord. Do not place the LCD display where the power cord may be stepped on.
- If the LCD display will not be used for an indefinite period of time, unplug the power cord from the power outlet.
- To disconnect the power cord, grasp and pull by the plug head. Do not tug on the cord; doing so may cause fire or electric shock.
- Do not unplug or touch the power cord with wet hands.
- When turning off the display by detaching the power cord, wait 6 seconds before re-attaching the power cord for normal operation.
- Do not knock or drop the display during operation or transportation.

Cleaning and Maintenance

- To protect your display from possible damage, do not put excessive pressure on the LCD panel. When moving your display, grasp the frame to lift; do not lift the display by placing your hand or fingers on the LCD panel.
- Unplug the display if you need to clean it with a slightly damp cloth. The screen may be wiped with a dry cloth when the power is off. However, never use organic solvent, such as, alcohol, or ammonia-based liquids to clean your display.
- If your display becomes wet, wipe it with dry cloth as soon as possible.
- If a foreign substance or water gets in your display, turn the power off immediately and disconnect the power cord. Then remove the foreign substance or water, and send the unit to the maintenance center.
- In order to maintain the best performance of your display and ensure a longer lifetime, we strongly recommend using the display in a location that falls within the following temperature and humidity ranges.
 - Temperature: 5°C-40°C (41°F-104°F)
 - Humidity: 20%-80% (non-condensing)



Warning:



Unplug the power cord from the power outlet and refer to qualified service

personnel under the following conditions:

- When the power cord is damaged.
- If the LCD display has been dropped or the housing has been damaged.
- If the LCD display emits smoke or a distinct odor.

PRECAUTIONS

Notice for the LCD Display

- In order to maintain the stable luminous performance, it is recommended to use low brightness setting.
- Due to the lifespan of the lamp, it is normal that the brightness quality of the LCD display may decrease with time.
- When static images are displayed for long periods of time, the image may cause an imprint on the LCD display. This is called image retention or burn-in.
 - To prevent image retention, do any of the following:
 - Set the LCD display to turn off after a few minutes of being idle.
 - Use a screen saver that has moving graphics or a blank white image.
 - Execute the ANTI-BURN-IN function of the LCD display. See “General Settings, ANTI-BURN-IN” section.
 - Switch desktop backgrounds regularly.
 - Adjust the LCD display to low brightness settings.
 - Turn off the LCD display when the system is not in use.
 - Things to do when the LCD display shows image retention:
 - Turn off the LCD display for extended periods of time. It can be several hours or several days.
 - Use a screen saver and run it for extended periods of time.
 - Use a black and white image and run it for extended periods of time.
- There are millions of micro transistors inside the LCD display. It is normal for a few transistors to be damaged and to produce spots. This is acceptable and is not considered a failure.
- **IMPORTANT:** Always activate a moving screen saver program when you leave your display unattended. Always activate a periodic screen refresh application if the unit will display unchanging static content. Uninterrupted display of still or static images over an extended period may cause “burn in”, also known as “after-imaging” or “ghost imaging”, on your screen. This is a well-known phenomenon in LCD panel technology. In most cases, the “burned in” or “after-imaging” or “ghost imaging” will disappear gradually over a period of time after the power has been switched off.
- **WARNING:** Severe “burn-in” or “after-image” or “ghost image” symptoms will not disappear and cannot be repaired. This is also not covered under the terms of your warranty.

CHAPTER 1: PRODUCT DESCRIPTION

1.1 Package Contents

When unpacking, check if the following items are included in the package. If any of them is missing or damaged, contact your dealer.

LCD Display

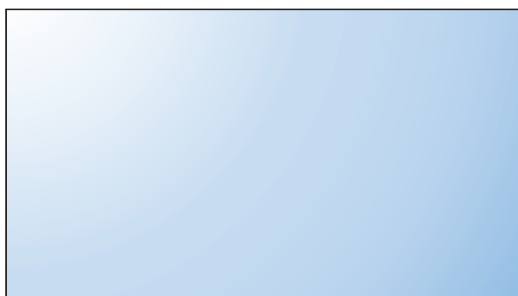

Quick Start Guide



Remote Control

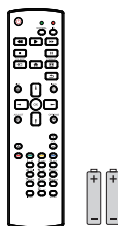

Power Cord



RS232 Daisy-Chain Cable

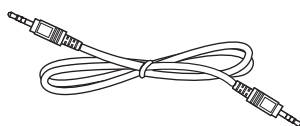

RS232 Cable

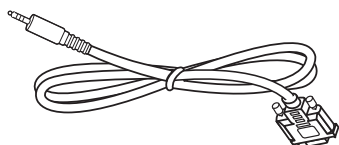

HDMI Cable

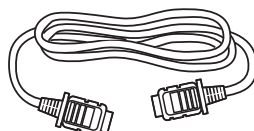

IR Sensor Cable

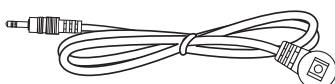

DVI Cable

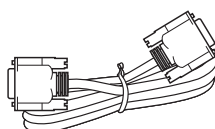

Note:

- Remote control is shipped with the supplied AAA batteries.
- For all other regions, apply a power cord that conforms to the AC voltage of the power socket and has been approved by and complies with the safety regulations of the particular country.
- You might like to save the package box and packing material for shipping the display.

Note:

- The pictures are for reference only. Actual items may vary upon shipment.

PRODUCT DESCRIPTION

1.2 Preparing for the Installation

- Due to the high power consumption, always use the plug exclusively designed for this product. If an extended line is required, please consult your service agent.
- The product should be installed on a flat surface to avoid tipping. The distance between the back of the product and the wall should be maintained for proper ventilation. Avoid installing the product in the kitchen, bathroom or any other places with high humidity so as not to shorten the service life of the electronic components.
- The product can normally operate only under 5000m in altitude. In installations at altitudes above 3000m, some abnormalities may be experienced.

1.3 Installing and Removing Table Stands (optional)

To install table stands:

- 1 Ensure your display is powered off.
- 2 Spread a protective sheet on a flat surface.
- 3 Grab the carrying handles and place the display face-down on the protective sheet.
- 4 After inserting the stand in the guide block, tighten the screws on both sides of the display.

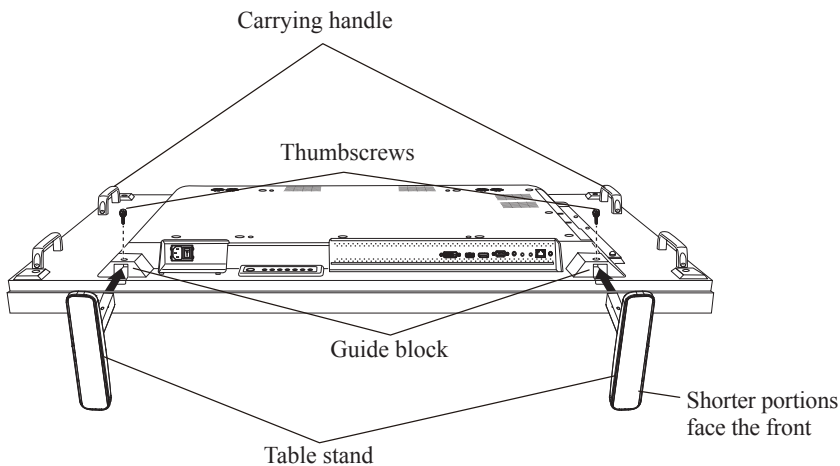

To remove table stands:

- 1 Power off the display.
- 2 Spread a protective sheet on a flat surface.
- 3 Grab the carrying handles and place the display face-down on the protective sheet.
- 4 Remove screws using a screwdriver and place them in a safe place for reuse.



Warning:

- Do not press too hard on the LCD panel or edge of the frame, as this may cause the device to malfunction.
- During unpacking, make sure to hold the carrying handles to remove the device from its packaging.

Note:

- The shorter side of the stand should face the front of the display.

PRODUCT DESCRIPTION

1.4 Wall Mounting Installation

To mount this display to a wall, you will have to obtain a standard wall-mounting kit (commercially available). We recommend using a mounting interface that complies with TUV-GS and/or UL1678 standard in North America.

To wall-mount the LCD display, screw the mounting bracket to the VESA holes at the rear of the LCD display.

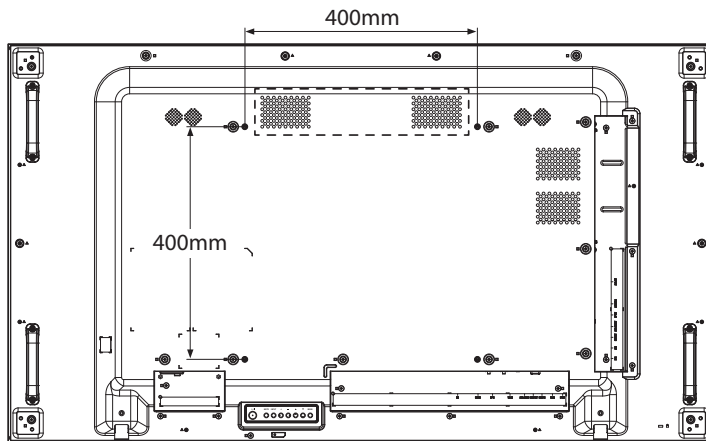

1.4.1 VESA Grid

Model Name	VESA Grid
PN-55D3	400(H) x 400(V) mm

Caution:

To prevent the display from falling:

- For wall or ceiling installation, we recommend installing the display with metal brackets which are commercially available. For detailed installation instructions, refer to the guide received with the respective bracket.
- To lessen the probability of injury and damage resulting from fall of the display in case of earthquake or other natural disaster, be sure to consult the bracket manufacturer for installation location.

Note:

- Avoid the wall-mounting kit to block the ventilation holes on the back of the display.
- Secure the LCD display on a solid wall strong enough to bear its weight.
- Lay a protective sheet on a table, which was wrapped around the display when it was packaged, beneath the screen surface so as not to scratch the screen face.
- Ensure you have all accessories for mounting this display (wall mount, ceiling mount, table stand, etc).
- Follow the instructions that come with the base mounting kit. Failure to follow correct mounting procedures could result in damage to the equipment or injury to the user or installer. Product warranty does not cover damage caused by improper installation.
- For the wall-mounting kit, use M6 mounting screws (having a length 12 mm longer than the thickness of the mounting bracket) and tighten them securely.
- Unit without base weight is 26.6 kg. The equipment and its associated mounting means still remain secure during the test. For use only with UL Listed Wall Mount Bracket with minimum weight/load is 32.3 kg.

PRODUCT DESCRIPTION

1.5 Mounting in Portrait Position

This display can be installed in portrait position.

- 1 Remove the table stand, if attached.
- 2 Rotate 90 degrees counter-clockwise.

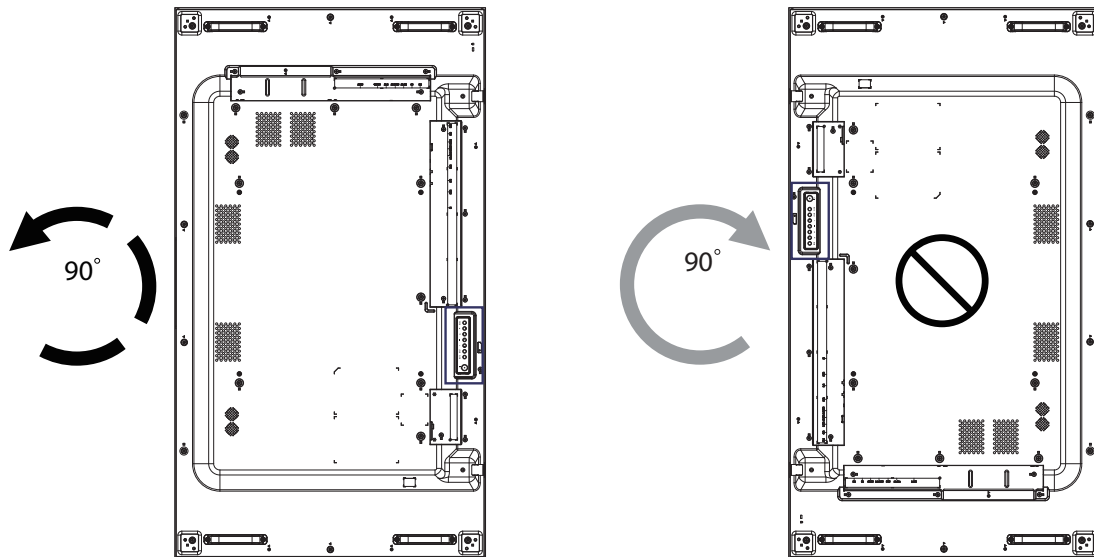

PRODUCT DESCRIPTION

1.6 LCD Display Overview

1.6.1 Control Panel

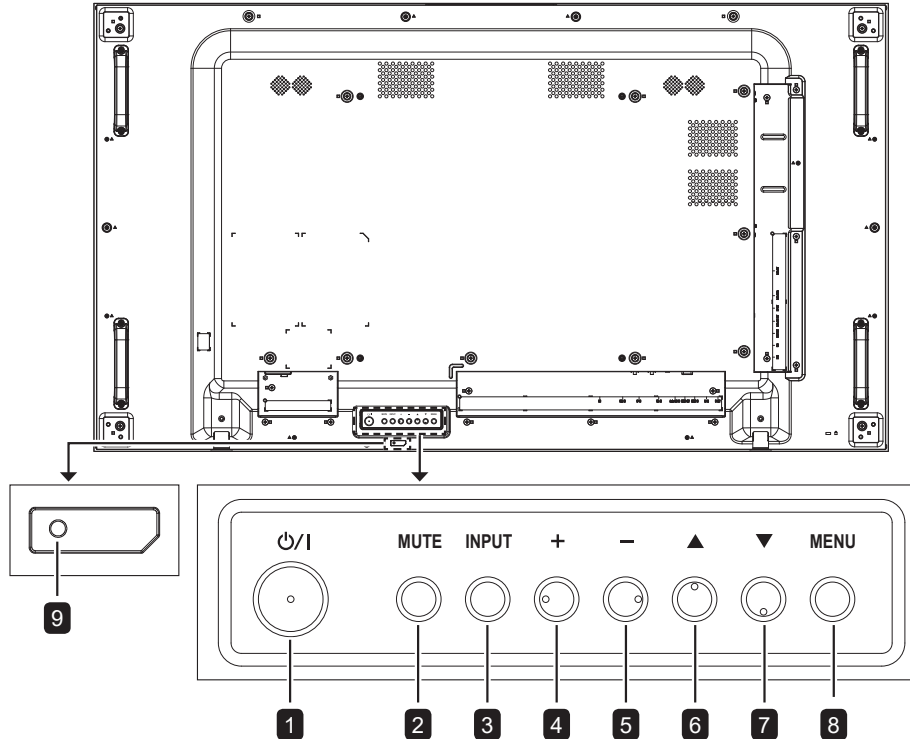

1 [Power] Power button

Use this button to turn the display on or to put the display into standby mode.

2 [MUTE] button

Switch the audio mute ON/OFF.

3 [INPUT] button

Choose the input source.

4 [+] button

Increase the adjustment while OSD menu is on, or increase the audio output level while OSD menu is off.

5 [-] button

Decrease the adjustment while OSD menu is on, or decrease the audio output level while OSD menu is off.

6 [▲] button

Move the highlight bar up to adjust the selected item while OSD menu is on.

7 [▼] Hot Key: Audio Source select

- Press to select audio source between Analog, DisplayPort, and Digital while OSD menu is on.
- When OSD menu is ON, move the highlight bar down to adjust the selected item while OSD menu is on.

8 [MENU] button

Return to previous menu while OSD menu is on, or to activate the OSD menu when OSD menu is off.

9 Remote control sensor and power status indicator

- Receives command signals from the remote control.
- Indicates the operating status of the display without OPS:
 - Lights green when the display is turned on
 - Lights red when the display is in standby mode
 - Lights amber when the display is in Power Saving Mode (Wake On Signal/Fast Wake On Signal)

PRODUCT DESCRIPTION

1.6.2 Input/Output Terminals

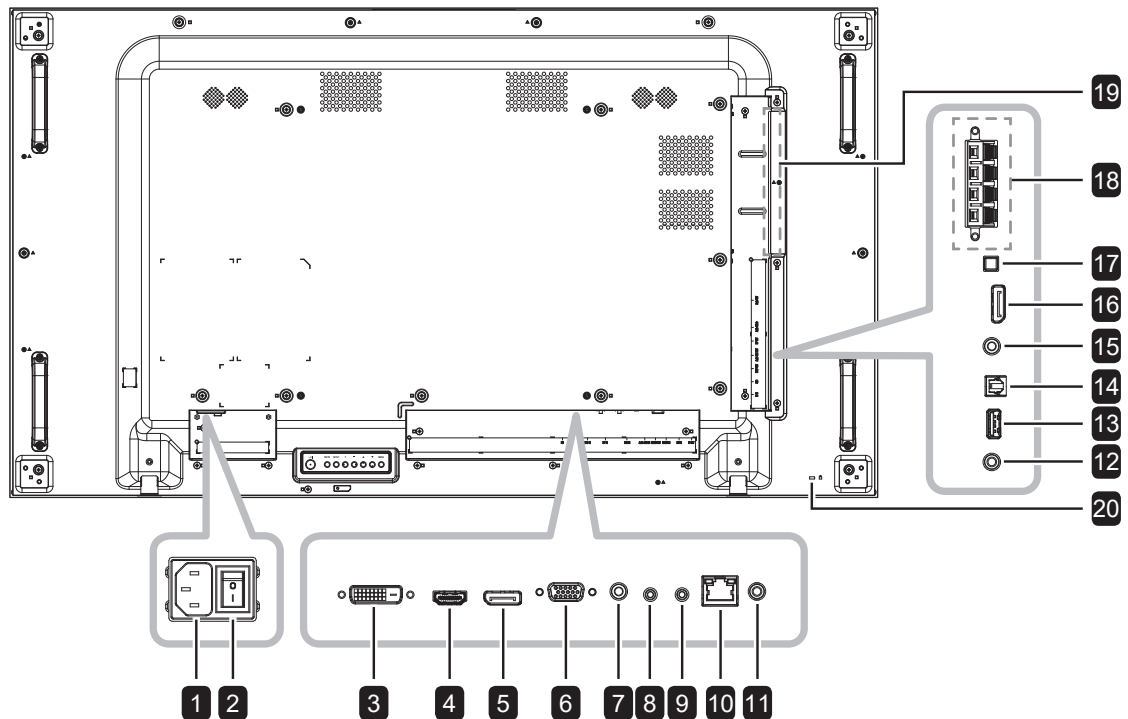

1 AC IN/OUT

AC power input/output.

2 MAIN POWER SWITCH

Switch the main power on/off.

3 DVI-D IN

Connect DVI signals input.

4 HDMI IN

Connect HDMI signals input.

5 DisplayPort IN

Connect DisplayPort signals input.

6 VGA IN

Connect VGA signals input.

7 AUDIO IN

Audio input for VGA source
(3.5mm Stereo Audio Jack).

8 RS232 OUT

Connect RS232 output to additional displays.

9 RS232 IN

Connect RS232 input from external equipment.

10 RJ-45

LAN control function for remote control from
a network.

11 IR OUT

IR signal output for the loop-through function.

12 IR IN

IR signal input.

Note:

- This display's remote control sensor will stop working if the jack [IR IN] is connected.

13 USB (FW)

Connect USB storage for FW update.

14 S/PDIF OUT

Connect digital audio signals output.

15 AUDIO OUT

Connect audio signals output
(3.5 mm Stereo Audio Jack).

16 DisplayPort OUT

Connect DisplayPort signals output.

PRODUCT DESCRIPTION

17 **SPEAKER SWITCH**

Select the internal or external speaker.

18 **EXT. SPEAKER TERMINAL**

Audio output to external speakers.

19 **OPS Slot**

Connect the OPS module.

20 **SECURITY LOCK**

Connect the OPS module.

PRODUCT DESCRIPTION

1.7 Remote Control

1.7.1 General Functions

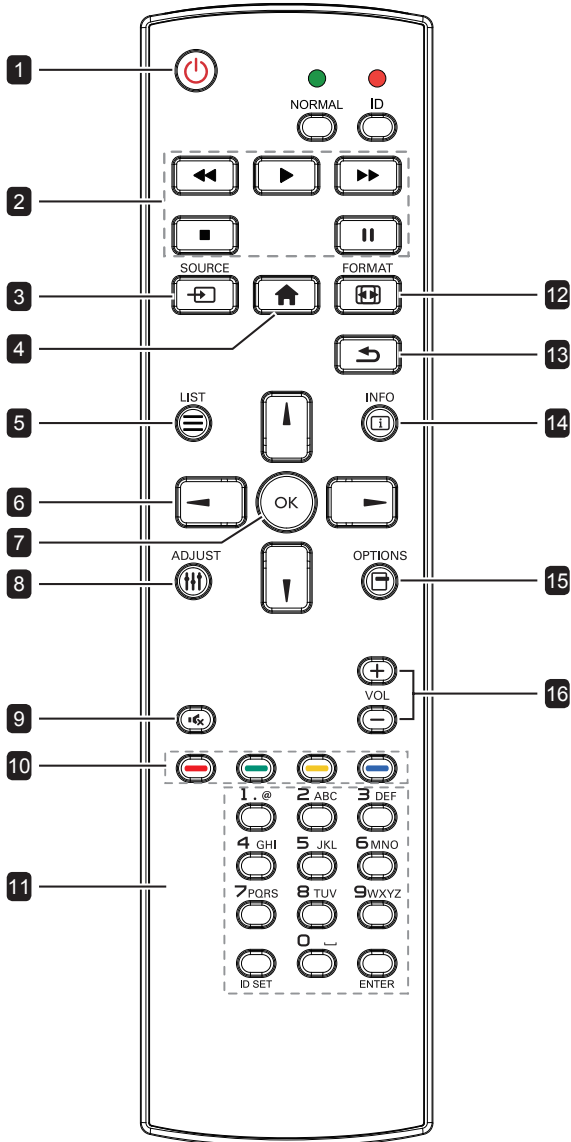

- 1 [POWER] POWER button**
Turn the display on or to put the display into standby mode.
- 2 [PLAY] buttons**
No function.
- 3 [SOURCE] SOURCE button**
Choose input source. Press [▲] or [▼] button to choose from DisplayPort, DVI-D, HDMI, OPS, or VGA. Press the [OK] button to confirm and exit.
- 4 [HOME] HOME button**
Access the OSD menu.
- 5 [LIST] LIST button**
No function.
- 6 [NAVIGATION] NAVIGATION buttons**
Navigate through menus and choose items.
- 7 [OK] button**
Confirm an entry or selection.
- 8 [ADJUST] ADJUST button**
Go to Auto Adjust OSD for VGA only.
- 9 [MUTE] MUTE button**
Turn the mute function on/off.
- 10 [COLOUR] COLOUR button**
Blue: No function.
- 11 [Number / ID SET / ENTER] button**
Press to set the display ID. Refer to User Manual ID Remote Control for more detail.
- 12 [FORMAT] FORMAT button**
Change aspect ratio.
- 13 [BACK] BACK button**
Return to the previous menu page or exit from the previous function.
- 14 [INFO] INFO button**
View info about the display.
- 15 [OPTIONS] OPTIONS button**
No function.
- 16 [VOLUME] VOLUME button**
Adjust volume on internal or external audio sources.

PRODUCT DESCRIPTION

1.7.2 ID Remote Control

You can set the remote control ID when you want to use this remote control on one of several different displays.

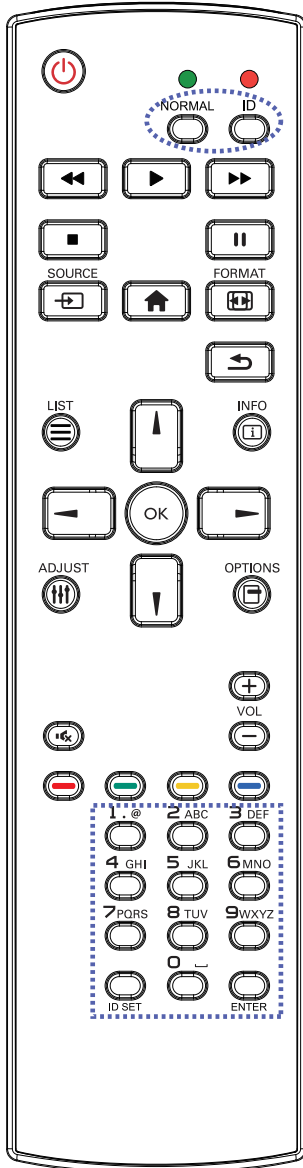

To set the remote control ID:

- 1 Press the [ID] button for more than 1 second. The red LED blinks twice.
- 2 Press the [ID SET] button for more than 1 second to enter the ID mode. The red LED lights up.
Press the [ID SET] button again will exit the ID mode. The red LED lights off.
- 3 Press the digit numbers [0] ~ [9] to select the display you want to control.
For example:
 - Display ID #1: press [0], [0], [1]
 - Display ID #11: press [0], [1], [1]The numbers available are from [001] ~ [255].
 - Not pressing any button within 10 seconds will exit the ID mode.
 - If an error pressing of buttons other than the digits occurred, wait 1 second after the red LED lights off and then lights up again, then press the correct digits again.
- 4 Press the [ENTER] button to confirm.
The red LED blinks twice and then lights off.

Note:

- Press the [NORMAL] button for more than 1 second. The green LED blinks twice, indicating the remote control returns to normal operation.
- It is necessary to set up the Monitor ID for each display before selecting its ID number. Refer to page 48.

PRODUCT DESCRIPTION

1.7.3 Inserting the Batteries in the Remote Control

The remote control is powered by two 1.5V AAA batteries.

To install or replace batteries:

- 1 Press and then slide the cover to open it.
- 2 Align the batteries according to the (+) and (-) indications inside the battery compartment.
- 3 Replace the cover.

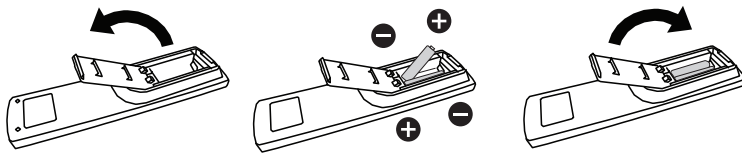

1.7.4 Handling the Remote Control

- Do not subject to strong shock.
- Do not allow water or other liquid to splash the remote control. If the remote control gets wet, wipe it dry immediately.
- Avoid exposure to heat and steam.
- Other than to install the batteries, do not open the remote control.

1.7.5 Operating Range of the Remote Control

Point the top of the remote control toward the display's remote control sensor(back side) when pressing a button.

Use the remote control within the range which is shown in the following table.

Operation Angle	RC operational distance
$\theta = 0^\circ$ (for H & V)	6m
$\theta = 20^\circ$ (for H & V)	4m
$\theta = 45^\circ$ (for H only)	Not supported

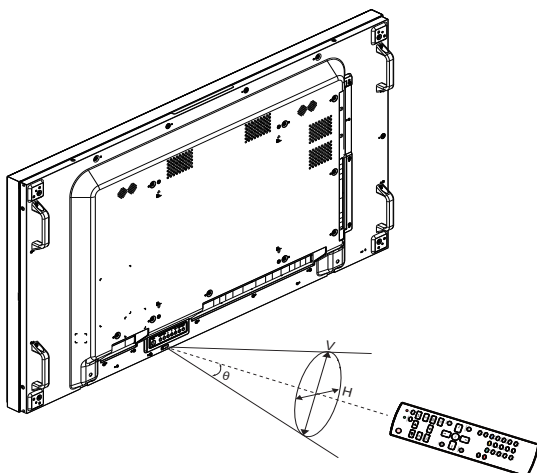

Caution:

The incorrect use of batteries can result in leaks or bursting. Be sure to follow these instructions:

- Place “AAA” batteries matching the (+) and (-) signs on each battery to the (+) and (-) signs of the battery compartment.
- Do not mix battery types.
- Do not combine new batteries with used ones. It causes shorter life or leakage of batteries.
- Remove the dead batteries immediately to prevent them from liquid leaking in the battery compartment. Don't touch exposed battery acid, as it can damage your skin.

Note:

- If you do not intend to use the remote control for a long period, remove the batteries.
- The remote control may not function properly when the remote control sensor on this display is under direct sunlight or strong illumination, or when there is an obstacle in the path of signal transmission.

CHAPTER 2: MAKING CONNECTIONS

2.1 Connecting the Power

- 1 Connect one end of the power cord to the AC IN connector at the rear of the LCD display.
- 2 Connect the other end of the power cord to a power outlet or a power supply.
- 3 Set the **Main Power** switch to ON.

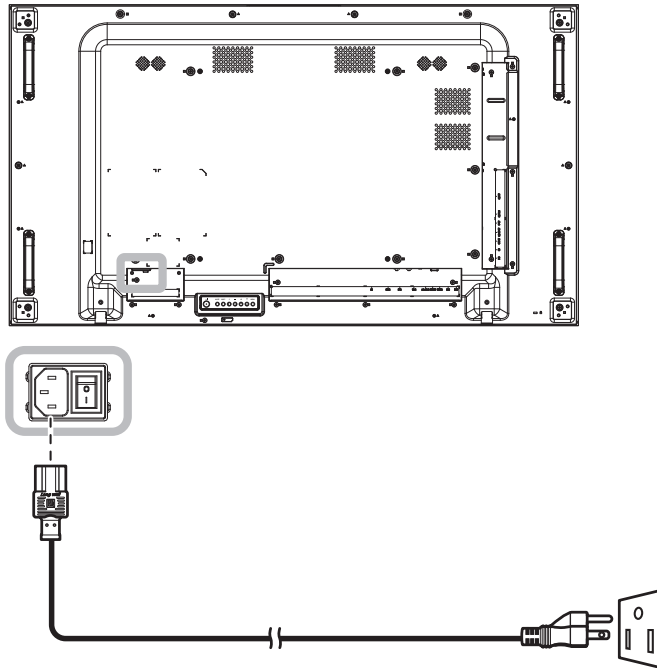

Caution:

- Make sure that the LCD display is not connected to the power outlet before making any connections. Connecting cables while the power is ON may cause electric shock or personal injury.
- When unplugging the power cord, hold the power cord by the plug head. Never pull by the cord.

MAKING CONNECTIONS

2.2 Connecting a Computer

2.2.1 Using VGA Input

Connect one end of a D-sub cable to the VGA IN connector of the LCD display and the other end of a D-sub cable to the VGA OUT (D-Sub) connector of the computer.

For audio input, connect one end of an audio cable to the AUDIO IN connector of the LCD display and the other end of an audio cable to the AUDIO OUT connector of the computer.

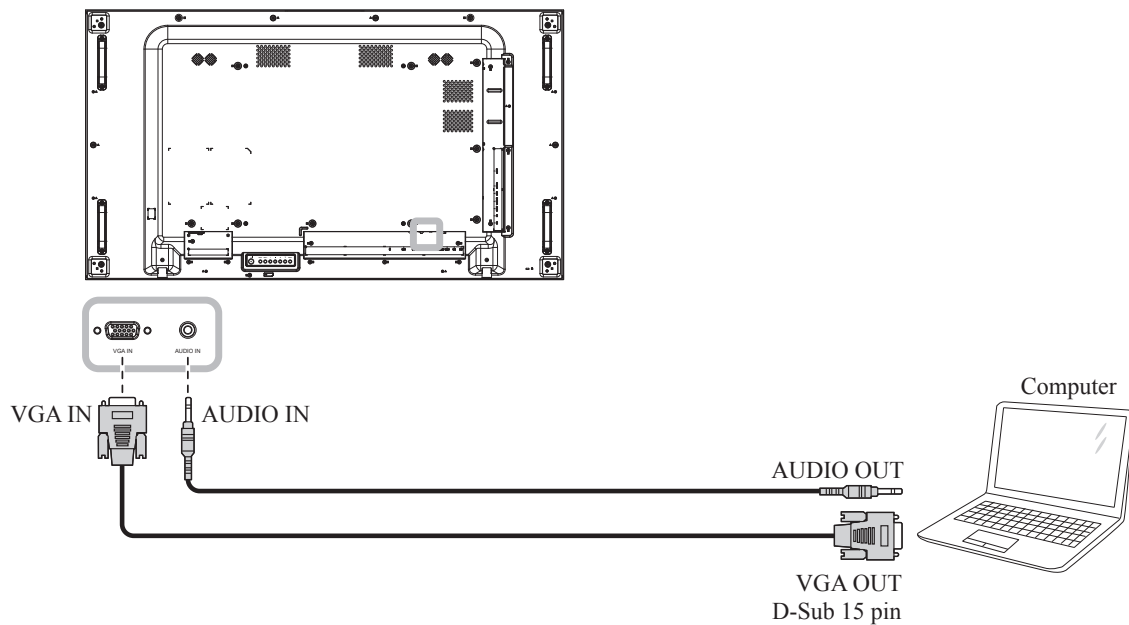

2.2.2 Using DisplayPort Input

Connect one end of a DisplayPort cable to the DisplayPort IN connector of the LCD display and the other end of a DisplayPort cable to the DisplayPort OUT connector of the computer.

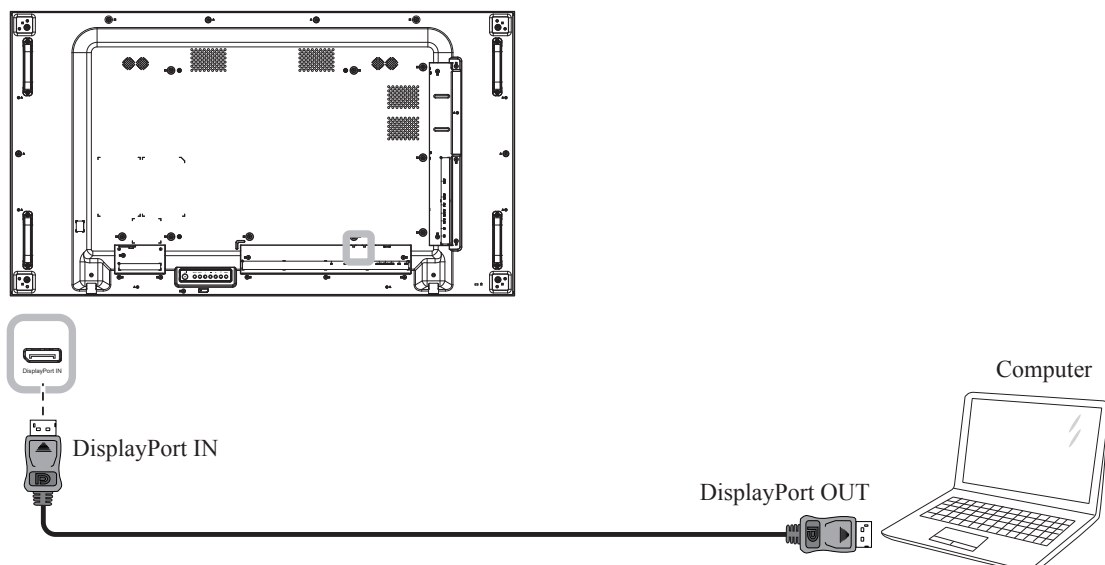

MAKING CONNECTIONS

2.2.3 Using DVI Input

Connect one end of a DVI cable to the DVI-D IN connector of the LCD display and the other end of a DVI cable to the DVI OUT connector of the computer.

For audio input, connect one end of an audio cable to the AUDIO IN connector of the LCD display and the other end of an audio cable to the AUDIO OUT connector of the computer.

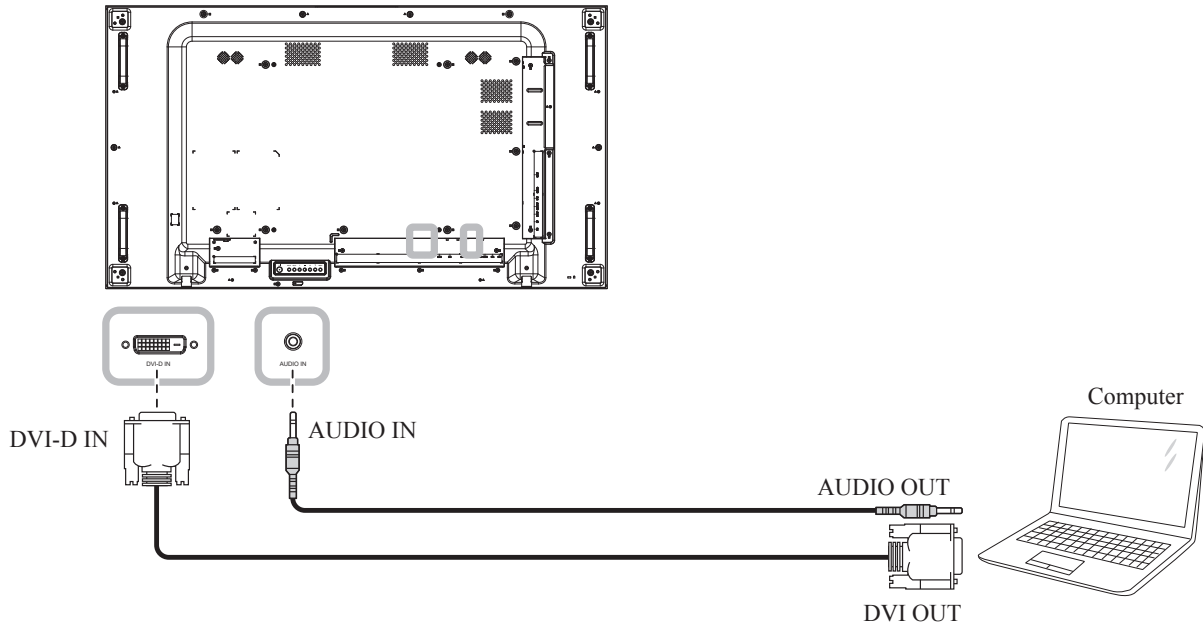

2.2.4 Using HDMI Input

Connect one end of an HDMI cable to the HDMI IN connector of the LCD display and the other end of an HDMI cable to the HDMI OUT connector of the computer.

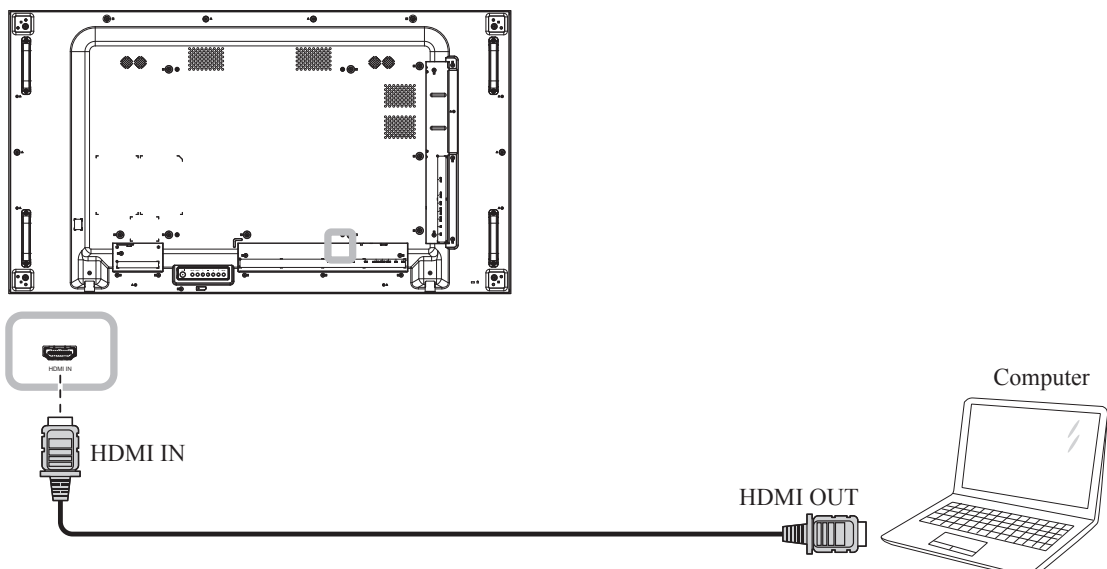

MAKING CONNECTIONS

2.3 Connecting External Equipment (AV Devices)

2.3.1 Using HDMI Video Input

Connect one end of an HDMI cable to the HDMI IN connector of the LCD display and the other end of an HDMI cable to the HDMI OUT connector of the video player.

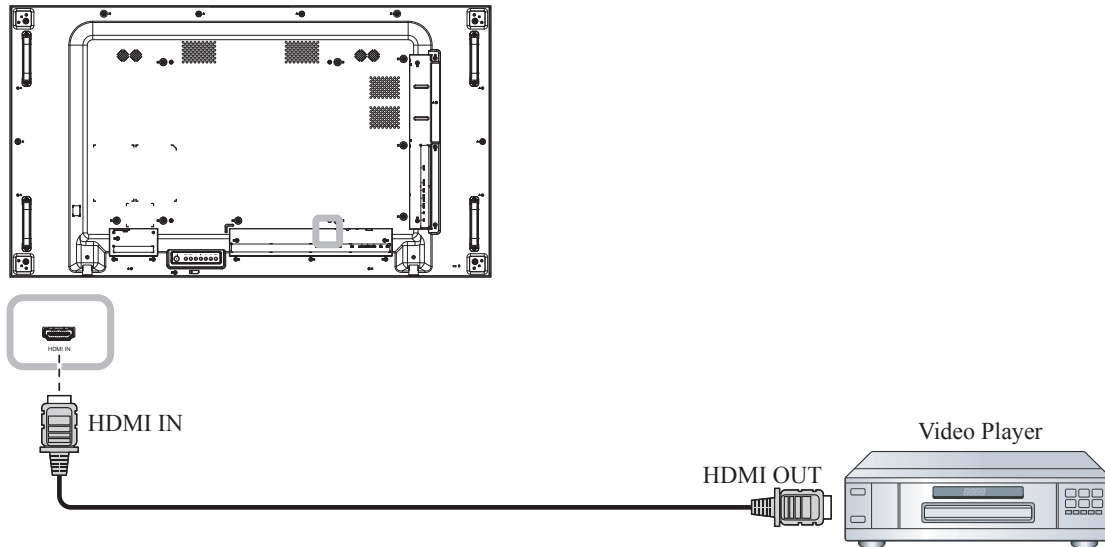

2.4 Connecting Audio Equipment

2.4.1 Connecting External Speakers

Press the Speaker Switch and connect the speakers cables to the EXT. Speaker Terminal of the LCD display.

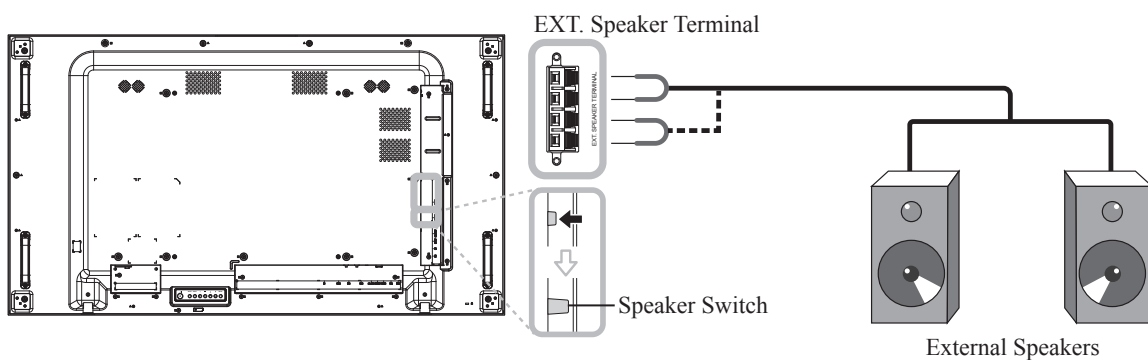

MAKING CONNECTIONS

2.4.2 Connecting an External Audio Device

- Connect one end of an audio cable to the AUDIO OUT connector of the LCD display and the other end of an audio cable to the AUDIO IN connector of the audio device.
- Connect one end of a S/PDIF cable to the S/PDIF OUT connector of the LCD display and the other end of an S/PDIF cable to the S/PDIF IN connector of the audio device.

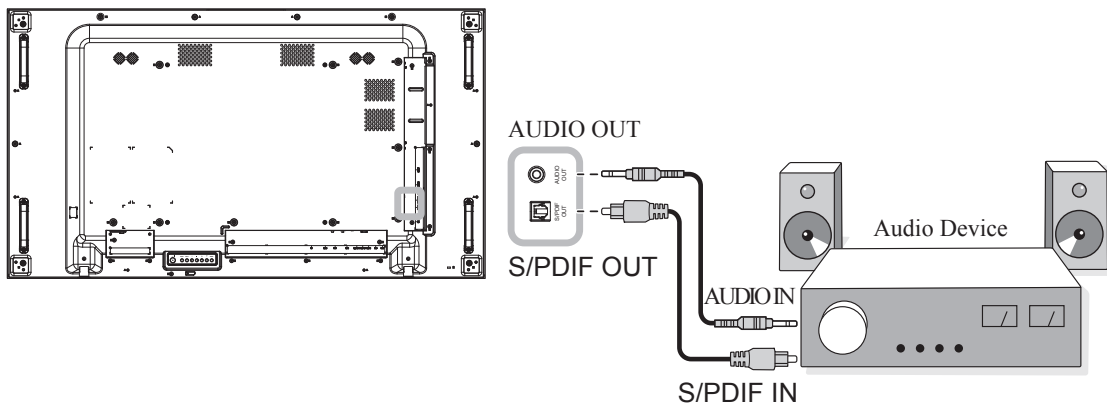

2.5 Connecting USB Devices

Connect the USB storage to the USB port of the LCD display to upgrade firmware.

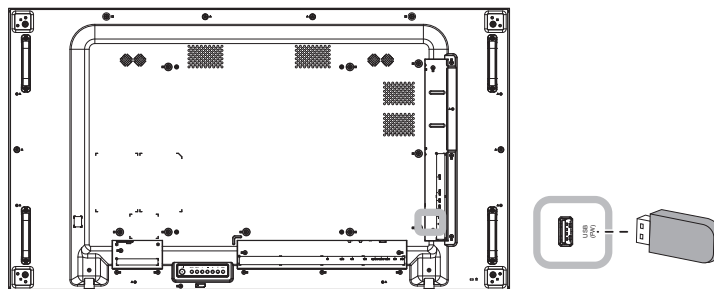

MAKING CONNECTIONS

2.6 Connecting Multiple Displays in a Daisy-chain Configuration

You can interconnect multiple displays to create a daisy-chain configuration for applications such as a video wall.

Caution:

To avoid unnecessary strain on the bezel, it is highly recommended to keep a minimum space of 0.5mm in which a business card is able to slip between all displays on all sides.

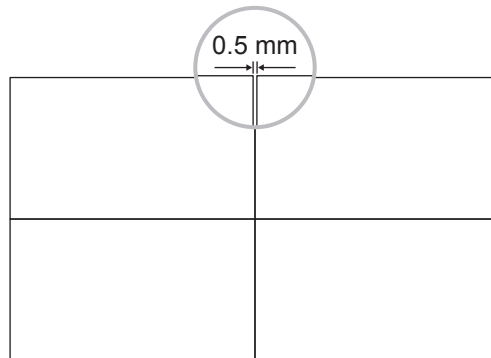

2.6.1 Display Control Connection

Connect the RS232 OUT connector of DISPLAY 1 to the RS232 IN connector of DISPLAY 2.

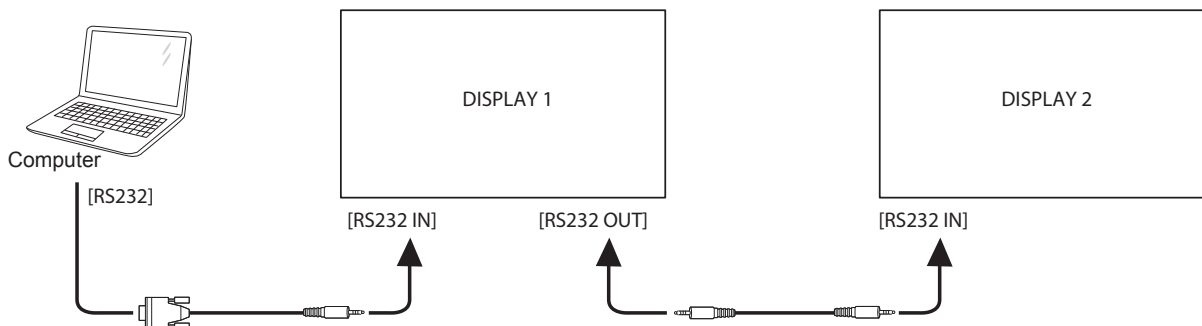

2.6.2 Digital Video Connection

Connect the DisplayPort OUT connector of DISPLAY 1 to the DisplayPort IN connector of DISPLAY 2.

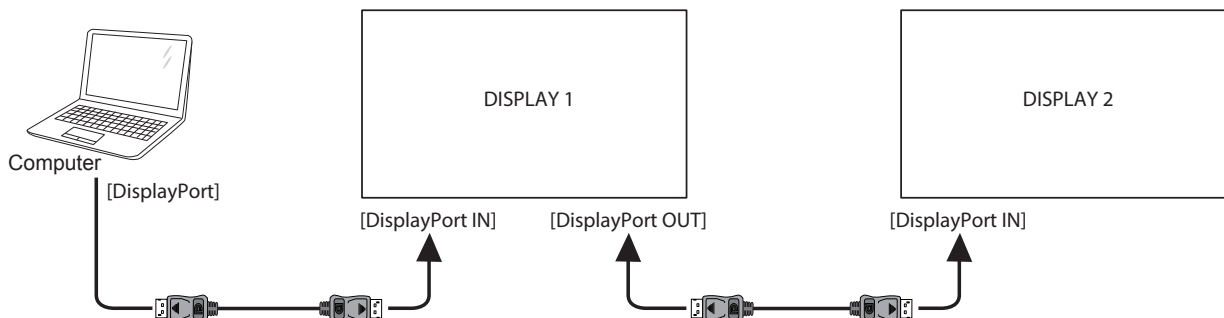

MAKING CONNECTIONS

Note:

- Before selecting the DisplayPort 1.2 option, make sure the **UniWall > Enable** setting is set to **Off**.

2.7 IR Connection

Connect the IR sensor cable to the IR IN connector of the LCD display.

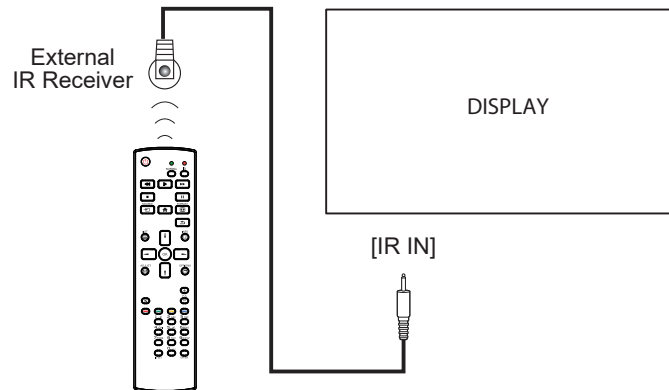

Note:

- This display's remote control sensor will stop working if the [IR IN] is connected.

2.8 IR Pass-Through Connection

Connect one end of an IR extender cable to the IR OUT connector of the LCD display and the other end of an IR extender cable to the IR IN connector of the AV devices.

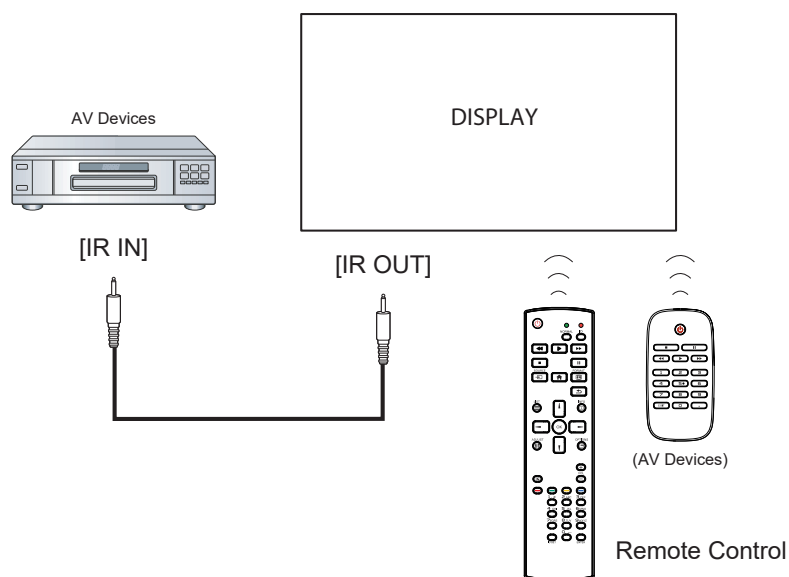

MAKING CONNECTIONS

2.9 Connecting to Wired Network

If you connect this LCD display to a network, you can play photos, music, and videos from your computer.

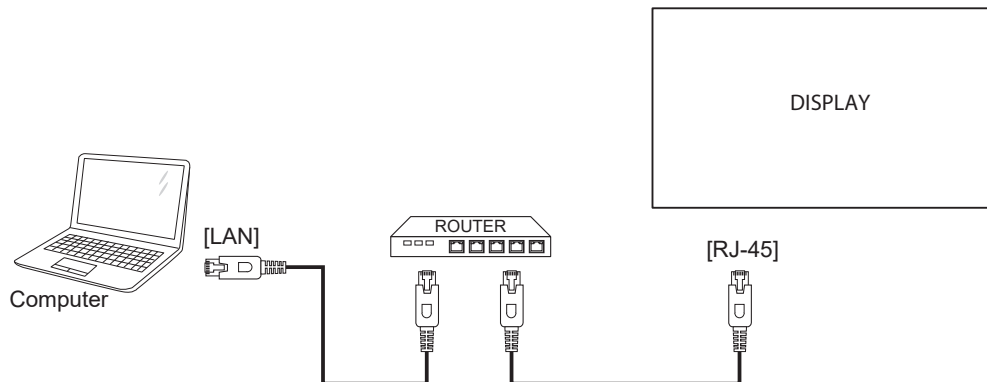

To setup the network:

- 1 Switch on the router and switch on its DHCP setting.
- 2 Connect the router to the LCD display with an Ethernet cable.
- 3 Press the **Home** button to display the OSD menu.
- 4 Press the **Up** or **Down** button to select **Configuration 1 > Network**. Press the **OK** button to enter its submenu.
- 5 Press the **Up** or **Down** button to select **DHCP**. Press the **OK** button to confirm.

Note:

- Connecting with a shielded CAT-5 Ethernet cable to comply with the EMC directive.
- To manually configure the network parameters, set the **Configuration 1 > Network** and set DHCP to **Off**. Then enter the network parameters manually and select **SET** to save the settings.

CHAPTER 3: USING THE LCD DISPLAY

3.1 Turning on the Power

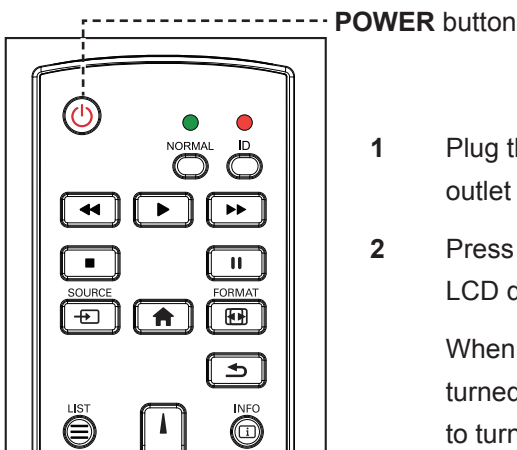

- 1 Plug the power cord to a power outlet or power supply.
- 2 Press the  button to turn the LCD display on.



When the LCD display is turned on, press the  button to turn off the LCD display.

Note:

- The LCD display still consumes power as long as the power cord is connected to the power outlet. Disconnect the power cord to completely cut off power.

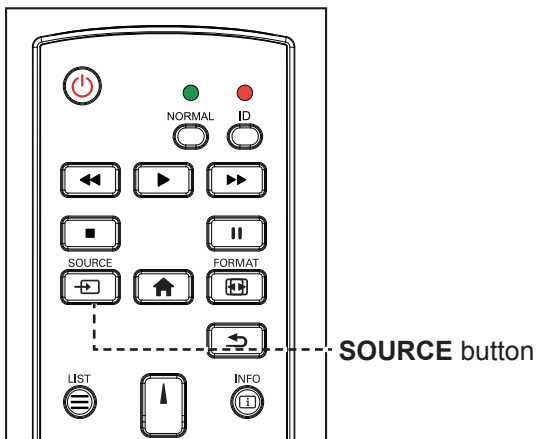
3.2 Selecting the Input Source Signal



- 1 Press the  button.
- 2 Press the  or  button to choose a device, then press the OK button.

Note:

- After pressing the  button, a menu with available input sources will be displayed on the screen.

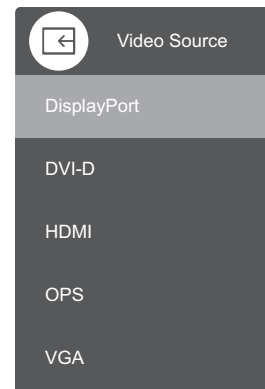

- If the selected input source signal is not connected to the LCD display or is turned off, the no signal message is displayed on the screen.



USING THE LCD DISPLAY

3.3 Adjusting the Volume

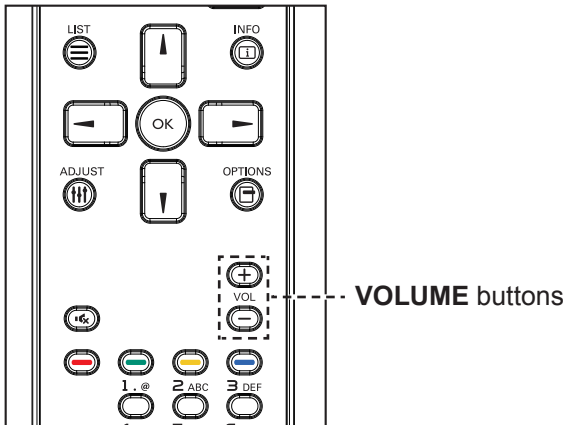

Press the **-** or **+** button to adjust the volume.

Note:

- After pressing the **-** or **+** button, the volume adjustment bar will be displayed on the screen automatically. Press the **-** or **+** to adjust volume.



- Press the **MUTE** button to mute audio.

3.4 Changing the Picture Format

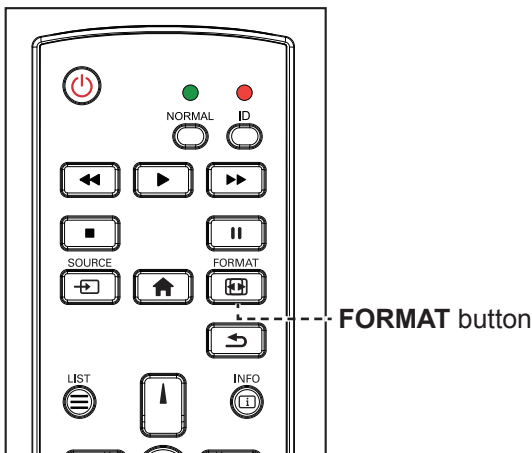

Press the **FORMAT** button repeatedly to toggle through the aspect ratios.

Note:

The available picture formats include:

- **Full:** This mode restores the correct proportions of pictures transmitted in 16:9 using the full screen display.
- **4:3:** The picture is reproduced in 4:3 format and a black band is displayed on either side of the picture.
- **Real:** This mode displays the image pixel-by-pixel on screen without scaling the original image size.
- **16:9:** The picture is reproduced in 16:9 format and a black band at the top and bottom.
- **Letterbox:** The picture is reproduced in 21:9 format and a black band at the top and bottom.

USING THE LCD DISPLAY

3.5 Using the Auto Adjustment Function

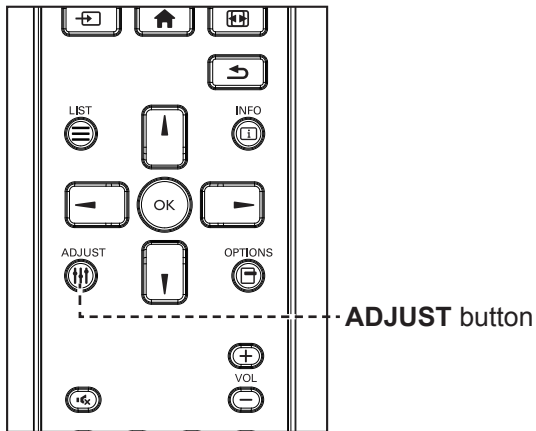

Auto adjustment function automatically tunes the VGA source to its optimal setting, including horizontal position, vertical position, clock, and phase. Press the  button. Then press **OK** at the prompt to start the auto adjustment.

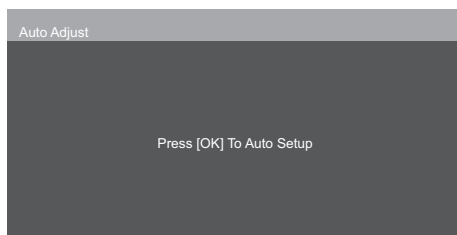

CHAPTER 4: ON SCREEN DISPLAY MENU

4.1 Using the OSD Menu

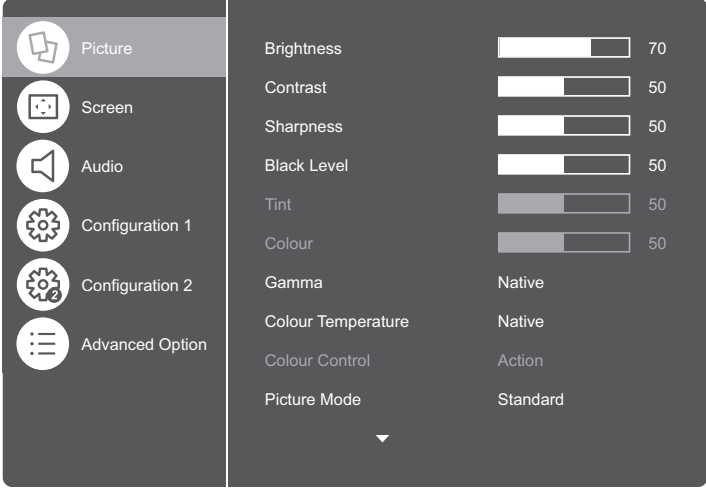
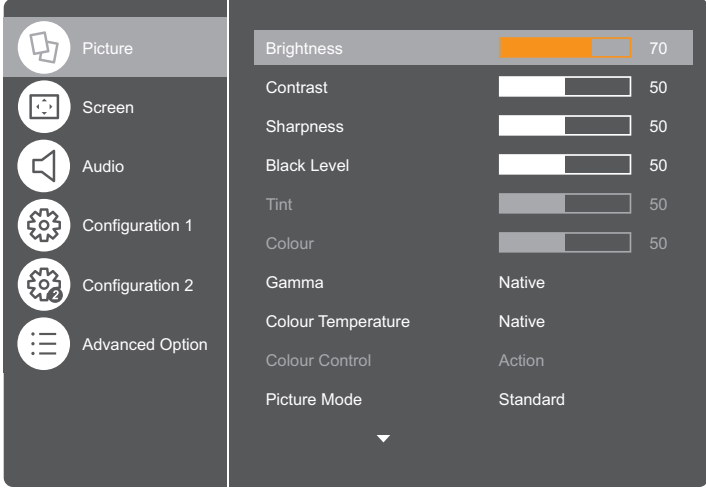
#	Menu Navigation	Operation	
		Control Panel	Remote Control
1	<p>Display the main menu screen.</p> 	Press the MENU button.	Press the ⬆ button.
2	<p>Enter the submenu.</p>  <p>The highlighted item (gray box) indicates the active submenu.</p>	<p>1 Press the ▲ or ▼ button to select the menu item.</p> <p>2 Press the INPUT button to enter the submenu.</p>	<p>1 Press the ⬇ or ⬇ button to select the menu item.</p> <p>2 Press the OK or ▶ button to enter the submenu.</p>

ON SCREEN DISPLAY MENU

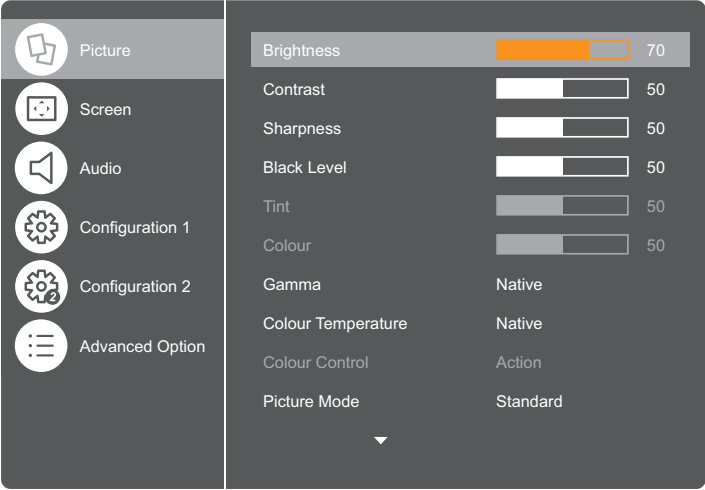
#	Menu Navigation	Operation	
		Control Panel	Remote Control
3	<p>Adjust the settings. The highlighted item indicates the active submenu. For example:</p> 	<p>1 Press the + or - button to adjust the value or press INPUT and then press the ▲ or ▼ button to select the setting.</p> <p>2 Press the INPUT button to confirm (if necessary).</p>	<p>1 Press the ← or → button to adjust the value or press the ↓ or ↑ button to select the setting.</p> <p>2 Press the OK button to confirm (if necessary).</p>
4	Exit the submenu.	Press the - button to return to the previous menu.	Press the ↶ or ← button to return to the previous menu.
5	Close the OSD window.	Press the MENU button again.	Press the ⬆ button again.

When settings are modified, all changes are saved when the user does the following:

- Proceeds to the another menu.
- Exits the OSD menu.
- Waits for the OSD menu to disappear.

Note:

- Availability of some menu items depend on the input source signal. If the menu is not available, it is disabled and grayed out.

ON SCREEN DISPLAY MENU

4.2 OSD Menu Tree

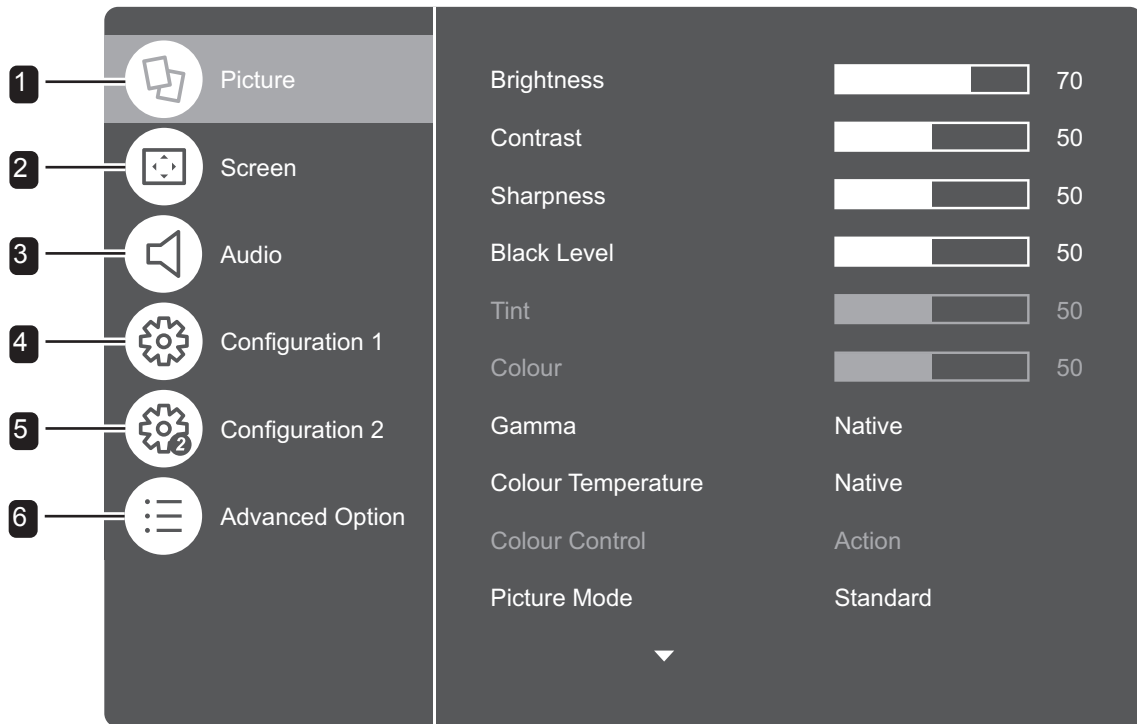

Main Menu	Submenu	Remarks
1. Picture	<ul style="list-style-type: none"> • Brightness • Contrast • Sharpness • Black Level • Tint • Colour • Gamma • Colour Temperature • Colour Control • Picture Mode • Colour Space • Local Dimming • Overscan • Picture Reset 	See page 37.

ON SCREEN DISPLAY MENU

Main Menu	Submenu	Remarks
2. Screen	<ul style="list-style-type: none"> • H Position • V Position • Clock • Phase • Aspect Ratio • Auto Adjust • Screen Reset 	See page 40.
3. Audio	<ul style="list-style-type: none"> • Balance • Treble • Bass • Audio Out (Line Out) • Audio Source • Audio Reset 	See page 42.
4. Configuration1	<ul style="list-style-type: none"> • Switch On State • Panel Saving • Blank Screen Colour • Boot On Source • Network • Power LED Light • Configuration1 Reset • Factory Reset 	See page 44.
5. Configuration2	<ul style="list-style-type: none"> • OSD Turn Off • OSD H Position • OSD V Position • OSD Transparency • Information OSD • Logo • Monitor ID • Heat Status • Monitor Information • DP Version • HDMI EDID • OSD Rotation • Language • Configuration2 Reset 	See page 48.

ON SCREEN DISPLAY MENU

Main Menu	Submenu	Remarks
6 Advanced option	<ul style="list-style-type: none">• Input Resolution• IR Control• Keypad Control• UniWall• Off Timer• Date And Time• Schedule• Auto Search• Standby Mode• Power Saving Mode• Firmware Update• Advanced Option Reset	See page 51.

CHAPTER 5: ADJUSTING THE LCD DISPLAY

5.1 Picture Settings

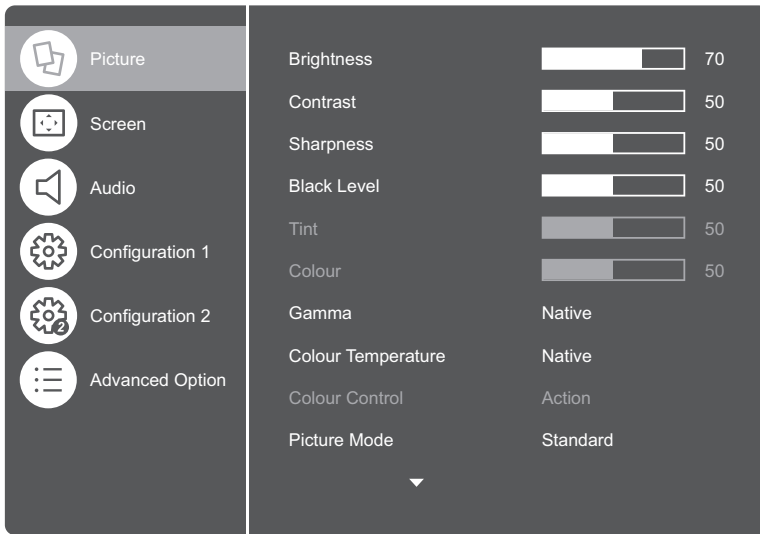

- 1 Press the **MENU** button on the control panel or the **HOME** button on the remote control to call out the OSD window.
- 2 Select **Picture**, then press the **INPUT** button on the control panel or the **OK** button on the remote control.
- 3 Press the **▲/▼** button on the control panel or the **▲/▼** button on the remote control to select an option.

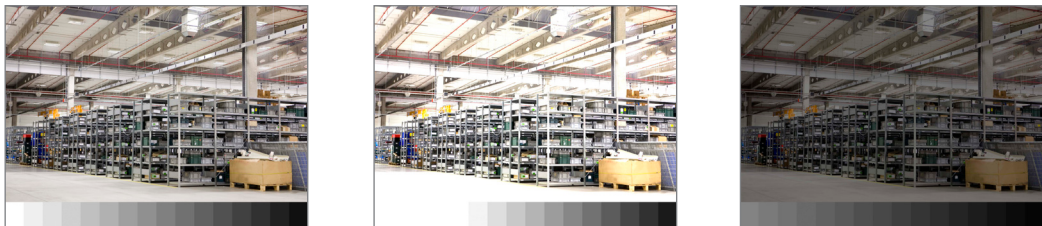
Item	Function	Operation	Range
Brightness	Adjusts the luminance of the screen image.	Press the +/- button on the control panel or the ←/→ button on the remote control to adjust the value.	1 to 100
	<p style="text-align: center;"><i>Original Setting</i> <i>High Setting</i> <i>Low Setting</i></p> 		
Contrast	Adjusts the difference between the black level and the white level.	Press the +/- button on the control panel or the ←/→ button on the remote control to adjust the value.	0 to 100
	<p style="text-align: center;"><i>Original Setting</i> <i>High Setting</i> <i>Low Setting</i></p> 		
Sharpness	Adjusts the clarity and focus of the screen image.	Press the +/- button on the control panel or the ←/→ button on the remote control to adjust the value.	0 to 100
Black Level	Adjusts the black level of the screen image. Low brightness setting makes black colour darker.		0 to 100
Tint	Adjusts the colour tint.		0 to 100
Colour	Adjusts the colour saturation of the picture.		0 to 100

ADJUSTING THE LCD DISPLAY

Item	Function	Operation	Range
Gamma	Adjusts the non-linear setting for picture luminance and contrast.	<ol style="list-style-type: none"> 1 Press the INPUT button on the control panel or the OK button on the remote control. 2 Press the ▲/▼ button on the control panel or the M button on the remote control to select the setting. 	Native 1.80~2.60 (with the step 0.05)
Colour Temperature	<p>Changes the colour balance.</p> <ul style="list-style-type: none"> • 3200K~9300K: Sets the colour temperature from warm to cooler tones. • Native: Commonly used for normal lighting conditions. • User 1: Sets the colour temperature by adjusting the Red Gain, Green Gain, and Blue Gain settings according to the user's preference in Colour Control menu. • User 2: Adjusts the colour temperature by 100K in Colour Control menu. 	<ol style="list-style-type: none"> 1 Press the INPUT button on the control panel or the OK button on the remote control. 2 Press the ▲/▼ button on the control panel or the M button on the remote control to select the setting. 	3200K 5500K 6500K 7500K 9300K Native User 1 User 2
Colour Control	Customise colour temperature if the colour temperature is set to User 1 or User 2 in Colour Temperature menu.	Press the INPUT button on the control panel or the OK button on the remote control to enter the submenu.	Action
	<ul style="list-style-type: none"> • User 1: Adjusts the Red Gain, Green Gain, and Blue Gain. 	<ol style="list-style-type: none"> 1 Press the ▲/▼ button on the control panel or the M button on the remote control to select the colour. 2 Press the INPUT button on the control panel or the OK button on the remote control to enter the adjustment mode. 3 Press the +/- button on the control panel or the ←/→ button on the remote control to adjust the value. 	0 to 255

ADJUSTING THE LCD DISPLAY

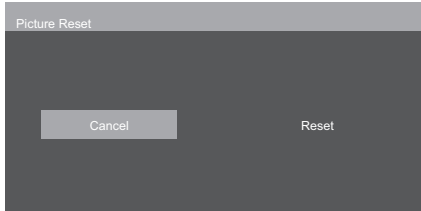
Item	Function	Operation	Range
Colour Control (continued)	<ul style="list-style-type: none"> • User 2: Adjusts the colour temperature by 100K. 	Press the ▲/▼ button on the control panel or the M button on the remote control to select the setting.	3200K to 9300K (with the step 100K)
Picture Mode	Sets the predefined picture setting.	<ol style="list-style-type: none"> 1 Press the INPUT button on the control panel or the OK button on the remote control. 2 Press the ▲/▼ button on the control panel or the M button on the remote control to select the setting. 3 Press the INPUT button on the control panel or the OK button on the remote control to confirm the setting. 	Standard Vivid Cinema sRGB
Colour Space	Sets the colour space that matches the corresponding picture mode. <ul style="list-style-type: none"> • Full: RGB Full • Limit: RGB Limited • REC601: 601_Limit_444 • REC709: 709_Limit_444 • Auto: Auto detected by the scaler. 		Full Limit REC601 REC709 Auto
Local Dimming	Enables or disables local dimming. This feature reduces power consumption, provides higher contrast, and lowers radiated heat.		Off On
Overscan	Changes the display area of the image. <ul style="list-style-type: none"> • On: Display area is about 95%. • Off: Display area is about 100%. 		Off On
Picture Reset	Resets all Picture menu settings to their factory defaults. 	<ol style="list-style-type: none"> 1 Press the INPUT button on the control panel or the OK button on the remote control. 2 Press the +/- button on the control panel or the ←/→ button on the remote control to select Cancel (cancels operation) or Reset (resets settings). 3 Press the INPUT button on the control panel or the OK button on the remote control to confirm the setting. 	Cancel Reset

ADJUSTING THE LCD DISPLAY

5.2 Screen Settings

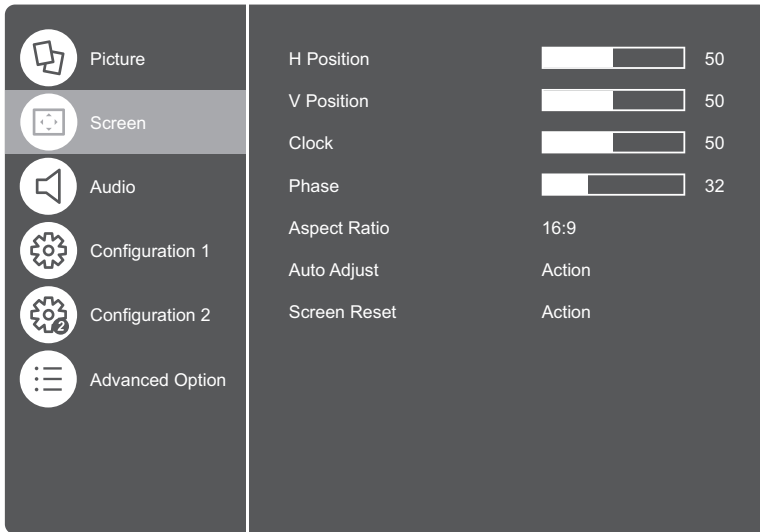

- 1 Press the **MENU** button on the control panel or the **HOME** button on the remote control to call out the OSD window.
- 2 Select **Screen**, then press the **INPUT** button on the control panel or the **OK** button on the remote control.
- 3 Press the **▲/▼** button on the control panel or the **↑/↓** button on the remote control to select an option.

Item	Function	Operation	Range
H Position (Horizontal Position)	Moves the screen image to the left or right. Note: This function is available only with VGA source.	Press the +/- button on the control panel or the ←/→ button on the remote control to adjust the value.	0 to 100
V Position (Vertical Position)	Moves the screen image up or down. Note: This function is available only with VGA source.		0 to 100
Clock	Adjusts the frequency timing to synchronise with the video signal. Note: This function is available only with VGA source.		0 to 100
Phase	Adjusts the phase timing to synchronise with the video signal. Note: This function is available only with VGA source.		0 to 100

ADJUSTING THE LCD DISPLAY

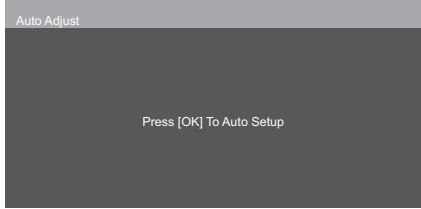
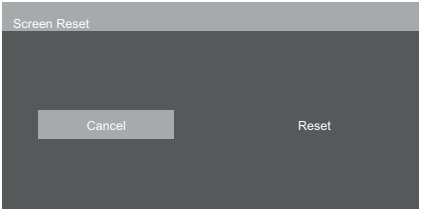
Item	Function	Operation	Range
Aspect Ratio	Adjusts the aspect ratio of the screen image.	<ol style="list-style-type: none"> 1 Press the INPUT button on the control panel or the OK button on the remote control. 2 Press the ▲▼ button on the control panel or the ↵ button on the remote control to select the setting. 3 Press the INPUT button on the control panel or the OK button on the remote control to confirm the setting. 	Fill 4:3 Native 16:9 Letterbox
Auto Adjust	Automatically tunes the LCD display to its optimal setting, including horizontal position, vertical position, clock, and phase.  Note: This function is available only with VGA source.	Press the INPUT button on the control panel or the OK button on the remote control twice.	OK
Screen Reset	Resets all Screen menu settings to their factory defaults. 	<ol style="list-style-type: none"> 1 Press the INPUT button on the control panel or the OK button on the remote control. 2 Press the +/- button on the control panel or the ←/→ button on the remote control to select Cancel (cancels operation) or Reset (resets settings). 3 Press the INPUT button on the control panel or the OK button on the remote control to confirm the setting. 	Cancel Reset

ADJUSTING THE LCD DISPLAY

5.3 Audio Settings

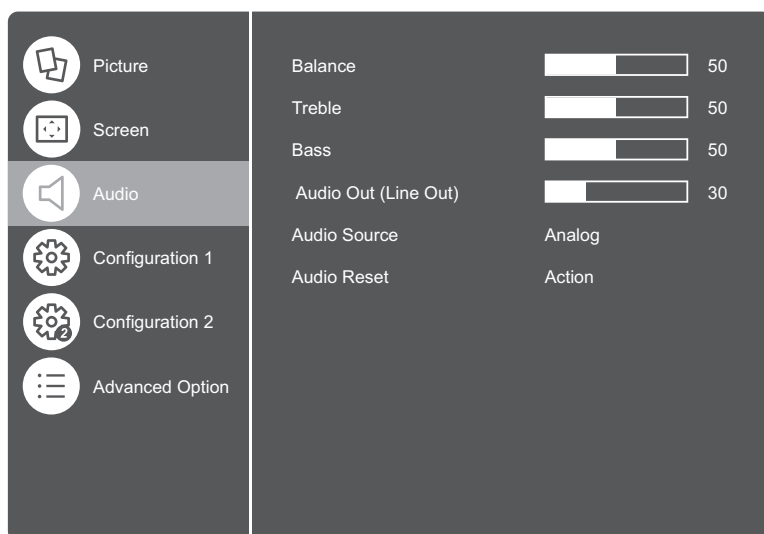

- 1 Press the **MENU** button on the control panel or the **HOME** button on the remote control to call out the OSD window.
- 2 Select **Audio**, then press the **INPUT** button on the control panel or the **OK** button on the remote control.
- 3 Press the **▲/▼** button on the control panel or the **↵** button on the remote control to select an option.







Item	Function	Operation	Range
Balance	Balances the audio output.	Press the +/- button on the control panel or the ←/→ button on the remote control to adjust the value.	0 to 100
Treble	Increases or decreases higher-pitched sounds.		0 to 100
Bass	Increases or decreases lower-pitched sounds.		0 to 100
Audio Out (Line Out)	Adjusts audio output volume.		0 to 100
Audio Source	Selects the audio source.	<ol style="list-style-type: none"> 1 Press the INPUT button on the control panel or the OK button on the remote control. 2 Press the ▲/▼ button on the control panel or the ↵ button on the remote control to select the setting. 3 Press the INPUT button on the control panel or the OK button on the remote control to confirm the setting. 	Analog DisplayPort Digital



ADJUSTING THE LCD DISPLAY



Item	Function	Operation	Range
Audio Reset	<p>Resets all Audio menu settings to their factory defaults.</p>  <p>The screenshot shows a dark grey menu titled 'Audio Reset' with two options: 'Cancel' and 'Reset'.</p>	<ol style="list-style-type: none"> 1 Press the INPUT button on the control panel or the OK button on the remote control. 2 Press the +/- button on the control panel or the ←/→ button on the remote control to select Cancel (cancels operation) or Reset (resets settings). 3 Press the INPUT button on the control panel or the OK button on the remote control to confirm the setting. 	<p>Cancel Reset</p>

ADJUSTING THE LCD DISPLAY

5.4 Configuration1 Settings

 Picture	Switch On State	Last Status
 Screen	Panel Saving	Action
 Audio	Blank Screen Color	Black
 Configuration 1	Boot On Source	Last Input
 Configuration 2	Network	Action
 Advanced Option	Power LED Light	On
	Configuration1 Reset	Action
	Factory Reset	Action

- 1 Press the **MENU** button on the control panel or the  button on the remote control to call out the OSD window.
- 2 Select **Configuration1**, then press the **INPUT** button on the control panel or the **OK** button on the remote control.
- 3 Press the  button on the control panel or the  button on the remote control to select an option.

Item	Function	Operation	Range
Switch On State	<p>Selects the display status used for the next time you connect the power cord.</p> <ul style="list-style-type: none"> • Power off: The display will remain off when the power cord is connected to a wall outlet. • Force on: The display will turn on when the power cord is connected to a wall outlet. • Last status: The display will return to the previous power status (on/off/standby) when removing and replacing the power cord. 	<ol style="list-style-type: none"> 1 Press the INPUT button on the control panel or the OK button on the remote control. 2 Press the  button on the control panel or the  button on the remote control to select the setting. 3 Press the INPUT button on the control panel or the OK button on the remote control to confirm the setting. 	Power off Forced on Last status

ADJUSTING THE LCD DISPLAY

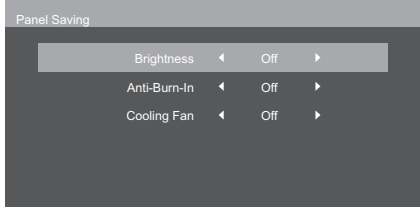
Item	Function	Operation	Range
Panel Saving	<p>Selects the panel saving function to reduce the risk of “image persistence” or “ghost-imaging”.</p> 	<ol style="list-style-type: none"> 1 Press the INPUT button on the control panel or the OK button on the remote control. 2 Press the ▲/▼ button on the control panel or the ↵ button on the remote control to select the setting. 3 Press the INPUT button on the control panel or the OK button on the remote control to confirm the setting. 	Brightness Anti-Burn-In Cooling Fan
	<ul style="list-style-type: none"> • Brightness: Enables or disables using 40% of maximum brightness. 	<ol style="list-style-type: none"> 1 Press the ▲/▼ button on the control panel or the ↵ button on the remote control to select the submenu item. 	Off On
	<ul style="list-style-type: none"> • Anti-Burn-In™: Selects the time interval in seconds for the display to slightly expand the image size and shift the position of pixels in four directions (up, down, left, or right). 	<ol style="list-style-type: none"> 2 Press the +/- button on the control panel or the ←/→ button on the remote control to adjust the value. 	Auto Off 10 to 900 (with the step 10 seconds)
	<ul style="list-style-type: none"> • Cooling Fan: Enables or disables the HeatControl Sensor to automatically activate the internal cooling fan to cool down the temperature. <ul style="list-style-type: none"> - Off: Cooling fan is disabled. - Landscape: Cooling fan is on when the projector is in landscape configuration. - Portrait: Cooling fan is on when the projector is in portrait configuration. - On: Cooling fan is operating normally. 		Off Landscape Portrait On
	<p>Note:</p> <ul style="list-style-type: none"> • A temperature warning message will appear on the screen when the temperature reaches 70°C (158°F). • Regardless the cooling fan status off or on, the cooling fan is turned on automatically if the temperature reaches 70°C (158°F), for three successive minutes and a temperature-waning message is shown on the screen for 10 seconds. In this situation, the LCD display is shut down and the Power LED indicator will be blinking red and green. 		

ADJUSTING THE LCD DISPLAY

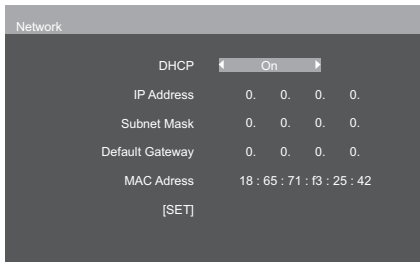
Item	Function	Operation	Range
Blank Screen Colour	Selects the background colour when no signal is detected.	<ol style="list-style-type: none"> 1 Press the INPUT button on the control panel or the OK button on the remote control. 2 Press the ▲/▼ button on the control panel or the ↔ button on the remote control to select the setting. 3 Press the INPUT button on the control panel or the OK button on the remote control to confirm the setting. 	Black Blue
Boot On Source	Sets the default source at boot up.		Last input DisplayPort DVI-D HDMI OPS VGA
Network	Configures network access parameters. 	Press the INPUT button on the control panel or the OK button on the remote control.	DHCP IP Address
	<ul style="list-style-type: none"> • DHCP: Receives network access parameters automatically from the server. 	Press the +/- button on the control panel or the ↔ button on the remote control to select the setting.	On Off
	<ul style="list-style-type: none"> • IP Address: If the DHCP option is set to Off, then enter the network access parameters manually. 	<ol style="list-style-type: none"> 1 Press the +/- button on the control panel or the ↔ button on the remote control to enter the data. 2 Use the ▼/▲ button on the control panel or the ↔ button on the remote control to move to the next or previous field respectively. 3 Repeat steps 1 and 2 until all the parameters are entered. Then select SET to save the settings. 	N/A

ADJUSTING THE LCD DISPLAY

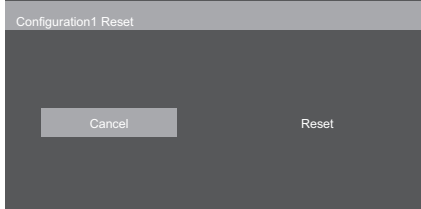
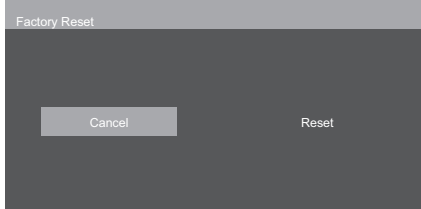
Item	Function	Operation	Range
Power LED Light	Sets the power LED light on or off.	<ol style="list-style-type: none"> 1 Press the INPUT button on the control panel or the OK button on the remote control. 2 Press the ▲/▼ button on the control panel or the ↕ button on the remote control to select the setting. 3 Press the INPUT button on the control panel or the OK button on the remote control to confirm the setting. 	Off On
Configuration1 Reset	Resets all Configuration1 menu settings to their factory defaults. 	<ol style="list-style-type: none"> 1 Press the INPUT button on the control panel or the OK button on the remote control. 2 Press the +/- button on the control panel or the ←/→ button on the remote control to select Cancel (cancels operation) or Reset (resets settings). 	Cancel Reset
Factory Reset	Resets all customised settings to their factory defaults. 	<ol style="list-style-type: none"> 3 Press the INPUT button on the control panel or the OK button on the remote control to confirm the setting. 	Cancel Reset

ADJUSTING THE LCD DISPLAY

5.5 Configuration2 Settings

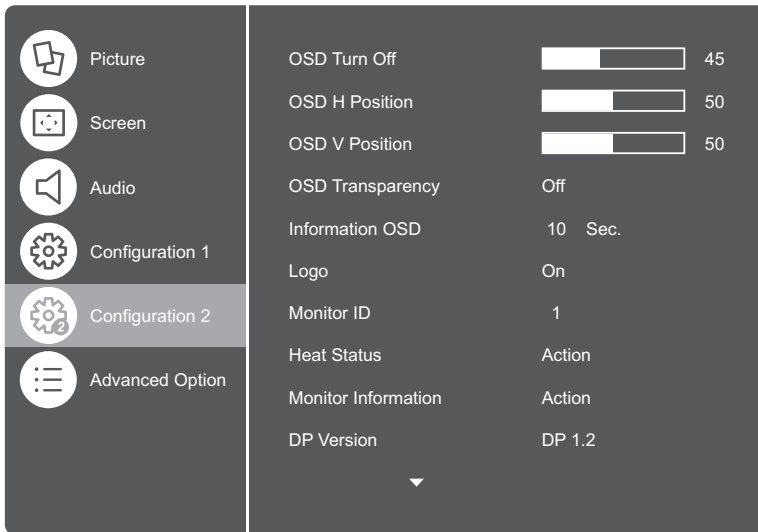

- 1 Press the **MENU** button on the control panel or the **⬆** button on the remote control to call out the OSD window.
- 2 Select **Configuration2**, then press the **INPUT** button on the control panel or the **OK** button on the remote control.
- 3 Press the **▲/▼** button on the control panel or the **M** button on the remote control to select an option.

Item	Function	Operation	Range
OSD Turn Off	Sets the length of time (in seconds) the OSD window is displayed. When the time elapses, the OSD window is automatically inactivated.	Press the +/- button on the control panel or the ←/→ button on the remote control to adjust the value.	0 to 120 (with the step 5 seconds)
OSD H Position	Set the OSD menu horizontal position on the screen.		0 to 100
OSD V Position	Sets the OSD menu vertical position on the screen.		0 to 100
OSD Transparency	Adjusts the OSD transparency in seconds.	<ol style="list-style-type: none"> 1 Press the INPUT button on the control panel or the OK button on the remote control. 2 Press the ▲/▼ button on the control panel or the M button on the remote control to select the setting. 3 Press the INPUT button on the control panel or the OK button on the remote control (if necessary). 	Off 1 to 4
Information OSD	Enables or disables displaying the information OSD when the LCD display is turned on while in standby mode. If enabled, sets the information OSD time interval in seconds.		Off 1 to 60
Logo	Enables or disables the logo feature. If the setting is set to On , the AG Neovo logo is briefly displayed after the display is powered on.		Off On
Monitor ID	Sets the ID number for controlling the display via the RS232 connection. Each display must have a unique ID number when multiple sets of displays are connected.		1 to 255

ADJUSTING THE LCD DISPLAY

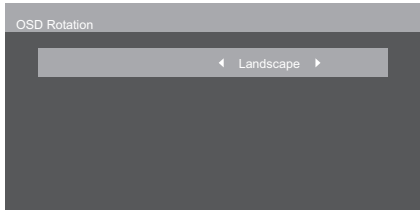
Item	Function	Operation	Range
Heat Status	Displays the heat status.	Press the INPUT button on the control panel or the OK button on the remote control.	Action
Monitor Information	Displays the LCD display information, including model name, serial number, operation hours, and firmware version.		Action
DP Version	<p>Sets the DisplayPort version to 1.1 or 1.2. This setting is only valid with DisplayPort input and output as follows:</p> <ul style="list-style-type: none"> • DP 1.1: Switches the DP Version to 1.1, then the DisplayPort output is the clone of the DisplayPort input. • DP 1.2: Switches the DP Version to 1.2 to support MST(MultiStream Transport). <p>Note: If the display is black screen or abnormal under DisplayPort source, then switch the DP Version to 1.1 and turn AC off and on.</p>	<ol style="list-style-type: none"> 1 Press the INPUT button on the control panel or the OK button on the remote control. 2 Press the ▲▼ button on the control panel or the ↕ button on the remote control to select the setting. 3 Press the INPUT button on the control panel or the OK button on the remote control to confirm the setting. 	DP 1.1 DP 1.2
HDMI EDID	<p>Sets the HDMI EDID version to 1.4 or 2.0 depending on the connected equipment.</p> <p>Note: This option is available only if the input source is HDMI.</p>		1.4 2.0
OSD Rotation	<p>Selects the screen orientation.</p> <p>Note: If the setting is set to Portrait, only the OSD menu screen will change to portrait.</p> 	<ol style="list-style-type: none"> 1 Press the INPUT button on the control panel or the OK button on the remote control. 2 Press the +/- button on the control panel or the ←/→ button on the remote control to select the setting. 	Landscape Portrait

ADJUSTING THE LCD DISPLAY

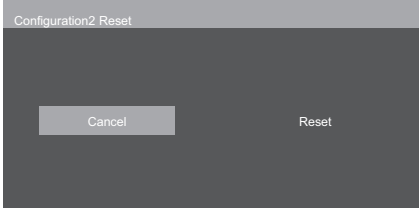
Item	Function	Operation	Range
Language	Selects the language used in OSD menus.	<ol style="list-style-type: none"> 1 Press the INPUT button on the control panel or the OK button on the remote control. 2 Press the ▲/▼ button on the control panel or the ↕ button on the remote control to select the setting. 3 Press the INPUT button on the control panel or the OK button on the remote control to confirm the setting. 	English Français Deutsch Español Italiano 简体中文 繁體中文 Português 日本語
Configuration2 Reset	Resets all Configuration2 menu settings to their factory defaults. 	<ol style="list-style-type: none"> 1 Press the INPUT button on the control panel or the OK button on the remote control. 2 Press the +/- button on the control panel or the ←/→ button on the remote control to select Cancel (cancels operation) or Reset (resets settings). 3 Press the INPUT button on the control panel or the OK button on the remote control to confirm the setting. 	Cancel Reset

ADJUSTING THE LCD DISPLAY

5.6 Advanced Option

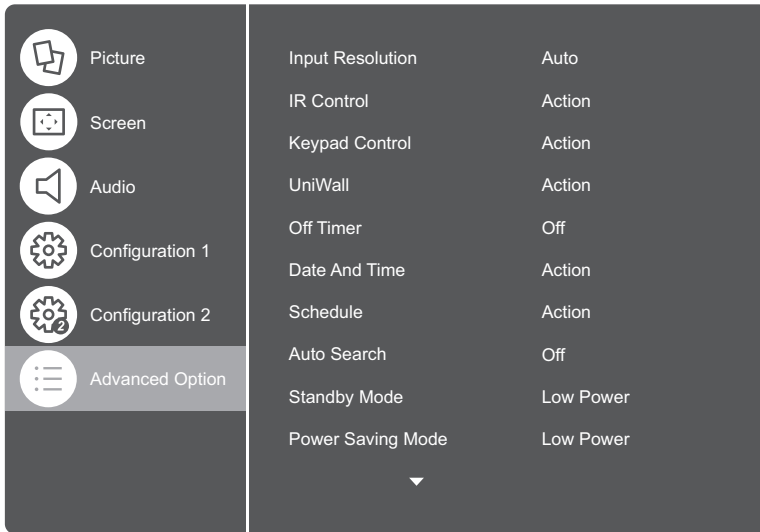

- 1 Press the **MENU** button on the control panel or the **⬆** button on the remote control to call out the OSD window.
- 2 Select **Advanced Option**, then press the **INPUT** button on the control panel or the **OK** button on the remote control.
- 3 Press the **▲/▼** button on the control panel or the **⏮** button on the remote control to select an option.

Item	Function	Operation	Range
Input Resolution	Sets the resolution of the VGA input. This is only required when the display is unable to detect the VGA input resolution correctly. Note: This function is available only with VGA source.	1 Press the INPUT button on the control panel or the OK button on the remote control.	AUTO
		2 Press the ▲/▼ button on the control panel or the ⏮ button on the remote control to select the setting.	1024x768 1280x768 1360x768 1366x768
		3 Press the INPUT button on the control panel or the OK button on the remote control to confirm the setting.	AUTO 1400x1050 1680x1050
			AUTO 1600x1200 1920x1200

ADJUSTING THE LCD DISPLAY

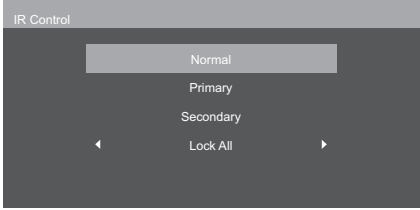
Item	Function	Operation	Range
IR Control	<p>Selects the operation mode of the remote control unit when multiple displays are connected via the RS232 connection.</p>  <ul style="list-style-type: none"> • Normal: All displays can be operated normally by the remote control. • Primary: Designates this monitor as the primary monitor for remote control operation. Only this monitor can be operated by the remote control. • Secondary: Designates this monitor as the secondary monitor. This monitor cannot be operated by the remote control, and will only receive the control signal from the primary monitor via the RS232C connection. 	<ol style="list-style-type: none"> 1 Press the INPUT button on the control panel or the OK button on the remote control. 2 Press the ▲/▼ button on the control panel or the ⏮ button on the remote control to select the setting. 3 Press the INPUT button on the control panel or the OK button on the remote control to confirm the setting. 	Normal Primary Secondary
	<ul style="list-style-type: none"> • Lock All: Lock all remote control functions. • Lock All but Volume: Lock all remote control functions except for the + and - buttons. • Lock All but Power: Lock all remote control functions except for the ⏻ button. <p>Note:</p> <ul style="list-style-type: none"> • To enable the operation of all remote control buttons and keypad buttons, press and hold the i button on the remote control for 6 (six) seconds. 	<ol style="list-style-type: none"> 1 Press the +/- button on the control panel or the ⏮/⏭ button on the remote control to select the setting. 2 Press the INPUT button on the control panel or the OK button on the remote control to confirm the setting. 	Lock All Lock All but Volume Lock All but Power

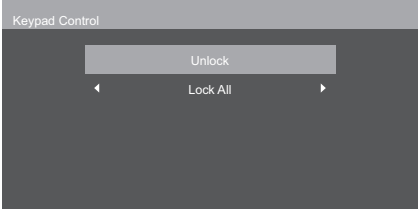

ADJUSTING THE LCD DISPLAY

Item	Function	Operation	Range
Keypad Control	<p>Enables or disables all control panel buttons.</p> 	<ol style="list-style-type: none"> 1 Press the INPUT button on the control panel or the OK button on the remote control. 2 Press the ▲/▼ button on the control panel or the ⏪ button on the remote control to select the setting. 3 Press the INPUT button on the control panel or the OK button on the remote control to confirm the setting. 	Unlock
	<ul style="list-style-type: none"> • Lock All: Lock all control panel buttons. • Lock All but Volume: Lock all control panel buttons except for the + and - button. • Lock All but Power: Lock all control panel buttons except for the ⏻ button. <p>Note:</p> <ul style="list-style-type: none"> • To enable the operation of all remote control buttons and keypad buttons, press and hold the i button on the remote control for 6 (six) seconds. 	<ol style="list-style-type: none"> 1 Press the +/- button on the control panel or the ⏪ button on the remote control to select the setting. 2 Press the INPUT button on the control panel or the OK button on the remote control to confirm the setting. 	Lock All Lock All but Volume Lock All but Power

ADJUSTING THE LCD DISPLAY

Item	Function	Operation	Range		
UniWall	<p>With this function, you can create a single large-screen matrix (video wall) that consists of up to 225 sets of this display (up to 15-sets on the vertical and 15-sets on the horizontal sides). This function requires a daisy-chain connection.</p> <p>If UniWall is enabled, you can configure the following display settings:</p> <ul style="list-style-type: none"> • H Monitors • V Monitors • Position • Frame Comp. 	<p>Press the INPUT button on the control panel or the OK button on the remote control.</p>	Action		
					
	<p>Note: If UniWall is set to On, the ANTI-BURN-IN option is not visible.</p>				
	<ul style="list-style-type: none"> • Enable: Enable or disable UniWall function. 			<p>1 Press the ▲/▼ button on the control panel or the ⏏ button on the remote control to select the setting.</p>	Off On
	<ul style="list-style-type: none"> • H Monitors: Adjusts displays on the horizontal side. • V Monitors: Adjusts displays on the vertical side. 			<p>2 Press the +/- button on the control panel or the ←/→ button on the remote control to select the setting.</p>	1 to 15 1 to 15
<ul style="list-style-type: none"> • Position: Adjusts the position of this display in the screen matrix. Please see the Example1 and Example2 for reference. 		1 to 255			

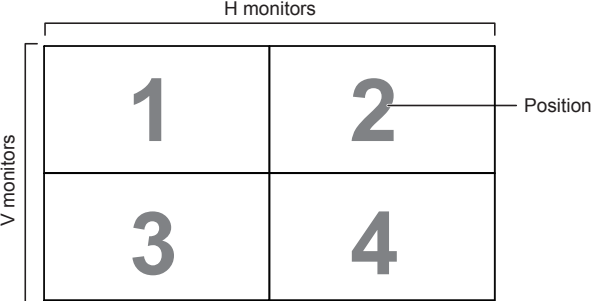
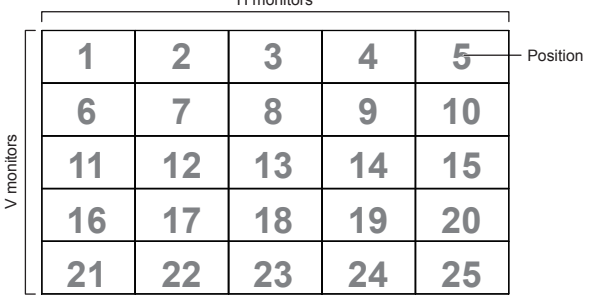
ADJUSTING THE LCD DISPLAY

Item	Function	Operation	Range				
UniWall	<p><u>Example1:</u> 2 x 2 screen matrix (4 displays)</p> <ul style="list-style-type: none"> • H Monitors = 2 displays • V Monitors = 2 displays 						
	<p><u>Example2:</u> 5 x 5 screen matrix (25 displays)</p> <ul style="list-style-type: none"> • H Monitors = 5 displays • V Monitors = 5 displays 						
	<ul style="list-style-type: none"> • Frame Comp.: If frame compensation is enabled, then the display will adjust the image to compensate for the width of the display bezels in order to accurately display the image. Set the Frame Comp. Top, Frame Comp. Bottom, Frame Comp. Left, and Frame Comp. Right parameters from 1 to 100. • Switch On Delay: Enables or disables switch on delay. If enabled, sets the switching on interval in seconds. • Save to Preset: Saves the settings as a preset setting. Note: You can save up to 10 preset settings. • Recall from Preset: Recalls a preset setting. 	<ol style="list-style-type: none"> 1 Press the ▲/▼ button on the control panel or the  button on the remote control to select the setting. 2 Press the +/- button on the control panel or the  button on the remote control to select the setting. 	<table border="1"> <tr> <td data-bbox="1273 1240 1445 1621">Off On</td> </tr> <tr> <td data-bbox="1273 1621 1445 1845">Off Auto 0.1~25.0 (with the step 0.1)</td> </tr> <tr> <td data-bbox="1273 1845 1445 2011">Preset 1 to Preset 10</td> </tr> <tr> <td data-bbox="1273 2011 1445 2096">Preset 1 to Preset 10</td> </tr> </table>	Off On	Off Auto 0.1~25.0 (with the step 0.1)	Preset 1 to Preset 10	Preset 1 to Preset 10
Off On							
Off Auto 0.1~25.0 (with the step 0.1)							
Preset 1 to Preset 10							
Preset 1 to Preset 10							

ADJUSTING THE LCD DISPLAY

Item	Function	Operation	Range
UniWall	<ul style="list-style-type: none"> • Save Action: Saves the action. 	<ol style="list-style-type: none"> 1 Press the ▲/▼ button on the control panel or the M button on the remote control to select the setting. 2 Press the INPUT button on the control panel or the OK button on the remote control. 3 Press the +/- button on the control panel or the ←/→ button on the remote control to select the setting. 4 Press the INPUT button on the control panel or the OK button on the remote control. 	Cancel Action
	<ul style="list-style-type: none"> • Recall Action: Recalls the action. 		Cancel Action
Off Timer	Switches off the display after a specified time (using the countdown timer).	<ol style="list-style-type: none"> 1 Press the INPUT button on the control panel or the OK button on the remote control. 2 Press the ▲/▼ button on the control panel or the M button on the remote control to select the setting. 	Off 1Hour to 24 Hours
Date And Time	Adjusts the current date and time for the LCD display's internal clock.  Note: The NTP Server is set automatically and cannot be altered.	Press the INPUT button on the control panel or the OK button on the remote control.	Action
	<ul style="list-style-type: none"> • Year: Selects the year manually. 	<ol style="list-style-type: none"> 1 Press the ▲/▼ button on the control panel or the M button on the remote control to select the setting. 2 Press the +/- button on the control panel or the ←/→ button on the remote control to select the setting. 	2021 to 2041
	<ul style="list-style-type: none"> • Month: Selects the month manually. 		01 to 12
	<ul style="list-style-type: none"> • Day: Selects the day manually. 		01 to 31
	<ul style="list-style-type: none"> • Hour: Selects hour manually. 		00 to 23
<ul style="list-style-type: none"> • Minute: Selects minutes manually. 	00 to 59		

ADJUSTING THE LCD DISPLAY

Item	Function	Operation	Range
Date And Time <i>(continued)</i>	<ul style="list-style-type: none"> • Daylight Saving Time: Selects daylight saving time. 	<ol style="list-style-type: none"> 1 Press the ▲/▼ button on the control panel or the M button on the remote control to select the setting. 2 Press the INPUT button on the control panel or the OK button on the remote control. 3 Press the +/- button on the control panel or the ←/→ button on the remote control to select the setting. 4 Use the ▼/▲ button on the control panel or the M button on the remote control to move to the next or previous field respectively. 5 Repeat steps 3 and 4 until all the settings are set. Then move to the Daylight Saving Correction field and press the +/- button on the control panel or the ←/→ button on the remote control to select On. Press the INPUT button on the control panel or the OK button on the remote control to save the settings. 	N/A
<ul style="list-style-type: none"> • Date and Time: Displays the current date and time from the NTP server. 			

ADJUSTING THE LCD DISPLAY

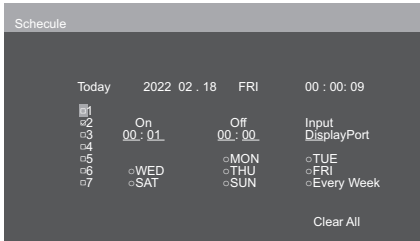
Item	Function	Operation	Range
Schedule	<p>This function allows you to program up to 7 different scheduled time intervals for this display to activate.</p> <p>You can set:</p> <ul style="list-style-type: none"> Which input source the display will use for each scheduled activation period. The time for the display to turn on and turn off. The days in a week for the display to activate.  <p>Note:</p> <ul style="list-style-type: none"> We recommend you to set up current date and time in the Date And Time menu before using this function. After modifying the Date And Time settings, you need to set this Scheduling again. 	<p>Press the INPUT button on the control panel or the OK button on the remote control.</p>	Action
	<ul style="list-style-type: none"> 1 to 7: Selects the schedule. 	<ol style="list-style-type: none"> Press the ▲/▼ button on the control panel or the ↕ button on the remote control to select the setting. Press the INPUT button on the control panel or the OK button on the remote control. 	1 to 7
	<ul style="list-style-type: none"> On: Sets time when the schedule is turned on. 	<ol style="list-style-type: none"> Use the +/- button on the control panel or the ←/→ button on the remote control to move to the next or previous field respectively. Use the ▼/▲ button on the control panel or the ↕ button on the remote control to select the setting. 	00 to 23
	<ul style="list-style-type: none"> Off: Sets time when the schedule is turned off. 		00 to 23
<ul style="list-style-type: none"> Input: Sets the input source. 	DisplayPort DVI-D HDMI VGA		

ADJUSTING THE LCD DISPLAY

Item	Function	Operation	Range
Schedule (continued)	<ul style="list-style-type: none"> • MON to SUN/Every Week: Sets the days in a week when the schedule is turned on or selects to turn on the schedule every week. 	<ol style="list-style-type: none"> 1 Use the +/- button on the control panel or the ←/→ button on the remote control to move to the next or previous field respectively. 2 Press the INPUT button on the control panel or the OK button on the remote control to select the day or every week setting. 	MON to SUN Every Week
	<ul style="list-style-type: none"> • Clear All: Clears all schedule settings. 	<ol style="list-style-type: none"> 1 Use the +/- button on the control panel or the ←/→ button on the remote control to move to the Clear All field. 2 Press the INPUT button on the control panel or the OK button on the remote control to clear all schedule settings. 	N/A
Auto Search	<p>Enables or disables displaying available signal sources automatically.</p> <p>Note: This function takes place only when there is no signal connected at the input port you designate for auto-detection.</p>	<ol style="list-style-type: none"> 1 Press the INPUT button on the control panel or the OK button on the remote control. 2 Press the ▲/▼ button on the control panel or the ↕ button on the remote control to select the setting. 	Off On
Standby Mode	<p>Sets standby mode when DC is off.</p> <ul style="list-style-type: none"> • Lower Power: The LCD display is in the lowest power standby mode & LAN port is disabled. • Fast Startup: The LCD display is in the lower power standby mode & LAN port is active. <p>Note:</p> <ul style="list-style-type: none"> • When DC power is off, the power status LED lights red. • Fast Startup mode will cause power consumption to increase. 	<ol style="list-style-type: none"> 1 Press the INPUT button on the control panel or the OK button on the remote control. 2 Press the ▲/▼ button on the control panel or the ↕ button on the remote control to select the setting. 3 Press the INPUT button on the control panel or the OK button on the remote control. 	Lower Power Fast Startup

ADJUSTING THE LCD DISPLAY

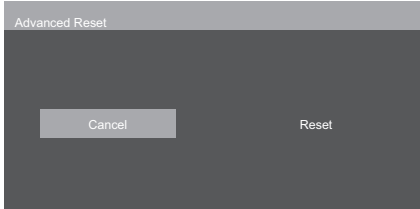

Item	Function	Operation	Range
Power Saving Mode	<p>Configures power saving mode settings.</p> <p>Note: System enters power saving mode automatically if no signal is detected unless the power saving mode is off.</p> <ul style="list-style-type: none"> • Low Power: The LCD display is in the lowest power standby mode and cannot be woken up on signal detection and LAN. The power status LED is red. • Wake On Signal: The LCD display is in a low power standby mode (but not necessarily the lowest power standby mode). The device can be woken up on signal detection and LAN. The power status LED is amber. • Fast Wake On Signal: The LCD display is fully on but the backlight is off. The device can be woken up on signal detection. The power status LED is amber. • Disabled: The LCD display never enters the power saving mode neither displays “No signal” message. The power status LED is green. 	<ol style="list-style-type: none"> 1 Press the INPUT button on the control panel or the OK button on the remote control. 2 Press the ▲/▼ button on the control panel or the ⏏ button on the remote control to select the setting. 3 Press the INPUT button on the control panel or the OK button on the remote control. 	Low Power Wake On Signal Fast Wake On Signal Disabled

ADJUSTING THE LCD DISPLAY

Item	Function	Operation	Range
Power Saving Mode (continued)	<p>Note:</p> <ul style="list-style-type: none"> If the OPS is connected to the system and the OPS is in the sleep mode or off, then the Power Saving Mode automatically changes to Fast Wake On Signal despite the original setting. If the Power Saving Mode is set to any setting other than Disabled, then the No Signal message time-out is 60 seconds. Network function does not support Low Power mode, other Power Saving Modes are supported. 		
Firmware Update	Updates system firmware.	Press the INPUT button on the control panel or the OK button on the remote control.	Action
Advanced Option Reset	<p>Resets all Advanced Option menu settings to their factory defaults.</p> 	<ol style="list-style-type: none"> Press the INPUT button on the control panel or the OK button on the remote control. Press the +/- button on the control panel or the ◀/▶ button on the remote control to select Cancel (cancels operation) or Reset (resets settings). Press the INPUT button on the control panel or the OK button on the remote control to confirm the setting. 	Cancel Reset

CHAPTER 6: APPENDIX

6.1 Warning Messages

Warning Messages	Cause	Solution
 No Signal !	<p>The LCD display cannot detect the input source signal.</p>	<ul style="list-style-type: none"> • Check if the input source is turned ON. • Check if the signal cable is properly connected. • Check if any pin inside the cable connector is twisted or broken.
Keypad Locked	<p>The operation using control panel buttons has been locked by the user.</p>	<ul style="list-style-type: none"> • To enable the operation of all control panel buttons, press and hold the  button on the remote control for 6 (six) seconds. For more locking/unlocking options, refer to “Keypad Control” on page 53.
IR Locked	<p>The operation using the remote control buttons has been locked by the user.</p>	<ul style="list-style-type: none"> • To unlock all remote control buttons, press and hold the  button on the remote control for 6 (six) seconds. For more locking/unlocking options, refer to “IR Control” on page 52.

APPENDIX

6.2 Supported Resolution

VGA Resolution:

Standard Resolution	Active Resolution		Refresh Rate	Pixel Rate	Aspect Ratio	Stand for Mode
	H Pixels	V Lines				
VGA	640	480	60 Hz	25.175 MHz	4:3	Video Graphic Array
			75 Hz	31.5 MHz		
SVGA	800	600	60 Hz	40 MHz	4:3	Super VGA
XGA	1024	768	60 Hz	65 MHz	4:3	Extended Graphic Array
SXGA	1280	1024	60 Hz	108 MHz	5:4	Super XGA
UXGA	1600	1200	60 Hz	162 MHz	4:3	Ultra XGA
HD1080	1920	1080	60 Hz	148.5 MHz	16:9	HD1080

Note:

- 1280 x 768/60Hz can be supported but not shown in the VGA resolution table.

SD Resolution:

Standard Resolution	Active Resolution		Refresh Rate	Pixel Rate	Aspect Ratio
	H Pixels	V Lines			
480p	720	480	59.94 Hz	27 MHz	4:3
576p	720	576	50 Hz	27 MHz	4:3

HD Resolution:

Standard Resolution	Active Resolution		Refresh Rate	Pixel Rate	Aspect Ratio
	H Pixels	V Lines			
720p	1280	720	50 Hz	74.25 MHz	16:9
			60 Hz		
1080p	1920	1080	50 Hz	148.5 MHz	16:9
			60 Hz		

General guidelines:

- The PC text quality is optimum in HD 1080 mode (1920 x 1080, 60Hz).
- Your PC display screen might appear different depending on the manufacturer (and your particular version of Windows).
- Check your PC instruction book for information about connecting your PC to a display.
- If a vertical and horizontal frequency-select mode exists, select 60Hz (vertical) and 31.5KHz (horizontal). In some cases, abnormal signals (such as stripes) might appear on the screen when the PC power is turned off (or if the PC is disconnected). If so, press the [INPUT] button to enter the video mode. Also, make sure that the PC is connected.
- When horizontal synchronous signals seem irregular in RGB mode, check PC power saving mode or cable connections.
- The display settings table complies to the IBM/VESA standards, and based on the analog input.
- The best timing for the vertical frequency to each mode is 60Hz.

6.3 Cleaning

Caution When Using the Display

- Do not bring your hands, face or objects close to the ventilation holes of the display. The top of the display is usually very hot due to the high temperature of exhaust air being released through the ventilation holes. Burns or personal injuries may occur if any body parts are brought too close. Placing any object near the top of the display could also result in heat related damage to the object as well as the display itself.
- Be sure to disconnect all cables before moving the display. Moving the display with its cables attached may damage the cables and thus cause fire or electric shock.
- Disconnect the power plug from the wall outlet as a safety precaution before carrying out any type of cleaning or maintenance procedure.

Front Panel Cleaning Instructions



- The front of the display has been specially treated. Wipe the surface gently using only a cleaning cloth or a soft, lint-free cloth.
- If the surface becomes dirty, soak a soft, lint-free cloth in a mild detergent solution. Wring the cloth to remove excess liquid. Wipe the surface of the display to remove dirt. Then use a dry cloth of the same type to dry.
- Do not scratch or hit the surface of the panel with fingers or hard objects of any kind.
- Do not use volatile substances such as insert sprays, solvents and thinners.

Cabinet Cleaning Instructions

- If the cabinet becomes dirty, wipe the cabinet with a soft, dry cloth.
- If the cabinet is extremely dirty, soak a lint-free cloth in a mild detergent solution. Wring the cloth to remove as much moisture as possible. Wipe the cabinet. Use another dry cloth to wipe over until the surface is dry.
- Do not allow any water or detergent to come into contact with the surface of the display. If water or moisture gets inside the unit, operating problems, electrical and shock hazards may result.
- Do not scratch or hit the cabinet with fingers or hard objects of any kind.
- Do not use volatile substances such as insert sprays, solvents and thinners on the cabinet.
- Do not place anything made from rubber or PVC near the cabinet for any extended periods of time.

APPENDIX

6.4 Troubleshooting

Symptom	Possible Cause	Remedy
No picture is displayed	<ul style="list-style-type: none"> The main power switch on the back of the display is not switched on. The selected input has no connection. The display is in standby mode. 	<ol style="list-style-type: none"> 1 Plug in the power cord. 2 Make sure the power switch is switched on. 3 Connect a signal connection to the display.
Interference displayed on the display or audible noise is heard	Caused by surrounding electrical appliances or fluorescent lights.	Move the display to another location to see if the interference is reduced.
Colour is abnormal	The signal cable is not connected properly.	Make sure that the signal cable is attached firmly to the back of the display.
Picture is distorted with abnormal patterns	<ul style="list-style-type: none"> The signal cable is not connected properly. The input signal is beyond the capabilities of the display. 	<ul style="list-style-type: none"> Make sure that the signal cable is attached firmly. Check the video signal source to see if it is beyond the range of the display. Please verify its specifications with this display's specification section.
Display image doesn't fill up the full size of the screen	The picture format is not set correctly.	Press the  button and select Auto .
Can hear sound, but no picture	Improperly connected source signal cable.	Make sure that both video inputs and sound inputs are correctly connected.
Can see picture but no sound is heard	<ul style="list-style-type: none"> Improperly connected source signal cable. Volume is turned all the way down. MUTE function is turned on. No external speaker connected. 	<ul style="list-style-type: none"> Make sure that both video and sound inputs are correctly connected. Press the + or - button to hear the sound. Switch the MUTE function off by using the  button. Connect the external speakers and adjust the volume to a suitable level.
Some picture elements do not light up	Some pixels of the display may not turn on.	This display is manufactured using an extremely high level of precision technology: however, sometimes some pixels of the display may not display. This is not a malfunction.
After-Images can still be seen on the display after the display is powered off. (Examples of still pictures include logos, video games, computer images, and images displayed in 4:3 normal mode)	A still picture is displayed for an over extended period of time.	Do not allow a still image to be displayed for an extended period of time as this can cause a permanent after-image to remain on the display.

APPENDIX

6.5 Transporting the LCD Display

To transport the LCD display for repair or shipment, place the display in its original packaging carton.

- 1 Put all the accessories in the box (if necessary).
- 2 Place the lower foam cushions (a) inside the lower box (b).
- 3 Place the supportive sheet (c) inside the lower box (b).
- 4 Place the LCD display (d) down in the lower foam cushions (a).
- 5 Place the upper foam cushions (e) on top of the LCD display (d).
- 6 Place the accessories box (f) on the designated area (if necessary).
- 7 Place the upper box (g) on LCD display.
- 8 Secure the upper box to the lower box with the supplied locks (h).

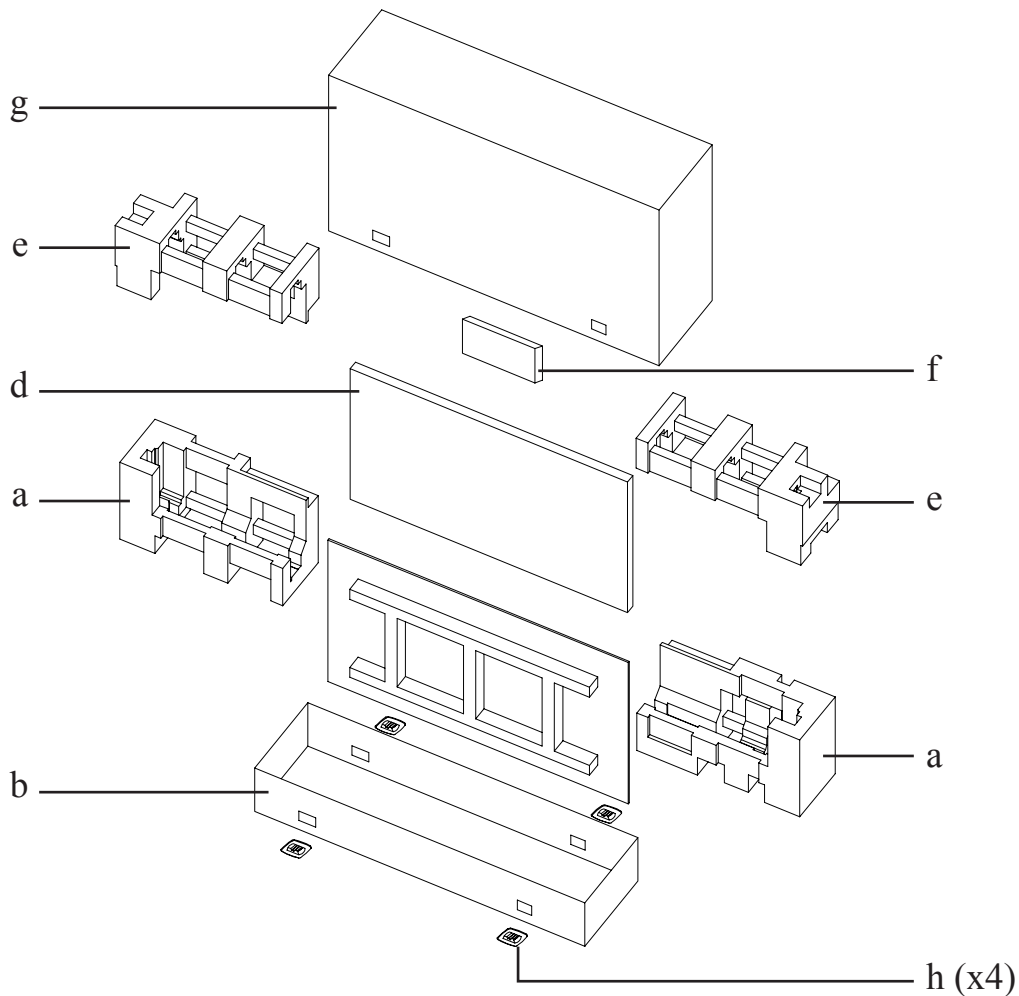

CHAPTER 7: SPECIFICATIONS

7.1 Display Specifications

PN-55D3		
Panel	Panel Type	LED-Backlit TFT LCD (IPS Technology)
	Panel Size	54.6"
	Max. Resolution	FHD 1920 x 1080
	Pixel Pitch	0.630 mm
	Brightness	500 cd/m ²
	Contrast Ratio	1200:1
	Viewing Angle (H/V)	178°/178°
	Display Colour	1.07B
	Response Time	5 ms
	Surface Treatment	Anti-Glare Treatment (Haze 28%), 2H Hard Coating
Frequency (H/V)	H Freq.	31 kHz-92 kHz
	V Freq.	49 Hz-85 Hz
Input	DisplayPort	1.2 x 1
	HDMI	2.0 x 1
	DVI	24-Pin DVI-D
	VGA	15-Pin D-Sub x 1
Output	DisplayPort	1.2 x 1
External Control	IR In	3.5 mm Phone Jack
	IR Out	3.5 mm Phone Jack
	RS232 In	2.5 mm Phone Jack
	RS232 Out	2.5 mm Phone Jack
	LAN	RJ45 x 1
Other Connectivity	USB	2.0 x 1 (Service Port)
	OPS Slot	Yes
Audio	Audio In	Stereo Audio Jack (3.5 mm)
	Audio Out	Stereo Audio Jack (3.5 mm), S/PDIF
	Internal Speakers	10 W x 2
	Speaker Output (RMS)	10 W x 2
Power	Power Requirements	AC 100-240V, 50/60 Hz
	On Mode	79W (On)
	Stand-by Mode	< 0.5W
	Off Mode	0W
	Power Supply	Internal
Operating Conditions	Temperature	0°C-40°C (32°F-104°F)
	Humidity	20%-80% (non-condensing)
Storage Conditions	Temperature	-20°C-60°C (-4°F-140°F)
	Humidity	10%-90% (non-condensing)
Mounting	VESA FPMPMI	Yes (400 x 400 mm)
Security	Kensington Security Slot	Yes
Dimensions	Product w/o Base (W x H x D)	1213.4 x 684.2 x 102.7 mm (47.8" x 26.9" x 4.0")
	Packaging (W x H x D)	1395.0 x 838.0 x 280.0 mm (54.9" x 33.0" x 11.0")
Weight	Product w/o Base	26.6 kg (58.6 lb)
	Packaging	35.3 kg (77.8 lb)

Note:

- All specifications are subject to change without prior notice.

SPECIFICATIONS

7.2 Display Dimensions

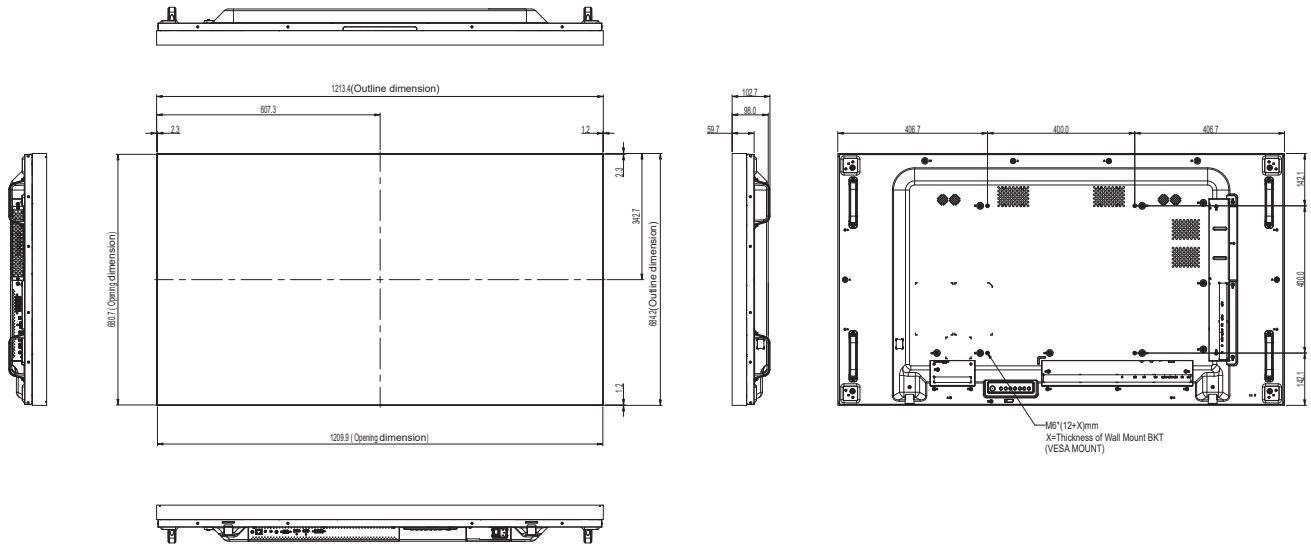

AG Neovo

Company Address: 5F-1, No. 3-1, Park Street, Nangang District, Taipei, 11503, Taiwan.

Copyright © 2022 AG Neovo. All rights reserved.

PN-55D3 Eprel registration number: 1053070

PN5D30_UM_V010