



**THE DISPLAY CHOICE  
OF PROFESSIONALS™**

[www.agneovo.com](http://www.agneovo.com)

**DR-24G LCD Monitor**  
**User Manual**

# TABLE OF CONTENTS

## Safety Information

Federal Communications Commission (FCC) Notice (U.S. Only).....	4
WEEE.....	5

## Precautions

Notice .....	6
Cautions When Setting Up .....	7
Cautions When Using.....	8
Cleaning and Maintenance.....	8
Notice for the LCD Display .....	9

## Chapter 1: Product Description

1.1 Package Contents .....	10
1.2 Wall Mounting Installation Preparation .....	11
1.2.1 Wall Mounting.....	11
1.3 LCD Display Overview .....	12
1.3.1 Front View and Keypad Buttons.....	12
1.3.2 Rear View.....	13

## Chapter 2: Making Connections

2.1 Connecting the Power .....	14
2.2 Connecting Input Source Signals .....	15
2.2.1 Connecting a Computer .....	15
Using VGA Cables .....	15
Using DVI Cables.....	15
Using HDMI Cables.....	16
Using DisplayPort Cables .....	16
Using RS232 Cables.....	17
Using Audio Cables.....	17
2.2.2 Connecting a Video Device .....	18
Using Composite (CVBS) Cables .....	18
Using S-Video Cables .....	19
Using HDMI Cables.....	19
Using DisplayPort Cables .....	20

## Chapter 3: Using the LCD Display

3.1 Turning on the Power .....	21
3.2 Selecting the Input Source Signal .....	21
3.3 Adjusting the Volume / Illuminator Function Hot Key.....	22
3.3.1 Muting the Audio.....	22
3.3.2 Illuminator Function Hot Key .....	22
3.4 Choosing Your Preferred Picture Settings.....	22
3.5 Using Picture-in-Picture (PIP) .....	23
3.5.1 PIP/PBP Options .....	23
3.5.2 PIP/PBP Swap .....	24
3.6 Using FREEZE Function .....	24
3.7 Using Auto Adjustment Function .....	25

# TABLE OF CONTENTS

3.8 Using ROTATE Function .....	25
3.9 Locking the OSD Menu .....	26
<b>Chapter 4: On Screen Display Menu</b>	
4.1 Using the OSD Menu .....	27
4.2 OSD Menu Tree .....	29
<b>Chapter 5: Adjusting the LCD Display</b>	
5.1 Brightness .....	32
5.2 Colour Temp. ....	34
5.3 Image Setting .....	35
5.4 Aspect Ratio .....	38
5.5 PIP Setting .....	39
5.6 Anti-Burn-in.....	41
5.7 OSD Setting .....	42
5.8 Audio Setting .....	43
5.9 System 1 .....	44
5.10 System 2 .....	46
5.11 EcoSmart Sensor .....	47
5.12 Input Select .....	49
<b>Chapter 6: Appendix</b>	
6.1 Warning Messages.....	50
6.2 Supported Resolutions .....	51
6.3 Troubleshooting.....	52
6.4 Transporting the LCD Display .....	54
<b>Chapter 7: Specifications</b>	
7.1 Display Specifications .....	55
7.2 Display Dimensions.....	56

# TABLE OF CONTENTS

## Federal Communications Commission (FCC) Notice (U.S. Only)



This equipment has been tested and found to comply with the limits for a Class B digital device, pursuant to part 15 of the FCC Rules. These limits are designed to provide reasonable protection against harmful interference in a residential installation. This equipment generates, uses and can radiate radio frequency energy and, if not installed and used in accordance with the instructions, may cause harmful interference to radio communications. However, there is no guarantee that interference will not occur in a particular installation. If this equipment does cause harmful interference to radio or television reception, which can be determined by turning the equipment off and on, the user is encouraged to try to correct the interference by one or more of the following measures:

- Reorient or relocate the receiving antenna.
- Increase the separation between the equipment and receiver.
- Connect the equipment into an outlet on a circuit different from that to which the receiver is connected.
- Consult the dealer or an experienced radio/TV technician for help.



Changes or modifications not expressly approved by the party responsible for compliance could void the user's authority to operate the equipment.

Use only an RF shielded cable that was supplied with the display when connecting this display to a computer device.

To prevent damage which may result in fire or shock hazard, do not expose this appliance to rain or excessive moisture.

THIS CLASS B DIGITAL APPARATUS MEETS ALL REQUIREMENTS OF THE CANADIAN INTERFERENCE-CAUSING EQUIPMENT REGULATIONS.



This device complies with Part 15 of the FCC Rules. Operation is subject to the following two conditions: (1) this device may not cause harmful interference, and (2) this device must accept any interference received, including interference that may cause undesired operation.

# TABLE OF CONTENTS

## WEEE

Disposal of Waste Equipment by Users in Private Household in the European Union.

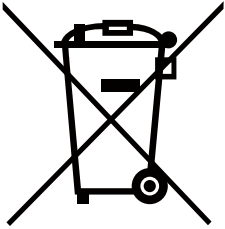

This symbol on the product or on its packaging indicates that this product must not be disposed of with your other household waste. Instead, it is your responsibility to dispose of your waste equipment by handing it over to a designated collection point for the recycling of waste electrical and electronic equipment. The separate collection and recycling of your waste equipment at the time of disposal will help to conserve natural resources and ensure that it is recycled in a manner that protects human health and the environment. For more information about where you can drop off your waste equipment for recycling, please contact your local city office, your household waste disposal service or the shop where you purchased the product

For Private Households in the European Union. To help conserve natural resources and ensure the product is recycled in a manner that protects human health and the environment, we would like to bring your attention to the following:

- The crossed-out dustbin on the device or outer packaging indicates the product is compliant with European WEEE (Waste Electrical and Electronic Equipment) Directive
- Always dispose of the old devices separately from household waste
- Batteries should be removed beforehand and disposed separately to the right collection system
- You are responsible with regard to the deletion of personal data on old devices before disposal
- Private households can hand in their old devices free of charge
- For more information about where you can drop off your waste equipment for recycling, please contact your local city office, your household waste disposal service or the shop where you purchased the product

# TABLE OF CONTENTS

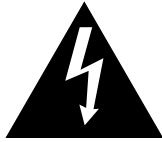

**CAUTION**  
RISK OF ELECTRIC SHOCK  
DO NOT OPEN



## Symbols used in this manual

	This icon indicates the existence of a potential hazard that could result in personal injury or damage to the product.
	This icon indicates important operating and servicing information.

## Notice

- Read this User Manual carefully before using the LCD monitor and keep it for future reference.
- The product specifications and other information provided in this User Manual are for reference only. All information is subject to change without notice. Updated content can be downloaded from our web site at [www.agneovo.com](http://www.agneovo.com).
- To protect your rights as a consumer, do not remove any stickers from the LCD monitor. Doing so may affect the determination of the warranty period.

# TABLE OF CONTENTS

## Cautions When Setting Up

---



Do not place the LCD monitor near heat sources, such as a heater, exhaust vent, or in direct sunlight.

---



Do not cover or block the ventilation holes in the housing.

---



Place the LCD monitor on a stable area. Do not place the LCD monitor where it may be subject to vibration or shock.

---



Place the LCD monitor in a well-ventilated area.

---



Do not place the LCD monitor outdoors.

---



Do not place the LCD monitor in a dusty or humid environment.

---



Do not spill liquid or insert sharp objects into the LCD monitor through the ventilation holes. Doing so may cause accidental fire, electric shock or damage the LCD monitor.

---

# TABLE OF CONTENTS

## Cautions When Using



Use only the power cord supplied with the LCD monitor.



The power outlet should be installed near the LCD monitor and be easily accessible.



If an extension cord is used with the LCD monitor, ensure that the total current consumption plugged into the power outlet does not exceed the ampere rating.



Do not allow anything to rest on the power cord. Do not place the LCD monitor where the power cord may be stepped on.



If the LCD monitor will not be used for an indefinite period of time, unplug the power cord from the power outlet.



To disconnect the power cord, grasp and pull by the plug head. Do not tug on the cord; doing so may cause fire or electric shock.

The mains plug or appliance coupler is used as the disconnect device, the disconnect device shall remain readily operable. Always completely disconnect the power cord set from your product whenever you are working or cleaning on it. Do not make connections while the power is on, because a sudden rush of power can damage sensitive electronic components.



Do not unplug or touch the power cord with wet hands.

## Cleaning and Maintenance

Disconnect this equipment from any AC outlet before cleaning. Do not use liquid or spray detergents for cleaning. Use a damp cloth. Keeping to clean your monitor by monthly.



The LCD monitor comes with NeoV™ Optical Glass. Use a soft cloth to clean the glass surface and the housing. The monitor can be cleaned using a cloth moistened with 95% ethyl alcohol.



Do not rub or tap the surface of the glass with sharp or abrasive items such as a pen or screwdriver. This may result in scratching the surface of the glass.



Do not attempt to service the LCD monitor yourself, refer to qualified service personnel. Opening or removing the covers may expose you to dangerous voltage or other risks.



### Warning:



Unplug the power cord from the power outlet and refer to qualified service personnel under the following conditions:

- ◆ When the power cord is damaged.
- ◆ If the LCD display has been dropped or the housing has been damaged.
- ◆ If the LCD display emits smoke or a distinct odor.



### Warning:



Ceiling mount or mount on any other horizontal surface overhead are not advisable.

Installation in contravention of the instructions may result in undesirable consequences, particularly hurting people and damaging property. Users who have already mounted the display on the ceiling or any other horizontal surface overhead are strongly advised to contact AG Neovo for consultations and solutions to help ensure a most pleasurable and fulfilling display experience.



# TABLE OF CONTENTS

---

## Notice for the LCD Monitor

---

In order to maintain the stable luminous performance, it is recommended to use low brightness setting.

---

Due to the lifespan of the lamp, it is normal that the brightness quality of the LCD monitor may decrease with time.

---

When static images are displayed for long periods of time, the image may cause an imprint on the LCD monitor. This is called image retention or burn-in.

To prevent image retention, do any of the following:

- Set the LCD monitor to turn off after a few minutes of being idle.
- Use a screen saver that has moving graphics or a blank white image.
- Switch desktop backgrounds regularly.
- Adjust the LCD monitor to low brightness settings.
- Turn off the LCD monitor when the system is not in use.

Things to do when the LCD monitor shows image retention:

- Turn off the LCD monitor for extended periods of time. It can be several hours or several days.
  - Use a screen saver and run it for extended periods of time.
  - Use a black and white image and run it for extended periods of time.
- 

When the LCD monitor is moved from one room to another or there is a sudden change from low to high ambient temperature, dew condensation may form on or inside the glass surface. When this happens, do not turn on the LCD monitor until the dew disappears.

---

Due to humid weather conditions, it is normal for mist to form inside the glass surface of the LCD monitor. The mist will disappear after a few days or as soon as the weather stabilizes.

---

There are millions of micro transistors inside the LCD monitor. It is normal for a few transistors to be damaged and to produce spots. This is acceptable and is not considered a failure.

---

# TABLE OF CONTENTS

## 1.1 Package Contents

When unpacking, check if the following items are included in the package. If any of them is missing or damaged, contact your dealer.

LCD Monitor

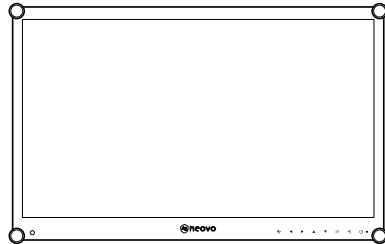

Quick Start Guide



Power adapter

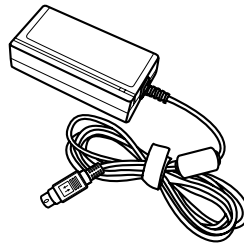

Power cord

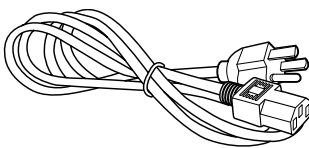

VGA cable

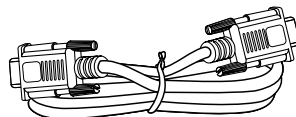

Audio cable

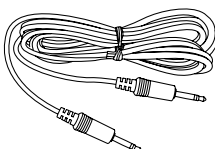

Warranty card

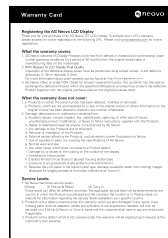

### Note:

Must use only the supplied power adapter:

- ◆ ADAPTER TECH  
Model no.: ATM065T-P240  
Rating: 24V/2.71A

### Note:

- ◆ The pictures are for reference only. Actual items may vary upon shipment.

# TABLE OF CONTENTS

## 1.2 Wall Mounting Installation Preparation

### 1.2.1 Wall Mounting

#### 1 Remove the base stand.

See procedures below.

#### 2 Wall mount the LCD display.

Screw the mounting bracket to the VESA holes at the rear of the LCD display.

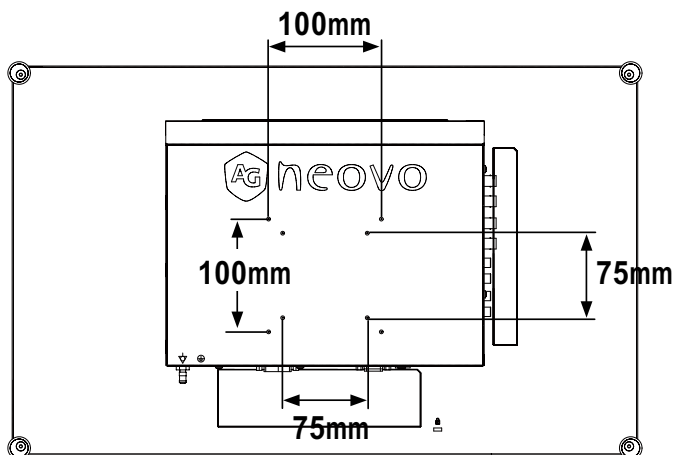

#### Note:

To protect the glass panel, place a towel or soft cloth before laying the LCD display down.



#### Warning:



Ceiling mount or mount on any other horizontal surface overhead are not advisable.

Installation in contravention of the instructions may result in undesirable consequences, particularly hurting people and damaging property. Users who have already mounted the display on the ceiling or any other horizontal surface overhead are strongly advised to contact AG Neovo for consultations and solutions to help ensure a most pleasurable and fulfilling display experience.

#### Note:

Take measures to prevent the LCD display from falling down and lessen possible injury and damage to the display in case of earthquakes or other disasters.

- ◆ Use only the 75 x 75 mm and 100 x 100 mm wall mount kit recommended by AG Neovo.
- ◆ Secure the LCD display on a solid wall strong enough to bear its weight.

# TABLE OF CONTENTS

## 1.3 LCD Display Overview

### 1.3.1 Front View and Keypad Buttons

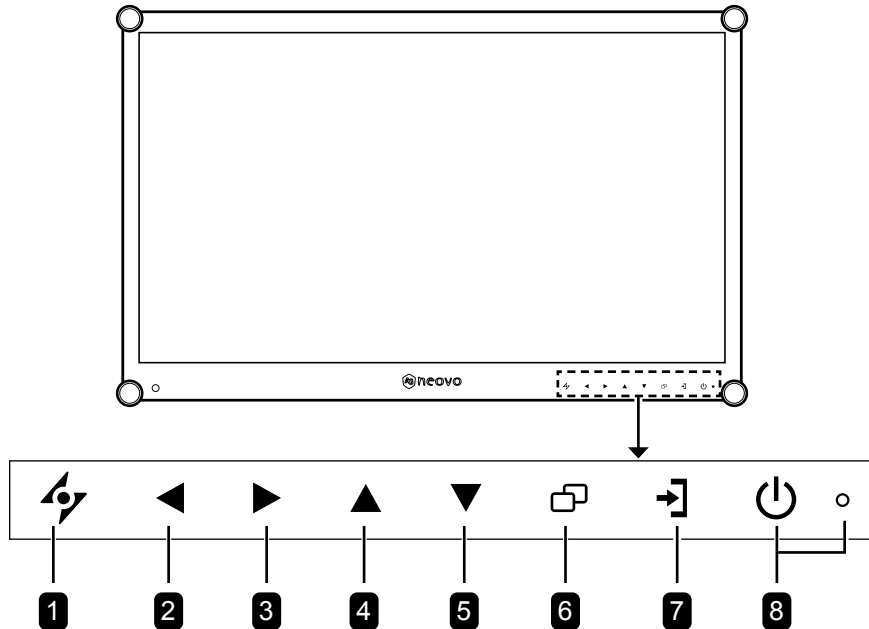

#### 1 AUTO

##### **Hot Key: Auto Adjustment/Rotate**

- For VGA input signal source, press to perform auto adjustment.
- Press for 3 seconds to enable the Rotate function.
- When OSD menu is ON, press to close the OSD menu or exit a submenu.

#### 2 LEFT

##### **Hot Key: Audio Volume Adjustment**

- Press to display the volume bar. Then press the LEFT key to decrease the volume.
- When OSD menu is ON, press to select an option or adjust the settings.

#### 3 RIGHT

##### **Hot Key: Screen Freeze**

- Press to activate the screen freeze function. To deactivate, press any key except for the Power key.
- When the volume bar appears, press to increase the volume.
- When OSD menu is ON, press to select and option, adjust the settings, or enter the submenu.

#### 4 UP

##### **Hot Key: PIP/PBP Select**

- Press repeatedly to select PIP/PBP option (PIP → PBP → OFF).
- When OSD menu is ON, press to select an option or adjust the settings.

#### 5 DOWN

##### **Hot Key: PICTURE MODE Select**

- Press repeatedly to select PICTURE MODE option (STANDARD → VIDEO → sRGB).
- When OSD menu is ON, press to select an option or adjust the settings.
- When PIP is ON, press to swap the PIP main and sub picture.

#### 6 MENU

Press to display/hide the OSD menu.

#### 7 SOURCE

Press to select the input signal source.

#### 8 POWER and LED Indicator

- Press to turn the power on or off.
- Indicate the operating status of the LCD display:
  - Lights Green when the LCD display is turned on.
  - Lights Amber when the LCD display is in standby mode.
  - Lights Off when the LCD display is turned off.

# TABLE OF CONTENTS

## 1.3.2 Rear View

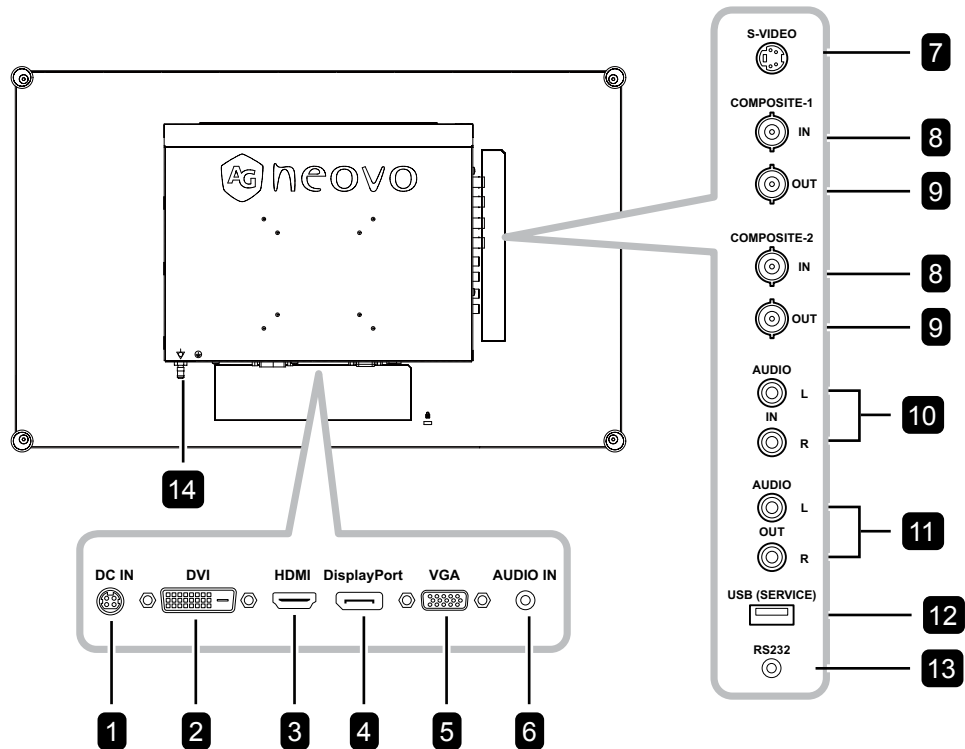

- |  |   |
|--|---|
| <p><b>1 DC IN</b><br/>Connect with the supplied power adaptor.</p> <p><b>2 DVI</b><br/>Connect DVI signals input.</p> <p><b>3 HDMI</b><br/>Connect HDMI signals input.</p> <p><b>4 DisplayPort</b><br/>Connect DisplayPort signals input.</p> <p><b>5 VGA</b><br/>Connect VGA signals input.</p> <p><b>6 AUDIO IN</b><br/>Connect audio signals input (3.5 mm Stereo Audio Jack).</p> <p><b>7 S-VIDEO</b><br/>Connect S-Video signals input.</p> | <p><b>8 COMPOSITE-1/COMPOSITE-2 IN</b><br/>Connect Composite (CVBS) signals input.</p> <p><b>9 COMPOSITE-1/COMPOSITE-2 OUT</b><br/>Connect Composite (CVBS) signals output.</p> <p><b>10 AUDIO IN</b><br/>Connect audio signals input (RCA Stereo Audio Jack).</p> <p><b>11 AUDIO OUT</b><br/>Connect audio signals output (RCA Stereo Audio Jack).</p> <p><b>12 USB (SERVICE)</b><br/>Connect USB 2.0 for service.</p> <p><b>13 RS232</b><br/>Connect RS232 input from external equipment.</p> <p><b>14 GROUNDING STUD</b><br/>Connect to a proper earth ground.</p> |
|--|---|

# TABLE OF CONTENTS

## 2.1 Connecting the Power

- 1 Connect the power cord to the power adapter.
- 2 Connect the power adapter to the DC power input at the rear of the LCD monitor.
- 3 Connect the power cord plug to a power outlet or a power supply.

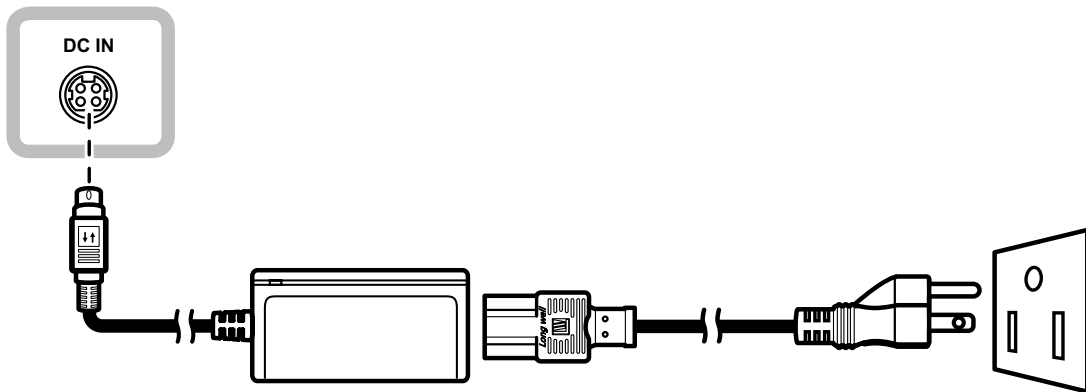
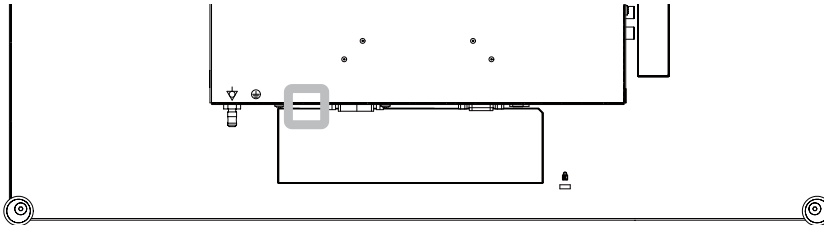

### Note:

- ◆ When removing the power supply, please make sure the plug is unlocked.



### Caution:

- ◆ Make sure that the LCD display is not connected to the power outlet before making any connections. Connecting cables while the power is ON may cause electric shock or personal injury.



### Caution:

- ◆ When unplugging the power cord, hold the power cord by the plug head. Never pull by the cord.

# TABLE OF CONTENTS

## 2.2 Connecting Input Source Signals

### 2.2.1 Connecting a Computer

#### Using VGA Cables

Connect one end of a VGA cable to the VGA connector of the LCD display and the other end to the VGA connector of the computer.

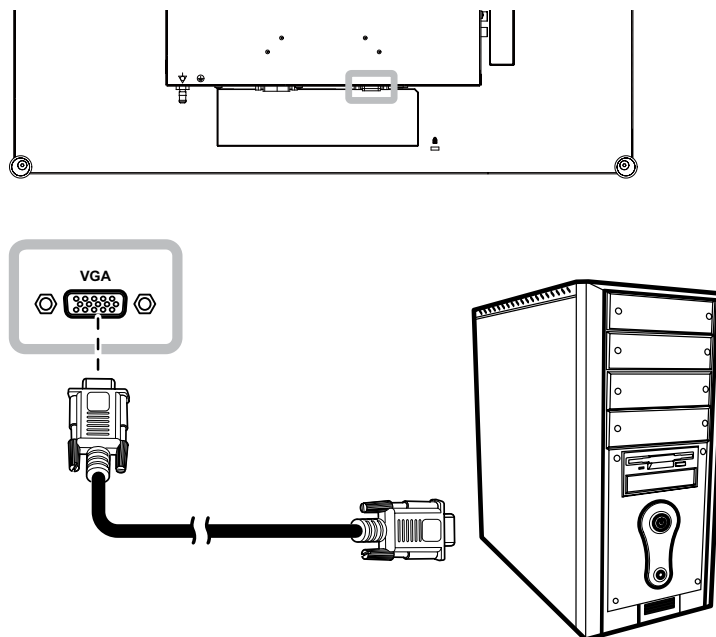

#### Using DVI Cables

Connect one end of a DVI (DVI-D) cable to the DVI connector of the LCD display and the other end to the DVI connector of the computer.

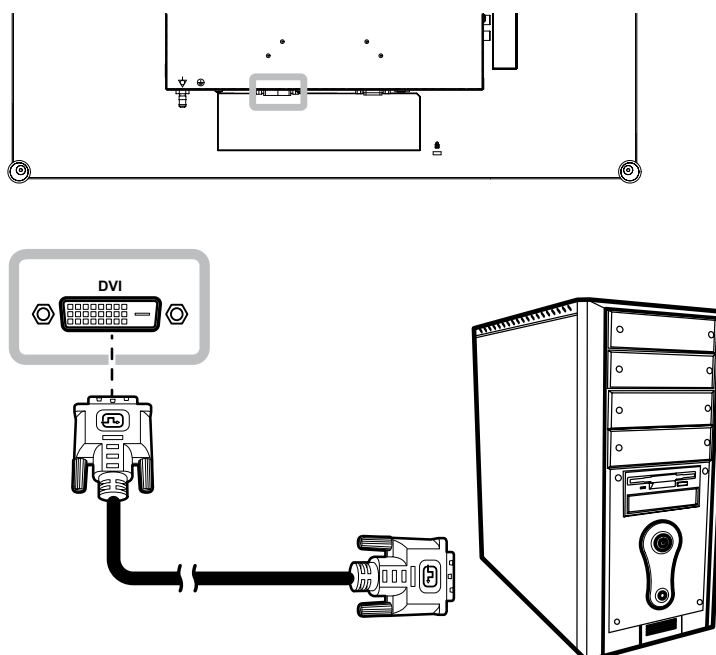

# TABLE OF CONTENTS

## Using HDMI Cables

Connect one end of an HDMI cable to the HDMI connector of the LCD display and the other end to the HDMI connector of the computer.

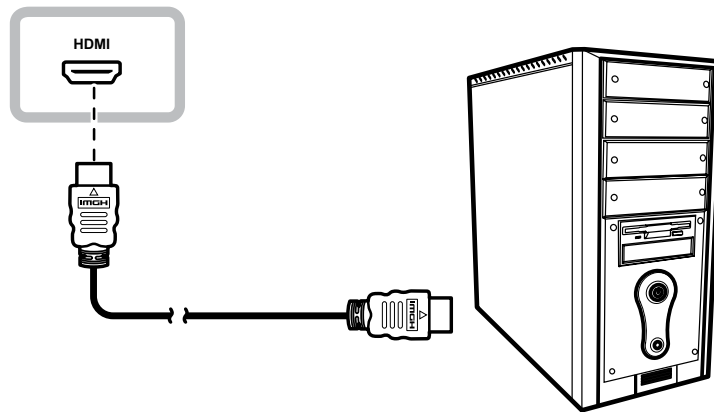
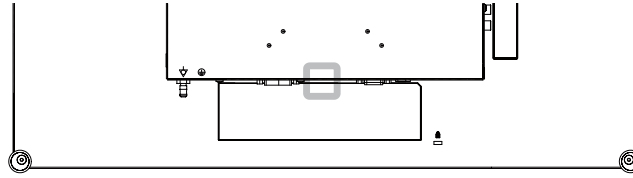

## Using DisplayPort Cables

Connect one end of a DisplayPort cable to the DisplayPort connector of the LCD display and the other end to the DisplayPort connector of the computer.

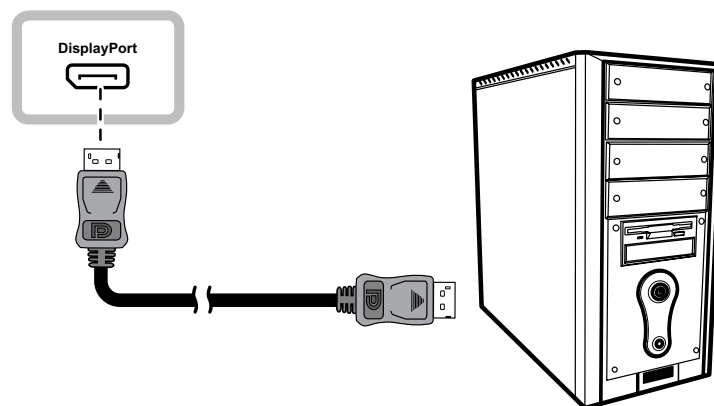
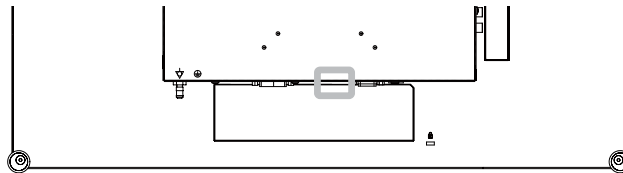



# TABLE OF CONTENTS

## Using RS232 Cables

Connect one end of an RS232 cable to the RS232 connector of the LCD display and the other end to the RS232 connector of the computer.

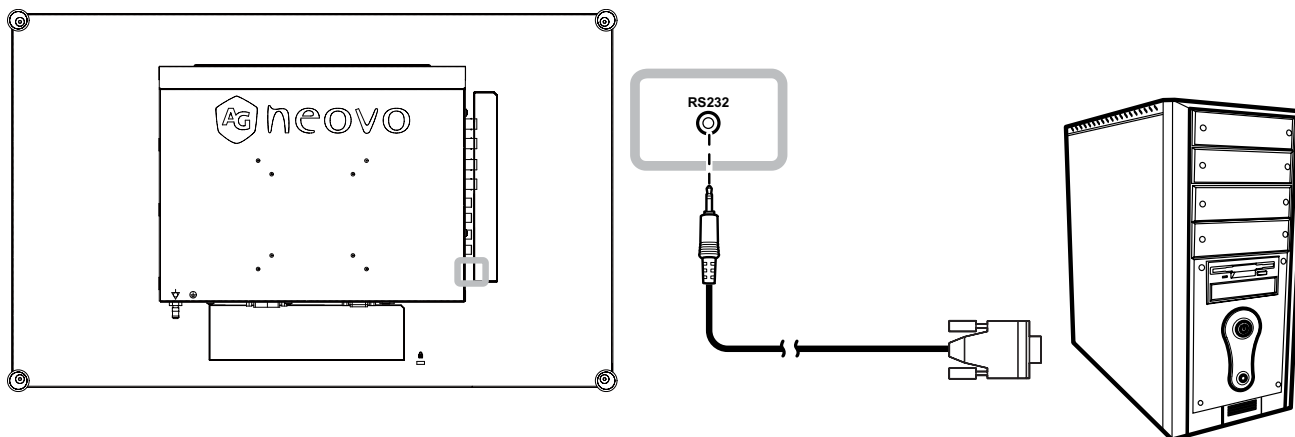

## Using Audio Cables

Connect one end of an audio cable to the AUDIO IN connector at the rear of the LCD display and the other end to the audio out connector of the computer.

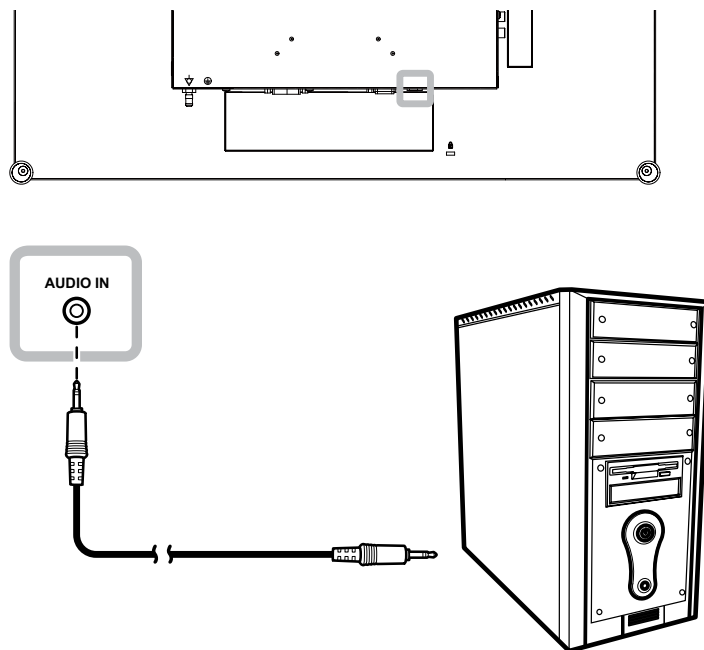

# TABLE OF CONTENTS

## 2.2.2 Connecting a Video Device

### Using Composite (CVBS) Cables

Connect one end of a Composite (CVBS) cable to the COMPOSITE 1 / COMPOSITE 2 IN connector of the LCD display and the other end to the Composite (CVBS) connectors of your device.

For audio input, connect an RCA cable to the AUDIO IN connectors of the LCD display and the audio out connector of your device.

For video looping, connect one end of a Composite (CVBS) cable to the COMPOSITE 1 / COMPOSITE 2 OUT connector of the LCD display and the other end to the COMPOSITE 1 / COMPOSITE 2 IN connector of the additional display.

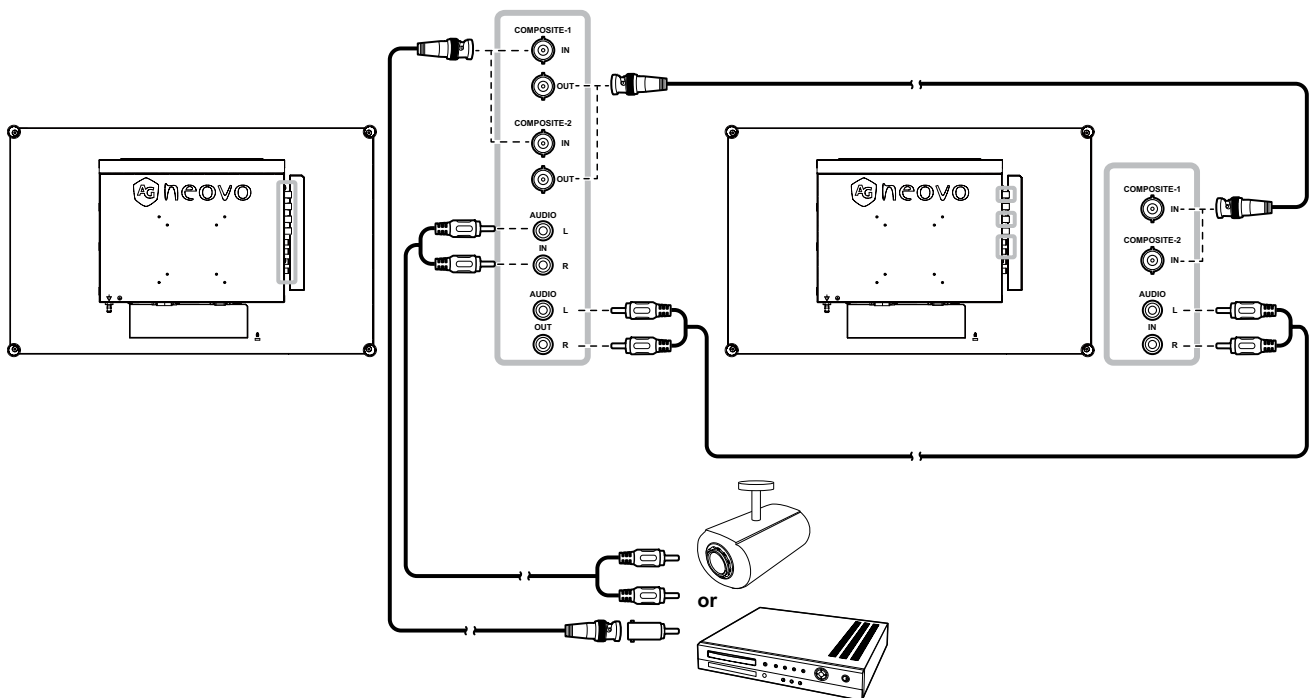

# TABLE OF CONTENTS

## Using S-Video Cables

Connect one end of an S-Video cable to the S-VIDEO connector of the LCD display and the other end to the S-VIDEO connector of your device.

For audio input, connect an RCA cable to the AUDIO IN connectors of the LCD display and the audio out connector of your device.

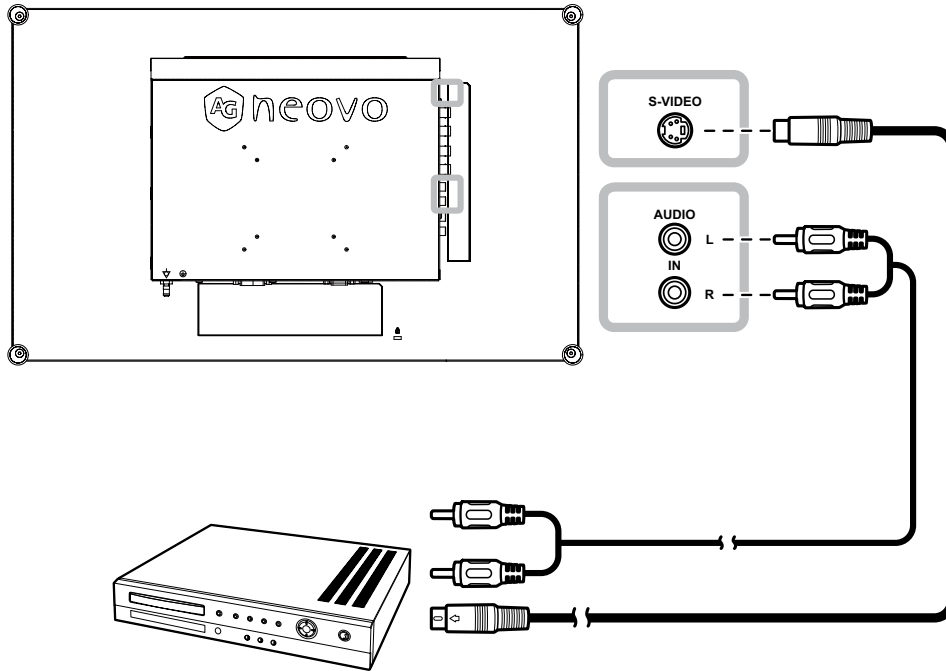

## Using HDMI Cables

Connect one end of an HDMI cable to the HDMI connector of the LCD display and the other end to the HDMI connector of your device.

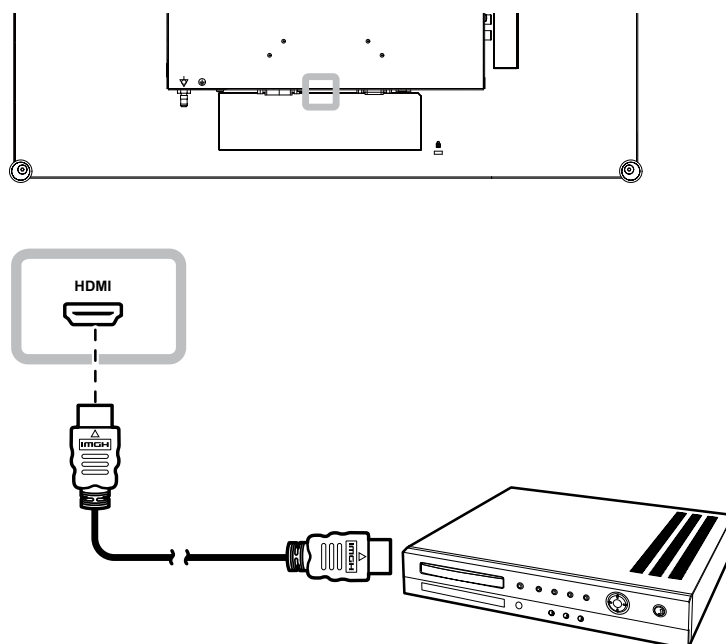

# TABLE OF CONTENTS

## Using DisplayPort Cables

Connect one end of a DisplayPort cable to the DisplayPort connector of the LCD display and the other end to the DisplayPort connector of your device.

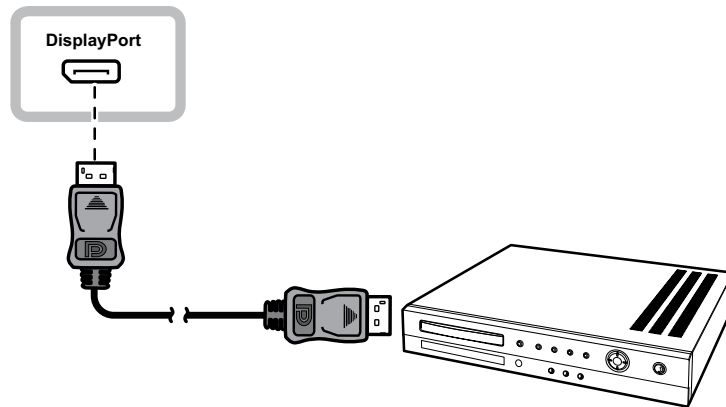
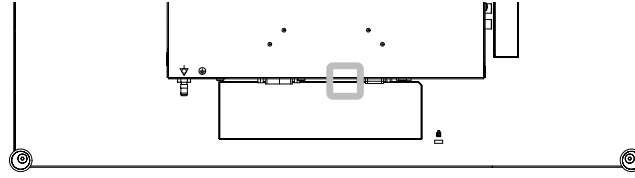

# TABLE OF CONTENTS

## 3.1 Turning on the Power

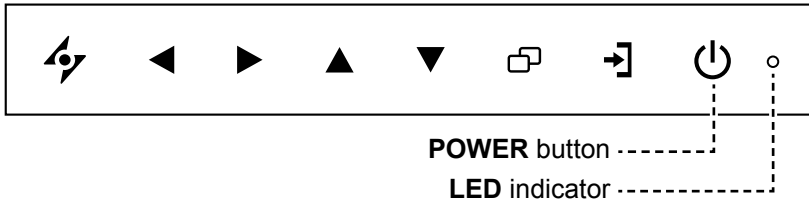

- 1 Connect the power cord to the power adapter. Then connect the power adapter to the DC power input at the rear of the LCD display.
- 2 Press the **POWER** button to turn the LCD display on. The LED indicator turns GREEN. When the LCD display is turned on, press the **POWER** button to turn off the LCD display. The LED indicator turns off.

## 3.2 Selecting the Input Source Signal

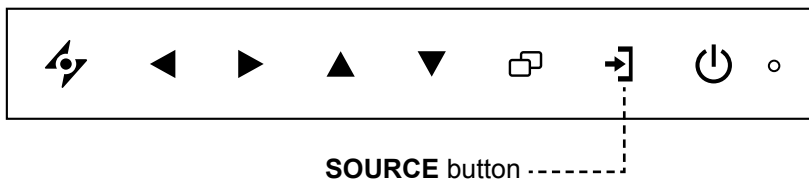

- 1 Press the **→** button to call out the input source menu.



- 2 Press the **▲** or **▼** button to highlight an input source.
- 3 Press the **▶** button to select the input source.

### Note:

- ◆ The LCD display still consumes power as long as the power cord is connected to the power outlet. Disconnect the power cord to completely cut off power.

### Notes:

- ◆ After selecting an input source signal, the input source signal message appears on the screen briefly.

For example, HDMI is selected the following message is displayed.



- ◆ If the selected input source signal is not connected to the LCD display or is turned off, the no signal message is displayed on the screen.



- ◆ If the resolution or the graphics card of the connected computer is set too high, the input out of range message is displayed.



# TABLE OF CONTENTS

## 3.3 Adjusting the Volume / Illuminator Function Hot Key

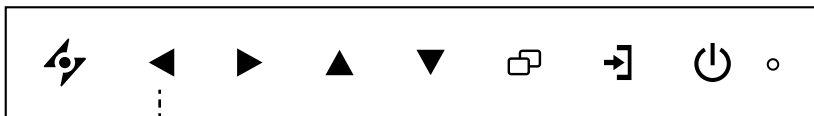

Hot Key: **Audio Volume Adjustment**

- 1 Press the ◀ button to call out the volume bar.



- 2 Press the ▶ button to increase volume or the ◀ button to decrease volume.

### 3.3.1 Muting the Audio

Press the ▶ and ◀ buttons simultaneously to mute or unmute the audio.

### 3.3.2 Illuminator Function Hot Key

Press and hold ◀ and ▶ for 5 seconds to turn the screen completely white to enable you to see the light box for the x-ray film. To change the screen back to normal display mode, press and hold ◀ and ▶ for 5 seconds again.

## 3.4 Choosing Your Preferred Picture Settings

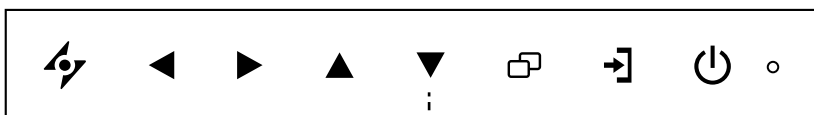

Hot Key: **PICTURE MODE Select**

Press the ▼ button repeatedly to toggle between the picture modes.

Options are as follows:

- STANDARD MODE: Default settings that suits most environments and types of video.
- VIDEO MODE: Settings adjusted for video.
- sRGB MODE: Settings adjusted for sRGB.

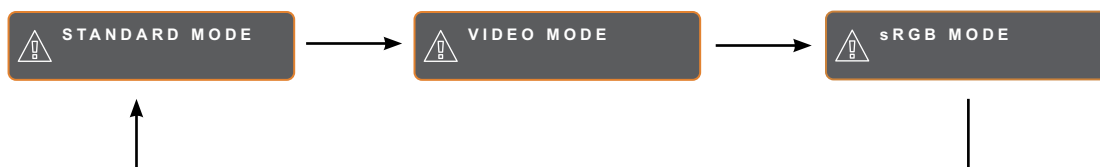

# TABLE OF CONTENTS

## 3.5 Using Picture-in-Picture (PIP)

The Picture-in-Picture (PIP) and Picture-by-Picture (PIP) feature allows viewing of more than one input source signal on the LCD display.

### 3.5.1 PIP/PBP Options

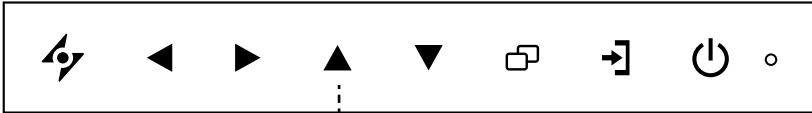

Hot Key: **PIP/PBP Select**

Press the ▲ button repeatedly to enable and scroll among the PIP/PBP options. Options are as follows:

- PIP On: The sub source signal is displayed within the main source signal.
- PBP (Picture-by-Picture): The main source and the sub source signals are displayed side by side with equal display size.
- PIP Off: PIP function is disabled, only the main source signal is displayed.

PIP On



PBP



PIP Off



#### Note:

- ◆ The main source and sub source signals can be set in PIP Setting, see page 39.
- ◆ Some input source signal combinations do not support PIP. See PIP Compatibility table on page 40.

# TABLE OF CONTENTS

## 3.5.2 PIP/PBP Swap

The main and the sub source signals set in PIP/PBP Setting can be easily swapped using the keypad.



Press the ▼ button to swap the main source and the sub source signals. See illustration below.



## 3.6 Using FREEZE Function

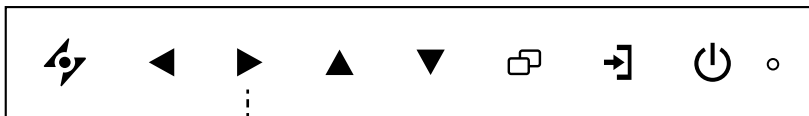

Hot Key: **Screen Freeze**

The FREEZE function allows you to freeze the screen image but still continues real-time playback until the image is unfreeze.

Press the ► button to activate screen freeze, the screen freeze message is displayed on the screen.



You can press any button to deactivate except the **POWER** button.

### Note:

- ◆ PIP/PBP Swap can only be executed if PIP is enabled, see page 39.



# TABLE OF CONTENTS

## 3.7 Using Auto Adjustment Function

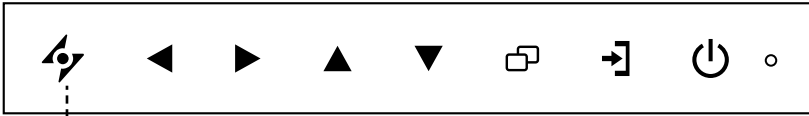

Hot Key: **Auto Adjustment/Rotate**

Auto Adjustment function automatically tunes the LCD display to its optimal setting, including horizontal position, vertical position, clock, and phase.

Press the  button to perform auto adjustment.

The message auto adjusting is displayed on the screen.



During auto adjustment, the screen will slightly shake for a few seconds.

When the message disappears, auto adjustment is completed.

## 3.8 Using ROTATE Function

The ROTATE function allows you to rotate the screen image at 180°.

Press the  button for 3 seconds to rotate the picture 180°.



After ROTATE image

After executing ROTATE, press the  button for 3 seconds again to rotate the picture back to its normal state.



Original screen image

### Note:

- ◆ Auto Adjustment function is available only during VGA input signals.
- ◆ It is recommended to use the auto adjustment function when using the LCD display for the first time or after a resolution or frequency change.
- ◆ It is recommended to perform the Auto Adjustment function only when the image (non-black) is displayed in full screen.

### Note:

- ◆ ROTATE function can only be executed if PIP is off, see page 39.

# TABLE OF CONTENTS

## 3.9 Locking the OSD Menu

Lock the OSD menu to protect the LCD display from unauthorised users or from accidentally pressing the keypad.

To lock the OSD, press and hold the keypad buttons listed below for at least 5 seconds or until the





message appears.

When the OSD is locked, all keypad buttons are inactivated.

Type of OSD Lock	Lock Operation	Unlock Operation
Lock all buttons	Press and hold the ►, ▲, and ▼ buttons simultaneously for 5 seconds.	Do one of the following to unlock: <ul style="list-style-type: none"><li>• Press and hold the ►, ▲, and ▼ buttons simultaneously for 5 seconds or until the OSD menu appears.</li><li>• Press and hold the ◀, ▲, and ▼ buttons simultaneously for 5 seconds or until the OSD menu appears.</li></ul>
Lock all buttons except the <b>POWER</b> button.	Press and hold the ◀, ▲, and ▼ buttons simultaneously for 5 seconds.	

# TABLE OF CONTENTS

## 4.1 Using the OSD Menu

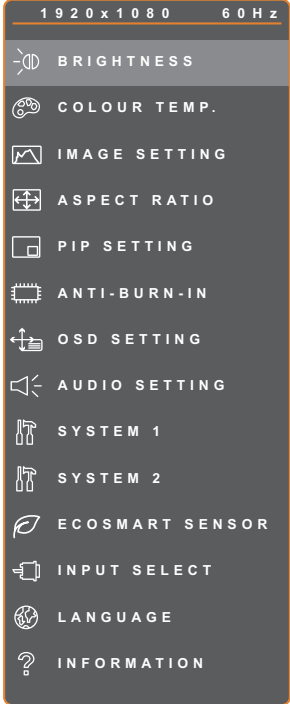
		Operation
<b>1</b>	<p>Display the main menu screen.</p>  <p>Navigation Window</p>	<p>Press the  button.</p>
<b>2</b>	<p>Select the menu.</p> 	<ol style="list-style-type: none"><li>1 Press the ▲ or ▼ button.</li><li>2 Press the ► button to enter the submenu.</li></ol>

# TABLE OF CONTENTS

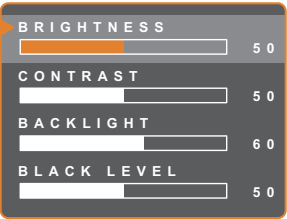
		Operation
<p><b>3</b> Select the submenu item.</p>  <p>The highlighted item with an orange arrow indicates the active submenu.</p>	Press the ▲ or ▼ button.	
<p><b>4</b> Adjust the settings.</p>	Press the ◀ or ▶ button.	
<p><b>5</b> Exit the submenu.</p>	Press the ⚡ or ◻ button to return to the previous menu.	
<p><b>6</b> Close the OSD window.</p>	Press the ⚡ or ◻ button again.	

When settings are modified, all changes are saved when the user does the following:

- Proceeds to the another menu.
- Exits the OSD menu.
- Waits for the OSD menu to disappear.

**Note:** Availability of some menu items depend on the input source signal. If the menu is not available, it is disabled and grayed out.

# TABLE OF CONTENTS

## 4.2 OSD Menu Tree

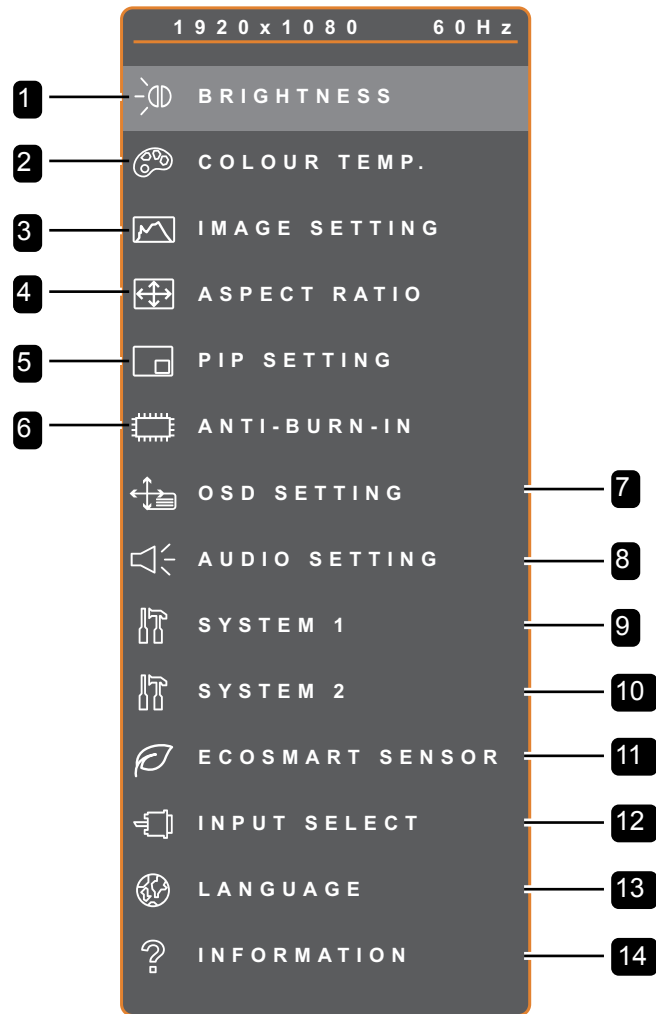

Main Menu	Submenu	Remarks
1. BRIGHTNESS	<ul style="list-style-type: none"> <li>• BRIGHTNESS</li> <li>• CONTRAST</li> <li>• BACKLIGHT</li> <li>• BLACK LEVEL</li> </ul>	See page 32.
2. COLOUR TEMP.	<ul style="list-style-type: none"> <li>• NEUTRAL</li> <li>• WARM</li> <li>• COOL</li> <li>• USER</li> <li>• AUTO COLOUR</li> </ul>	See page 34.

# TABLE OF CONTENTS

Main Menu	Submenu	Remarks
3. IMAGE SETTING	<ul style="list-style-type: none"> <li>• SHARPNESS</li> <li>• SATURATION</li> <li>• TINT</li> <li>• GAMMA</li> <li>• COLOUR RANGE</li> <li>• NOISE REDUCTION</li> <li>• PICTURE MODE</li> <li>• H. POSITION</li> <li>• V. POSITION</li> <li>• PHASE</li> <li>• CLOCK</li> </ul>	See page 35.
4. ASPECT RATIO	<ul style="list-style-type: none"> <li>• FULL</li> <li>• REAL</li> <li>• NATIVE</li> <li>• ZOOM</li> <li>• OVERSCAN</li> </ul>	See page 38.
5. PIP SETTING	<ul style="list-style-type: none"> <li>• PIP</li> <li>• MAIN SOURCE</li> <li>• SUB SOURCE</li> <li>• SUB PICTURE SIZE</li> <li>• SUB PIC. POS.</li> <li>• SWAP</li> </ul>	See page 39.
6. ANTI-BURN-IN	<ul style="list-style-type: none"> <li>• ENABLE</li> <li>• INTERVAL (HOURS)</li> <li>• MODE</li> </ul>	See page 41.
7. OSD SETTING	<ul style="list-style-type: none"> <li>• TRANSPARENCY</li> <li>• OSD H. POSITION</li> <li>• OSD V. POSITION</li> <li>• OSD TIMER</li> </ul>	See page 42.
8. AUDIO SETTING	<ul style="list-style-type: none"> <li>• VOLUME</li> <li>• AUDIO</li> <li>• SOURCE</li> </ul>	See page 43.
9. SYSTEM 1	<ul style="list-style-type: none"> <li>• STANDBY</li> <li>• SOURCE DETECT</li> <li>• DDC/CI</li> <li>• BLUE SCREEN</li> <li>• SIGNAL INFO</li> <li>• Alink</li> <li>• LOGO</li> <li>• LED</li> <li>• RESET</li> </ul>	See page 44.





# TABLE OF CONTENTS

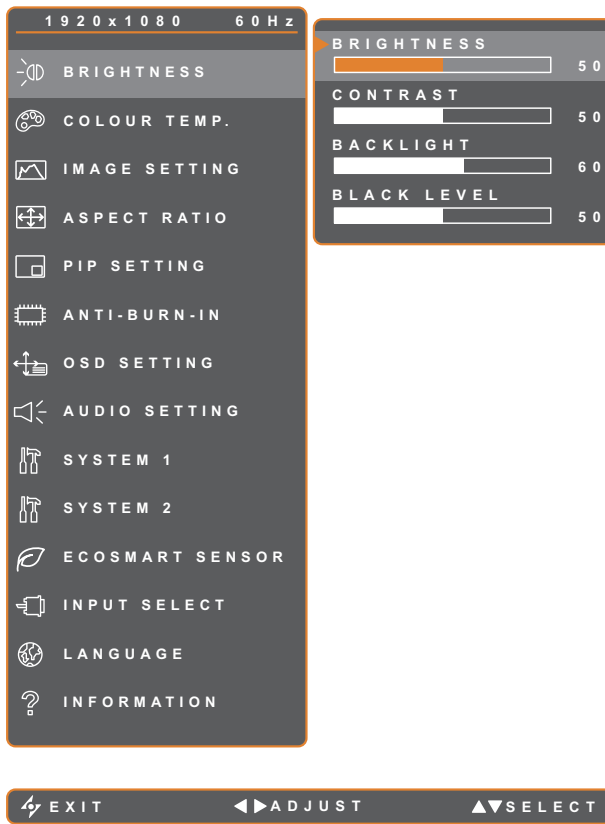

Main Menu	Submenu	Remarks
10. SYSTEM 2	<ul style="list-style-type: none"> <li>• SUPER RESOLUTION</li> <li>• OVERDRIVE</li> <li>• MODE</li> <li>• DCR</li> <li>• LOW POWER</li> <li>• MONITOR ID</li> </ul>	See page 46.
11. ECOSMART SENSOR	<ul style="list-style-type: none"> <li>• ENABLE</li> <li>• MODE</li> <li>• LEVEL</li> </ul>	See page 47.
12. INPUT SELECT	<ul style="list-style-type: none"> <li>• VGA</li> <li>• DVI</li> <li>• HDMI</li> <li>• DISPLAYPORT</li> <li>• COMPOSITE 1</li> <li>• COMPOSITE 2</li> <li>• S-VIDEO</li> </ul>	See page 48.
13. LANGUAGE	Select the OSD language: EN / FR / DE / ES / IT / PY / RO / PL / CS / NL / 简中 / 繁中	
14. INFORMATION	Displays settings information such as Input, Resolution, Horizontal Frequency, Vertical Frequency, Timing Mode, and Firmware Version.	

# TABLE OF CONTENTS

## 5.1 Brightness



1. Press the  button to call out the OSD window.
2. Select **BRIGHTNESS** menu, then press the  button.
3. Press the  or  button to select an option.

Item	Function	Operation	Range
BRIGHTNESS	Adjusts the luminance of the screen image.	Press the  or  button to adjust the value.	0 to 100
CONTRAST	Adjusts the difference between the black level and the white level.		
BACKLIGHT	Adjusts the luminance of the screen image. <b>Note:</b> This menu option is not available if the ECOSMART SENSOR function is enabled.		
BLACK LEVEL	Adjusts the black level of the screen image. Low brightness setting makes black colour darker.		

See comparison illustrations on page 33.



# TABLE OF CONTENTS

	Original Setting	High Setting	Low Setting
BRIGHTNESS			
CONTRAST			
BLACK LEVEL			

# TABLE OF CONTENTS

## 5.2 Colour Temp.



1. Press the button to call out the OSD window.
2. Select **COLOUR TEMP.** menu, then press the button.
3. Press the or button to select an option.



Item	Function	Operation	Range
COLOUR TEMP.	Provides several colour settings.	Press the  or  button to select the setting.	NEUTRAL WARM COOL USER AUTO COLOUR
	Colour setting can be set to: <ul style="list-style-type: none"> <li>• <b>NEUTRAL</b> - commonly used for normal lighting conditions.</li> <li>• <b>WARM</b> - Applies a reddish tint for warmer colours.</li> <li>• <b>COOL</b> - Applies a bluish tint for cooler colours.</li> <li>• <b>USER</b> - This allows users to set the colour temperature by adjusting the R, G, B settings according to one's preference.               <ol style="list-style-type: none"> <li>1 Select <b>USER</b>, and press the  button.</li> <li>2 Press the  or  button to select the colour you want to adjust.</li> <li>3 Press the  or  button to adjust the values between 0 ~ 255.</li> </ol> </li> <li>• <b>AUTO COLOUR</b> - Operates the white balance and automatically adjusts the colour settings.               <ol style="list-style-type: none"> <li>1 Select <b>AUTO COLOUR</b>.</li> <li>2 Press the  button to activate auto colour.</li> </ol> </li> </ul> <p><b>Note:</b> This menu option is only available if the input source is VGA.</p> <p><b>Note:</b> Activate <b>RESET</b> to return the colour to its default setting.</p>		

# TABLE OF CONTENTS



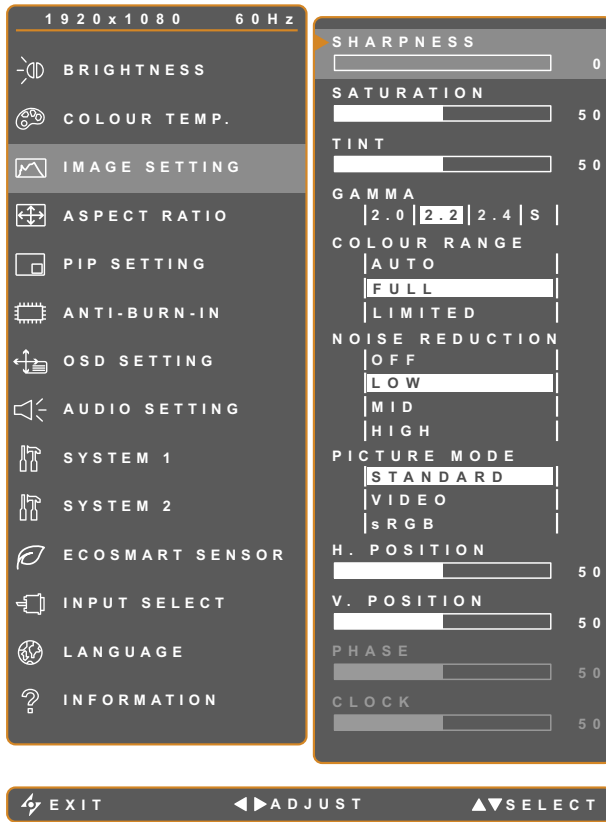

## 5.3 Image Setting

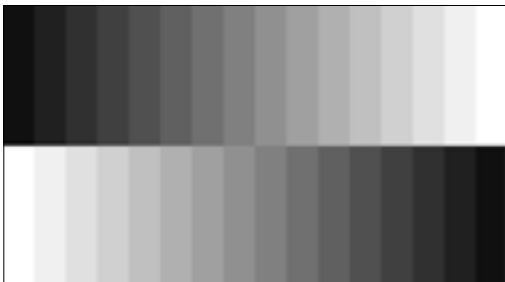
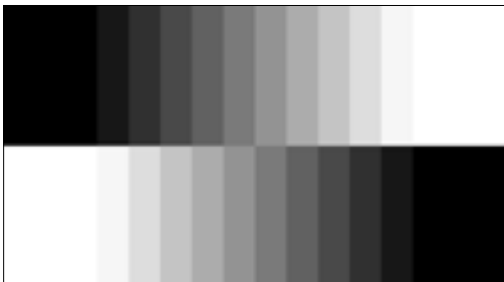
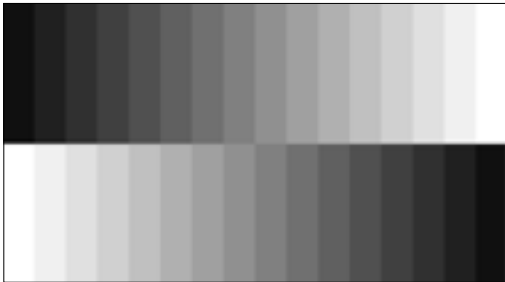

1. Press the button to call out the OSD window.
2. Select **IMAGE SETTING** menu, then press the button.
3. Press the or button to select an option.

Item	Function	Operation	Range
SHARPNESS	Adjusts the clarity and focus of the screen image.	Press the  or  button to adjust the value.	0 to 100
SATURATION	Adjusts the colour saturation.		
TINT	Adjusts the colour tint.		
GAMMA	Adjusts the non-linear setting for picture luminance and contrast.	Press the  or  button to select the setting.	2.0 2.2 2.4 S
	<div style="display: flex; justify-content: space-around; margin-top: 5px;"> <div style="text-align: center;"> <p>Display Gamma 2.0</p> </div> <div style="text-align: center;"> <p>Display Gamma 2.2</p> </div> <div style="text-align: center;"> <p>Display Gamma 2.4</p> </div> <div style="text-align: center;"> <p>Display Gamma S</p> </div> </div>		

# TABLE OF CONTENTS

Item	Function	Operation	Range	
COLOUR RANGE	Adjusts black and white levels for video. <b>Note:</b> This menu option is only available if the input source is HDMI.	Press the ◀ or ▶ button to select the setting.	AUTO FULL LIMITED	
	Signal source from PC - PC signal at a full range (Grayscale 0-255) state:			
				
	Monitor OSD colour range: Full *Please select	Monitor OSD colour range: Limited		
NOISE REDUCTION	Adjusts the noise reduction to help remove noise from images. This helps produce clearer and crisper images.	Press the ◀ or ▶ button to select the setting.	OFF LOW MID HIGH	
	Signal source from Video - Video signal at a limited range (Grayscale 16~235) state:			
				
	Monitor OSD colour range: Limited *Please select	Monitor OSD colour range: Full		
NOISE REDUCTION				
	Noise Reduction Off	Noise Reduction On		

# TABLE OF CONTENTS

Item	Function	Operation	Range
PICTURE MODE	<p>Selects a predefined picture mode setting.</p> <p><b>Note:</b> When the setting is set to sRGB, the BRIGHTNESS, CONTRAST, BLACK LEVEL, COLOR TEMP., and SATURATION functions will be disabled.</p>	Press the ◀ or ▶ button to select the setting.	STANDARD VIDEO sRGB
H. POSITION (Horizontal Position)	Moves the screen image to the left or right.	Press the ◀ or ▶ button to adjust the value.	0 to 100
V. POSITION (Vertical Position)	Moves the screen image up or down.		
PHASE	<p>Adjusts the phase timing to synchronise with the video signal.</p> <p><b>Note:</b> This menu option is only available if the input source is VGA.</p>		
CLOCK	<p>Adjusts the frequency timing to synchronise with the video signal.</p> <p><b>Note:</b> This menu option is only available if the input source is VGA.</p>		

# TABLE OF CONTENTS

## 5.4 Aspect Ratio

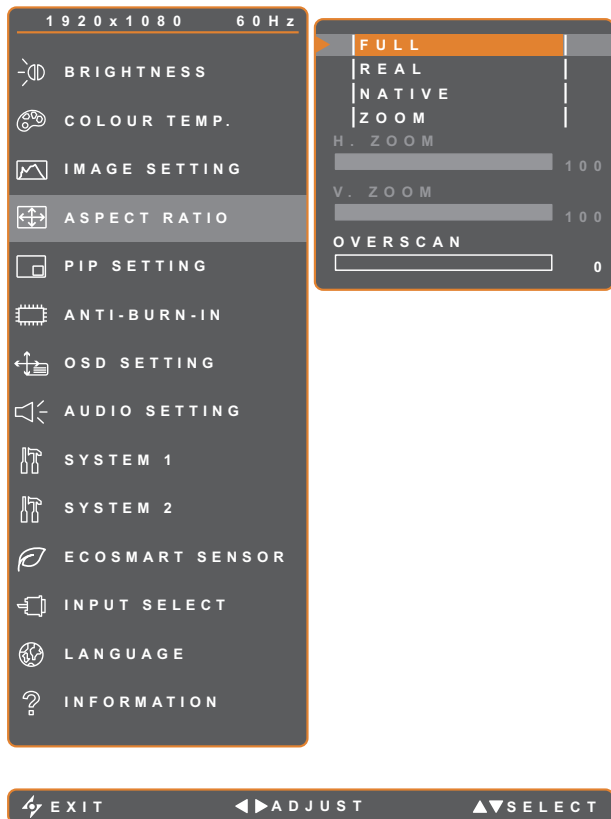





1. Press the button to call out the OSD window.
2. Select **ASPECT RATIO** menu, then press the button.
3. Press the or button to select an option.

Item	Function	Operation	Range
ASPECT RATIO	Adjusts the aspect ratio of the screen image.	Press the  or  button to select the setting.	FULL REAL NATIVE ZOOM OVERSCAN
	<p>The aspect ratio setting can be set to:</p> <ul style="list-style-type: none"> <li>• <b>FULL</b> - Enlarges the picture to fill the screen.</li> <li>• <b>REAL</b> - Displays the picture at its original size.</li> <li>• <b>NATIVE</b> - Enlarges the picture but retain its original aspect ratio.</li> <li>• <b>ZOOM</b> - Sets a custom aspect ratio by adjusting the horizontal zoom(H. ZOOM) and /or vertical zoom(V.ZOOM) according to your preference.               <ol style="list-style-type: none"> <li>1 Select <b>ZOOM</b>, and press the  button.</li> <li>2 Press the  or  button to select the zoom parameter you want to adjust.</li> <li>3 Press the  or  button to adjust the values between 0 ~ 100.</li> </ol> </li> <li>• <b>OVERSCAN</b> - Adjusts the overscan setting to fix the cut-off screen edges. Press the  or  button to adjust the values between 0 ~ 100.</li> </ul>		

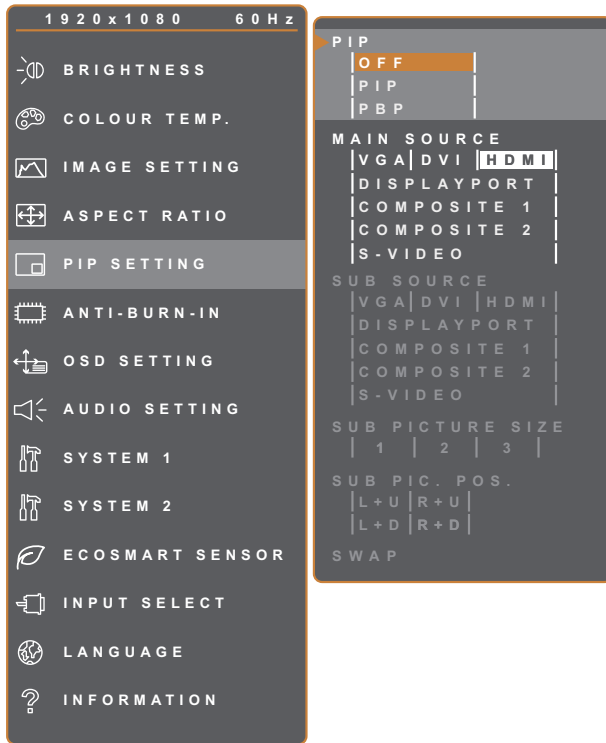



# TABLE OF CONTENTS

## 5.5 PIP Setting



1. Press the  button to call out the OSD window.
2. Select **PIP SETTING** menu, then press the  button.
3. Press the  or  button to select an option.



Item	Function	Operation	Range
PIP	Allows you to select the PIP setting or disable PIP.	Press the  or  button to select the value.	OFF PIP PBP
	PIP can be set to: <ul style="list-style-type: none"> <li>• <b>OFF</b> - Disables PIP.</li> <li>• <b>PIP</b> - The sub source image is within the main source image.</li> <li>• <b>PBP</b> - The main source and sub source images are displayed side by side.</li> </ul>		
MAIN SOURCE	Allows you to select the main source signal.	Press the  or  button to select the setting.	VGA DVI HDMI
SUB SOURCE	Allows you to select the sub source signal.		DISPLAYPORT COMPOSITE 1 COMPOSITE 2 S-VIDEO

# TABLE OF CONTENTS

**Note:** Any input signal may be set as the main or the sub source signal. However, some input signals are not supported to be paired together as the main and the sub source signals.

Refer to the following table for compatibility options:

Input Source		Main Source						
		VGA	DVI	HDMI	DISPLAYPORT	COMPOSITE 1	COMPOSITE 2	S-VIDEO
Sub Source	VGA	X	O	O	O	O	O	O
	DVI	O	X	O	O	O	O	O
	HDMI	O	O	X	O	O	O	O
	DISPLAYPORT	O	O	O	X	O	O	O
	COMPOSITE 1	O	O	O	O	X	X	X
	COMPOSITE 2	O	O	O	O	X	X	X
	S-VIDEO	O	O	O	O	X	X	X





Item	Function	Operation	Range
SUB PICTURE SIZE (Sub Picture Size)	Allows you to select the size of the sub source image. <b>Note:</b> This menu option is only available if the <b>PIP</b> setting is to <b>PIP</b> .	Press the ◀ or ▶ button to select the setting.	1 2 3
	The size of the sub source image can be set to: <ul style="list-style-type: none"> <li>• <b>1</b> - Small image size.</li> <li>• <b>2</b> - Medium image size.</li> <li>• <b>3</b> - Large image size.</li> </ul>		
SUB PIC. POS. (Sub Picture Position)	Allows you to select the position of the sub source image. <b>Note:</b> This menu option is only available if the <b>PIP</b> setting is to <b>PIP</b>	Press the ◀ or ▶ button to select the setting.	L+U R+U L+D R+D
	The position of the sub source image can be set to: <ul style="list-style-type: none"> <li>• <b>L+U</b> - Sets the image on the upper left corner of the screen.</li> <li>• <b>R+U</b> - Sets the image on the upper right corner of the screen.</li> <li>• <b>L+D</b> - Sets the image on the lower left corner of the screen.</li> <li>• <b>R+D</b> - Sets the image on the lower right corner of the screen.</li> </ul>		
SWAP	Swaps the main source and sub source signals.	Press the ▶ button to execute the function.	-



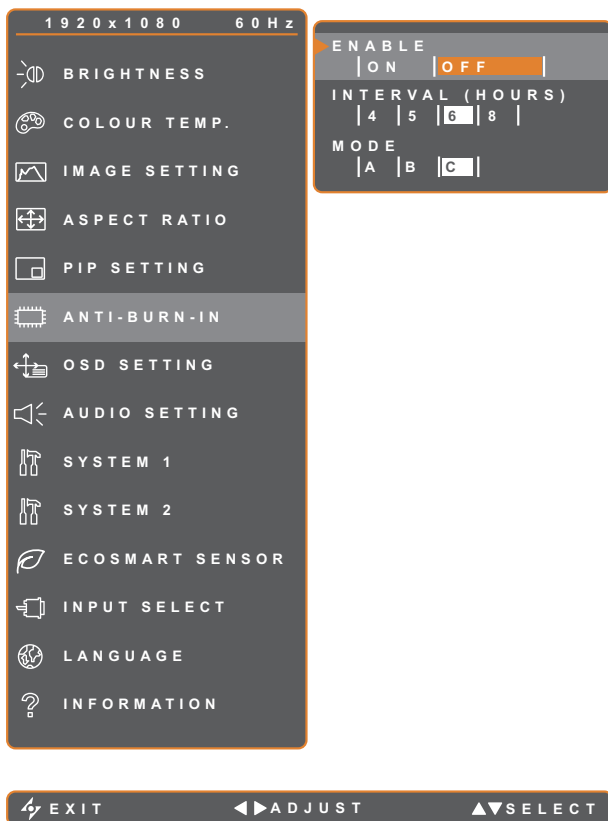





# TABLE OF CONTENTS

## 5.6 Anti-Burn-in







1. Press the  button to call out the OSD window.
2. Select **ANTI-BURN-IN** menu, then press the  button.
3. Press the  or  button to select an option.

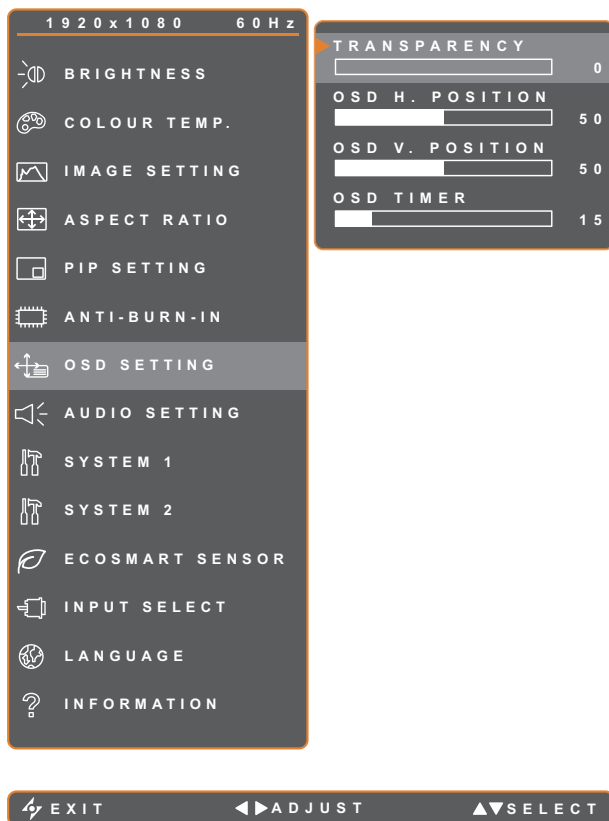

Item	Function	Operation	Range
ENABLE	Enables or disables Anti-Burn-In function.	Press the  or  button to select the setting.	ON OFF
INTERVAL (HOURS)	Sets the interval time (hour) between activating the Anti-Burn-In function.	Press the  or  button to adjust the value.	4 5 6 8
MODE	Selects the Anti-Burn-In mode.	Press the  or  button to select the setting.	A B C
	Anti-Burn-In mode can be set to: <ul style="list-style-type: none"> <li>• <b>A</b> - Executes fast.</li> <li>• <b>B</b> - Slower but more precise than mode A.</li> <li>• <b>C</b> - Slowest but the most precise anti-burn-in mode.</li> </ul>		

# TABLE OF CONTENTS

## 5.7 OSD Setting







1. Press the  button to call out the OSD window.
2. Select **OSD SETTING** menu, then press the  button.
3. Press the  or  button to select an option.

Item	Function	Operation	Range
TRANSPARENCY	Adjusts the transparency level of the OSD screen.	Press the  or  button to adjust the value.	0 to 100
OSD H. POSITION (Horizontal Position)	Moves the OSD window to the left or right of the screen.		
OSD V. POSITION (Vertical Position)	Moves the OSD window up or down the screen.		
OSD TIMER	Sets the length of time (in seconds) the OSD screen is displayed. When the time elapses, the OSD screen is automatically inactivated.		5 to 100

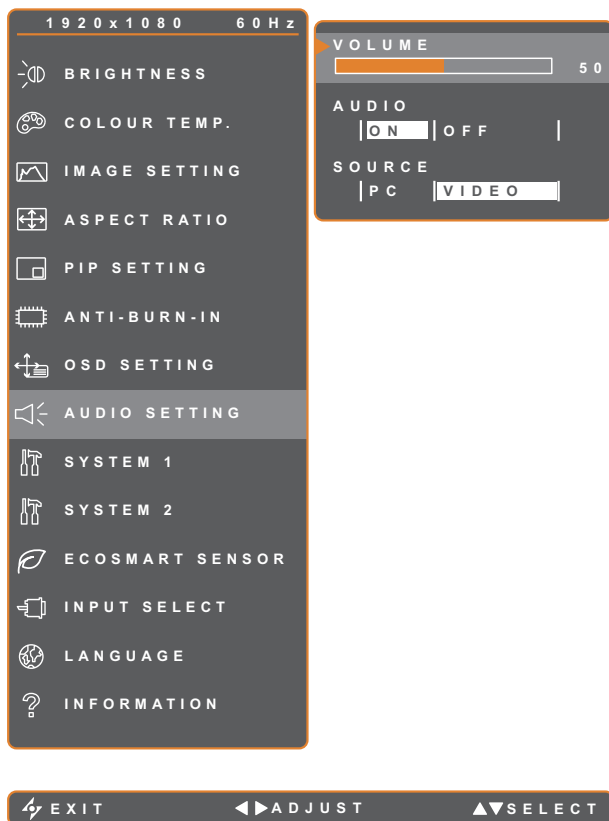
# TABLE OF CONTENTS

## 5.8 Audio Setting







1. Press the  button to call out the OSD window.
2. Select **AUDIO SETTING** menu, then press the  button.
3. Press the  or  button to select an option.

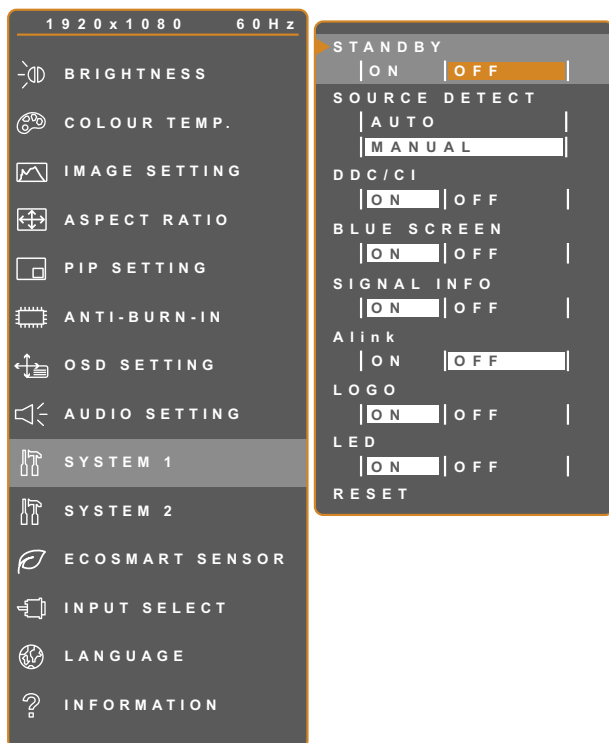

Item	Function	Operation	Range
VOLUME	Adjusts the volume level of the built-in speaker.	Press the ◀ or ▶ button to adjust the value.	0 to 100
AUDIO	Turns the audio ON or OFF.	Press the ◀ or ▶ button to select the setting.	ON OFF
SOURCE	Selects the audio source for the PC or Video input signal. <b>Note:</b> This menu option is only available if the input source is HDMI or DisplayPort.		PC VIDEO

# TABLE OF CONTENTS

## 5.9 System 1



1. Press the  button to call out the OSD window.
2. Select **SYSTEM 1** menu, then press the  button.
3. Press the  or  button to select an option.

Item	Function	Operation	Range
STANDBY	<p>Enables or disables standby mode.</p> <p>When the LCD display turns into standby mode, the screen turns black and the LED indicator lights AMBER.</p> <p><b>Note:</b> The amount of time for the display to enter standby varies depending on the SOURCE DETECT setting. If the SOURCE DETECT is set to AUTO, the display checks all input source signals before entering standby mode if no signal is detected; this takes up more time. If the SOURCE DETECT is set to MANUAL, the display enters standby mode right away.</p>	Press the  or  button to select the setting.	ON OFF
SOURCE DETECT	Sets the display to automatically or manually detect the input source signal.		AUTO MANUAL





# TABLE OF CONTENTS





Item	Function	Operation	Range
DDC/CI	Activates the DDC/CI protocol to allow users to configure the monitor by a software using two wires on the VGA, HDMI, DisplayPort, or DVI cables.		
BLUE SCREEN	Enables or disables the blue screen feature. If the setting is set to <b>ON</b> , it displays a blue screen when no signal is available.		
SIGNAL INFO	Enables or disables the signal information to be displayed on the screen.		
Alink	Enables or disables HDMI Consumer Electronics Control control. If the setting is set to <b>On</b> , you can control the connected HDMI-CEC compatible device on the same power on or power off status. <b>Note:</b> This menu option is only available if the input source is HDMI.	Press the ◀ or ▶ button to select the setting.	ON OFF
LOGO	Enables or disables the logo feature. If the setting is set to <b>ON</b> , the AG Neovo logo is briefly displayed after the display is powered on.		
LED	Sets the display LED indicator on or off.		
RESET	Use to reset all to default settings, except Language, and the input source.	Press the ▶ button to execute the function.	-

# TABLE OF CONTENTS

## 5.10 System 2



1. Press the  button to call out the OSD window.
2. Select **SYSTEM 2** menu, then press the  button.
3. Press the  or  button to select an option.

Item	Function	Operation	Range
SUPER RESOLUTION	Upscales images at a higher and more detailed resolution for better clearness.		OFF LOW MID HIGH
OVERDRIVE	Enhances the display response time.		
DCR (Dynamic Contrast Ratio)	Activates DCR. This feature provides automatic adjustment of picture brightness and contrast at high speed and dynamic contrast range, such as when watching movies. DCR is suitable for indoor viewing. <b>Note:</b> When the DCR function is activated, the BACKLIGHT and ECOSMART SENSOR function will be disabled.	Press the  or  button to select the setting.	ON OFF
MONITOR ID	Sets the ID number for controlling the display via the RS232 connection. Each display must have a unique ID number when multiple sets of this display are connected.	Press the  or  button to set the ID.	1~255





# TABLE OF CONTENTS

## 5.11 EcoSmart Sensor

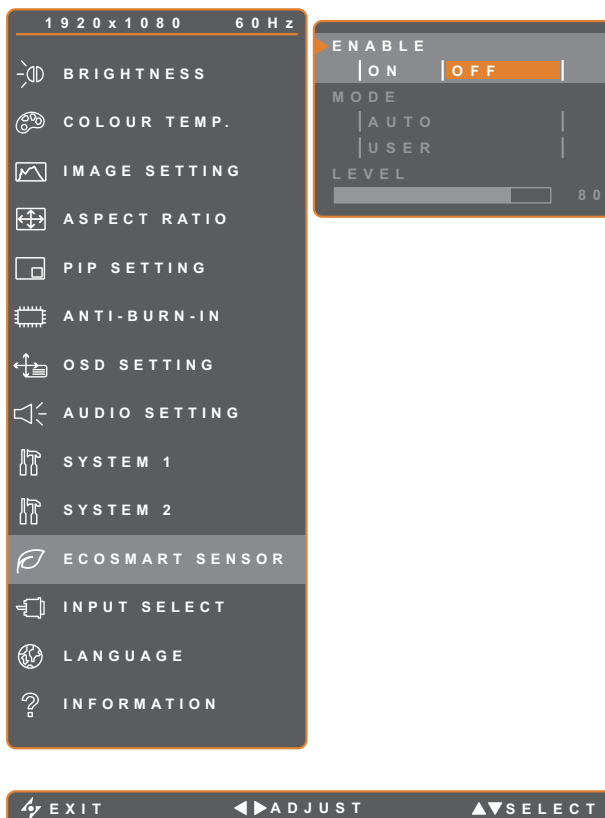
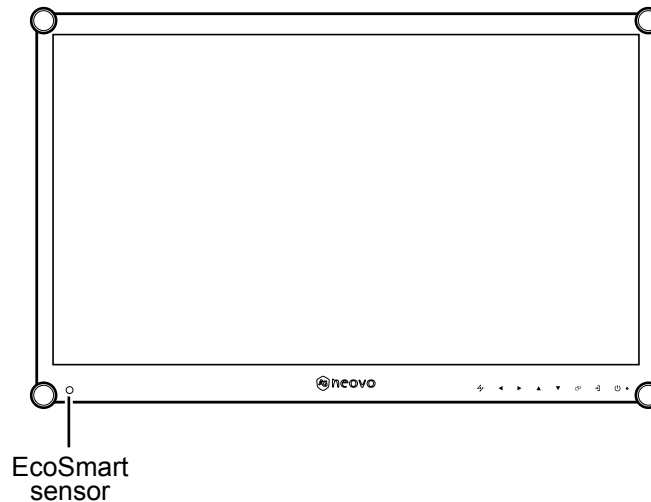
With the built-in EcoSmart sensor, users can enable the Eco Smart feature to automatically adjust the LCD screen brightness according to the ambient light. This feature comforts the eyes and helps optimise energy efficiency.

**Note:** Please make sure the EcoSmart sensor is not covered when enabling this function.



1. Press the  button to call out the OSD window.
2. Select **ECOSMART SENSOR** menu, then press the  button.
3. Press the  or  button to select an option.

# TABLE OF CONTENTS





Item	Function	Operation	Value
ENABLE	Enables or disables the Eco Smart feature.	Press the ◀ or ▶ button to select the setting.	ON OFF
MODE	Sets the auto brightness mode.	Press the ◀ or ▶ button to select the setting.	AUTO USER
	The mode can be set to: <ul style="list-style-type: none"> <li>• <b>AUTO</b> - This mode is the default mode. The LCD brightness automatically adjusts to the ambient brightness.</li> <li>• <b>USER</b> - Allows you to manually adjust the LCD brightness.</li> </ul>		
LEVEL	Allows you to set the level of LCD brightness. <b>Note:</b> This menu option is only available if the <b>MODE</b> setting is to <b>USER</b> .	Press the ◀ or ▶ button to adjust the value.	0 to 100

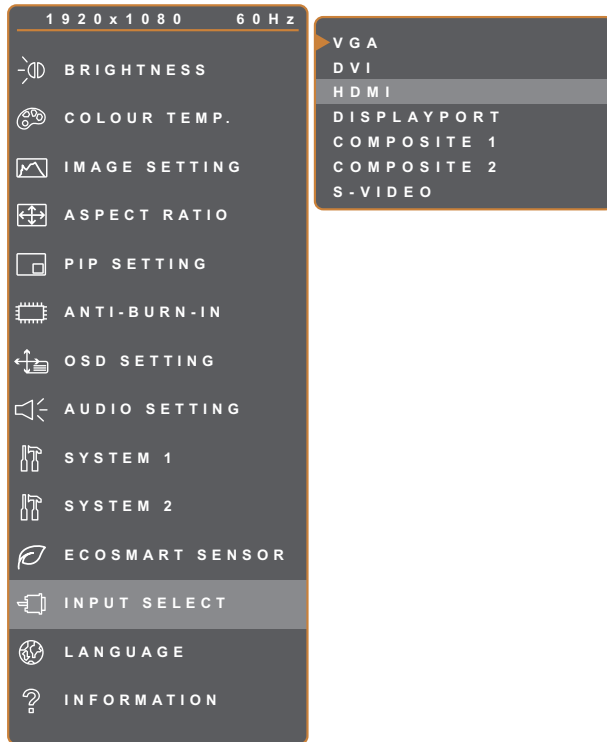

# TABLE OF CONTENTS

## 5.12 Input Select







1. Press the  button to call out the OSD window.
2. Select **INPUT SELECT** menu, then press the  button.
3. Press the  or  button to select an option.

Item	Function	Operation	Value
VGA	Sets VGA as the input source signal.	Press the  button to switch to the selected input source.	-
DVI	Sets DVI as the input source signal.		
HDMI	Sets HDMI as the input source signal.		
DISPLAYPORT	Sets DisplayPort as the input source signal.		
COMPOSITE 1	Sets COMPOSITE 1 as the input source signal.		
COMPOSITE 2	Sets COMPOSITE 2 as the input source signal.		
S-VIDEO	Sets S-VIDEO as the input source signal.		

# TABLE OF CONTENTS

## 6.1 Warning Messages

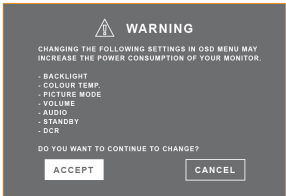
Warning Messages	Cause	Solution
	The resolution or the refresh rate of the graphics card of the computer is set too high.	<ul style="list-style-type: none"> <li>Change the resolution or the refresh rate of the graphics card.</li> </ul>
	The LCD display cannot detect the input source signal.	<ul style="list-style-type: none"> <li>Check if the input source is turned ON.</li> <li>Check if the signal cable is properly connected.</li> <li>Check if any pin inside the cable connector is twisted or broken.</li> </ul>
	The OSD has been locked by the user.	<ul style="list-style-type: none"> <li>Unlock the OSD. Refer to page 50.</li> </ul>
	The Anti-Burn-In function has been enabled by the user.	<ul style="list-style-type: none"> <li>Disable the Anti-Burn-In function. Refer to page 50.</li> </ul>
	The Anti-Burn-In function has been disabled by the user.	<ul style="list-style-type: none"> <li>Enable the Anti-Burn-In function. Refer to page 50.</li> </ul>
	This warning message box will only show when the menu feature setting is changed for the first time.	<ul style="list-style-type: none"> <li>Press the ACCEPT button to continue the setting changes, or press the CANCEL button to disable the setting changes.</li> <li>Note: The operation may vary from different product models.</li> </ul>

# TABLE OF CONTENTS

## 6.2 Supported Resolutions

PC Mode	Resolution		Refresh Rate
	Horizontal	Vertical	
IBM VGA	720	400	70
IBM VGA	640	480	60
Apple Mac II	640	480	67
VESA	640	480	72
VESA	640	480	75
VESA	800	600	56
VESA	800	600	60
VESA	800	600	72
VESA	800	600	75
Apple Mac II	832	624	75
VESA	1024	768	60
VESA	1024	768	70
VESA	1024	768	75
VESA	1280	1024	60
VESA	1280	1024	75
Apple Mac II	1152	870	75
VESA	1152	864	75
VESA	1280	800	60
VESA	1280	800	75
VESA	1280	960	60
VESA	1440	900	60
VESA	1680	1050	60
VESA	1920	1080	60

Video Mode	Resolution		Refresh Rate
	Horizontal	Vertical	
EDTV	720	480	60i
EDTV	720	480	60
EDTV	720	576	50i
EDTV	720	576	50
HDTV	1280	720	50
EDTV	1280	720	60
HDTV	1920	1080	50i
HDTV	1920	1080	50
HDTV	1920	1080	60i

# TABLE OF CONTENTS

Video Mode	Resolution		Refresh Rate
	Horizontal	Vertical	
HDTV	1920	1080	60
HDTV	1920	1080	24
HDTV	1920	1080	25
HDTV	1920	1080	30

## 6.3 Troubleshooting

Problem	Possible Cause and Solution
<p>No picture.</p> <ul style="list-style-type: none"> <li>LED indicator is OFF.</li> </ul>	<ul style="list-style-type: none"> <li>Check if the LCD display is turned ON.</li> <li>Check if the power cord is properly connected to the LCD display.</li> <li>Check if the power cord is plugged into the power outlet.</li> </ul>
<ul style="list-style-type: none"> <li>LED indicator is AMBER.</li> </ul>	<ul style="list-style-type: none"> <li>Check if the computer is turned ON.</li> <li>Check if the computer is in standby mode, move the mouse or press any key to wake up the computer.</li> </ul>
Image position is incorrect.	<ul style="list-style-type: none"> <li>Adjust the H. POSITION and V. POSITION values. See IMAGE SETTING on page 35.</li> </ul>
The displayed texts are blurry.	<ul style="list-style-type: none"> <li>For VGA input, press the  button on the keypad to auto-adjust the display.</li> <li>Adjust the IMAGE SETTING (see page 35).</li> </ul>
The OSD menu can't be called out.	<ul style="list-style-type: none"> <li>The OSD is locked. To unlock the OSD, see page 26.</li> </ul>
Red, blue, green, white dots appear on screen.	<ul style="list-style-type: none"> <li>There are millions of micro transistors inside the LCD display. It is normal for a few transistors to be damaged and to produce spots. This is acceptable and is not considered a failure.</li> </ul>
No audio output.	<ul style="list-style-type: none"> <li>Check if the volume is set to 0 (see page 22 or 43).</li> <li>Check if the <b>AUDIO SETTING &gt; AUDIO</b> setting is set to <b>OFF</b> (see page 43).</li> <li>For VGA or DVI input, check the audio setting of the computer.</li> <li>For HDMI or DisplayPort input, select the correct audio input source (see page 43).</li> </ul>
PIP mode does not work.	<ul style="list-style-type: none"> <li>The main and sub input source signals are not compatible to be displayed together in PIP mode. Check the PIP Compatibility Table for details (see page 40).</li> </ul>

# TABLE OF CONTENTS

Problem	Possible Cause and Solution
Cannot adjust the backlight setting.	<ul style="list-style-type: none"> <li>The Eco Smart feature is enabled. Set the <b>ECOSMART SENSOR &gt; ENABLE</b> setting to <b>OFF</b> to disable the Eco Smart feature (see page 47).</li> </ul>
The displayed picture looks distorted.	<ul style="list-style-type: none"> <li>Adjust the aspect ratio (see page 38).</li> </ul>
Dew formed on or inside the LCD display.	<ul style="list-style-type: none"> <li>This normally happens when the LCD display is moved a cold room to a hot room temperature. Do not turn ON the LCD display, wait for the dew condensation to disappear.</li> </ul>
Mist formed inside the glass surface.	<ul style="list-style-type: none"> <li>This happens due to humid weather conditions. This is a normal occurrence. The mist will disappear after a few days or as soon as the weather stabilizes.</li> </ul>
Faint shadows from a static image appear on the screen.	<ul style="list-style-type: none"> <li>Turn off the LCD display for extended periods of time.</li> <li>Use a screen saver or a black and white image and run it for extended periods of time.</li> </ul>

# TABLE OF CONTENTS

## 6.4 Transporting the LCD Display

To transport the LCD display for repair or shipment, place the display in its original packaging carton.

- 1 Place the two foam cushions on each side of the LCD display for protection.**
- 2 Place the LCD display down in the box.**
- 3 Place the accessories box on the designated area (if necessary).**
- 4 Close and tape the box.**

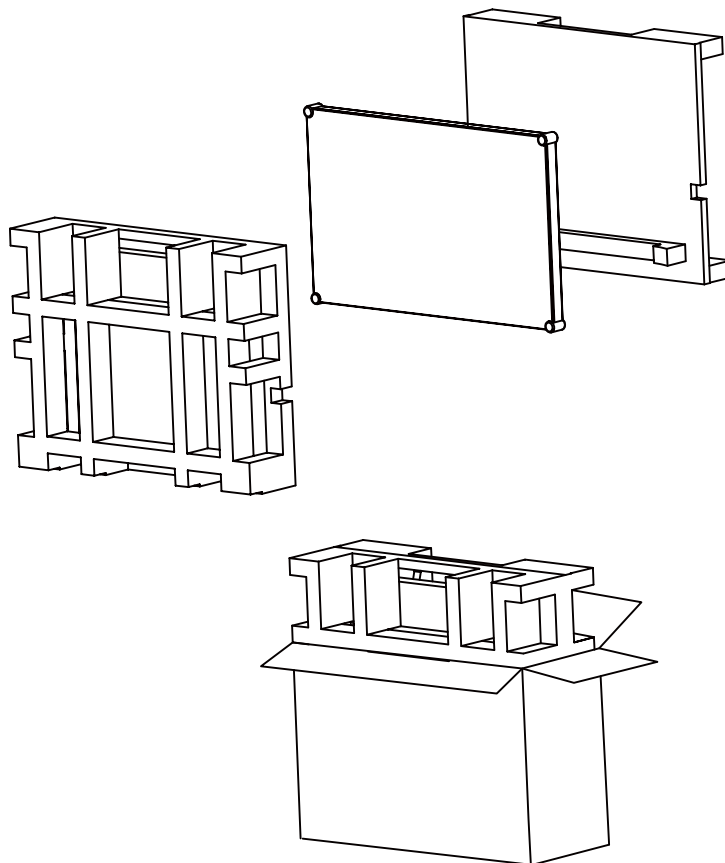

# TABLE OF CONTENTS

## 7.1 Display Specifications

DR-24G		
Panel	Panel Type	LED-Backlit TFT LCD (VA Technology)
	Panel Size	23.8"
	Max. Resolution	FHD 1920 x 1080
	Pixel Pitch	0.2745 mm
	Brightness	250 cd/m <sup>2</sup>
	Contrast Ratio	20,000,000:1 (DCR)
	Viewing Angle (H/V)	178°/178°
	Display Colour	16.7M
	Response Time	5 ms
Frequency (H/V)	H Freq.	24 kHz-83 kHz
	V Freq.	50 Hz-75 Hz
Input	DisplayPort	x 1
	HDMI	1.4 x 1
	DVI	24-Pin DVI-D x 1
	VGA	15-Pin D-Sub x 1
	Composite (CVBS)	BNC x 2
	S-Video	4-Pin mini DIN x 1
Output	Composite (CVBS)	BNC x 2
External Control	RS232 In	2.5 mm Phone Jack
Other Connectivity	USB	2.0 x1 (Service Port)
Audio	Audio In	Stereo Audio Jack (3.5 mm) Stereo Audio Jack (RCA)
	Audio Out	Stereo Audio Jack (RCA)
	Internal Speakers	2W x 2
Power	Power Supply	External
	Power Requirements	DC 24V, 2.71A
	On Mode	18W (On)
	Standby Mode	< 0.5 W
	Off Mode	< 0.3 W
Glass	Thickness	3.0 mm (0.12")
	Reflection Rate	< 1%
	Transmission Rate	> 97%
	Hardness	> 9H
Operating Conditions	Temperature	0°C-40°C (32°F-104°F)
	Humidity	10%-90% (non-condensing)
	Altitude	< 12,000 feet (3,658 m)
Transport/ Storage Conditions	Temperature	-20°C-60°C (-4°F-140°F)
	Humidity	5%-95% (non-condensing)
	Altitude	< 40,000 feet (12,192 m)
Mounting	VESA FPMPI	Yes (100 x 100 mm & 75 x 75 mm)
Security	Kensington Security Slot	Yes
Dimensions	wo/Base (W x H x D)	562.4mm x 352.6 mm x 56.2mm (22.1" x 13.9" x 2.2")
	Packaging (W x H x D)	672.0mm x 517.0mm x 249.0mm (26.5" x 20.4" x 9.8")
Weight	wo/Base	7.4kg (16.3 lb)
	Packaging	10.6kg (23.4 lb)

### Note:

- ◆ All specifications are subject to change without prior notice.

# TABLE OF CONTENTS

## 7.2 Display Dimensions

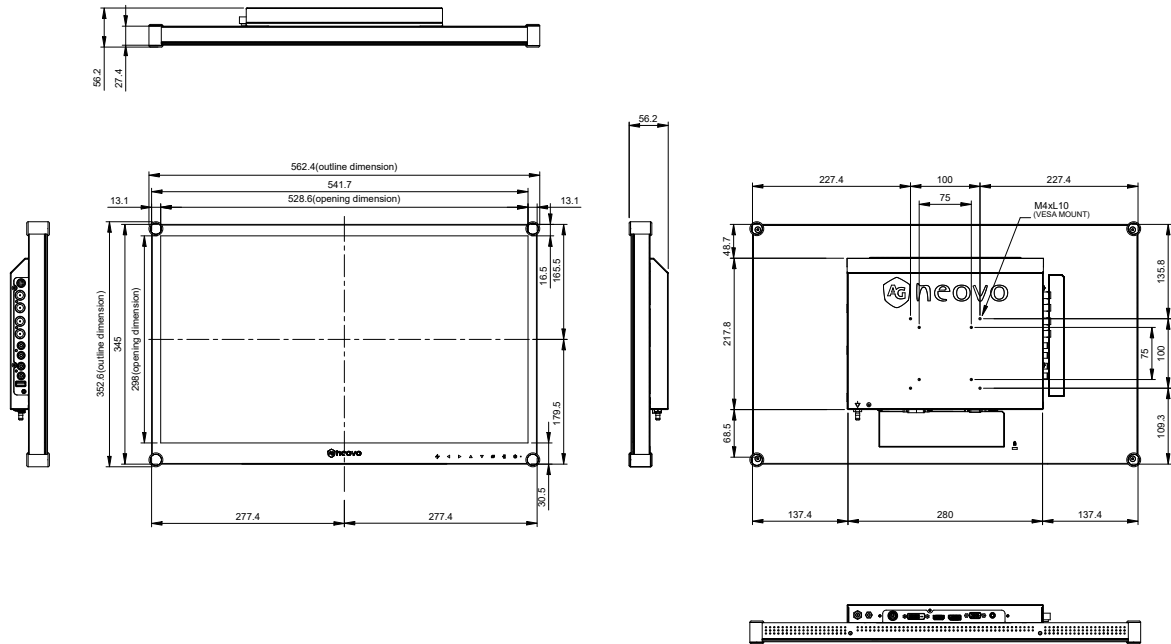

### AG Neovo

Company Address: 5F-1, No. 3-1, Park Street, Nangang District, Taipei, 11503, Taiwan.

Copyright © 2022 AG Neovo. All rights reserved.

DR-24G Eprel registration number: 1053063

DR24G0\_UM\_V010