

CDE30 Series

Commercial Display

Quick Start Guide

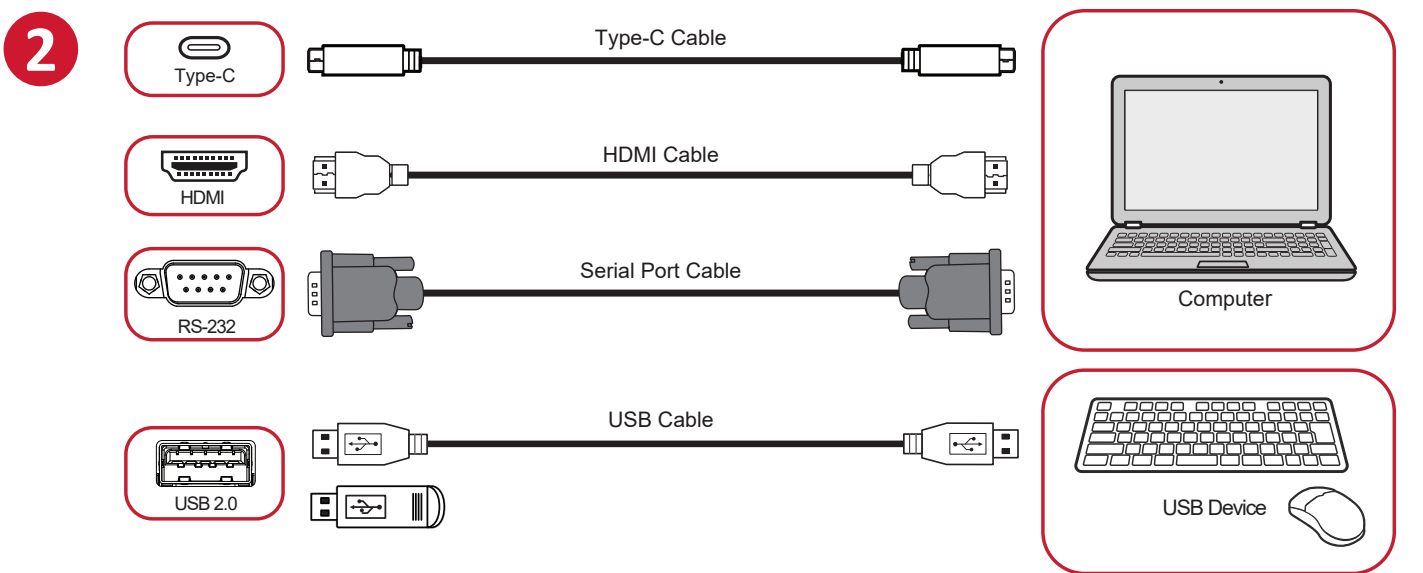

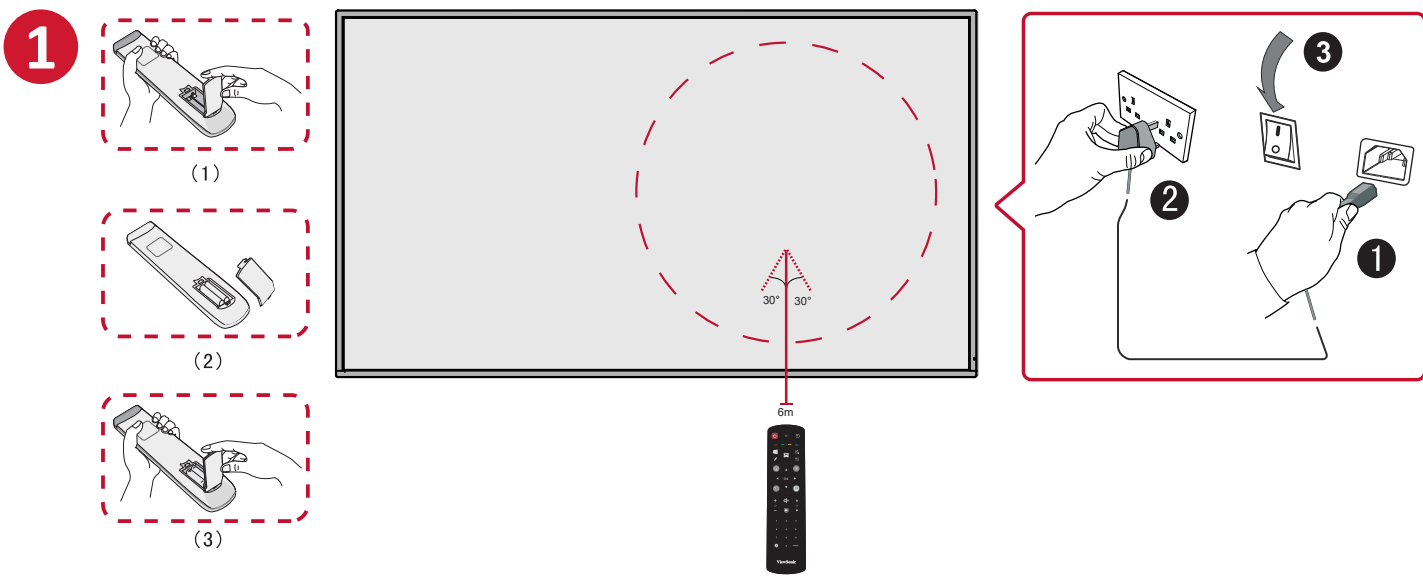
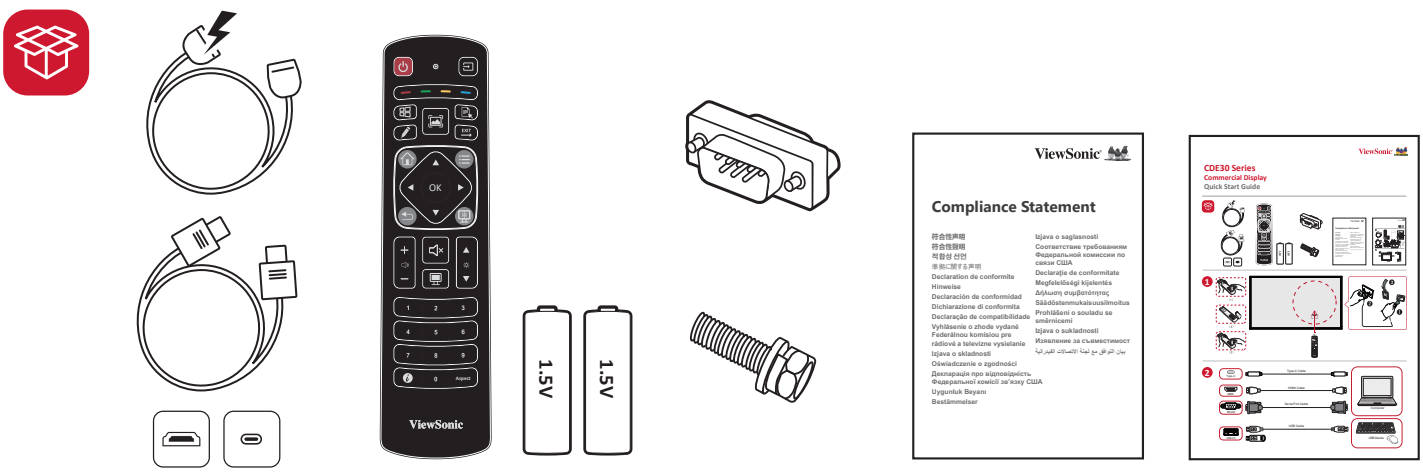
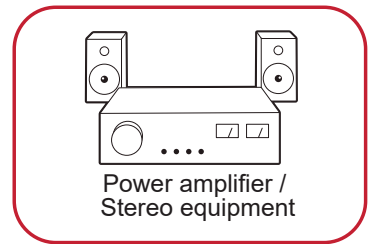
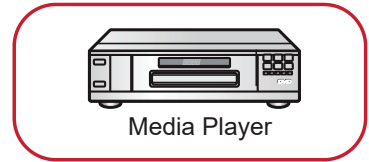
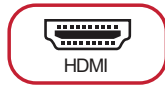
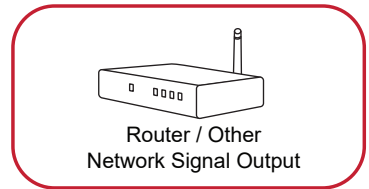
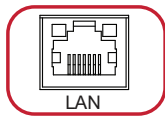

The terms HDMI, HDMI High-Definition Multimedia Interface, HDMI trade dress and the HDMI Logos are trademarks or registered trademarks of HDMI Licensing Administrator, Inc.

3

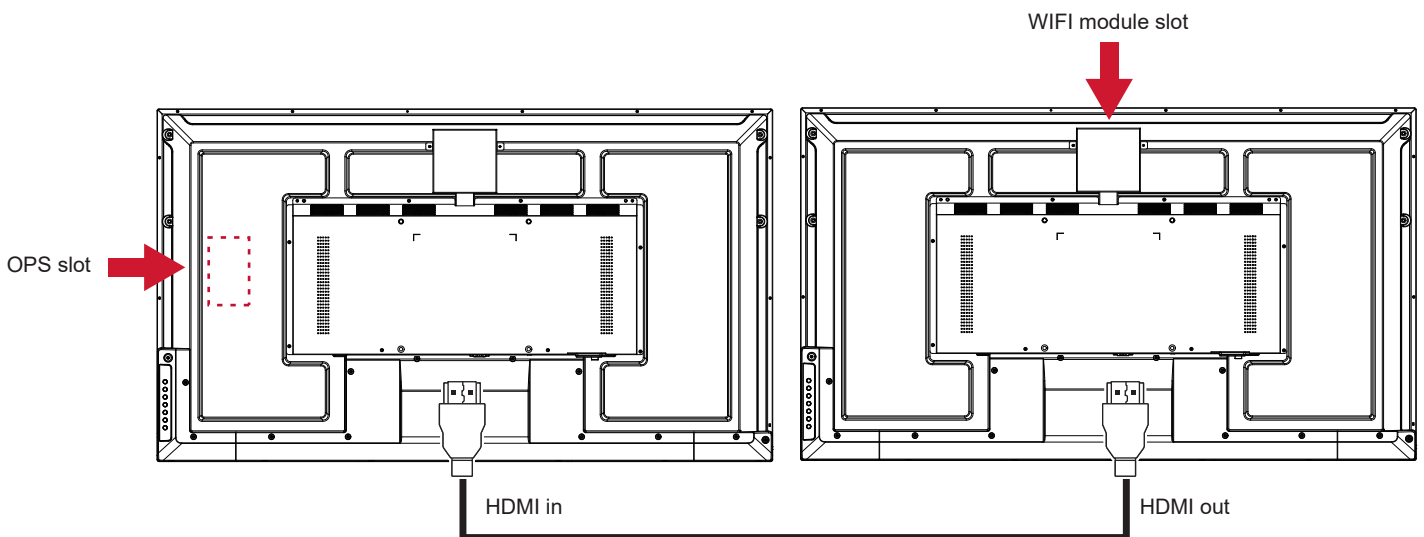

Scan for more information