

# KitchenAid

Espresso Machine  
5KES6403  
5KES6503



<b>EN</b>	Use and Care manual	2	<b>FI</b>	Käyttö- ja huolto-opas	193
<b>DE</b>	Gebrauchs- und Pflegeanleitung	21	<b>DA</b>	Vejledning til anvendelse og vedligehold	211
<b>FR</b>	Manuel d'utilisation et d'entretien	41	<b>IS</b>	Notenda & Meðhöndlunar handbók	229
<b>IT</b>	Manuale d'uso e manutenzione	63	<b>RU</b>	Руководство по эксплуатации и уходу	247
<b>NL</b>	Gebruiks- en onderhoudshandleiding	81	<b>PL</b>	Instrukcja obsługi i konserwacji	267
<b>ES</b>	Manual de uso y cuidado	99	<b>CS</b>	Návod k použití a údržbě	285
<b>PT</b>	Manual de utilização e manutenção	119	<b>TR</b>	Kullanım ve Bakım kılavuzu	303
<b>EL</b>	Εγχειρίδιο Χρήσης και Φροντίδας	139	<b>UK</b>	Посібник із використання й догляду	321
<b>SV</b>	Handbok för skötsel och användning	157	<b>AR</b>	دليل الاستخدام والعناية	1
<b>NO</b>	Håndbok for bruk og vedlikehold	175			



## PARTS AND FEATURES

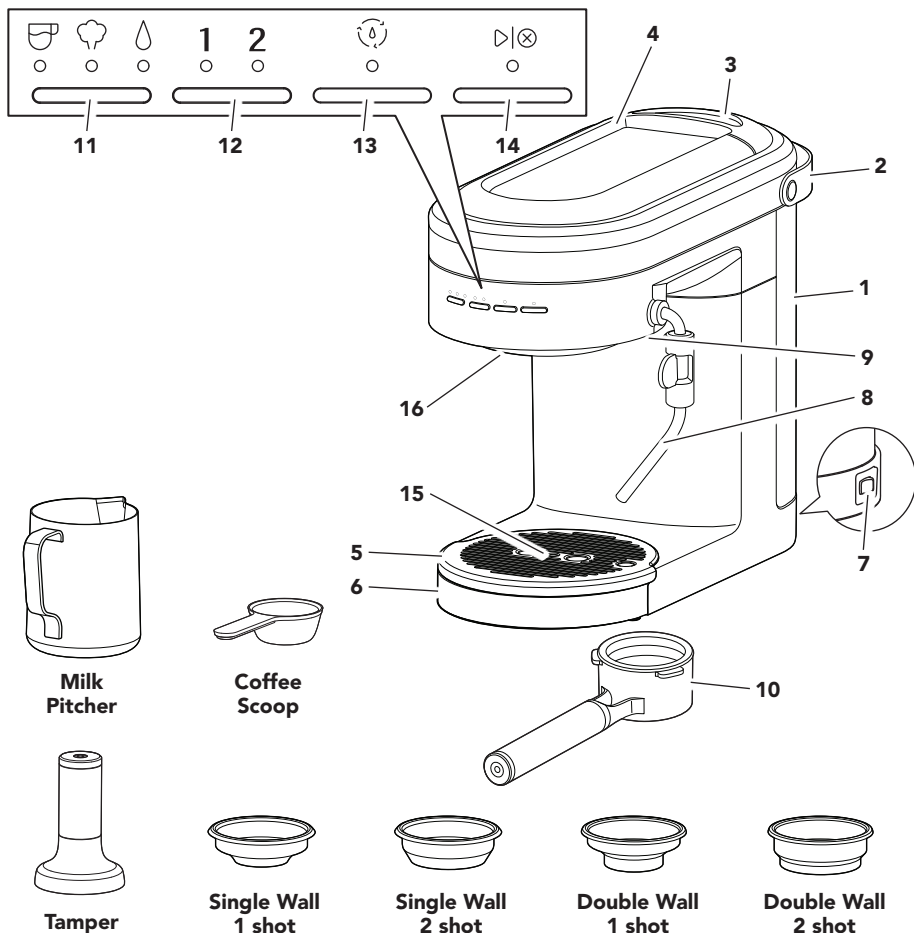

- 1** Water Tank (Capacity: 1.4 Liters)
- 2** Water Tank Handle
- 3** Water Tank Lid
- 4** Cup Warmer
- 5** Drip Tray Plate
- 6** Drip Tray
- 7** Main Power On/Off Switch
- 8** Steam Wand
- 9** Steam Wand Release Button

- 10** Portafilter (58 mm)
- 11** Mode Button : Espresso  
: Steam  
: Hot Water
- 12** Dose Button : **1** (1 shot)  
: **2** (2 shot)
- 13** Clean Cycle Button
- 14** Start/Cancel Button
- 15** Empty Drip Tray Indicator
- 16** Group Head





## PRODUCT SAFETY

### Your safety and the safety of others are very important.

We have provided many important safety messages in this manual and on your appliance. Always read and obey all safety messages.



This is the safety alert symbol.

This symbol alerts you to potential hazards that can kill or hurt you and others.

All safety messages will follow the safety alert symbol and either the word "DANGER" or "WARNING." These words mean:

 **DANGER**

**You can be killed or seriously injured if you don't immediately follow instructions.**

 **WARNING**

**You can be killed or seriously injured if you don't follow instructions.**

All safety messages will tell you what the potential hazard is, tell you how to reduce the chance of injury, and tell you what can happen if the instructions are not followed.

## IMPORTANT SAFEGUARDS

**When using electrical appliances, basic safety precautions should always be followed, including the following:**

1. Read all instructions. Misuse of appliance may result in personal injury.
2. European Union Only: This appliance shall not be used by children. Keep the appliance and its cord out of reach of children.
3. European Union Only: Appliances can be used by persons with reduced physical, sensory or mental capabilities or lack of experience and knowledge if they have been given supervision or instruction concerning use of the appliance in a safe way and understand the hazards involved. Children shall not play with the appliance.
4. Do not touch hot surfaces. Use handles or knobs.
5. This appliance is not intended for use by persons (including children) with reduced physical, sensory or mental capabilities, or lack of experience and knowledge, unless they have been given supervision or instruction concerning use of the appliance by a person responsible for their safety.



## PRODUCT SAFETY

6. To protect against fire, electric shock, and personal injury do not immerse cord, plugs, or appliance in water or other liquids. Avoid spillage on the connector.
7. Close supervision is necessary when any appliance is used by or near children.
8. Unplug from outlet when not in use and before cleaning. Allow to cool before putting on or taking off parts, and before cleaning.
9. Do not operate any appliance with a damaged cord or plug, or after the appliance malfunctions, or is dropped or damaged in any manner. Return appliance to the nearest Authorised Service Facility for examination, repair, or electrical or mechanical adjustment.
10. Never leave the appliance unattended while it is in operation.
11. The use of accessory attachments not recommended by the appliance manufacturer may result in fire, electric shock, or personal injury.
12. Do not use the appliance outdoors.
13. Do not let cord hang over edge of table or counter, or touch hot surfaces.
14. Do not place on or near a hot gas or electric burner, or in a heated oven.
15. Turn the appliance OFF, then unplug from the outlet when not in use, before assembling or disassembling parts and before cleaning. To unplug, grasp the plug and pull from the outlet. Never pull from the power cord.
16. Do not clean the Espresso Machine with abrasive cleaners, steel wool, or other abrasive materials.
17. Use extreme caution when using hot steam.
18. Do not use appliance for other than intended use.
19. Irritation to skin or eyes can occur if they come into contact with the descaling solution. Avoid skin and eye contact. Rinse off descaling solution with clean water. Obtain medical advice after eye contact.
20. Damage to delicate surfaces can occur after contact with the descaling solution. Remove any splashes immediately.





## PRODUCT SAFETY

21. Refer to the “Care and Cleaning” section for instructions on cleaning the surfaces in contact with food.
22. The heating element surface is subject to residual heat after use. Do not touch hot surface. Use handles.
23. Children should be supervised to ensure that they do not play with the appliance.
24. If the supply cord is damaged, it must be replaced by the manufacturer, its service agent or similarly qualified persons in order to avoid a hazard.
25. Cleaning and user maintenance shall not be made by children without supervision.
26. The Coffee-Maker shall not be placed in a cabinet when in use.
27. This appliance is intended to be used in household and similar applications such as:
  - staff kitchen areas in shops, offices and other working environments;
  - farm houses;
  - by clients in hotels, motels and other residential type environments;
  - bed and breakfast type environments.

## SAVE THESE INSTRUCTIONS

Instructions are also available online, visit our website at:  
[www.KitchenAid.co.uk](http://www.KitchenAid.co.uk) or [www.KitchenAid.eu](http://www.KitchenAid.eu)



# PRODUCT SAFETY

## ELECTRICAL REQUIREMENTS

**⚠ WARNING**



**Electrical Shock Hazard**

**Plug into an earthed outlet.**

**Do not remove earth prong.**

**Do not use an adapter.**

**Do not use an extension cord.**

**Failure to follow these instructions can result in death, fire, or electrical shock.**

**Voltage:** 220-240 Volts AC

**Frequency:** 50-60 Hz

**Wattage:** 1470 Watts

**NOTE:** If the plug does not fit in the outlet, contact a qualified electrician or service person. Do not modify the plug in any way. Do not use an adapter.

Do not use an extension cord. If the power supply cord is too short, have a qualified electrician or service person to install an outlet near the appliance.

The cord should be arranged so that it will not drape over the countertop or tabletop where it can be pulled on by children or tripped over unintentionally.

## DISPOSAL OF PACKING MATERIAL

The packing material is recyclable and is marked with the recycle symbol . The various parts of the packing must therefore be disposed of responsibly and in full compliance with local authority regulations governing waste disposal.

## ELECTRICAL EQUIPMENT WASTE DISPOSAL

### Recycling the product

- This appliance is marked in compliance with law in the EU and UK covering, Waste Electrical and Electronic Equipment (WEEE).

- By ensuring this product is disposed of correctly, you will help prevent potential negative consequences for the environment and human health, which could otherwise be caused by inappropriate waste handling of this product.



- The symbol  on the product or on the accompanying documentation indicates that it should not be treated as domestic waste but must be taken to an appropriate collection centre for the recycling of electrical and electronic equipment.

For more detailed information about treatment, recovery and recycling of this product, please contact your local city office, your household waste disposal service, or the shop where you purchased the product.





# PRODUCT SAFETY

## DECLARATION OF CONFORMITY (UK)

---

This appliance has been designed, constructed and distributed in compliance with the safety requirements of UK Legislation: Electrical Equipment (Safety) Regulations 2016, Electromagnetic Compatibility Regulations 2016. The Ecodesign for Energy-Related Products and Energy Information (Amendment) (EU Exit) Regulations 2019. The Restriction of the Use of Certain Hazardous Substances in Electrical and Electronic Equipment Regulations 2012.

## DECLARATION OF CONFORMITY (EU)

---

This appliance has been designed, constructed and distributed in compliance with the safety requirements of EC Directives: Low Voltage Directive 2014/35 Electromagnetic Compatibility - Directive 2014/30/EU Directive 92/42/EEC hot water boilers and Ecodesign Directive 2009/125/EC Restriction of the use of certain Hazardous Substances in Electrical and Electronic Equipment (RoHS) - Directive 2002/95/EC.





# GETTING STARTED

First, clean all parts and accessories (See "Care and Cleaning" section).  
Place the Espresso Machine on a dry, flat, level surface such as a countertop or table.

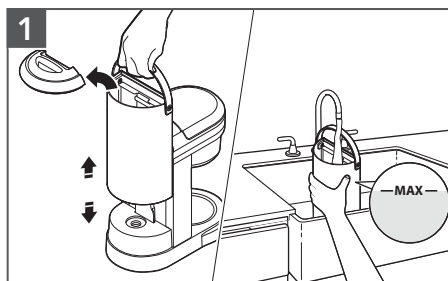

**1**  
Fill the Water Tank with fresh water (max. 1.4 liter). Replace the Water Tank Lid.

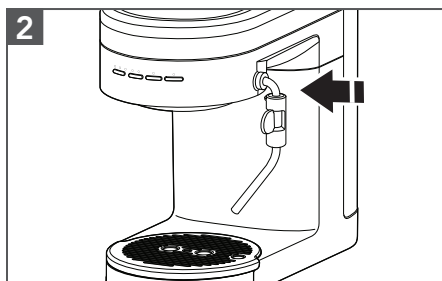

**2**  
Insert the Steam Wand until you hear a click.

**IMPORTANT:** Distilled water or mineral water can damage the Espresso Machine. Do not use either to brew espresso.



## ⚠ WARNING

### Electrical Shock Hazard

**Plug into an earthed outlet.**

**Do not remove an earth prong.**

**Do not use an adapter.**

**Do not use an extension cord.**

**Failure to follow these instructions can result in death, fire, or electrical shock.**

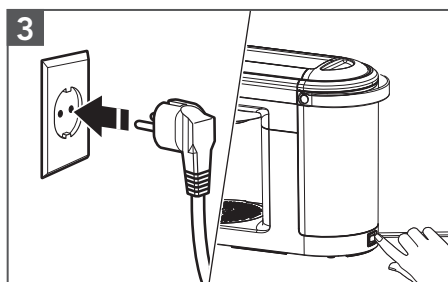

**3**  
Plug into an earthed outlet.  
Press the main power switch to "ON (-)".

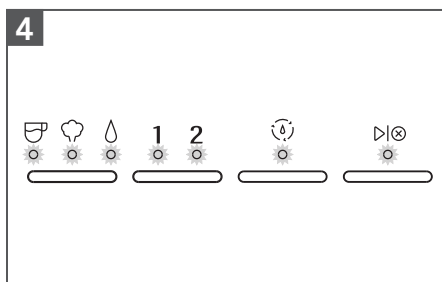

**4**  
The machine automatically pumps water into the heater and starts heating. When lights stop blinking, the Espresso Machine is ready for use.







## GETTING STARTED

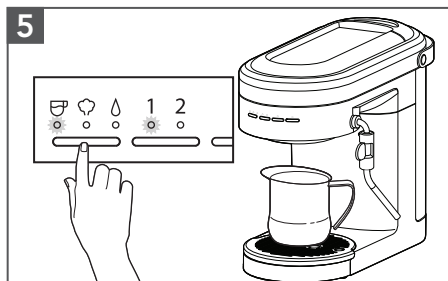

To rinse the Group Head, place a container under the Group Head. Toggle the Mode Button to select Espresso. Toggle Dose Button to **1** and press **▶⊗** button. The machine will flush water through the Group Head and automatically stop when the cycle is complete.

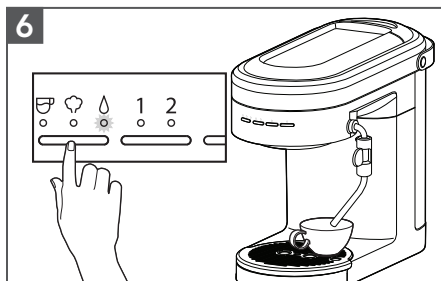

To rinse the Steam Wand, direct the Steam Wand towards the Drip Tray or into a cup. Then, toggle the Mode Button to select Hot Water and press **▶⊗** button to start. Allow water to flow for 3 to 5 seconds then, press **▶⊗** button to stop.

## PRODUCT USAGE

### BREWING ESPRESSO

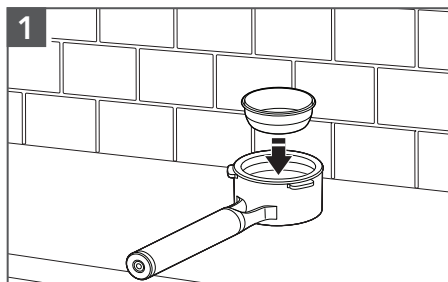



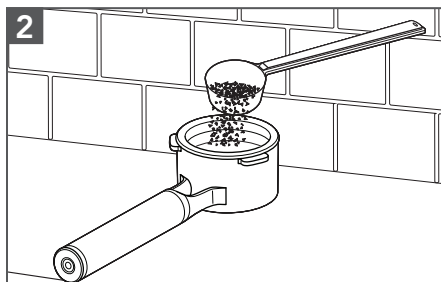





Select desired Filter basket (see Basket selection chart). Press the Filter basket into the Portafilter until it clicks into place.



Fill the Filter basket with fine Espresso coffee grounds (see Basket selection chart for dosing recommendations).

### BASKET SELECTION CHART

Basket type	Shot	Dose (gram)	Use for
Single wall 	1 shot 	10 - 12	Freshly ground whole bean coffee
Single wall 	2 shot 	18 - 20	Freshly ground whole bean coffee
Double wall 	1 shot 	10 - 12	Pre-ground coffee
Double wall 	2 shot 	18 - 20	Pre-ground coffee



## PRODUCT USAGE

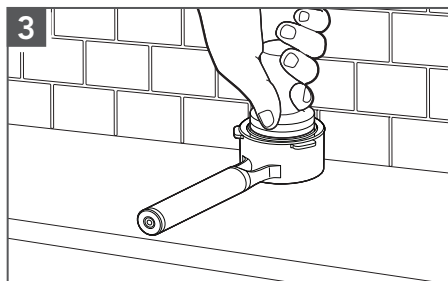

Tap the Portafilter to level the ground coffee bed and rest on a flat surface. Use the Tamper to tamp down the ground coffee. Sweep excess coffee grinds from the rim.

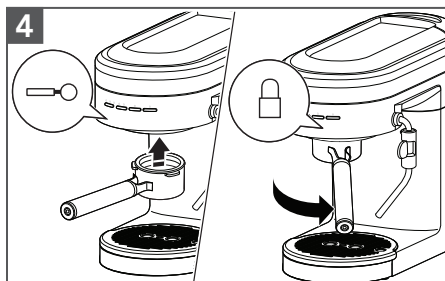

Position the Portafilter under the Group Head with the handle align to unlock. Raise the Portafilter into the Group Head and twist to the right side to lock.

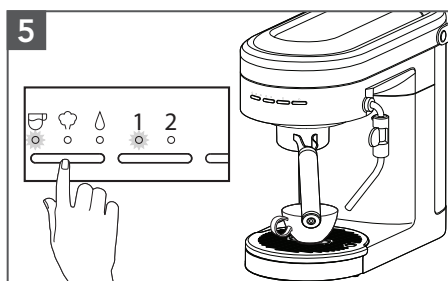

Toggle Mode Button to select Espresso. Toggle Dose Button to select desired number of shots 1 (~ 30 ml) or 2 (~ 60 ml).

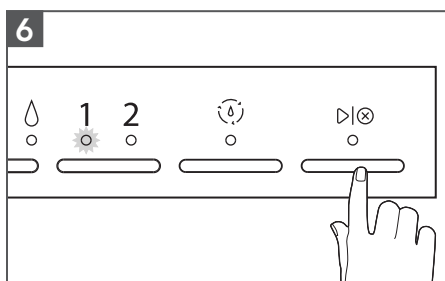

Press **▶⏸** button to run selected Espresso cycle.

**NOTE:** Do not remove the Portafilter when brewing.

**TIP:** Shot duration should be between 20-30 seconds for 1 and 2 shot selections.

- If less than 20 seconds: decrease grind size and/or increase tamp pressure.
- If more than 30 seconds: increase grind size and/or reduce tamp pressure.

## USING THE STEAM MODE FOR MILK

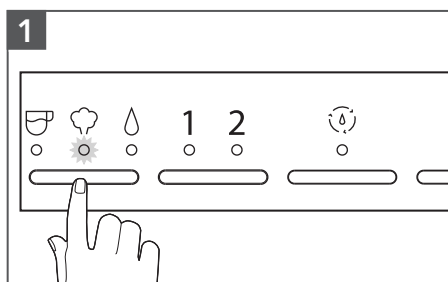

Toggle the Mode Button to select Steam. The machine will automatically start heating, indicated by the flashing Steam light. The Steam light will go solid when machine is ready for steaming.

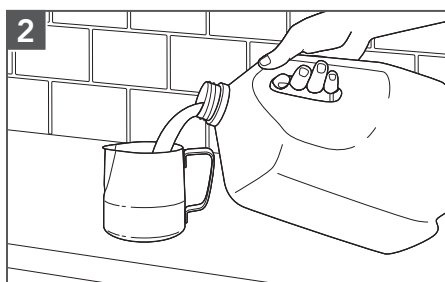

Fill the Milk Pitcher with desired amount of cold milk.

**TIP:** Fill to bottom of the pour spout.



## PRODUCT USAGE

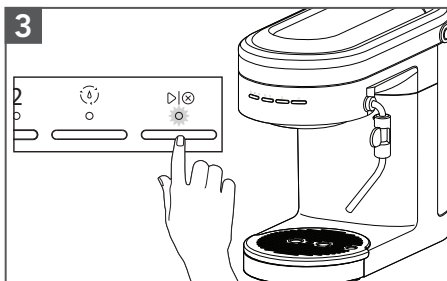

3 Angle the Steam Wand towards the Drip Tray or into a cup. Press **▶⏸** button to start. Once water turns to steam, press **▶⏸** button to stop.

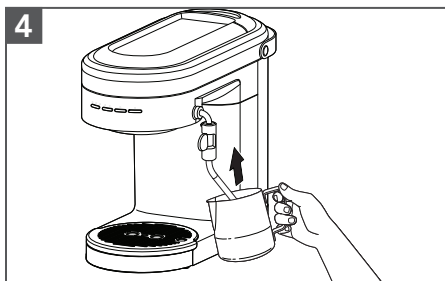

4 Adjust the Steam Wand to desirable position. Submerge the tip of the Steam Wand just below the surface of milk in the Milk Pitcher.

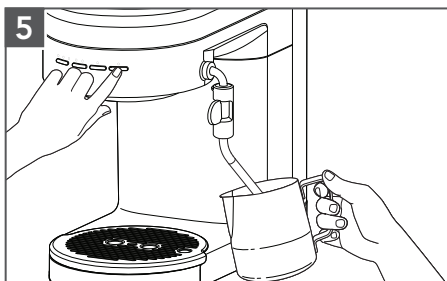

5 Press **▶⏸** button to initiate the steam. Froth until desired level of foam and temperature is reached. To stop the steam, press **▶⏸** button again. To avoid splattering, wait until the steam stops before removing the Steam Wand from the milk.

## USING HOT WATER FEATURE

The Steam Wand can also dispense hot water which is great for an americano, tea, hot chocolate, etc. You can also use hot water to pre-heat cups.

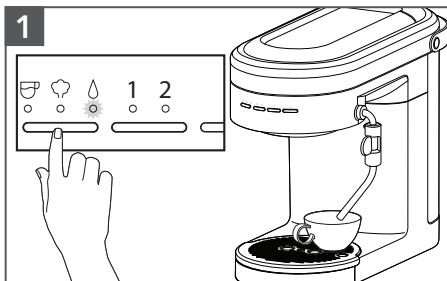

1 Toggle the Mode Button to select Water. Place a cup under the Steam Wand.

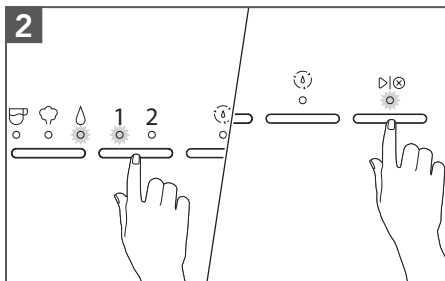

2 Press Dose Button to select the volume of water 1 (~ 118 ml) or 2 (~ 177 ml). Press **▶⏸** button to start water cycle. Water flows out from the Steam Wand.

**NOTE:** You can pause the cycle by pressing **▶⏸** button to stop the flow of water before the cycle complete.





# PROGRAMMING FUNCTION

The Espresso Machine is equipped with programming functionality. Any customised settings will be saved even in the event power is lost to the machine.

## PROGRAMMING THE ESPRESSO AND HOT WATER AMOUNT

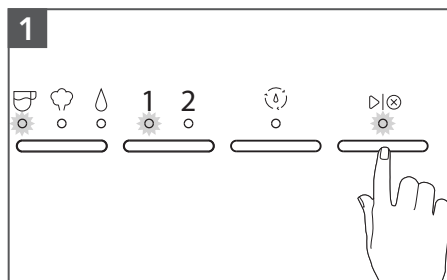

**To change pre-programmed Espresso Volume for 1 / 2:** Toggle the Mode Button to select Espresso. Select the dose you desire to programme (1 or 2). Press and hold **▶⊗** button until desired espresso amount is reached in your cup.

While programming your selected dose, the dose and the **▶⊗** button lights will blink. Lights will stop blinking when programming is complete.

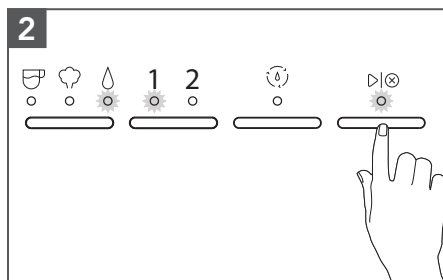

**To change pre-programmed Water Volume for 1 / 2:** Toggle the Mode Button to select Water. Select the dose you desire to programme (1 or 2). Press and hold **▶⊗** button until desired water amount is reached in your cup.

While programming your selected dose, the dose and the **▶⊗** button light will blink. Lights will stop blinking when programming is complete.

**TIP:** To restore all factory settings, Press and Hold "Dose Button" for 3 seconds. Changing the factory default Espresso or Water Volumes may impact the intended performance of the machine.

## PROGRAMMING THE WATER TEMPERATURE AND WATER HARDNESS

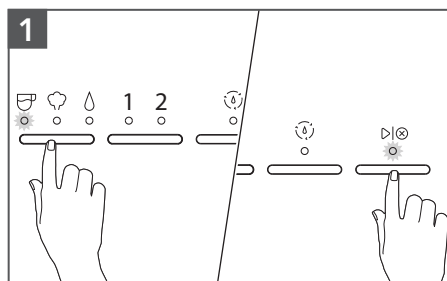

**To change pre-programmed Water Temperature:** Toggle the Mode Button to select Espresso, press and hold for 3 seconds.

The indicator lights will show the default factory setting or previous saved setting (see Indicator light chart for reference).

Toggle the Mode Button between Low-Mid-High to select desired temperature.

To save your selection, press **▶⊗** button or wait for 10 seconds.

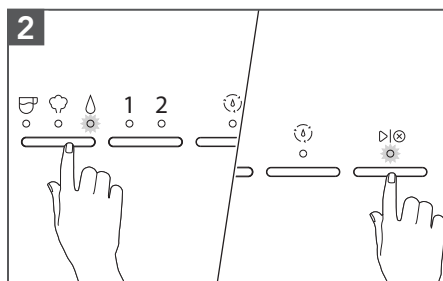

**To change pre-programmed Water Hardness:** Toggle the Mode Button to Water, Press and hold for 3 seconds.

The indicator lights will show the default factory setting or previous saved setting (see Indicator light chart for reference).

Toggle the Mode Button between Low-Mid-High to select desired water hardness.









To save your selection, press **▶⊗** button or wait for 10 seconds.





# PROGRAMMING FUNCTION

## INDICATOR LIGHT CHART

Water Temperature or Water Hardness			
Low			
Medium			
High			

**NOTE:** Water Hardness - Low: 0 to 60 ppm  
 Medium: 60 to 120 ppm  
 High: more than 120 ppm

**TIP:** To restore all factory settings, Press and Hold "Dose Button" for 3 seconds. All indicator lights will blink indicating that all settings are restored.

## CARE AND CLEANING

For best results, regularly clean the Espresso Machine and accessories.

**IMPORTANT:** Unplug the Espresso Machine before cleaning. Allow the Espresso Machine and accessories to cool down.

**NOTE:** Do not use abrasive cleansers or scouring pads when cleaning the Espresso Machine, parts, or accessories. Do not immerse the Espresso Machine or cord in water or other liquids.

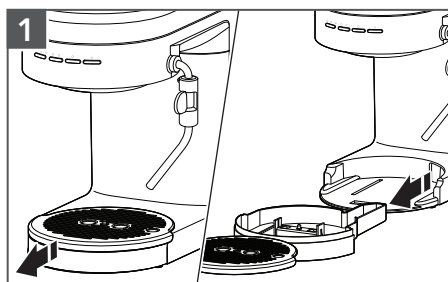

1 When the Drip Tray Indicator rises and becomes visible above the surface of the Drip Tray Plate, empty the Drip Tray and rinse with warm water.

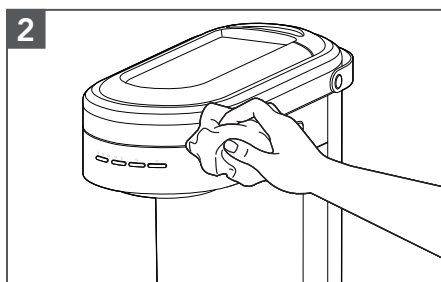

2 Wipe the Espresso Machine housing and Group Head with a clean soft damp cloth.



## CARE AND CLEANING

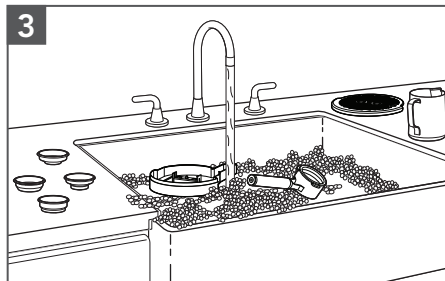

Wash the Drip Tray, Portafilter, Filter baskets, Milk Pitcher, and Drip Tray Plate in warm, soapy water and rinse with clean water. Dry with a soft cloth.

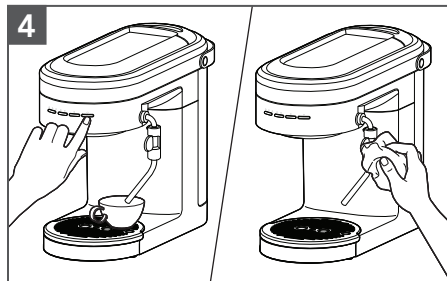

Clean the Steam Wand after every use. Toggle the Mode Button to select Water. Position the Steam Wand over Drip Tray or into a cup. Press **▶|⊗** button, wait 3 to 5 seconds. Press **▶|⊗** button to stop. Wipe down wand exterior with a soft damp cloth.

**NOTE:** To remove the Steam Wand press the Steam Wand Release Button.

## DESCALING THE ESPRESSO MACHINE

The descaling programme enables simple and effective descaling of your Espresso Machine. Descale the Espresso Machine regularly, but a minimum whenever the “Clean (i)” indicator is blinking. The frequency of descaling depends on the hardness of the water in your region. Therefore, it is important to programme the Espresso Machine according to the water hardness level of your location.

**NOTE:** The descaling process runs in 4 phases, takes approximately 10 minutes and must be completed before next use. At any time during the descaling programme you can pause the cycle by pressing **▶|⊗** button. And, resume too by pressing **▶|⊗** button.

**IMPORTANT:** Only use descaling solution intended for Espresso Machines.

## SET UP OF GROUP HEAD DESCALING

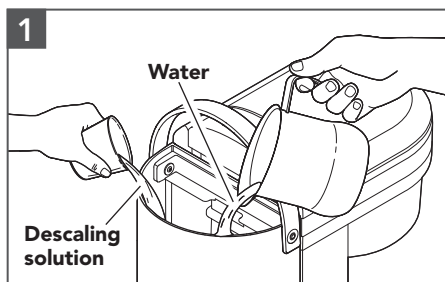

Fill 250 ml water and 125 ml descaling solution inside the Water Tank.

**NOTE:** The clean cycle is designed to run as per the above mentioned water and descaling solution volumes.

The cycle cannot be completed with any less volume than mentioned above.

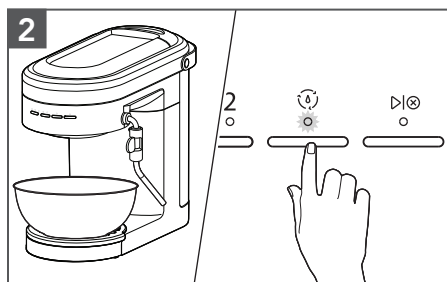

**Phase 1:** Place a container (~0.5 L) on the Drip Tray below the Group Head. Press the Clean cycle (i) button for 3 seconds or until Clean light is solid. Then, press **▶|⊗** button to start first phase of decalcification cycle.

Start/Cancel (**▶|⊗**) will blink fast after the first phase is complete. Empty the container.



## CARE AND CLEANING

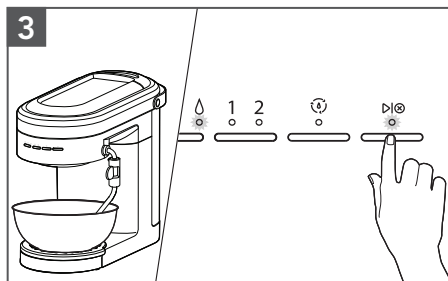

**Phase 2:** Place the container (~0.5 L) below the Steam Wand. Then, press **▶|⊗** button. Start/Cancel (**▶|⊗**) and Water Mode lights will blink fast after the second phase is complete. Empty the container.

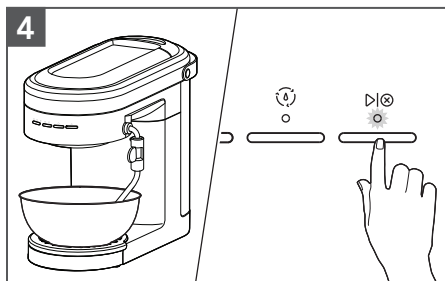

**Phase 3:** Place the container (~0.5 L) below the Steam Wand. Empty, rinse and refill the Water Tank with fresh water to Max fill line. Replace the Water Tank. Press **▶|⊗** button. Start/Cancel (**▶|⊗**) will blink fast after the third phase is complete. Empty the container.

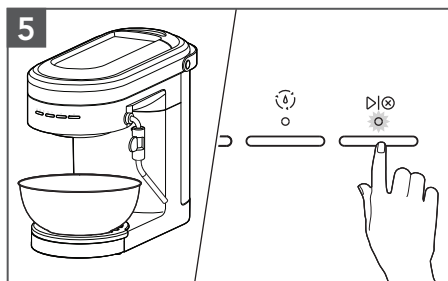

**Phase 4:** Place the container (~0.5 L) on the Drip Tray below Group Head. Then, press **▶|⊗** button. Clean (⌚) light and **▶|⊗** button light will blink fast after the fourth and final phase is complete. Empty the container.

Press **▶|⊗** button to complete the Clean cycle. Machine will go back into heating mode.

## WINTER STORAGE CARE

**IMPORTANT:** To avoid damage, use and store your Espresso Machine where it will not freeze. Because some water remains inside the unit, freezing can damage the product. If storing or moving during freezing weather, purge your Espresso Machine.

To purge the Espresso Machine, ensure Steam Wand is attached and Water Tank is at least half full.

1. Place a cup under the Steam Wand nozzle.
2. Turn the Espresso Machine On, toggle Mode Button to Steam. Press Start/Cancel (**▶|⊗**). Once steam exits the Steam Wand for approximately 10 seconds, remove Water Tank and allow remaining water in the machine to exit through the Steam Wand.
3. Purging cycle will be complete once Espresso Machine stops and the Water mode will blink.
4. Turn On/Off (icon) button to off. Empty and re-install Water Tank. Then, unplug the Espresso Machine.





# TROUBLESHOOTING GUIDE



## ⚠ WARNING

### Electrical Shock Hazard

**Plug into an earthed outlet.**

**Do not remove an earth prong.**

**Do not use an adapter.**

**Do not use an extension cord.**

**Failure to follow these instructions can result in death, fire, or electrical shock.**

Problem	Solution
Espresso Machine will not start	Check if the Espresso Machine is securely plugged into an earthed prong outlet.
	Check to see if the Main Power On/Off Switch is turned on.
	If you have a circuit breaker box, then make sure the circuit is closed.
Espresso flows slowly or only drips	Coffee is ground too finely. Use slightly coarser grind.
	Coffee tamped too hard. Use slightly lighter tamp between 15-20 kg or 30-40 lb of force.
	Filter basket can be blocked. Use a pin to unblock the hole(s).
	Machine might need to be descaled. Refer to the "Descaling the Espresso Machine" section.
Espresso flows too quickly	Coffee is ground too coarsely. Use slightly finer grind.
	Not sufficient coffee in the filter basket. Increase dose of coffee. Refer to the "Basket selection chart" section.
	Coffee tamped too softly. Use slightly firmer tamp between 15-20 kg or 30-40 lb of force.
Espresso flows over the edge of the Portafilter	Portafilter is not inserted in the Group Head properly. Ensure the Portafilter is completely inserted and rotated until the handle is aligned to the lock icon.
	There are coffee grounds around the rim of the filter basket. Swipe excess coffee to ensure proper seal in the Group Head.
	Too much coffee in the filter basket. Use lower dose of coffee. Refer to the "Basket selection chart" section.
Steam Wand is not producing hot water/steam	Operating temperature has not been reached. Allow the machine to reach to the operating temperature.
Steam/hot water flows slowly from Steam Wand	Steam Wand is partially blocked. Remove Steam Wand from Espresso Machine. Soak in cleaning solution and use a pin to clear out the hole and rinse with clear water.
	Machine might need to be descaled. Refer to the "Descaling the Espresso Machine" section.







## TROUBLESHOOTING GUIDE

Problem	Solution
No Crema is being produced	Coffee is ground too coarsely. Use slightly finer grind.
	Coffee tamped too softly. Use slightly firmer tamp between 15-20 kg or 30-40 lb of force.
	Single wall filter basket might have been used with pre-ground coffee. Please see the "Basket selection chart" section.
Knocking/pumping sound occurs during espresso, steam, or hot water cycle	The Espresso Machine is going through a normal operation, therefore no action is required.
All Mode/Dose lights are blinking	Machine is in protection mode to avoid the pump from over heating. Turn Off the machine for 7.5 minutes.
The Steam light and all Dose lights are blinking	Machine is in the protection mode to avoid from overheating. Turn Off the machine for 10 minutes.
Water light continuously blinks	Ensure water is in the Water Tank and ensure Water Tank is properly assembled.
	Steam Wand is blocked. Remove it from Espresso Machine and thoroughly clean it.
	Coffee puck is too dense, adjust to larger grind size. If using a Double wall basket, then clean exit hole with a pin.
All lights are blinking at the same time	Turn off the Espresso Machine and unplug for approximately 10 minutes. Then, plug back in and restart the machine. If problem persist call service.
All lights are continuously on	If the problem occurs again, unplug the machine for approx. 5 minutes, plug back in and restart the machine and then run 1 complete clean cycle.
If the problem is not due to one of the above items	See the "Arranging for Service" chapter in the "Terms of KitchenAid Guarantee ("Guarantee")" section. Do not return the Espresso Machine to the retailer as they do not provide service.



# TERMS OF KITCHENAID GUARANTEE ("GUARANTEE")

## Covering U.K. - Ireland - South Africa - UAE

KitchenAid Europa, Inc., Nijverheidslaan 3, Box 5, 1853 Strombeek-Bever, Belgium ("Guarantor") grants the end-customer, who is a consumer, a Guarantee pursuant to the following terms.

### FOR U.K.:

The Guarantee applies in addition to and does not limit or affect the statutory warranty rights of the end-customer against the seller of the product. In summary, the Consumer Rights Act 2015 says products must be as described, fit for purpose and of satisfactory quality. During the expected lifespan of your product your legal rights entitle you to the following:

- Up to 30 days: if your product is faulty, then you can get an immediate refund.
- Up to six months: if your product can't be repaired or replaced, then you're entitled to a full refund, in most cases.
- Up to six years: if your product does not last a reasonable length of time you may be entitled to some money back.

These rights are subject to certain exceptions. For detailed information please visit the Citizens Advice website [www.adviceguide.org.uk](http://www.adviceguide.org.uk) or call **03454 04 05 06**.

### FOR IRELAND:

The Guarantee applies in addition to and does not limit or affect the statutory warranty rights of the end-customer against the seller of the product under the European Communities (Certain Aspects of the Sale of Consumer Goods and Associated Guarantees Regulations 2003 (S.I. No. 11/2003)) and other enactments governing the sale of consumer goods.

### FOR SOUTH AFRICA:

The Guarantee applies in addition to and does not limit or affect the statutory warranty rights of the end-customer against the seller of the product. In summary, the Consumer Protection Act, 2008 says that products must be: (i) reasonably suitable for the purpose for which they are intended; (ii) in good working order, of good quality and free of any defects; (iii) useable and durable for a reasonable period of time, having regard to the use to which they would normally be put and to all the surrounding circumstances; and (iv) in compliance with any applicable standards or any other public regulations.

During the expected lifespan of your product and where the products are not purchased online, your legal rights will entitle you to the following:

- You will be entitled to a full refund, if you did not have the opportunity to examine the product before delivery and if you rejected delivery of the product on the basis that the type and quality of the product was not as reasonably expected or did not reasonably conform to the material specifications.
- Within 5 business days after delivery: you may rescind your purchase and request a refund, if your purchase resulted from direct marketing.
- Within 10 business days after delivery: you will be entitled to a full refund, if it is found that the product was unsuitable for a particular purpose specifically communicated to you by the Guarantor.
- Within 15 business days after delivery: you will be entitled to a refund if: (i) the product was not delivered to you; or (ii) if you returned the product to the Guarantor.
- Within 6 months after delivery: you will be entitled to a refund or a replacement product, if the product is defective or fails to operate in terms of its specifications.





# TERMS OF KITCHENAID GUARANTEE ("GUARANTEE")

Where you have purchased a product online your legal rights will be governed by the Electronic Communications and Transactions Act, 2002 and you will be entitled to the following:

- Within 7 days after conclusion of the transaction or after delivery: you may cancel your purchase without reason and without penalty.
- Within 30 days of the date of cancellation of the transaction: you will be entitled to receive a refund, if you have already made payment.
- You will only be liable for the direct costs of returning the product to the Guarantor.

## FOR UAE:

The Guarantee applies in addition to and does not limit or affect the statutory warranty rights of the end-customer against the seller of the product.

### 1) SCOPE AND TERMS OF THE GUARANTEE

a) The Guarantor grants the Guarantee for the products mentioned under Section 1.b) which a consumer has purchased from a seller or a company of the KitchenAid-Group within the following countries: U.K., Ireland, or South Africa, or the United Arab Emirates (UAE).

b) The Guarantee period depends on the purchased product and is as follows:

**5KES6403 Two years full guarantee from date of purchase.**

**5KES6503 Five years full guarantee from date of purchase.**

c) The Guarantee period commences on the date of purchase, i.e. the date on which a consumer purchased the product from a dealer or a company of the KitchenAid-Group.

d) The Guarantee covers the defect-free nature of the product.

e) The Guarantor shall provide the consumer with the following services under this Guarantee, at the choice of the Guarantor, if a defect occurs during the Guarantee period:

- Repair of the defective product or product part, or
- Replacement of the defective product or product part. If a product is no longer available, the Guarantor is entitled to exchange the product for a product of equal or higher value.

f) If the consumer wishes to make a claim under the Guarantee, the consumer has to contact the country specific KitchenAid service centres or the Guarantor directly at KitchenAid Europa, Inc. Nijverheidslaan 3, Box 5, 1853 Strombeek-Bever, Belgium;

Email-Address U.K.: [CONSUMERCARE.UK@kitchenaid.eu](mailto:CONSUMERCARE.UK@kitchenaid.eu)

Email-Address IRELAND: [CONSUMERCARE.IE@kitchenaid.eu](mailto:CONSUMERCARE.IE@kitchenaid.eu)

Toll Free Number U.K. & IRELAND: **00 800 381 040 26**

## FOR SOUTH-AFRICA:

### Our local KitchenAid Distributor:

KitchenAid Africa  
PO Box 52102  
V&A Waterfront  
Cape Town  
8002



# TERMS OF KITCHENAID GUARANTEE ("GUARANTEE")

## Contact our distributor:

Telephone: +27 21 555 0700

You can contact our Customer Service Centre for Small Domestic Appliances from 8.30 am to 1.00pm and from 1.30 pm to 5.00 pm or write to us at the following address: [hello@kitchenaidafrica.com](mailto:hello@kitchenaidafrica.com)

## FOR UAE:

### AL GHANDI ELECTRONICS.

POST BOX NO. 9098,

DUBAI, UNITED ARAB EMIRATES

Toll free number: +971 4 2570007

g) The costs of repair, including spare parts, and the postage costs (if applicable) for the delivery of a defect-free product or product part shall be borne by the Guarantor. The Guarantor shall also bear the postage costs for returning the defective product or product part if the Guarantor or the country specific KitchenAid customer service centre requested the return of the defective product or product part. However, the consumer shall bear the costs of appropriate packaging for the return of the defective product or product part.

h) To be able to make a claim under the Guarantee, the consumer must present the receipt or invoice of the purchase of the product.

## 2) LIMITATIONS OF THE GUARANTEE

a) **The Guarantee applies only to products used for private purposes and not for professional or commercial purposes.**

b) **The Guarantee does not apply in the case of normal wear and tear, improper or abusive use, failure to follow the instructions for use, use of the product at the wrong electrical voltage, installation and operation in violation of the applicable electrical regulations, and use of force (e.g. blows).**

c) **The Guarantee does not apply if the product has been modified or converted, e.g. conversions from 120 V products to 220-240 V products.**

d) **The provision of Guarantee services does not extend the Guarantee period, nor does it initiate the commencement of a new Guarantee period. The Guarantee period for installed spare parts ends with the Guarantee period for the entire product.**

### e) FOR SOUTH-AFRICA & UAE ONLY:

**Further or other claims, in particular claims for damages, are excluded unless liability is mandatory by law.**

After expiry of the Guarantee period or for products for which the Guarantee does not apply, the KitchenAid customer service centres are still available to the end-customer for questions and information.

Further information is also available on our website:

- For U.K. & Ireland [www.kitchenaid.eu](http://www.kitchenaid.eu)

- For South-Africa: [www.kitchenaidafrica.com](http://www.kitchenaidafrica.com)

- For UAE: [www.KitchenAid-MEA.com](http://www.KitchenAid-MEA.com)

## PRODUCT REGISTRATION

Register your new KitchenAid appliance now: <http://www.kitchenaid.eu/register>

©2021 All rights reserved.

