

# Dell UltraSharp 34 Curved USB-C Hub Monitor - U3423WE

## User's Guide

**Model:** U3423WE  
**Regulatory model:** U3423WEb





**NOTE: A NOTE indicates important information that helps you make better use of your computer.**



**CAUTION: A CAUTION indicates potential damage to hardware or loss of data if instructions are not followed.**



**WARNING: A WARNING indicates a potential for property damage, personal injury, or death.**

**Copyright © 2022 Dell Inc. or its subsidiaries. All rights reserved.** Dell, EMC, and other trademarks are trademarks of Dell Inc. or its subsidiaries. Other trademarks may be trademarks of their respective owners.

2022 - 09

Rev. A00

# Contents

<b>Safety instructions</b> . . . . .	<b>6</b>
<b>About your monitor</b> . . . . .	<b>7</b>
Package contents . . . . .	7
Product features . . . . .	9
Identifying parts and controls . . . . .	11
Front view . . . . .	11
Back view . . . . .	12
Bottom view . . . . .	13
<b>Monitor specifications</b> . . . . .	<b>15</b>
<b>Resolution specifications</b> . . . . .	<b>17</b>
Supported video modes . . . . .	17
Preset display modes . . . . .	18
Electrical specifications . . . . .	18
Physical characteristics . . . . .	20
Environmental characteristics . . . . .	21
Pin assignments . . . . .	22
<b>Universal Serial Bus (USB) interface</b> . . . . .	<b>24</b>
USB 3.2 downstream connector . . . . .	24
USB Type-C connector . . . . .	25
USB ports . . . . .	25
RJ45 Connector . . . . .	26
<b>Plug and play capability</b> . . . . .	<b>29</b>
<b>LCD monitor quality and pixel policy</b> . . . . .	<b>29</b>
<b>Ergonomics</b> . . . . .	<b>29</b>
<b>Handling and moving your display</b> . . . . .	<b>31</b>
<b>Maintenance guidelines</b> . . . . .	<b>32</b>



Cleaning your monitor . . . . .	32
<b>Setting up the monitor . . . . .</b>	<b>34</b>
Attaching the stand . . . . .	34
Organizing your cables. . . . .	37
Connecting your monitor . . . . .	37
Connecting the DisplayPort (DisplayPort to DisplayPort) cable. . . . .	38
Connecting the HDMI cable . . . . .	38
Connecting the USB Type-C cable . . . . .	38
Connecting the monitor for RJ45 Cable (Optional) . . . . .	39
Connecting the super speed USB 10 Gbps (USB 3.2 Gen2) cable. . . . .	39
Dell Power Button Sync (DPBS) . . . . .	41
Connecting the Monitor for DPBS for the First Time . . . . .	44
Using DPBS Function. . . . .	45
Connecting the monitor for USB-C . . . . .	47
Securing your monitor using Kensington lock (optional) . . . . .	49
Removing the monitor stand . . . . .	49
VESA wall mounting (optional) . . . . .	50
<b>Operating the monitor . . . . .</b>	<b>51</b>
Power on the monitor . . . . .	51
Using the Joystick Control. . . . .	51
Using the navigation keys . . . . .	53
Using the On-Screen Display (OSD) menu . . . . .	54
Accessing the menu system . . . . .	54
OSD warning message . . . . .	70





Setting the maximum resolution . . . . .	76
Setting the KVM switch . . . . .	77
Setting the Auto KVM . . . . .	79
Using the tilt, swivel, vertical extension, and slant adjust . . . . .	81
Tilt, swivel . . . . .	81
Vertical extension . . . . .	81
Slant adjust . . . . .	82
<b>Troubleshooting . . . . .</b>	<b>83</b>
Self-test . . . . .	83
Using the joystick to lock/unlock buttons . . . . .	84
Locking the power and joystick buttons . . . . .	84
Always On USB Type-C Charging . . . . .	85
Common problems . . . . .	86
Product specific problems . . . . .	89
Universal Serial Bus (USB) specific problems . . . . .	90
Speakers Specific Problems . . . . .	92
<b>Regulatory information . . . . .</b>	<b>93</b>
FCC notices (U.S. only) and other regulatory information . . . . .	93
EU product database for energy label and product information sheet . . . . .	93
<b>Contact Dell . . . . .</b>	<b>94</b>



# Safety instructions

Use the following safety guidelines to protect your monitor from potential damage and to ensure your personal safety. Unless otherwise noted, each procedure included in this document assumes that you have read the safety information that shipped with your monitor.

 **NOTE: Before using the monitor, read the safety instruction that is shipped with your monitor and printed on the product. Keep the documentation at a secure location for future reference.**

 **WARNING: Use of controls, adjustments, or procedures other than those specified in this documentation may result in exposure to shock, electrical hazards, and/or mechanical hazards.**

 **WARNING: The possible long-term effect of listening to audio at high volume through the headphones (on monitor that support it) may cause damage to your hearing ability.**

- Place the monitor on a solid surface and handle it carefully. The screen is fragile and can be damaged if dropped or hit with a sharp object.
- Ensure that your monitor is electrically rated to operate with the AC power available in your location.
- Keep the monitor in room temperature. Excessive cold or hot conditions can have an adverse effect on the liquid crystals of the display.
- Connect the power cable from the monitor to a wall outlet that is near and accessible. See [Connecting your monitor](#).
- Do not place and use the monitor on a wet surface or near water.
- Do not subject the monitor to severe vibration or high impact conditions. For example, do not place the monitor inside a car trunk.
- Unplug the monitor when it is going to be left unused for an extended period.
- To avoid electric shock, do not attempt to remove any cover or touch the inside of the monitor.
- Read these instructions carefully. Keep this document for future reference. Follow all warnings and instructions marked on the product.
- Certain monitors can be wall mounted using the VESA mount that is sold separately. Ensure to use the correct VESA specifications as mentioned in the wall mounting section of the *User's Guide*.

For information on safety instructions, see the *Safety, Environmental, and Regulatory Information (SERI)* document that is shipped with your monitor.





# About your monitor







## Package contents

The following table provides the list of components that are shipped with your monitor. If any component is missing, contact Dell. For more information, see [Contact Dell](#).

 **NOTE: Some items may be optional and may not ship with your monitor. Some features may not be available in certain countries.**

	Display
	Stand riser
	Stand base



	<p>Power cable (varies by country)</p>
	<p>DisplayPort cable (DP to DP) Cable length: 1.80 M</p>
	<p>HDMI cable Cable length: 1.80 M</p>
	<p>USB Type-C cable Cable length: 1.00 M</p>
	<p>USB-A to USB-C Gen2 Cable Cable length: 1.00 M</p>
	<ul style="list-style-type: none"> <li>• Quick Setup Guide</li> <li>• Safety, Environmental, and Regulatory Information</li> <li>• Factory calibration report</li> </ul>





## Product features

The **Dell U3423WE** monitor has an active matrix, Thin-Film Transistor (TFT), Liquid Crystal Display (LCD) and LED backlight. The monitor features include:

- 86.72 cm (34.14 in.) viewable area (measured diagonally).  
3440 x 1440 (21:9) resolution, plus full-screen support for lower resolutions.
- Wide viewing angle to allow viewing from a sitting or standing position.
- Color gamut of DCI-P3 98%, Display P3 98%, sRGB 100%, and Rec 709 100% with an average Delta E  $\leq$  2.
- Digital connectivity with DisplayPort, USB Type-C and HDMI.
- Single USB Type-C to supply power (PD 90 W) to a compatible notebook while receiving video & data signal.
- Tilt, swivel, height, and slant adjust capabilities.
- Ultra-thin bezel minimizes the bezel gap in multi-monitor usage, enabling easier setup with an elegant viewing experience.
- Removable stand and Video Electronics Standards Association (VESA™) 100 mm mounting holes for flexible mounting solutions.
- Equipped with:
  - 1 USB Type-C upstream port (video and data; DP1.4 with Alternate mode, PD up to 90 W)
  - 1 USB Type-C upstream port (data only)
  - 1 super speed USB 10 Gbps (USB 3.2 Gen2) Type-C downstream port
  - 1 super speed USB 10 Gbps (USB 3.2 Gen2) Type-A downstream charging port
  - 4 super speed USB 10 Gbps (USB 3.2 Gen2) Type-A downstream ports
- USB-C and RJ45 ports enable a single-cable, network-connected experience.
- Plug and play capability if supported by your system.
- On-Screen Display (OSD) adjustments for ease of set-up and screen optimization.
- Supports Picture by Picture (PBP) and Picture in Picture (PIP) Select mode.
- The built-in KVM switch allows you to control up to 2 computers from a single set of keyboard and mouse connected to the monitor.
- Supports Auto KVM for multiple input setup.
- Power and OSD buttons lock.
- Security-lock slot.
- Stand lock.
- $\leq$  0.3 W in Standby Mode.



- Built-in speakers (5 W) x 2.
- Optimize eye comfort with a flicker-free screen and ComfortView Plus feature.
- This monitor uses low blue light panel. When the monitor is reset to factory settings or default setting (**Preset mode: Standard**), it works in compliance with TÜV Rheinland (hardware solutions provider).

 **WARNING: The possible long-term effects of blue light emission from the monitor may cause damage to the eyes, which includes but is not limited to eye fatigue and digital eye strain. ComfortView Plus feature is designed to reduce the amount of blue light emitted from the monitor to optimize eye comfort.**



# Identifying parts and controls

## Front view



Label	Description	Use
1	Power LED indicator	Solid white light indicates that the monitor is turned on and functioning normally. Blinking white light indicates that the monitor is in Standby Mode.



## Back view



### Back view with monitor stand

Label	Description	Use
1	VESA mounting holes (100 mm x 100 mm - behind attached VESA Cover)	Wall mount monitor using VESA-compatible wall mount kit (100 mm x 100 mm).
2	Regulatory label	Lists the regulatory approvals.
3	Stand release button	Releases stand from the monitor.
4	Barcode, serial number, and Service Tag label	Refer to this label if you need to contact Dell for technical support.
5	Power On/Off button	To turn the monitor on or off.
6	Joystick	Use to control the OSD menu. (For more Information, see <a href="#">Operating the monitor</a> )
7	Cable-management slot	Use to organize cables by inserting them through the slot.



## Bottom view

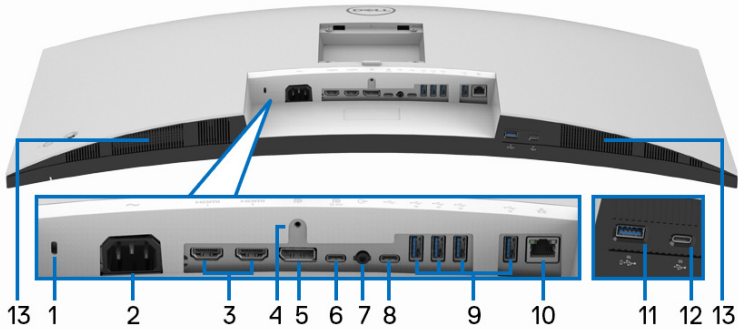

**Bottom view without monitor stand**

Label	Description	Use
1	Security lock slot (based on Kensington Security Slot™)	Secures the monitor with security lock (security lock not included).
2	Power connector	Connect the power cable (shipped with your monitor).
3	HDMI port (2)	Connect your computer with the HDMI cable.
4	Stand lock feature	To lock the stand to the monitor using a M3 x 6 mm screw (screw not included).
5	DisplayPort	Connect your computer with the DisplayPort cable.



<p><b>6</b></p>	<p>Super speed USB 10 Gbps (USB 3.2 Gen2) Type-C upstream port (video and data)</p>	<p>Connect the USB Type-C cable that came with your monitor to the computer or mobile device. This port supports USB Power Delivery, Data, and DisplayPort video signal.</p> <p>The super speed USB 10 Gbps (USB 3.2 Gen2) Type-C port offers the fastest transfer rate and the alternate mode with DP 1.4 supports a maximum resolution of 3440 x 1440 at 60 Hz, PD 20 V/4.5 A, 15 V/3 A, 9 V/3 A, 5 V/3 A.</p> <p><b>NOTE:</b> USB Type-C is not supported on versions of Windows prior to Windows 10.</p>
<p><b>7</b></p>	<p>Audio line-out port</p>	<p>Connect your external speakers.*</p>
<p><b>8</b></p>	<p>Super speed USB 10 Gbps (USB 3.2 Gen2) Type-C upstream port (data only)</p> 	<p>Connect the USB-A to USB-C cable that came with your monitor to the computer. This port supports USB data transfer at 10 Gbps (USB 3.2 Gen2). Once this cable is connected, you can use the USB connectors on the monitor.</p> <p><b>NOTE:</b> USB Type-C is not supported on versions of Windows prior to Windows 10.</p>
<p><b>9</b></p>	<p>Super speed USB 10 Gbps (USB 3.2 Gen2) Type-A downstream port (4)</p>	<p>Connect your USB device.**</p> <p><b>NOTE:</b> To use this port, you must connect the USB Type-C cable or USB Type-C to Type-A Cable (shipped with your monitor) to the USB Type-C upstream port on the monitor and to your computer.</p>
<p><b>10</b></p>	<p>RJ45 port</p>	<p>Support Ethernet connection 10/100/1000 Mbps.</p>
<p><b>11</b></p>	<p>Super speed USB 10 Gbps (USB 3.2 Gen2) Type-A downstream port with Power Charging</p>	<p>Connect your USB device** or charge your device</p> <p><b>NOTE:</b> To use this port, you must connect the USB Type-C cable or USB Type-C to Type-A Cable (shipped with your monitor) to the USB Type-C upstream port on the monitor and to your computer.</p>



<b>12</b>	Super speed USB 10 Gbps (USB 3.2 Gen2) Type-C downstream port	Connect your USB device.** <b>NOTE:</b> To use this port, you must connect the USB Type-C cable or USB Type-C to Type-A Cable (shipped with your monitor) to the USB Type-C upstream port on the monitor and to your computer.
<b>13</b>	Speakers	Provides audio output.

\*Headphone usage is not supported for the audio line out connector.

\*\*To avoid signal interference, when a wireless USB device has been connected to a USB downstream port, it is NOT recommended to connect any other USB devices to the adjacent port(s).

## Monitor specifications

<b>Model</b>	<b>U3423WE</b>
Screen type	Active matrix - TFT LCD
Panel technology	In-Plane Switching Technology
Aspect ratio	21:9
Viewable image	
Diagonal	867.16 mm (34.14 in.)
Width (active area)	800.05 mm (31.50 in.)
Height (active area)	335.05 mm (13.19 in.)
Total area	268056.75 mm <sup>2</sup> (415.49 in. <sup>2</sup> )
Pixel pitch	0.2325 mm x 0.2325 mm
Pixel per inch (PPI)	109
Viewing angle	178° (vertical) typical 178° (horizontal) typical
Luminance output	300 cd/m <sup>2</sup> (typical)
Contrast ratio	2000 to 1 (typical)
Faceplate coating	Anti-Glare with 3H hardness
Backlight	White LED edgelight system



Response time	8 ms (Normal) 5 ms (Fast)
Color depth	1.07 billion colors
Color gamut	<ul style="list-style-type: none"> <li>• DCI-P3 98%</li> <li>• Display P3 98%</li> <li>• sRGB 100%</li> <li>• Rec 709 100%</li> </ul>
Calibration accuracy	DCI-P3, Display P3, sRGB, & Rec 709: Delta E $\leq$ 2 (average)
Connectivity	<ul style="list-style-type: none"> <li>• 1 x DisplayPort version 1.4 (HDCP2.2)</li> <li>• 2 x HDMI port version 2.1 (TMDS) (HDCP2.2)</li> <li>• 1 x USB Type-C upstream port (video and data) (Alternate mode with DisplayPort 1.4, Power Delivery PD up to 90 W)*</li> <li>• 1 x USB-C upstream port (data only, 10 Gbps USB 3.2 Gen2)</li> <li>• 4 x super speed USB 10 Gbps (USB 3.2 Gen2) Type-A downstream port</li> <li>• 1 x super speed USB 10 Gbps (USB 3.2 Gen2) Type-C downstream port with charging capability at 15 W (maximum)</li> <li>• 1 x super speed USB 10 Gbps (USB 3.2 Gen2) Type-A with BC1.2 charging capability at 2 A (maximum)</li> <li>• 1 x Audio line-out port</li> <li>• 1 x RJ45 port</li> </ul>
Border width (edge of monitor to active area)	10.35 mm (Top) 9.66 mm (Left/Right) 13.90 mm (Bottom)





Adjustability	
Height adjustable stand	150 mm
Tilt	-5° to 21°
Swivel	-30° to 30°
Slant adjust	-4° to 4°
 <b>NOTE:</b> Do not mount or use this monitor in portrait (vertical) orientation or inverse (180°) landscape mount as it may damage the monitor.	
Built-in speakers	2 x 5 W sound output
Dell Display Manager compatibility	Easy Arrange and other key features
Security	Security lock slot (cable lock sold separately)

\*DisplayPort and USB Type-C (Alternate mode with DisplayPort 1.4): HBR3/DisplayPort 1.4/DP audio is supported.

## Resolution specifications

<b>Model</b>	<b>U3423WE</b>
Horizontal scan range	30 kHz to 90 kHz (automatic)
Vertical scan range	56 Hz to 76 Hz (automatic)
Maximum preset resolution	3440 x 1440 at 60 Hz

## Supported video modes

<b>Model</b>	<b>U3423WE</b>
Video display capabilities (HDMI & DisplayPort & USB Type-C alternate mode)	480p, 576p, 720p, 1080i*, 1080p

\*For HDMI input only.



## Preset display modes

Display mode	Horizontal frequency (kHz)	Vertical frequency (Hz)	Pixel clock (MHz)	Sync polarity (Horizontal /Vertical)
VESA, 720 x 400	31.5	70.1	28.3	-/+
VESA, 640 x 480	31.5	59.9	25.2	-/-
VESA, 640 x 480	37.5	75.0	31.5	-/-
VESA, 800 x 600	37.9	60.3	40.0	+/+
VESA, 800 x 600	46.9	75.0	49.5	+/+
VESA, 1024 x 768	48.4	60.0	65.0	-/-
VESA, 1024 x 768	60.0	75.0	78.8	+/+
VESA, 1152 x 864	67.5	75.0	108.0	+/+
VESA, 1280 x 800 - R	49.3	59.9	71.0	+/-
VESA, 1280 x 1024	64.0	60.0	108.0	+/+
VESA, 1280 x 1024	80.0	75.0	135.0	+/+
VESA, 1600 x 1200	75.0	60.0	162.0	+/+
VESA, 1920 x 1080	67.5	60.0	148.5	+/+
VESA, 2560 x 1440	88.8	60.0	241.5	+/-
VESA, 3440 x 1440*	88.8	60.0	319.8	+/-

\* Requires a graphics card that supports HDMI 2.1 (TMDS).

## Electrical specifications

Model	U3423WE
Video input signals	HDMI 2.1 (TMDS)*/DisplayPort 1.4**, 600 mV for each differential line, 100 ohm input impedance per differential pair
AC input voltage/frequency/current	100 VAC to 240 VAC / 50 Hz or 60 Hz $\pm$ 3 Hz / 3.0 A (typical)



Inrush current	<ul style="list-style-type: none"> <li>• 120 V: 40 A (Max.) at 0°C (cold start)</li> <li>• 240 V: 80 A (Max.) at 0°C (cold start)</li> </ul>
Power consumption	<ul style="list-style-type: none"> <li>• 0.3 W (Off mode)<sup>1</sup></li> <li>• 0.3 W (Standby mode)<sup>1</sup></li> <li>• 31 W (On mode)<sup>1</sup></li> <li>• 198 W (Max.)<sup>2</sup></li> <li>• 26.24 W (Pon)<sup>3</sup></li> <li>• 85.06 kWh (TEC)<sup>3</sup></li> </ul>

\*Not supporting the HDMI 2.1 optional specification, including HDMI Ethernet Channel (HEC), Audio Return Channel (ARC), standard for 3D format and resolutions, standard for 4K digital cinema resolution, HDR, Fixed Rate Link (FRL), Enhanced Audio Return Channel (eARC), Variable Refresh Rate (VRR), Quick Media Switching (QMS), Quick Frame Transport (QFT), Auto Low Latency Mode (ALLM), Display Stream Compression (DSC), and Source-Based Tone Mapping (SBTM).

\*\*HBR3/DisplayPort 1.4/DP audio is supported.

<sup>1</sup> As defined in EU 2019/2021 and EU 2019/2013.

<sup>2</sup> Max brightness and contrast setting with maximum power loading on all USB ports.

<sup>3</sup> Pon: Power consumption of On mode as defined in Energy Star 8.0 version.

TEC: Total energy consumption in kWh as defined in Energy Star 8.0 version.

This document is informational only and reflects laboratory performance. Your product may perform differently, depending on the software, components and peripherals you ordered and shall have no obligation to update such information.

Accordingly, the customer should not rely upon this information in making decisions about electrical tolerances or otherwise. No warranty as to accuracy or completeness is expressed or implied.

 **NOTE: This monitor is ENERGY STAR certified. This product qualifies for ENERGY STAR in the factory default settings which can be restored by “Factory Reset” function in the OSD menu. Changing the factory default settings or enabling other features may increase power consumption that could exceed the ENERGY STAR specified limit.**



## Physical characteristics

<b>Model</b>	<b>U3423WE</b>
<b>Signal cable type</b>	<ul style="list-style-type: none"> <li>• Digital: DisplayPort, 20 pins</li> <li>• Digital: HDMI, 19 pins</li> <li>• Universal Series Bus: Type-C, 24 pins</li> <li>• Universal Serial Bus: USB-C to USB-A</li> </ul>
<p><b>NOTE:</b> Dell monitors are designed to work optimally with the video cables that are shipped with your monitor. As Dell does not have control over the different cable suppliers in the market, the type of material, connector and process used to manufacture these cables, Dell does not guarantee video performance on cables that are not shipped with your Dell monitor.</p>	
<b>Dimensions (with stand)</b>	
Height (extended)	542.77 mm (21.37 in.)
Height (compressed)	392.77 mm (15.46 in.)
Width	813.26 mm (32.02 in.)
Depth	237.44 mm (9.35 in.)
<b>Dimensions (without stand)</b>	
Height	359.05 mm (14.14 in.)
Width	813.26 mm (32.02 in.)
Depth	57.50 mm (2.26 in.) / 60.15 mm (2.37 in.)
<b>Stand dimensions</b>	
Height (extended)	433.30 mm (17.06 in.)
Height (compressed)	386.50 mm (15.22 in.)
Width	357.50 mm (14.07 in.)
Depth	237.44 mm (9.35 in.)
Base	357.50 mm (14.07 in.) x 235.00 mm (9.25 in.)
<b>Weight</b>	
Weight with packaging	15.65 kg (34.49 lb)
Weight with stand assembly and cables	11.44 kg (25.21 lb)



Weight without stand assembly (For wall mount or VESA mount considerations - no cables)	7.72 kg (17.01 lb)
Weight of stand assembly	3.29 kg (7.25 lb)

## Environmental characteristics

<b>Model</b>	<b>U3423WE</b>
<b>Compliant standards</b>	
<ul style="list-style-type: none"> <li>ENERGY STAR certified monitor</li> <li>EPEAT registered where applicable. EPEAT registration varies by country. See <a href="http://www.epeat.net">www.epeat.net</a> for registration status by country.</li> <li>RoHS-compliant</li> <li>TCO Certified &amp; TCO Certified Edge</li> <li>BFR/PVC free monitor (excluding external cables)</li> <li>Arsenic-free glass and Mercury-free for the panel only</li> </ul>	
<b>Temperature</b>	
Operating	0°C to 40°C (32°F to 104°F)
Non-operating	<ul style="list-style-type: none"> <li>Storage: -20°C to 60°C (-4°F to 140°F)</li> <li>Shipping: -20°C to 60°C (-4°F to 140°F)</li> </ul>
<b>Humidity</b>	
Operating	10% to 80% (non-condensing)
Non-operating	<ul style="list-style-type: none"> <li>Storage: 5% to 90% (non-condensing)</li> <li>Shipping: 5% to 90% (non-condensing)</li> </ul>
<b>Altitude</b>	
Operating	5000 m (16404 ft) (maximum)
Non-operating	12192 m (40000 ft) (maximum)
<b>Thermal dissipation</b>	<ul style="list-style-type: none"> <li>675.58 BTU/hour (maximum)</li> <li>105.77 BTU/hour (typical)</li> </ul>



## Pin assignments

### DisplayPort connector (in)



Pin number	20-pin side of the connected signal cable
1	ML3 (n)
2	GND
3	ML3 (p)
4	ML2 (n)
5	GND
6	ML2 (p)
7	ML1 (n)
8	GND
9	ML1 (p)
10	ML0 (n)
11	GND
12	ML0 (p)
13	GND
14	GND
15	AUX (p)
16	GND
17	AUX (n)
18	Hot Plug Detect
19	Re-PWR
20	+3.3 V DP_PWR



## HDMI connector

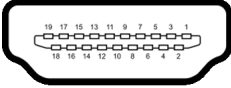

Pin number	19-pin side of the connected signal cable
1	TMDS DATA 2+
2	TMDS DATA 2 SHIELD
3	TMDS DATA 2-
4	TMDS DATA 1+
5	TMDS DATA 1 SHIELD
6	TMDS DATA 1-
7	TMDS DATA 0+
8	TMDS DATA 0 SHIELD
9	TMDS DATA 0-
10	TMDS CLOCK+
11	TMDS CLOCK SHIELD
12	TMDS CLOCK-
13	CEC
14	Reserved (N.C. on device)
15	DDC CLOCK (SCL)
16	DDC DATA (SDA)
17	DDC/CEC Ground
18	+5 V POWER
19	HOT PLUG DETECT



## Universal Serial Bus (USB) interface

This section gives you information about the USB ports that are available on the monitor.

 **NOTE: This monitor is super speed USB 10 Gbps (USB 3.2 Gen2) compatible.**

Transfer speed	Data rate	Maximum power supported*
Super speed	10 Gbps	4.5 W
High speed	480 Mbps	4.5 W
Full speed	12 Mbps	4.5 W

\*Up to 2 A on USB downstream port (with  battery icon) with BC1.2 compliance devices or normal USB devices.

USB Type-C	Description
Video	DisplayPort 1.4*
Data	Super speed USB 10 Gbps (USB 3.2 Gen2)
Power Delivery (PD)	Up to 90 W

\*HBR3/DisplayPort 1.4/DP audio is supported.

### USB 3.2 downstream connector



Pin number	9-pin side of the connector
1	VCC
2	D-
3	D+
4	GND
5	SSRX-
6	SSRX+





<b>7</b>	GND
<b>8</b>	SSTX-
<b>9</b>	SSTX+

## USB Type-C connector

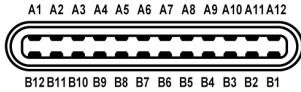

Pin Number	Signal Name	Pin Number	Signal Name
A1	GND	B1	GND
A2	TX1+	B2	TX2+
A3	TX1-	B3	TX2-
A4	VBUS	B4	VBUS
A5	CC1	B5	CC2
A6	D+	B6	D+
A7	D-	B7	D-
A8	SBU1	B8	SBU2
A9	VBUS	B9	VBUS
A10	RX2-	B10	RX1-
A11	RX2+	B11	RX1+
A12	GND	B12	GND

## USB ports

- 1 super speed USB 10 Gbps (USB 3.2 Gen2) Type-C upstream (video + data) - bottom
  - 1 super speed USB 10 Gbps (USB 3.2 Gen2) Type-C upstream (data only) - bottom
  - 1 super speed USB 10 Gbps (USB 3.2 Gen2) Type-C downstream - bottom
  - 5 super speed USB 10 Gbps (USB 3.2 Gen2) Type-A downstream - bottom
- Power Charging Port - the port with  battery icon; supports up to 2 A fast-charging capability if the device is BC1.2 compatible.



**NOTE:** Super speed USB 10 Gbps (USB 3.2 Gen2) functionality requires a super speed USB 10 Gbps (USB 3.2 Gen2)-capable computer.

**NOTE:** The USB ports on the monitor work only when the monitor is turned On or in Standby mode. If you turn Off the monitor and then turn it On, the attached peripherals may take a few seconds to resume normal functionality.

## RJ45 Connector

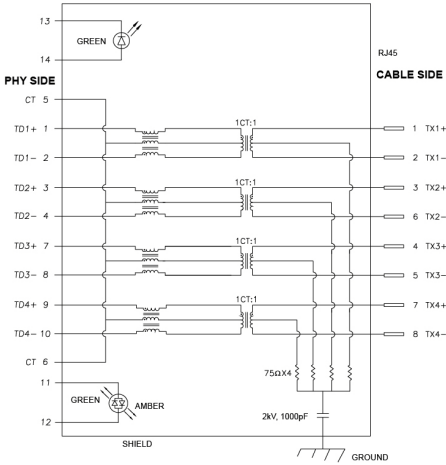

Pin	Signal
<b>P1</b>	MDI0+
<b>P2</b>	MDI0-
<b>P3</b>	MDI1+
<b>P4</b>	MDI1-
<b>P5</b>	CT
<b>P6</b>	CT
<b>P7</b>	MDI2+
<b>P8</b>	MDI2-
<b>P9</b>	MDI3+
<b>P10</b>	MDI3-



Pin number	Orange	Green
P11	-	+
P12	+	-
P13	N/A	+
P14	N/A	-

## Driver Installation

Install the Realtek USB GBE Ethernet Controller Driver available for your system. This is available for download at [www.dell.com/support](http://www.dell.com/support) under the “Driver and download” section.

Network (RJ45) data rate via USB-C:

- High Resolution: Up to 480 Mbps
- High Data Speed: Up to 1000 Mbps

 **NOTE: This LAN port is 1000Base-T IEEE 802.3az compliant, supporting Mac Address (Printed on model label) Pass-thru (MAPT), Wake-on-LAN (WOL) from standby mode (S3 only) and UEFI\* PXE Boot function [UEFI PXE Boot is not supported on Dell Desktop PC's (except for OptiPlex 7090/3090 Ultra Desktop)], these 3 features depend on BIOS settings and version of the OS. Functionality may vary with non-Dell PC's.**

\*UEFI stands for Unified Extensible Firmware Interface.



## RJ45 Connector LED Status

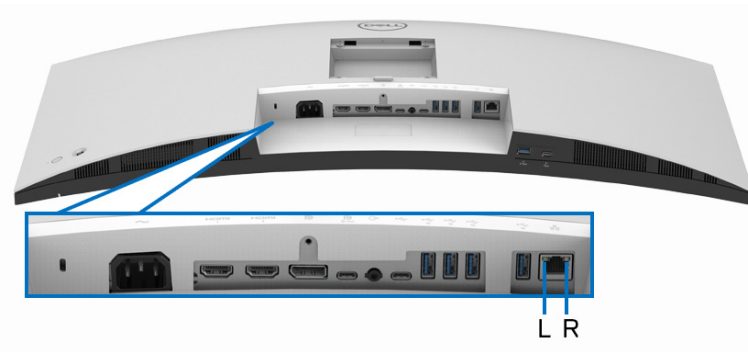

LED	Color	Description
Right LED	Amber or Green	Speed indicator: <ul style="list-style-type: none"><li>• Amber On - 1000 Mbps</li><li>• Green On - 100 Mbps</li><li>• Off - 10 Mbps</li></ul>
Left LED	Green	Link / Activity indicator: <ul style="list-style-type: none"><li>• Blinking - Activity on the port.</li><li>• Green On - Link is being established.</li><li>• Off - Link is not established.</li></ul>

 **NOTE: RJ45 cable is non in-box standard accessory.**



## Plug and play capability

You can connect the monitor to any Plug and Play-compatible system. The monitor automatically provides the computer with its Extended Display Identification Data (EDID) using Display Data Channel (DDC) protocols so that the computer can configure itself and optimize the monitor settings. Most monitor installations are automatic; you can select different settings as required. For more information about changing the monitor settings, see [Operating the monitor](#).

## LCD monitor quality and pixel policy

During the LCD Monitor manufacturing process, it is not uncommon for one or more pixels to become fixed in an unchanging state which are hard to see and do not affect the display quality or usability. For more information on Dell Monitor Quality and Pixel Policy, see [www.dell.com/pixelguidelines](http://www.dell.com/pixelguidelines).

## Ergonomics

**△ CAUTION: Improper or prolonged usage of keyboard may result in injury.**

**△ CAUTION: Viewing the monitor screen for extended periods of time may result in eye strain.**

For comfort and efficiency, observe the following guidelines when setting up and using your computer workstation:

- Position your computer so that the monitor and keyboard are directly in front of you as you work. Special shelves are commercially available to help you correctly position your keyboard.
- To reduce the risk of eye strain and neck, arm, back, or shoulder pain from using the monitor for long periods of time, we recommend you to:
  1. Set the distance of the screen between 20 to 28 in. (50 - 70 cm) from your eyes.
  2. Blink frequently to moisten your eyes or wet your eyes with water after prolonged usage of the monitor
  3. Take regular and frequent breaks for 20 minutes every two hours.
  4. Look away from your monitor and gaze at a distant object that is 20 feet away for at least 20 seconds during the breaks.
  5. Perform stretches to relieve tension in the neck, arm, back, and shoulders during the breaks.
- Ensure that the monitor screen is at eye level or slightly lower when you are sitting in front of the monitor.



- Adjust the tilt of the monitor, its contrast, and brightness settings.
- Adjust the ambient lighting around you (such as overhead lights, desk lamps, and the curtains or blinds on nearby windows) to minimize reflections and glare on the monitor screen.
- Use a chair that provides good lower-back support.
- Keep your forearms horizontal with your wrists in a neutral, comfortable position while using the keyboard or mouse.
- Always leave space to rest your hands while using the keyboard or mouse.
- Let your upper arms rest naturally on both sides.
- Ensure that your feet are resting flat on the floor.
- When sitting, make sure that the weight of your legs is on your feet and not on the front portion of your seat. Adjust your chair's height or use a footrest if necessary, to maintain a proper posture.
- Vary your work activities. Try to organize your work so that you do not have to sit and work for extended periods of time. Try to stand or get up and walk around at regular intervals.
- Keep the area under your desk clear of obstructions and cables or power cords that may interfere with comfortable seating or present a potential trip hazard.

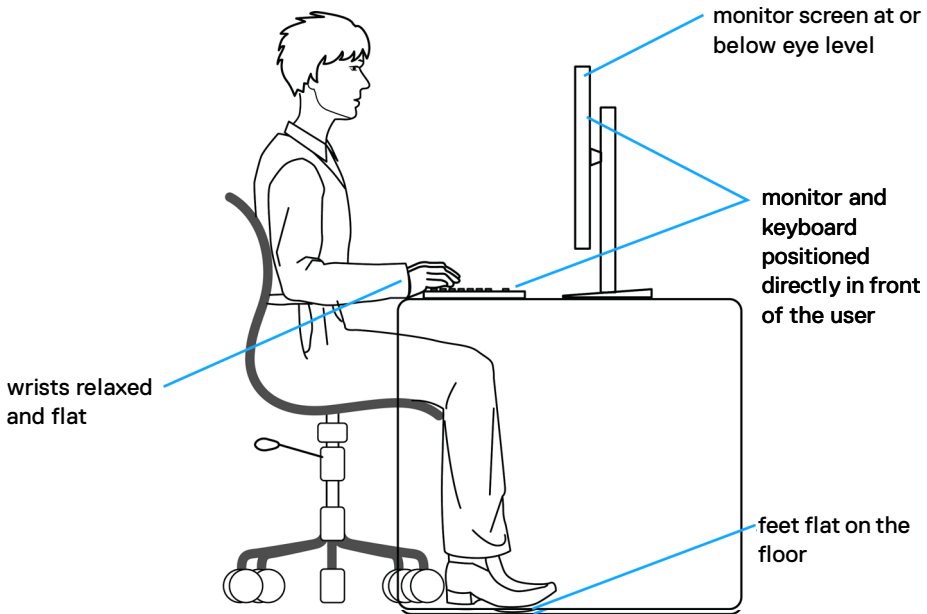

## Handling and moving your display

To ensure that the monitor is handled safely when lifting or moving it, follow these guidelines:

- Before moving or lifting the monitor, turn off your computer and the monitor.
- Disconnect all cables from the monitor.
- Place the monitor in the original box with the original packing materials.
- Hold the bottom edge and the side of the monitor firmly without applying excessive pressure when lifting or moving the monitor.

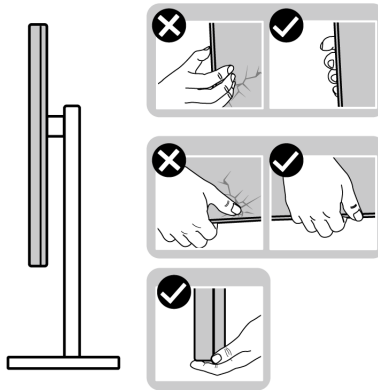

- When lifting or moving the monitor, ensure the screen is facing away from you and do not press on the display area to avoid any scratches or damage.

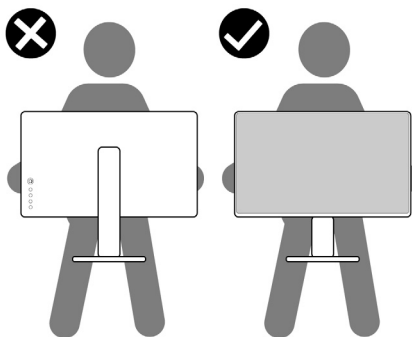

- When transporting the monitor, avoid any sudden shock or vibration to it.



- When lifting or moving the monitor, do not turn the monitor upside down while holding the stand base or stand riser. This may result in accidental damage to the monitor or cause personal injury.

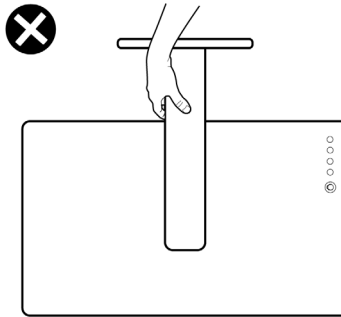

## Maintenance guidelines

### Cleaning your monitor

- ⚠ **WARNING:** Using improper methods when cleaning the monitor can result in a physical damage to the screen or the body of your Dell monitor.
- ⚠ **CAUTION:** Read and follow the [Safety instructions](#) before cleaning the monitor.
- ⚠ **WARNING:** Before cleaning the monitor, unplug the monitor power cable from the electrical outlet.

For best practices, follow the instructions in the list below when unpacking, cleaning, or handling your monitor:

- To clean the Dell monitor screen, lightly dampen a soft, clean cloth with water. If possible, use a special screen-cleaning tissue or solution suitable for the Dell monitor screen.
- ⚠ **CAUTION:** Do not use detergents or other chemicals such as benzene, thinner, ammonia, abrasive cleaners, or compressed air.
- ⚠ **CAUTION:** Using chemicals for cleaning may cause changes in the appearance of the monitor, such as color fading, milky film on the monitor, deformation, uneven dark shade, and peeling of screen area.





 **WARNING: Do not spray the cleaning solution or even water directly on the surface of the monitor. Doing so will allow liquids to accumulate at the bottom of the display panel and corrode the electronics resulting in permanent damage. Instead, apply the cleaning solution or water to a soft cloth and then clean the monitor.**



 **NOTE: Monitor damage due to improper cleaning methods and the use of benzene, thinner, ammonia, abrasive cleaners, alcohol, compressed air, detergent of any kind will lead to a Customer Induced Damage (CID). CID is not covered under the standard Dell warranty.**

- If you notice white powder when you unpack your monitor, wipe it off with a cloth.
- Handle your monitor with care as a darker-colored monitor may get scratched and show white scuff marks more than a lighter-colored monitor.
- To help maintain the best image quality on your monitor, use a dynamically changing screen saver and turn off your monitor when not in use.



# Setting up the monitor

## Attaching the stand

-  **NOTE: The stand is not installed at the factory when shipped.**
-  **NOTE: The following instructions are applicable only for the stand that was shipped with your monitor. If you are attaching a stand that you purchased from any other source, follow the setup instructions that were included with the stand.**

To attach the monitor stand:

1. Follow the instructions on the flaps of carton to remove the stand from the top cushion that secures it.
2. Remove the stand riser and stand base from the packaging cushion.

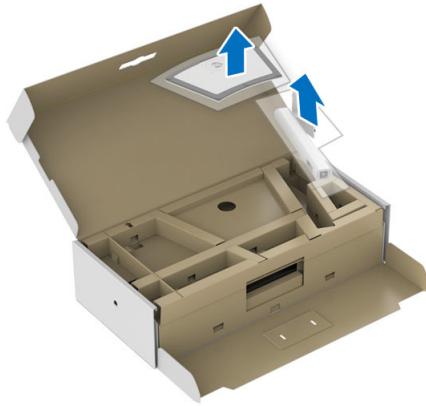

3. Insert the stand base blocks fully into the stand slot.
4. Lift the screw handle and turn the screw clockwise.
5. After fully tightening the screw, fold the screw handle flat within the recess.

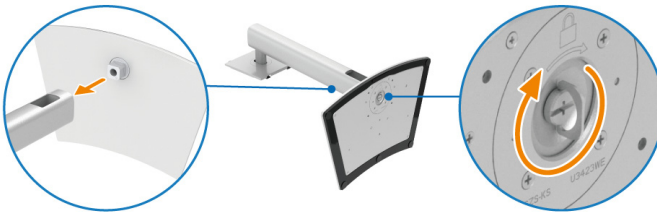

**6.** Lift the cover, as shown, to access the VESA area for stand assembly.



**7.** Attach the stand assembly to the monitor.

- a.** Fit the two tabs on the upper part of the stand to the groove on the back of the monitor.
- b.** Press the stand down till it snaps into place.

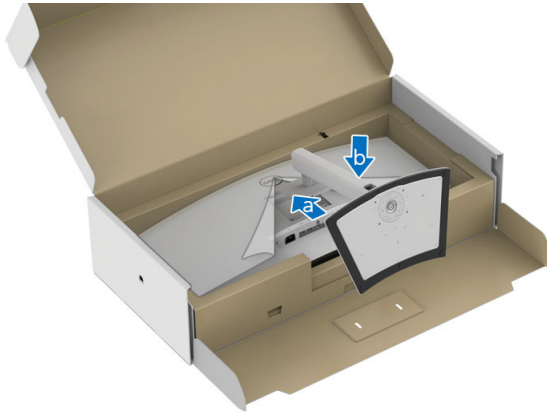

8. Place the monitor upright.

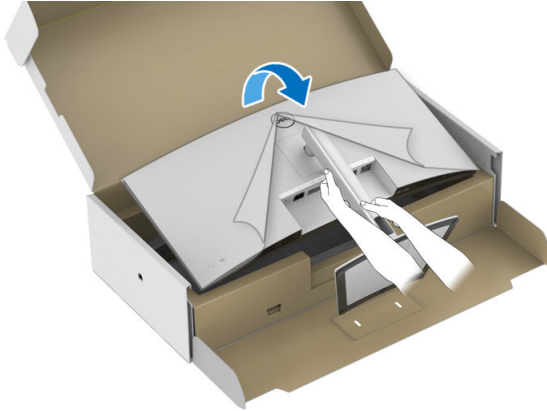

**NOTE:** Lift the monitor carefully to prevent it from slipping or falling.

9. Remove the cover from the monitor.

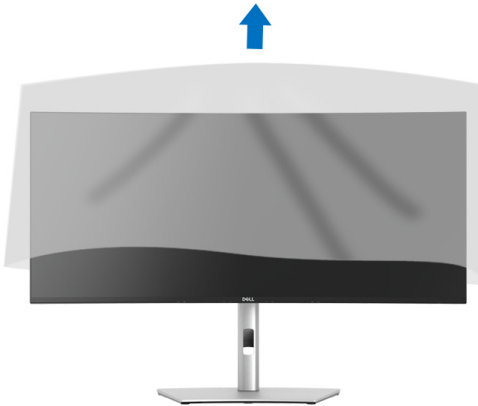

## Organizing your cables

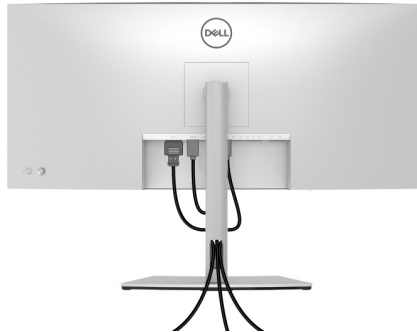

After attaching all necessary cables to your monitor and computer, (See [Connecting your monitor](#) for cable attachment,) organize all cables as shown above.

### Connecting your monitor

- ⚠ WARNING:** Before you begin any of the procedures in this section, follow the [Safety instructions](#).
- ✎ NOTE:** Dell monitors are designed to work optimally with the Dell-supplied cables inside the box. Dell does not guarantee the video quality and performance if non-Dell cables are used.
- ✎ NOTE:** Route the cables through the cable-management slot before connecting them.
- ✎ NOTE:** Do not connect all cables to the computer at the same time.
- ✎ NOTE:** The images are for the purpose of illustration only. The appearance of the computer may vary.

To connect your monitor to the computer:

1. Turn Off your computer and disconnect the power cable.
2. Connect the DisplayPort, HDMI, or USB Type-C cable from your monitor to the computer.



## Connecting the DisplayPort (DisplayPort to DisplayPort) cable

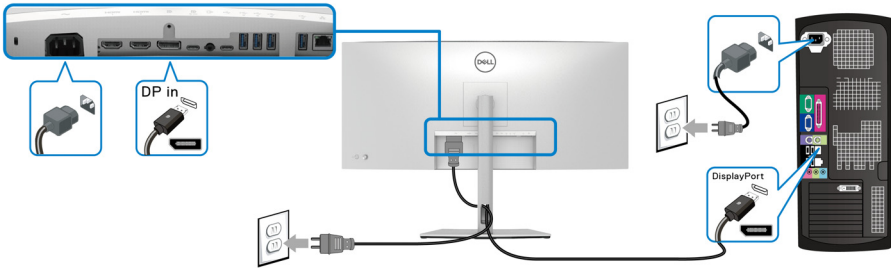

## Connecting the HDMI cable

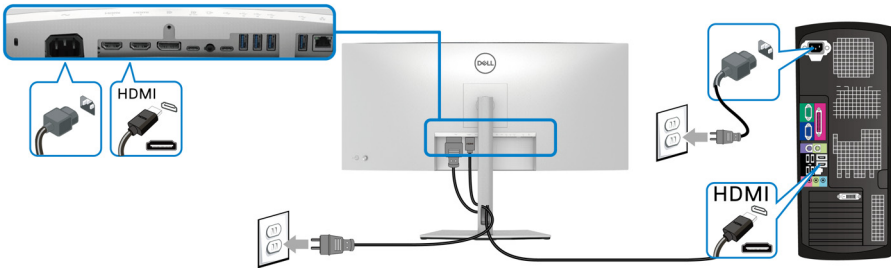

## Connecting the USB Type-C cable

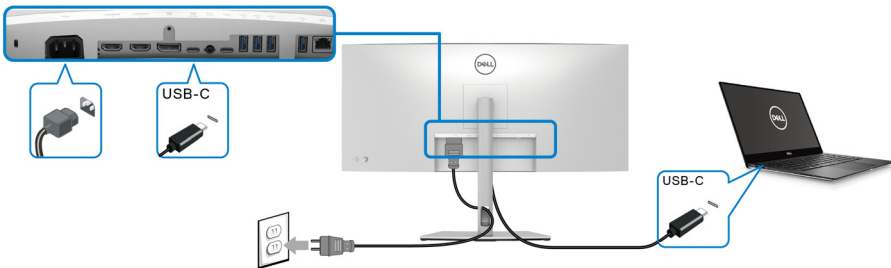

### **NOTE: Use the USB Type-C cable shipped with monitor only.**

- This port supports DisplayPort Alternate Mode (DP1.4 standard only).
- The USB Type-C power delivery compliant port (PD Version 3.0) delivers up to 90 W of power.



- If your notebook requires more than 90 W to operate and the battery is drained, it may not be powered up or charged with the USB PD port of this monitor.

## Connecting the monitor for RJ45 Cable (Optional)

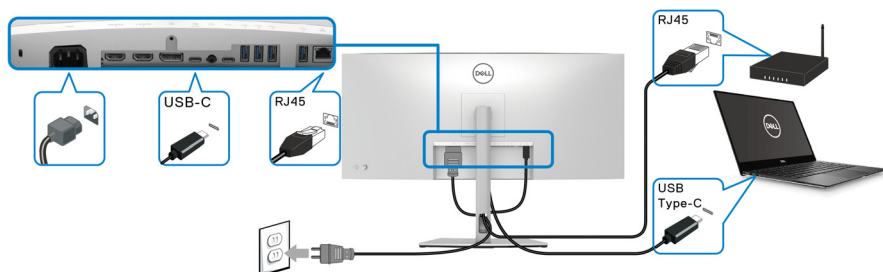

**NOTE:** RJ45 cable is non in-box standard accessory.

## Connecting the super speed USB 10 Gbps (USB 3.2 Gen2) cable

**NOTE:** To prevent data damage or loss, before unplugging the USB upstream port, make sure that NO USB storage devices are in use by the computer connected to the monitor's USB downstream port.

After you have completed connecting the DisplayPort/HDMI/USB Type-C cable, follow the procedures below to connect the USB cable to the computer and complete your monitor setup:

- 1. a. Connect one computer:** connect the USB 3.2 (Gen2) Type-C upstream port (data only) (cable supplied) to an appropriate USB 3.2 (Gen2) port on your computer.
  - 1. b. Connect two computers\*:** connect the USB 3.2 (Gen2) Type-C upstream port (data only) (cable supplied) and USB Type-C upstream port (video and data) (cable supplied) to appropriate USB ports on the two computers. Then use the OSD menu to select between the USB upstream source and input sources. See [USB](#).
- 2.** Connect the USB peripherals to the USB downstream ports on the monitor.



3. Plug the power cables for your computer(s) and monitor into a nearby outlet.

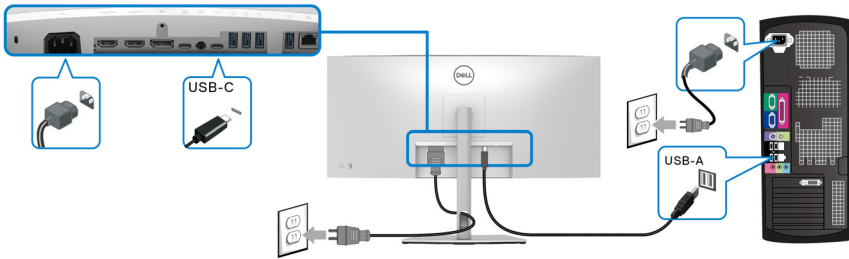

**a. Connect one computer**

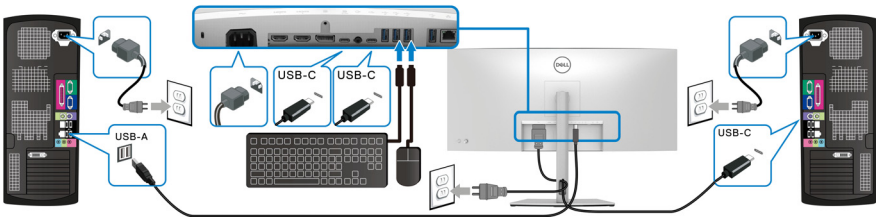

**b. Connect two computers**

\* When connecting two computers to the monitor, configure the **USB** settings from the OSD menu to share a single set of keyboard and mouse connected to the monitor between two computers. See **USB** and **Setting the KVM switch** for details.

4. Turn On the monitor and the computer(s).  
If your monitor displays an image, installation is complete. If it does not display an image, see **Common problems**.





## Dell Power Button Sync (DPBS)

Your monitor is designed with Dell Power Button Sync (DPBS) feature to allow you to control PC system power state from the monitor power button. This feature is only supported with Dell platform which has built-in DPBS function, and is only supported over USB-C interface.

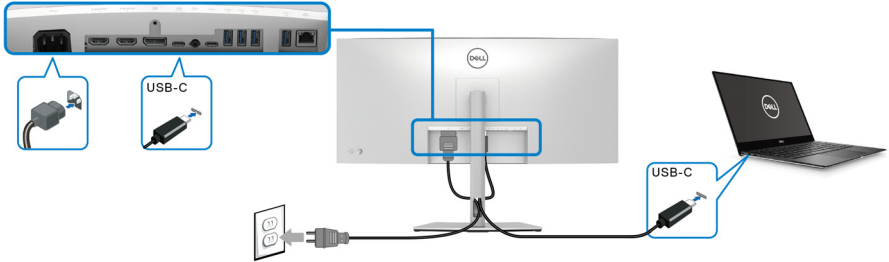

To make sure the DPBS function works for the first time, perform the following steps on the DPBS supported platform in the **Control Panel** first.

**NOTE:** DPBS only supports the USB Type-C upstream port with  icon.

1. Go to **Control Panel**.

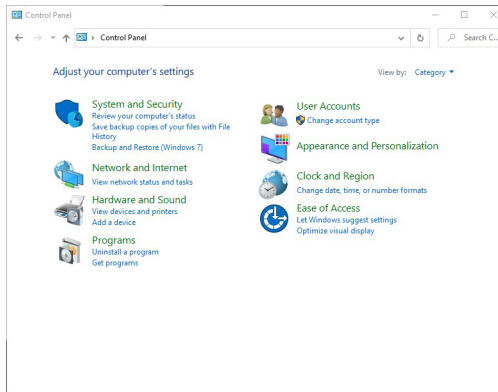

## 2. Select **Hardware and Sound**, followed by **Power Options**.

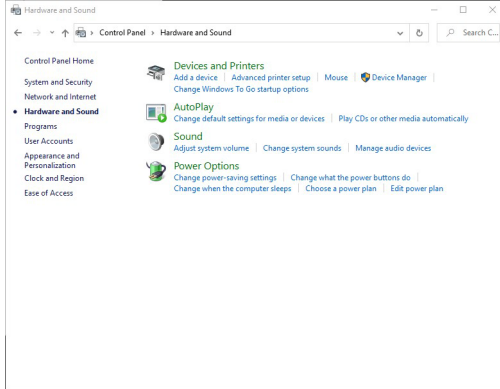

## 3. Go to **System Settings**.

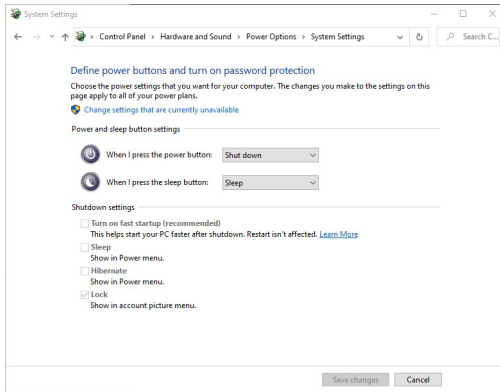

4. In the drop-down menu of **When I press the power button**, there are a few options for selection, namely **Do nothing/Sleep/Hibernate/Shut down**. You can select **Sleep/Hibernate/Shut down**.

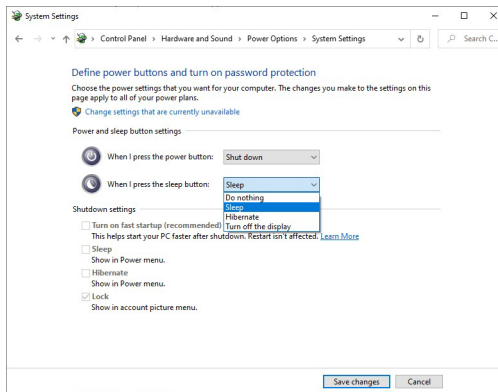
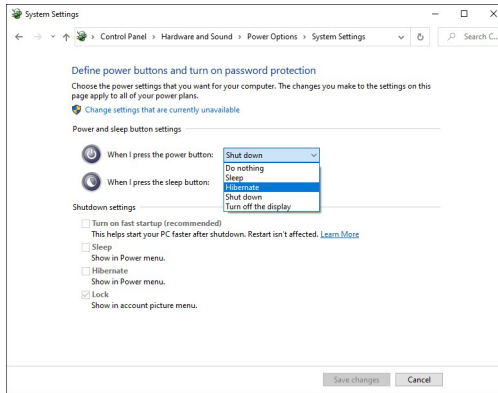

**NOTE:** Do not select “Do nothing”, otherwise the monitor power button will not be able to sync with PC system power state.



## Connecting the Monitor for DPBS for the First Time

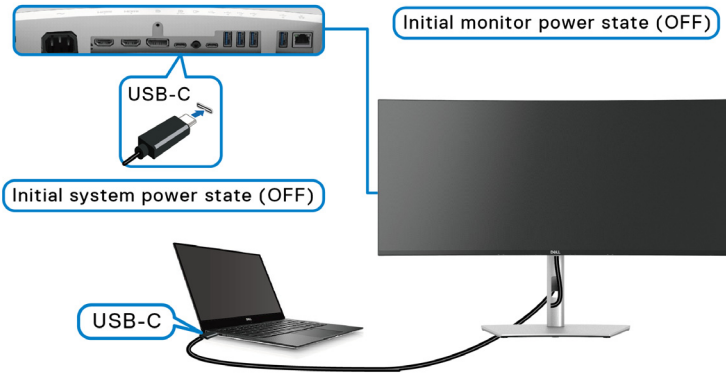

For the first time setting up the DPBS function:

1. Make sure both the PC and the monitor are OFF.
2. Press the monitor power button to turn ON the monitor.
3. Connect the USB-C cable from the PC to the monitor.
4. Both the monitor and PC will turn ON normally. If not, press either the monitor power button or PC power button to boot up the system.



**NOTE: Ensure that Dell Power Button Sync is set to On. See [Dell Power Button Sync](#).**



## Using DPBS Function

### Waking on the USB-C cable

When you connect the USB-C cable, the Monitor/PC state is as follows:

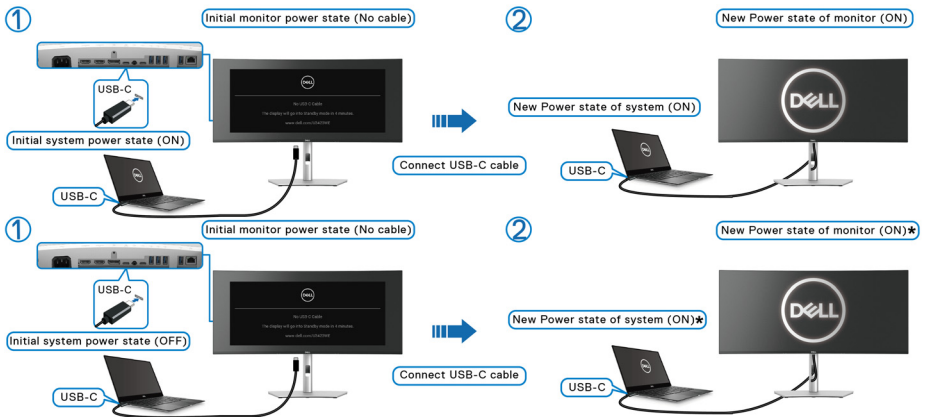

**\*Not all Dell PC systems support to wake up the platform via the monitor.**

**\*Upon USB-C cable connection, mouse movement or keyboard press might be required to wake the system/monitor up from sleep or hibernate.**

When you press the monitor power button or PC power button, the Monitor/PC state is as follows:

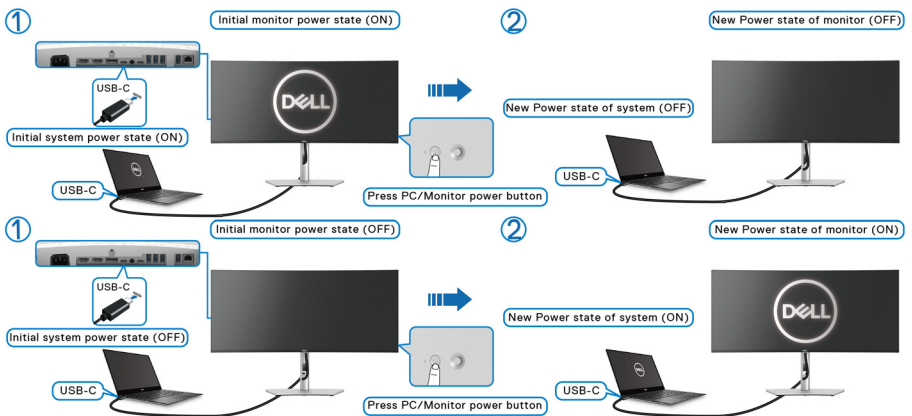

**NOTE:** You can enable or disable the power button sync function via OSD. See [Dell Power Button Sync](#).

- When the monitor and the PC power state are both ON, **press and hold the monitor power button for 4 seconds**, the screen prompt will ask if you would like to shut down the PC.

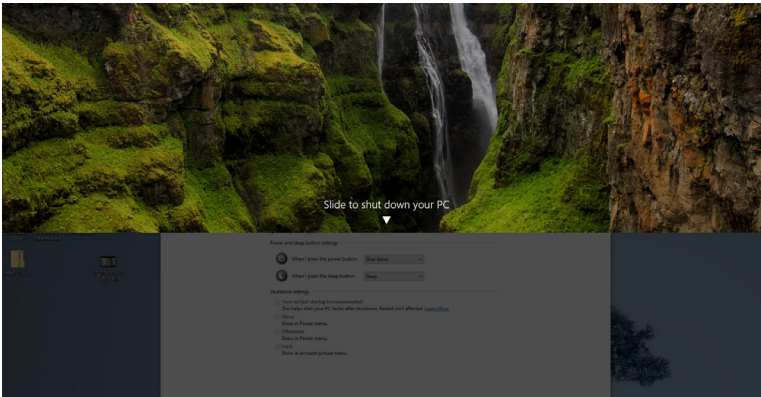
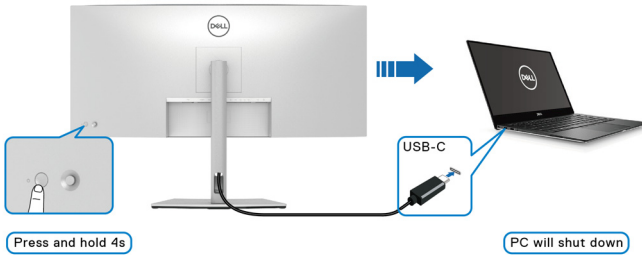

- When the monitor and the PC power state are both ON, **press and hold the monitor power button for 10 seconds**, the PC will shut down.

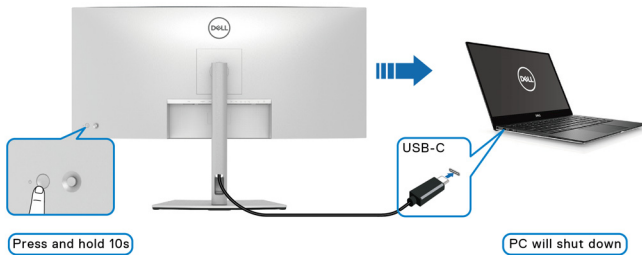

## Connecting the monitor for USB-C

If the Dell PC\* has two USB-C ports, the power state of each connected monitor will sync with the PC.

For example, when the PC and two monitors are in an initial ON power state, pressing the power button on Monitor 1 or Monitor 2 will turn OFF the PC, Monitor 1, and Monitor 2.

\*Ensure to check the Dell PC for DPBS supportability.

**NOTE:** DPBS only supports the USB Type-C upstream port with  icon.

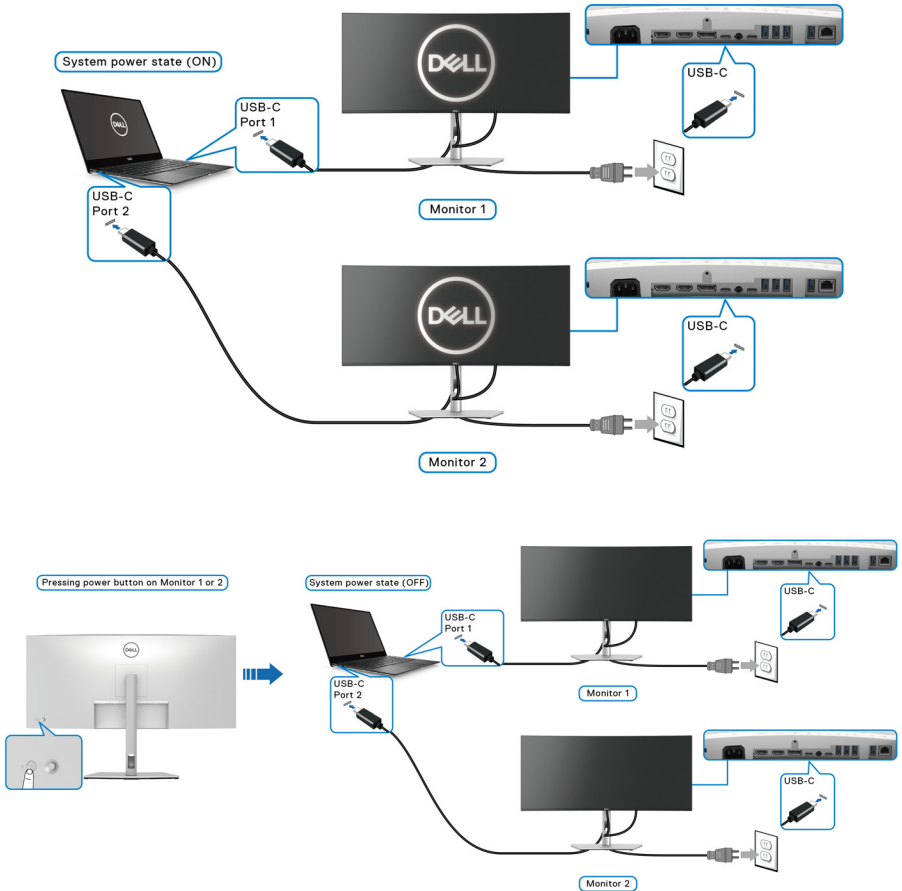

Ensure that **Dell Power Button Sync** is set to ON (see [Dell Power Button Sync](#)). When the PC and two monitors are in an initial OFF power state, pressing the power button on Monitor 1 or Monitor 2 will turn ON the PC, Monitor 1, and Monitor 2.

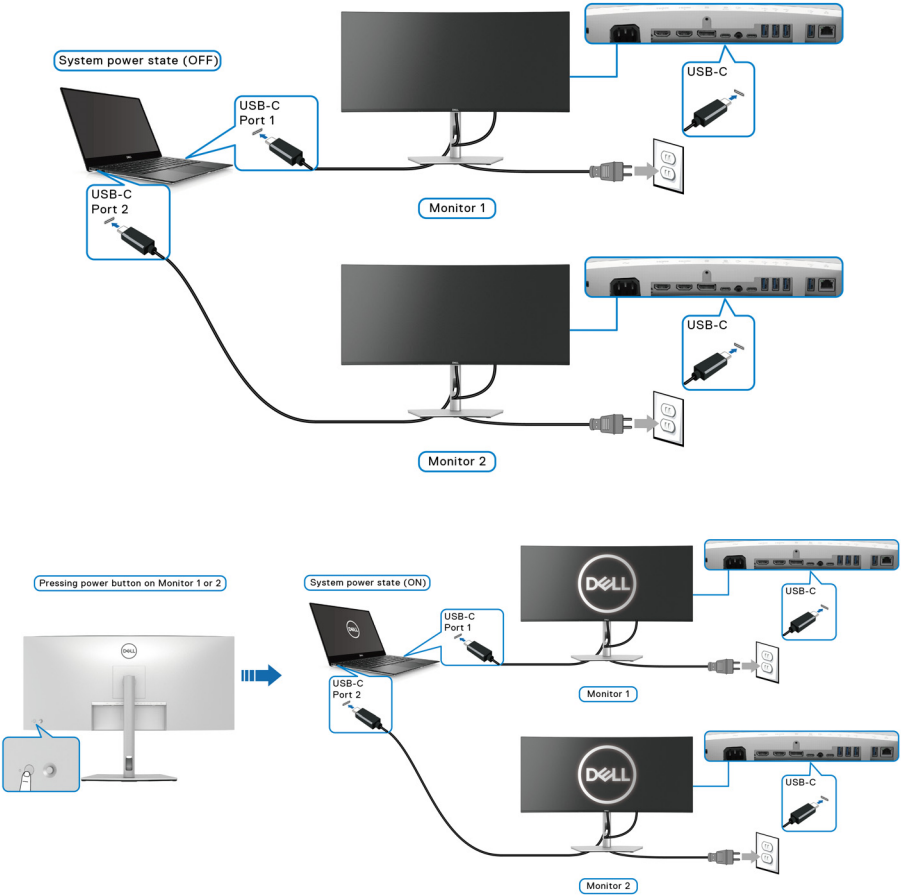



## Securing your monitor using Kensington lock (optional)

The security-lock slot is located at the bottom of the monitor (see [Security lock slot \(based on Kensington Security Slot™\)](#)). Secure your monitor to a table using the Kensington security lock.

For more information on using the Kensington lock (sold separately), see the documentation that is shipped with the lock.

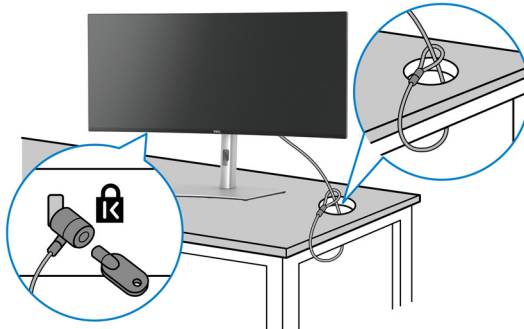

**NOTE:** The image is for the purpose of illustration only. The appearance of the lock may vary.

## Removing the monitor stand

**NOTE:** To prevent scratches on the LCD screen when removing the stand, ensure that the monitor is placed on a soft surface and handle it carefully.

**NOTE:** The following steps are specifically for removing the stand that is shipped with your monitor. If you are removing a stand that you purchased from any other source, follow the setup instructions that are included with the stand.

To remove the stand:

1. Place the monitor on a soft cloth or cushion.
2. Press and hold the stand release button at the back of the display.



3. Lift the stand assembly up and away from the monitor.

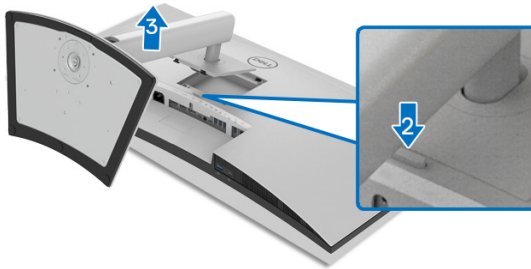

## VESA wall mounting (optional)



(Screw dimension: M4 x 10 mm).

Refer to the instructions that come with the VESA-compatible wall mounting kit.

1. Place the monitor panel on a soft cloth or cushion on a stable flat table.
2. Remove the stand. (See [Removing the monitor stand](#))
3. Use a Phillips crosshead screwdriver to remove the four screws securing the plastic cover.
4. Attach the mounting bracket from the wall mounting kit to the monitor.
5. Mount the monitor on the wall. For more information, see the documentation that shipped with the wall mounting kit.

**NOTE:** For use only with UL or CSA or GS-listed wall mount bracket with minimum weight or load bearing capacity of 30.88 kg.



# Operating the monitor

## Power on the monitor

Press the **Power Button** to turn On the monitor.

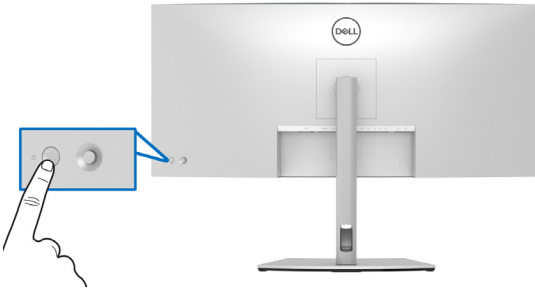

## Using the Joystick Control

Use the joystick control on the rear of the monitor to make OSD adjustments.

1. Press the joystick button to launch the OSD main menu.
2. Move the joystick up/down/left/right to toggle between options.
3. Press the joystick button again to confirm the settings and exit.

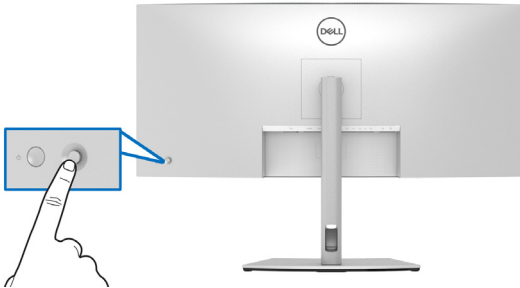

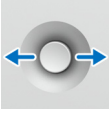
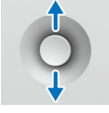
Joystick	Description
	<ul style="list-style-type: none"> <li>When the OSD menu is on, press the button to confirm the selection or save the settings.</li> <li>When the OSD menu is off, press the button to launch the OSD main menu. See <a href="#">Accessing the menu system</a>.</li> </ul>
	<ul style="list-style-type: none"> <li>For 2-way (right and left) directional navigation.</li> <li>Move right to enter the submenu.</li> <li>Move left to exit from the submenu.</li> </ul>
	<ul style="list-style-type: none"> <li>For 2-way (up and down) directional navigation.</li> <li>Toggles between the menu items.</li> <li>Increases (up) or decreases (down) the parameters of selected menu item.</li> </ul>



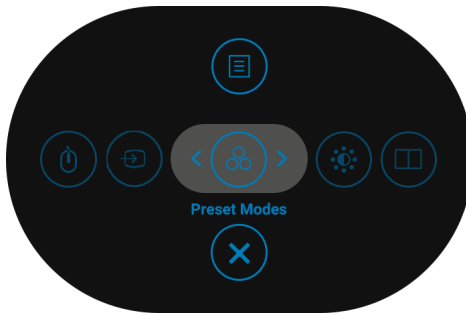



When you press the joystick button, the OSD Status Bar appears to let you know the current settings of some OSD functions.



The following table describes the Menu Launcher functions:

Menu Launcher Icon	Description
<p>1</p>  <p><b>Shortcut key/ Preset Modes</b></p>	<p>Select this icon to choose from a list of preset color modes.</p>



2	 <b>Shortcut key/ Brightness/Contrast</b>	Select this icon to adjust the brightness and contrast level.
3	 <b>Shortcut key/ PIP/PBP</b>	Select this icon to set <b>PIP/PBP</b> .
4	 <b>Shortcut key/ USB Switch</b>	Select this icon to switch between the USB upstream sources in <b>PIP/PBP</b> mode.
5	 <b>Shortcut key/ Input Source</b>	Select this icon to set the <b>Input Source</b> .
6	 <b>Menu</b>	Select this icon to launch the On-Screen Display (OSD). See <a href="#">Accessing the menu system</a> .
7	 <b>Exit</b>	Select this icon to exit the OSD main menu.

### Using the navigation keys

When the OSD main menu is active, move the joystick to configure the settings, following the navigation keys displayed below the OSD.

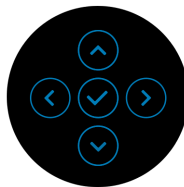

After you change the settings, press the joystick to save the changes before proceeding to another menu or exit the OSD menu.

 **NOTE: To exit the current menu item and return to the previous menu, move the joystick to the left until you exit.**



# Using the On-Screen Display (OSD) menu

## Accessing the menu system

 **NOTE:** After you change the settings, press the joystick to save the changes before proceeding to another menu or exit the OSD menu.

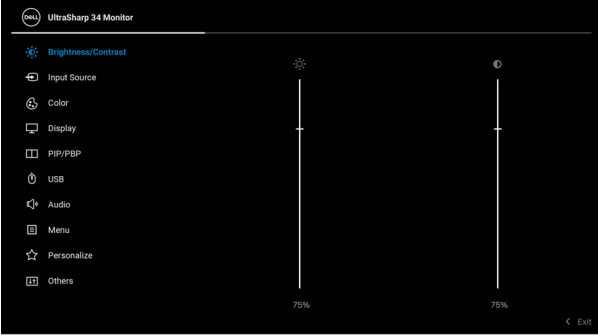
Icon	Menu and Submenus	Description
	<b>Brightness/Contrast</b>	Use this menu to activate <b>Brightness/Contrast</b> adjustment.
		
	<b>Brightness</b>	<b>Brightness</b> adjusts the luminance of the backlight. Toggle the joystick up to increase the brightness and toggle the joystick down to decrease the brightness (min. 0 / max. 100).
	<b>Contrast</b>	Adjusts the <b>Brightness</b> first, and then adjust the <b>Contrast</b> only if further adjustment is necessary. Toggle the joystick up to increase the contrast and toggle the joystick down to decrease the contrast (min. 0 / max. 100). The <b>Contrast</b> function adjusts the degree of difference between darkness and lightness on the monitor screen.





## Input Source

Use the **Input Source** menu to select between the different video signals that may be connected to your monitor.

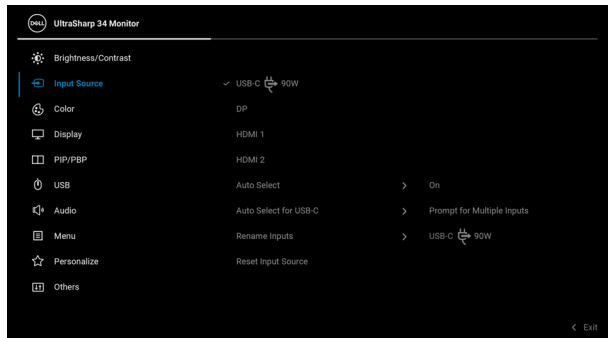

### USB-C 90W

Select the **USB-C 90W** input when you are using the USB Type-C connector. Press the joystick to confirm the selection.

### DP

Select the **DP** input when you are using the DisplayPort (DP) connector. Press the joystick to confirm the selection.

### HDMI 1

Select the **HDMI 1** input when you are using the HDMI 1 connector. Press the joystick to confirm the selection.

### HDMI 2

Select the **HDMI 2** input when you are using the HDMI 2 connector. Press the joystick to confirm the selection.

### Auto Select

Turning on the function allows you to scan for available input sources.



---

### Auto Select for USB-C

Allows you to set Auto Select for USB-C to:

- **Prompt for Multiple Inputs:** Always displays the “**Switch to USB-C Video Input**” message for you to choose whether to switch or not.
- **Yes:** Always switches to USB-C video input (without asking) when the USB Type-C cable is connected.
- **No:** Never automatically switches to USB-C video input when the USB Type-C cable is connected.

**NOTE: Auto Select for USB-C** is available only when **Auto Select** is on.

---

### Rename Inputs

Allows you to select the input name for the selected input source. The options are **PC, PC 1, PC 2, Laptop, Laptop 1, and Laptop 2.**

**NOTE:** For Input with USB-C Charging, the wattage value shall remain after renaming, e.g., **PC 1** ⇨ **90W.**

**NOTE:** Input names in warning messages, KVM, and Display Info will not be changed.

---

### Reset Input Source

Resets your monitor input settings to the factory settings.



### Color

Use **Color** to adjust the color setting mode.

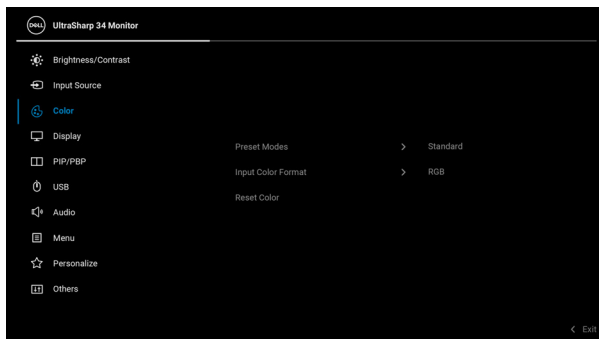



---

**Preset Modes** Allows you to choose from a list of preset color modes.

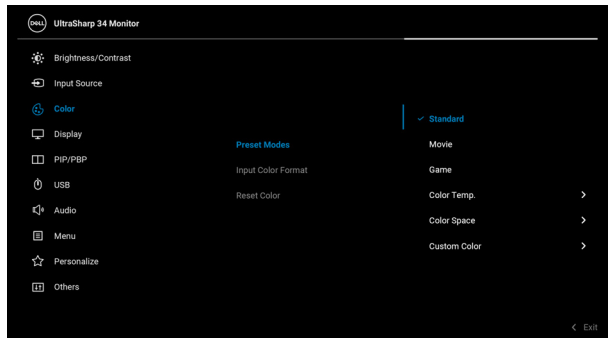

- **Standard:** Loads the monitor's default color settings. This is the default preset mode.
- **Movie:** Loads color settings ideal for movies.
- **Game:** Loads color settings ideal for most gaming applications.
- **Color Temp.:** Allows you to select the color temperature: 5000K, 5700K, 6500K, 7500K, 9300K, and 10000K. Press the joystick to confirm the selection.
- **Color Space:** Allows you to set the color space to:
  - **sRGB:** matches 99% sRGB.
  - **Rec. 709:** matches 100% Rec. 709.
  - **DCI-P3:** reproduces 98% of DCI-P3 digital cinema color standard.
  - **Display P3:** reproduces 98% of Display P3.

**NOTE:** If you select the color space ICC profile from your PC, the monitor OSD will not change automatically to the respective color space.

---



---

## Preset Modes

**NOTE:** When you select **DCI-P3** as the color space, the luminance of the backlight defaults to 48 cd/m<sup>2</sup> (typical). You can manually adjust the luminance of the backlight by using the **Brightness** function under **Brightness/Contrast** in the OSD menu.

- **Custom Color:** Allows you to manually adjust the color settings.

Toggle the joystick up or down to adjust the color values and create your own preset color mode.

---

## Input Color Format

Allows you to set the video input mode to:

- **RGB:** Select this option if your monitor is connected to a computer (or media player) using the USB Type-C, DisplayPort, or HDMI cable.
- **YCbCr:** Select this option if your media player supports only YCbCr output.

Press the joystick to confirm the selection.

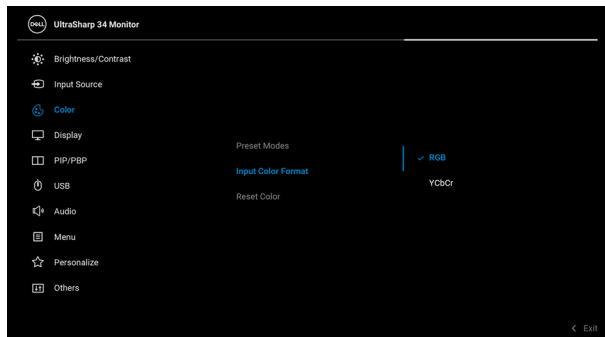

---

## Hue

This feature can shift the color of the video image to green or purple. This is used to adjust the desired flesh tone color. Toggle the joystick up or down to adjust the hue from '0' to '100'.

**NOTE:** Hue adjustment is available only when you select **Movie** or **Game** preset mode.

---



---

## Saturation

This feature can adjust the color saturation of the video image. Toggle the joystick up or down to adjust the saturation from '0' to '100'.

**NOTE: Saturation** adjustment is available only when you select **Movie** or **Game** preset mode.

---

## Reset Color

Resets your monitor's color settings to the factory settings.

---



## Display

Use the **Display** menu to adjust images.

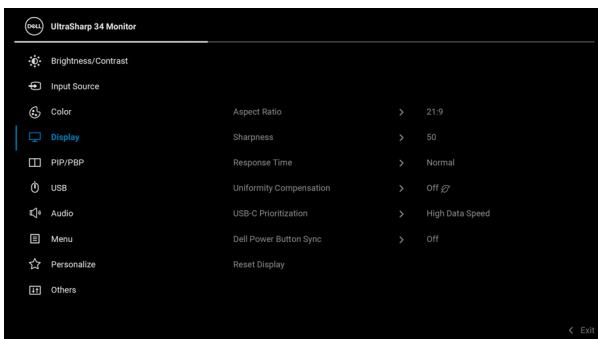

---

## Aspect Ratio

Adjusts the image ratio to **21:9**, **Auto Resize**, **4:3**, or **1:1**.

---

## Sharpness

This feature can make the image look sharper or softer.

Toggle the joystick up or down to adjust the sharpness from '0' to '100'.

---

## Response Time

Allows you to set the **Response Time** to **Normal** or **Fast**.

---



## Uniformity Compensation

Select screen uniformity compensation settings. **On** is factory calibrated setting by default. **Uniformity Compensation** adjusts different areas of the screen with respect to the center to achieve uniform brightness and color over the entire screen. For optimal screen performance, **Brightness** and **Contrast** for some preset modes (**Standard, Color Temp.**) will be disabled when **Uniformity Compensation** is turned **On**.

**NOTE:** User is advised to use factory default brightness setting when **Uniformity Compensation** is turned on. For other brightness level setting, the uniformity performance may deviate from the data shown on the Factory Calibration Report.

## USB-C Prioritization

Allows you to specify the priority to transfer the data with high resolution (**High Resolution**) or high speed (**High Data Speed**) when using the USB Type-C port/DisplayPort. If the current platform is DP 1.4 (HBR3), use **High Data Speed** to access full video performance with high data speed. If the current platform is DP 1.2 (HBR2) or below, select **High Resolution** for accessing full video performance with data and network speed drop.

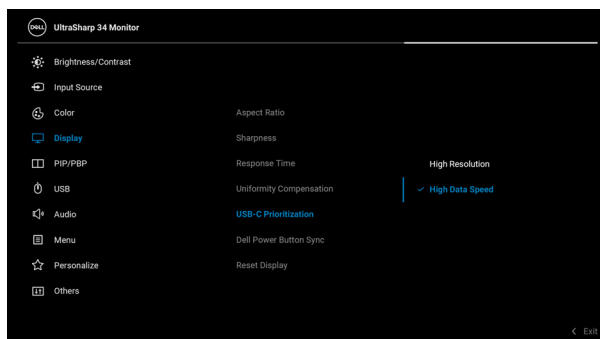

---

**Dell Power Button Sync**

Turns the Dell Power Button Sync feature On or Off. When Off is selected, power button sync function will be disabled.

**NOTE:** When Off is selected, the Wake-on-Connect function will remain active.

---

**Reset Display**

Resets all display settings to the factory preset values.

---

**PIP/PBP**

This function brings up a window displaying image from another input source.

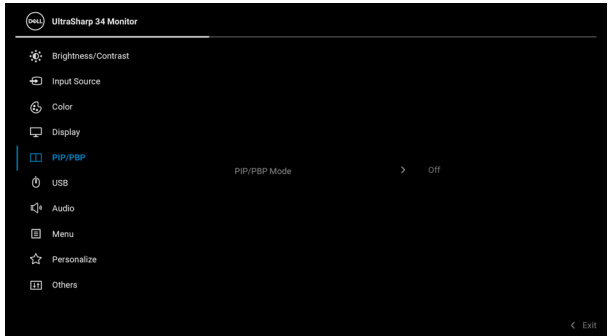











Main Window	Sub-Window			
	USB-C	DP	HDMI 1	HDMI 2
USB-C	X	✓	✓	✓
DP	✓	X	✓	✓
HDMI 1	✓	✓	X	✓
HDMI 2	✓	✓	✓	X

**NOTE:** The images under PBP will be displayed at the center of the screen, not full screen.

---



---

**PIP/PBP Mode** Adjusts the **PIP/PBP** (Picture in Picture/Picture by Picture) mode to  (50% - 50%),  (74% - 26%),  (26% - 74%),  (PIP1 small),  (PIP2 small),  (PIP3 small),  (PIP4 small),  (PIP1 large),  (PIP2 large),  (PIP3 large), or  (PIP4 large).  
You can disable this feature by selecting **Off**.

---

**PIP/PBP (Sub)** Select between the different video signals that may be connected to your monitor for the PIP/PBP sub-window.

---

**USB Switch** Select to switch between the USB upstream sources in PIP/PBP mode.

---

**Video Swap** Select to swap videos between main window and sub-window in PIP/PBP mode.

---

**Audio** Allows you to set the audio source between the **Main** window and the **Sub** window.

---

**Contrast (Sub)** Adjust the contrast level of the picture in PIP/PBP Mode.  
Toggle the joystick up to increase the contrast and toggle the joystick down to decrease the contrast.

---





## USB

Allows you to assign the USB upstream port for the input signals (DP, HDMI 1, and HDMI 2), thus the monitor's USB downstream port (eg. keyboard and mouse) can be used by the current input signals when you connect a computer to either one of the upstream ports.

When you use only one upstream port, the connected upstream port is active.

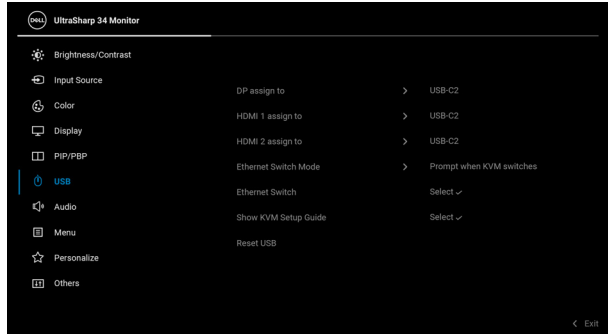

**NOTE:** To prevent data damage or loss, before changing USB upstream ports, make sure that NO USB storage devices are in use by the computer connected to the monitor's USB downstream port.

## Ethernet Switch Mode

Allows you to set the Ethernet switch mode:

- **Tie to KVM:** When KVM USB switches, Ethernet switches together.
- **Prompt when KVM switches:** When KVM USB switches, a message prompts user to decide whether to switch Ethernet together.
- **Switch Manually:** When KVM USB switches, Ethernet does not switch.

## Ethernet Switch

Manually switch Ethernet.



---

**Show KVM Setup Guide**

Select this option and follow steps if you want to connect multiple computers to the monitor and use one setup of keyboard and mouse.

---

**Reset USB**

Resets all settings under the **USB** menu to the factory preset values.

---

**Audio**

---

**Volume**

Allows you to set the volume level of speakers.

Toggle the joystick up or down to adjust the volume level from '0' to '100'.

---

**Speaker**

Allows you to enable or disable the speaker function.

---

**Reset Audio**

Select this option to restore default audio settings.

---







## Menu

Select this option to adjust the settings of the OSD, such as, the languages of the OSD, the amount of time the menu remains on screen, and so on.

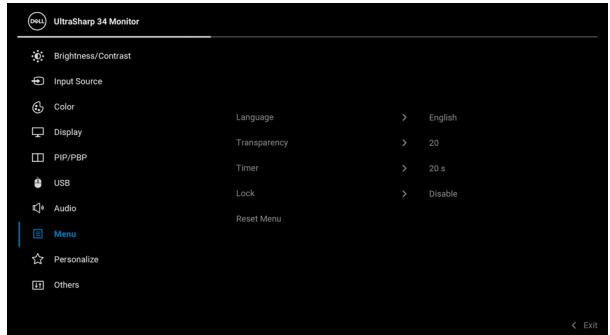

### Language

Sets the OSD display to one of the eight languages (English, Spanish, French, German, Brazilian Portuguese, Russian, Simplified Chinese, or Japanese).

### Transparency

Select this option to change the menu transparency by toggling the joystick up or down (min. 0 / max. 100).

### Timer

Sets the length of time the OSD will remain active after the last time you pressed a button. Toggle the joystick up or down to adjust the slider in 1 second increments, from 5 to 60 seconds.



---

## Lock

With the control buttons on the monitor locked, you can prevent people from accessing the controls. It also prevents accidental activation in multiple monitors side-by-side setup.

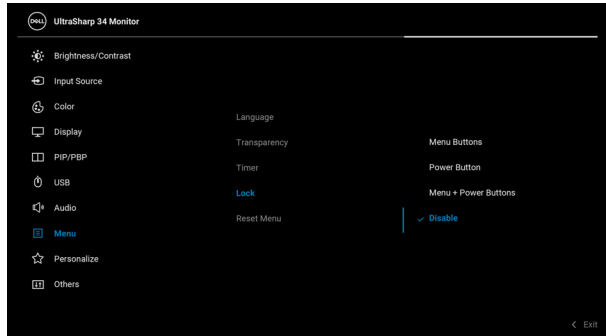

- **Menu Buttons:** All joystick functions are locked and not accessible by the user.
- **Power Button:** Only the Power button is locked and not accessible by the user.
- **Menu + Power Buttons:** Both the joystick & the Power button are locked and not accessible by the user.

The default setting is **Disable**.

Alternative Lock Method [for Menu/function buttons]: You can also press and hold the joystick to the up or down or left or right for 4 seconds to set the lock options.

**NOTE:** To unlock the button(s), press and hold the joystick to the up or down or left or right for 4 seconds.

---

## Reset Menu

Resets all settings under the **Menu** menu to the factory preset values.

---





## Personalize

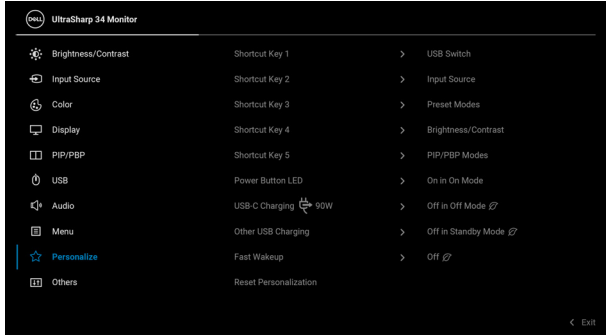

### Shortcut Key 1

### Shortcut Key 2

### Shortcut Key 3

### Shortcut Key 4

### Shortcut Key 5

Allows you to choose a feature from **Preset Modes**, **Brightness/Contrast**, **Input Source**, **Aspect Ratio**, **PIP/PBP Mode**, **USB Switch**, **Ethernet Switch**, **Video Swap**, **Volume**, or **Display Info** and set it as a shortcut key.

### Power Button LED

Allows you to set the power LED indicator on or off to save energy.

### USB-C Charging 90W

Allows you to enable or disable the **Always On USB Type-C Charging** function during monitor Off mode.

### Other USB Charging

Allows you to enable or disable USB Type-A and USB Type-C Downstream Ports charging function during monitor standby mode.

### Fast Wakeup

Allows you to enable or disable monitor fast wakeup.

### Reset Personalization

Resets all settings under the **Personalize** menu to the factory preset values.





## Others

Select this option to adjust the OSD settings, such as **DDC/CI**, **LCD Conditioning**, and so on.

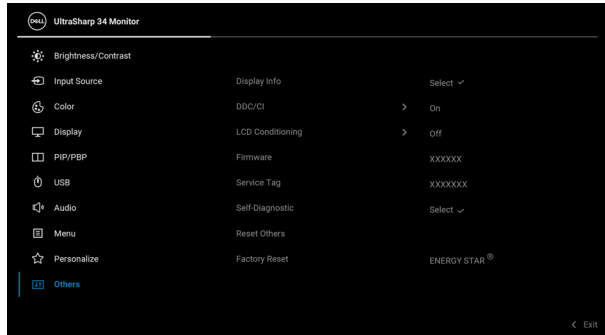

## Display Info

Displays the monitor's current settings.

### DDC/CI

**DDC/CI** (Display Data Channel/Command Interface) allows your monitor parameters (brightness, color balance, and etc.) to be adjustable via the software on your computer. You can disable this feature by selecting **Off**. Enable this feature for best user experience and optimum performance of your monitor.

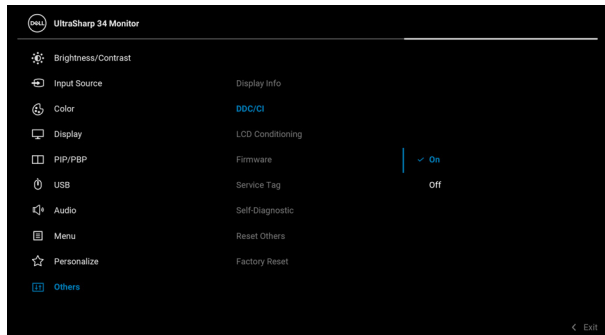

---

## LCD Conditioning

Helps reduce minor cases of image retention. Depending on the degree of image retention, the program may take some time to run. You can enable this feature by selecting **On**.

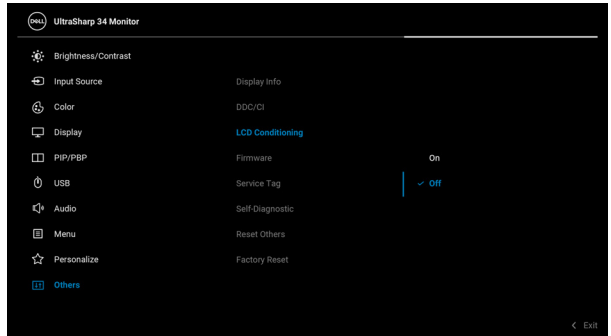

---

## Firmware

Displays the firmware version of your monitor.

---

## Service Tag

Displays the service tag of your monitor. This string is required when you look for phone support, check your warranty status, update drivers on Dell's website, etc.

---

## Self-Diagnostic

Press the joystick to initiate the self-diagnostic process.

1. When initiated, a gray screen appears.
2. Carefully inspect the screen for abnormalities.
3. Press the joystick. The color of the screen changes to red.
4. Inspect the display for any abnormalities.
5. Repeat steps 3 and 4 to inspect the display in green, blue, black, white and text screens.

The test is complete when the text screen appears. To exit, press the joystick again.

---

## Reset Others

Resets all settings under the **Others** menu to the factory preset values.

---



## Factory Reset

Restore all preset values to the factory default settings. These are also the settings for ENERGY STAR® tests.

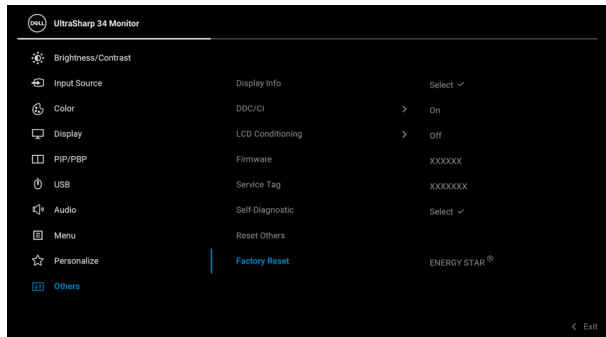

## OSD warning message

When the monitor does not support a particular resolution mode, you will see the following message:

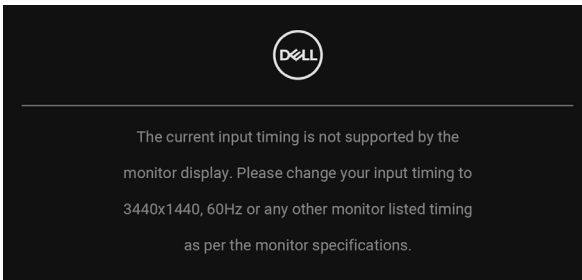

This means that the monitor cannot synchronize with the signal that it is receiving from the computer. See [Monitor specifications](#) for the Horizontal and Vertical frequency ranges addressable by this monitor. Recommended mode is 3440 x 1440.



You will see the following message before the **DDC/CI** function is disabled:

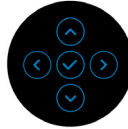

When you adjust the **Brightness** level for the first time, the following message appears:

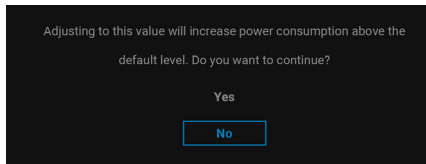

**NOTE:** If you select **Yes**, the message will not appear the next time you change the **Brightness** setting.

When you change the default setting of power saving features for the first time, such as **Uniformity Compensation**, **USB-C Charging @ 90W**, **Other USB Charging**, or **Fast Wakeup**, the following message appears:

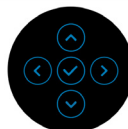
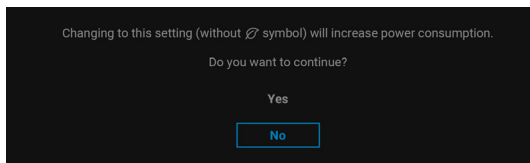

**NOTE:** If you select **Yes** for any one of the features mentioned above, the message will not appear next time when you intend to change the settings of these features. When you perform a factory reset, the message will appear again.

You will see the following message before the **Lock** function is activated:

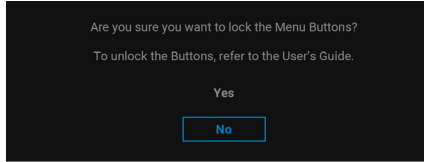

**NOTE:** The message may be slightly different according to the selected settings.

When the monitor goes into Standby mode, the following message appears:

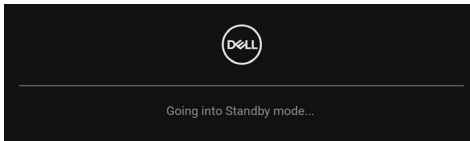

Activate the computer and wake up the monitor to gain access to the **OSD**.

The OSD functions only in the normal operation mode. If you press any button other than the **Power Button** during the Standby mode, the following message will appear depending on the selected input:

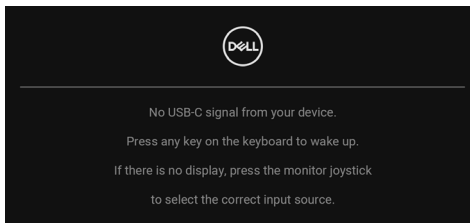



Activate the computer and the monitor to gain access to the [OSD](#).

 **NOTE: The message may be slightly different according to the connected input signal.**

If either USB Type-C, DisplayPort, or HDMI input is selected and the corresponding cable is not connected, a floating dialog box as shown below appears.

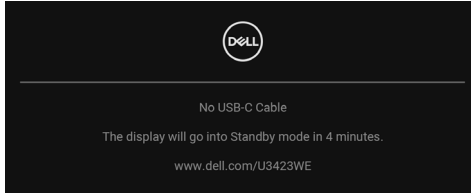

 **NOTE: The message may be slightly different according to the connected input signal.**

When the monitor is under DP/HDMI input and a USB Type-C cable is connected to a notebook that supports DP Alternate Mode, if [Auto Select for USB-C](#) is enabled, the following message appears:

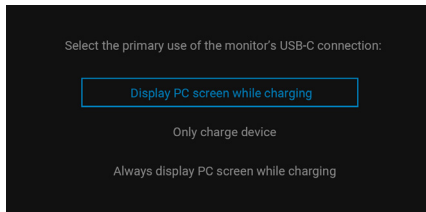

When **Factory Reset** is selected, the following message appears:

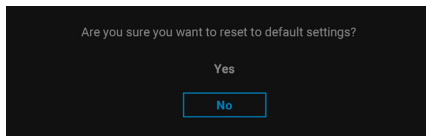

When **Yes** is selected, the following messages appear.

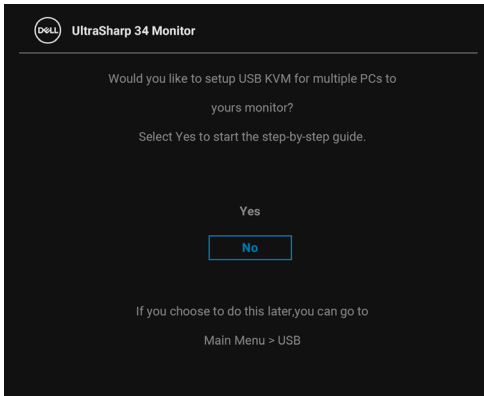
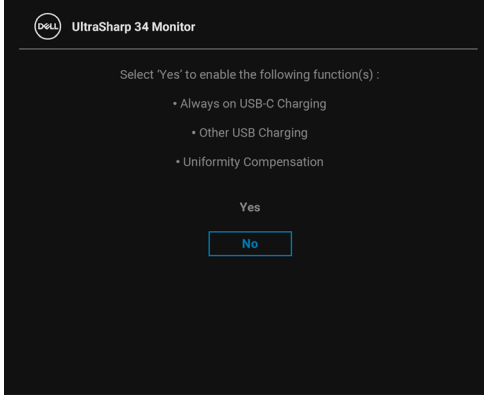

When you switch the USB Switch from PC 1 to PC 2, and **Ethernet Switch Mode** is set to **Prompt then KVM switches**, the following message appears:

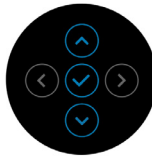
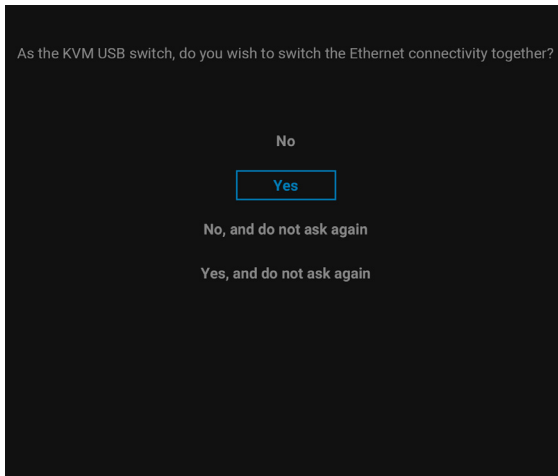

**NOTE:** When ‘No, and do not ask again’ is selected, Ethernet Switch Mode will change to ‘Switch Manually’. When ‘Yes, and do not ask again’ is selected, Ethernet Switch Mode will change to ‘Tie to KVM’.

See [Troubleshooting](#) for more information.



## Setting the maximum resolution



**NOTE: The steps may vary slightly depending on the version of Windows you have.**

To set the maximum resolution for the monitor:

In Windows 7, Windows 8, and Windows 8.1:

1. For Windows 8 and Windows 8.1 only, select the Desktop tile to switch to classic desktop.
2. Right-click on the desktop and click **Screen Resolution**.
3. If you have more than one monitor connected, ensure that you select **U3423WE**.
4. Click the **Screen Resolution** dropdown list and select **3440 x 1440**.
5. Click **OK**.

In Windows 10 and Windows 11:

1. Right-click on the desktop and click **Display settings**.
2. If you have more than one monitor connected, ensure to select **U3423WE**.
3. Click the **Display Resolution** dropdown list and select **3440 x 1440**.
4. Click **Keep changes**.

If you do not see 3440 x 1440 as an option, you must update your graphics driver to the latest version. Depending on your computer, complete one of the following procedures:

If you have a Dell desktop or laptop:

- Go to <https://www.dell.com/support>, enter your service tag, and download the latest driver for your graphics card.

If you are using a non-Dell computer (laptop or desktop):

- Go to the support site for your computer and download the latest graphic drivers.
- Go to your graphics card website and download the latest graphic drivers.



## Setting the KVM switch

The built-in KVM switch allows you to control up to 2 computers from a single set of keyboard and mouse connected to the monitor.

- a. When connecting **HDMI + USB-C (data only)** to computer 1 and **DP + USB-C (video and data)** to computer 2:

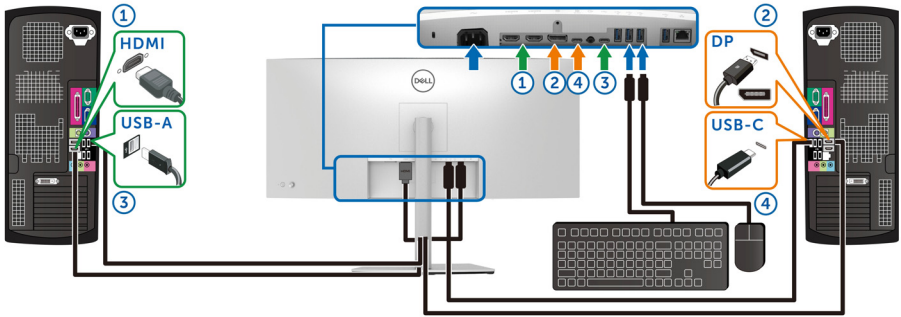

**NOTE:** The USB Type-C connections currently only support data transfer.

Ensure that **USB** for **HDMI** is assigned to **USB-C2** and **DP** is assigned to **USB-C1**.



b. When connecting **HDMI + USB-C (data only)** to computer 1 and **USB-C (video and data)** to computer 2:

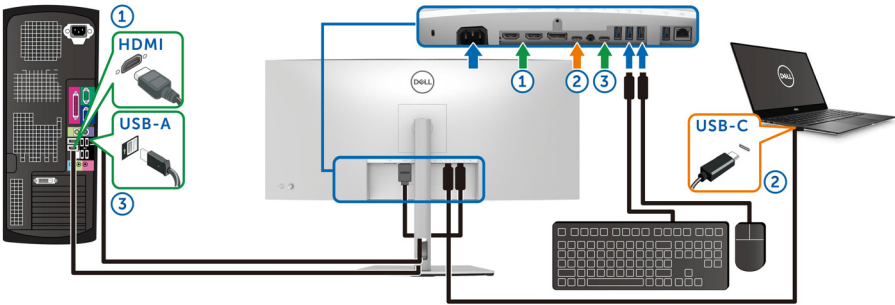

**NOTE: The USB-C (video and data) connection currently supports video and data transfer.**

Make sure **USB** for **HDMI** is assigned to **USB-C2**.

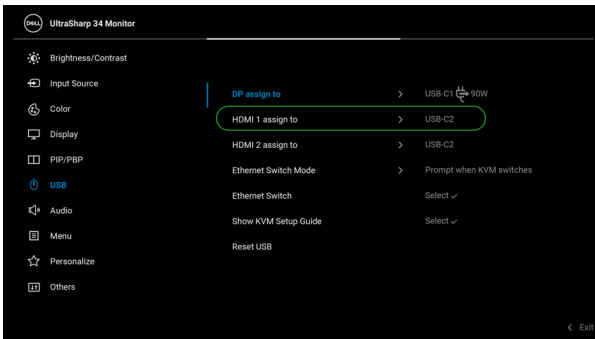

**NOTE: As the USB Type-C (video and data) port supports the DisplayPort Alternate Mode, there is no need to set USB for USB-C.**

**NOTE: When connecting to different video input sources not shown above, follow the same method to make correct settings for USB to pair the ports.**



# Setting the Auto KVM

You can follow below instruction to set up Auto KVM for your monitor:

1. Ensure that **PIP/PBP Mode** is **Off**.



2. Ensure that **Auto Select** is **On** and **Auto Select for USB-C** is **Yes**.



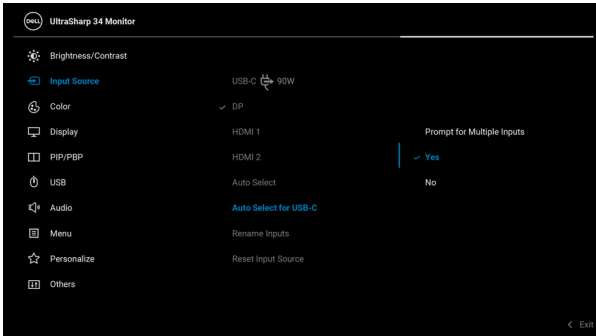

3. Ensure that the USB ports and the video inputs are paired accordingly.

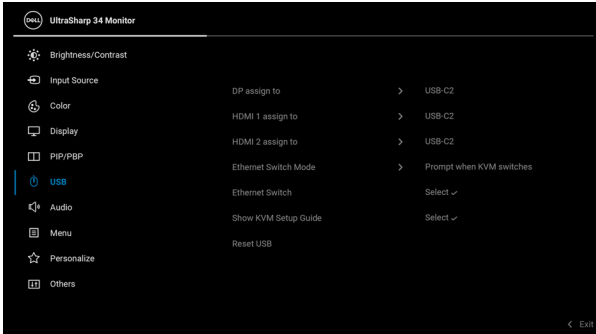

**NOTE:** For USB Type-C (video and data) connection, there is no further setting required.





## Using the tilt, swivel, vertical extension, and slant adjust

**NOTE:** The following instructions are applicable only for attaching the stand that was shipped with your monitor. If you are attaching a stand that you purchased from any other source, follow the set up instructions that were included with the stand.

### Tilt, swivel

With the stand attached to the monitor, you can tilt and swivel the monitor for the most comfortable viewing angle.

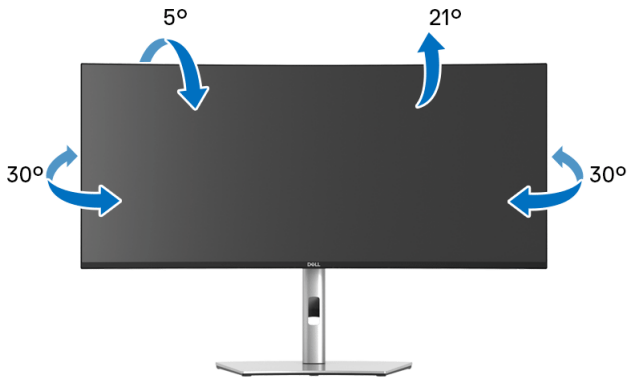

**NOTE:** The stand is not installed at the factory when shipped.

### Vertical extension

**NOTE:** The stand extends vertically up to 150 mm. The figure below illustrates how to extend the stand vertically.



## Slant adjust

With the stand attached to the monitor, you can adjust the monitor to your desired angle with the slant adjust feature.



# Troubleshooting

**⚠ WARNING:** Before you begin any of the procedures in this section, follow the [Safety instructions](#).

## Self-test

Your monitor provides a self-test feature that allows you to check whether your monitor is functioning properly. If your monitor and computer are properly connected but the monitor screen remains dark, run the monitor self-test by performing the following steps:

1. Turn off both your computer and the monitor.
2. Unplug the video cable from the back of the computer.
3. Turn on the monitor.

The floating dialog box should appear on-screen (against a black background), if the monitor cannot sense a video signal and is working correctly. While in self-test mode, the power LED remains white. Also, depending upon the selected input, one of the dialogs shown below will continuously scroll through the screen.

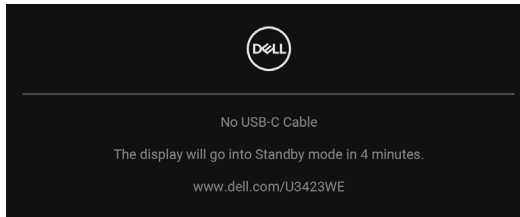

**📌 NOTE:** The message may be slightly different according to the connected input signal.

4. This box also appears during normal system operation, if the video cable becomes disconnected or damaged.
5. Turn Off your monitor and reconnect the video cable; then turn On both your computer and the monitor.

If your monitor screen remains blank after you use the previous procedure, check your video controller and computer, because your monitor is functioning properly.



## Using the joystick to lock/unlock buttons

### Locking the power and joystick buttons

You can lock the joystick and power buttons to prevent access to the OSD menu and/or power off the monitor.

To lock the buttons:

1. Toggle and hold the joystick to the **up** or **down** or **left** or **right** for about 4 seconds until a pop menu appears.

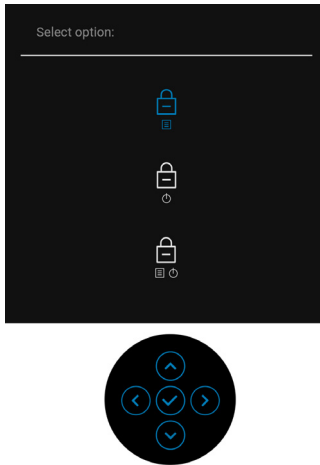

2. Select one of the following options:

- **Menu Buttons:** All joystick functions are locked and not accessible by the user.
- **Power Buttons:** Only the **Power Button** is locked and not accessible by the user.
- **Menu + Power Buttons:** Both the joystick & the **Power Button** are locked and not accessible by the user.



To unlock the button(s), press and hold the joystick to the **up** or **down** or **left** or **right** for 4 seconds. Select the **Unlock** icon to unlock the button(s).

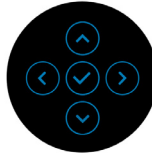
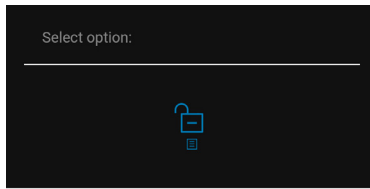

## Always On USB Type-C Charging

The monitor allows you to charge your notebook or mobile devices through the USB Type-C cable even when the monitor is powered off. See [USB-C Charging 90W](#) for more information.

You may verify your current firmware revision in [Firmware](#). If this is not available, go to the Dell download support site for the latest application installer (**Monitor Firmware Update Utility.exe**) and refer to the Firmware Update Instruction User's Guide: [www.dell.com/U3423WE](http://www.dell.com/U3423WE).



## Common problems

The following table contains general information about common monitor problems you might encounter and the possible solutions:

Common symptoms	What you experience	Possible solutions
No Video/Power LED off	No picture	<ul style="list-style-type: none"><li>• Ensure that the video cable connecting the monitor and the computer is properly connected and secure.</li><li>• Verify that the power outlet is functioning properly using any other electrical equipment.</li><li>• Ensure that the <b>Power Button</b> is pressed fully.</li><li>• Ensure that the correct input source is selected in the <b>Input Source</b> menu.</li></ul>
No Video/Power LED on	No picture or no brightness	<ul style="list-style-type: none"><li>• Increase brightness &amp; contrast controls via OSD.</li><li>• Perform monitor self-test feature check.</li><li>• Check for bent or broken pins in the video cable connector.</li><li>• Run the built-in diagnostics.</li><li>• Ensure that the correct input source is selected in the <b>Input Source</b> menu.</li></ul>
Poor Focus	Picture is fuzzy, blurry, or ghosting	<ul style="list-style-type: none"><li>• Eliminate video extension cables.</li><li>• Reset the monitor to factory settings.</li><li>• Change the video resolution to the correct aspect ratio.</li></ul>
Shaky/Jittery Video	Wavy picture or fine movement	<ul style="list-style-type: none"><li>• Reset the monitor to factory settings.</li><li>• Check environmental factors.</li><li>• Relocate the monitor and test in another room.</li></ul>



Missing Pixels	LCD screen has spots	<ul style="list-style-type: none"> <li>• Cycle power On-Off.</li> <li>• Pixel that is permanently Off is a natural defect that can occur in LCD technology.</li> <li>• For more information on Dell Monitor Quality and Pixel Policy, see Dell Support site at: <a href="http://www.dell.com/pixelguidelines">http://www.dell.com/pixelguidelines</a>.</li> </ul>
Stuck-on Pixels	LCD screen has bright spots	<ul style="list-style-type: none"> <li>• Cycle power On-Off.</li> <li>• Pixel that is permanently off is a natural defect that can occur in LCD technology.</li> <li>• For more information on Dell Monitor Quality and Pixel Policy, see Dell Support site at: <a href="http://www.dell.com/pixelguidelines">http://www.dell.com/pixelguidelines</a>.</li> </ul>
Brightness Problems	Picture too dim or too bright	<ul style="list-style-type: none"> <li>• Reset the monitor to factory settings.</li> <li>• Adjust brightness &amp; contrast controls via OSD.</li> </ul>
Geometric Distortion	Screen not centered correctly	<ul style="list-style-type: none"> <li>• Reset the monitor to factory settings.</li> </ul>
Horizontal/Vertical Lines	Screen has one or more lines	<ul style="list-style-type: none"> <li>• Reset the monitor to factory settings.</li> <li>• Perform monitor self-test feature check and determine if these lines are also in self-test mode.</li> <li>• Check for bent or broken pins in the video cable connector.</li> <li>• Run the built-in diagnostics.</li> </ul>



Synchronization Problems	Screen is scrambled or appears torn	<ul style="list-style-type: none"> <li>Reset the monitor to factory settings.</li> <li>Perform monitor self-test feature check to determine if the scrambled screen appears in self-test mode.</li> <li>Check for bent or broken pins in the video cable connector.</li> <li>Restart the computer in the safe mode.</li> </ul>
Safety Related Issues	Visible signs of smoke or sparks	<ul style="list-style-type: none"> <li>Do not perform any troubleshooting steps.</li> <li>Contact Dell immediately.</li> </ul>
Intermittent Problems	Monitor malfunctions on & off	<ul style="list-style-type: none"> <li>Ensure that the video cable connecting the monitor to the computer is connected properly and is secure.</li> <li>Reset the monitor to factory settings.</li> <li>Perform monitor self-test feature check to determine if the intermittent problem occurs in self-test mode.</li> </ul>
Missing Color	Picture missing color	<ul style="list-style-type: none"> <li>Perform monitor self-test feature check.</li> <li>Ensure that the video cable connecting the monitor to the computer is connected properly and is secure.</li> <li>Check for bent or broken pins in the video cable connector.</li> </ul>
Wrong Color	Picture color not good	<ul style="list-style-type: none"> <li>Try different <b>Preset Modes</b> in <b>Color</b> settings OSD. Adjust the <b>R/G/B</b> value in <b>Custom Color</b> in <b>Color</b> settings OSD.</li> <li>Change the <b>Input Color Format</b> to <b>RGB</b> or <b>YCbCr/YPbPr</b> in the <b>Color</b> settings OSD.</li> <li>Run the built-in diagnostics.</li> </ul>





Image retention from a static image left on the monitor for a long period of time	Faint shadow from the static image displayed appears on the screen	<ul style="list-style-type: none"> <li>Set the screen to turn off after a few minutes of screen idle time. These can be adjusted in Windows Power Options or Mac Energy Saver setting.</li> <li>Alternatively, use a dynamically changing screensaver.</li> </ul>
---	--	---

## Product specific problems

Common symptoms	What you experience	Possible solutions
Screen image is too small	Image is centered on screen, but does not fill entire viewing area	<ul style="list-style-type: none"> <li>Check the <b>Aspect Ratio</b> setting in the <b>Display</b> menu OSD.</li> <li>Reset the monitor to factory settings.</li> </ul>
Cannot adjust the monitor with the buttons on the front panel	OSD does not appear on the screen	<ul style="list-style-type: none"> <li>Turn Off the monitor, unplug the power cord, plug it back, and then turn On the monitor.</li> <li>Check whether the OSD menu is locked. If yes, move and hold the joystick up/down/left/right for 4 seconds to unlock (for more information, see <a href="#">Lock</a>).</li> </ul>
No Input Signal when user controls are pressed	No picture, the LED light is white	<ul style="list-style-type: none"> <li>Check the signal source. Ensure the computer is not in the standby mode by moving the mouse or pressing any key on the keyboard.</li> <li>Check whether the signal cable is plugged in properly. Re-plug the signal cable if necessary.</li> <li>Reset the computer or video player.</li> </ul>
The picture does not fill the entire screen	The picture cannot fill the height or width of the screen	<ul style="list-style-type: none"> <li>Due to different video formats (aspect ratio) of DVDs, the monitor may display in full screen.</li> <li>Run the built-in diagnostics.</li> </ul>



No video at HDMI/DisplayPort/USB Type-C port	When connected to some dongle/docking device at the port, there is no video when unplugging/plugging the Thunderbolt cable from the notebook	<ul style="list-style-type: none"> <li>Unplug the HDMI/DisplayPort/USB Type-C cable from dongle/docking device, then plug the docking HDMI/DisplayPort/USB Type-C cable to the notebook.</li> </ul>
No network connection	Network dropped or intermittent	<ul style="list-style-type: none"> <li>Check to ensure <b>USB-C Prioritization</b> is set to <b>High Data Speed</b>.</li> <li>Do not turn Off the display during network connection.</li> </ul>

### Universal Serial Bus (USB) specific problems

Common symptoms	What you experience	Possible solutions
USB interface is not working	USB peripherals are not working	<ul style="list-style-type: none"> <li>Check that your monitor is turned On.</li> <li>Reconnect the upstream cable to your computer.</li> <li>Reconnect the USB peripherals (downstream connector).</li> <li>Switch Off and then turn On the monitor again.</li> <li>Reboot the computer.</li> <li>Some USB devices like external portable HDD require higher electric current; connect the device directly to the computer system.</li> </ul>



USB Type-C port does not supply power	USB peripherals can not be charged	<ul style="list-style-type: none"> <li>• Check that the connected device is compliant with the USB-C specification. The USB Type-C port supports USB 3.2 Gen2 and an output of 90 W.</li> <li>• Check that you use the USB Type-C cable shipped with your monitor.</li> </ul>
Super speed USB 10 Gbps (USB 3.2 Gen2) interface is slow	Super speed USB 10 Gbps (USB 3.2 Gen2) peripherals working slowly or not working at all	<ul style="list-style-type: none"> <li>• Check that your computer is super speed USB 10 Gbps (USB 3.2 Gen2)-capable.</li> <li>• Some computers have USB 3.2, USB 2.0 and USB 1.1 ports. Ensure that the correct USB port is used.</li> <li>• Reconnect the upstream cable to your computer.</li> <li>• Reconnect the USB peripherals (downstream connector).</li> <li>• Reboot the computer.</li> </ul>
Wireless USB peripherals stop working when a USB 3.2 device is plugged in	Wireless USB peripherals responding slowly or only working as the distance between itself and its receiver decreases	<ul style="list-style-type: none"> <li>• Increase the distance between the USB 3.2 peripherals and the wireless USB receiver.</li> <li>• Position your wireless USB receiver as close as possible to the wireless USB peripherals.</li> <li>• Use a USB-extender cable to position the wireless USB receiver as far away as possible from the USB 3.2 port.</li> </ul>



## Speakers Specific Problems

<b>Specific Symptoms</b>	<b>What You Experience</b>	<b>Possible Solutions</b>
No sound coming from the external speakers	Cannot hear any sound	<ul style="list-style-type: none"><li>• Turn Off the monitor, unplug the monitor power cord, replug it, and then turn On the monitor.</li><li>• Ensure the audio cable is connected correctly between the Audio Line Out port and the external speaker.</li><li>• Disconnect/reconnect the audio cable from the Audio Line Out port and the external speaker.</li><li>• Reset the monitor to factory settings.</li></ul>



# Regulatory information

## FCC notices (U.S. only) and other regulatory information

For FCC notices and other regulatory information, see the regulatory compliance website located at [www.dell.com/regulatory\\_compliance](http://www.dell.com/regulatory_compliance).

## EU product database for energy label and product information sheet

U3423WE: <https://eprel.ec.europa.eu/qr/1264609>



# Contact Dell

To contact Dell for sales, technical support, or customer service issues, see [www.dell.com/contactdell](http://www.dell.com/contactdell).



**NOTE: Availability varies by country and product, and some services may not be available in your country.**



**NOTE: If you do not have an active Internet connection, you can find contact information on your purchase invoice, packing slip, bill, or Dell product catalog.**

