

Product Datasheet

QSFP-4X10G-AOC15M-AR-C

Arista® Compatible 40GBASE-SR4 QSFP+ to 4x10GBASE-SR SFP+ Active Optical Breakout Cable, 15m

FEATURES

- Up to 25.78125Gbps Data rate per channel
- Maximum link length of 70m on OM3 MMF or 100m on OM4 MMF
- 850nm VCSEL transmitter
- PIN photo detector receiver
- Hot-pluggable QSFP28 & SFP28 form factor
- Internal CDR circuits on both receiver and Transmitter channels
- Support CDR bypass
- Built-in digital diagnostic functions
- Single +3.3V power supply
- Low power consumption <2.5W(QSFP28) & <1W(SFP28)
- Operating case temperature: 0~+70°C
- SFF-8436 compliant QSFP28 connector
- SFF-8431 compliant 4xSFP28 connectors

APPLICATIONS

- 100GBASE-SR4 100G Ethernet
- Infiniband EDR, FDR, QDR
- High-Performance Computing (HPC) clusters

DESCRIPTION

For typical applications, users can install this breakout or splitter cable between an available QSFP28 port on 100GE switch and feed up to 4 upstream SFP28 enabled 25GE switches. Each cable features a single SFF-8436 compliant QSFP28 connector rated for 103Gb/s on one end and 4 SFF-8431 compliant SFP28 connectors rated for 25.78Gb/s each on the other end.

The 100G QSFP28 to 4x25G SFP28 breakout Active Optical Cables (AOCs) offer IT professionals a cost-effective interconnect solution for merging 100G QSFP28 and 25G SFP28 enabled host adapters, switches and servers.

Product Datasheet



Figure 1. Transceiver functional Block Diagram

Standard

- Compliant with SFF-8665 Specification
- Compliant with IEEE 802.3bm 100GBASE-SR4
- Compliant with IEEE 802.3by 25GBASE-SR
- Compliant with GR-468-CORE
- RoHS Compliant

Regulatory Compliance

Product Certificate	Certificate Number	Applicable Standard
TUV	R50135086	EN 60950-1 :2006+A11+A1+A12+A2 EN 60825-1 :2014 EN 60825-2 :2004+A1+A2
UL	E317337	UL 60950-1 CSA C22.2 No. 60950-1-07
EMC CE	AE 50285865 0001	EN 55022:2010 EN 55024:2010
FCC	WTF14F0514417E	47 CFR PART 15 OCT., 2013
FDA	/	CDRH 1040.10
ROHS	/	2011/65/ EU

Product Datasheet

Absolute Maximum Ratings

Parameter	Symbol	Min	Typ	Max	Unit
Maximum Supply Voltage	VCC	-0.5	-	+4.0	V
Storage Temperature	TS	-40	-	+85	° C
Case Operating Temperature	TA	-5	-	+75	° C
Relative Humidity	RH	5	-	95	%

Note:

1. The operation in excess of any absolute maximum ratings might cause permanent damage to this module
2. Non-condensing

Recommended Operating Environment

Parameter	Symbol	Min	Typ	Max	Unit	Notes
Data Rate, each lane	BR	-	25.78125	-	Gbps	
Data Rate Variation, each lane		- 100	-	+ 100	ppm	
Power Supply Voltage	VCC	3.13	3.3	3.47	V	
Power Supply Current (QSFP28)	ICC	-	-	750	mA	
Power Dissipation (QSFP28)	PD	-	-	2.5	W	
Power Supply Current (SFP28)	ICC	-	-	300	mA	
Power Dissipation (SFP28)	PD	-	-	1.0	W	
Case Operating Temperature	TA	0	-	+70	°C	
Relative Humidity	RH	5	-	85	%	1
Transmission Distance	TD	-	-	100	m	2
Fiber Bend Radius	Rb	30	-	-	mm	

Notes:

1. Non-condensing
2. Measured with ITU-T G.651 OM4 MMF

Product Datasheet

Electrical Specifications (TOP = 0 to +70 °C, VCC = 3.13 to 3.47 V)

Parameter	Symbol	Min	Typ	Max	Unit
Differential Data Input Amplitude	VIN, P- P	180	-	900	mVpp
Input Differential Impedance	ZIN	90	100	110	Ω
Transmitter Fault Output- High	VOH	2.4	-	VCC	V
Transmitter Fault Output- Low	VOL	-0.3	-	0.4	V
Transmitter Disable Voltage- High	VIH	2.0	-	VCC	V
Transmitter Disable Voltage- low	VIL	0	-	0.8	V
Differential output voltage swing	VOUT, P- P	300	-	900	mVpp
Output Differential Impedance	ZOUT	90	100	110	Ω
LOS Output Voltage- High	VLOSH	2.0	-	VCC	V
LOS Output Voltage- Low	VLOSL	-	-	0.8	V

Product Datasheet

Optical Characteristics (TOP = 0 to +70 °C, VCC = 3.13 to 3.47 V)

Parameter	Symbol	Min	Typ	Max	Unit	Notes
Transmitter						
Optical Center Wavelength	λ_C	840	850	860	nm	
RMS Spectral Width	σ	-	-	0.6	nm	
Data Rate, each lane	BR	-	25.78125	-	Gbps	
Data Rate Variation, each lane		- 100	-	+ 100	ppm	
Average Launch Power, each lane	PO	-8.4	-	2.4	dBm	1
Optical Modulation Amplitude, each lane	POMA	-6.4	-	3.0	dBm	
Optical Extinction Ratio	ER	2.0	-	-	dB	
Transmitter and dispersion eye closure, each lane	TDEC	-	-	4.3	dBm	
Launch Power (OMA) minus TDEC, each lane	P-TDEC	-7.3	-	-	dBm	
Optical Return Loss Tolerance	ORL	-	-	12	dB	
Average Launch power of Tx OFF, each lane	POFF	-	-	-30	dBm	
Transmitter Eye Mask coordinates: X1, X2, X3, Y1, Y2, Y3		SPECIFICATION VALUES {0.3,0.38,0.45,0.35,0.41,0.5}				2
Receiver						
Center Wavelength Range	λ_C	840	850	860	nm	
Data Rate, each lane	BR	-	25.78125	-	Gbps	
Data Rate Variation, each lane		- 100	-	+ 100	ppm	
Receiver Power (OMA), each lane	POMA	-	-	3.0	dBm	
Average Receive Power, each lane	RPO	- 10.3	-	2.4	dBm	1
Receiver Sensitivity (OMA), each lane	RSEN	-	-	- 10.3	dBm	3
Stressed Receiver Sensitivity (OMA), each lane	RSRS	-	-	-5.2	dBm	
LOS Assert	LOSA	-30	-	-	dBm	
LOS De-Assert	LOSD	-	-	- 13	dBm	
LOS Hysteresis	LOSH	0.5	-	5.0	dB	
Receiver Reflectance	RR	-	-	- 12	dB	

Product Datasheet

Notes:

1. Average launch/receive power, each lane (min) is informative and not the principal indicator of signal strength. A transmitter with launch/receive power below this value cannot be compliant; however, a value above this does not ensure compliance
2. Hit Ratio 5×10^{-5} hits/sample
3. Measured with worst ER=2.5d B, RPBS $2^{31}-1$ test pattern @25.78125Gbps BER= $\ll 5E-5$

Product Datasheet

Pin Assignment

Pin	Symbol	Name/Description	Notes
1	GND	Ground	1
2	Tx2n	Transmitter Inverted Data Input	
3	Tx2p	Transmitter Non- Inverted Data Input	
4	GND	Ground	1
5	Tx4n	Transmitter Inverted Data Input	
6	Tx4p	Transmitter Non- Inverted Data Input	
7	GND	Ground	1
8	ModSelL	Module Select	2
9	ResetL	Module Reset	2
10	Vcc Rx	+3.3 V Power supply receiver	
11	SCL	2-wire serial interface clock	2
12	SDA	2-wire serial interface data	2
13	GND	Ground	1
14	Rx3p	Receiver Non- Inverted Data Output	
15	Rx3n	Receiver Inverted Data Output	
16	GND	Ground	1
17	Rx 1p	Receiver Non- Inverted Data Output	
18	Rx 1n	Receiver Inverted Data Output	
19	GND	Ground	1
20	GND	Ground	
21	Rx2n	Receiver Inverted Data Output	
22	Rx2p	Receiver Non- Inverted Data Output	
23	GND	Ground	1
24	Rx4n	Receiver Inverted Data Output	
25	Rx4p	Receiver Non- Inverted Data Output	
26	GND	Ground	1
27	ModPrsL	Module Present	
28	IntL	Interrupt	2
29	Vcc Tx	+3.3 V Power supply transmitter	
30	Vcc1	+3.3 V Power Supply	
31	LPMode	Low Power Mode	2
32	GND	Ground	1

Product Datasheet

33	Tx3p	Transmitter Non- Inverted Data Input	
34	Tx3n	Transmitter Inverted Data Input	
35	GND	Ground	1
36	Tx1p	Transmitter Non- Inverted Data Input	
37	Tx1n	Transmitter Inverted Data Input	
38	GND	Ground	1

Notes:

1. Circuit ground is internally isolated from chassis ground
2. Open collector; should be pulled up with a 4.7kΩ to 10kΩ resistor on host board to a voltage between 3.15V and 3.6V



Figure 2. Host PCB QSFP28 pad assignment top view and Names

Optical Interface Lanes and Assignment

The optical interface port is a male MPO connector, the keying feature of the MPO receptacle is on the top, then fibers are numbered left to right as 12 through 1 looking into the receptacle. The four fiber positions on the left (fibers 12, 11, 10, 9) are used for the optical transmit signals (Channel 1 through 4). The fiber positions on the right (fibers 4, 3, 2, 1) are used for the optical receive signals (Channel 4 through 1). The central four fibers (5, 6, 7, 8) may be physically present.

Product Datasheet



Fiber Number: 12 11 10 9 x x x x 4 3 2 1
Transmit Channels: 1 2 3 4
Receive Channels: 4 3 2 1

Figure 3. QSFP28 Optical Receptacle and Channel Orientation

Product Datasheet

Pin Descriptions (SFP28)

PIN	Name	Function/Description
1	VeeT	Module Transmitter Ground
2	Tx_Fault	Module Transmitter Fault
3	Tx_Disable	Transmitter Disable, Turns off transmitter laser output
4	SDA	Two wire serial interface Data input/output (SDA)
5	SCL	Two wire serial interface Clock input (SCL)
6	MOD_ABS	Module Absent, connected to VeeT or VeeR in the module
7	RS0	Receiver Rate Select
8	Rx_LOS	Loss of Signal indication, Logic 0 indicates normal operation
9	RS1	Transmitter Rate Select, not used for this product
10	VeeR	Module Receiver Ground
11	VeeR	Module Receiver Ground
12	RD-	Receiver Inverted DATA output, AC Coupled
13	RD+	Receiver Non-inverted DATA output, AC Coupled
14	VeeR	Module Receiver Ground
15	VccR	Module Receiver 3.3V Supply
16	VccT	Module Transmitter 3.3V Supply
17	VeeT	Module Transmitter Ground
18	TD+	Transmitter Non-Inverted DATA input, AC Coupled
19	TD-	Transmitter Inverted DATA input, AC Coupled
20	VeeT	Module Transmitter Ground

Notes:

1. Open collector/drain output, which should be pulled up with a 4.7kΩ to 10kΩ resistor on the host board if intended for use. Pull up voltage should be between 2.0V to 3.6V. A high output indicates a transmitter fault caused by either the TX bias current or the TX output power exceeding the preset alarm thresholds. A low output indicates normal operation. In the low state, the output is pulled to <0.8V.
2. Laser output disabled on Tx_Disable >2.0V or open, enabled on Tx_Disable <0.8V.
3. LOS is open collector output. Should be pulled up with 4.7kΩ to 10kΩ on host board to a voltage between 2.0V and 3.6V. Logic 0 indicates normal operation; logic 1 indicates loss of signal.
4. RD-/+: These are the differential receiver outputs. They are internally AC-coupled 100Ω differential lines which should be terminated with 100Ω (differential) at the user SERDES.
5. TD-/+: These are the differential transmitter inputs. They are internally AC-coupled, differential lines with 100Ω differential termination inside the module.

Product Datasheet

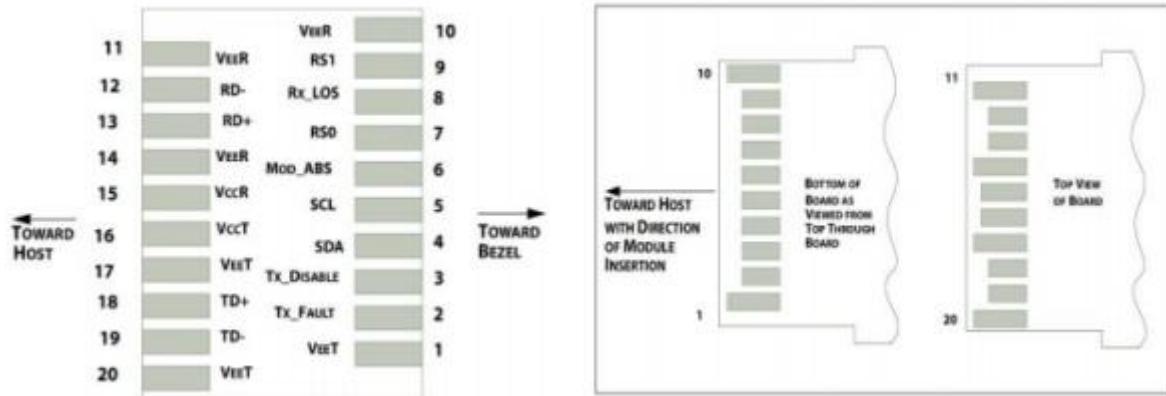

Figure 4. Host PCB SFP+ pad assignment top view and Names

Digital Diagnostic Monitoring Interface (QSFP28)

Digital diagnostics monitoring function is available on all QSFP28 module. A 2-wire serial interface provides user to contact with module. The structure of the memory is shown in Figure 4. The memory space is arranged into a lower, single page, address space of 128 bytes and multiple upper address space pages. This structure permits timely access to addresses in the lower page, such as Interrupt Flags and Monitors. Less time critical time entries, such as serial ID information and threshold settings, are available with the Page Select function. The interface address used is A0xh and is mainly used for time critical data like interrupt handling in order to enable a one-time- read for all data related to an interrupt situation. After an interrupt, IntL, has been asserted, the host can read out the flag field to determine the affected channel and type of flag.

Product Datasheet



Figure 5. QSFP28 Memory Map (Specific Data Field Descriptions)

Digital Diagnostic Memory Map (SFP28)

The transceivers provide serial ID memory contents and diagnostic information about the present operating conditions by the 2-wire serial interface (SCL, SDA). The diagnostic information with internal calibration or external calibration all are implemented, including received power monitoring, transmitted power monitoring, bias current monitoring, supply voltage monitoring and temperature monitoring. The digital diagnostic memory map specific data field defines as following.

Product Datasheet

Digital Diagnostic Memory Map (Specific Data Field Descriptions)



Digital Diagnostic Monitor Characteristics

Parameter	Calibration	Range	Accuracy	Unit
Transceiver Internal Temperature	Internal	0 to +70°C	± 5.0	°C
VCC Internal Supply Voltage	Internal	3.0 to 3.6V	± 3.0	%
Laser Bias Current, each lane	Internal	0 to 15mA	± 10	%
Tx Output Power, each lane	Internal	-8.4 to 3d Bm	± 3.0	dBm
Rx Input Power, each lane	Internal	- 12.0 to 3d Bm	± 3.0	dBm

Product Datasheet

Timing and Electrical

Parameter	Symbol	Min	Typ	Max	Unit
Initialization Time	t_init	-	-	2000	ms
Reset Init Assert Time	t_reset_init	-	-	2	us
Serial Bus Hardware Ready Time	t_serial	-	-	2000	ms
Monitor Data Ready Time	t_data	-	-	2000	ms
Reset Assert Time	t_reset	-	-	2000	ms
LPMODE Assert Time	ton_LPMODE	-	-	100	us
IntL Assert Time	ton_IntL	-	-	200	ms
IntL Deassert Time	toff_IntL	-	-	500	us
Rx LOS Assert Time	ton_los	-	-	100	ms
Tx Fault Assert Time	ton_Txfault	-	-	200	ms
Flag Assert Time	ton_flag	-	-	200	ms
Mask Assert Time	ton_mask	-	-	100	ms
Mask Deassert Time	toff_mask	-	-	100	ms
ModSelL Assert Time	ton_ModSelL	-	-	100	us
ModSelL Deassert Time	toff_ModSelL	-	-	100	us
Power over-ride or Power-set Assert Time	ton_Pdown	-	-	100	ms
Power over-ride or Power-set Deassert Time	toff_Pdown	-	-	300	ms

Recommended Circuit



Figure 6. Recommended Host Board Power Supply Circuit (QSFP28)

Product Datasheet

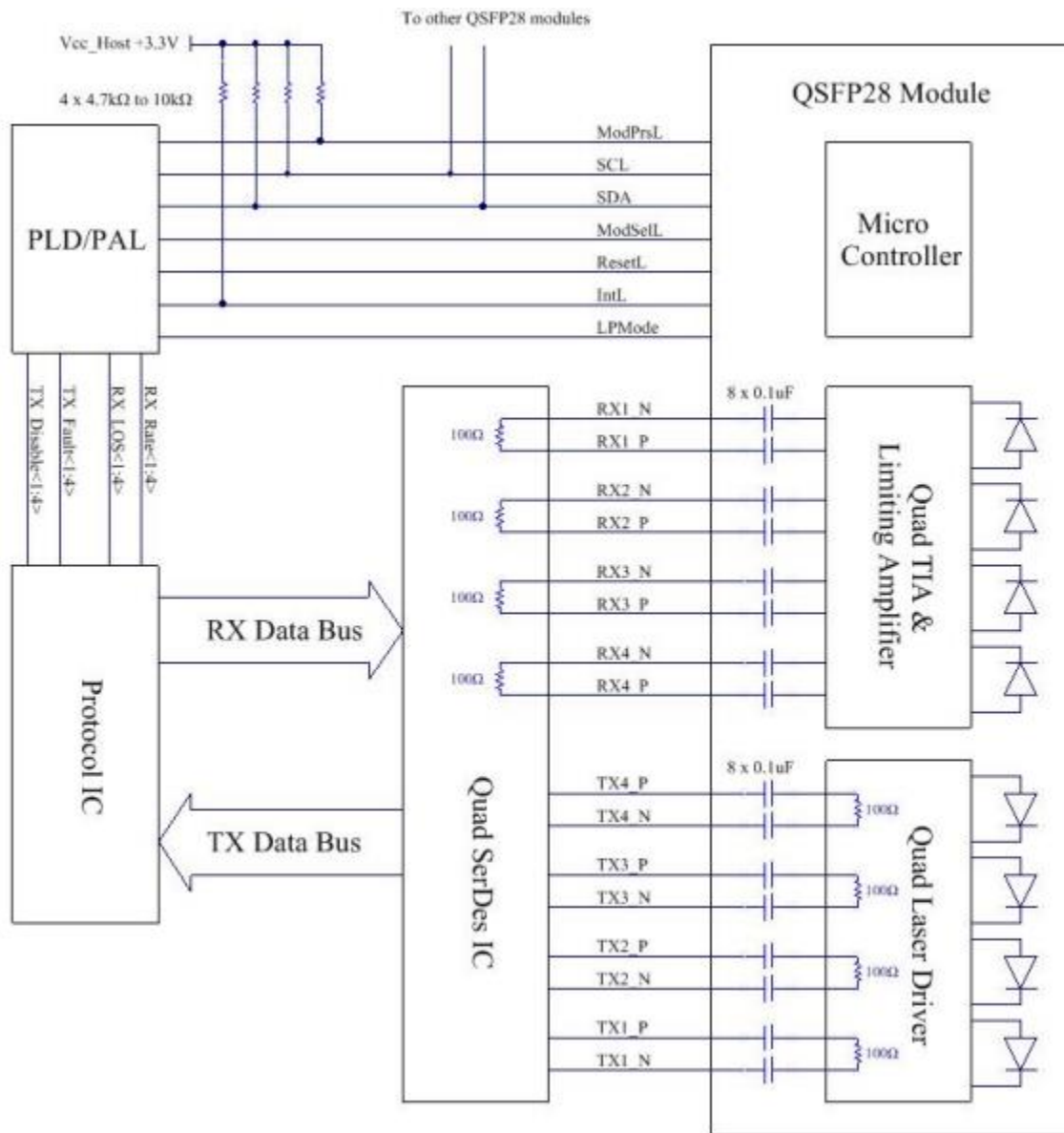

Figure 7. Recommended Interface Circuit (QSFP28)

Product Datasheet

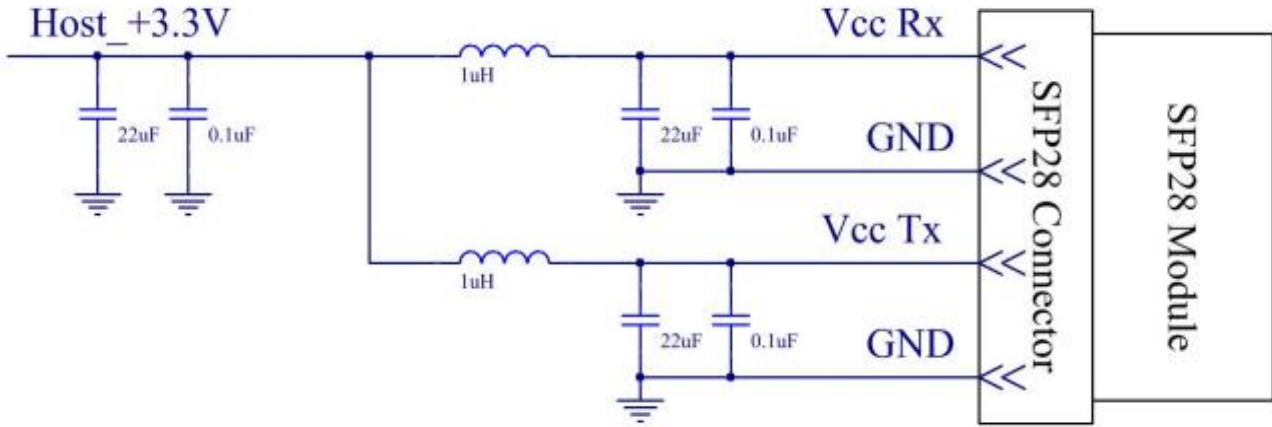

Figure 8. Recommended Host Board Power Supply Circuit (SFP28)

Product Datasheet



Figure 9. Recommended Interface Circuit (SFP28)

Product Datasheet

Technical Dimensions

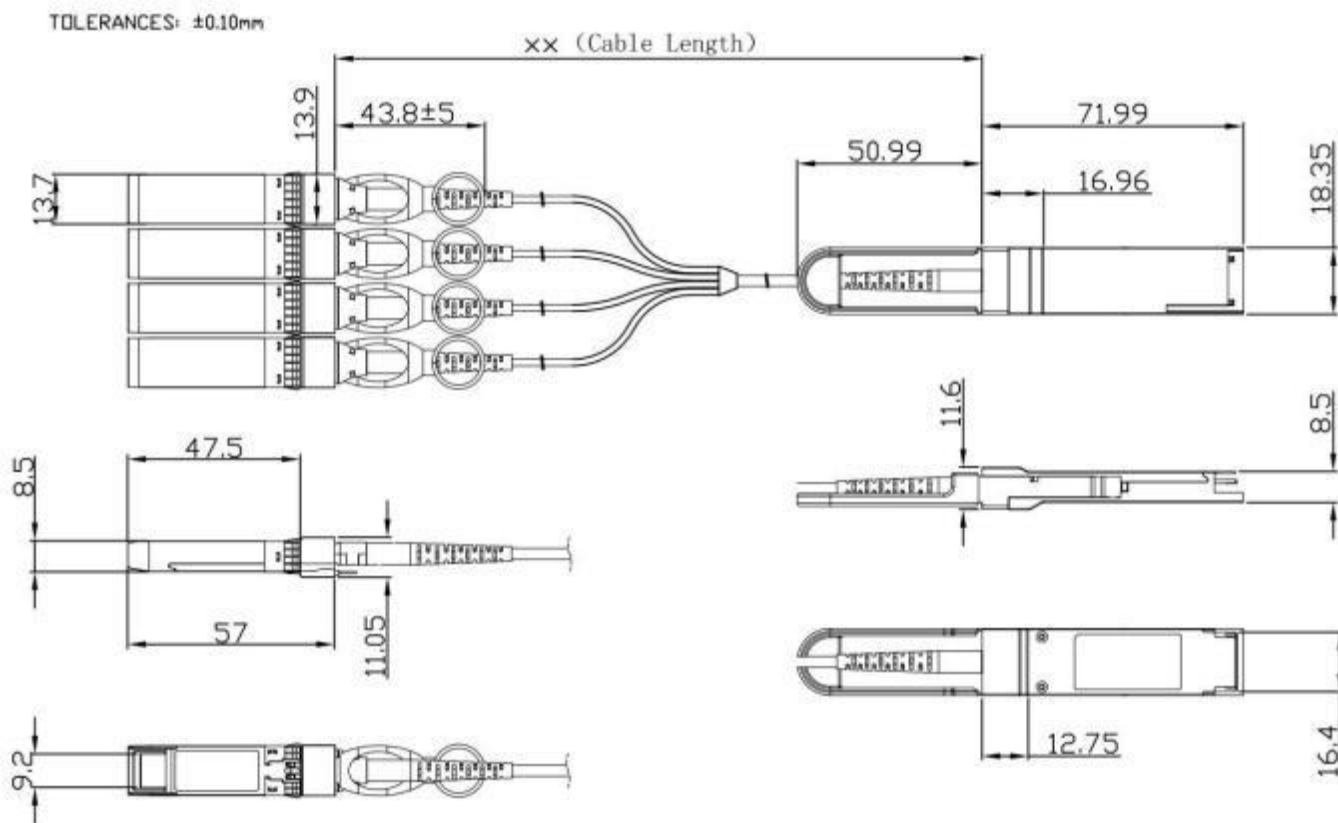

Figure 10. Mechanical Dimensions