

4

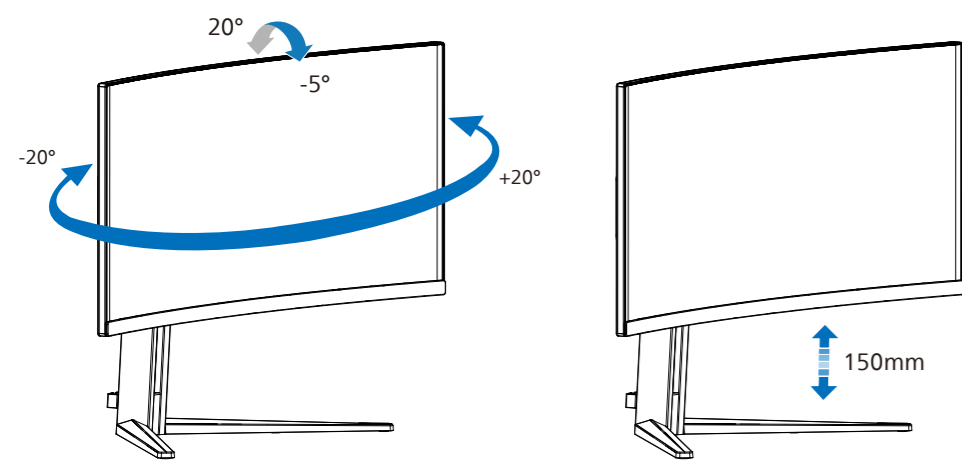

5

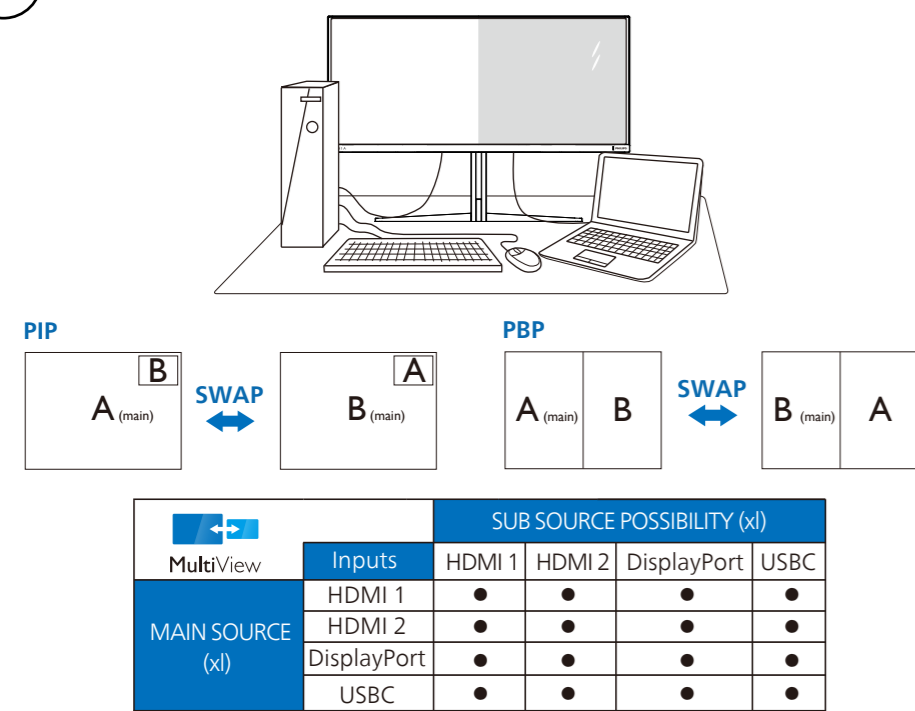

Register your product and get support at www.philips.com/support



Version: 34M2C8600Q1T
2022 © TOP Victory Investments Ltd. All rights reserved.

This product has been manufactured by and is sold under the responsibility of Top Victory Investments Ltd., and Top Victory Investments Ltd. is the warrantor in relation to this product. Philips and the Philips Shield Emblem are registered trademarks of Koninklijke Philips N.V. and are used under license.

Specifications are subject to change without notice.

HDMI
The terms HDMI, HDMI High-Definition Multimedia Interface, HDMI Trade Dress and the HDMI Logos are trademarks or registered trademarks of HDMI Licensing Administrator, Inc.

www.philips.com

Energy Labelling
34M2C8600



Printed in China



EVNIA

Quick start



34M2C8600

Register your product and get support at www.philips.com/welcome

PHILIPS

Contents

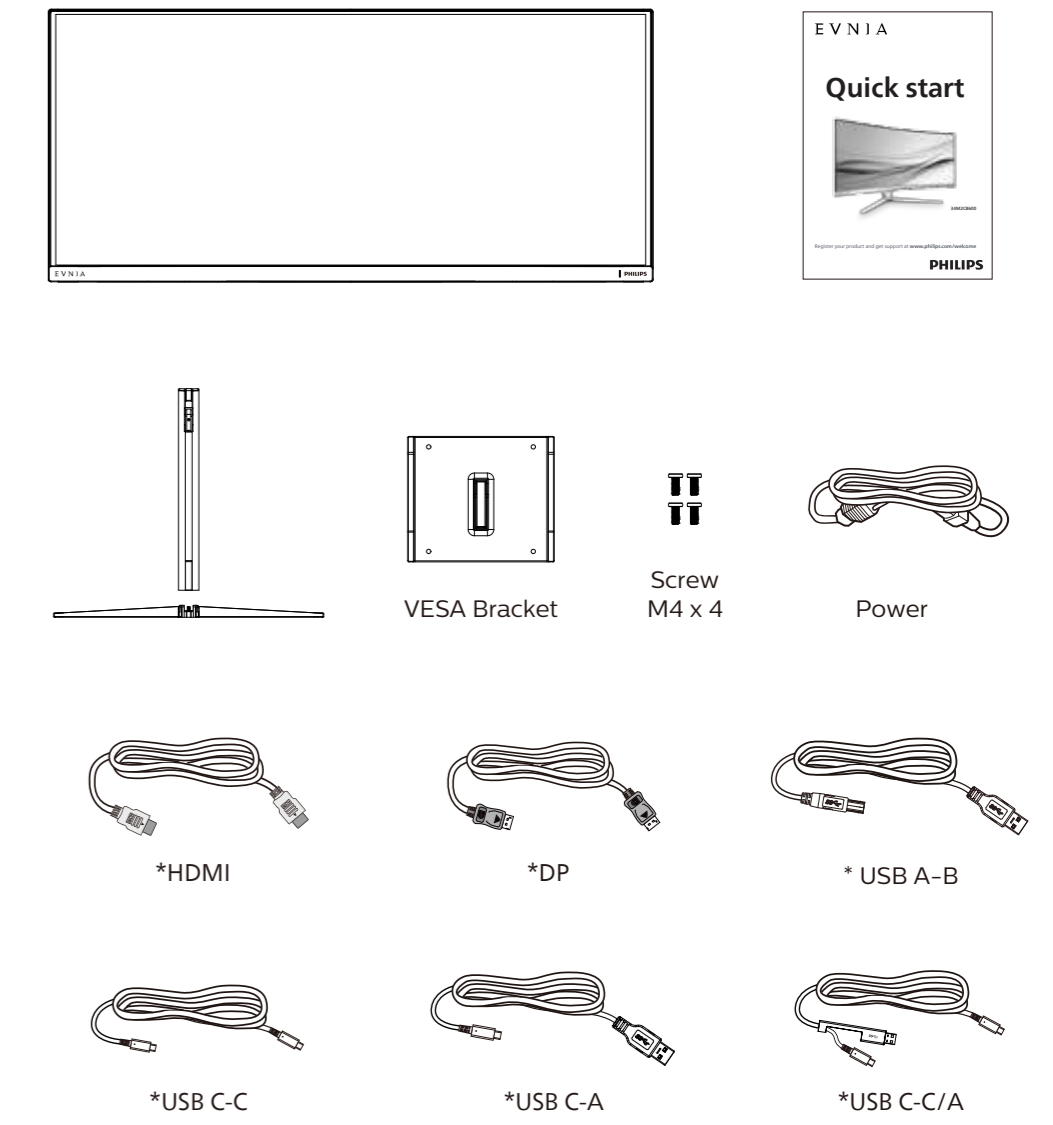

*Different according to region
Display design may differ from that illustrated

1

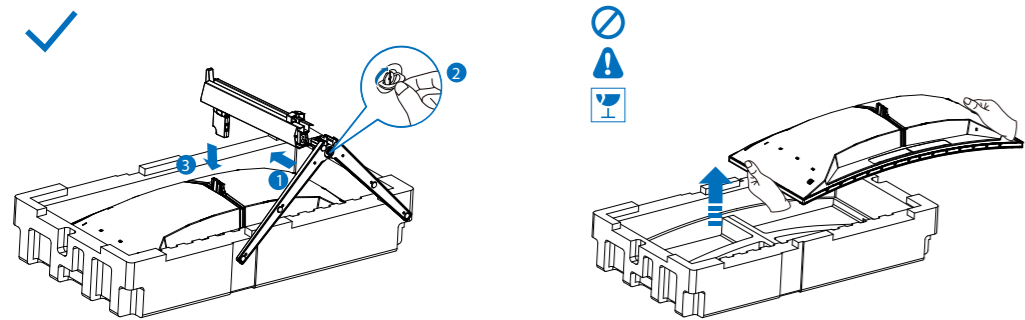

CAUTION: Place the monitor face down on a smooth surface. Pay attention not to scratch or damage the screen.

2

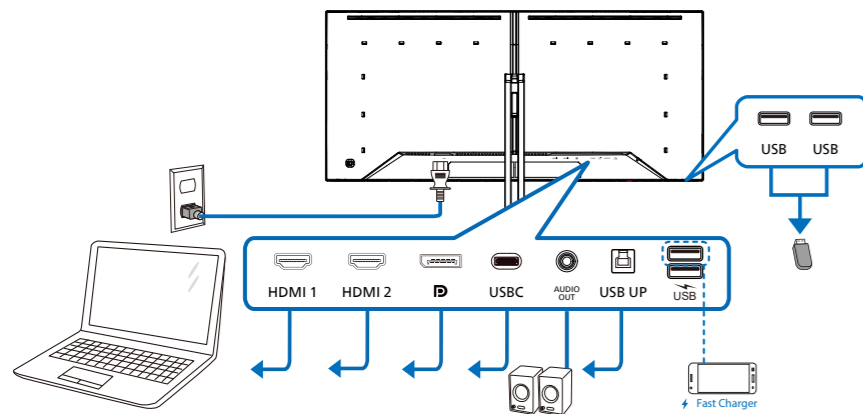

USB C-C

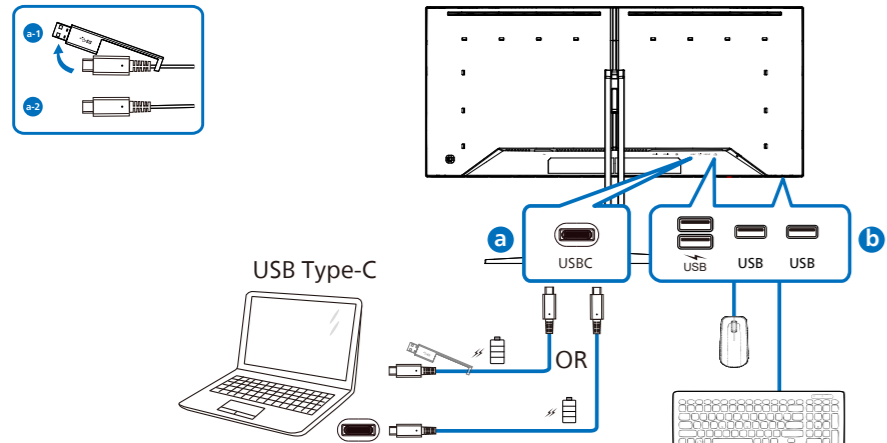

USB A-C

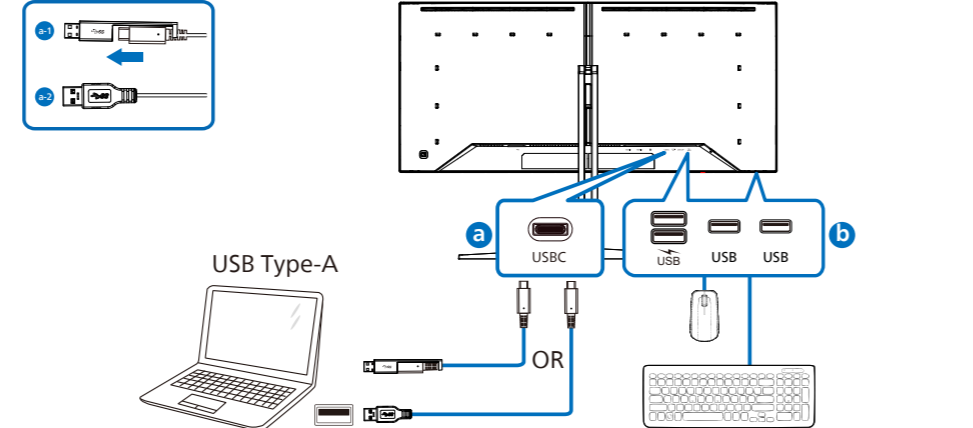

USB hub

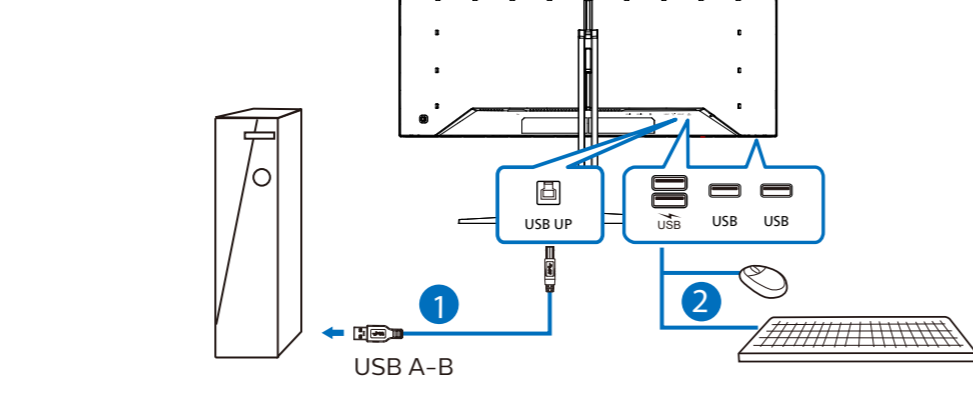

KVM

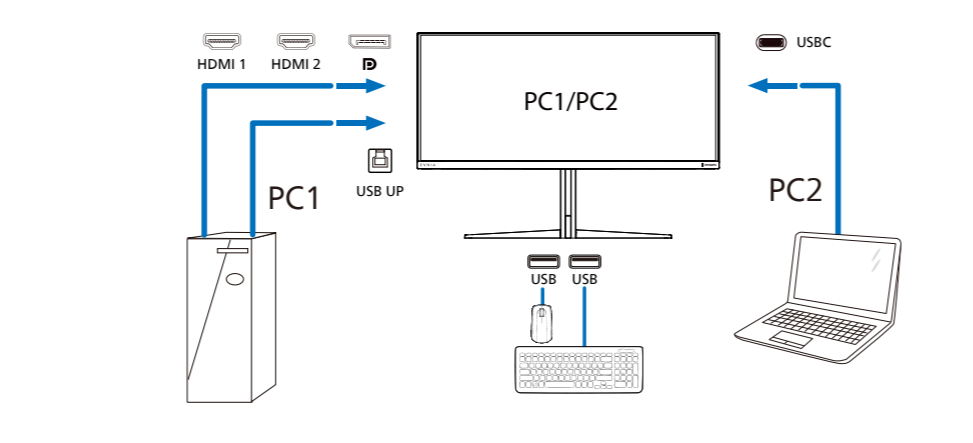

3

