

## Product Datasheet

### AFBR-7CER20Z-C

#### Avago Broadcom® Compatible 1G/10Gb/s SFP+ Active Optical Cable, Active, 20m

##### FEATURES

- Hot pluggable
- Bit rate support from 1G to 11.3Gbps
- Up to 100m by active optical cable with OM2/OM3 fiber
- Pre-terminated fiber cable
- Operating environment temperature 0 ~ 70°C
- Low power consumption
- SFP+ housing with enhanced EMI shielding
- Single 3.3V power supply
- Programmable EEPROM for serial identification

##### APPLICATIONS

- 10G Ethernet
- Applicable to 1G Ethernet
- 8G Fiber Channel
- Applicable to 4G / 2G / 1G Fiber Channel
- 10G Fiber Channel over Ethernet
- 1X QDR Infiniband
- Applicable to 1X DDR / 1x SDR Infiniband
- High-capacity IO with SFP+ interface
- Data center and in-rack connection
- Compliance
- SFF-8431 SFP+ Electrical MSA
- SFF-8432 SFP+ Mechanical MSA
- RoHS complaint

##### DESCRIPTION

ATGBICS SFP AOC cable assemblies are high-performance, cost effective I/O solutions for 10Gb Ethernet and 10G Fiber Channel applications. SFP+ active optical cables allow hardware manufacturers to achieve high port density, configurability, and utilization at a very low cost and to reduce power budget. The high-speed cable assemblies meet and exceed the performance and reliability requirements stipulated by Gigabit Ethernet and Fiber Channel industry standard.

## Product Datasheet

### Host Board Connector Pin (Top View)

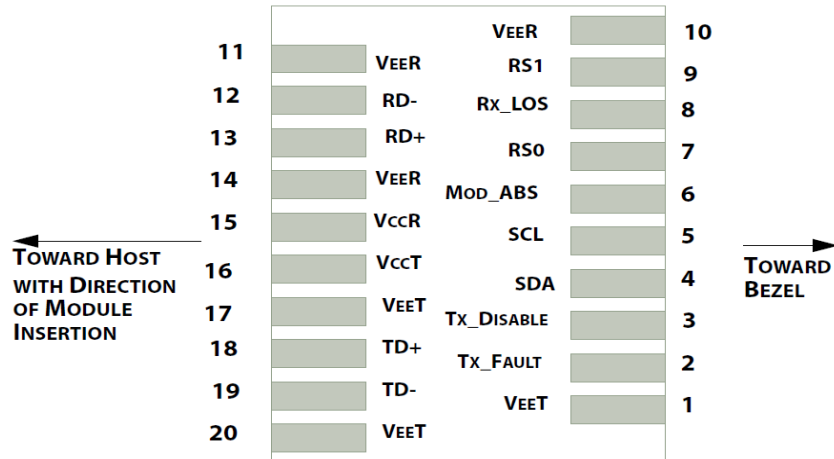

#### Note:

1. For detail information, please refer to SFF-8083 0.8mm Card Edge Connector for 8/10 Gbps Applications

## Product Datasheet

### SFP+ Connector Pin

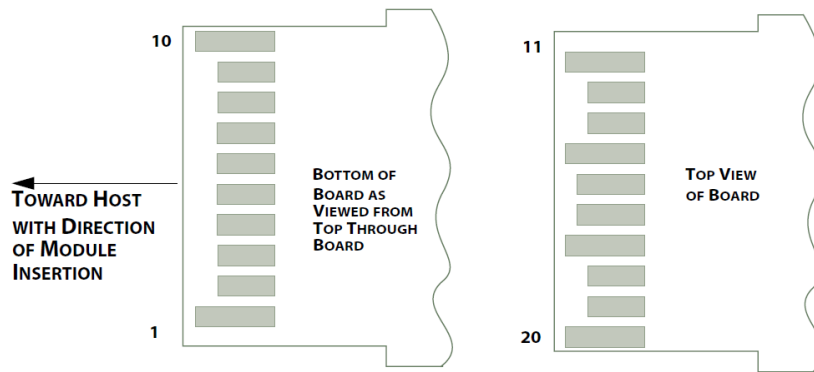

Pin	Symbol	Logic	Description	Note
1	VeeT		Module Transmitter Ground	1
2	Tx_Fault	LVTTL-O	Not supported.	3
3	Tx_Disable	LVTTL-I	Not supported.	3
4	SDA	LVTTL-I/O	2-wire Serial Interface Data Line	2
5	SCL	LVTTL-I/O	2-wire Serial Interface Clock	2
6	Mod_ABS		Module Absent	2
7	RS0	LVTTL-I	Not supported.	3
8	Rx_LOS	LVTTL-O	Not supported.	3
9	RS1	LVTTL-I	Not supported.	3
10	VeeR		Module Receiver Ground	1
11	VeeR		Module Receiver Ground	1
12	RD-	CML-O	Receiver Inverted Data Output	
13	RD+	CML-O	Receiver Non-Inverted Data Output	
14	VeeR		Module Receiver Ground	1
15	VccR		Module Receiver 3.3 V Supply	4
16	VccT		Module Transmitter 3.3 V Supply	4
17	VeeT		Module Transmitter Ground	1
18	TD+	CML-I	Transmitter Non-Inverted Data Input	
19	TD-	CML-I	Transmitter Inverted Data Input	
20	VeeT		Module Transmitter Ground	1

## Product Datasheet

### Notes:

1. Module circuit ground pins are isolated from the module chassis ground
2. Pull up to VccHost with 4.7k – 10k
3. No connection required
4. Power supply filtering circuit required

### Absolute Maximum Ratings

Parameter	Symbol	Min	Max	Unit
Storage Temperature	Ts	-40	+85	°C
Operating Case Temperature	Tc	-40	+85	°C
Operating Humidity	RH		85	%
Supply Voltage	Vcc	-0.5	3.6	V

### Note:

Damage may occur if the transceiver is subjected to conditions beyond the limits.

### Recommended Operating Conditions

Parameter	Symbol	Min	Max	Unit
Operating Case Temperature	Tc	0	+70	°C
Supply Voltage	Vcc	3.1	3.5	V
Bit Rate	BR	1	11.3	GB

## Product Datasheet

### Host PCB Layout

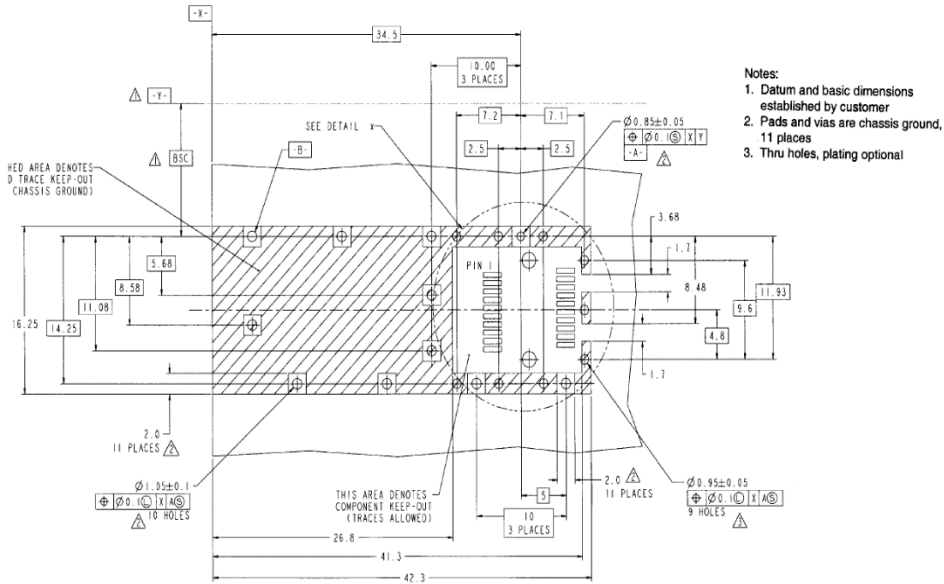

## Product Datasheet

### Recommended Power Supply Filter



### References:

1. SFF-8431 “Specifications for Enhanced Small Form Factor Pluggable Module SFP+”
2. SFF-8432 “Specification for Improved Pluggable Form factor”
3. SFF-8472 “Specification for Diagnostic Monitoring Interface for Optical Transceivers”

### Mechanical Drawing

