

# OptiPlex All-in-One 7410

## Owner's Manual

## Notes, cautions, and warnings

 **NOTE:** A NOTE indicates important information that helps you make better use of your product.

 **CAUTION:** A CAUTION indicates either potential damage to hardware or loss of data and tells you how to avoid the problem.

 **WARNING:** A WARNING indicates a potential for property damage, personal injury, or death.

# Contents

<b>Chapter 1: High Performance and Energy Efficient.....</b>	<b>6</b>
<b>Chapter 2: Views of OptiPlex All-in-One 7410.....</b>	<b>7</b>
Right.....	7
Left.....	8
Display.....	9
Retractable camera .....	10
Bottom.....	11
Back panel.....	12
Service Tag.....	14
<b>Chapter 3: Set up your computer.....</b>	<b>15</b>
<b>Chapter 4: Specifications of OptiPlex All-in-One 7410.....</b>	<b>20</b>
Dimensions and weight.....	20
Processor.....	20
Chipset.....	22
Operating system.....	23
Memory.....	23
External ports.....	24
Internal slots.....	25
Ethernet.....	25
Wireless module.....	26
Audio.....	26
Storage.....	27
Media-card reader.....	27
Camera.....	28
Power.....	28
Power supply connector.....	30
Display.....	30
GPU—Integrated.....	31
Hardware security.....	31
Environmental.....	32
Operating and storage environment.....	32
<b>Chapter 5: Working inside your computer.....</b>	<b>33</b>
Safety instructions.....	33
Before working inside your computer.....	33
Safety precautions.....	34
Electrostatic discharge—ESD protection.....	34
ESD field service kit .....	35
Transporting sensitive components.....	36
After working inside your computer.....	36
BitLocker.....	36

Recommended tools.....	36
Screw list.....	37
Major components of OptiPlex All-in-One 7410.....	38
<b>Chapter 6: High Performance and Energy Efficient.....</b>	<b>41</b>
<b>Chapter 7: Removal and installation procedures for High Performance processors.....</b>	<b>42</b>
Removing and installing Customer Replaceable Units (CRUs).....	42
Stand.....	42
Back cover.....	45
Memory.....	47
System-board shield.....	50
Wireless card.....	51
Solid-state drive in M.2 slot 0.....	54
Solid-state drive in M.2 slot 1.....	58
Coin-cell battery.....	63
I/O cover.....	65
Bottom cover.....	67
Retractable-camera assembly.....	69
Fan.....	72
Power-supply unit.....	73
Removing and installing Field Replaceable Units (FRUs).....	76
Power-supply fan.....	76
I/O bracket.....	82
Speakers.....	84
Heat sink.....	85
Processor.....	87
System board.....	90
Power-button and I/O board.....	97
Audio board.....	100
Display-assembly base.....	102
<b>Chapter 8: Removal and installation procedures for Energy Efficient processors.....</b>	<b>105</b>
Removing and installing Customer Replaceable Units (CRUs).....	105
Stand.....	105
Back cover.....	108
Memory.....	109
System-board shield.....	112
Wireless card.....	113
Solid-state drive.....	116
Hard drive.....	120
Coin-cell battery.....	123
I/O cover.....	124
Bottom cover.....	126
Retractable-camera assembly.....	127
Fan.....	129
Removing and installing Field Replaceable Units (FRUs).....	131
I/O bracket.....	132
Speakers.....	133

Heat sink.....	135
Processor.....	137
System board.....	140
Power-button and I/O board.....	147
Audio board.....	149
Display-assembly base.....	150
<b>Chapter 9: Software.....</b>	<b>153</b>
Operating system.....	153
Drivers and downloads.....	153
<b>Chapter 10: BIOS setup.....</b>	<b>154</b>
Entering BIOS setup program.....	154
Navigation keys.....	154
One Time Boot menu.....	154
System setup options.....	155
Updating the BIOS.....	163
Updating the BIOS in Windows.....	163
Updating the BIOS using the USB drive in Windows.....	164
Updating the BIOS in Linux and Ubuntu.....	164
Updating the BIOS from the F12 One Time Boot menu.....	164
System and setup password.....	165
Assigning a system setup password.....	165
Deleting or changing an existing system setup password.....	166
Clearing CMOS settings.....	166
Clearing BIOS (System Setup) and System passwords.....	166
<b>Chapter 11: Troubleshooting.....</b>	<b>167</b>
Dell SupportAssist Pre-boot System Performance Check diagnostics.....	167
Running the SupportAssist Pre-Boot System Performance Check.....	167
Power-Supply Unit Built-in Self-Test .....	167
System-diagnostic lights.....	168
Recovering the operating system.....	169
Real Time Clock—RTC reset.....	169
Backup media and recovery options.....	170
Wi-Fi power cycle.....	170
<b>Chapter 12: Getting help and contacting Dell.....</b>	<b>171</b>

# High Performance and Energy Efficient

To determine the specifications and features of your OptiPlex All-in-One 7410 some specifications in this document have been mentioned to be available only on computers with High Performance or Energy efficient processors.

**High Performance and Energy Efficient processors can be determined as follows:**

- **High Performance:** Computers shipped with 46 W, 60 W or 65 W processors and a power-supply unit.
- **Energy Efficient:** Computers shipped with 35 W processors and a power adapter.

## Views of OptiPlex All-in-One 7410

### Right



#### 1. USB 3.2 Gen 2 port with PowerShare

Connect devices such as external storage devices, printers, and external displays.

Provides data transfer speeds up to 10 Gbps. Supports Power Delivery that enables two-way power supply between devices. Provides up to 10 W power output that enables faster charging.

**i** **NOTE:** PowerShare enables you to charge your USB devices even when your computer is turned off.

**i** **NOTE:** If a USB device is connected to the PowerShare port before the computer is turned off or in hibernate state, you must disconnect and connect it again to enable charging.

## Left



**1. Storage drive activity light**

The activity light turns on when the computer reads from or writes to storage drives.

**2. Universal audio port**

Connect headphones or a headset (headphone and microphone combo).



# Display



**1. Left microphone**

Provides digital sound input for audio recording and voice calls.

**2. Right microphone**

Provides digital sound input for audio recording and voice calls.

**3. Retractable camera**

Enables you to video-chat, capture photos, and record videos. To protect your privacy, this camera can be retracted when it is not in use.

**4. Right speaker**

Provides audio output.

**5. Left speaker**

Provides audio output.

# Retractable camera

## Locating the retractable camera

**NOTE:** To access your retractable camera, press down on the retractable camera located at the top of your computer. To conceal your retractable camera and protect your privacy, press down on the retractable camera until it clicks into place.



## Retractable camera view

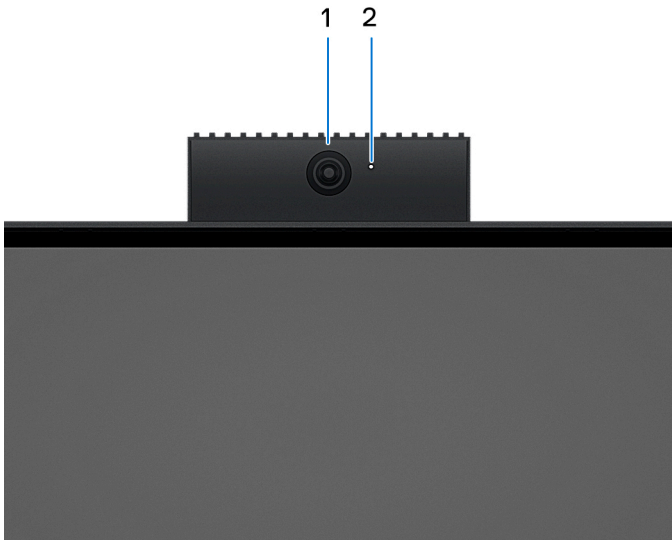

- 1. Camera**  
Enables you to video chat, capture photos, and record videos.
- 2. Camera-status light**  
Turns on when the camera is in use.

## Bottom

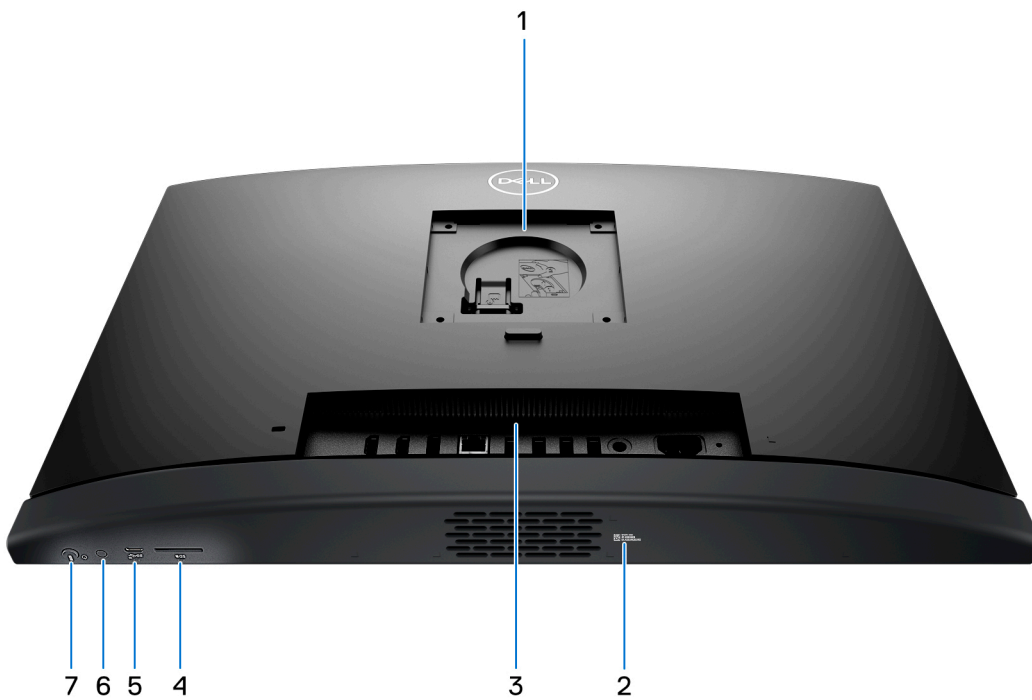

- 1. Stand/VESA mount location**  
Allows for the installation of a 100 mm x 100 mm screw pitch VESA connection for use in standard environmental conditions, or one of the stands offered by Dell for your OptiPlex All-in-One 7410 .

## 2. Service Tag label

The Service Tag is a unique alphanumeric identifier that enables Dell service technicians to identify the hardware components in your computer and access warranty information.

## 3. Back panel

Connect USB, audio, video, and other devices.

## 4. SD-card slot

Reads from and writes to the SD card.

## 5. USB 3.2 Gen 2 Type C port

Connect devices such as external storage devices and printers. Provides data transfer rate of up to 10 Gbps.

## 6. Display Built-in Self Test (BIST)/Display input button

Press and hold for your computer to enter a display Built-in Self Test (BIST).

**NOTE:** Press to switch display input to and from the device connected to the HDMI-in port on the back panel. This feature is only available on computers shipped with a High Performance processor.

## 7. Power button

Press to turn on the computer if it is turned off, in sleep state, or in hibernate state.

When the computer is turned on, press the power button to put the computer into sleep state; press and hold the power button for 10 seconds to force shut-down the computer.

**NOTE:** You can customize the power-button behavior in Windows.

# Back panel

**For computers with Energy Efficient processors:**

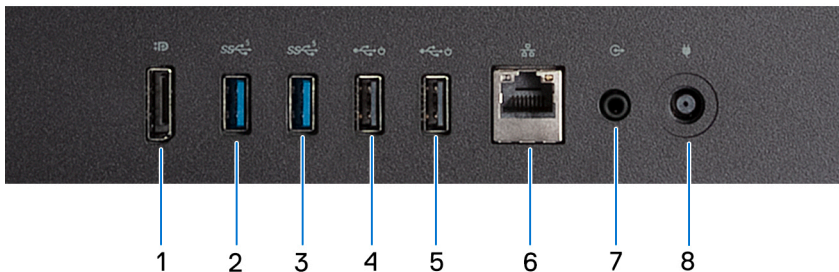

## 1. DisplayPort ++ 1.4a

Connect an external display or a projector. Can support video output of up to 5120 x 3200 at 60 Hz.

## 2. USB 3.2 Gen 1 port

Connect devices such as external storage devices and printers. Provides data transfer speeds up to 5 Gbps.

## 3. USB 3.2 Gen 1 port

Connect devices such as external storage devices and printers. Provides data transfer speeds up to 5 Gbps.

## 4. USB 2.0 port with Smart Power on

Connect devices such as external storage devices and printers. Provides data transfer speeds up to 480 Mbps.

**NOTE:** When USB wake is enabled in the BIOS the computer will power on or wake from hibernation when a USB mouse or keyboard that is connected to this port is used.

## 5. USB 2.0 port with Smart Power on

Connect devices such as external storage devices and printers. Provides data transfer speeds up to 480 Mbps.

**NOTE:** When USB wake is enabled in the BIOS the computer will power on or wake from hibernation when a USB mouse or keyboard that is connected to this port is used.

**6. Network port**

Connect an Ethernet (RJ45) cable from a router or a broadband modem for network or Internet access.

**7. Audio line-out port, retaskable**

Connect speakers.

**8. Power-adaptor port**

Connect a power adapter to provide power to your computer.

**For computers with High Performance processors:**

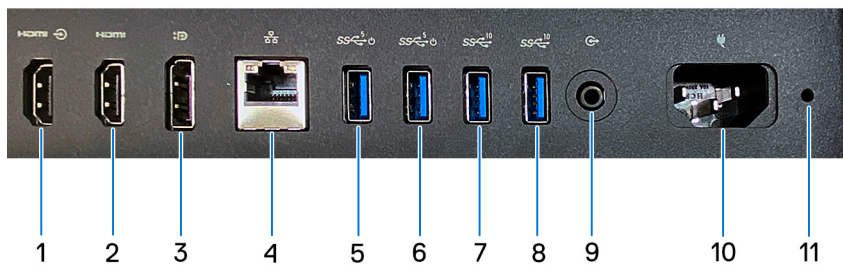

**1. HDMI-in 1.4b port**

Connect a gaming console, Blu-ray player, or other HDMI-out enabled device.

**2. HDMI-out 2.1 port**

Connect to a TV, external display or another HDMI-in enabled device. Provides video and audio output and supports video output of up to 4096 x 2160 at 60Hz.

**3. DisplayPort ++ 1.4a**

Connect an external display or a projector. Can support video output of up to 5120 x 3200 at 60 Hz.

**4. Network port**

Connect an Ethernet (RJ45) cable from a router or a broadband modem for network or Internet access.

**5. USB 3.2 Gen 1 port with Smart Power on**

Connect devices such as external storage devices and printers. Provides data transfer speeds up to 5 Gbps.

**NOTE:** When USB wake is enabled in the BIOS the computer will power on or wake from hibernation when a USB mouse or keyboard that is connected to this port is used.

**6. USB 3.2 Gen 1 port with Smart Power on**

Connect devices such as external storage devices and printers. Provides data transfer speeds up to 5 Gbps.

**NOTE:** When USB wake is enabled in the BIOS the computer will power on or wake from hibernation when a USB mouse or keyboard that is connected to this port is used.

**7. USB 3.2 Gen 2 port**

Connect devices such as external storage devices and printers. Provides data transfer speeds up to 10 Gbps.

**8. USB 3.2 Gen 2 port**

Connect devices such as external storage devices and printers. Provides data transfer speeds up to 10 Gbps.

**9. Audio line-out port, retaskable**

Connect an audio device.

**10. Power-cable connector**

Connect a power cable to provide power to your computer.

**11. Power-supply diagnostics light**

Indicates the power-supply state.

## Service Tag

The service tag is a unique alphanumeric identifier that allows Dell service technicians to identify the hardware components in your computer and access warranty information.



## Set up your computer

### Steps

1. Install the stand base on the stand.

**i** **NOTE:** Stand base installation for all stand configurations offered for your computer is exactly the same. Follow the procedure shown in the image to install the stand base on the stand.

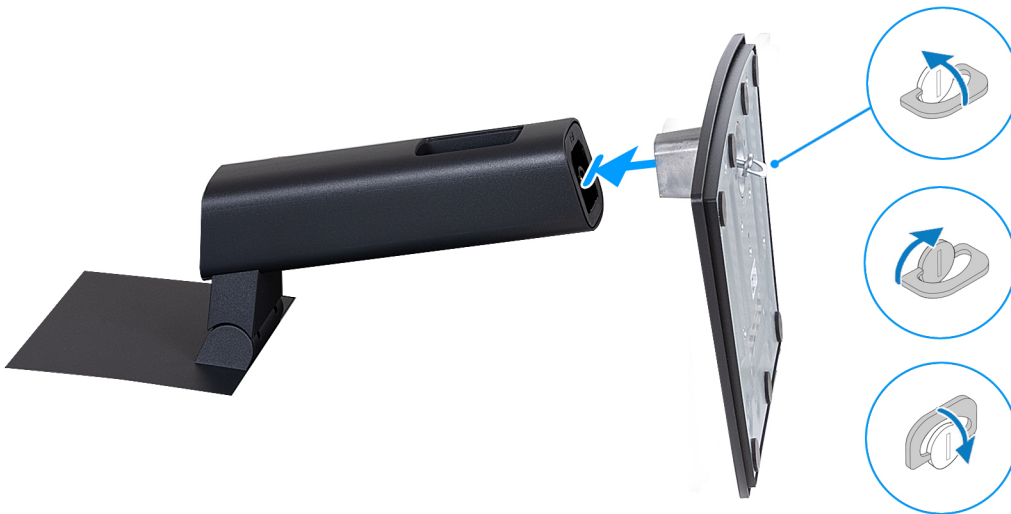

2. Set up the stand by inserting it into the slot on the back cover until it snaps into place.

**i** **NOTE:** Stand installation for all stand configurations offered for your computer is exactly the same. Follow the procedure shown in the image to install the stand on your computer.



3. Set up the keyboard and mouse.

**i** **NOTE:** For setup instructions, see the documentation shipped with the keyboard and mouse.

4. Connect the power-adapter cable or the power cable.

**i** **NOTE:** Depending on the configuration you have ordered your computer may have a power-adapter or a power supply. Refer to the appropriate image matching your computer for the procedure to connect the power-adapter cable or power cable.

#### Connecting the power-adapter cable



#### Connecting the power cable





5. Press the power button to turn on your computer.



6. Finish the operating system setup.

**For Ubuntu:**

Follow the on-screen instructions to complete the setup. For more information about installing and configuring Ubuntu, see the knowledge base articles [000131655](#) and [000131676](#) at [www.dell.com/support](http://www.dell.com/support).

**For Windows:**

Follow the on-screen instructions to complete the setup. When setting up, Dell recommends that you:





- Connect to a network for Windows updates.
  - **NOTE:** If connecting to a secured wireless network, enter the password for the wireless network access when prompted.
- If connected to the internet, sign-in with or create a Microsoft account. If not connected to the internet, create an offline account.
- On the **Support and Protection** screen, enter your contact details.

7. Locate and use Dell apps from the Windows Start menu—Recommended

**Table 1. Locate Dell apps**

Resources	Description
	<p><b>MyDell</b></p> <p>MyDell is a software application that offers you a single streamlined engagement platform including account access, device information, and hardware settings. This software delivers intelligent features that automatically fine-tune your computer for the best possible audio, power, and performance. Get the most out of your Dell device with intelligent, personalized technology from MyDell. Following are the key features of MyDell:</p>

**Table 1. Locate Dell apps (continued)**

Resources	Description
	<ul style="list-style-type: none"> <li>• Application</li> <li>• Audio</li> <li>• Power</li> <li>• Color and Display</li> <li>• Presence detection</li> </ul> <p>For more information about how to use MyDell, see product guides at <a href="http://www.dell.com/support">www.dell.com/support</a>.</p>
	<p><b>SupportAssist</b></p> <p>SupportAssist proactively and predictively identifies hardware and software issues on your computer and automates the engagement process with Dell Technical support. It addresses performance and stabilization issues, prevents security threats, monitors, and detects hardware failures. For more information, see <i>SupportAssist for Home PCs User's Guide</i> at <a href="http://www.dell.com/support/home/product-support/product/dell-supportassist-pcs-tablets/docs">www.dell.com/support/home/product-support/product/dell-supportassist-pcs-tablets/docs</a>.</p> <p> <b>NOTE:</b> In SupportAssist, click the warranty expiry date to renew or upgrade your warranty.</p>
	<p><b>Dell Update</b></p> <p>Updates your computer with critical fixes and latest device drivers as they become available. For more information about using Dell Update, see the product guides and third-party license documents at <a href="http://www.dell.com/support">www.dell.com/support</a>.</p>
	<p><b>Dell Digital Delivery</b></p> <p>Download software applications, which are purchased but not preinstalled on your computer. For more information about using Dell Digital Delivery, search in the Knowledge Base Resource at <a href="http://www.dell.com/support">www.dell.com/support</a>.</p>

# Specifications of OptiPlex All-in-One 7410

## Dimensions and weight

The following table lists the height, width, depth, and weight of your OptiPlex All-in-One 7410.

**Table 2. Dimensions and weight**

Description	Values
Height:	
Front height	354.30 mm (13.95 in.)
Rear height	354.30 mm (13.95 in.)
Width	540 mm (21.26 in.)
Depth	57.90 mm (2.28 in.)
Weight  <b>NOTE:</b> The weight of your computer depends on the configuration ordered and manufacturing variability.	<ul style="list-style-type: none"> <li>• Maximum: 6.32 kg (13.93 lb)</li> <li>• Minimum: 5.61 kg (12.37 lb)</li> </ul>

## Processor

The following table lists the details of the processors supported by your OptiPlex All-in-One 7410.

## High Performance processors

**Table 3. High Performance processors**

Description	Option one	Option two	Option three	Option four	Option five	Option six
Processor type	13th Generation Intel Core i3-13100	13th Generation Intel Core i5-13400	13th Generation Intel Core i5-13500, vPro	13th Generation Intel Core i5-13600, vPro	13th Generation Intel Core i7-13700, vPro	Pentium Gold G7400
Processor wattage	60 W	65 W	65 W	65 W	65 W	46 W
Processor total core count	4	10	14	14	16	2
Performance-cores	4	6	6	6	8	2
Efficient-cores	Not applicable	4	8	8	8	Not applicable
Processor total thread counts	8	16	20	20	24	4
 <b>NOTE:</b> Intel® Hyper-Threading Technology is only available on Performance-cores.						
Processor speed	Up to 4.5 GHz	Up to 4.6 GHz	Up to 4.8 GHz	Up to 5 GHz	Up to 5.2 GHz, Turbo Boost Max	3.7 GHz
Performance-cores frequency						
Processor base frequency	3.4 GHz	2.5 GHz	2.5 GHz	2.7 GHz	2.1 GHz	3.7 GHz
Maximum turbo frequency	4.5 GHz	4.6 GHz	4.8 GHz	5 GHz	5.1 GHz	Not applicable
Efficient-cores frequency						
Processor base frequency	Not applicable	1.8 GHz	1.8 GHz	2 GHz	1.5 GHz	Not applicable
Maximum turbo frequency	Not applicable	3.3 GHz	3.5 GHz	3.7 GHz	4.1 GHz	Not applicable
Processor cache	12 MB	20 MB	24 MB	24 MB	30 MB	6 MB
Integrated graphics	Intel UHD Graphics 730	Intel UHD Graphics 730	Intel UHD Graphics 770	Intel UHD Graphics 770	Intel UHD Graphics 770	Intel® UHD Graphics 710

## Energy Efficient processors

**Table 4. Energy Efficient processors**

Description	Option one	Option two	Option three	Option four	Option five	Option six
Processor type	13th Generation Intel Core i3-13100T	13th Generation Intel Core i5-13400T	13th Generation Intel Core i5-13500T, vPro	13th Generation Intel Core i5-13600T, vPro	Intel Pentium Gold G7400T	Intel Celeron G6900T
Processor wattage	35 W	35 W	35 W	35 W	35 W	35 W
Processor total core count	4	10	14	14	2	2
Performance-cores	4	6	6	6	2	2
Efficient-cores	Not applicable	4	8	8	Not applicable	Not applicable
Processor total thread counts	8	16	20	20	4	2
 <b>NOTE:</b> Intel® Hyper-Threading Technology is only available on Performance-cores.						
Processor speed	Up to 4.2 GHz	Up to 4.4 GHz	Up to 4.6 GHz	Up to 4.8 GHz	Up to 3.1 GHz	Up to 2.8 GHz
Performance-cores frequency						
Processor base frequency	2.5 GHz	1.3 GHz	1.6 GHz	1.8 GHz	3.1 GHz	2.8 GHz
Maximum turbo frequency	4.2 GHz	4.4 GHz	4.6 GHz	4.8 GHz	Not applicable	Not applicable
Efficient-cores frequency						
Processor base frequency	Not applicable	1 GHz	1.2 GHz	1.3 GHz	Not applicable	Not applicable
Maximum turbo frequency	Not applicable	3 GHz	3.2 GHz	3.4 GHz	Not applicable	Not applicable
Processor cache	12 MB	20 MB	24 MB	24 MB	6 MB	4 MB
Integrated graphics	Intel UHD Graphics 730	Intel UHD Graphics 730	Intel UHD Graphics 770	Intel UHD Graphics 770	Intel UHD Graphics 710	Intel UHD Graphics 710

## Chipset

The following table lists the details of the chipset supported by your OptiPlex All-in-One 7410.

**Table 5. Chipset**

Description	Values
Chipset	Q670
Processor	<ul style="list-style-type: none"> <li>13th Generation Intel Core i3T/i5T/i5T vPro</li> </ul>

**Table 5. Chipset (continued)**

Description	Values
	<ul style="list-style-type: none"><li>• 13th Generation Intel Core i3/i5/i5 vPro/i7 vPro</li><li>• Intel Pentium Gold</li><li>• Intel Celeron</li></ul>
DRAM bus width	64-bit
Flash EPROM	32 MB + 16 MB
PCIe bus	Up to Gen3

## Operating system

Your OptiPlex All-in-One 7410 supports the following operating systems:

- Windows 11 Home, 64-bit
- Windows 11 Pro, 64-bit
- Windows 11 Pro Downgrade (Windows 10 image)
- Windows 11 Pro National Education, 64-bit
- Windows 10 CMIT Government Edition (China only)
- Ubuntu Linux 22.04 LTS, 64-bit

For more information about Dell OS Recovery image, see *How to Download and Use the Dell OS Recovery Image in Microsoft Windows*, at [Dell support site](#).

### Commercial platform Windows 11 N-2 and 5-year operating system supportability:

All newly introduced 2019 and later commercial platforms (Latitude, OptiPlex, and Dell Precision) will qualify and ship with the most current factory installed Semi-Annual Channel Windows 11 version (N) and qualify (but not ship) the previous two versions (N-1, N-2). The OptiPlex All-in-One 7410 will RTS with Windows 11 version v20H2 at time of launch, and this version will determine the N-2 versions that are initially qualified for this platform.

For future versions of Windows 11, Dell continues to test the commercial platform with coming Windows 11 releases during device production and for five years post-production, including both fall and spring releases from Microsoft.

For additional information about N-2 and 5-year Windows operating system supportability, see the Dell Windows as a Service (WaaS), at [Dell support site](#).

### EOML 411

The OptiPlex All-in-One 7410 continues to test the coming Semi-Annual Channel Windows 11 version releases for five years post-production, including both fall and spring releases from Microsoft.

## Memory

The following table lists the memory specifications of your OptiPlex All-in-One 7410.

**Table 6. Memory specifications**

Description	Values
Memory slots	Two SoDIMM slots
Memory type	<ul style="list-style-type: none"><li>• DDR4 ,only for computers shipped with Energy Efficient processors</li><li>• DDR5, only for computers shipped with High Performance processors</li></ul>
Memory speed	<ul style="list-style-type: none"><li>• 3200 MHz, only for computers shipped with Energy Efficient processors</li></ul>

**Table 6. Memory specifications (continued)**

Description	Values
	<ul style="list-style-type: none"> <li>4800 MHz, only for computers shipped with High Performance processors</li> </ul>
Maximum memory configuration	64 GB
Minimum memory configuration	<ul style="list-style-type: none"> <li>4 GB, only for computers shipped with Energy Efficient processors</li> <li>8 GB, only for computers shipped with High Performance processors</li> </ul>
Memory size per slot	<p><b>For computers shipped with Energy Efficient processors:</b></p> <ul style="list-style-type: none"> <li>4 GB, 8 GB, 16 GB, or 32 GB</li> </ul> <p><b>For computers shipped with High Performance processors:</b></p> <ul style="list-style-type: none"> <li>8 GB, 16 GB, or 32 GB</li> </ul>
Memory configurations supported	<p><b>For computers shipped with Energy Efficient processors:</b></p> <ul style="list-style-type: none"> <li>4 GB, 1 x 4 GB, DDR4, 3200 MHz</li> <li>8 GB, 1 x 8 GB, DDR4, 3200 MHz</li> <li>16 GB, 1 x 16 GB, DDR4, 3200 MHz</li> <li>16 GB, 2 x 8 GB, DDR4, 3200 MHz, dual-channel</li> <li>32 GB, 1 x 32 GB, DDR4, 3200 MHz</li> <li>32 GB, 2 x 16 GB, DDR4, 3200 MHz, dual-channel</li> <li>64 GB, 2 x 32 GB, DDR4, 3200 MHz, dual-channel</li> </ul> <p><b>For computers shipped with High Performance processors:</b></p> <ul style="list-style-type: none"> <li>8 GB, 1 x 8 GB, DDR5, 4800 MHz</li> <li>16 GB, 1 x 16 GB, DDR5, 4800 MHz</li> <li>16 GB, 2 x 8 GB, DDR5, 4800 MHz, dual-channel</li> <li>32 GB, 1 x 32 GB, DDR5, 4800 MHz</li> <li>32 GB, 2 x 16 GB, DDR5, 4800 MHz, dual-channel</li> <li>64 GB, 2 x 32 GB, DDR5, 4800 MHz, dual-channel</li> </ul>

## External ports

The following table lists the external ports of your OptiPlex All-in-One 7410.

**Table 7. External ports**

Description	Values
Network port	One RJ45 Ethernet Port 10/100/1000 Mbps
USB ports	<p><b>For computers shipped with Energy Efficient processors:</b></p> <ul style="list-style-type: none"> <li>One USB 3.2 Gen 2 port with PowerShare</li> <li>One USB 3.2 Gen 2 Type-C port</li> <li>Two USB 3.2 Gen 1 ports</li> <li>Two USB 2.0 ports with Smart Power On</li> </ul> <p><b>For computers shipped with High Performance processors:</b></p> <ul style="list-style-type: none"> <li>One USB 3.2 Gen 2 port with PowerShare</li> </ul>



**Table 7. External ports (continued)**

Description	Values
	<ul style="list-style-type: none"> <li>One USB 3.2 Gen 2 Type-C port</li> <li>Two USB 3.2 Gen 2 ports</li> <li>Two USB 3.2 Gen 1 ports with Smart Power On</li> </ul>
Audio port	<ul style="list-style-type: none"> <li>One universal audio port</li> <li>One audio line-out port, retaskable</li> </ul>
Video port	<ul style="list-style-type: none"> <li>One DisplayPort++ 1.4a port</li> <li>One HDMI-in 1.4b, only for computers shipped with High Performance processors</li> <li>One HDMI-out 2.1, only for computers shipped with High Performance processors</li> </ul>
Media-card reader	One SD-card slot
Power-adaptor port	<ul style="list-style-type: none"> <li>One power-adaptor port, only for computers shipped with Energy Efficient processors</li> <li>One power-cable connector, only for computers shipped with High Performance processors</li> </ul>
Security-cable slot	One security-cable slot (wedge-shaped)

## Internal slots

The following table lists the internal slots of your OptiPlex All-in-One 7410.

**Table 8. Internal slots**

Description	Values
M.2	<p><b>For computers shipped with Energy Efficient processors:</b></p> <ul style="list-style-type: none"> <li>One M.2 2230 slot for WiFi and Bluetooth combo card</li> <li>One M.2 2230/2280 slot for solid-state drive</li> </ul> <p><b>For computers shipped with High Performance processors:</b></p> <ul style="list-style-type: none"> <li>One M.2 2230 slot for WiFi and Bluetooth combo card</li> <li>Two M.2 2230/2280 slots for solid-state drive</li> </ul> <p><b>NOTE:</b> To learn more about the features of different types of M.2 cards, search in the Knowledge Base Resource at <a href="http://www.dell.com/support">www.dell.com/support</a>.</p>
SATA	One SATA slot for 2.5-inch hard drive, only for computers shipped with Energy Efficient processors

## Ethernet

The following table lists the wired Ethernet Local Area Network (LAN) specifications of your OptiPlex All-in-One 7410.

**Table 9. Ethernet specifications**

Description	Values
Model number	Intel i219-LM

**Table 9. Ethernet specifications (continued)**

Description	Values
Transfer rate	10/100/1000 Mbps

## Wireless module

The following table lists the Wireless Local Area Network (WLAN) module specifications of your OptiPlex All-in-One 7410.

**Table 10. Wireless module specifications**

Description	Option one	Option two	Option three
Model number	AX201	Intel AX211	Realtek RTL8852BE
Transfer rate	Up to 2400 Mbps	Up to 2400 Mbps	Up to 1201 Mbps
Frequency bands supported	2.4 GHz/5 GHz	2.4 GHz/5 GHz/6 GHz	2.4 GHz/5 GHz
Wireless standards	<ul style="list-style-type: none"> <li>• Wi-Fi 802.11a/b/g</li> <li>• Wi-Fi 4 (WiFi 802.11n)</li> <li>• Wi-Fi 5 (WiFi 802.11ac)</li> <li>• Wi-Fi 6 (WiFi 802.11ax)</li> </ul>	<ul style="list-style-type: none"> <li>• Wi-Fi 802.11a/b/g</li> <li>• Wi-Fi 4 (WiFi 802.11n)</li> <li>• Wi-Fi 5 (WiFi 802.11ac)</li> <li>• Wi-Fi 6E (WiFi 802.11ax)</li> </ul>	<ul style="list-style-type: none"> <li>• Wi-Fi 802.11a/b/g</li> <li>• Wi-Fi 4 (WiFi 802.11n)</li> <li>• Wi-Fi 5 (WiFi 802.11ac)</li> <li>• Wi-Fi 6 (WiFi 802.11ax)</li> </ul>
Encryption	<ul style="list-style-type: none"> <li>• 64-bit/128-bit WEP</li> <li>• AES-CCMP</li> <li>• TKIP</li> </ul>	<ul style="list-style-type: none"> <li>• 64-bit/128-bit WEP</li> <li>• AES-CCMP</li> <li>• TKIP</li> </ul>	<ul style="list-style-type: none"> <li>• 64-bit/128-bit WEP</li> <li>• AES-CCMP</li> <li>• TKIP</li> </ul>
Bluetooth	Bluetooth wireless card	Bluetooth wireless card	Bluetooth wireless card

## Audio

The following table lists the audio specifications of your OptiPlex All-in-One 7410.

**Table 11. Audio specifications**

Description	Values
Audio controller	<ul style="list-style-type: none"> <li>• Realtek ALC3246, only for computers shipped with Energy Efficient processors</li> <li>• Realtek ALC3289, only for computers shipped with High Performance processors</li> </ul>
Stereo conversion	Supported
Internal audio interface	High-definition audio interface
External audio interface	<ul style="list-style-type: none"> <li>• One universal audio port</li> <li>• One audio line-out port, retaskable</li> </ul>
Number of speakers	Two stereo speakers
Internal-speaker amplifier	<ul style="list-style-type: none"> <li>• Supported for computers shipped with Energy Efficient processors</li> <li>• Realtek Amplifier ALC1302, only for computers shipped with High Performance processors</li> </ul>
External volume controls	Not supported

**Table 11. Audio specifications (continued)**

Description		Values
Speaker output:		
	Average speaker output	2 W
	Peak speaker output	2.5 W
Subwoofer output		Not supported
Microphone		Two microphones in the retractable-camera assembly

## Storage

This section lists the storage options on your OptiPlex All-in-One 7410.

Your OptiPlex All-in-One 7410 supports one of the following storage configurations:

- One M.2 2230/2280 solid-state drive
- One M.2 2230/2280 solid-state drives + one 2.5-inch hard-disk drive, only for computers shipped with Energy Efficient processors
- One 2.5-inch hard-drive, only for computers shipped with Energy Efficient processors
- Two M.2 2230/2280 solid-state drives, only for computers shipped with High Performance processors

The primary drive of your OptiPlex All-in-One 7410 varies with the storage configuration. For computers:

- with an M.2 drive, the M.2 drive is the primary drive
- without an M.2 drive, the 2.5-inch hard drive is the primary drive

**Table 12. Storage specifications**

Storage type	Interface type	Capacity
2.5-inch hard-disk drive <b>i</b> <b>NOTE:</b> Only available on computers shipped with Energy Efficient processors.	SATA AHCI, up to 6 Gbps	Up to 1 TB
M.2 2230 solid-state drive, Class 35	PCIe Gen3 x4 NVMe, up to 64 Gbps	Up to 1 TB
M.2 2280 solid-state drive, Class 40	PCIe Gen3 x4 NVMe, up to 64 Gbps	Up to 2 TB
M.2 2230 solid-state drive, self-encrypting, Class 35	PCIe Gen3 x4 NVMe, up to 64 Gbps	Up to 256 GB
M.2 2280 solid-state drive, self-encrypting, Class 40	PCIe Gen3 x4 NVMe, up to 64 Gbps	Up to 1 TB

## Media-card reader

The following table lists the media cards supported by your OptiPlex All-in-One 7410.

**Table 13. Media-card reader specifications**

Description	Values
Media-card type	One SD-card slot
Media-cards supported	<ul style="list-style-type: none"> <li>• Secure Digital (SD)</li> <li>• Secure Digital High Capacity (SDHC)</li> </ul>

**Table 13. Media-card reader specifications (continued)**

Description	Values
	<ul style="list-style-type: none"><li>Secure Digital Extended Capacity (SDXC)</li></ul>
<b>i</b> <b>NOTE:</b> The maximum capacity supported by the media-card reader varies depending on the standard of the media card installed in your computer.	

## Camera

The following table lists the camera specifications of your OptiPlex All-in-One 7410.

**Table 14. Camera specifications**

Description	Values
Number of cameras	One
Camera type	FHD RGB camera
Camera location	Retractable camera
Camera sensor type	CMOS sensor technology
Camera resolution:	
Still image	2.07 megapixel
Video	1920 x 1080 (FHD) at 30 fps
Diagonal viewing angle:	82 degrees

## Power

The following table lists the power adapter specifications of your OptiPlex All-in-One 7410.

### Power adapter

**i** **NOTE:** The power adapter specification is only applicable to computers shipped with Energy Efficient processors.

**Table 15. Power adapter specifications**

Description	Option one	Option two
Type	130 W AC adapter	180 W AC adapter
Connector dimensions:		
External diameter	7.40 mm	7.40 mm
Internal diameter	5.10 mm	5.10 mm
Power-adapter dimensions:		
Height	154.70 mm (6.09 in.)	155 mm (6.10 in.)
Width	76.20 mm (3 in.)	76.20 mm (3 in.)

**Table 15. Power adapter specifications (continued)**

Description		Option one	Option two
	Depth	25.4 mm (1 in.)	30 mm (1.18 in.)
	Input voltage	100 VAC–240 VAC	100 VAC–240 VAC
	Input frequency	50 Hz–60 Hz	50 Hz–60 Hz
	Input current (maximum)	2.50 A	2.34 A
	Output current (continuous)	6.70 A	9.23 A
	Rated output voltage	19.50 VDC	19.50 VDC
Temperature range:			
	Operating	0°C to 40°C (32°F to 104°F)	0°C to 40°C (32°F to 104°F)
	Storage	-40°C to 70°C (-40°F to 158°F)	-40°C to 70°C (-40°F to 158°F)
<p><b>⚠ CAUTION:</b> Operating and storage temperature ranges may differ among components, so operating or storing the device outside these ranges may impact the performance of specific components.</p>			

## Power-supply unit

**i** **NOTE:** The power rating specification is only applicable to computers shipped with High Performance processors.

**Table 16. Power rating**

Description		Values
	Type	160 W internal power supply unit (PSU), 80 Plus Bronze
	Input voltage	90 VAC–264 VAC
	Input frequency	47 Hz–63 Hz
	Input current (maximum)	2.80 A
	Output current (continuous)	Operating: <ul style="list-style-type: none"> <li>● 19.50 VA: 7 A</li> <li>● 19.50 VB: 5 A</li> </ul> Standby: <ul style="list-style-type: none"> <li>● 19.50 VA: 0.50 A</li> <li>● 19.50 VB: 1.75 A</li> </ul>
	Rated output voltage	<ul style="list-style-type: none"> <li>● 19.50 VA</li> <li>● 19.50 VB</li> </ul>
Temperature range:		
	Operating	5°C to 42°C (41°F to 107.6°F)
	Storage	-40°C to 70°C (-40°F to 158°F)

# Power supply connector

The following table lists the Power supply connector specifications of your OptiPlex All-in-One 7410.

**Table 17. Power supply connector**

160 W internal power supply unit (PSU), 80 Plus Bronze	<ul style="list-style-type: none"> <li>• One 8-pin connector for processor</li> <li>• One 6-pin connector for system board</li> <li>• One 6-pin connector for control signal</li> <li>• One 2-pin connector for LED</li> </ul>
--	--

# Display

The following table lists the display specifications of your OptiPlex All-in-One 7410.

**Table 18. Display specifications**

Description	Option one	Option two
Display type	Full High Definition (FHD), ComfortView Plus	Full High Definition (FHD), ComfortView Plus
Touch options	No	Touch support, with 10 touch points
Display-panel technology	In-Plane Switching (IPS)	In-Plane Switching (IPS)
Display-panel dimensions (active area):		
Height	296.46 mm (11.67 in.)	296.46 mm (11.67 in.)
Width	527.04 mm (20.75 in.)	527.04 mm (20.75 in.)
Diagonal	604.70 mm (23.81 in.)	604.70 mm (23.81 in.)
Display-panel native resolution	1920 x 1080	1920 x 1080
Luminance (typical)	250 nits	300 nits
Megapixels	2.07	2.07
Color gamut	99% (sRGB)	99% (sRGB)
Pixels Per Inch (PPI)	92	92
Contrast ratio (min.)	<ul style="list-style-type: none"> <li>• 700:1, minimum</li> <li>• 1000:1, typical</li> </ul>	<ul style="list-style-type: none"> <li>• 700:1, minimum</li> <li>• 1000:1, typical</li> </ul>
Response time (max.)	<ul style="list-style-type: none"> <li>• 25 ms, minimum</li> <li>• 14 ms, typical</li> </ul>	<ul style="list-style-type: none"> <li>• 20 ms, minimum</li> <li>• 14 ms, typical</li> </ul>
Refresh rate	60 Hz	60 Hz
Horizontal view angle	<ul style="list-style-type: none"> <li>• +/- 85 degrees, minimum</li> <li>• +/- 89 degrees, typical</li> </ul>	<ul style="list-style-type: none"> <li>• +/- 85 degrees, minimum</li> <li>• +/- 89 degrees, typical</li> </ul>
Vertical view angle	<ul style="list-style-type: none"> <li>• +/- 85 degrees, minimum</li> <li>• +/- 89 degrees, typical</li> </ul>	<ul style="list-style-type: none"> <li>• +/- 85 degrees, minimum</li> <li>• +/- 89 degrees, typical</li> </ul>
Pixel pitch	0.27 mm	0.27 mm

**Table 18. Display specifications (continued)**

Description	Option one	Option two
Power consumption (maximum)	14.11 W	17.26 W
Anti-glare vs glossy finish	Anti-glare	Anti-glare

## GPU—Integrated

The following table lists the specifications of the integrated Graphics Processing Unit (GPU) supported by your OptiPlex All-in-One 7410.

**Table 19. GPU—Integrated**

Controller	External display support	Memory size	Processor
Intel UHD Graphics 710	<ul style="list-style-type: none"> <li>One DisplayPort++ 1.4a port (5120 x 3200 at 60 Hz)</li> <li>One HDMI-out 2.1 port (4096 x 2160 at 60 Hz), only for computers shipped with High Performance processors</li> </ul>	Shared system memory	<ul style="list-style-type: none"> <li>Intel Pentium Gold</li> <li>Intel Celeron</li> </ul>
Intel UHD Graphics 730	<ul style="list-style-type: none"> <li>One DisplayPort++ 1.4a port (5120 x 3200 at 60 Hz)</li> <li>One HDMI-out 2.1 port (4096 x 2160 at 60 Hz), only for computers shipped with High Performance processors</li> </ul>	Shared system memory	13th Generation Intel Core i3/i3T/i5/i5T
Intel UHD Graphics 770	<ul style="list-style-type: none"> <li>One DisplayPort++ 1.4a port (5120 x 3200 at 60 Hz)</li> <li>One HDMI-out 2.1 port (4096 x 2160 at 60 Hz), only for computers shipped with High Performance processors</li> </ul>	Shared system memory	13th Generation Intel Core i5 vPro/i5T vPro/i7 vPro

## Hardware security

The following table lists the hardware security of your OptiPlex All-in-One 7410.

**Table 20. Hardware security**

Hardware security
Kensington security-cable slot
Chassis intrusion switch
Trusted Platform Module (Discrete TPM Enabled)
SafeBIOS including Dell Off-host BIOS Verification
BIOS Resilience

**Table 20. Hardware security (continued)**

<b>Hardware security</b>
BIOS Recovery, and additional BIOS Controls
SafelD including Trusted Platform Module (TPM) 2.0
Self-Encrypting Drives (SED)
D-Pedigree (Secure Supply Chain Functionality)

## Environmental

The following table lists the environmental specifications of your OptiPlex All-in-One 7410.

**Table 21. Environmental**

Feature	Values
Recyclable packaging	Yes
BFR/PVC—free chassis	Yes
Vertical orientation packaging support	Yes
Multi-Pack packaging	No
Energy-Efficient Power Supply	Yes
ENV0424 compliant	Yes

**i NOTE:** Wood-based fiber packaging contains a minimum of 35% recycled content by total weight of wood-based fiber. Packaging that contains without wood-based fiber can be claimed as Not Applicable. The anticipated required criteria for EPEAT 2018.

## Operating and storage environment

This table lists the operating and storage specifications of your OptiPlex All-in-One 7410.

**Airborne contaminant level:** G1 as defined by ISA-S71.04-1985

**Table 22. Computer environment**

Description	Operating	Storage
Temperature range	0°C to 35°C (32°F to 95°F)	-40°C to 65°C (-40°F to 149°F)
Relative humidity (maximum)	10% to 90% (non-condensing)	0% to 95% (non-condensing)
Vibration (maximum)*	0.26 GRMS	1.30 GRMS
Shock (maximum)	40 G†	160 G†
Altitude range	-15.2 m to 3048 m (-49.87 ft to 10000 ft)	-15.2 m to 10668 m (-49.87 ft to 35000 ft)
<b>⚠ CAUTION: Operating and storage temperature ranges may differ among components, so operating or storing the device outside these ranges may impact the performance of specific components.</b>		

\* Measured using a random vibration spectrum that simulates user environment.











† Measured using a 2 ms half-sine pulse.



# Working inside your computer

## Safety instructions

Use the following safety guidelines to protect your computer from potential damage and to ensure your personal safety. Unless otherwise noted, each procedure included in this document assumes that you have read the safety information that shipped with your computer.

-  **WARNING:** Before working inside your computer, read the safety information that is shipped with your computer. For more safety best practices, see the Regulatory Compliance home page at [www.dell.com/regulatory\\_compliance](http://www.dell.com/regulatory_compliance).
-  **WARNING:** Disconnect your computer from all power sources before opening the computer cover or panels. After you finish working inside the computer, replace all covers, panels, and screws before connecting your computer to an electrical outlet.
-  **CAUTION:** To avoid damaging the computer, ensure that the work surface is flat, dry, and clean.
-  **CAUTION:** To avoid damaging the components and cards, handle them by their edges, and avoid touching the pins and the contacts.
-  **CAUTION:** You should only perform troubleshooting and repairs as authorized or directed by the Dell technical assistance team. Damage due to servicing that is not authorized by Dell is not covered by your warranty. See the safety instructions that is shipped with the product or at [www.dell.com/regulatory\\_compliance](http://www.dell.com/regulatory_compliance).
-  **CAUTION:** Before touching anything inside your computer, ground yourself by touching an unpainted metal surface, such as the metal at the back of the computer. While you work, periodically touch an unpainted metal surface to dissipate static electricity which could harm internal components.
-  **CAUTION:** When you disconnect a cable, pull it by its connector or its pull tab, not the cable itself. Some cables have connectors with locking tabs or thumbscrews that you must disengage before disconnecting the cable. When disconnecting cables, keep them evenly aligned to avoid bending the connector pins. When connecting cables, ensure that the ports and the connectors are correctly oriented and aligned.
-  **CAUTION:** Press and eject any installed card from the media-card reader.
-  **CAUTION:** Exercise caution when handling Lithium-ion batteries in laptops. Swollen batteries should not be used and should be replaced and disposed properly.
-  **NOTE:** The color of your computer and certain components may appear differently than shown in this document.

## Before working inside your computer

### About this task

-  **NOTE:** The images in this document may differ from your computer depending on the configuration you ordered.

### Steps

1. Save and close all open files and exit all open applications.
2. Shut down your computer. For Windows operating system, click **Start** >  **Power** > **Shut down**.

 **NOTE:** If you are using a different operating system, see the documentation of your operating system for shut-down instructions.

3. Disconnect your computer and all attached devices from their electrical outlets.
4. Disconnect all attached network devices and peripherals, such as keyboard, mouse, and monitor from your computer.

 **CAUTION:** To disconnect a network cable, first unplug the cable from your computer and then unplug the cable from the network device.

5. Remove any media card and optical disc from your computer, if applicable.

## Safety precautions

The safety precautions chapter details the primary steps to be taken before performing any disassembly instructions.

Observe the following safety precautions before you perform any installation or break/fix procedures involving disassembly or reassembly:

- Turn off the system and all attached peripherals.
- Disconnect the system and all attached peripherals from AC power.
- Disconnect all network cables, telephone, and telecommunications lines from the system.
- Use an ESD field service kit when working inside any desktop to avoid electrostatic discharge (ESD) damage.
- After removing any system component, carefully place the removed component on an anti-static mat.
- Wear shoes with non-conductive rubber soles to reduce the chance of getting electrocuted.

## Standby power

Dell products with standby power must be unplugged before you open the case. Systems that incorporate standby power are essentially powered while turned off. The internal power enables the system to be remotely turned on (wake on LAN) and suspended into a sleep mode and has other advanced power management features.

Unplugging, pressing, and holding the power button for 15 seconds should discharge residual power in the system board.

## Bonding

Bonding is a method for connecting two or more grounding conductors to the same electrical potential. This is done through the use of a field service electrostatic discharge (ESD) kit. When connecting a bonding wire, ensure that it is connected to bare metal and never to a painted or non-metal surface. The wrist strap should be secure and in full contact with your skin, and ensure that you remove all jewelry such as watches, bracelets, or rings prior to bonding yourself and the equipment.

## Electrostatic discharge—ESD protection

ESD is a major concern when you handle electronic components, especially sensitive components such as expansion cards, processors, memory DIMMs, and system boards. Very slight charges can damage circuits in ways that may not be obvious, such as intermittent problems or a shortened product life span. As the industry pushes for lower power requirements and increased density, ESD protection is an increasing concern.

Due to the increased density of semiconductors used in recent Dell products, the sensitivity to static damage is now higher than in previous Dell products. For this reason, some previously approved methods of handling parts are no longer applicable.

Two recognized types of ESD damage are catastrophic and intermittent failures.

- **Catastrophic** – Catastrophic failures represent approximately 20 percent of ESD-related failures. The damage causes an immediate and complete loss of device functionality. An example of catastrophic failure is a memory DIMM that has received a static shock and immediately generates a "No POST/No Video" symptom with a beep code emitted for missing or nonfunctional memory.
- **Intermittent** – Intermittent failures represent approximately 80 percent of ESD-related failures. The high rate of intermittent failures means that most of the time when damage occurs, it is not immediately recognizable. The DIMM receives a static shock, but the tracing is merely weakened and does not immediately produce outward symptoms related to the damage. The weakened trace may take weeks or months to melt, and in the meantime may cause degradation of memory integrity, intermittent memory errors, etc.

The more difficult type of damage to recognize and troubleshoot is the intermittent (also called latent or "walking wounded") failure.

Perform the following steps to prevent ESD damage:

- Use a wired ESD wrist strap that is properly grounded. The use of wireless anti-static straps is no longer allowed; they do not provide adequate protection. Touching the chassis before handling parts does not ensure adequate ESD protection on parts with increased sensitivity to ESD damage.
- Handle all static-sensitive components in a static-safe area. If possible, use anti-static floor pads and workbench pads.
- When unpacking a static-sensitive component from its shipping carton, do not remove the component from the anti-static packing material until you are ready to install the component. Before unwrapping the anti-static packaging, ensure that you discharge static electricity from your body.
- Before transporting a static-sensitive component, place it in an anti-static container or packaging.

## ESD field service kit

The unmonitored Field Service kit is the most commonly used service kit. Each Field Service kit includes three main components: anti-static mat, wrist strap, and bonding wire.

### Components of an ESD field service kit

The components of an ESD field service kit are:

- **Anti-Static Mat** – The anti-static mat is dissipative and parts can be placed on it during service procedures. When using an anti-static mat, your wrist strap should be snug and the bonding wire should be connected to the mat and to any bare metal on the system being worked on. Once deployed properly, service parts can be removed from the ESD bag and placed directly on the mat. ESD-sensitive items are safe in your hand, on the ESD mat, in the system, or inside a bag.
- **Wrist Strap and Bonding Wire** – The wrist strap and bonding wire can be either directly connected between your wrist and bare metal on the hardware if the ESD mat is not required, or connected to the anti-static mat to protect hardware that is temporarily placed on the mat. The physical connection of the wrist strap and bonding wire between your skin, the ESD mat, and the hardware is known as bonding. Use only Field Service kits with a wrist strap, mat, and bonding wire. Never use wireless wrist straps. Always be aware that the internal wires of a wrist strap are prone to damage from normal wear and tear, and must be checked regularly with a wrist strap tester in order to avoid accidental ESD hardware damage. It is recommended to test the wrist strap and bonding wire at least once per week.
- **ESD Wrist Strap Tester** – The wires inside of an ESD strap are prone to damage over time. When using an unmonitored kit, it is a best practice to regularly test the strap prior to each service call, and at a minimum, test once per week. A wrist strap tester is the best method for doing this test. If you do not have your own wrist strap tester, check with your regional office to find out if they have one. To perform the test, plug the wrist-strap's bonding-wire into the tester while it is strapped to your wrist and push the button to test. A green LED is lit if the test is successful; a red LED is lit and an alarm sounds if the test fails.
- **Insulator Elements** – It is critical to keep ESD sensitive devices, such as plastic heat sink casings, away from internal parts that are insulators and often highly charged.
- **Working Environment** – Before deploying the ESD Field Service kit, assess the situation at the customer location. For example, deploying the kit for a server environment is different than for a desktop or portable environment. Servers are typically installed in a rack within a data center; desktops or portables are typically placed on office desks or cubicles. Always look for a large open flat work area that is free of clutter and large enough to deploy the ESD kit with additional space to accommodate the type of system that is being repaired. The workspace should also be free of insulators that can cause an ESD event. On the work area, insulators such as Styrofoam and other plastics should always be moved at least 12 inches or 30 centimeters away from sensitive parts before physically handling any hardware components
- **ESD Packaging** – All ESD-sensitive devices must be shipped and received in static-safe packaging. Metal, static-shielded bags are preferred. However, you should always return the damaged part using the same ESD bag and packaging that the new part arrived in. The ESD bag should be folded over and taped shut and all the same foam packing material should be used in the original box that the new part arrived in. ESD-sensitive devices should be removed from packaging only at an ESD-protected work surface, and parts should never be placed on top of the ESD bag because only the inside of the bag is shielded. Always place parts in your hand, on the ESD mat, in the system, or inside an anti-static bag.
- **Transporting Sensitive Components** – When transporting ESD sensitive components such as replacement parts or parts to be returned to Dell, it is critical to place these parts in anti-static bags for safe transport.

## ESD protection summary

It is recommended to use the traditional wired ESD grounding wrist strap and protective anti-static mat at all times when servicing Dell products. In addition, it is critical to keep sensitive parts separate from all insulator parts while performing service and that they use anti-static bags for transporting sensitive components.

## Transporting sensitive components

When transporting ESD sensitive components such as replacement parts or parts to be returned to Dell, it is critical to place these parts in anti-static bags for safe transport.

## Lifting equipment

Adhere to the following guidelines when lifting heavy weight equipment:

 **CAUTION: Do not lift greater than 50 pounds. Always obtain additional resources or use a mechanical lifting device.**

1. Get a firm balanced footing. Keep your feet apart for a stable base, and point your toes out.
2. Tighten stomach muscles. Abdominal muscles support your spine when you lift, offsetting the force of the load.
3. Lift with your legs, not your back.
4. Keep the load close. The closer it is to your spine, the less force it exerts on your back.
5. Keep your back upright, whether lifting or setting down the load. Do not add the weight of your body to the load. Avoid twisting your body and back.
6. Follow the same techniques in reverse to set the load down.

## After working inside your computer

### About this task

 **NOTE:** Leaving stray or loose screws inside your computer may severely damage your computer.

### Steps

1. Replace all screws and ensure that no stray screws remain inside your computer.
2. Connect any external devices, peripherals, or cables you removed before working on your computer.
3. Replace any media cards, discs, or any other parts that you removed before working on your computer.
4. Connect your computer and all attached devices to their electrical outlets.
5. Turn on your computer.

## BitLocker

 **CAUTION: If BitLocker is not suspended before updating the BIOS, the next time you reboot the system it will not recognize the BitLocker key. You will then be prompted to enter the recovery key to progress, and the system will ask for this on each reboot. If the recovery key is not known this can result in data loss or an unnecessary operating system reinstall. For more information about this subject, see Knowledge Article: [updating the BIOS on Dell systems with BitLocker enabled.](#)**

The installation of the following components triggers BitLocker:

- Hard disk drive or solid state drive
- System board

## Recommended tools

The procedures in this document may require the following tools:

- Phillips screwdriver #1
- Plastic scribe

## Screw list

**NOTE:** When removing screws from a component, it is recommended to note the screw type, the quantity of screws, and then place them in a screw storage box. This is to ensure that the correct number of screws and correct screw type is restored when the component is replaced.

**NOTE:** Some computers have magnetic surfaces. Ensure that the screws are not left attached to such surfaces when replacing a component.

**NOTE:** Screw color may vary with the configuration ordered.

**NOTE:** This screw list information is for computers shipped with a High Performance processor.

**Table 23. Screw list for computers with High Performance processors**

Component	Screw type	Quantity
System-board shield	M3x5	6
Wireless card	M2x3.5	1
M.2 2230/2280 solid-state drive in M.2 slot 0	M2x3.5	1
M.2 2230/2280 solid-state drive in M.2 slot 1	M2x3.5	1
I/O cover	M3x5	2
Bottom cover	M3x5	3
Retractable-camera assembly	M3x5	4
Fan	M3x5	3
I/O bracket	M3x5	2
Heat sink	Captive	5
Power-supply unit	M3x5	3
Power-supply connector cable bracket	M3x5	2
Power-supply fan	M3x5	2
System board	M3x5	7
	M3x12	1
Power-button and I/O board shield	M3x5	3
Power-button and I/O board	M3x5	2
Audio board shield	M3x5	3
Audio board	M3x5	2

**NOTE:** This screw list information is for computers shipped with a Energy Efficient processor.

**Table 24. Screw list for computers with Energy Efficient Processors**

Component	Screw type	Quantity
System-board shield	M3x5	6
Wireless card	M2x3.5	1
Hard-drive bracket	M3x5	1

**Table 24. Screw list for computers with Energy Efficient Processors (continued)**

<b>Component</b>	<b>Screw type</b>	<b>Quantity</b>
Hard drive	M3x3.5	4
M.2 2230/2280 solid-state drive	M2x3.5	1
I/O cover	M3x5	2
Bottom cover	M3x5	3
Retractable-camera assembly	M3x5	4
Fan	M3x5	3
I/O bracket	M3x5	3
Heat sink	Captive	5
System board	M3x5	7
	M3x12	1
Power-button and I/O board shield	M3x5	3
Power-button and I/O board	M3x5	2
Audio board shield	M3x5	3
Audio board	M3x5	2

## Major components of OptiPlex All-in-One 7410

The following image shows the major components of OptiPlex All-in-One 7410.

 **NOTE:** This is the major components for computers shipped with a High Performance processor.

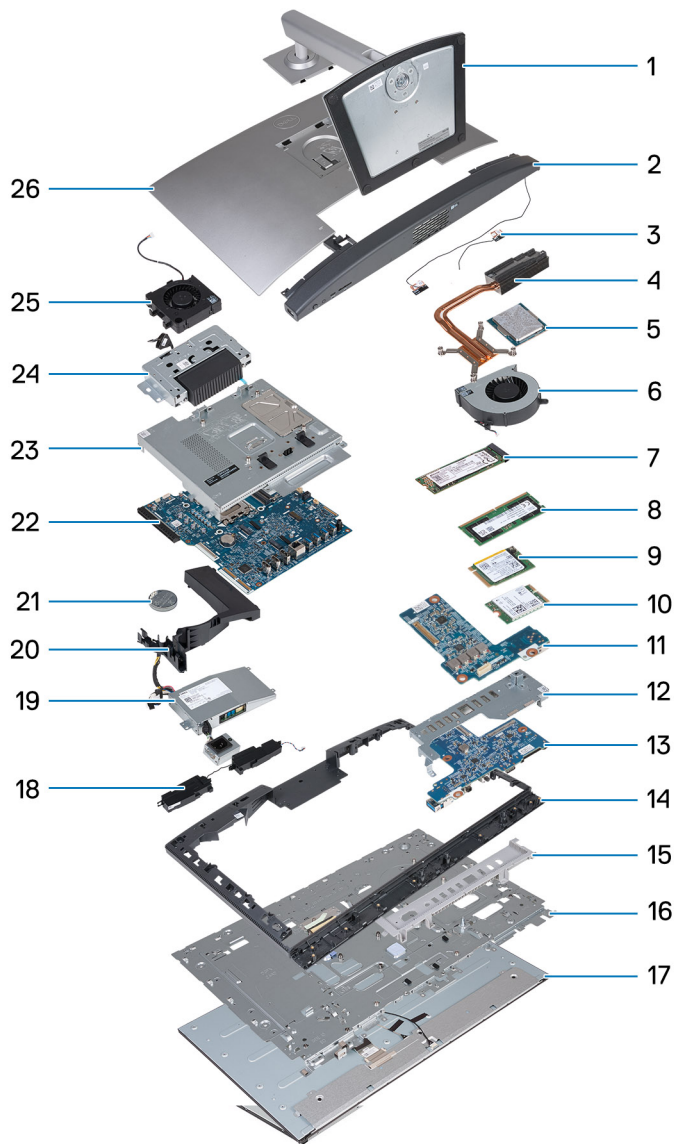

- |                                |                                 |
|--------------------------------|---------------------------------|
| 1. Stand                       | 2. Bottom cover                 |
| 3. Antenna modules             | 4. Heat sink                    |
| 5. Processor                   | 6. Fan                          |
| 7. M.2 2280 solid-state drive  | 8. Memory module                |
| 9. M.2 2230 solid-state drive  | 10. Wireless card               |
| 11. Audio board                | 12. I/O bracket                 |
| 13. Power-button and I/O board | 14. Middle frame                |
| 15. I/O cover                  | 16. Display base                |
| 17. Display panel              | 18. Speakers                    |
| 19. Power-supply unit (PSU)    | 20. Fan shroud                  |
| 21. Coin-cell battery          | 22. System board                |
| 23. System-board shield        | 24. Retractable-camera assembly |
| 25. Power-supply fan           | 26. Back cover                  |

**i** NOTE: This is the major components for computers shipped with a Energy Efficient processor.

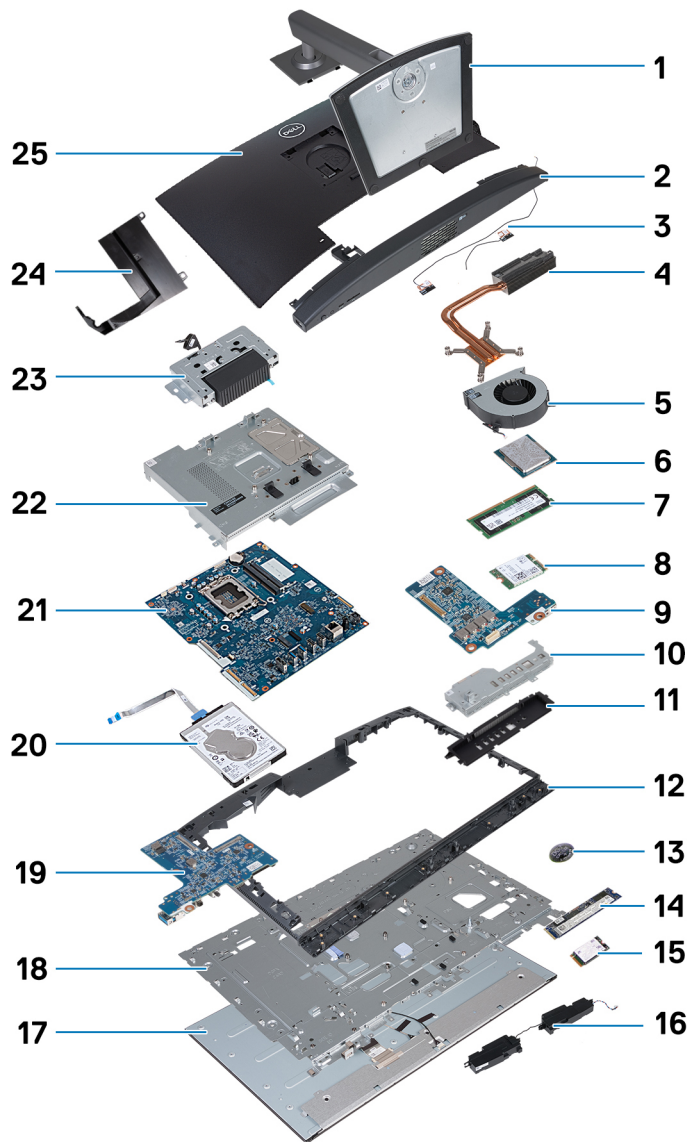

- |                                 |                                |
|---------------------------------|--------------------------------|
| 1. Stand                        | 2. Bottom cover                |
| 3. Antenna modules              | 4. Heat sink                   |
| 5. Fan                          | 6. Processor                   |
| 7. Memory module                | 8. Wireless card               |
| 9. Audio board                  | 10. I/O bracket                |
| 11. I/O cover                   | 12. Middle frame               |
| 13. Coin-cell battery           | 14. M.2 2280 solid-state drive |
| 15. M.2 2230 solid-state drive  | 16. Speakers                   |
| 17. Display panel               | 18. Display base               |
| 19. Power-button and I/O board  | 20. Hard drive                 |
| 21. System board                | 22. System-board shield        |
| 23. Retractable-camera assembly | 24. Fan shroud                 |
| 25. Back cover                  |                                |

**i NOTE:** Dell provides a list of components and their part numbers for the original system configuration purchased. These parts are available according to warranty coverages purchased by the customer. Contact your Dell sales representative for purchase options.



# High Performance and Energy Efficient

The removal and installation procedures of your OptiPlex All-in-One 7410 differ based on the configuration ordered.

To determine the procedure to removal and install components on your OptiPlex All-in-One 7410 refer to the following descriptions to identify the configuration of your computer:

- **High Performance:** Computers shipped with 46 W, 60 W or 65 W processors and a power-supply unit. Refer to [Removal and installation procedures for High Performance processors](#).
- **Energy Efficient:** Computers shipped with 35 W processors and a power adapter. Refer to [Removal and installation procedures for Energy Efficient processors](#).

# Removal and installation procedures for High Performance processors

The service procedures for replaceable components listed in this chapters are for computers shipped with High Performance processors.

## Removing and installing Customer Replaceable Units (CRUs)

The replaceable components in this chapter are Customer Replaceable Units (CRUs).

**CAUTION:** Customers can replace only the Customer Replaceable Units (CRUs) following the safety precautions and replacement procedures.

**NOTE:** The images in this document may differ from your computer depending on the configuration you ordered.

### Stand

#### Removing the stand

##### Prerequisites

1. Follow the procedure in [Before working inside your computer](#).

##### About this task

**NOTE:** Depending on the stand installed on your computer, refer to the corresponding image shown in the procedure.

The following image(s) indicate the location of the stand and provides a visual representation of the removal procedure.



### Steps

1. Place the display-assembly base on a clean and flat surface.
2. Press and hold down on the tab that secures the stand to the display-assembly base.
3. Slide and lift the stand off the display-assembly base.

## Installing the stand

### Prerequisites

If you are replacing a component, remove the existing component before performing the installation process.

### About this task

**NOTE:** Depending on the stand you are installing onto your computer, refer to the corresponding image shown in the procedure.

The following image(s) indicate the location of the stand and provides a visual representation of the installation procedure.

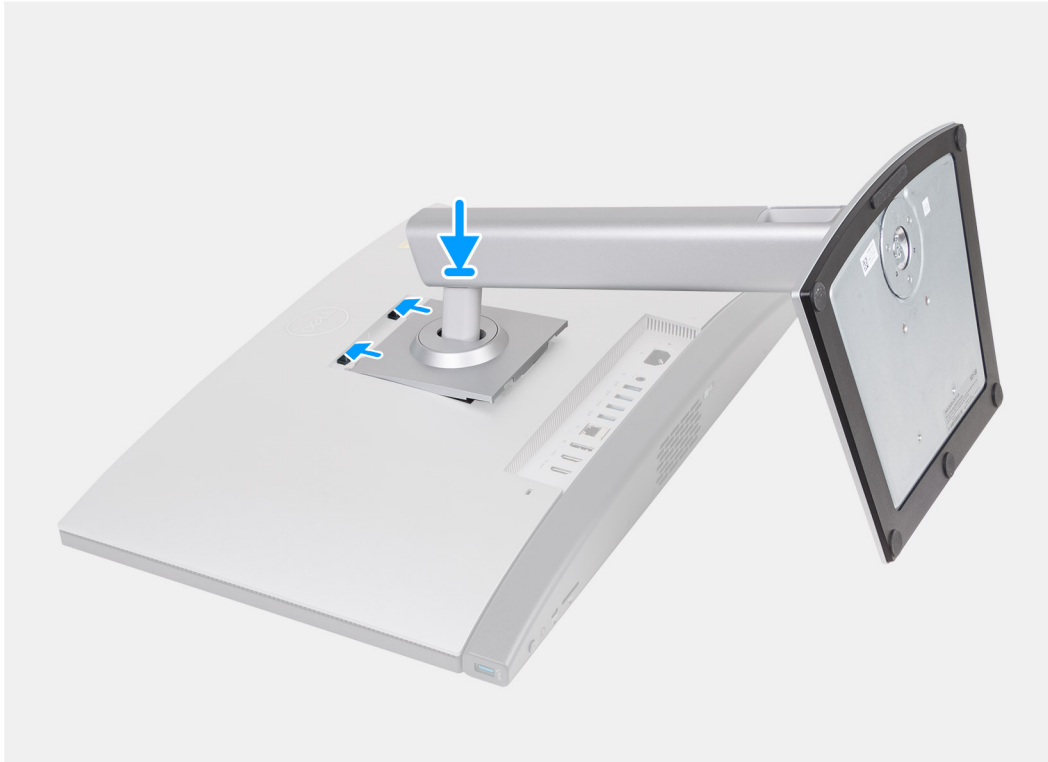



### Steps

1. Align the stand to the slot with the display-assembly base.
2. Slide the stand into place into the slot on the display-assembly base.

### Next steps

1. Follow the procedure in [After working inside your computer](#).

## Back cover

### Removing the back cover

#### Prerequisites

1. Follow the procedure in [Before working inside your computer](#).
2. Remove the [stand](#).

#### About this task

 **NOTE:** Before removing the base cover, ensure that there is no SD card installed in the SD card slot on your computer.

The following image(s) indicate the location of the back cover and provides a visual representation of the removal procedure.

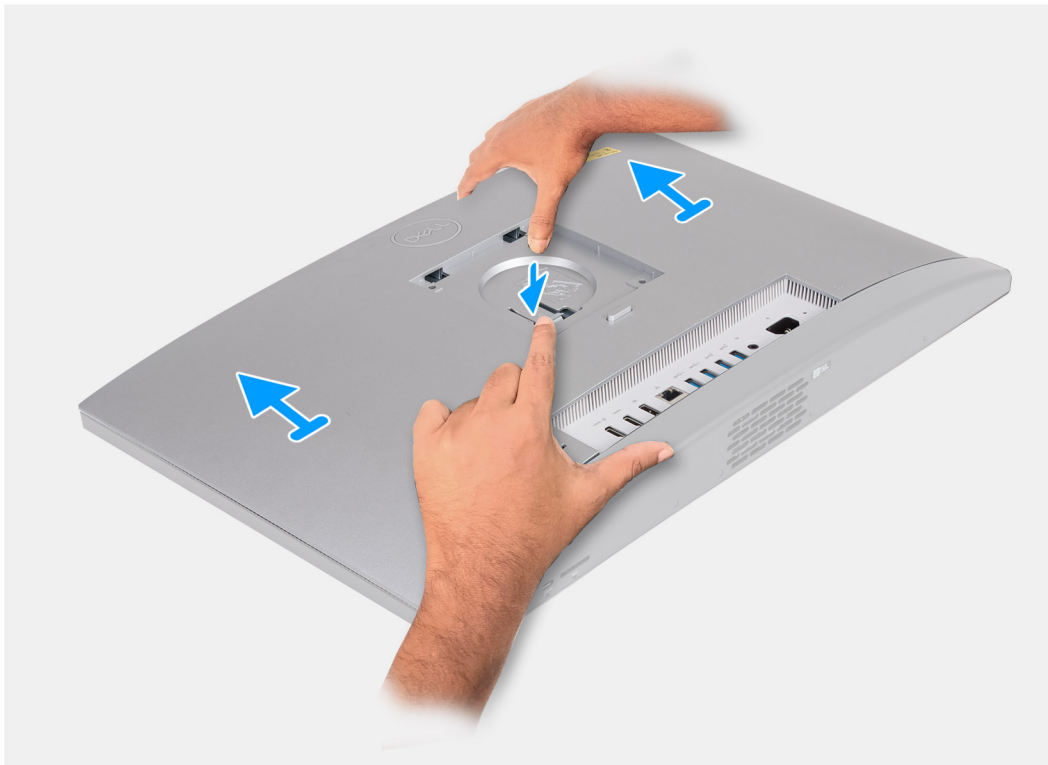

### Steps

1. Press down on the tab that secures the back cover to the display-assembly base.
2. Slide and lift the back cover off the display-assembly base.

## Installing the back cover

### Prerequisites

If you are replacing a component, remove the existing component before performing the installation process.

### About this task

The following image(s) indicate the location of the back cover and provides a visual representation of the installation procedure.



### Steps

1. Align the back cover to the display-assembly base.
2. Place and slide the back cover into place on the display assembly base.

**NOTE:** Ensure that the tab on the back cover is secured in the slot on the display-assembly base.

### Next steps

1. Install the [stand](#).
2. Follow the procedure in [After working inside your computer](#).

## Memory

### Removing the memory

#### Prerequisites

1. Follow the procedure in [Before working inside your computer](#).
2. Remove the [stand](#).
3. Remove the [back cover](#).

#### About this task

The following image(s) indicate the location of the memory and provides a visual representation of the removal procedure.

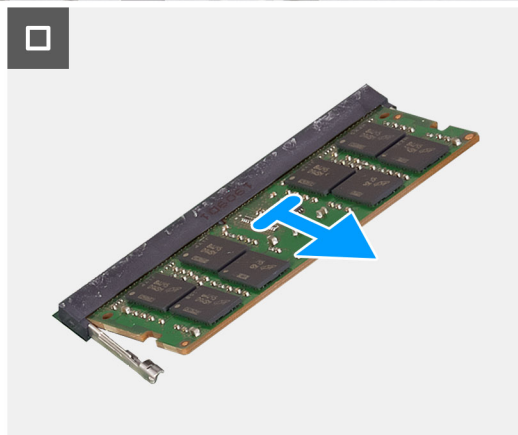
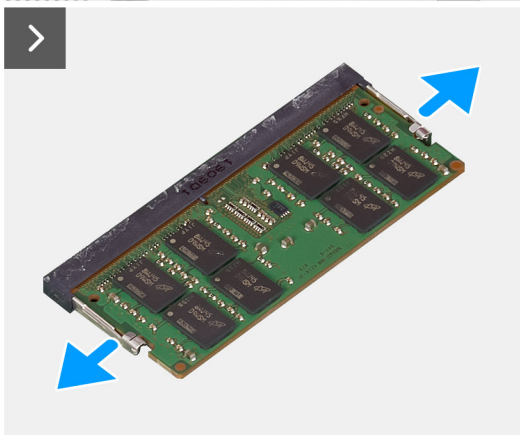
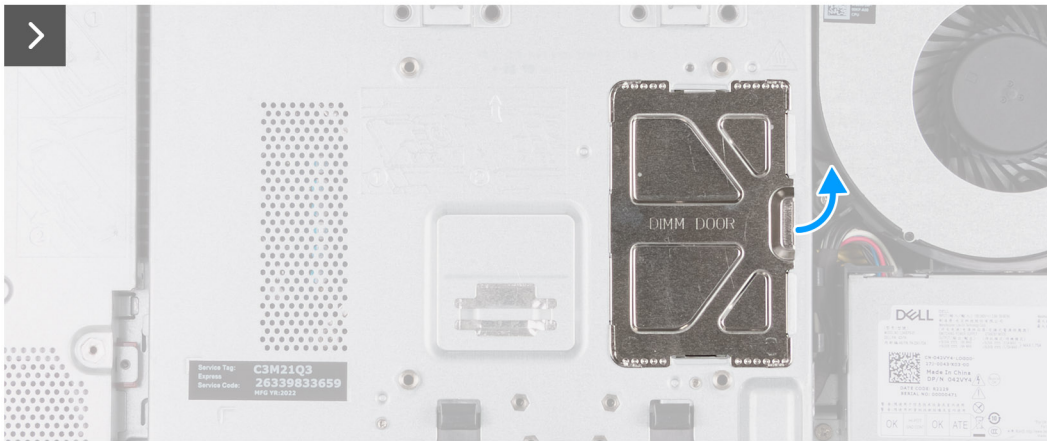
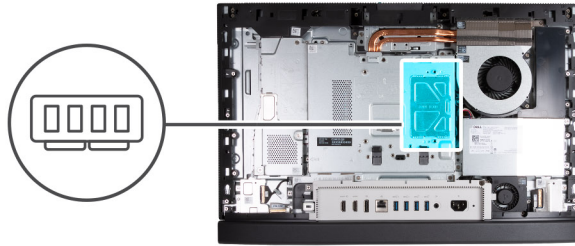

### Steps

1. Using the tab on the DIMM door, pry open and lift the DIMM door on the system-board shield to access the memory slots.
2. Using your fingertips, carefully spread apart the securing clips on each end of the memory-module slot until the memory module pops out.
3. Remove the memory module from the memory-module slot.

**NOTE:** Repeat steps 2 to 3 for each memory module installed on your computer.

## Installing the memory

### Prerequisites

If you are replacing a component, remove the existing component before performing the installation process.

### About this task

The following image(s) indicate the location of the memory and provides a visual representation of the installation procedure.



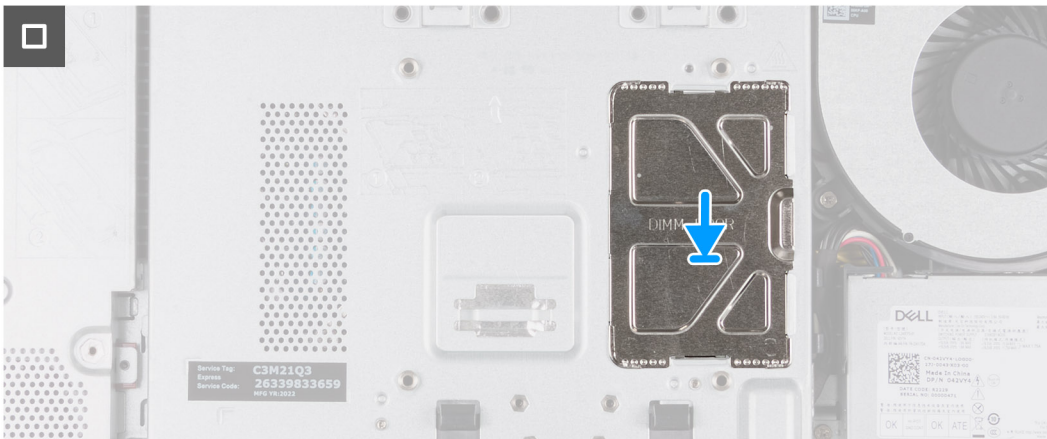
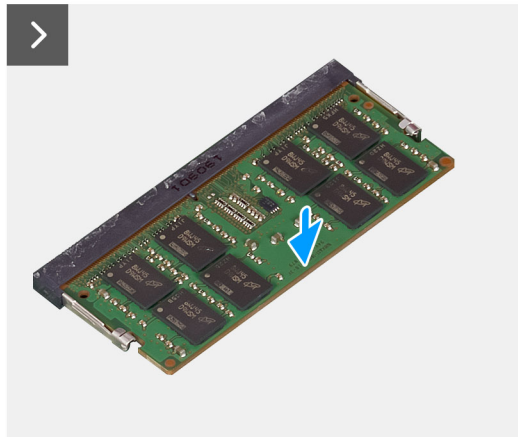
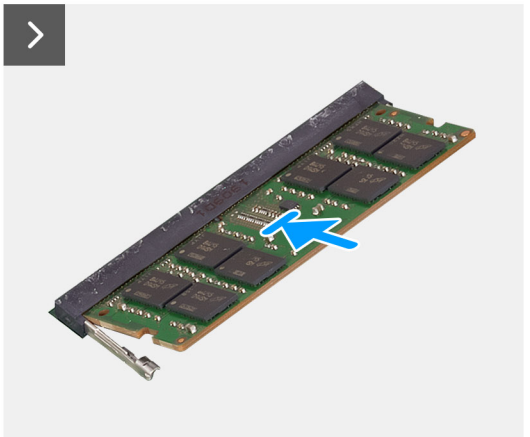
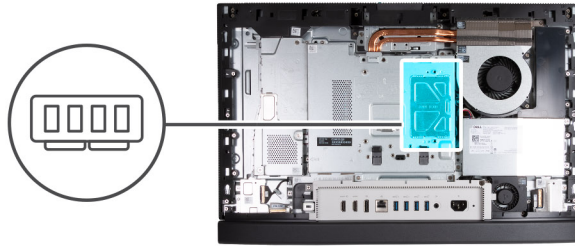

### Steps

1. Align the notch on the memory module with the tab on the memory-module slot
2. Slide the memory module firmly into the slot at an angle and press down on the memory module down until it clicks into place.

**NOTE:** If you do not hear the click, remove the memory module and reinstall it again.

**NOTE:** Repeat steps 1 to 2 for each memory module to be installed on your computer.

3. Close the DIMM door and press it into place, securing it.

### Next steps

1. Install the [back cover](#).
2. Install the [stand](#).
3. Follow the procedure in [After working inside your computer](#).

# System-board shield

## Removing the system-board shield

### Prerequisites

1. Follow the procedure in [Before working inside your computer](#).
2. Remove the [stand](#).
3. Remove the [back cover](#).

### About this task

The following image(s) indicate the location of the system-board shield and provides a visual representation of the removal procedure.



**6x**  
M3x5

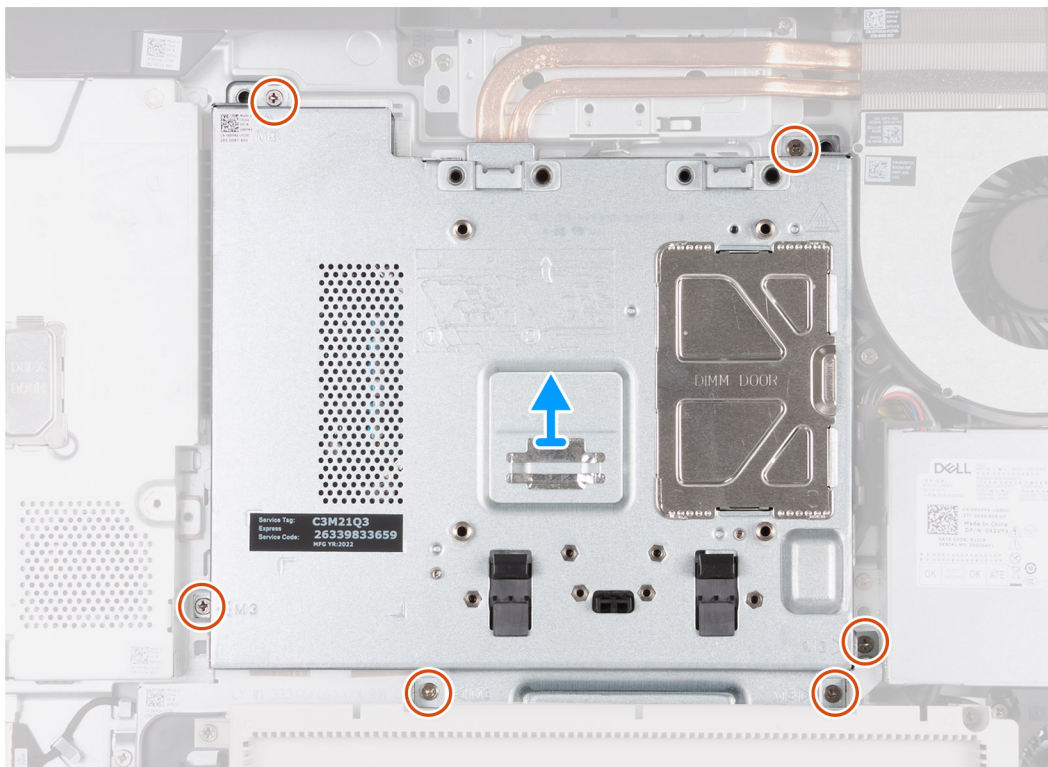
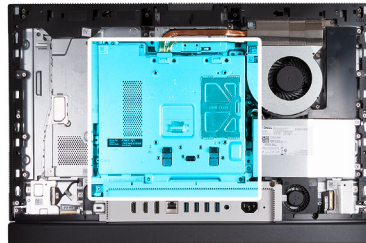

### Steps

1. Remove the six screws (M3x5) that secure the system-board shield to the display-assembly base.
2. Lift the system-board shield off the display-assembly base.

## Installing the system-board shield

### Prerequisites

If you are replacing a component, remove the existing component before performing the installation process.

### About this task

The following image(s) indicate the location of the system-board shield and provides a visual representation of the installation procedure.



**6x**  
M3x5

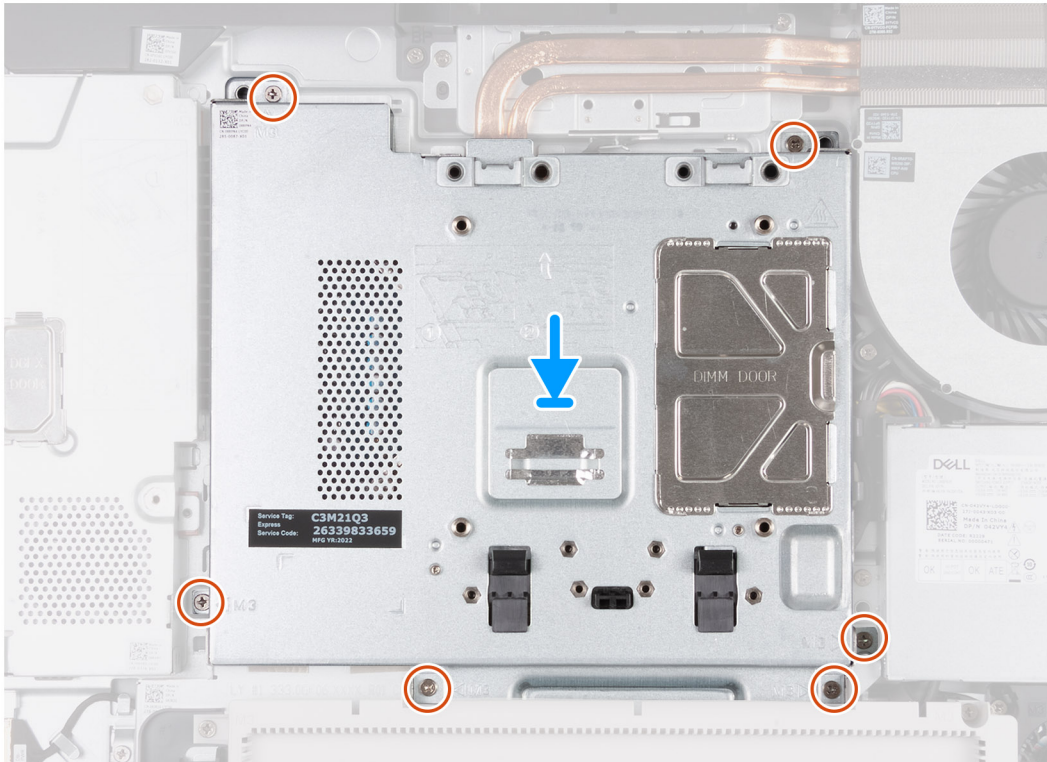
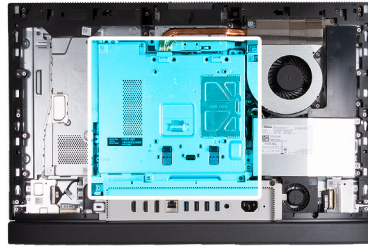

### Steps

1. Place the system-board shield on the display-assembly base.
2. Align the screw holes on the system-board shield with the screw holes on the display-assembly base.
3. Replace the six screws (M3x5) that secure the system-board shield to the display-assembly base.

### Next steps

1. Install the [back cover](#).
2. Install the [stand](#).
3. Follow the procedure in [After working inside your computer](#).

## Wireless card

### Removing the wireless card

#### Prerequisites

1. Follow the procedure in [Before working inside your computer](#).
2. Remove the [stand](#).

3. Remove the [back cover](#).
4. Remove the [system-board shield](#).

**About this task**

The following image(s) indicate the location of the wireless card and provides a visual representation of the removal procedure.



**1x**  
M2x3.5

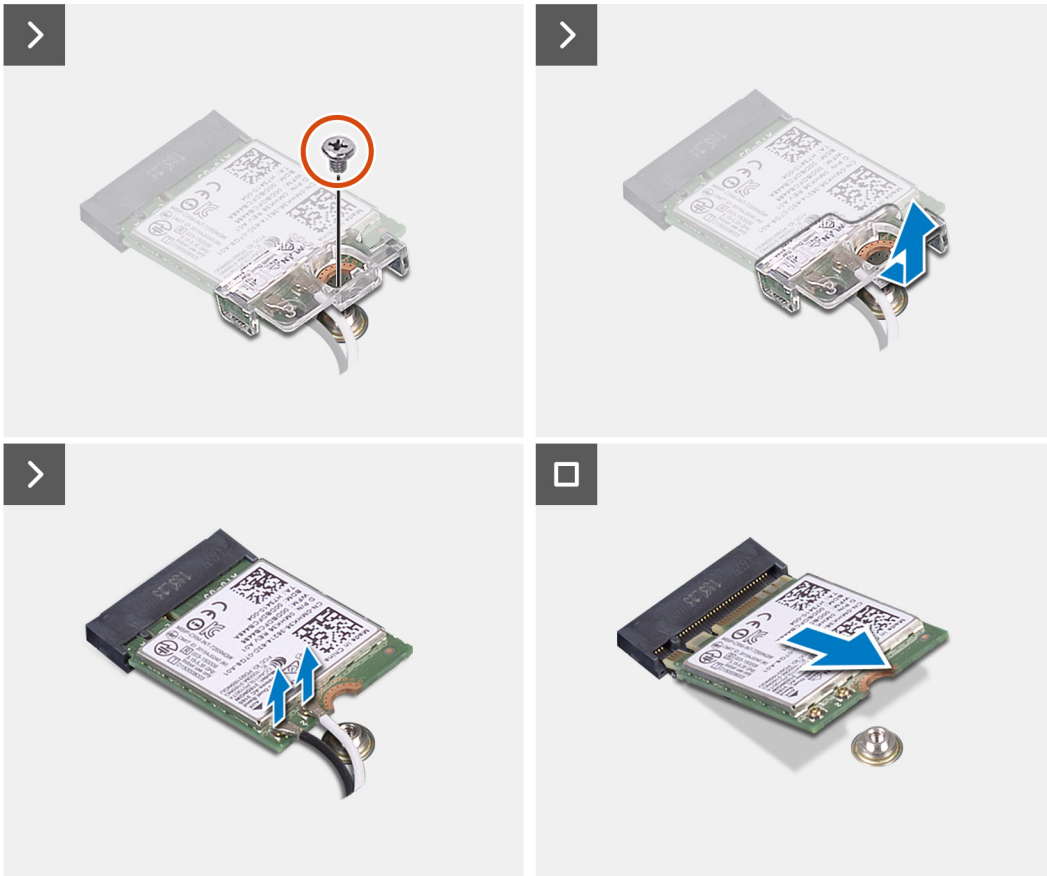
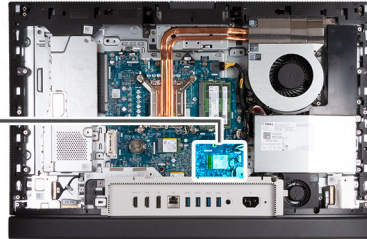

**Steps**

1. Remove the screw (M2x3.5) that secures the wireless-card bracket to the wireless card.
2. Lift the wireless-card bracket off the wireless card.
3. Disconnect the antenna cables from the wireless card.
4. Slide and lift the wireless card from the wireless-card slot (M.2 WLAN).

**Installing the wireless card**

**Prerequisites**

If you are replacing a component, remove the existing component before performing the installation process.

**About this task**

The following image(s) indicate the location of the wireless card and provides a visual representation of the installation procedure.



**1x**  
M2x3.5

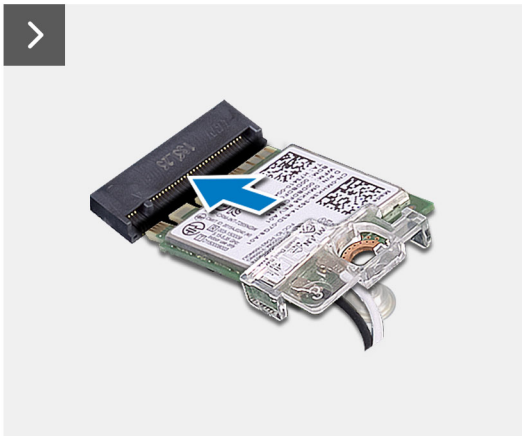
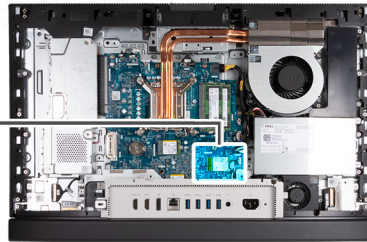

**Steps**

1. Connect the antenna cables to the wireless card.

**Table 25. Antenna-cable color scheme**

Connectors on the wireless card	Antenna-cable color	Silkscreen marking	
Main	White	MAIN	△ (white triangle)
Auxiliary	Black	AUX	▲ (black triangle)

2. Place the wireless-card bracket on the wireless card.
3. Align the notch on the wireless card with the tab on the wireless-card slot (M.2 WLAN).
4. Slide the wireless card at an angle into the wireless-card slot (M.2 WLAN).
5. Replace the screw (M2x3.5) that secures the wireless-card bracket to the wireless card.

### Next steps

1. Install the [system-board shield](#).
2. Install the [back cover](#).
3. Install the [stand](#).
4. Follow the procedure in [After working inside your computer](#).

## Solid-state drive in M.2 slot 0

### Removing the M.2 2230 solid-state drive in M.2 slot 0

#### Prerequisites

1. Follow the procedure in [Before working inside your computer](#).
2. Remove the [stand](#).
3. Remove the [back cover](#).
4. Remove the [system-board shield](#).

#### About this task

- NOTE:** Depending on the configuration ordered, your computer may have up to two M.2 2230 or 2280 solid-state drives installed in the solid-state drive slots on the system board.
- NOTE:** This procedure is applicable for computers where an M.2 2230 solid-state drive is installed in the solid-state drive slot (M.2 PCIe SSD 0) on the system board.

The following image(s) indicate the location of the M.2 2230 solid-state drive in M.2 slot 0 and provides a visual representation of the removal procedure.

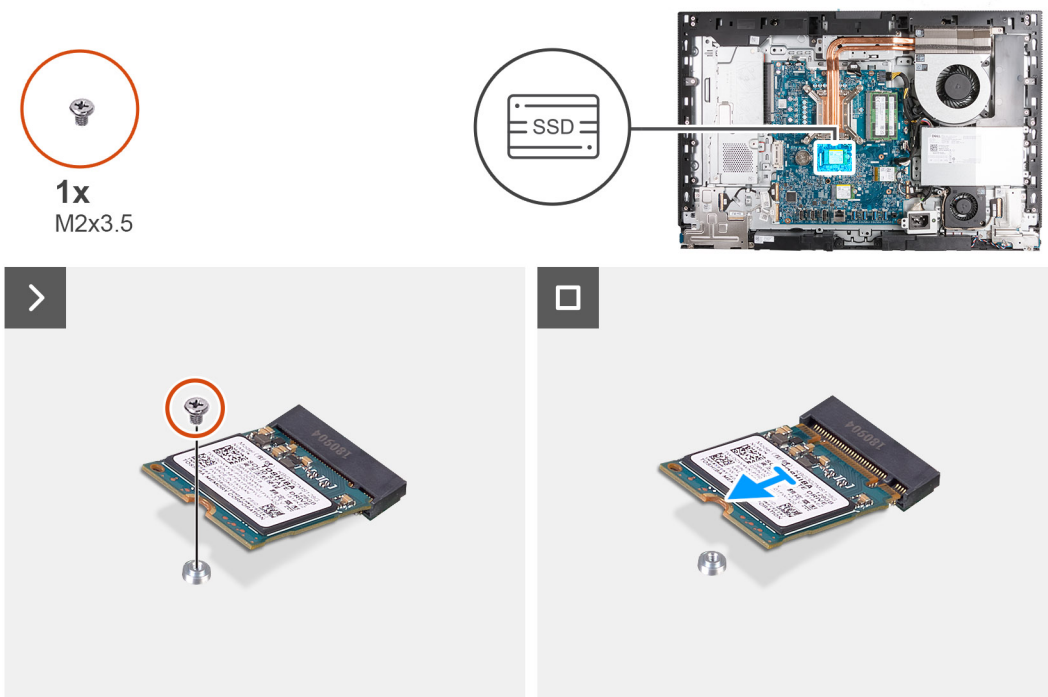

#### Steps

1. Remove the screw (M2x3.5) that secures the M.2 2230 solid-state drive to the system board.
2. Slide and lift the M.2 2230 solid-state drive from the solid-state drive slot (M.2 PCIe SSD 0) on the system board.

## Installing the M.2 2230 solid-state drive in M.2 slot 0

### Prerequisites

If you are replacing a component, remove the existing component before performing the installation process.

### About this task

**NOTE:** This procedure is only applicable if you are installing an M.2 2230 solid-state drive into the solid-state drive slot (M.2 PCIe SSD 0) on the system board.

**NOTE:** Ensure that the M.2 screw mount is in the proper location to install the M.2 2230 solid-state drive, refer to [Location of the screw mount on M.2 slot 0](#).

The following image(s) indicate the location of the M.2 2230 solid-state drive in M.2 slot 0 and provides a visual representation of the installation procedure.

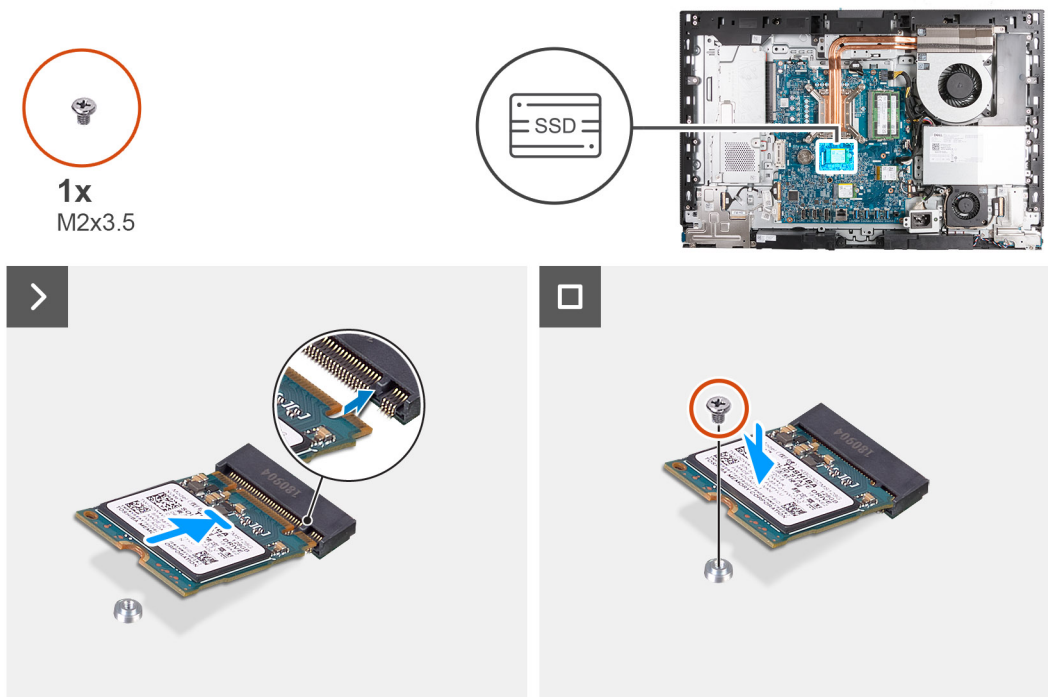

### Steps

1. Align the notch on the M.2 2230 solid-state drive with the tab on the solid-state drive slot (M.2 PCIe SSD 0).
2. Slide the M.2 2230 solid-state drive into the solid-state drive slot (M.2 PCIe SSD 0) on the system board.
3. Replace the screw (M2x3.5) that secures the M.2 2230 solid-state drive to the system board.

### Next steps

1. Install the [system-board shield](#).
2. Install the [back cover](#).
3. Install the [stand](#).
4. Follow the procedure in [After working inside your computer](#).

## Removing the M.2 2280 solid-state drive in M.2 slot 0

### Prerequisites

1. Follow the procedure in [Before working inside your computer](#).
2. Remove the [stand](#).
3. Remove the [back cover](#).

4. Remove the [system-board shield](#).

#### About this task

- NOTE:** Depending on the configuration ordered, your computer may have up to two M.2 2230 or 2280 solid-state drives installed in the solid-state drive slots on the system board.
- NOTE:** This procedure is applicable for computers where an M.2 2280 solid-state drive is installed in the solid-state drive slot (M.2 PCIe SSD 0) on the system board.

The following image(s) indicate the location of the M.2 2280 solid-state drive in M.2 slot 0 and provides a visual representation of the removal procedure.

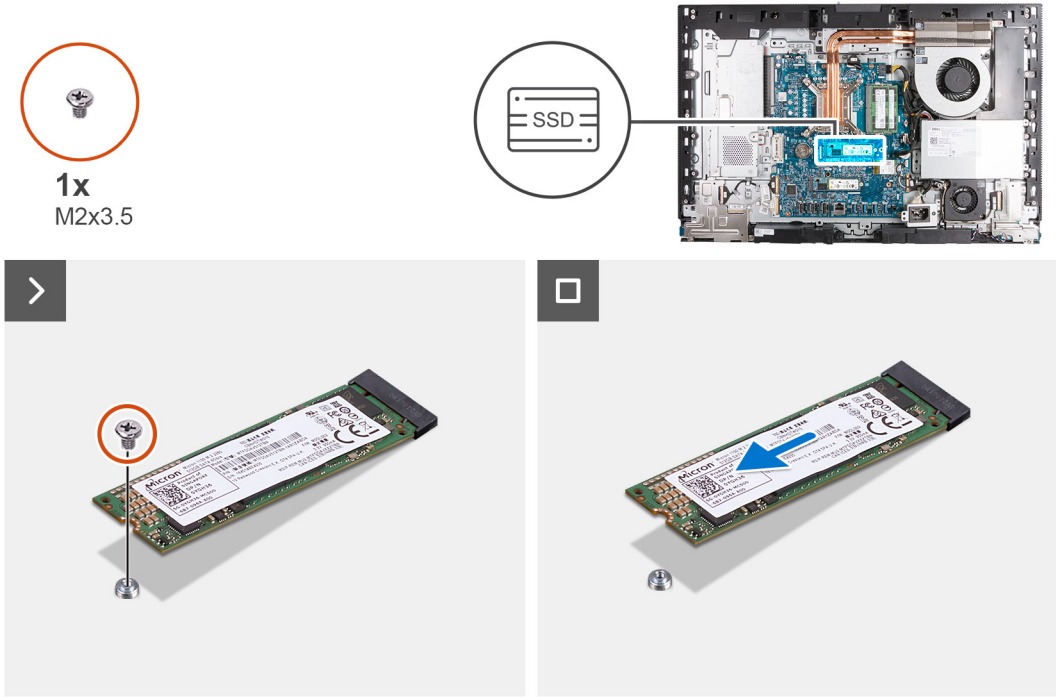

#### Steps

1. Remove the screw (M2x3.5) that secures the M.2 2280 solid-state drive to the system board.
2. Slide and lift the M.2 2280 solid-state drive from the solid-state drive slot (M.2 PCIe SSD 0) on the system board.

## Installing the M.2 2280 solid-state drive in M.2 slot 0

#### Prerequisites

If you are replacing a component, remove the existing component before performing the installation process.

#### About this task

- NOTE:** This procedure is only applicable if you are installing an M.2 2280 solid-state drive into the solid-state drive slot (M.2 PCIe SSD 0) on the system board.
- NOTE:** Ensure that the M.2 screw mount is in the proper location to install the M.2 2280 solid-state drive, refer to [Location of the screw mount on M.2 slot 0](#).

The following image(s) indicate the location of the M.2 2280 solid-state drive in M.2 slot 0 and provides a visual representation of the installation procedure.





1x  
M2x3.5

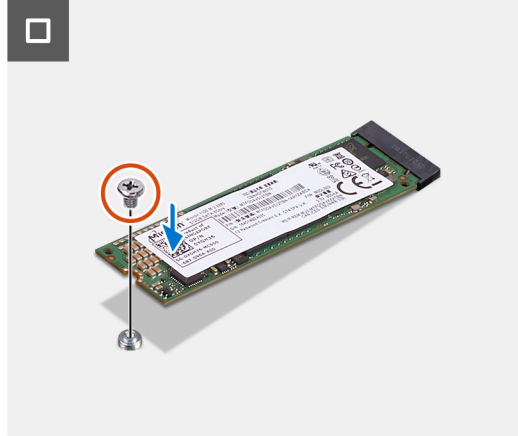
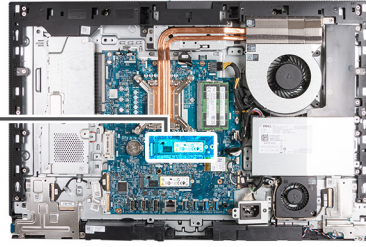

### Steps

1. Align the notch on the M.2 2280 solid-state drive with the tab on the solid-state drive slot (M.2 PCIe SSD 0).
2. Slide the M.2 2280 solid-state drive into the solid-state drive slot (M.2 PCIe SSD 0) on the system board.
3. Replace the screw (M2x3.5) that secures the M.2 2280 solid-state drive to the system board.

### Next steps

1. Install the [system-board shield](#).
2. Install the [back cover](#).
3. Install the [stand](#).
4. Follow the procedure in [After working inside your computer](#).

## Location of the screw mount on M.2 slot 0

### Prerequisites

To install an M.2 solid-state drive of a different form factor on M.2 slot 0, the location of the screw mount on M.2 slot 0 has to be changed in order to install the M.2 solid-state drive of a different form factor.

### About this task

**NOTE:** This procedure only applies to the screw mount located on M.2 slot 0.

The following image(s) indicate the location of the screw mount on M.2 slot 0 and provides a visual representation of the procedure to change the position of the screw mount.

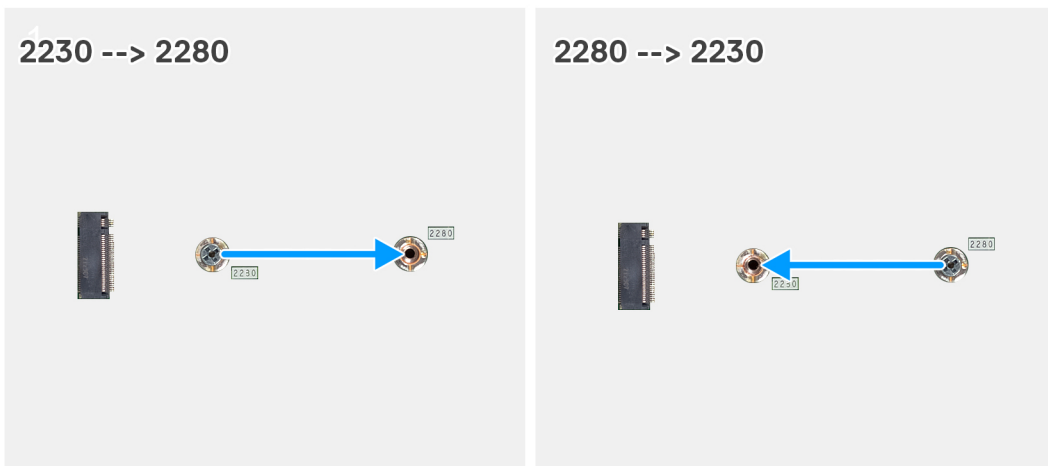

### Steps

1. Remove the screw mount on the system board.
2. Install the screw mount on the system board.

### Next steps

1. Install the [M.2 2230 solid-state drive slot 0](#) or the [M.2 2280 solid-state drive slot 0](#), whichever applicable.
2. Install the [system-board shield](#).
3. Install the [back cover](#).
4. Install the [stand](#).
5. Follow the procedure in [After working inside your computer](#).

## Solid-state drive in M.2 slot 1

### Removing the M.2 2230 solid-state drive in M.2 slot 1

#### Prerequisites

1. Follow the procedure in [Before working inside your computer](#).
2. Remove the [stand](#).
3. Remove the [back cover](#).
4. Remove the [system-board shield](#).
5. Remove the [I/O cover](#).

#### About this task

**NOTE:** Depending on the configuration ordered, your computer may have up to two M.2 2230 or 2280 solid-state drives installed in the solid-state drive slots on the system board.

**NOTE:** This procedure is applicable for computers where an M.2 2230 solid-state drive is installed in the solid-state drive slot (M.2 PCIe SSD 1) on the system board.

The following image(s) indicate the location of the M.2 2230 solid-state drive in M.2 slot 1 and provides a visual representation of the removal procedure.



1x  
M2x3.5

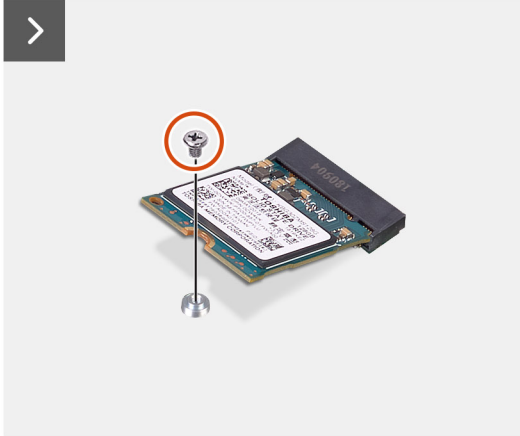
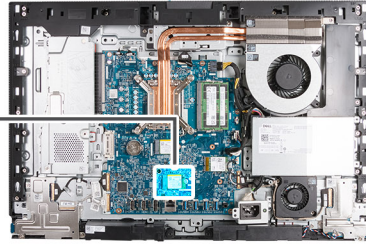

### Steps

1. Remove the screw (M2x3.5) that secures the M.2 2230 solid-state drive to the system board.
2. Slide and lift the M.2 2230 solid-state drive from the solid-state drive slot (M.2 PCIe SSD 1) on the system board.

## Installing the M.2 2230 solid-state drive in M.2 slot 1

### Prerequisites

If you are replacing a component, remove the existing component before performing the installation process.

### About this task

**NOTE:** This procedure is only applicable if you are installing an M.2 2230 solid-state drive into the solid-state drive slot (M.2 PCIe SSD 1) on the system board.

**NOTE:** Ensure that the M.2 screw mount is in the proper location to install the M.2 2230 solid-state drive, refer to [Location of the screw mount on M.2 slot 1](#).

The following image(s) indicate the location of the M.2 2230 solid-state drive in M.2 slot 1 and provides a visual representation of the installation procedure.



1x  
M2x3.5

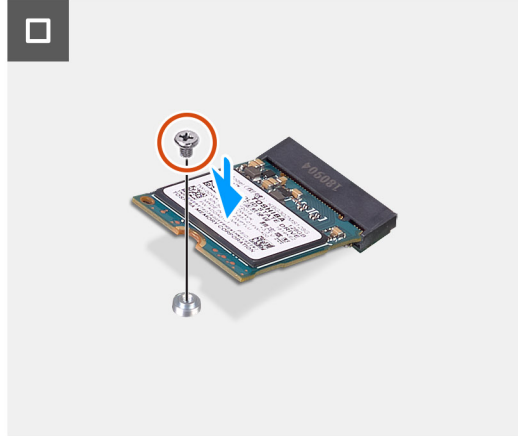
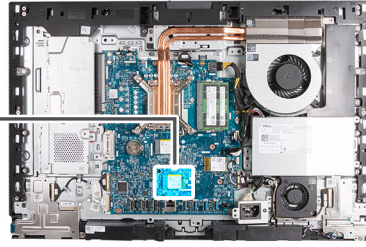

### Steps

1. Align the notch on the M.2 2230 solid-state drive with the tab on the solid-state drive slot (M.2 PCIe SSD 1).
2. Slide the M.2 2230 solid-state drive into the solid-state drive slot (M.2 PCIe SSD 1) on the system board.
3. Replace the screw (M2x3.5) that secures the M.2 2230 solid-state drive to the system board.

### Next steps

1. Install the [I/O cover](#).
2. Install the [system-board shield](#).
3. Install the [back cover](#).
4. Install the [stand](#).
5. Follow the procedure in [After working inside your computer](#).

## Removing the M.2 2280 solid-state drive in M.2 slot 1

### Prerequisites

1. Follow the procedure in [Before working inside your computer](#).
2. Remove the [stand](#).
3. Remove the [back cover](#).
4. Remove the [system-board shield](#).
5. Remove the [I/O cover](#).

### About this task

 **NOTE:** Depending on the configuration ordered, your computer may have up to two M.2 2230 or 2280 solid-state drives installed in the solid-state drive slots on the system board.

 **NOTE:** This procedure is applicable for computers where an M.2 2280 solid-state drive is installed in the solid-state drive slot (M.2 PCIe SSD 1) on the system board.

The following image(s) indicate the location of the M.2 2280 solid-state drive in M.2 slot 1 and provides a visual representation of the removal procedure.



1x  
M2x3.5

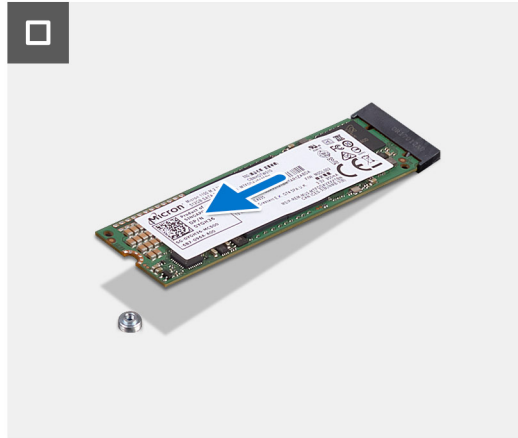
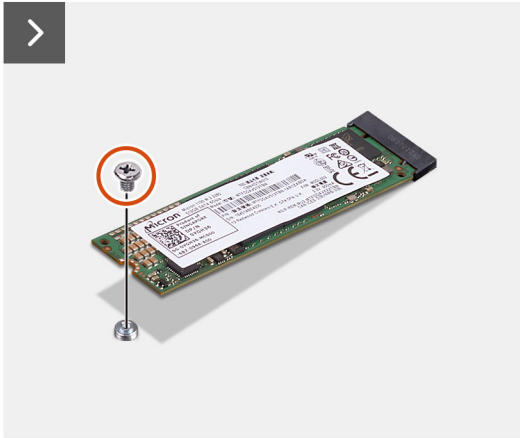
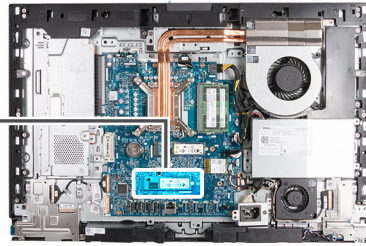

### Steps

1. Remove the screw (M2x3.5) that secures the M.2 2280 solid-state drive to the system board.
2. Slide and lift the M.2 2280 solid-state drive from the solid-state drive slot (M.2 PCIe SSD 1) on the system board.

## Installing the M.2 2280 solid-state drive in M.2 slot 1

### Prerequisites

If you are replacing a component, remove the existing component before performing the installation process.

### About this task

**NOTE:** This procedure is only applicable if you are installing an M.2 2280 solid-state drive into the solid-state drive slot (M.2 PCIe SSD 1) on the system board.

**NOTE:** Ensure that the M.2 screw mount is in the proper location to install the M.2 2280 solid-state drive, refer to [Location of the screw mount on M.2 slot 1](#).

The following image(s) indicate the location of the M.2 2280 solid-state drive in M.2 slot 1 and provides a visual representation of the installation procedure.



1x  
M2x3.5

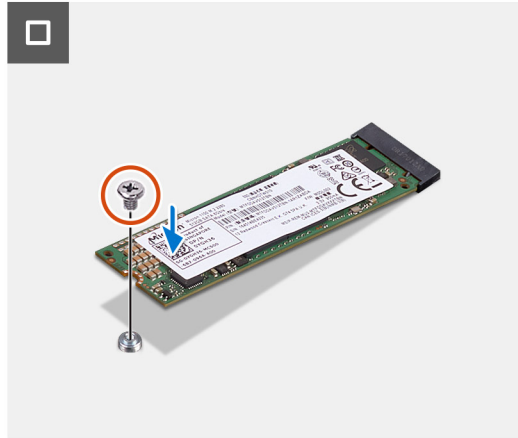
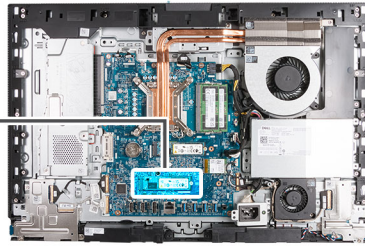

### Steps

1. Align the notch on the M.2 2280 solid-state drive with the tab on the solid-state drive slot (M.2 PCIe SSD 1).
2. Slide the M.2 2280 solid-state drive into the solid-state drive slot (M.2 PCIe SSD 1) on the system board.
3. Replace the screw (M2x3.5) that secures the M.2 2280 solid-state drive to the system board.

### Next steps

1. Install the [I/O cover](#).
2. Install the [system-board shield](#).
3. Install the [back cover](#).
4. Install the [stand](#).
5. Follow the procedure in [After working inside your computer](#).

## Location of the screw mount on M.2 slot 1

### Prerequisites

To install an M.2 solid-state drive of a different form factor on M.2 slot 1, the location of the screw mount on M.2 slot 1 has to be changed in order to install the M.2 solid-state drive of a different form factor.

### About this task

 **NOTE:** This procedure only applies to the screw mount located on M.2 slot 1.

The following image(s) indicate the location of the screw mount on M.2 slot 1 and provides a visual representation of the procedure to change the position of the screw mount.

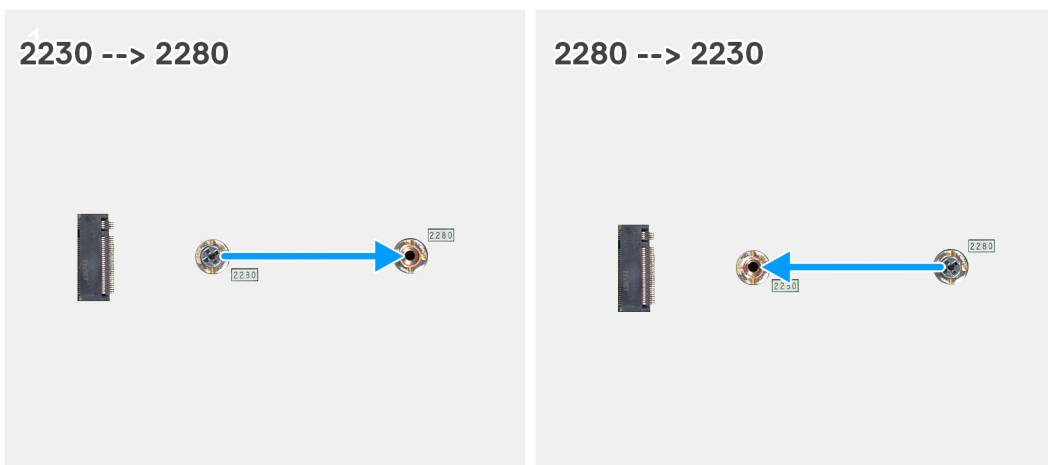

### Steps

1. Remove the screw mount on the system board.
2. Install the screw mount on the system board.

### Next steps

1. Install the [M.2 2230 solid-state drive slot 1](#) or the [M.2 2280 solid-state drive slot 1](#), whichever applicable.
2. Install the [system-board shield](#).
3. Install the [back cover](#).
4. Install the [stand](#).
5. Follow the procedure in [After working inside your computer](#).

## Coin-cell battery

### Removing the coin-cell battery

#### Prerequisites

1. Follow the procedure in [Before working inside your computer](#).
2. Remove the [stand](#).
3. Remove the [back cover](#).
4. Remove the [system-board shield](#).

#### About this task

**NOTE:** Removing the coin-cell battery resets the BIOS settings to default. It is recommended that you note the BIOS settings before removing the coin-cell battery.

The following image(s) indicate the location of the coin-cell battery and provides a visual representation of the removal procedure.

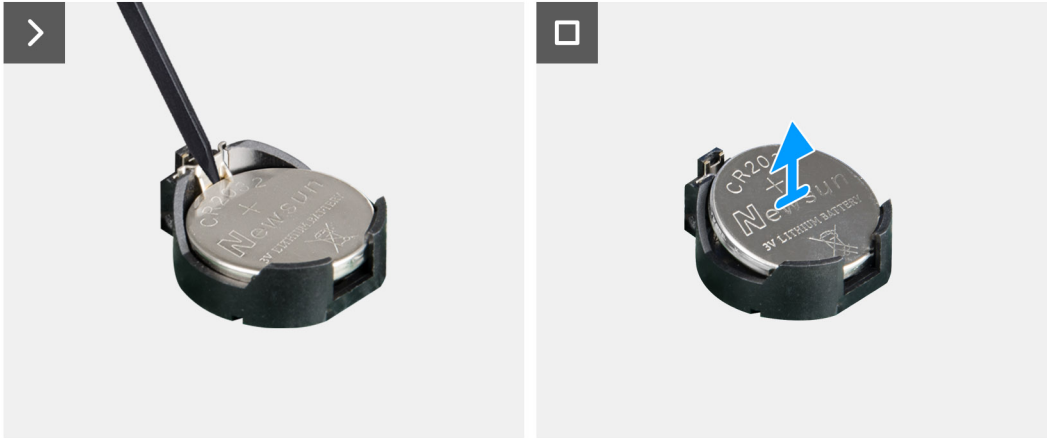
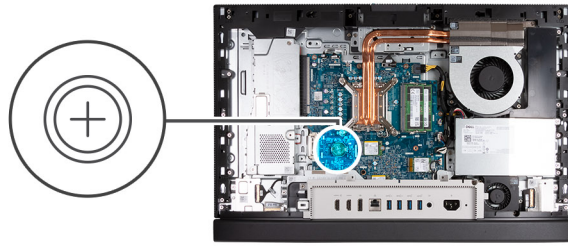

### Steps

1. Push the release lever on the coin-cell battery socket to release the coin-cell battery out of the socket.
2. Lift the coin-cell battery from the coin-cell battery socket.

## Installing the coin-cell battery

### Prerequisites

If you are replacing a component, remove the existing component before performing the installation process.

### About this task

The following image(s) indicate the location of the coin-cell battery and provides a visual representation of the installation procedure.



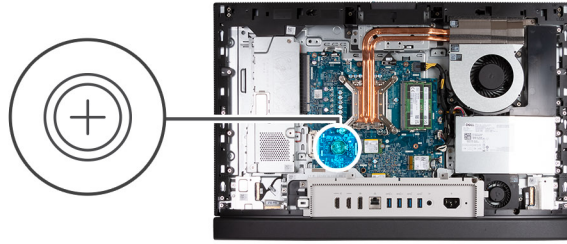

### Steps

With the positive-side (+) facing up, insert the coin-cell battery into the battery socket on the system board and snap the battery into place.

### Next steps

1. Install the [system-board shield](#).
2. Install the [back cover](#).
3. Install the [stand](#).
4. Follow the procedure in [After working inside your computer](#).

## I/O cover

### Removing the I/O cover

#### Prerequisites

1. Follow the procedure in [Before working inside your computer](#).
2. Remove the [stand](#).
3. Remove the [back cover](#).
4. Remove the [system-board shield](#).

#### About this task

The following image(s) indicate the location of the I/O cover and provides a visual representation of the removal procedure.



**2x**  
M3x5

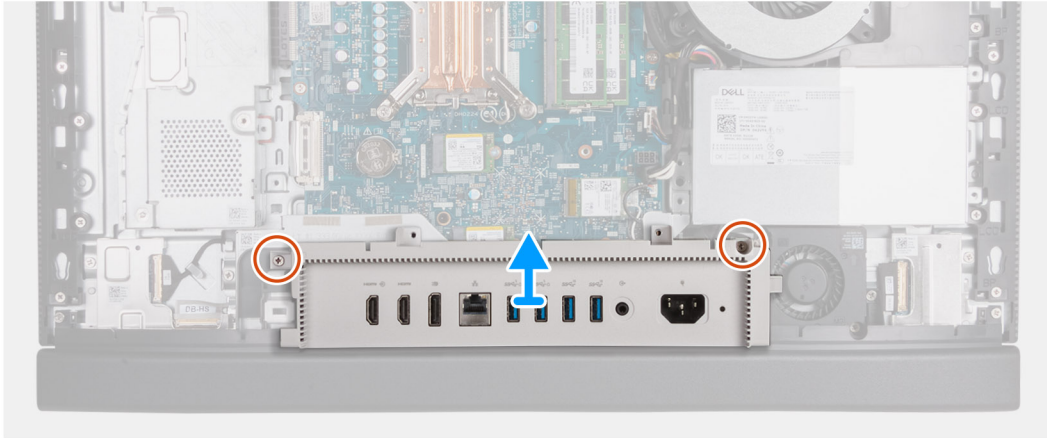

### Steps

1. Remove the two screws (M3x5) that secure the I/O cover to the display-assembly base.
2. Lift the I/O cover off the display-assembly base.

## Installing the I/O cover

### Prerequisites

If you are replacing a component, remove the existing component before performing the installation process.

### About this task

The following image(s) indicate the location of the I/O cover and provides a visual representation of the installation procedure.



2x  
M3x5

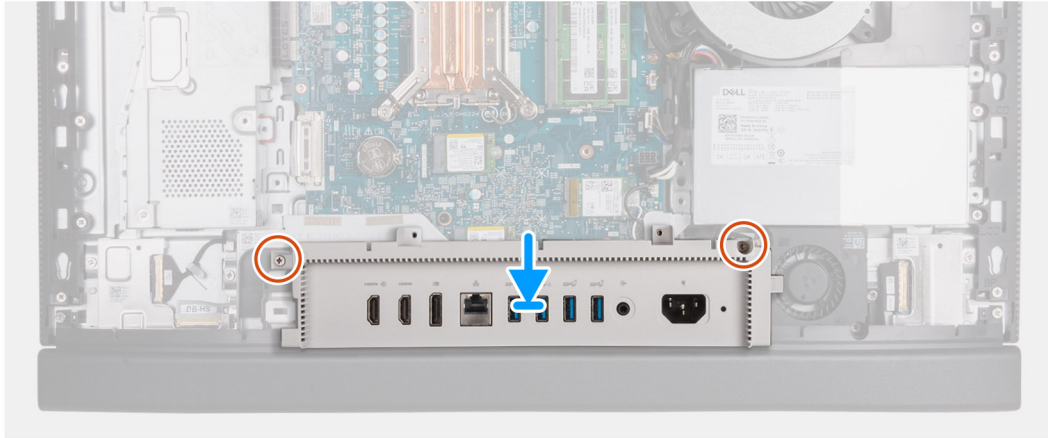

### Steps

1. Place and align the I/O cover with the display-assembly base.
2. Align the I/O slots on the I/O cover with the I/O ports and the screw holes on the I/O cover with the screw holes on the display-assembly base.
3. Replace the two screws (M3x5) that secure the I/O cover to the display-assembly base.

### Next steps

1. Install the [system-board shield](#).
2. Install the [back cover](#).
3. Install the [stand](#).
4. Follow the procedure in [After working inside your computer](#).

## Bottom cover

### Removing the bottom cover

#### Prerequisites

1. Follow the procedure in [Before working inside your computer](#).
2. Remove the [stand](#).
3. Remove the [back cover](#).
4. Remove the [system-board shield](#).
5. Remove the [I/O cover](#).

#### About this task

The following image(s) indicate the location of the bottom cover and provides a visual representation of the removal procedure.



**3x**  
M3x5

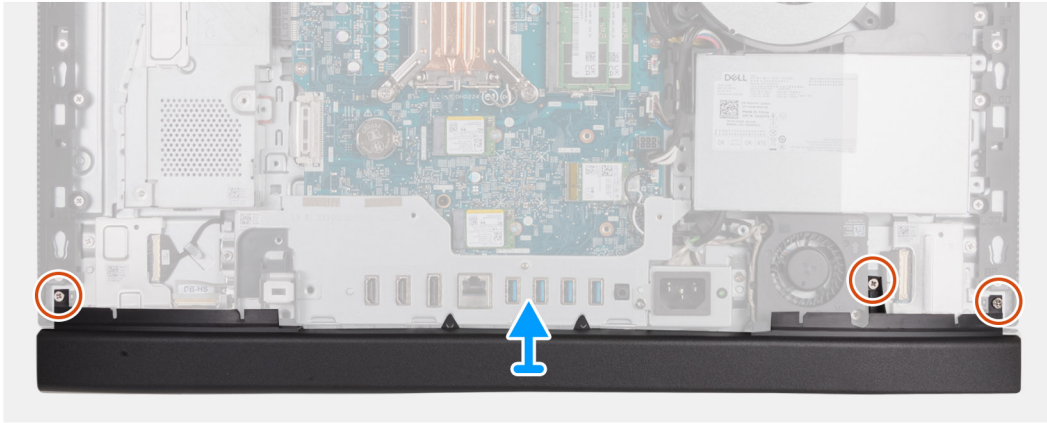
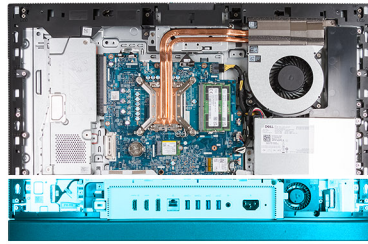

### Steps

1. Remove the three screws (M3x5) that secure the bottom cover to the display-assembly base.
2. Lift the bottom cover off the display-assembly base.

## Installing the bottom cover

### Prerequisites

If you are replacing a component, remove the existing component before performing the installation process.

### About this task

The following image(s) indicate the location of the bottom cover and provides a visual representation of the installation procedure.



**3x**  
M3x5

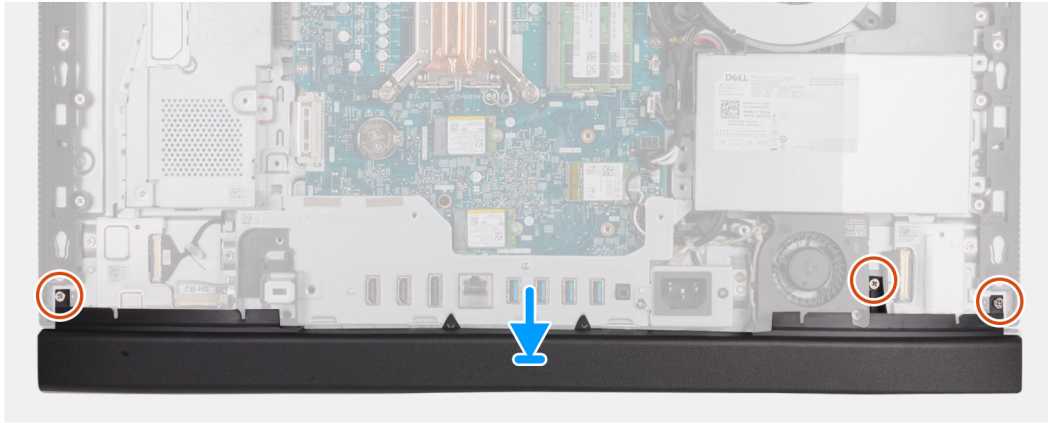
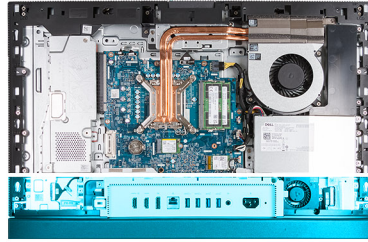

### Steps

1. Place and align the bottom cover with the display-assembly base.
2. Align the screw holes on the bottom cover with the screw holes on the display-assembly base.
3. Replace the three screws (M3x5) that secure the bottom cover to the display-assembly base.

### Next steps

1. Install the [I/O cover](#).
2. Install the [system-board shield](#).
3. Install the [back cover](#).
4. Install the [stand](#).
5. Follow the procedure in [After working inside your computer](#).

## Retractable-camera assembly

### Removing the retractable-camera assembly

#### Prerequisites

1. Follow the procedure in [Before working inside your computer](#).
2. Remove the [stand](#).
3. Remove the [back cover](#).
4. Remove the [system-board shield](#).

#### About this task

- NOTE:** The retractable-camera assembly consists of the following components:
- camera
  - microphones

The following image(s) indicate the location of the retractable-camera assembly and provides a visual representation of the removal procedure.



4x  
M3x5

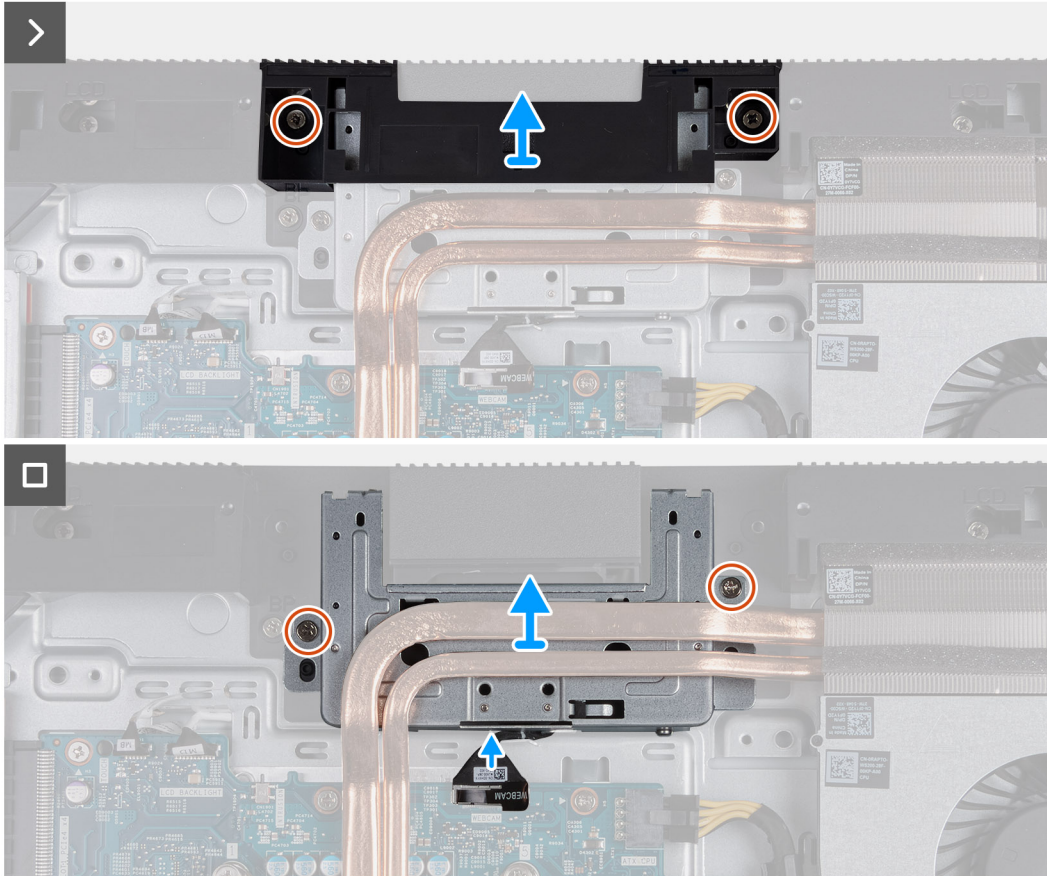
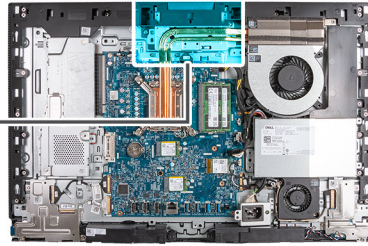

### Steps

1. Remove the two screws (M3x5) that secure the camera-assembly bracket to the display-assembly base.
2. Lift the camera-assembly bracket off the display-assembly base.
3. Using the pull tab, disconnect the camera cable (WEBCAM) from the system board.
4. Remove the two screws (M3x5) that secure the retractable-camera assembly to the display-assembly base.
5. Lift and slide the retractable-camera assembly from its slot and under the heat sink and remove the retractable-camera assembly from the display-assembly base.

## Installing the retractable-camera assembly

### Prerequisites

If you are replacing a component, remove the existing component before performing the installation process.

### About this task

The following image(s) indicate the location of the retractable-camera assembly and provides a visual representation of the installation procedure.



4x  
M3x5

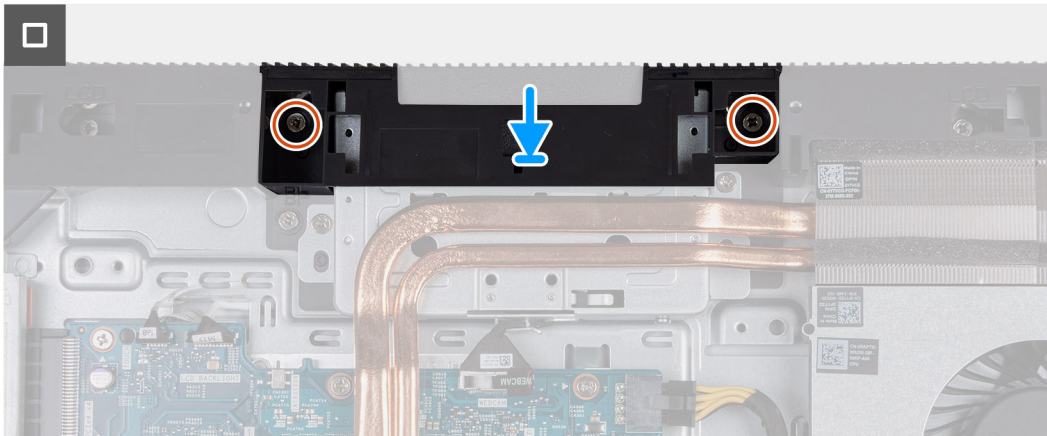
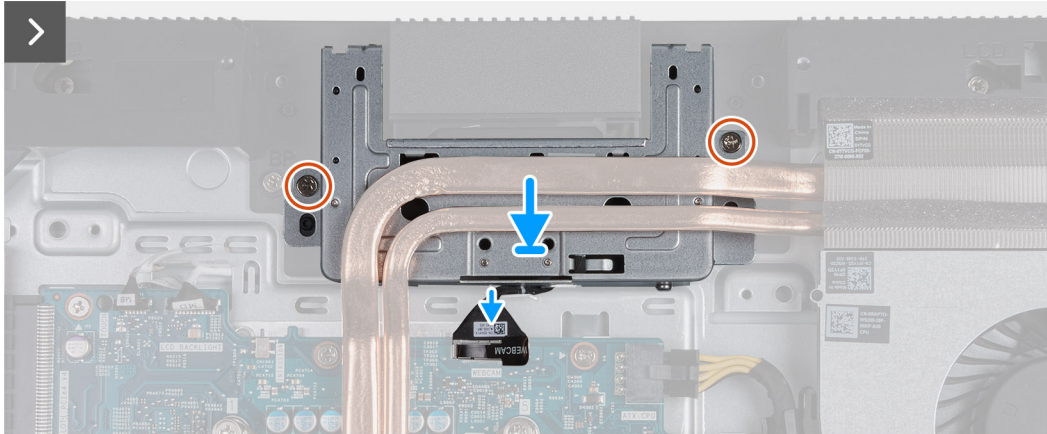
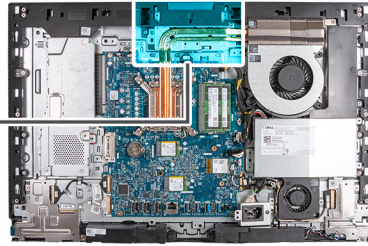
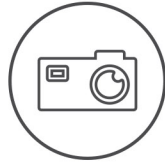

### Steps

1. Slide the retractable-camera assembly under the heat sink into its slot on the display-assembly base.
2. Align the screw holes on the retractable-camera assembly with the screw holes on the display-assembly base.
3. Replace the two screws (M3x5) that secure the retractable-camera assembly to the display-assembly base.
4. Connect the camera cable (WEBCAM) to the system board.
5. Place the camera-assembly bracket over retractable-camera assembly.
6. Align the screw holes on the camera-assembly bracket with the screw holes on the display-assembly base.
7. Replace the two screws (M3x5) that secure the camera-assembly bracket to the display-assembly base.

### Next steps

1. Install the [system-board shield](#).
2. Install the [back cover](#).
3. Install the [stand](#).
4. Follow the procedure in [After working inside your computer](#).

# Fan

## Removing the fan

### Prerequisites

1. Follow the procedure in [Before working inside your computer](#).
2. Remove the [stand](#).
3. Remove the [back cover](#).
4. Remove the [system-board shield](#).

### About this task

The following image(s) indicate the location of the fan and provides a visual representation of the removal procedure.

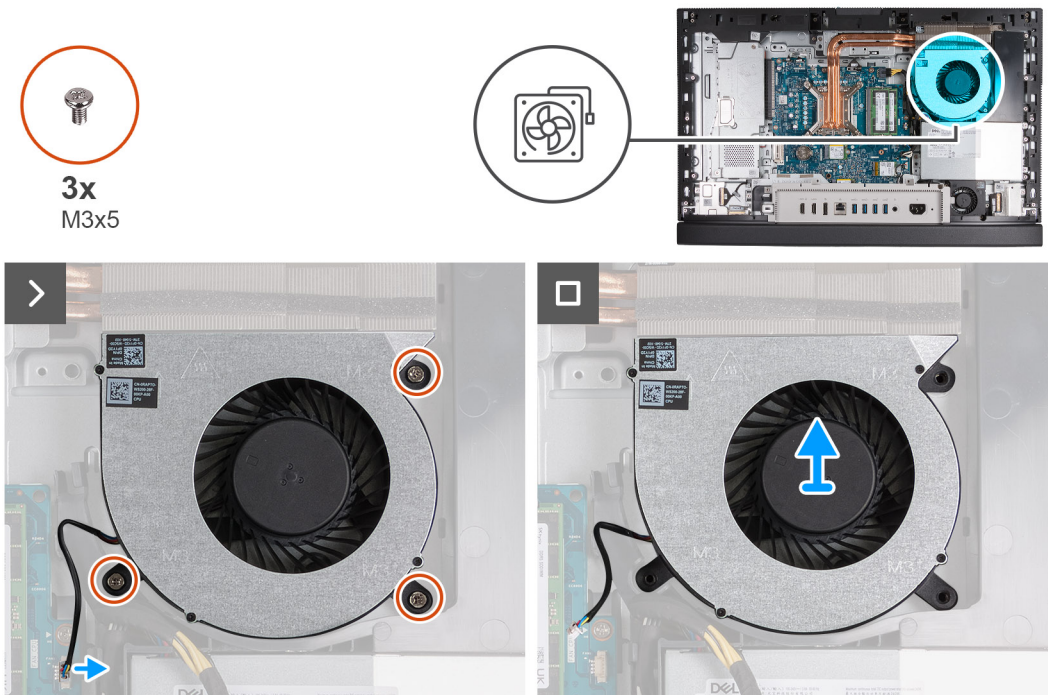

### Steps

1. Remove three two screws (M3x5) that secure the fan to the display-assembly base.
2. Disconnect the fan cable (FAN CPU) from the system board.
3. Lift the fan off the display-assembly base.

## Installing the fan

### Prerequisites

If you are replacing a component, remove the existing component before performing the installation process.

### About this task

The following image(s) indicate the location of the fan and provides a visual representation of the installation procedure.





3x  
M3x5

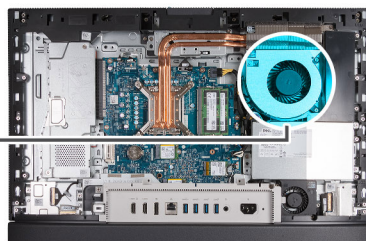
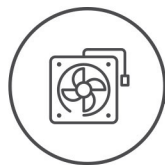

### Steps

1. Place the fan on the display-assembly base.
2. Align the screw holes on the fan with the screw holes on the display-assembly base.
3. Replace the three screws (M3x5) that secure the fan to the display-assembly base.
4. Connect the fan cable (FAN CPU) to the system board.

### Next steps

1. Install the [system-board shield](#).
2. Install the [back cover](#).
3. Install the [stand](#).
4. Follow the procedure in [After working inside your computer](#).

## Power-supply unit

### Removing the power-supply unit

#### Prerequisites

1. Follow the procedure in [Before working inside your computer](#).
2. Remove the [stand](#).
3. Remove the [back cover](#).
4. Remove the [system-board shield](#).
5. Remove the [I/O cover](#).

#### About this task

The following image(s) indicate the location of the power-supply unit and provides a visual representation of the removal procedure.



5x  
M3x5

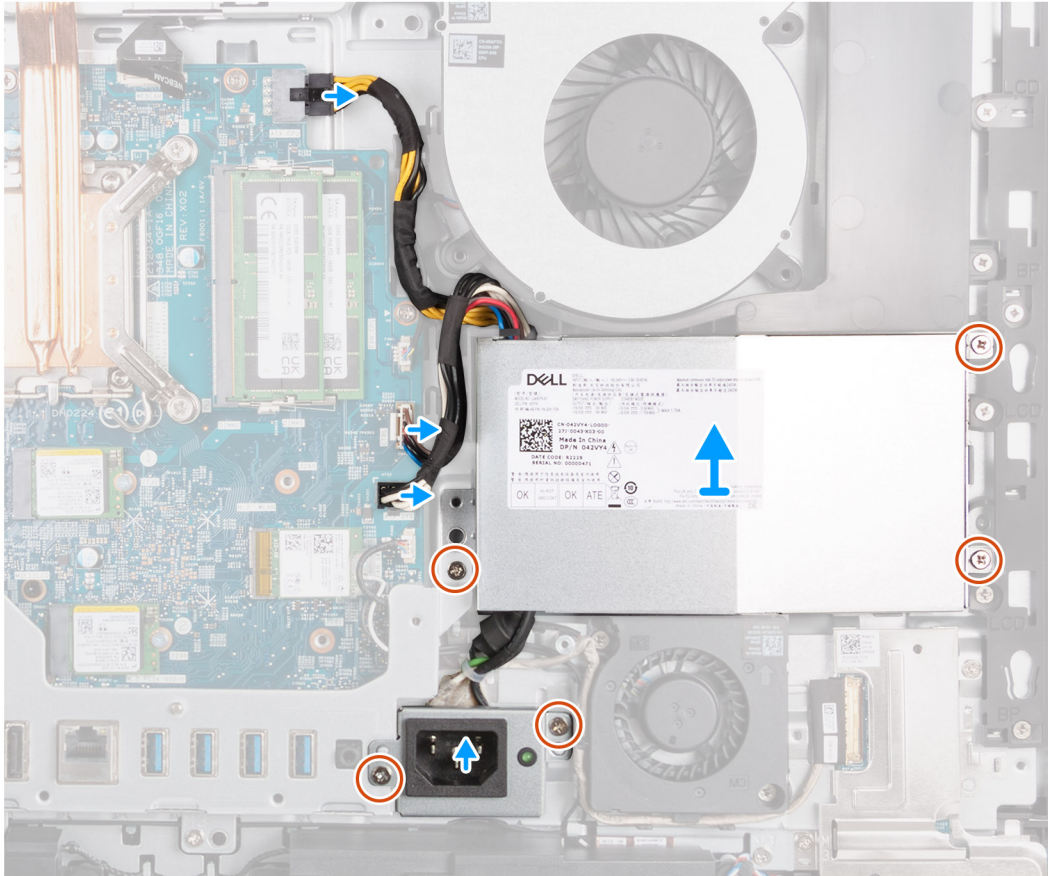
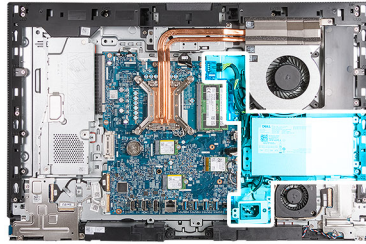

### Steps

1. Press and hold the securing clip and disconnect the processor-power cable (ATX CPU) from the system board.
2. Disconnect the control-signal cable (CTRL) from the system board.
3. Disconnect the system-board power cable (ATX SYS) from the system board.
4. Remove the three screws (M3x5) that secure the power-supply unit to the display-assembly base.
5. Remove the two screws (M3x5) that secure the power-supply connector cable bracket to the display-assembly base.
6. Lift the power-supply unit, its cables, and the power-supply unit connector off the display-assembly base.

## Installing the power-supply unit

### Prerequisites

If you are replacing a component, remove the existing component before performing the installation process.

### About this task

The following image(s) indicate the location of the power-supply unit and provides a visual representation of the installation procedure.



5x  
M3x5

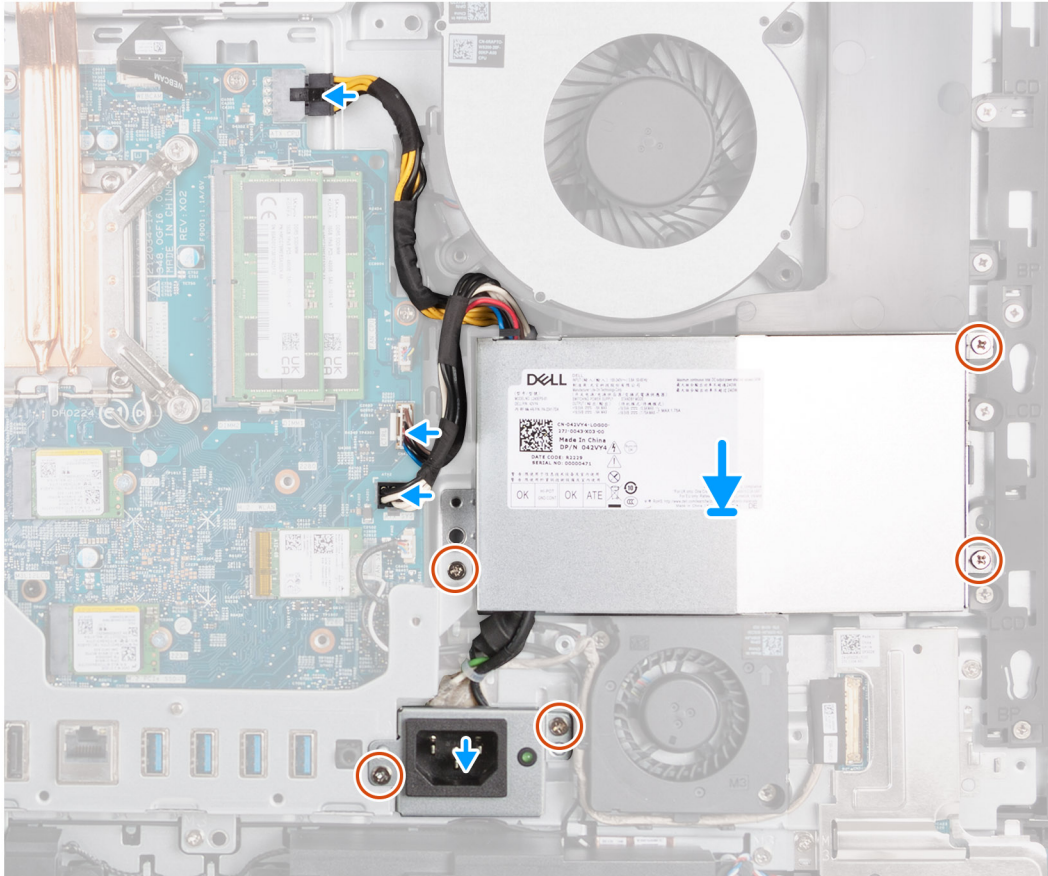
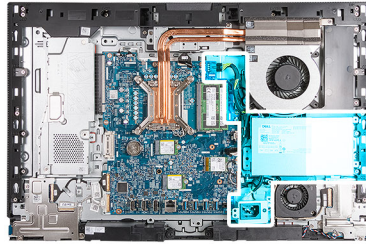

### Steps

1. Place the power-supply unit and the power-supply unit connector on the display-assembly base.
2. Align the screw holes on the power-supply unit with the screw holes on the display-assembly base.
3. Replace the three screws (M3x5) that secure the power-supply unit to the display-assembly base.
4. Align the screw holes on the power-supply connector bracket with the screw holes on the display-assembly base.
5. Replace the two screws (M3x5) that secure the power-supply connector bracket to the display-assembly base.
6. Connect the processor-power cable (ATX CPU) to the system board.
7. Connect the control-signal cable (CTRL) to the system board.
8. Connect the system-board power cable (ATX SYS) to the system board.

### Next steps

1. Install the [I/O cover](#).
2. Install the [system-board shield](#).
3. Install the [back cover](#).
4. Install the [stand](#).
5. Follow the procedure in [After working inside your computer](#).

# Removing and installing Field Replaceable Units (FRUs)

The replaceable components in this chapter are Field Replaceable Units (FRUs).

**CAUTION:** The information in this section is intended for authorized service technicians only.

**CAUTION:** To avoid any potential damage to the component or loss of data, ensure that an authorized service technician replaces the Field Replaceable Units (FRUs).

**CAUTION:** Dell Technologies recommends that this set of repairs, if needed, to be conducted by trained technical repair specialists.

**CAUTION:** As a reminder, your warranty does not cover damages that may occur during the courses of FRU repairs that are not authorized by Dell Technologies.

**NOTE:** The images in this document may differ from your computer depending on the configuration you ordered.

## Power-supply fan

### Removing the power-supply fan

#### Prerequisites

1. Follow the procedure in [Before working inside your computer](#).
2. Remove the [stand](#).
3. Remove the [back cover](#).
4. Remove the [system-board shield](#).
5. Remove the [I/O cover](#).
6. Remove the [power-supply unit](#).
7. Remove the [bottom cover](#).

#### About this task

The following image(s) indicate the location of the power-supply fan and provides a visual representation of the removal procedure.

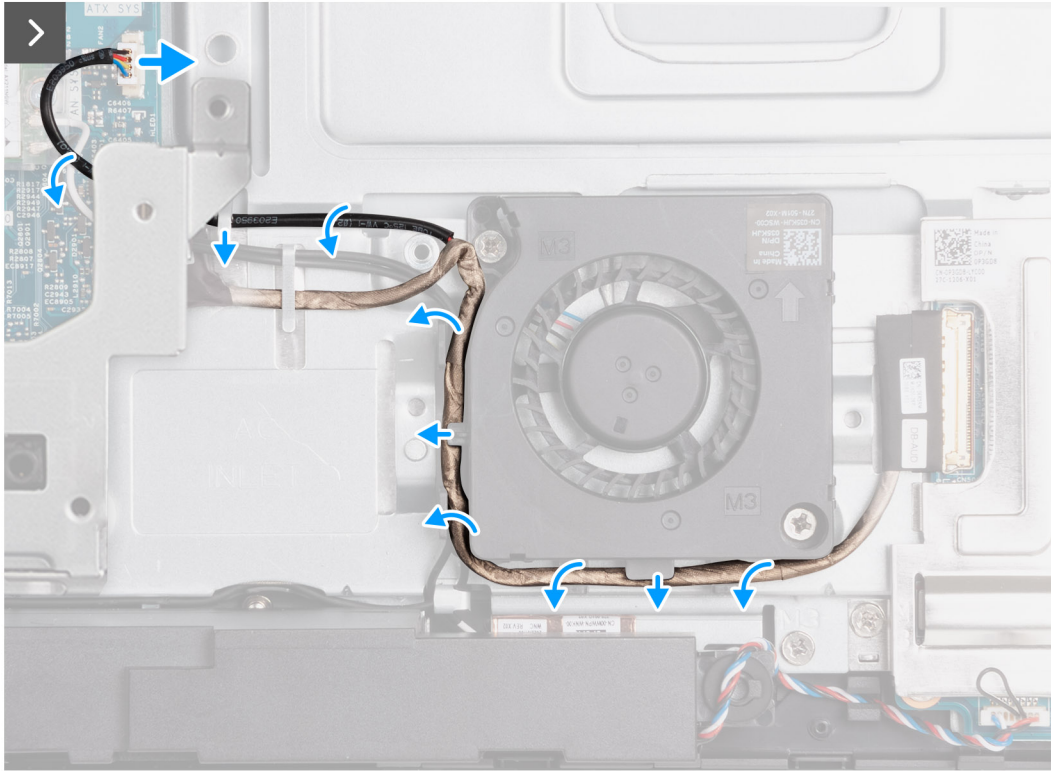
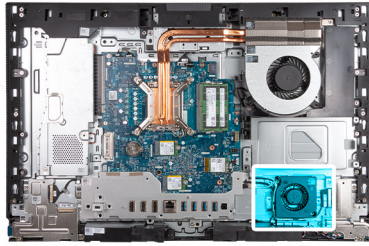

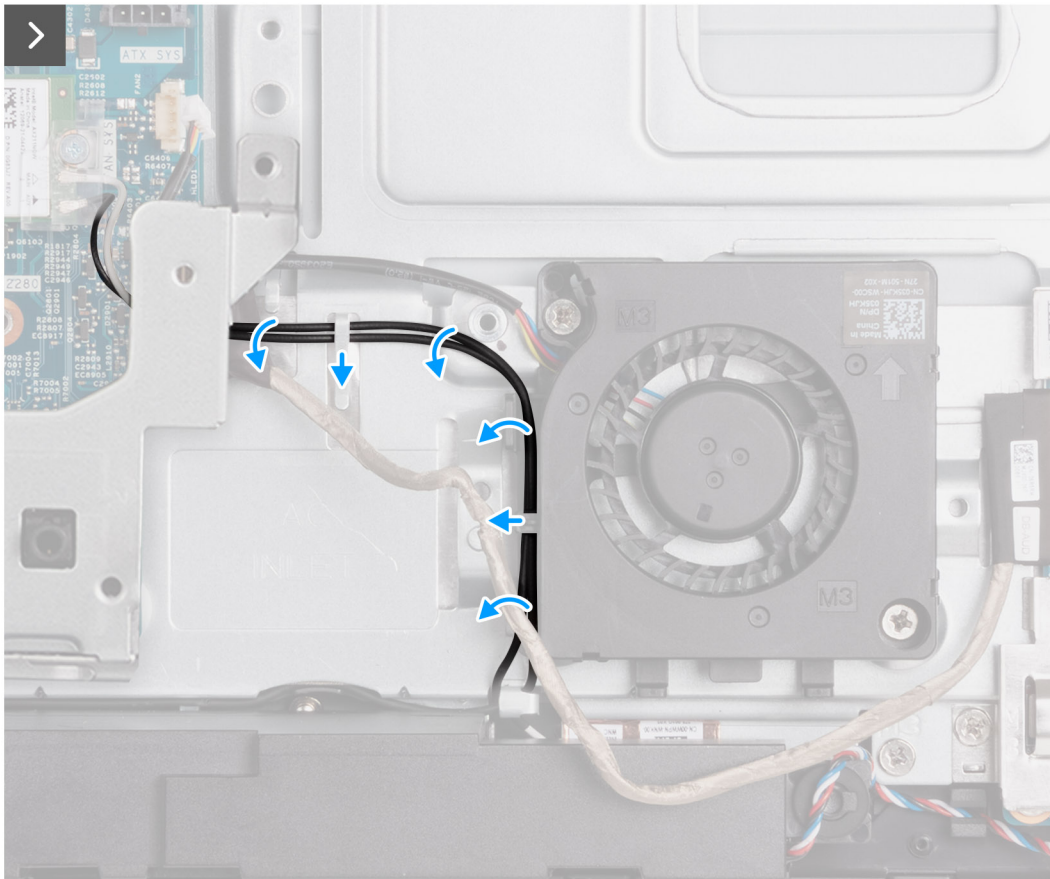



2x  
M3x5

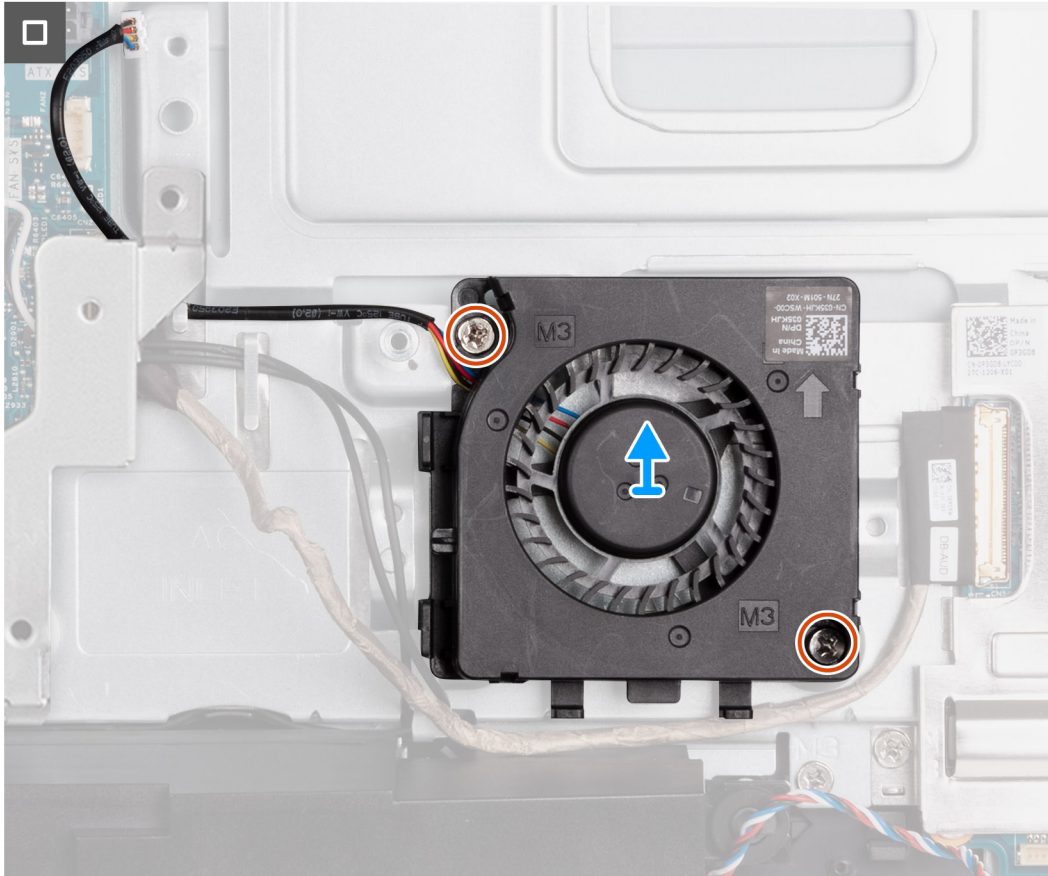

### Steps

1. Disconnect the power-supply fan cable (FAN SYS) from the system board.
2. Thread the power-supply fan cable under the I/O bracket and remove the power-supply fan cable from the routing guide on the display-assembly base.
3. Remove the audio-board cable from the routing guides on the display-assembly base and the power-supply fan.
4. Remove the antenna cables from the routing guides on the display-assembly base and the power-supply fan.
5. Remove the two screws (M3x5) that secure the power-supply fan to the display-assembly base.
6. Lift the power-supply fan off the display-assembly base.

## Installing the power-supply fan

### Prerequisites

If you are replacing a component, remove the existing component before performing the installation process.

### About this task

The following image(s) indicate the location of the power-supply fan and provides a visual representation of the installation procedure.



2x  
M3x5

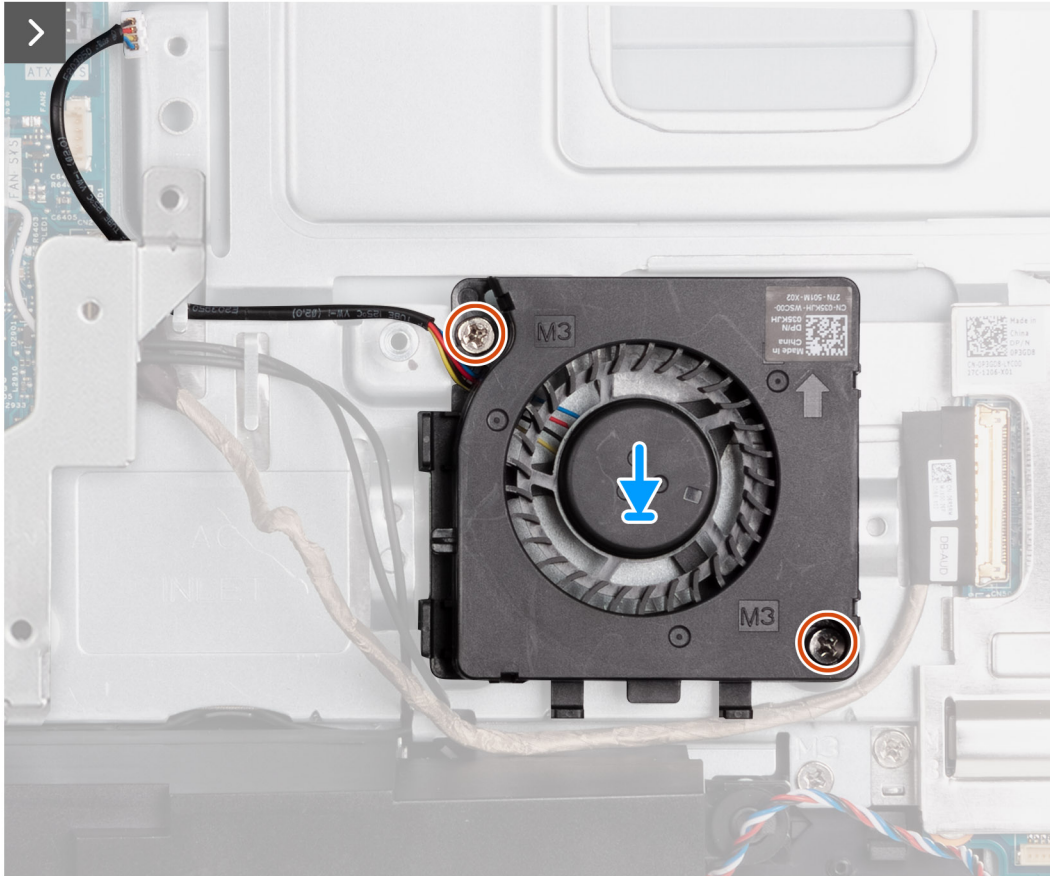
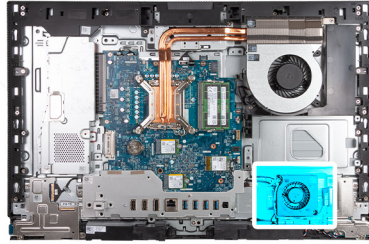



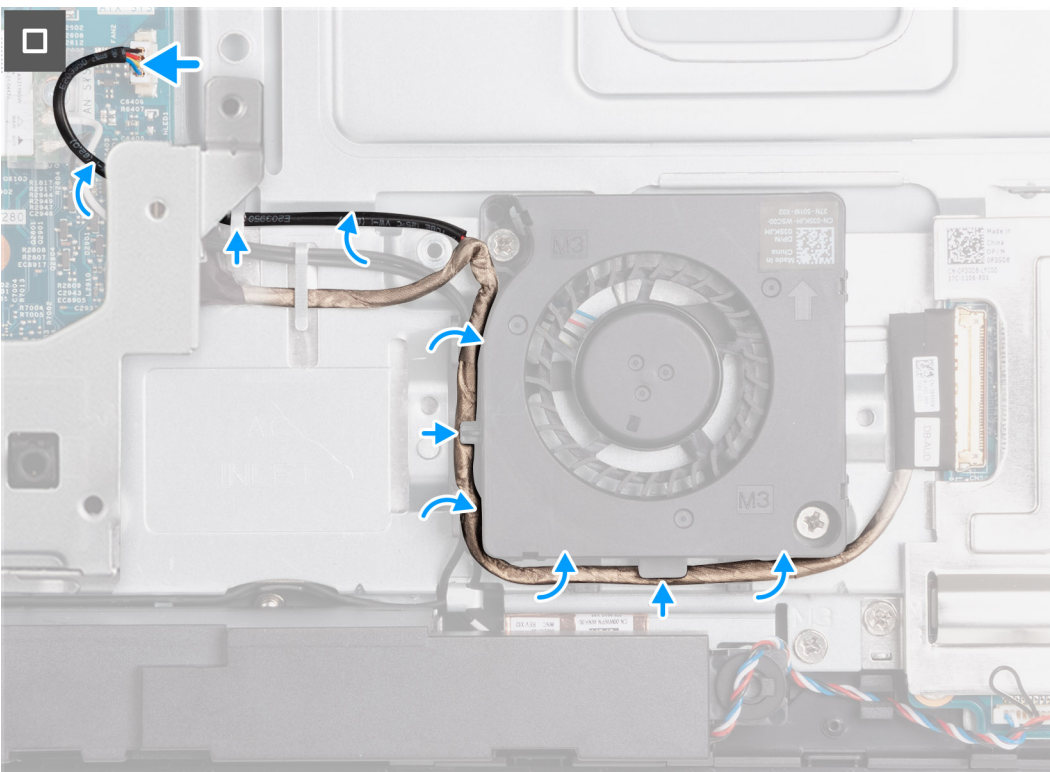
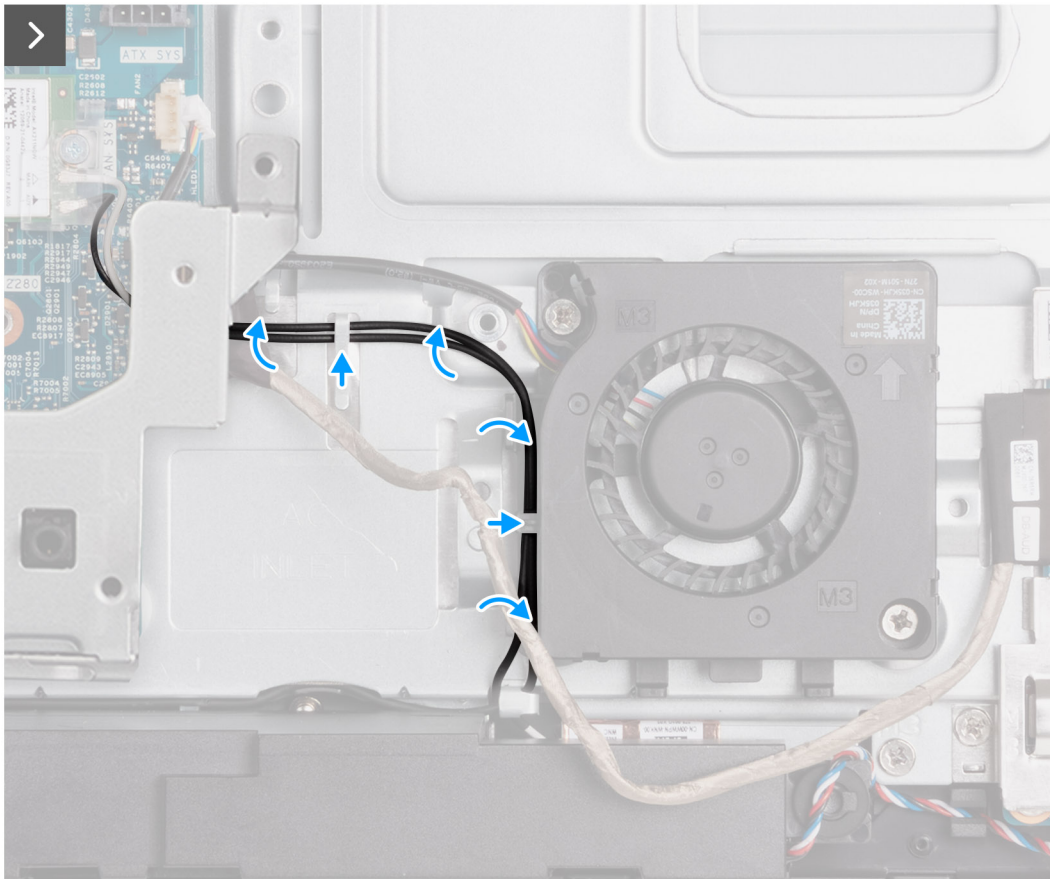

### Steps

1. Place the power-supply fan on the display-assembly base.
2. Align the screw holes on the power-supply fan with the screw holes on the display-assembly base.
3. Replace the two screws (M3x5) that secure the power-supply fan to the display-assembly base.

4. Route the antenna cables through the routing guides on the display-assembly base and the power-supply fan.
5. Route the audio-board cable through the routing guides on the display-assembly base and the power-supply fan.
6. Thread the power-supply fan cable under the I/O bracket and route the power-supply fan cable through the routing guide on the display-assembly base.
7. Connect the power-supply fan cable (FAN SYS) to the system board.

**Next steps**

1. Install the [bottom cover](#).
2. Install the [power-supply unit](#).
3. Install the [I/O cover](#).
4. Install the [system-board shield](#).
5. Install the [back cover](#).
6. Install the [stand](#).
7. Follow the procedure in [After working inside your computer](#).

## I/O bracket

### Removing the I/O bracket

**Prerequisites**

1. Follow the procedure in [Before working inside your computer](#).
2. Remove the [stand](#).
3. Remove the [back cover](#).
4. Remove the [system-board shield](#).
5. Remove the [I/O cover](#).
6. Remove the [bottom cover](#).

**About this task**

The following image(s) indicate the location of the I/O bracket and provides a visual representation of the removal procedure.



**4x**  
M3x5

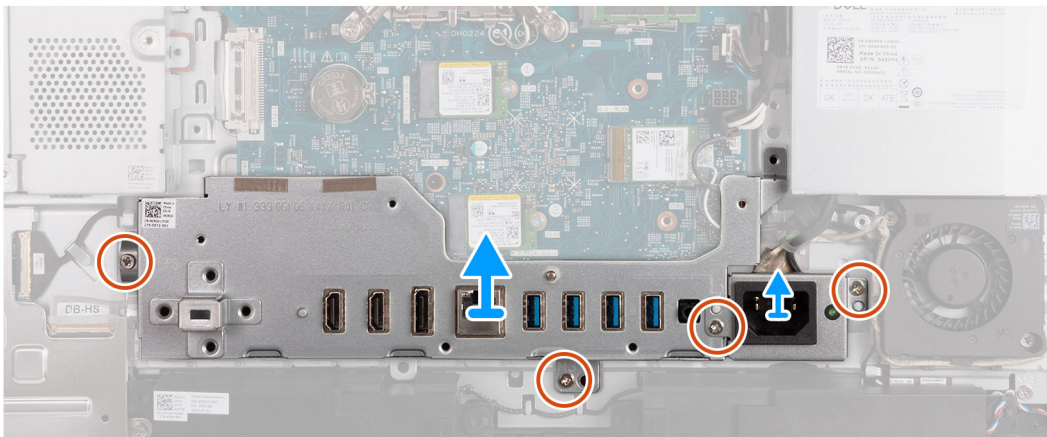
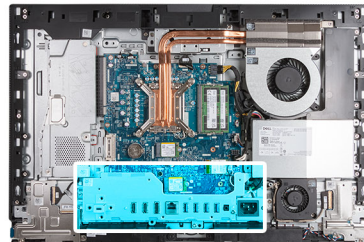

## Steps

1. Remove the two screws (M3x5) that secure the power-supply cable connector bracket to the display-assembly base.
2. Lift the power-supply cable connector bracket off the display-assembly base.
3. Remove the two screws (M3x5) that secure the I/O bracket to the display-assembly base.
4. Lift the I/O bracket off the display-assembly base.

## Installing the I/O bracket

### Prerequisites

If you are replacing a component, remove the existing component before performing the installation process.

### About this task

The following image(s) indicate the location of the I/O bracket and provides a visual representation of the installation procedure.



4x  
M3x5

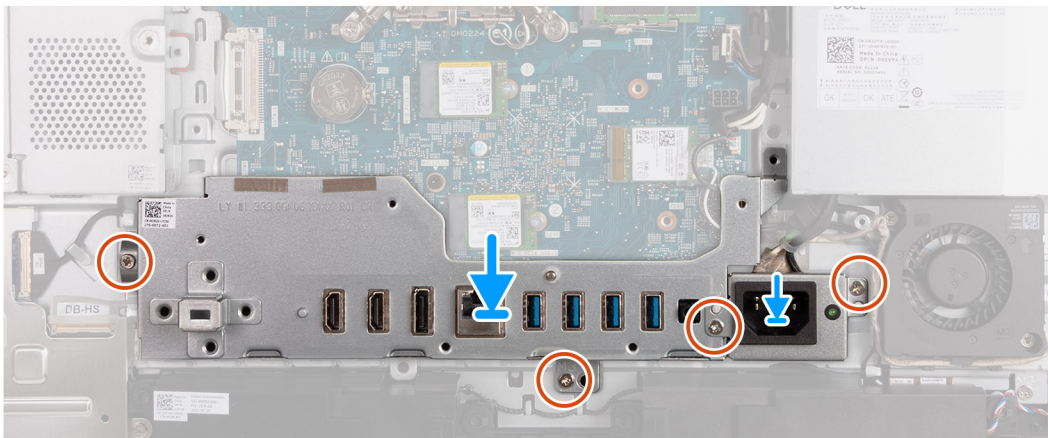
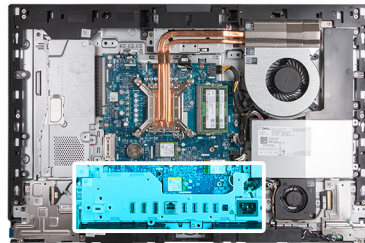

## Steps

1. Place and align the I/O bracket with the display-assembly base.
2. Align the I/O slots to the I/O ports and the screw holes on the I/O bracket with the screw holes on the display-assembly base.
3. Replace the two screws (M3x5) that secure the I/O cover to the display-assembly base.
4. Place the power-supply connector cable bracket on the display-assembly base.
5. Align the power-supply cable connector bracket screw holes with the screw holes on the display-assembly base.
6. Replace the two screws (M3x5) that secure the power-supply cable connector bracket to the display-assembly base.

## Next steps

1. Install the [bottom cover](#).
2. Install the [I/O cover](#).
3. Install the [system-board shield](#).
4. Install the [back cover](#).
5. Install the [stand](#).
6. Follow the procedure in [After working inside your computer](#).

# Speakers

## Removing the speakers

### Prerequisites

1. Follow the procedure in [Before working inside your computer](#).
2. Remove the [stand](#).
3. Remove the [back cover](#).
4. Remove the [system-board shield](#).
5. Remove the [I/O cover](#).
6. Remove the [bottom cover](#).

### About this task

The following image(s) indicate the location of the speakers and provides a visual representation of the removal procedure.

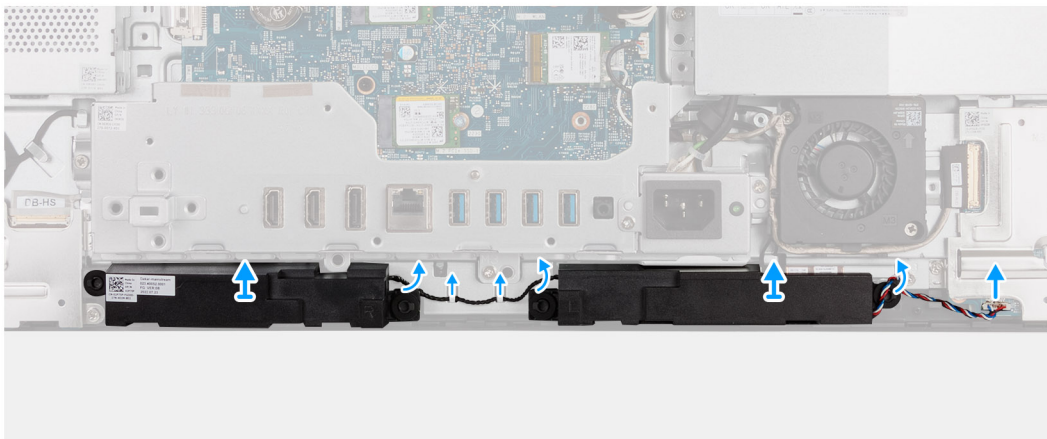
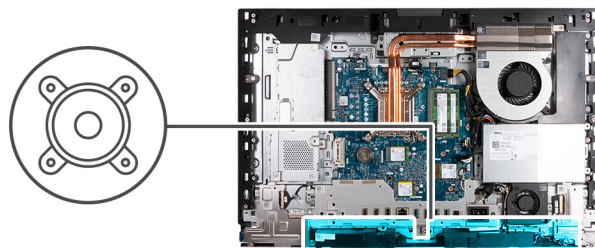

### Steps

1. Disconnect the speaker cable (INT SPKR) from the audio board.
2. Remove the speaker cable from its routing guides on the display-assembly base.
3. Lift the speakers and its cable off the display-assembly base.

## Installing the speakers

### Prerequisites

If you are replacing a component, remove the existing component before performing the installation process.

### About this task

The following image(s) indicate the location of the speakers and provides a visual representation of the installation procedure.

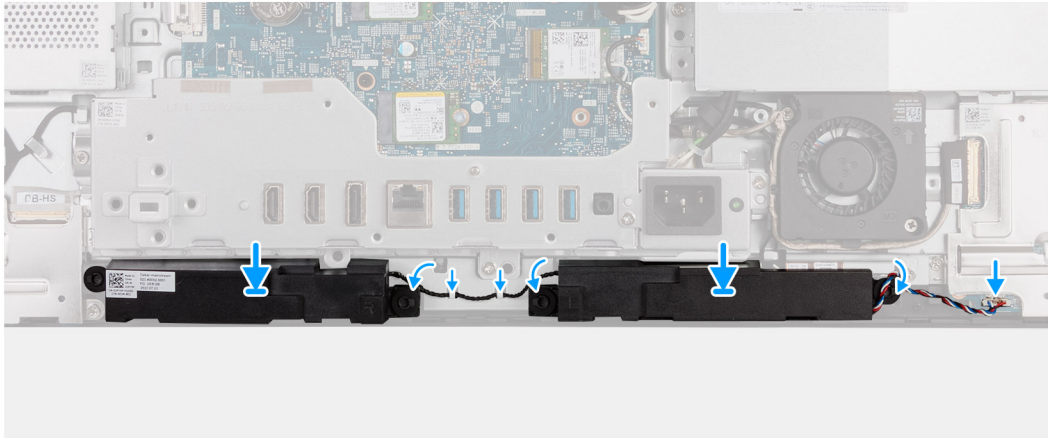
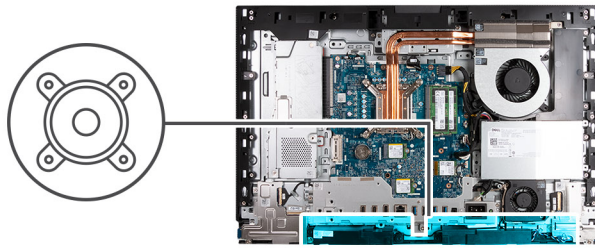

### Steps

1. Insert the speakers into their slots on the display-assembly base.
2. Route the speaker cable through the routing guides on the display-assembly base.
3. Connect the speaker cable (INT SPKR) to the audio board.

### Next steps

1. Install the [bottom cover](#).
2. Install the [I/O cover](#).
3. Install the [system-board shield](#).
4. Install the [back cover](#).
5. Install the [stand](#).
6. Follow the procedure in [After working inside your computer](#).

## Heat sink

### Removing the heat sink

#### Prerequisites

1. Follow the procedure in [Before working inside your computer](#).
2. Remove the [stand](#).
3. Remove the [back cover](#).
4. Remove the [system-board shield](#).

#### About this task

- NOTE:** The heat sink may become hot during normal operation. Allow sufficient time for the heat sink to cool before you touch it.
- NOTE:** For maximum cooling of the processor, do not touch the heat transfer areas on the heat sink. The oils in your skin can reduce the heat transfer capability of the thermal grease.

The following image(s) indicate the location of the heat sink and provides a visual representation of the removal procedure.



5x

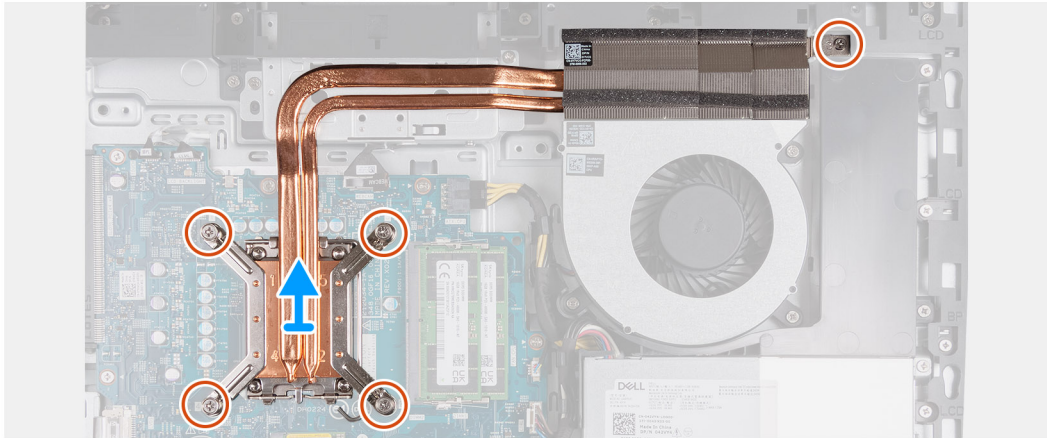
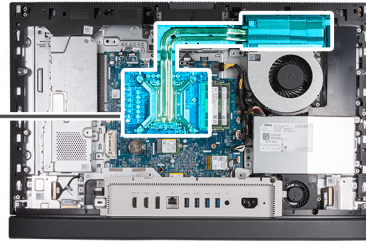

### Steps

1. In reverse sequential order (5>4>3>2>1) loosen the five captive screws that secure the heat sink to the system board and display-assembly base.
2. Lift the heat sink off the display assembly base.

## Installing the heat sink

### Prerequisites

If you are replacing a component, remove the existing component before performing the installation process.

### About this task

**NOTE:** If either the processor or the fan and heat sink is replaced, use the thermal grease provided in the kit to ensure that thermal conductivity is achieved.

The following image(s) indicate the location of the heat sink and provides a visual representation of the installation procedure.



5x

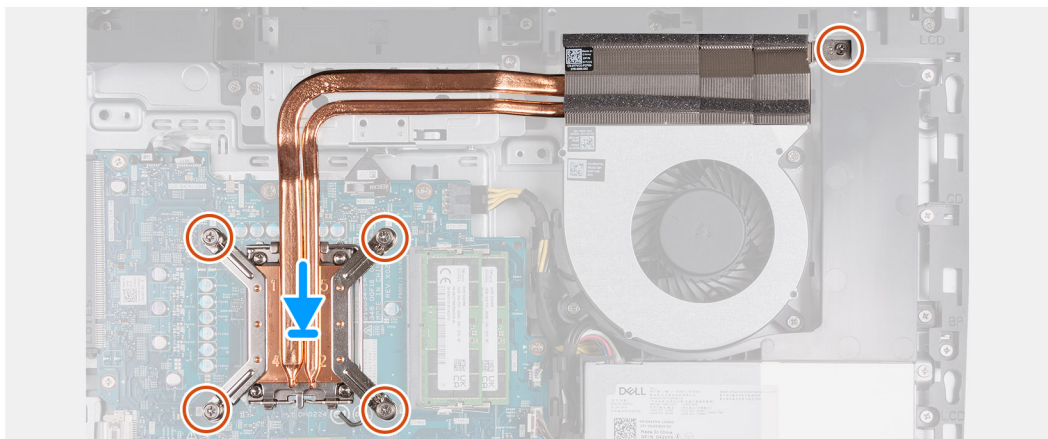
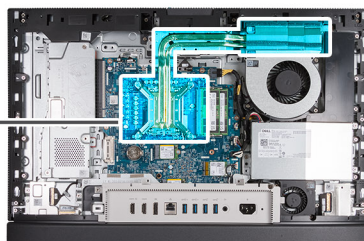

### Steps

1. Place the heat sink on the system board and the display-assembly base.
2. Align the screws on the heatsink with the screw holes on system board and the display-assembly base.
3. In sequential order (1>2>3>4>5) tighten the five captive screws that secure the heat sink to the system board and display-assembly base.

### Next steps

1. Install the [system-board shield](#).
2. Install the [back cover](#).
3. Install the [stand](#).
4. Follow the procedure in [After working inside your computer](#).

## Processor

### Removing the processor

#### Prerequisites

1. Follow the procedure in [Before working inside your computer](#).
2. Remove the [stand](#).
3. Remove the [back cover](#).
4. Remove the [system-board shield](#).
5. Remove the [heat sink](#).

#### About this task

**i NOTE:** The processor may become hot during normal operation. Allow sufficient time for the processor to cool before you touch it.

**i NOTE:** For maximum cooling of the processor, do not touch the heat transfer areas on the processor. The oils in your skin can reduce the heat transfer capability of the thermal grease.

The following image(s) indicate the location of the processor and provides a visual representation of the removal procedure.

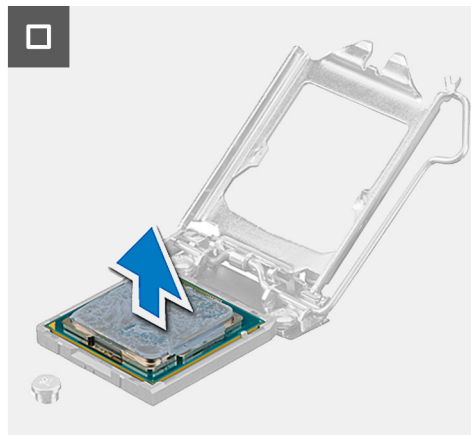
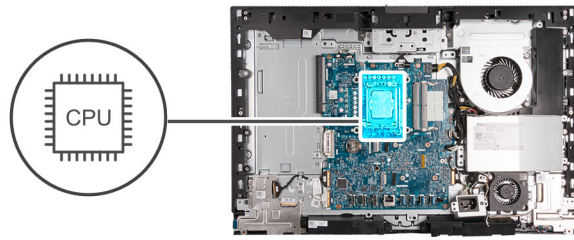

### Steps

1. Press the release lever down and then push it away from the processor to release it from the securing tab.
2. Extend the release lever completely and open the processor cover.

**CAUTION:** When removing the processor, do not touch any of the pins inside the socket or allow any objects to fall on the pins in the socket.

3. Gently lift the processor from the processor socket.

## Installing the processor

### Prerequisites

If you are replacing a component, remove the existing component before performing the installation process.

### About this task

**NOTE:** If either the processor or the fan and heat sink is replaced, use the thermal grease provided in the kit to ensure that thermal conductivity is achieved.

The following image(s) indicate the location of the processor and provides a visual representation of the installation procedure.



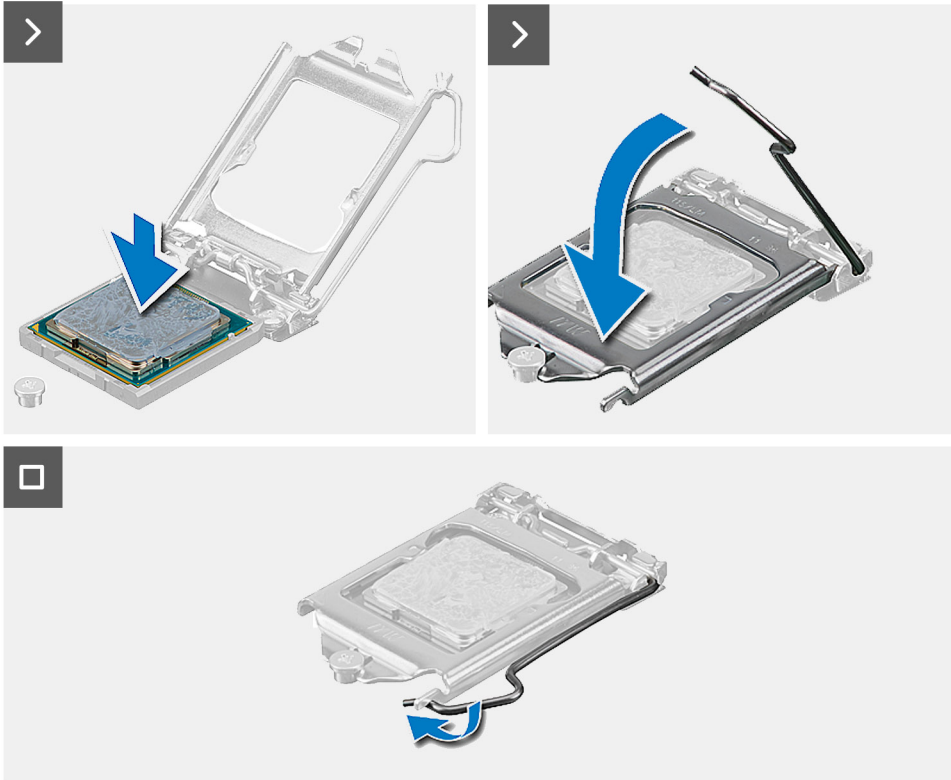
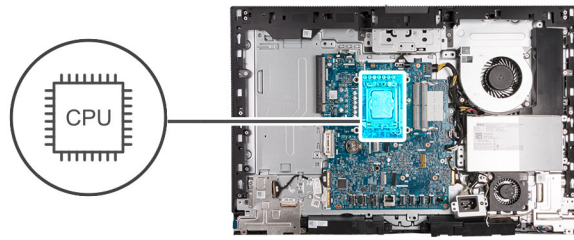

### Steps

1. Ensure that the release lever on the processor socket is fully extended in the open position.
  - i** **NOTE:** The pin-1 corner of the processor has a triangle that aligns with the triangle on the pin-1 corner on the processor socket. When the processor is properly seated, all four corners are aligned at the same height. If one or more corners of the processor are higher than the others, the processor is not seated properly.
2. Align the notches on the processor with the tabs on the processor socket and place the processor in the processor socket.
  - ⚠** **CAUTION:** Ensure that the processor-cover notch is positioned underneath the alignment post.
3. When the processor is fully seated in the socket, pivot the release-lever down and place it under the tab on the processor cover.

### Next steps

1. Install the [heat sink](#).
2. Install the [system-board shield](#).
3. Install the [back cover](#).
4. Install the [stand](#).
5. Follow the procedure in [After working inside your computer](#).

# System board

## Removing the system board

### Prerequisites

1. Follow the procedure in [Before working inside your computer](#).
2. Remove the [stand](#).
3. Remove the [back cover](#).
4. Remove the [memory](#).
5. Remove the [system-board shield](#).
6. Remove the [I/O cover](#).
7. Remove the [bottom cover](#).
8. Remove the [I/O bracket](#).
9. Remove the [M.2 2230 solid-state drive in M.2 slot 0](#) or the [M.2 2280 solid-state drive in M.2 slot 0](#), whichever applicable.
10. Remove the [M.2 2230 solid-state drive in M.2 slot 1](#) or the [M.2 2280 solid-state drive in M.2 slot 1](#), whichever applicable.
11. Remove the [wireless card](#).
12. Remove the [heat sink](#).
13. Remove the [processor](#).

### About this task

 **NOTE:** Replacing the system board removes any changes that you have made to the BIOS using the BIOS setup program. Make the appropriate changes again after you replace the system board.

The following image indicates the connectors on your system-board.

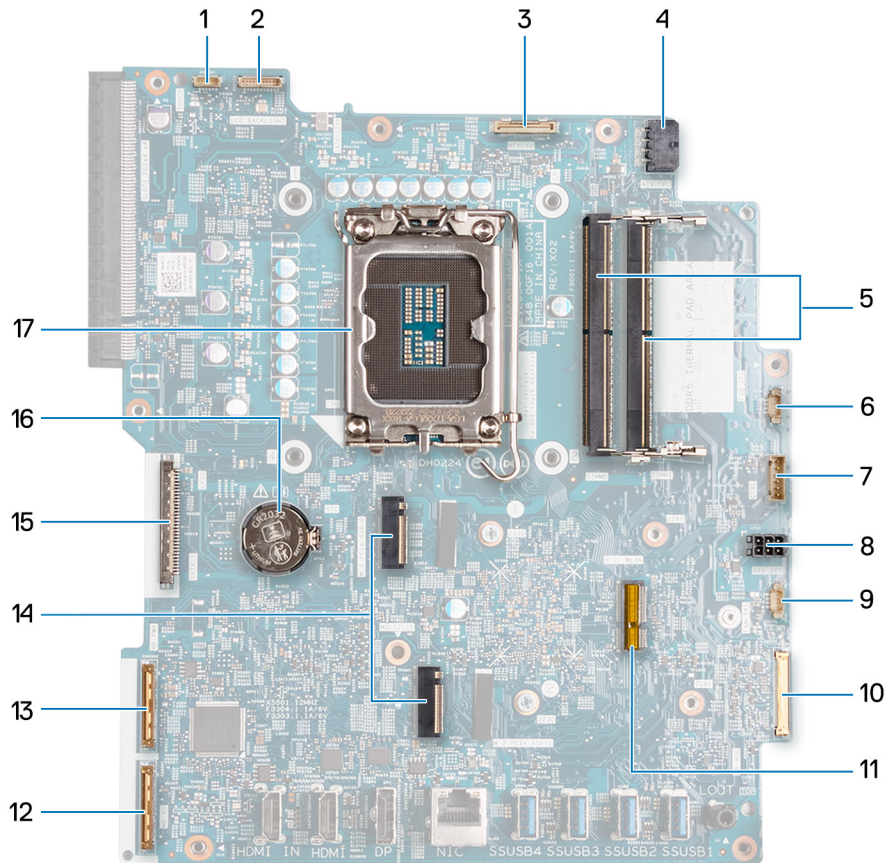

1. Touchscreen cable (TOUCH)
2. Display-backlight cable (LCD BACKLIGHT)
3. Camera cable (WEBCAM)
4. Processor-power cable (ATX CPU)
5. Memory slots (DIMM1 + DIMM2)
6. Fan cable (FAN CPU)
7. Control-signal cable (CTRL)
8. System-board power cable (ATX SYS)
9. Power-supply fan cable (FAN SYS)
10. audio cable (MB-AUDIO)
11. Wireless-card slot (M.2 WLAN)
12. high-speed cable (MB-HS)
13. power cable (MB-PWR)
14. Solid-state drive slots (M.2 PCIe SSD 1 + M.2 PCIe SSD 0)
15. Display cable (CVDS)
16. Coin-cell battery socket (RTC)
17. Processor socket (CPU)

The following image(s) indicate the location of the system board and provides a visual representation of the removal procedure.

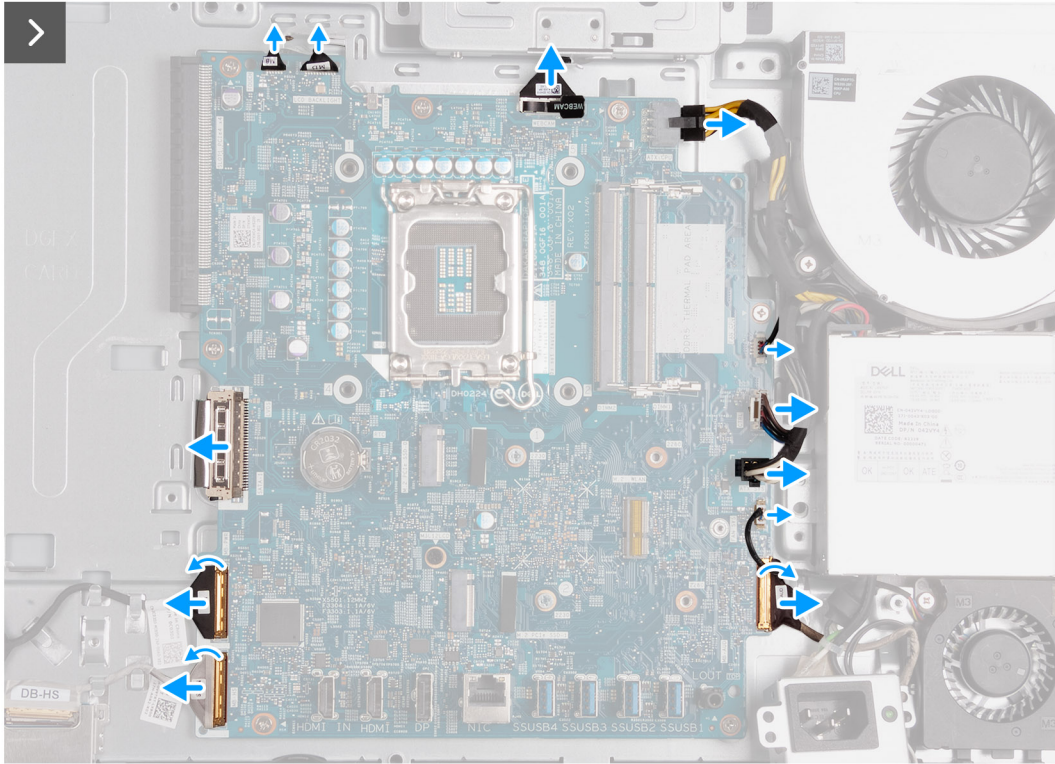
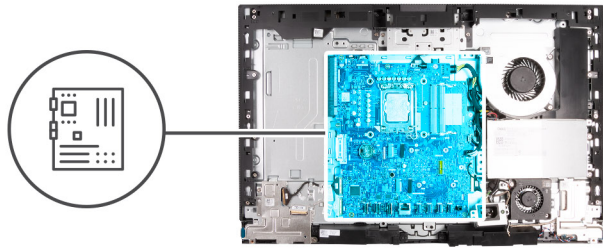



7x  
M3x5



1x  
M3x12

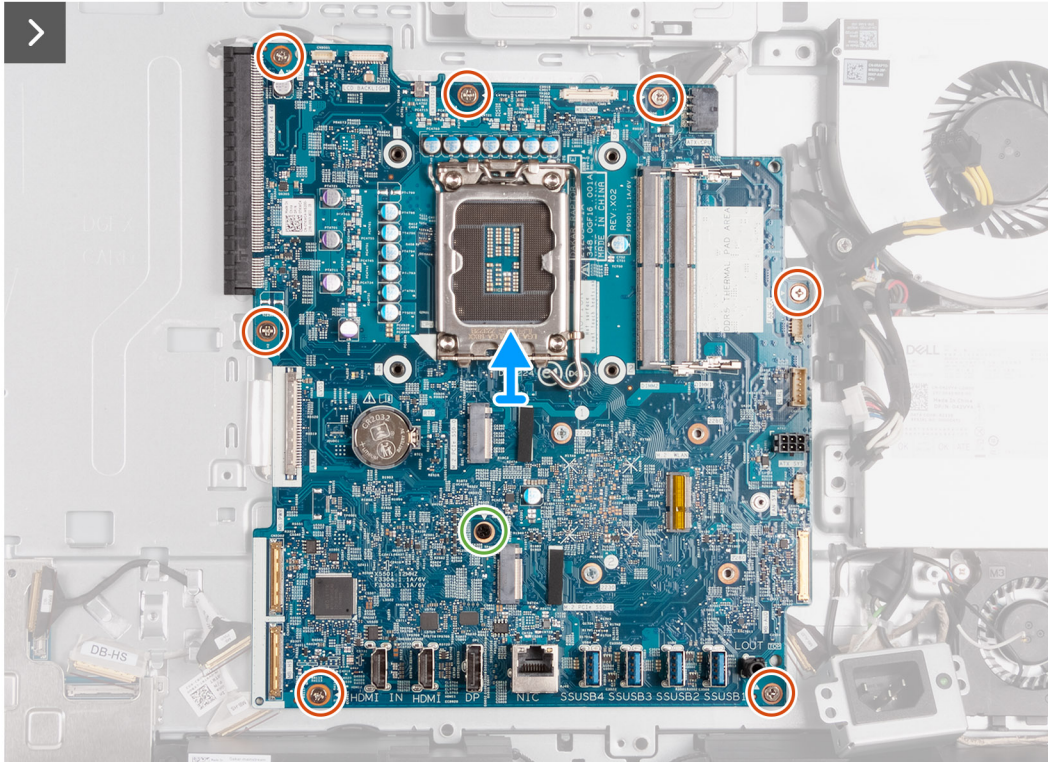

### Steps

1. Disconnect the touchscreen cable (TOUCH) from the system board.
2. Disconnect the display-backlight cable (LCB BACKLIGHT) from the system board.
3. Using the pull tab, disconnect the camera cable (WEBCAM) from the system board.
4. Press and hold the securing clip and disconnect the processor-power cable (ATX CPU) from the system board.
5. Disconnect the fan cable (FAN CPU) from the system board.
6. Disconnect the control-signal cable (CTRL) from the system board.
7. Disconnect the system-board power cable (ATX SYS) from the system board.
8. Disconnect the power-supply fan cable (FAN SYS) from the system board.
9. Lift the latch and disconnect the audio cable (MB-AUDIO) from the system board.
10. Lift the latch and disconnect the high-speed cable (MB-HS) from the system board.
11. Lift the latch and disconnect the power cable (MB-PWR) from the system board.
12. Pinching the securing clips on either side of the hard-drive cable connector, disconnect the display cable (CVDS) from the system board.
13. Remove the seven screws (M3x5) that secure the system board to the display-assembly base.
14. Remove the screw (M3x12) that secures the system board to the display-assembly base.
15. Gently lift the system board off the display-assembly base.

# Installing the system board

## Prerequisites

If you are replacing a component, remove the existing component before performing the installation process.

## About this task

**NOTE:** Replacing the system board removes any changes that you have made to the BIOS using the BIOS setup program. Make the appropriate changes again after you replace the system board.

The following image indicates the connectors on your system-board.

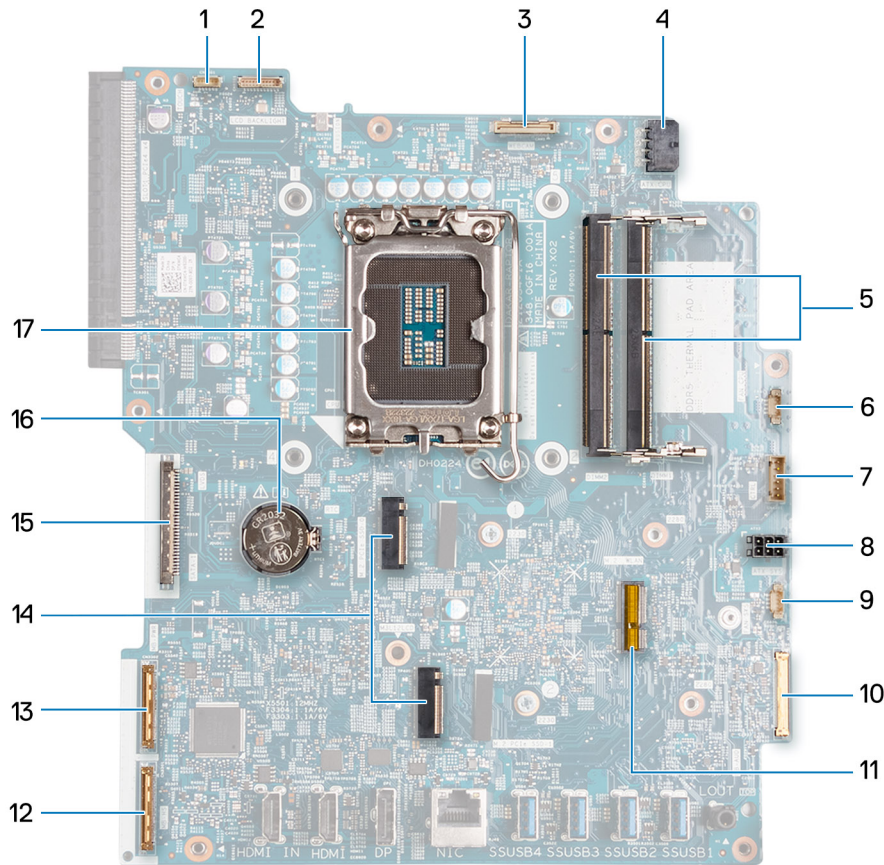

1. Touchscreen cable (TOUCH)
2. Display-backlight cable (LCD BACKLIGHT)
3. Camera cable (WEBCAM)
4. Processor-power cable (ATX CPU)
5. Memory slots (DIMM1 + DIMM2)
6. Fan cable (FAN CPU)
7. Control-signal cable (CTRL)
8. System-board power cable (ATX SYS)
9. Power-supply fan cable (FAN SYS)
10. audio cable (MB-AUDIO)
11. Wireless-card slot (M.2 WLAN)
12. high-speed cable (MB-HS)
13. power cable (MB-PWR)

- 14. Solid-state drive slots (M.2 PCIe SSD 1 + M.2 PCIe SSD 0)
- 15. Display cable (CVDS)
- 16. Coin-cell battery socket (RTC)
- 17. Processor socket (CPU)

The following image(s) indicate the location of the system board and provides a visual representation of the installation procedure.

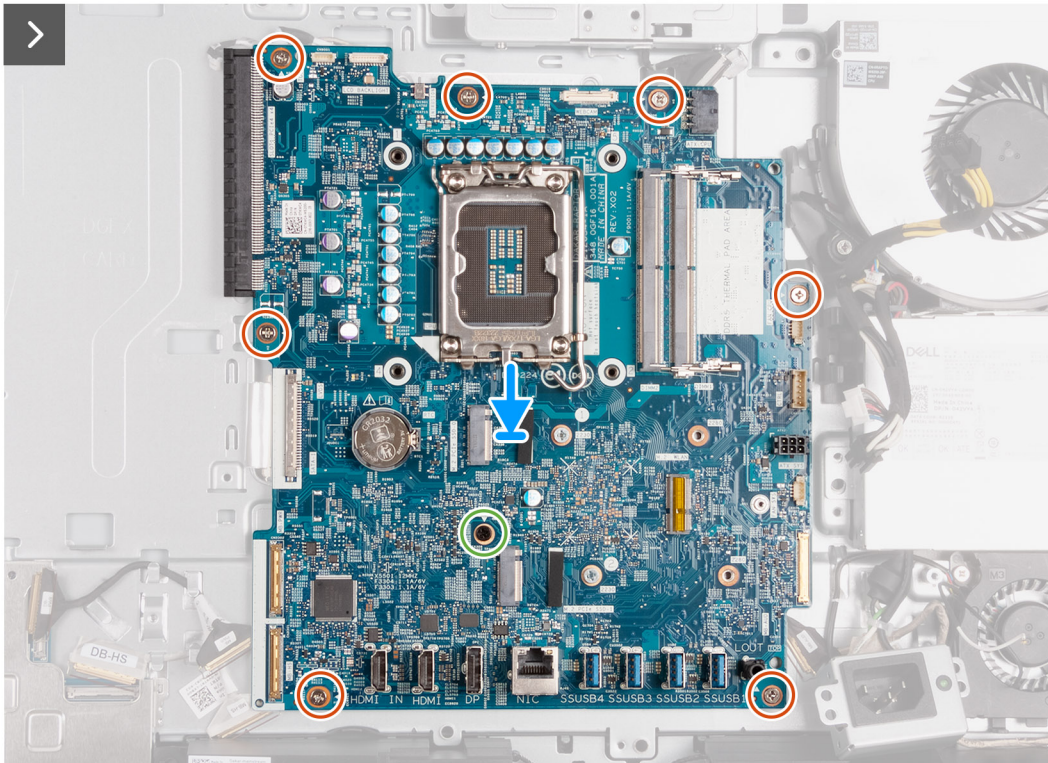
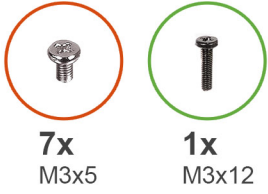

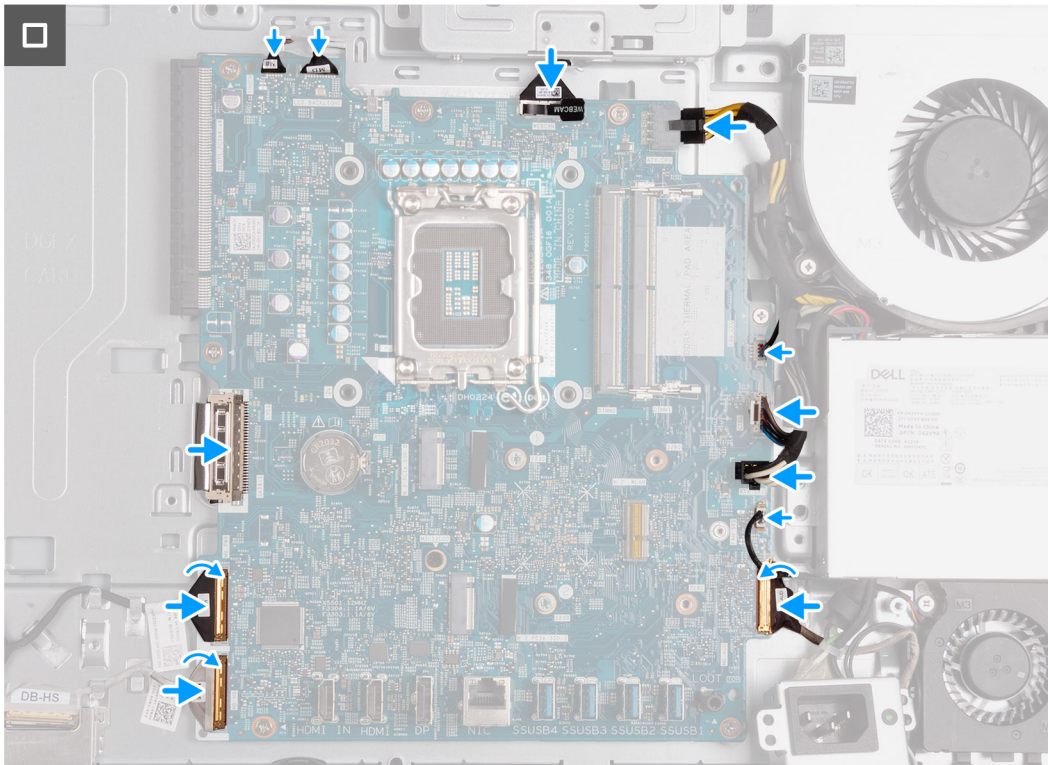

### Steps

1. Gently place the system board on the display-assembly base.
2. Align the screw holes on the system board with the screw holes on the display-assembly base.
3. Replace the seven screws (M3x5) that secure the system board to the display-assembly base.
4. Replace the screw (M3x12) that secures the system board to the display-assembly base.
5. Connect the touchscreen cable (TOUCH) to the system board.
6. Connect the display-backlight cable (LCB BACKLIGHT) to the system board.
7. Connect the camera cable (WEBCAM) to the system board.
8. Connect the processor-power cable (ATX CPU) to the system board.
9. Connect the fan cable (FAN CPU) to the system board.
10. Connect the control-signal cable (CTRL) to the system board.
11. Connect the system-board power cable (ATX SYS) to the system board.
12. Connect the power-supply fan cable (FAN SYS) to the system board.
13. Connect the audio cable (MB-AUDIO) to the system board and close the latch.
14. Connect the high-speed cable (MB-HS) to the system board and close the latch.
15. Connect the power cable (MB-PWR) to the system board and close the latch.
16. Connect the display cable (CVDS) to the system board.

### Next steps

1. Install the [processor](#).
2. Install the [heat sink](#).
3. Install the [wireless card](#).
4. Install the [M.2 2230 solid-state drive in M.2 slot 0](#) or the [M.2 2280 solid-state drive in M.2 slot 0](#), whichever applicable.
5. Install the [M.2 2230 solid-state drive in M.2 slot 1](#) or the [M.2 2280 solid-state drive in M.2 slot 1](#), whichever applicable.
6. Install the [I/O bracket](#).
7. Install the [bottom cover](#).
8. Install the [I/O cover](#).
9. Install the [system-board shield](#).
10. Install the [memory](#).



11. Install the [back cover](#).
12. Install the [stand](#).
13. Follow the procedure in [After working inside your computer](#).

## Power-button and I/O board

### Removing the power-button and I/O board

#### Prerequisites

1. Follow the procedure in [Before working inside your computer](#).
2. Remove the [stand](#).
3. Remove the [back cover](#).
4. Remove the [system-board shield](#).
5. Remove the [I/O cover](#).
6. Remove the [bottom cover](#).
7. Remove the [I/O bracket](#).

#### About this task

The following image(s) indicate the location of the power-button and I/O board and provides a visual representation of the removal procedure.



5x  
M3x5

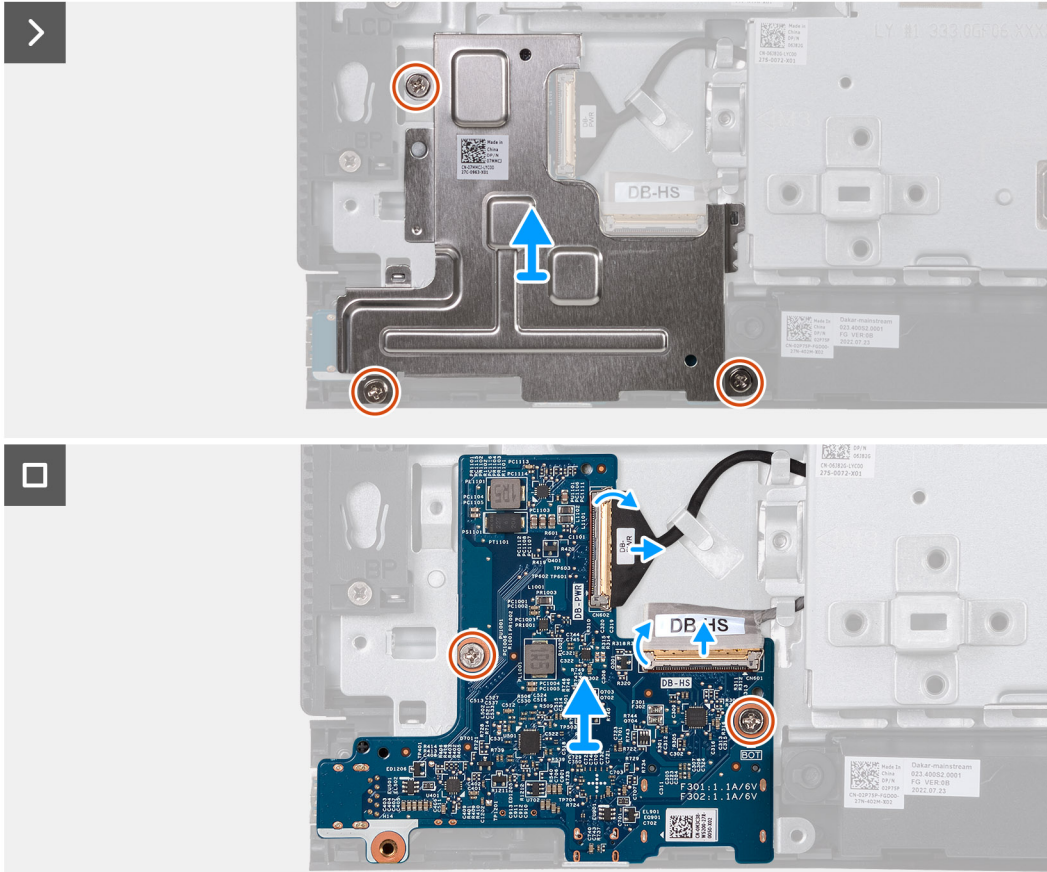
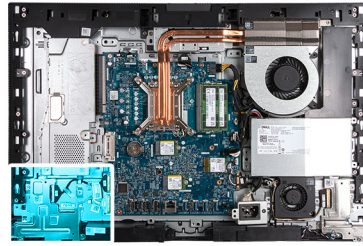

### Steps

1. Remove the three screws (M3x5) that secure the power-button and I/O board shield to the display-assembly base.
2. Lift the power-button and I/O board shield off the display-assembly base.
3. Lift the latch and disconnect the power cable (DB-PWR) from the power-button and I/O board.
4. Lift the latch and disconnect the high-speed cable (DB-HS) from the power-button and I/O board.
5. Remove the two screws (M3x5) that secure the power-button and I/O board to the display-assembly base.
6. Lift the power-button and I/O board off the display-assembly base.

## Installing the power-button and I/O board

### Prerequisites

If you are replacing a component, remove the existing component before performing the installation process.

### About this task

The following image(s) indicate the location of the power-button and I/O board and provides a visual representation of the installation procedure.



5x  
M3x5

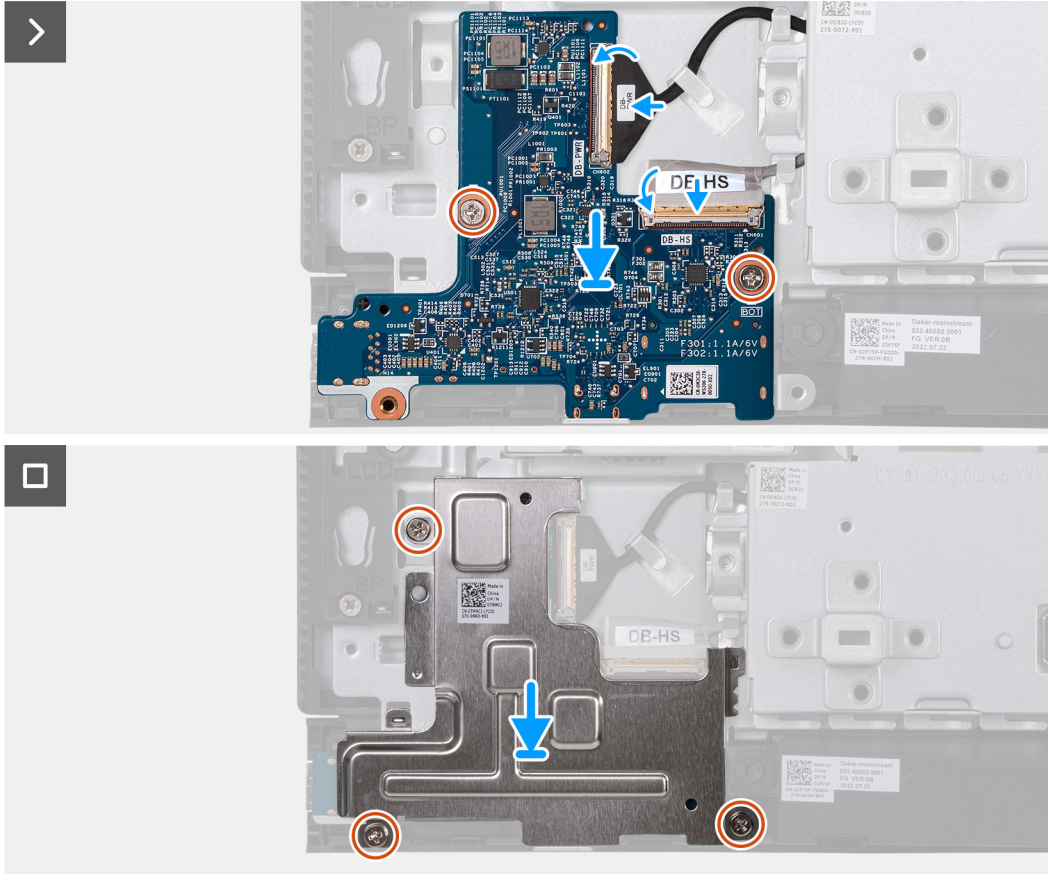
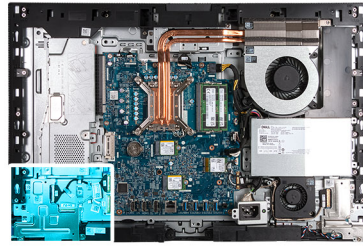

### Steps

1. Place the power-button and I/O board on the display-assembly base.
2. Align the screw holes on the power-button and I/O board with the screw holes on the display-assembly base.
3. Replace the two screws (M3x5) that secure the power-button and I/O board to the display-assembly base.
4. Connect the power cable (DB-PWR) to the power-button and I/O board and close the latch.
5. Connect the high-speed cable (DB-PWR) to the power-button and I/O board and close the latch.
6. Place the power-button and I/O board shield on the display-assembly base.
7. Align the screw holes on the power-button and I/O board shield with the screw holes on the display-assembly base.
8. Replace the three screws (M3x5) that secure the power-button and I/O board shield to the display-assembly base.

### Next steps

1. Install the [I/O bracket](#).
2. Install the [bottom cover](#).
3. Install the [I/O cover](#).
4. Install the [system-board shield](#).
5. Install the [back cover](#).
6. Install the [stand](#).
7. Follow the procedure in [After working inside your computer](#).

# Audio board

## Removing the audio board

### Prerequisites

1. Follow the procedure in [Before working inside your computer](#).
2. Remove the [stand](#).
3. Remove the [back cover](#).
4. Remove the [system-board shield](#).
5. Remove the [I/O cover](#).
6. Remove the [bottom cover](#).
7. Remove the [I/O bracket](#).

### About this task

The following image(s) indicate the location of the audio board and provides a visual representation of the removal procedure.



5x  
M3x5

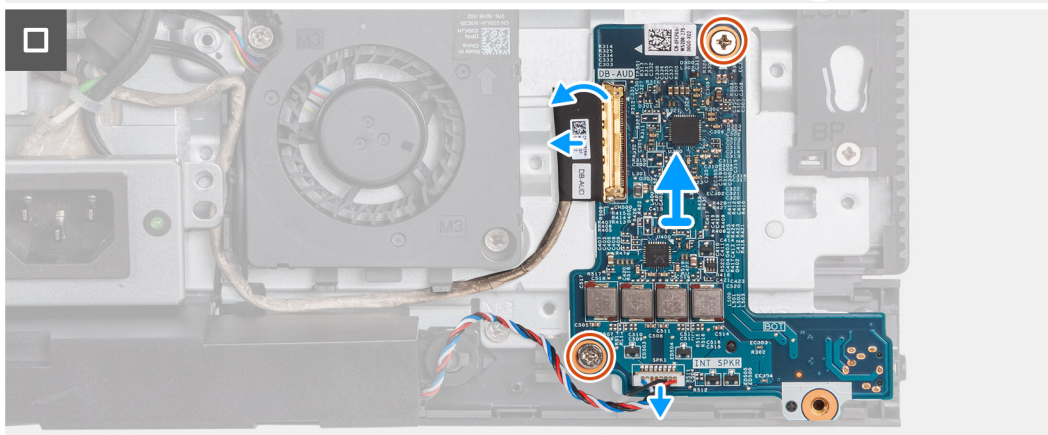
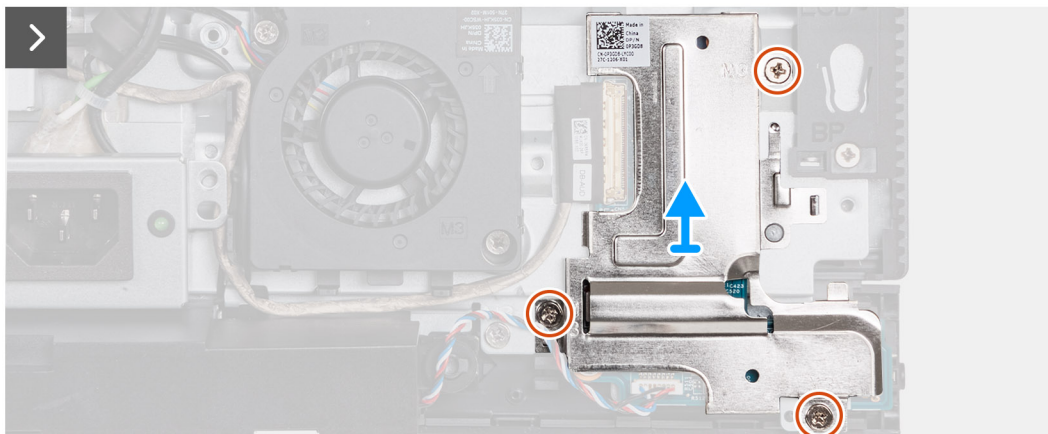
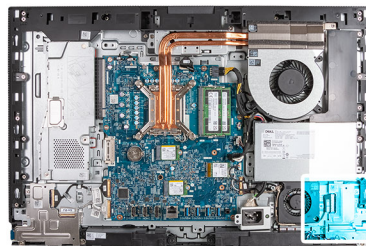

### Steps

1. Remove the three screws (M3x5) that secure the audio board shield to the display-assembly base.

2. Lift the audio-board shield off the display-assembly base.
3. Lift the latch and disconnect the audio cable (DB-AUDIO) from the audio board.
4. Disconnect the speaker cable (INT SPKR) from the audio board.
5. Remove the two screws (M3x5) that secure the audio board to the display-assembly base.
6. Lift the audio board off the display-assembly base.

## Installing the audio board

### Prerequisites

If you are replacing a component, remove the existing component before performing the installation process.

### About this task

The following image(s) indicate the location of the audio board and provides a visual representation of the installation procedure.



5x  
M3x5

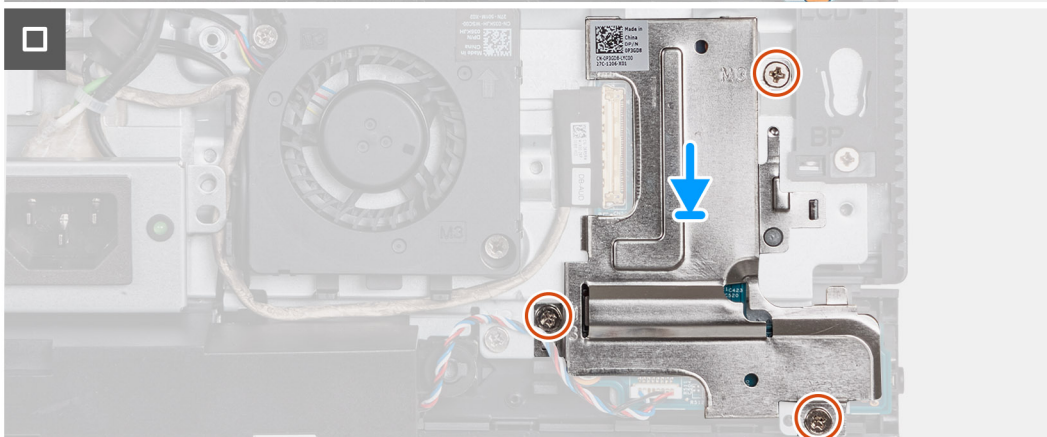
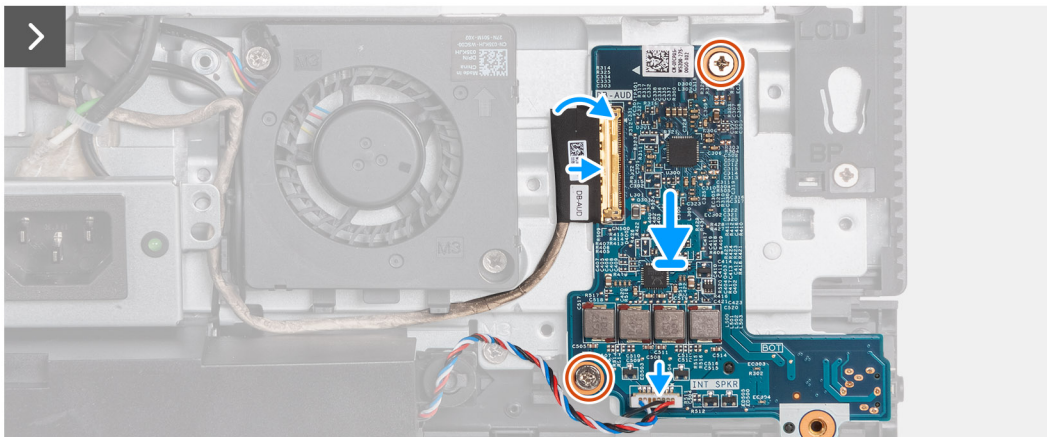
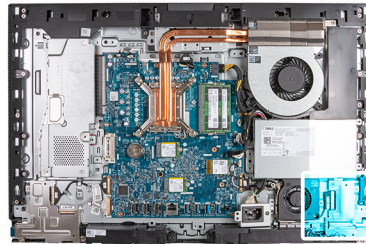

### Steps

1. Place the audio board on the display-assembly base.
2. Align the screw holes on the audio board with the screw holes on the display-assembly base.
3. Replace the two screws (M3x5) that secure the audio board to the display-assembly base.

4. Connect the power cable (DB-PWR) to the audio board and close the latch.
5. Connect the high-speed cable (DB-PWR) to the audio board and close the latch.
6. Place the audio-board shield on the display-assembly base.
7. Align the screw holes on the audio-board shield with the screw holes on the display-assembly base.
8. Replace the three screws (M3x5) that secure the audio-board shield to the display-assembly base.

### Next steps

1. Install the [I/O bracket](#).
2. Install the [bottom cover](#).
3. Install the [I/O cover](#).
4. Install the [system-board shield](#).
5. Install the [back cover](#).
6. Install the [stand](#).
7. Follow the procedure in [After working inside your computer](#).

## Display-assembly base

### Removing the display-assembly base

#### Prerequisites

1. Follow the procedure in [Before working inside your computer](#).
2. Remove the [stand](#).
3. Remove the [back cover](#).
4. Remove the [system-board shield](#).
5. Remove the [wireless card](#).
6. Remove the [I/O cover](#).
7. Remove the [bottom cover](#).
8. Remove the [retractable-camera assembly](#).
9. Remove the [fan](#).
10. Remove the [power-supply unit](#).
11. Remove the [power-supply fan](#).
12. Remove the [I/O bracket](#).
13. Remove the [speakers](#).
14. Remove the [heat sink](#).
15. Remove the [system board](#).

 **NOTE:** The system board can be removed with the memory, solid-state drive(s), coin-cell battery, and processor attached.

16. Remove the [audio board](#).
17. Remove the [power-button and I/O board](#).

#### About this task

 **NOTE:** The display-assembly base includes the following components:

- antenna modules
- display panel
- middle frame

To replace any of these components, replace the entire display-assembly base.

The following image(s) indicate the location of the display-assembly base and provides a visual representation of the removal procedure.

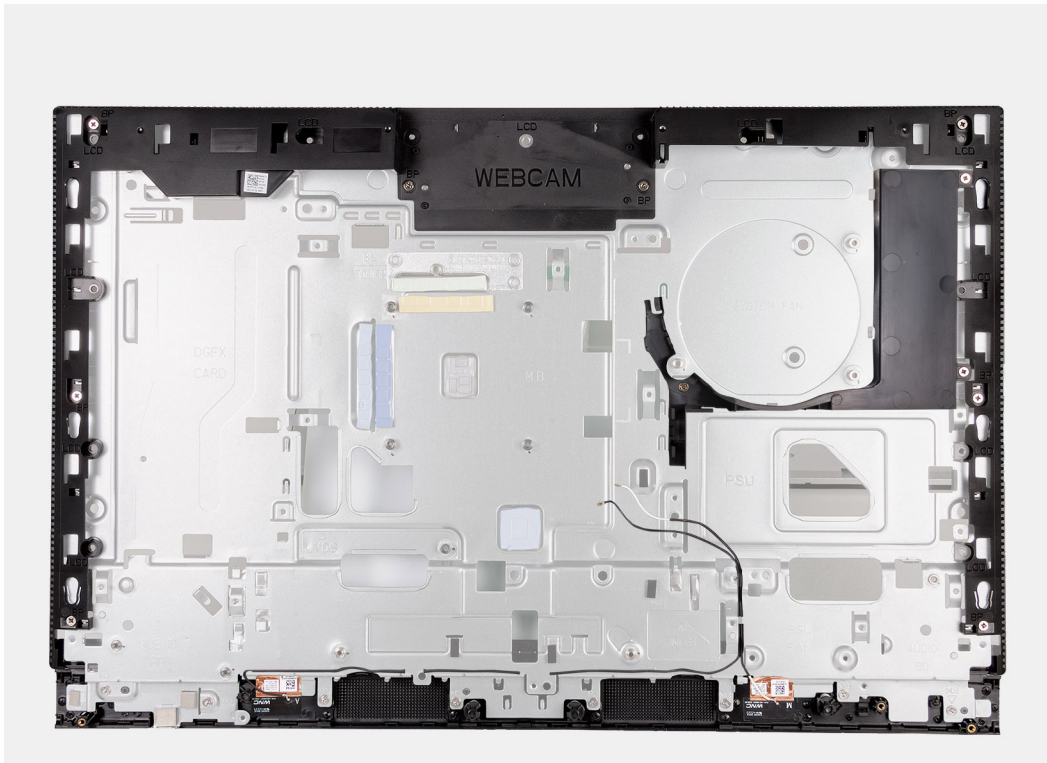

### Steps

After performing the pre-requisites you are left with the display-assembly base.

## Installing the display-assembly base

### Prerequisites

If you are replacing a component, remove the existing component before performing the installation process.

### About this task

**NOTE:** The display-assembly base includes the following components:

- antenna modules
- display panel
- middle frame

To replace any of these components, replace the entire display-assembly base.

The following image(s) indicate the location of the display-assembly base and provides a visual representation of the installation procedure.

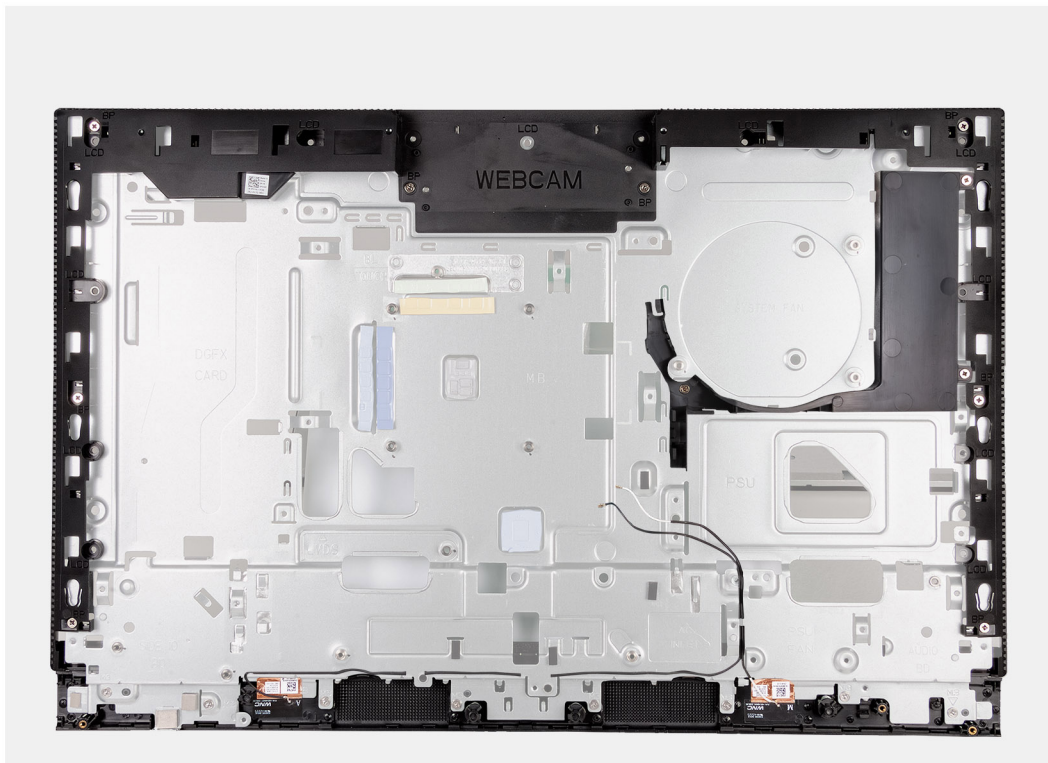

## Steps

To install the display-assembly base, perform all the post-requisite procedures.

## Next steps

1. Install the [power-button and I/O board](#).
2. Install the [audio board](#).
3. Install the [system board](#).

**i** **NOTE:** The system board can be installed with the memory, solid-state drive(s), coin-cell battery, and processor pre-attached.

4. Install the [heat sink](#).
5. Install the [speakers](#).
6. Install the [I/O bracket](#).
7. Install the [power-supply fan](#).
8. Install the [power-supply unit](#).
9. Install the [fan](#).
10. Install the [retractable-camera assembly](#).
11. Install the [bottom cover](#).
12. Install the [I/O cover](#).
13. Install the [wireless card](#).
14. Install the [system-board shield](#).
15. Install the [back cover](#).
16. Install the [stand](#).
17. Follow the procedure in [After working inside your computer](#).



# Removal and installation procedures for Energy Efficient processors

The service procedures for replaceable components listed in this chapters are for computers shipped with Energy Efficient processors.

## Removing and installing Customer Replaceable Units (CRUs)

The replaceable components in this chapter are Customer Replaceable Units (CRUs).

**CAUTION:** Customers can replace only the Customer Replaceable Units (CRUs) following the safety precautions and replacement procedures.

**NOTE:** The images in this document may differ from your computer depending on the configuration you ordered.

### Stand

#### Removing the stand

##### Prerequisites

1. Follow the procedure in [Before working inside your computer](#).

##### About this task

**NOTE:** Depending on the configuration ordered the stand shipped with your computer may vary. The images below show the removal process for both stand configurations.

The following image(s) indicate the location of the stand and provides a visual representation of the removal procedure.



### Steps

1. Place the display-assembly base on a clean and flat surface.
2. Press and hold down on the tab that secures the stand to the display-assembly base.
3. Slide and lift the stand off the display-assembly base.

## Installing the stand

### Prerequisites

If you are replacing a component, remove the existing component before performing the installation process.

### About this task

**NOTE:** Your computer can support two different stand configurations. The images below show the installation process for both stand configurations.

The following image(s) indicate the location of the stand and provides a visual representation of the installation procedure.

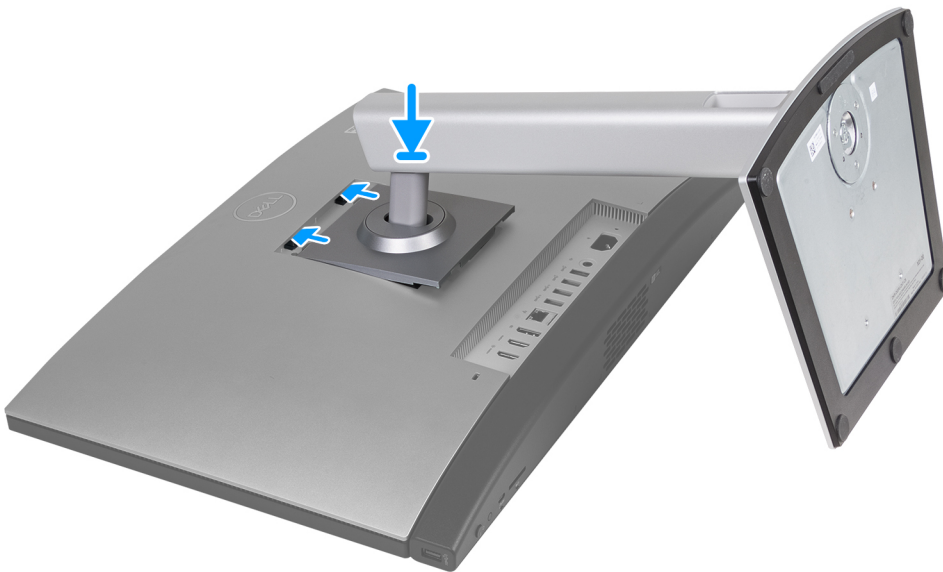

### Steps

1. Align the stand with the slot on the display-assembly base.
2. Slide the stand into place into the slot on the display-assembly base.

### Next steps

1. Follow the procedure in [After working inside your computer](#).

## Back cover

### Removing the back cover

#### Prerequisites

1. Follow the procedure in [Before working inside your computer](#).
2. Remove the [stand](#).

#### About this task

**NOTE:** Before removing the base cover, ensure that there is no SD card installed in the SD card slot on your computer.

The following image(s) indicate the location of the back cover and provides a visual representation of the removal procedure.



#### Steps

1. Press down on the tab that secures the back cover to the display-assembly base.
2. Slide and lift the back cover off the display-assembly base.

### Installing the back cover

#### Prerequisites

If you are replacing a component, remove the existing component before performing the installation process.

#### About this task

The following image(s) indicate the location of the back cover and provides a visual representation of the installation procedure.



### Steps

1. Align the back cover with the display-assembly base.
2. Place and slide the back cover into place on the display assembly base.

**i** **NOTE:** Ensure that the tab on the back cover is secured in the slot on the display-assembly base.

### Next steps

1. Install the [stand](#).
2. Follow the procedure in [After working inside your computer](#).

## Memory

### Removing the memory

#### Prerequisites

1. Follow the procedure in [Before working inside your computer](#).
2. Remove the [stand](#).
3. Remove the [back cover](#).

#### About this task

The following image(s) indicate the location of the memory and provides a visual representation of the removal procedure.

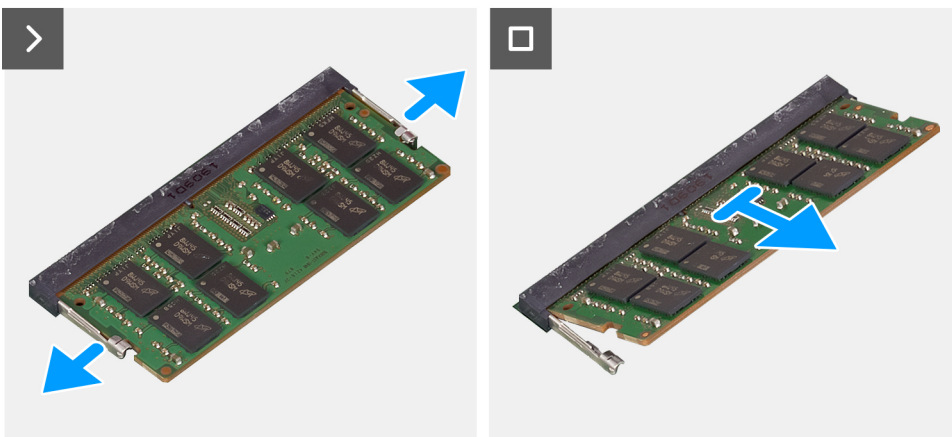
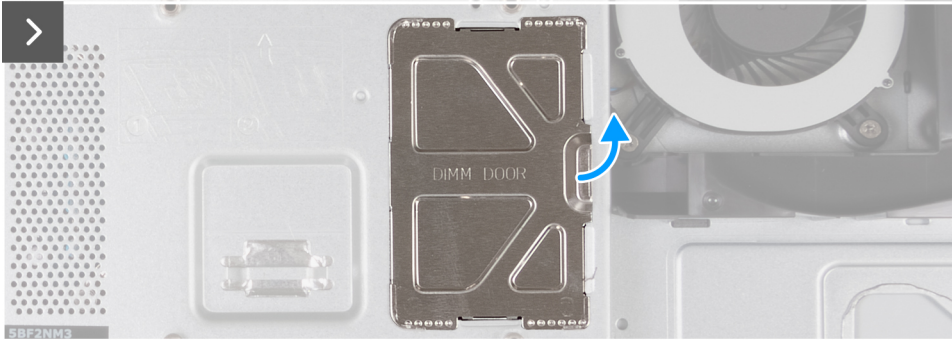
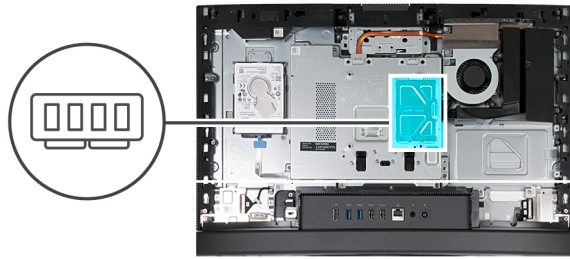

### Steps

1. Using the tab on the DIMM door, pry open and lift the DIMM door on the system-board shield to access the memory slots.
2. Using your fingertips, carefully spread apart the securing clips on each end of the memory-module slot until the memory module pops out.
3. Remove the memory module from the memory-module slot.

**i** | **NOTE:** Repeat steps 2 to 3 for each memory module installed on your computer.

## Installing the memory

### Prerequisites

If you are replacing a component, remove the existing component before performing the installation process.

### About this task

The following image(s) indicate the location of the memory and provides a visual representation of the installation procedure.

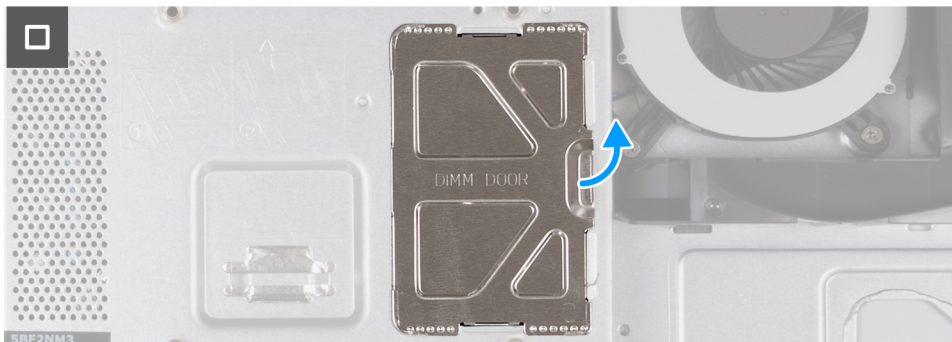
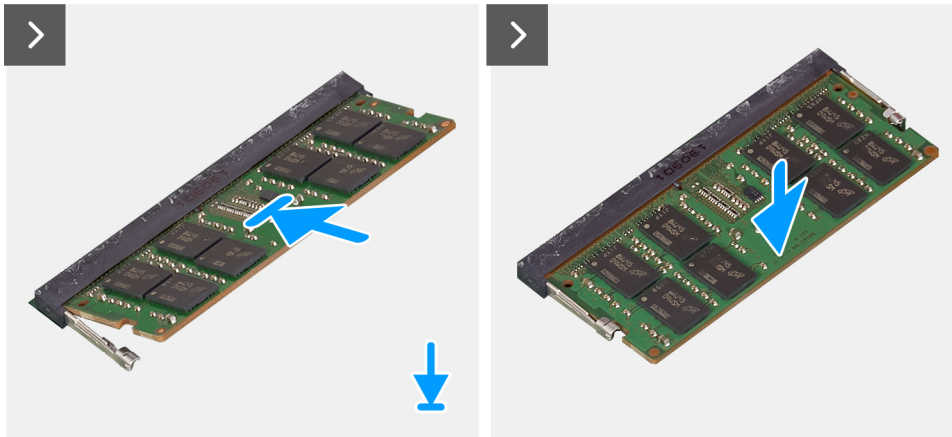
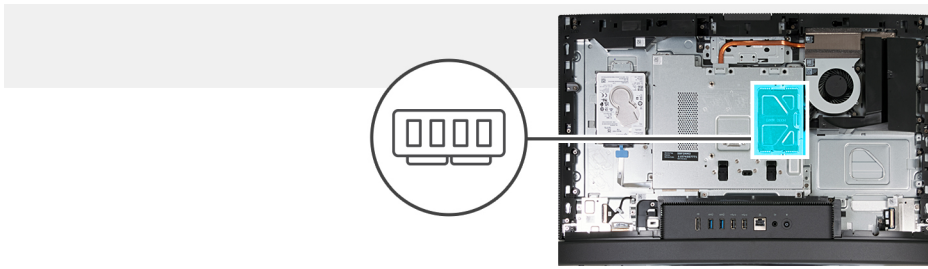

### Steps

1. Align the notch on the memory module with the tab on the memory-module slot
2. Slide the memory module firmly into the slot at an angle and press down on the memory module down until it clicks into place.

**NOTE:** If you do not hear the click, remove the memory module and reinstall it again.

**NOTE:** Repeat steps 1 to 2 for each memory module to be installed on your computer.

3. Close DIMM door and press it into place, securing it.

### Next steps

1. Install the [back cover](#).
2. Install the [stand](#).
3. Follow the procedure in [After working inside your computer](#).

# System-board shield

## Removing the system-board shield

### Prerequisites

1. Follow the procedure in [Before working inside your computer](#).
2. Remove the [stand](#).
3. Remove the [back cover](#).

### About this task

The following image(s) indicate the location of the system-board shield and provides a visual representation of the removal procedure.



6x  
M3x5

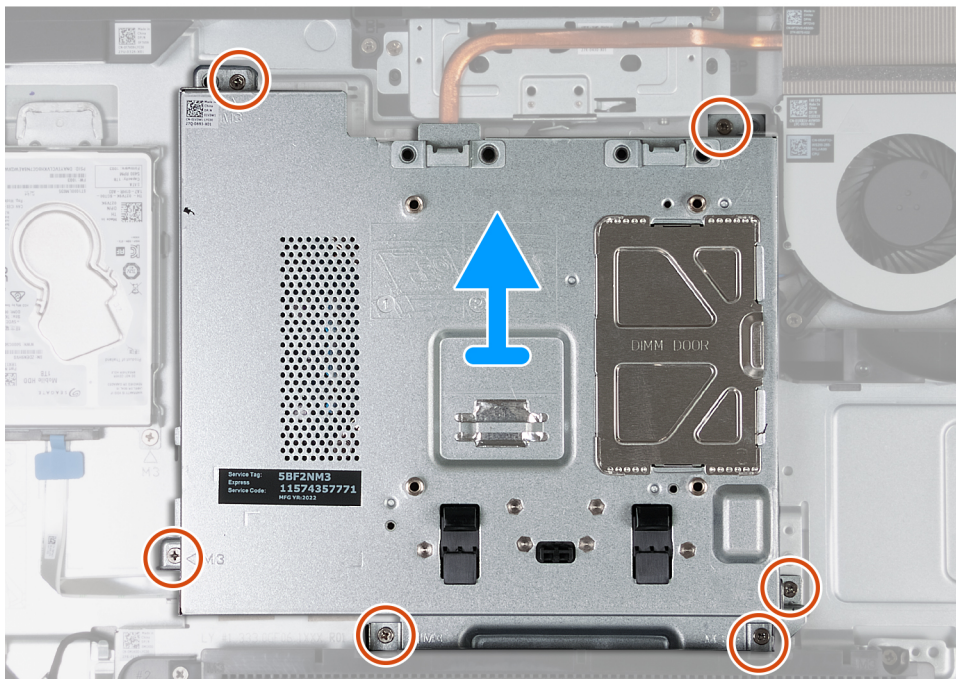
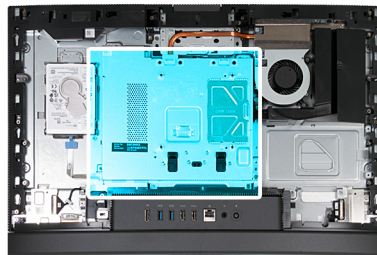

### Steps

1. Remove the six screws (M3x5) that secure the system-board shield to the display-assembly base.
2. Lift the system-board shield off the display-assembly base.

## Installing the system-board shield

### Prerequisites

If you are replacing a component, remove the existing component before performing the installation process.



## About this task

The following image(s) indicate the location of the system-board shield and provides a visual representation of the installation procedure.



6x  
M3x5

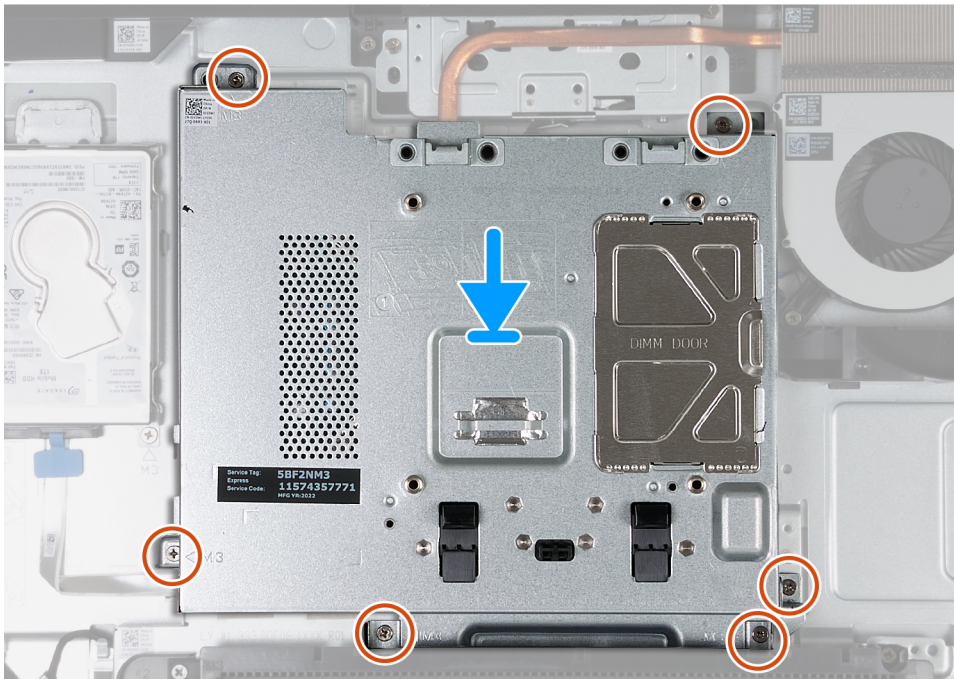
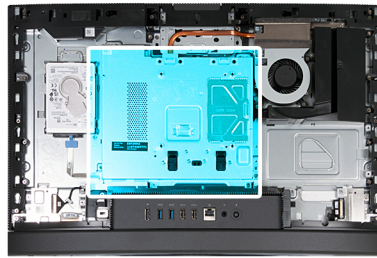

## Steps

1. Place the system-board on the display-assembly base.
2. Align the screw holes on the system-board shield with the screw holes on the display-assembly base.
3. Replace the six screws (M3x5) that secure the system-board shield to the display-assembly base.

## Next steps

1. Install the [back cover](#).
2. Install the [stand](#).
3. Follow the procedure in [After working inside your computer](#).

## Wireless card

### Removing the wireless card

#### Prerequisites

1. Follow the procedure in [Before working inside your computer](#).
2. Remove the [stand](#).
3. Remove the [back cover](#).
4. Remove the [system-board shield](#).

### About this task

The following image(s) indicate the location of the wireless card and provides a visual representation of the removal procedure.

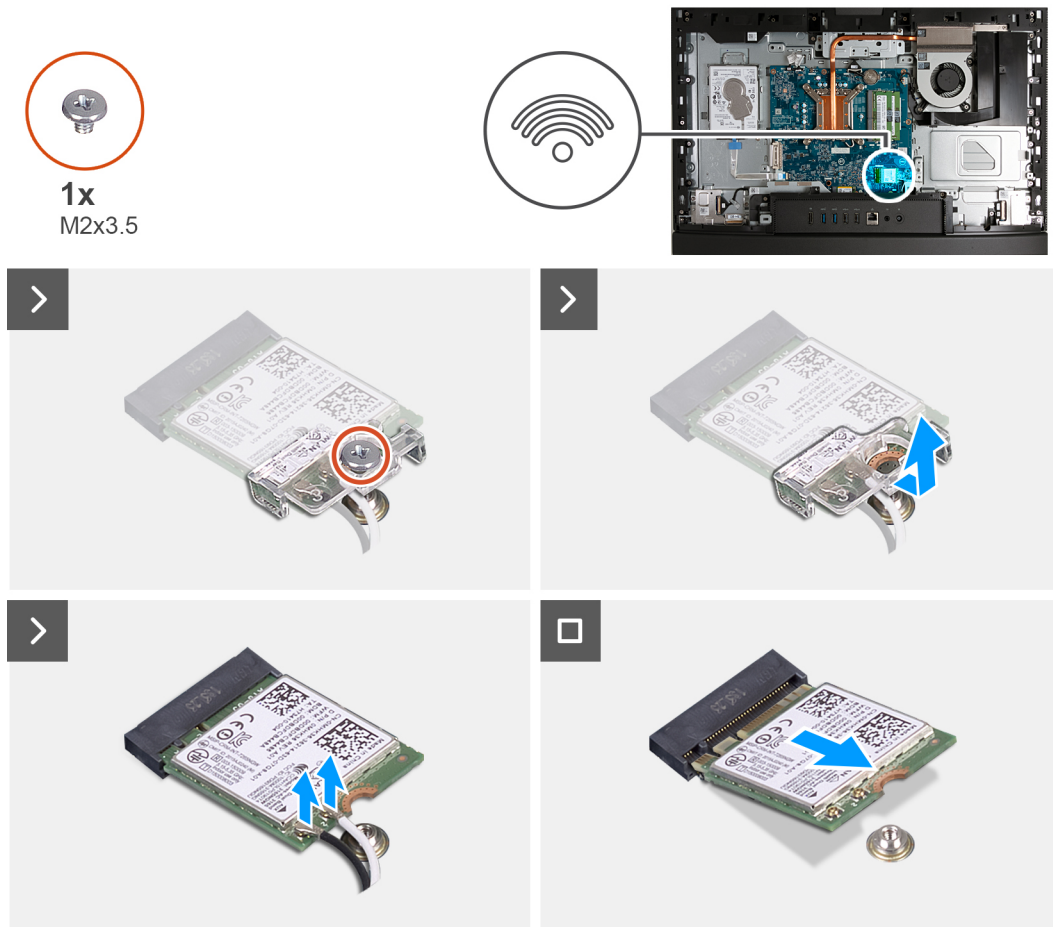

### Steps

1. Remove the screw (M2x3.5) that secures the wireless-card bracket to the wireless card.
2. Lift the wireless-card bracket off the wireless card.
3. Disconnect the antenna cables from the wireless card.
4. Slide and remove the wireless card from the wireless-card slot (M.2 WLAN).

## Installing the wireless card

### Prerequisites

If you are replacing a component, remove the existing component before performing the installation process.

### About this task

The following image(s) indicate the location of the wireless card and provides a visual representation of the installation procedure.



1x  
M2x3.5

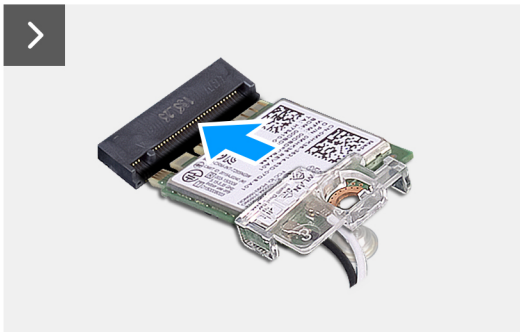
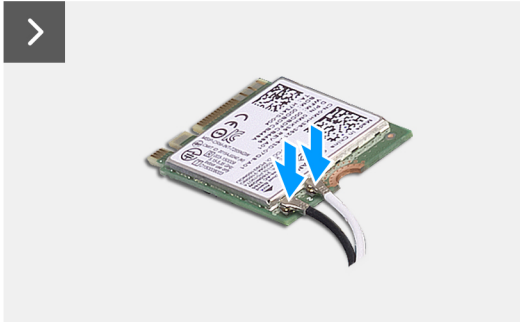
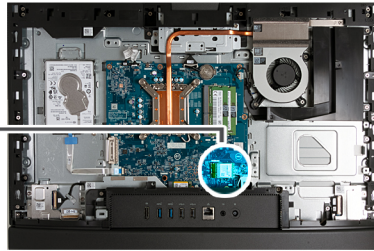

### Steps

1. Connect the antenna cables to the wireless card.

**Table 26. Antenna-cable color scheme**

Connectors on the wireless card	Antenna-cable color	Silkscreen marking	
Main	White	MAIN	△ (white triangle)
Auxiliary	Black	AUX	▲ (black triangle)

2. Place the wireless-card bracket on the wireless card.
3. Align the notch on the wireless card with the tab on the wireless-card slot (M.2 WLAN).
4. Slide the wireless card at an angle into the wireless-card slot (M.2 WLAN).
5. Replace the screw (M2x3.5) that secures the wireless-card bracket to the wireless card.

### Next steps

1. Install the [system-board shield](#).
2. Install the [back cover](#).
3. Install the [stand](#).
4. Follow the procedure in [After working inside your computer](#).

# Solid-state drive

## Removing the M.2 2230 solid-state drive

### Prerequisites

1. Follow the procedure in [Before working inside your computer](#).
2. Remove the [stand](#).
3. Remove the [back cover](#).
4. Remove the [system-board shield](#).

### About this task

**NOTE:** Depending on the configuration ordered, your computer may have an M.2 2230 or a 2280 solid-state drive installed in the solid-state drive slot (M.2 PCIe SSD 0) on the system board.

**NOTE:** This procedure is applicable for computers where an M.2 2230 solid-state drive is installed in the solid-state drive slot (M.2 PCIe SSD 0) on the system board.

The following image(s) indicate the location of the M.2 2230 solid-state drive and provides a visual representation of the removal procedure.

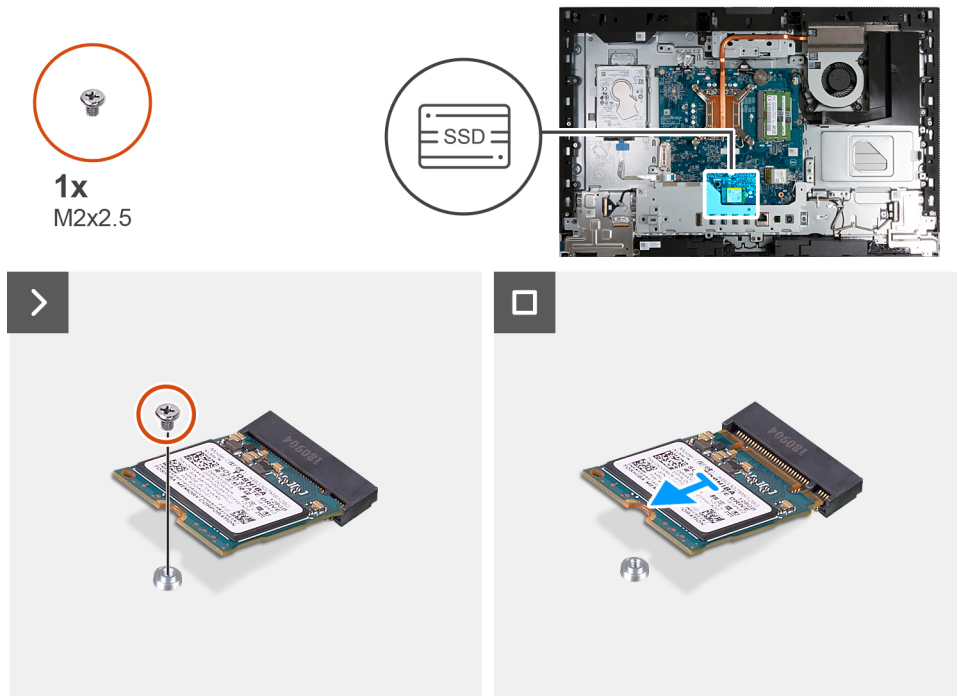

### Steps

1. Remove the screw (M2x3.5) that secures the M.2 2230 solid-state drive to the system board.
2. Slide and lift the M.2 2230 solid-state drive from the solid-state drive slot (M.2 PCIe SSD 0) on the system board.

## Installing the M.2 2230 solid-state drive

### Prerequisites

If you are replacing a component, remove the existing component before performing the installation process.

### About this task

**NOTE:** This procedure is only applicable if you are installing an M.2 2230 solid-state drive into the solid-state drive slot (M.2 PCIe SSD 0) on the system board.

**NOTE:** Ensure that the M.2 screw mount is in the proper location to install the M.2 2230 solid-state drive, refer to [Location of the screw mount](#).

The following image(s) indicate the location of the M.2 2230 solid-state drive and provides a visual representation of the installation procedure.

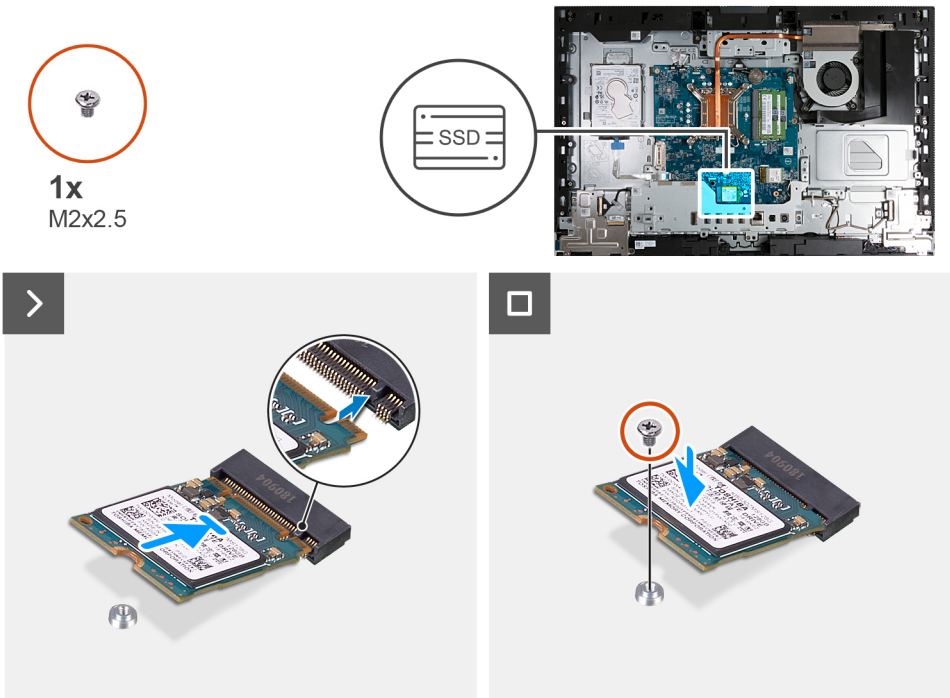

### Steps

1. Align the notch on the M.2 2230 solid-state drive with the tab on the solid-state drive slot (M.2 PCIe SSD 0).
2. Slide the M.2 2230 solid-state drive into the solid-state drive slot (M.2 PCIe SSD 0) on the system board.
3. Replace the screw (M2x3.5) that secures the M.2 2230 solid-state drive to the system board.

### Next steps

1. Install the [system-board shield](#).
2. Install the [back cover](#).
3. Install the [stand](#).
4. Follow the procedure in [After working inside your computer](#).

## Removing the 2280 solid-state drive

### Prerequisites

1. Follow the procedure in [Before working inside your computer](#).
2. Remove the [stand](#).
3. Remove the [back cover](#).
4. Remove the [system-board shield](#).

### About this task

**NOTE:** Depending on the configuration ordered, your computer may have an M.2 2230 or a 2280 solid-state drive installed in the solid-state drive slot (M.2 PCIe SSD 0) on the system board.

**NOTE:** This procedure is applicable for computers where an M.2 2280 solid-state drive is installed in the solid-state drive slot (M.2 PCIe SSD 0) on the system board.

The following image(s) indicate the location of the 2280 solid-state drive and provides a visual representation of the removal procedure.



1x  
M2x2.5

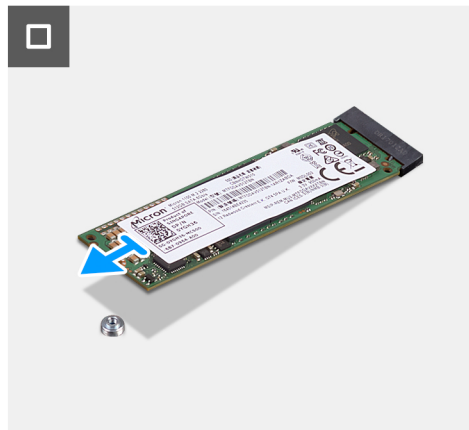
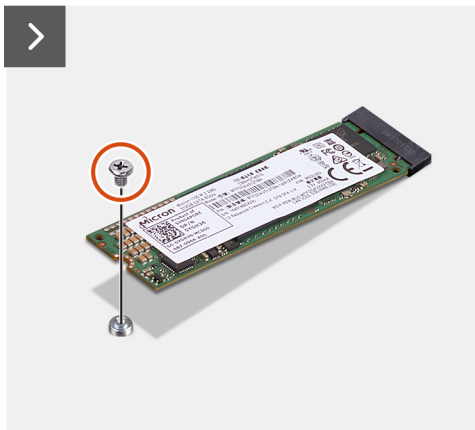
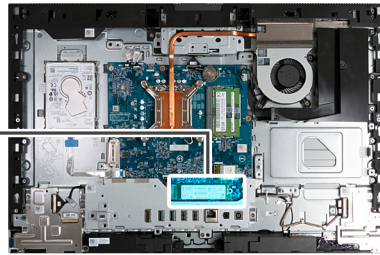

### Steps

1. Remove the screw (M2x3.5) that secures the M.2 2280 solid-state drive to the system board.
2. Slide and lift the M.2 2280 solid-state drive from the solid-state drive slot (M.2 PCIe SSD 0) on the system board.

## Installing the 2280 solid-state drive

### Prerequisites

If you are replacing a component, remove the existing component before performing the installation process.

### About this task

**NOTE:** This procedure is only applicable if you are installing an M.2 2280 solid-state drive into the solid-state drive slot (M.2 PCIe SSD 0) on the system board.

**NOTE:** Ensure that the M.2 screw mount is in the proper location to install the M.2 2280 solid-state drive, refer to [Location of the screw mount](#).

The following image(s) indicate the location of the 2280 solid-state drive and provides a visual representation of the installation procedure.

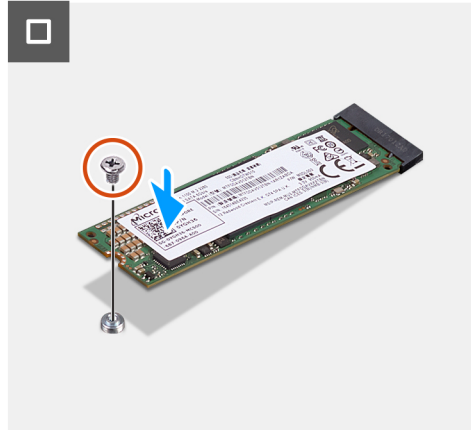
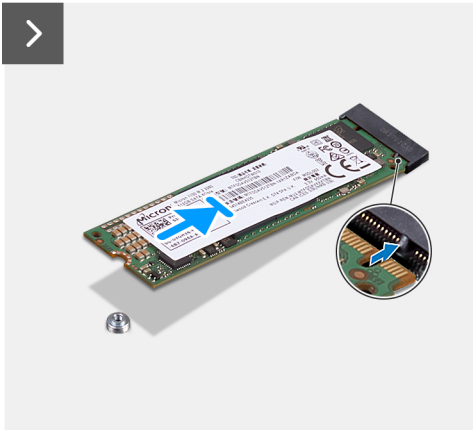
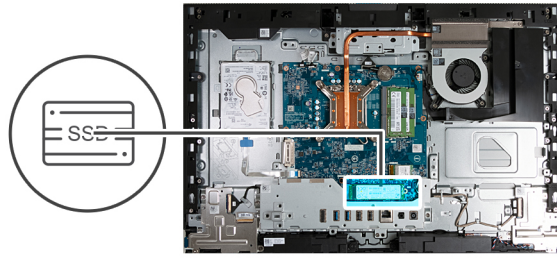

### Steps

1. Align the notch on the M.2 2280 solid-state drive with the tab on the solid-state drive slot (M.2 PCIe SSD 0).
2. Slide the M.2 2280 solid-state drive into the solid-state drive slot (M.2 PCIe SSD 0) on the system board.
3. Replace the screw (M2x3.5) that secures the M.2 2280 solid-state drive to the system board.

### Next steps

1. Install the [system-board shield](#).
2. Install the [back cover](#).
3. Install the [stand](#).
4. Follow the procedure in [After working inside your computer](#).

## Location of the screw mount

### Prerequisites

To install an M.2 solid-state drive of a different form factor on the M.2 slot, the location of the screw mount has to be changed in order to install the M.2 solid-state drive of a different form factor.

### About this task

**NOTE:** This procedure only applies to the screw mount located with the M.2 slot.

The following image(s) indicate the location of the screw mount on the M.2 slot and provides a visual representation of the procedure to change the position of the screw mount.

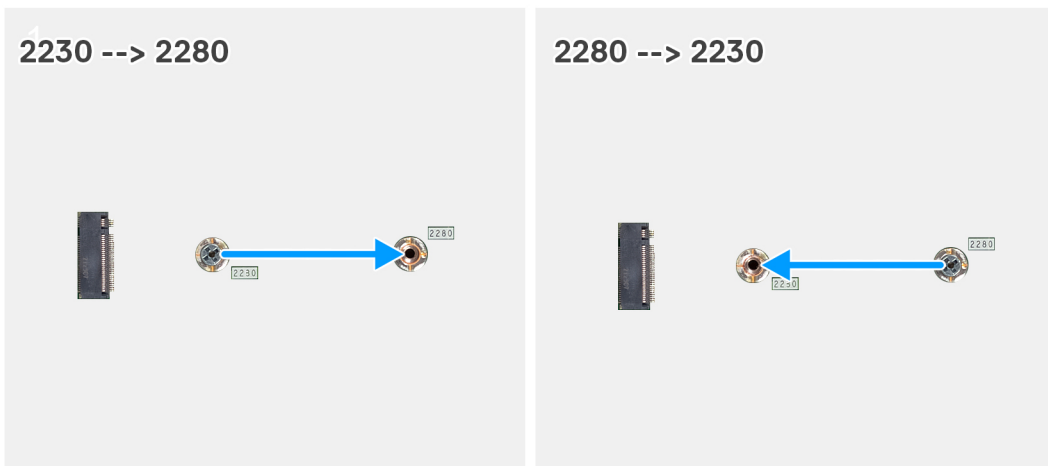

### Steps

1. Remove the screw mount on the system board.
2. Install the screw mount on the system board.

### Next steps

1. Install the [M.2 2230 solid-state drive](#) or the [M.2 2230 solid-state drive](#), whichever applicable.
2. Install the [system-board shield](#).
3. Install the [back cover](#).
4. Install the [stand](#).
5. Follow the procedure in [After working inside your computer](#).

## Hard drive

### Removing the hard drive

#### Prerequisites

1. Follow the procedure in [Before working inside your computer](#).
2. Remove the [stand](#).
3. Remove the [back cover](#).

#### About this task

The following image(s) indicate the location of the hard drive and provides a visual representation of the removal procedure.





1x  
M3x5



4x  
M3x3.5

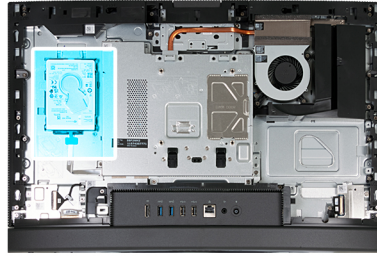

## Steps

1. Disconnect the hard-drive cable from the hard drive.
2. Remove the screw (M3x5) that secure the hard-drive assembly to the display-assembly base.
3. Slide and lift the hard-drive assembly from the hard-drive slot on the display-assembly base.
4. Remove the four screws (M3x3.5) that secure the hard-drive bracket to the hard drive.
5. Lift the hard-drive bracket off the hard drive.

## Installing the hard drive

### Prerequisites

If you are replacing a component, remove the existing component before performing the installation process.

## About this task

The following image(s) indicate the location of the hard drive and provides a visual representation of the installation procedure.

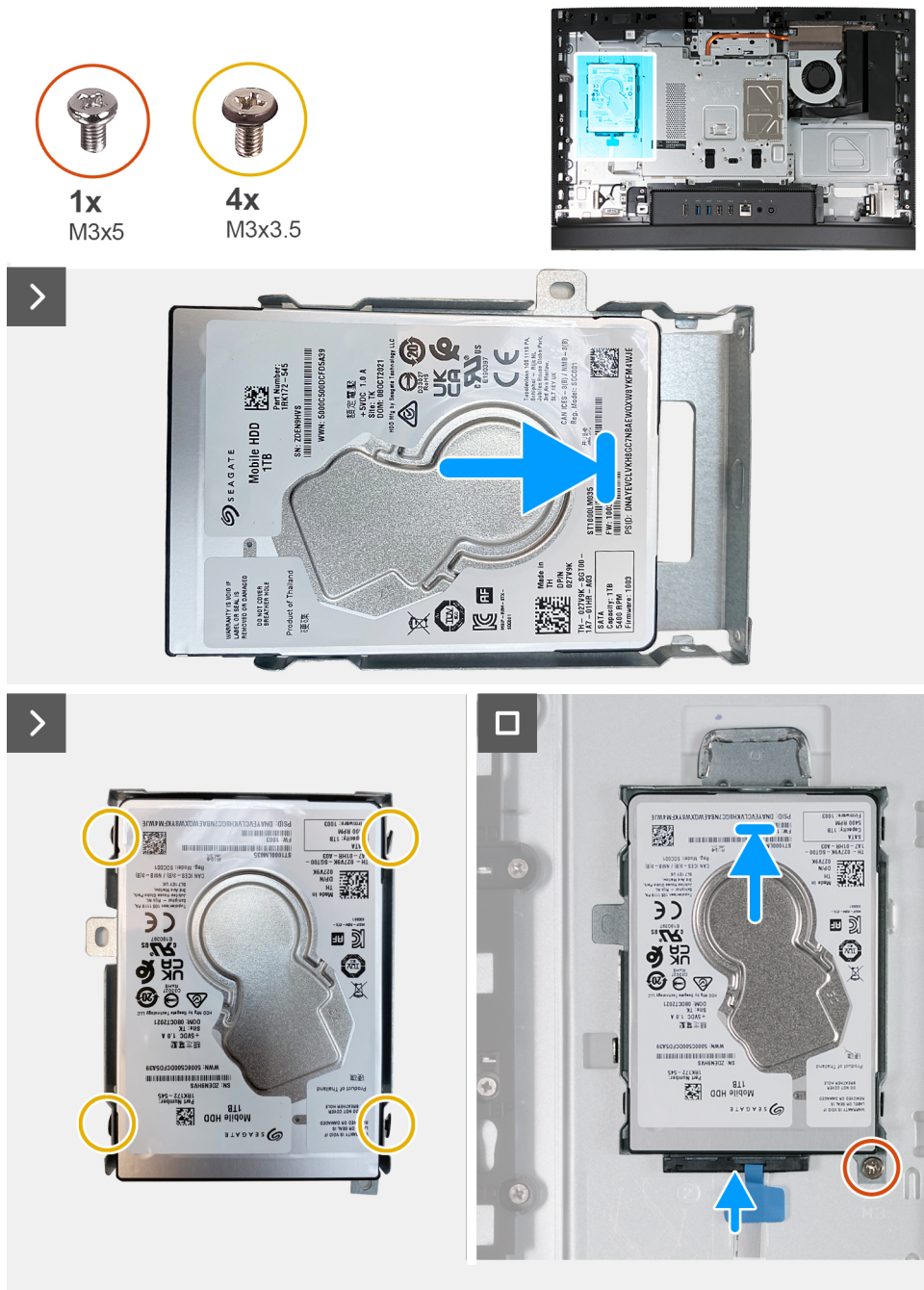

## Steps

1. Place the hard-drive bracket on the hard drive.
2. Align the screw holes on the hard drive with the screw holes on the hard-drive bracket.
3. Replace the four screws (M3x3.5) that secure the hard-drive bracket to the hard drive.
4. Slide the hard-drive assembly into the hard-drive slot on the display-assembly base.
5. Replace the screw (M3x5) that secures the hard-drive assembly to the display-assembly base.
6. Connect the hard-drive cable to the hard drive.

## Next steps

1. Install the [back cover](#).

2. Install the [stand](#).
3. Follow the procedure in [After working inside your computer](#).

## Coin-cell battery

### Removing the coin-cell battery

#### Prerequisites

1. Follow the procedure in [Before working inside your computer](#).
2. Remove the [stand](#).
3. Remove the [back cover](#).
4. Remove the [system-board shield](#).

#### About this task

**NOTE:** Removing the coin-cell battery resets the BIOS settings to default. It is recommended that you note the BIOS settings before removing the coin-cell battery.

The following image(s) indicate the location of the coin-cell battery and provides a visual representation of the removal procedure.

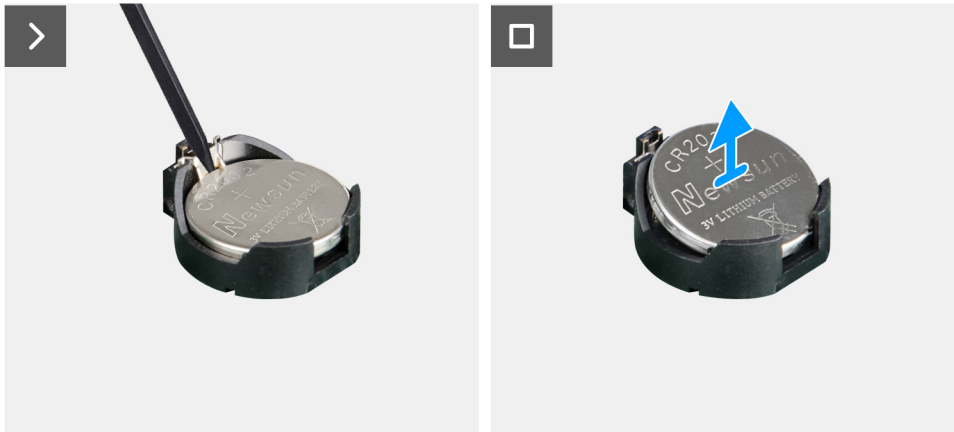
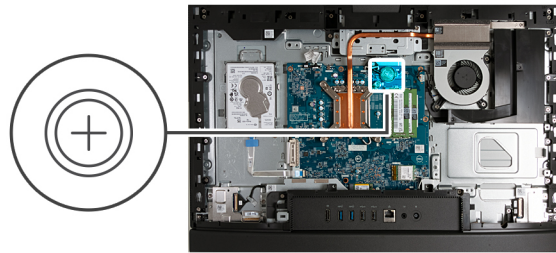

#### Steps

1. Push the release lever on the coin-cell battery socket to release the coin-cell battery out of the socket.
2. Lift the coin-cell battery from the coin-cell battery socket.

### Installing the coin-cell battery

#### Prerequisites

If you are replacing a component, remove the existing component before performing the installation process.

### About this task

The following image(s) indicate the location of the coin-cell battery and provides a visual representation of the installation procedure.

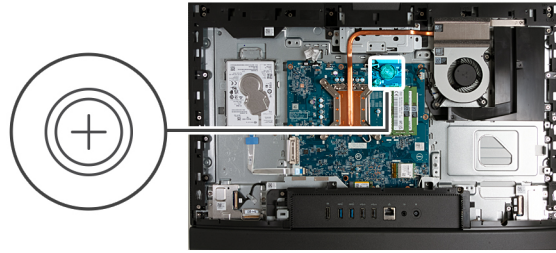

### Steps

With the positive-side (+) facing up, insert the coin-cell battery into the battery socket on the system board and snap the battery into place.

### Next steps

1. Install the [system-board shield](#).
2. Install the [back cover](#).
3. Install the [stand](#).
4. Follow the procedure in [After working inside your computer](#).

## I/O cover

### Removing the I/O cover

#### Prerequisites

1. Follow the procedure in [Before working inside your computer](#).
2. Remove the [stand](#).
3. Remove the [back cover](#).
4. Remove the [system-board shield](#).

### About this task

The following image(s) indicate the location of the I/O cover and provides a visual representation of the removal procedure.



2x  
M3x5

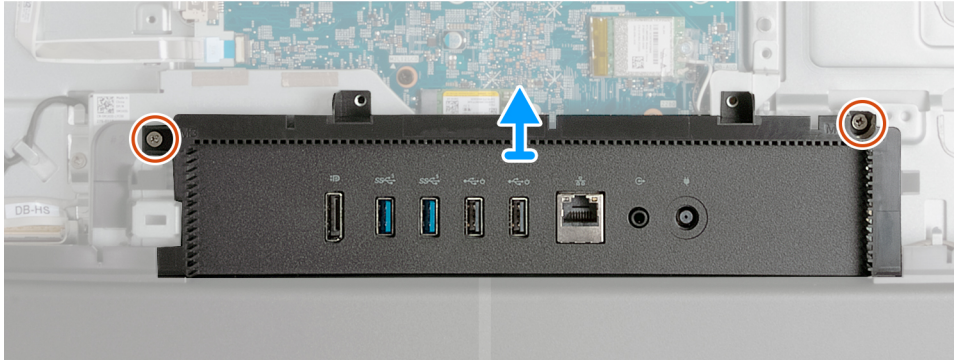
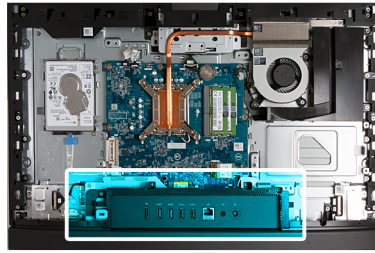

### Steps

1. Remove the two screws (M3x5) that secure the I/O cover to the display-assembly base.
2. Lift the I/O cover off the display-assembly base.

## Installing the I/O cover

### Prerequisites

If you are replacing a component, remove the existing component before performing the installation process.

### About this task

The following image(s) indicate the location of the I/O cover and provides a visual representation of the installation procedure.



2x  
M3x5

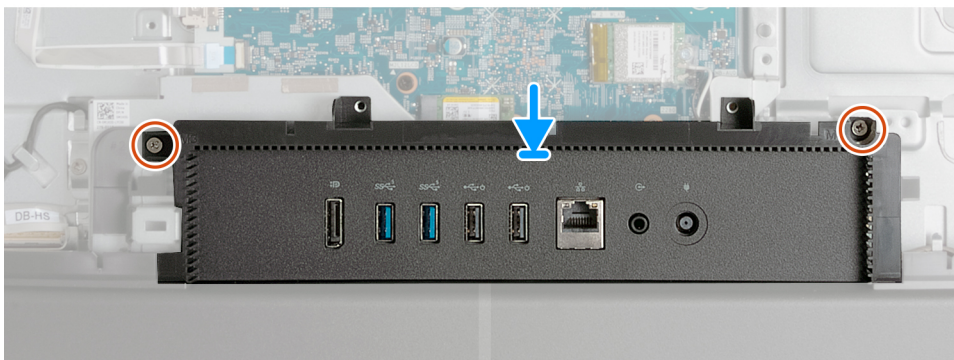
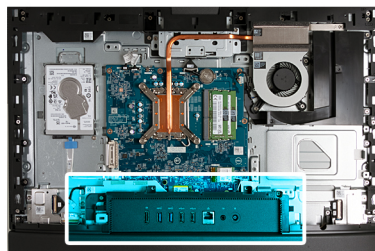

### Steps

1. Place and align the I/O cover with the display-assembly base.
2. Align the screw holes on the I/O cover with the screw holes on the display-assembly base.
3. Replace the two screws (M3x5) that secure the I/O cover to the display-assembly base.

### Next steps

1. Install the [system-board shield](#).
2. Install the [back cover](#).
3. Install the [stand](#).
4. Follow the procedure in [After working inside your computer](#).

## Bottom cover

### Removing the bottom cover

#### Prerequisites

1. Follow the procedure in [Before working inside your computer](#).
2. Remove the [stand](#).
3. Remove the [back cover](#).
4. Remove the [system-board shield](#).
5. Remove the [I/O cover](#).

#### About this task

The following image(s) indicate the location of the bottom cover and provides a visual representation of the removal procedure.



**3x**  
M3x5

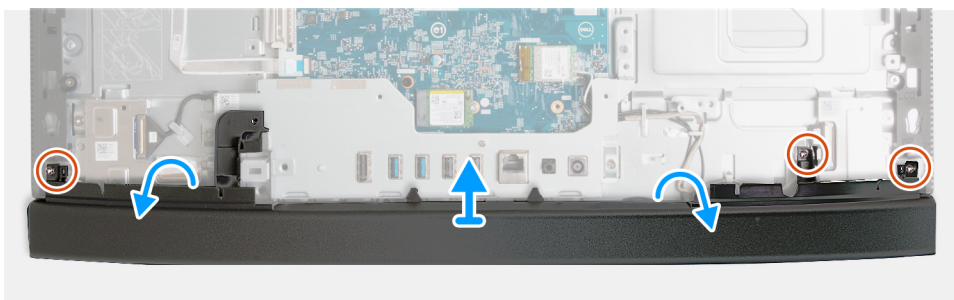
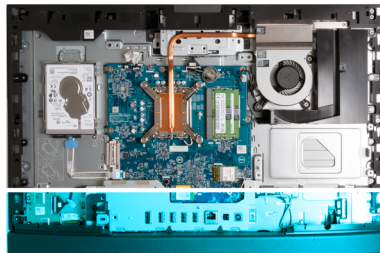

### Steps

1. Remove the three screws (M3x5) that secure the bottom cover to the display-assembly base.
2. Lift the bottom cover off the display-assembly base.

### Installing the bottom cover

#### Prerequisites

If you are replacing a component, remove the existing component before performing the installation process.

### About this task

The following image(s) indicate the location of the bottom cover and provides a visual representation of the installation procedure.



**3x**  
M3x5

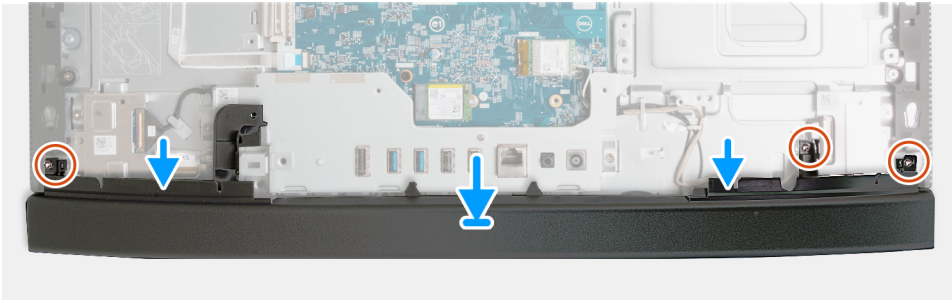
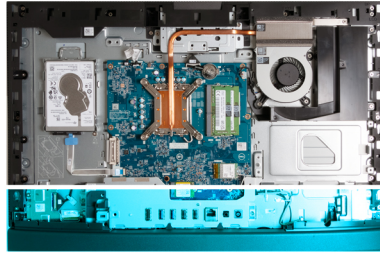

### Steps

1. Place and align the bottom cover with the display-assembly base.
2. Align the screw holes on the bottom cover with the screw holes on the display-assembly base.
3. Replace the three screws (M3x5) that secure the bottom cover to the display-assembly base.

### Next steps

1. Install the [I/O cover](#).
2. Install the [system-board shield](#).
3. Install the [back cover](#).
4. Install the [stand](#).
5. Follow the procedure in [After working inside your computer](#).

## Retractable-camera assembly

### Removing the retractable-camera assembly

#### Prerequisites

1. Follow the procedure in [Before working inside your computer](#).
2. Remove the [stand](#).
3. Remove the [back cover](#).
4. Remove the [system-board shield](#).

#### About this task

**NOTE:** The retractable-camera assembly consists of the following components:

- camera
- microphones

The following image(s) indicate the location of the retractable-camera assembly and provides a visual representation of the removal procedure.



4x  
M3x5

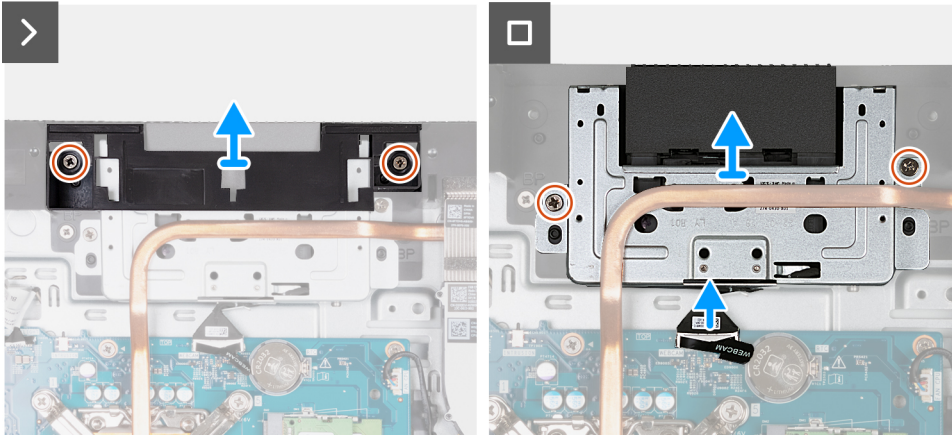
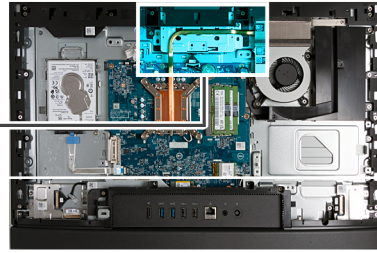
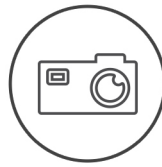

### Steps

1. Remove the two screws (M3x5) that secure the camera-assembly bracket to the display-assembly base.
2. Lift the camera-assembly bracket off the display-assembly base.
3. Using the pull tab, disconnect the camera cable (WEBCAM) from the system board.
4. Remove the two screws (M3x5) that secure the retractable-camera assembly to the display-assembly base.
5. Lift and slide the retractable-camera assembly from its slot and under the heat sink and remove the retractable-camera assembly from the display-assembly base.

## Installing the retractable-camera assembly

### Prerequisites

If you are replacing a component, remove the existing component before performing the installation process.

### About this task

The following image(s) indicate the location of the retractable-camera assembly and provides a visual representation of the installation procedure.





4x  
M3x5

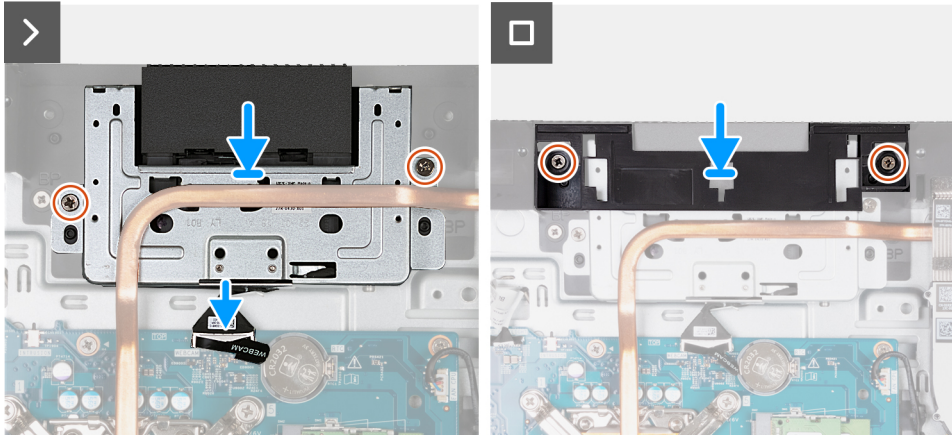
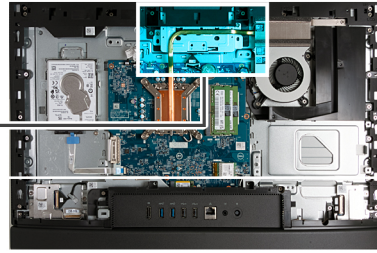
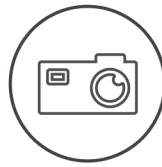

### Steps

1. Slide the retractable-camera assembly under the heat sink into its slot on the display-assembly base.
2. Align the screw holes on the retractable-camera assembly with the screw holes on the display-assembly base.
3. Replace the two screws (M3x5) that secure the retractable-camera assembly to the display-assembly base.
4. Connect the camera cable (WEBCAM) to the system board.
5. Place the camera-assembly bracket over retractable-camera assembly.
6. Align the screw holes on the camera-assembly bracket with the screw holes on the display-assembly base.
7. Replace the two screws (M3x5) that secure the camera-assembly bracket to the display-assembly base.

### Next steps

1. Install the [system-board shield](#).
2. Install the [back cover](#).
3. Install the [stand](#).
4. Follow the procedure in [After working inside your computer](#).

## Fan

### Removing the fan

#### Prerequisites

1. Follow the procedure in [Before working inside your computer](#).
2. Remove the [stand](#).
3. Remove the [back cover](#).
4. Remove the [system-board shield](#).

#### About this task

The following image(s) indicate the location of the fan and provides a visual representation of the removal procedure.



**3x**  
M3x5

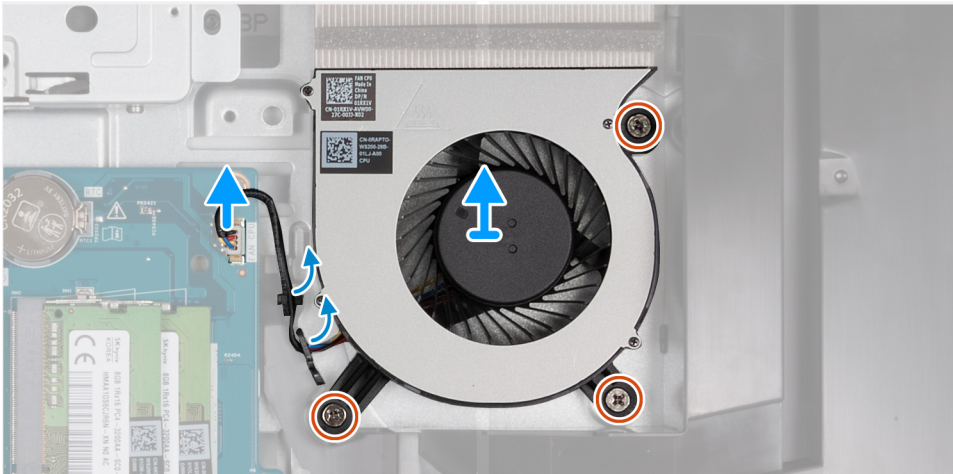
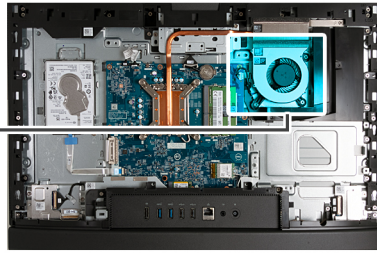
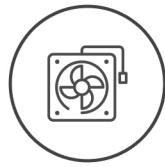

### Steps

1. Remove three two screws (M3x5) that secure the fan to the display-assembly base.
2. Disconnect the fan cable (FAN CPU) from the system board.
3. Lift the fan off the display-assembly base.

## Installing the fan

### Prerequisites

If you are replacing a component, remove the existing component before performing the installation process.

### About this task

The following image(s) indicate the location of the fan and provides a visual representation of the installation procedure.



3x  
M3x5

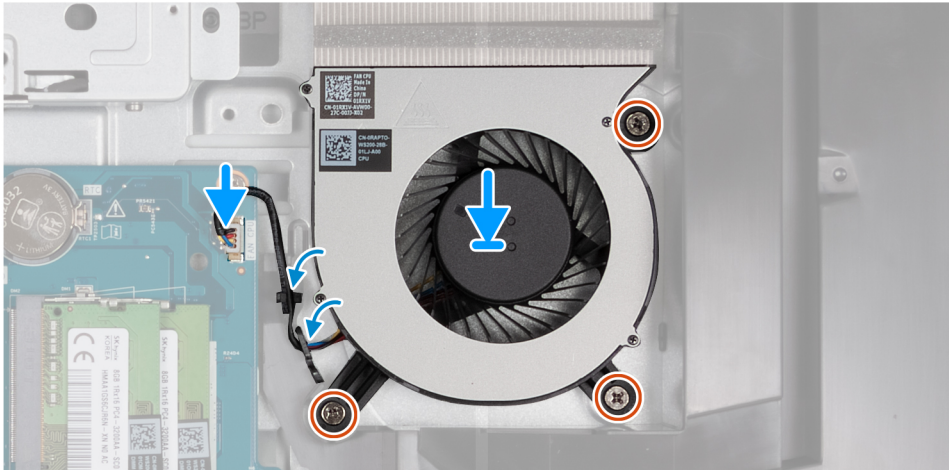
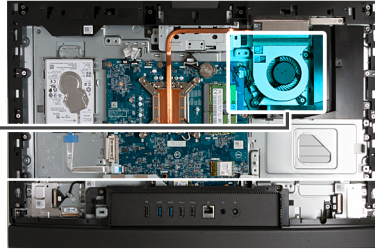
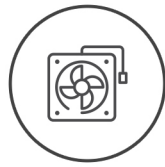

### Steps

1. Place the fan on the display-assembly base.
2. Align the screw holes on the fan with the screw holes on the display-assembly base.
3. Replace the three screws (M3x5) that secure the fan to the display-assembly base.
4. Connect the fan cable (FAN CPU) to the system board.

### Next steps

1. Install the [system-board shield](#).
2. Install the [back cover](#).
3. Install the [stand](#).
4. Follow the procedure in [After working inside your computer](#).

## Removing and installing Field Replaceable Units (FRUs)

The replaceable components in this chapter are Field Replaceable Units (FRUs).

**CAUTION:** The information in this section is intended for authorized service technicians only.

**CAUTION:** To avoid any potential damage to the component or loss of data, ensure that an authorized service technician replaces the Field Replaceable Units (FRUs).

**CAUTION:** Dell Technologies recommends that this set of repairs, if needed, to be conducted by trained technical repair specialists.

**CAUTION:** As a reminder, your warranty does not cover damages that may occur during the courses of FRU repairs that are not authorized by Dell Technologies.

**NOTE:** The images in this document may differ from your computer depending on the configuration you ordered.

## I/O bracket

### Removing the I/O bracket

#### Prerequisites

1. Follow the procedure in [Before working inside your computer](#).
2. Remove the [stand](#).
3. Remove the [back cover](#).
4. Remove the [system-board shield](#).
5. Remove the [I/O cover](#).
6. Remove the [bottom cover](#).

#### About this task

The following image(s) indicate the location of the I/O bracket and provides a visual representation of the removal procedure.



**3x**  
M3x5

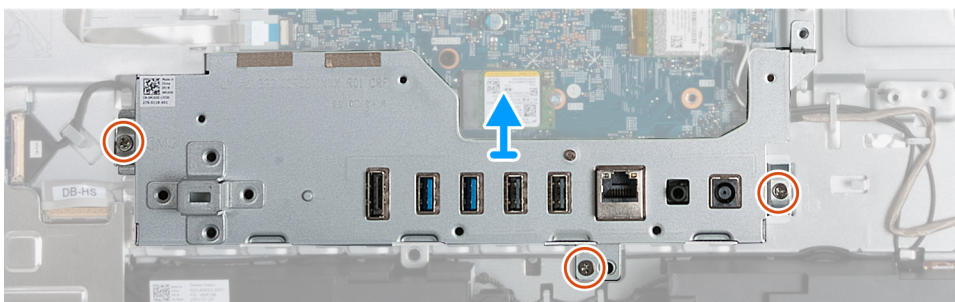

#### Steps

1. Remove the three screws (M3x5) that secure the I/O bracket to the display-assembly base.
2. Lift the I/O bracket off the display-assembly base.

### Installing the I/O bracket

#### Prerequisites

If you are replacing a component, remove the existing component before performing the installation process.

#### About this task

The following image(s) indicate the location of the I/O bracket and provides a visual representation of the installation procedure.



**3x**  
M3x5

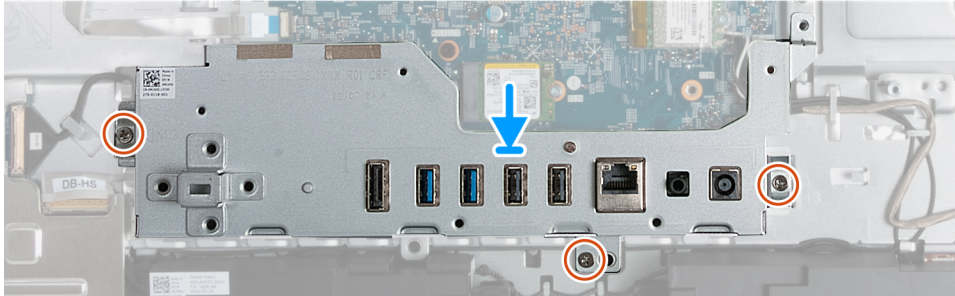
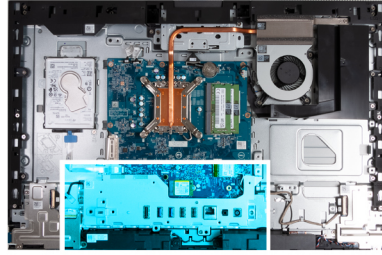

### Steps

1. Place and align the I/O bracket with the display-assembly base.
2. Align the I/O slots to the I/O ports and the screw holes on the I/O bracket with the screw holes on the display-assembly base.
3. Replace the three screws (M3x5) that secure the I/O cover to the display-assembly base.

### Next steps

1. Install the [bottom cover](#).
2. Install the [I/O cover](#).
3. Install the [system-board shield](#).
4. Install the [back cover](#).
5. Install the [stand](#).
6. Follow the procedure in [After working inside your computer](#).

## Speakers

### Removing the speakers

#### Prerequisites

1. Follow the procedure in [Before working inside your computer](#).
2. Remove the [stand](#).
3. Remove the [back cover](#).
4. Remove the [system-board shield](#).
5. Remove the [I/O cover](#).
6. Remove the [bottom cover](#).

#### About this task

The following image(s) indicate the location of the speakers and provides a visual representation of the removal procedure.

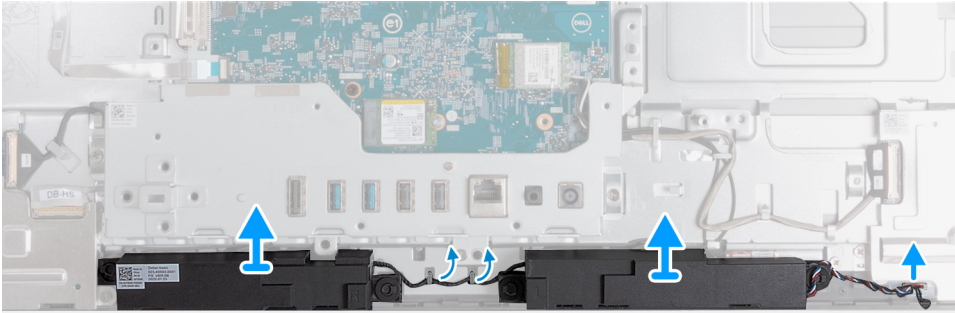
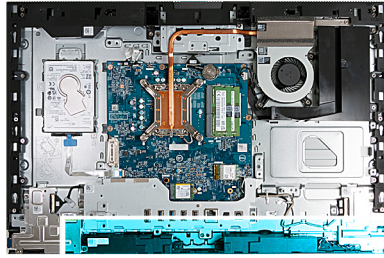

### Steps

1. Disconnect the speaker cable (INT SPKR) from the audio board.
2. Remove the speaker cable from its routing guides on the display-assembly base.
3. Lift the speakers and its cable off the display-assembly base.

## Installing the speakers

### Prerequisites

If you are replacing a component, remove the existing component before performing the installation process.

### About this task

The following image(s) indicate the location of the speakers and provides a visual representation of the installation procedure.

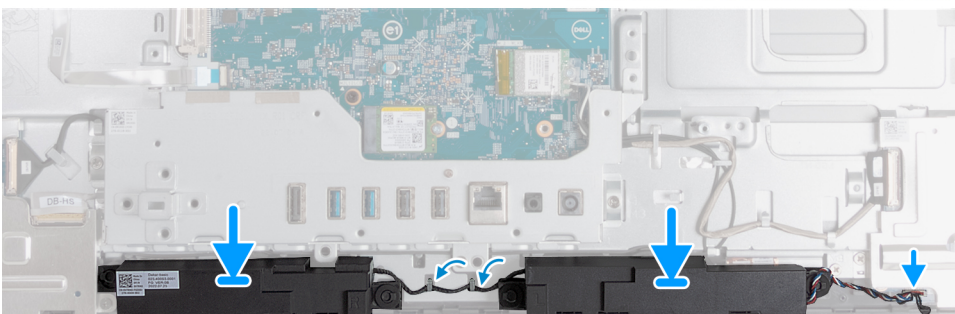
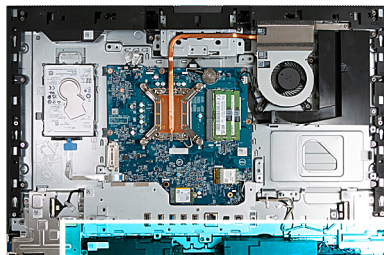

### Steps

1. Insert the speakers into their slots on the display-assembly base.
2. Route the speaker cable through the routing guides on the display-assembly base.

3. Connect the speaker cable (INT SPKR) to the audio board.

#### Next steps

1. Install the [bottom cover](#).
2. Install the [I/O cover](#).
3. Install the [system-board shield](#).
4. Install the [back cover](#).
5. Install the [stand](#).
6. Follow the procedure in [After working inside your computer](#).

## Heat sink

### Removing the heat sink

#### Prerequisites

1. Follow the procedure in [Before working inside your computer](#).
2. Remove the [stand](#).
3. Remove the [back cover](#).
4. Remove the [system-board shield](#).

#### About this task

 **NOTE:** The heat sink may become hot during normal operation. Allow sufficient time for the heat sink to cool before you touch it.

 **NOTE:** For maximum cooling of the processor, do not touch the heat transfer areas on the heat sink. The oils in your skin can reduce the heat transfer capability of the thermal grease.

The following image(s) indicate the location of the heat sink and provides a visual representation of the removal procedure.



5x

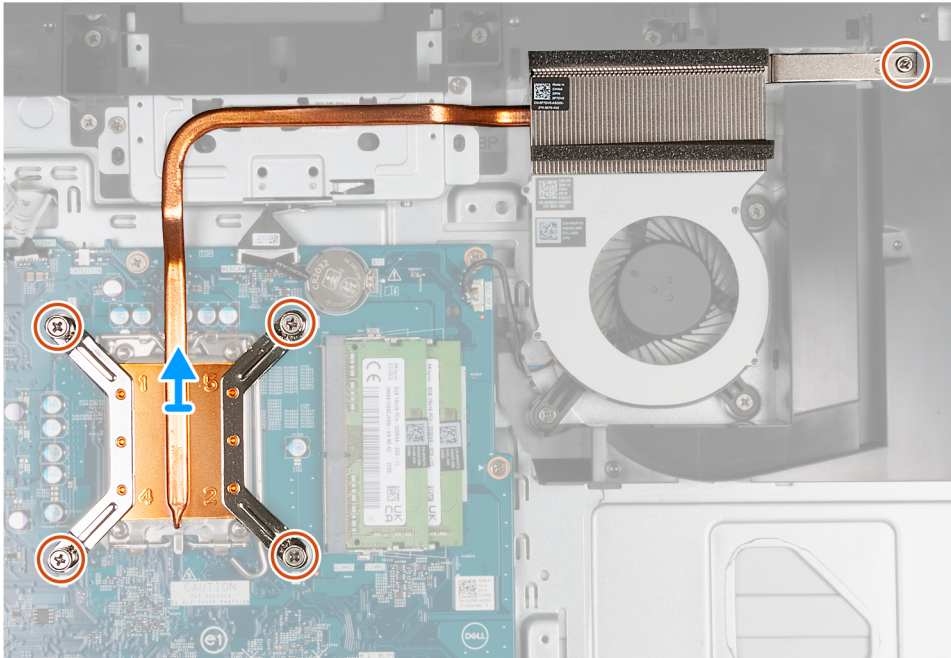
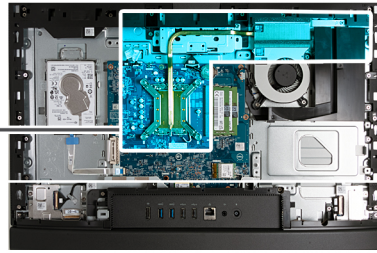

### Steps

1. In reverse sequential order (5>4>3>2>1) loosen the five captive screws that secure the heat sink to the system board and display-assembly base.
2. Lift the heat sink off the display assembly base.

## Installing the heat sink

### Prerequisites

If you are replacing a component, remove the existing component before performing the installation process.

### About this task

**i** **NOTE:** If either the processor or the fan and heat sink is replaced, use the thermal grease provided in the kit to ensure that thermal conductivity is achieved.

The following image(s) indicate the location of the heat sink and provides a visual representation of the installation procedure.





5x

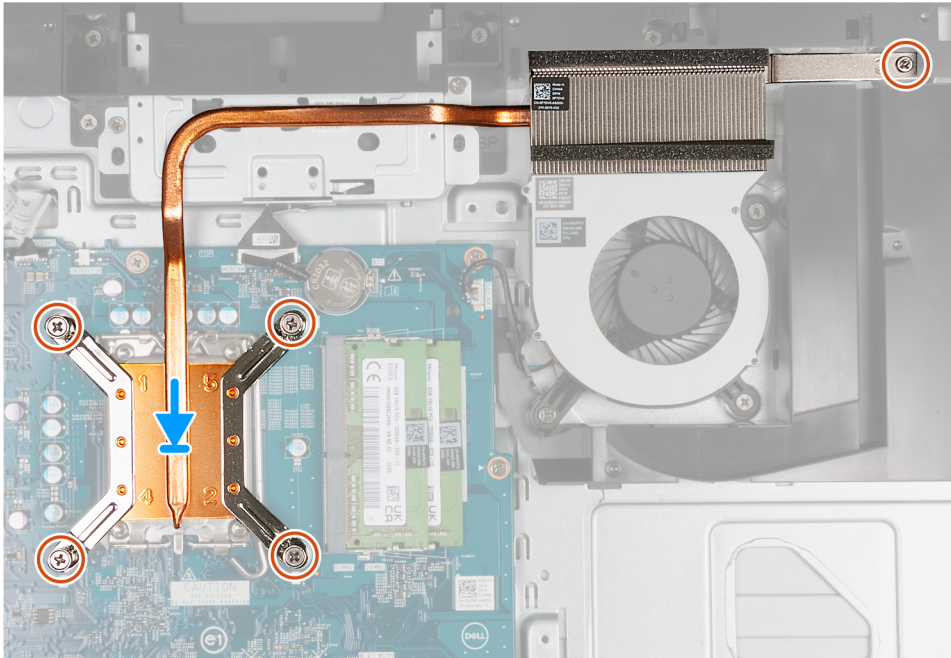
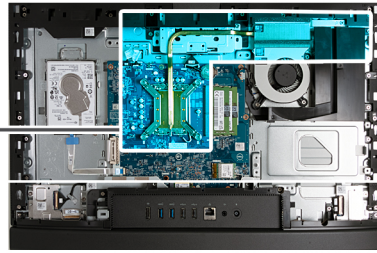

### Steps

1. Place the heat sink on the system board and the display-assembly base.
2. Align the screws on the heatsink with the screw holes on system board and the display-assembly base.
3. In sequential order (1>2>3>4>5) tighten the five captive screws that secure the heat sink to the system board and display-assembly base.

### Next steps

1. Install the [system-board shield](#).
2. Install the [back cover](#).
3. Install the [stand](#).
4. Follow the procedure in [After working inside your computer](#).

## Processor

### Removing the processor

#### Prerequisites

1. Follow the procedure in [Before working inside your computer](#).
2. Remove the [stand](#).
3. Remove the [back cover](#).
4. Remove the [system-board shield](#).
5. Remove the [heat sink](#).

### About this task

- NOTE:** The processor may become hot during normal operation. Allow sufficient time for the processor to cool before you touch it.
- NOTE:** For maximum cooling of the processor, do not touch the heat transfer areas on the processor. The oils in your skin can reduce the heat transfer capability of the thermal grease.

The following image(s) indicate the location of the processor and provides a visual representation of the removal procedure.

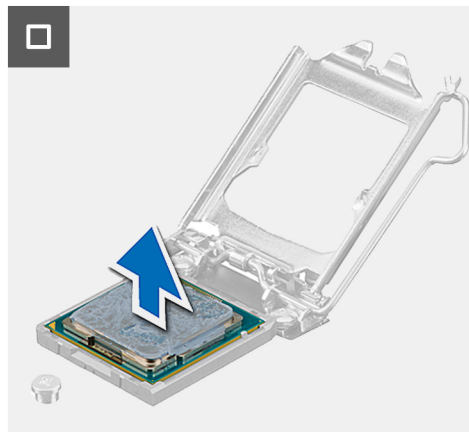
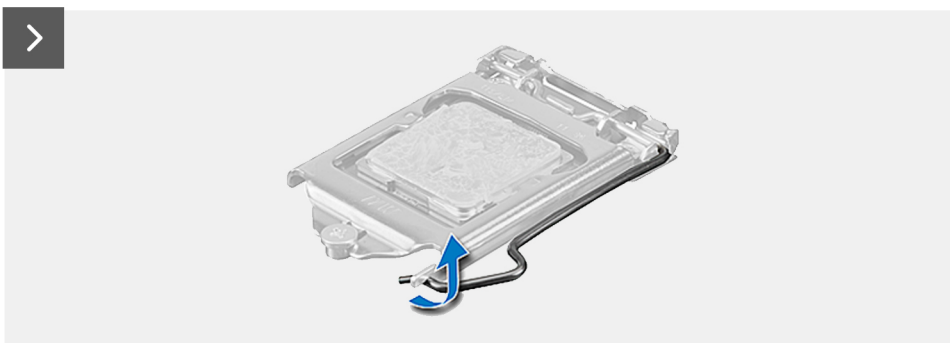
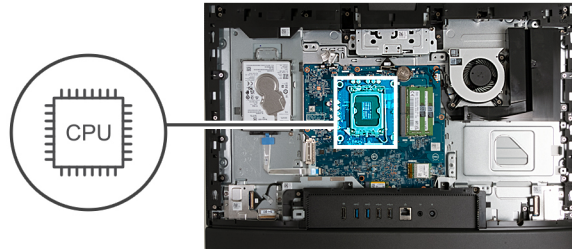

### Steps

1. Press the release lever down and then push it away from the processor to release it from the securing tab.
2. Extend the release lever completely and open the processor cover.

**CAUTION:** When removing the processor, do not touch any of the pins inside the socket or allow any objects to fall on the pins in the socket.

3. Gently lift the processor from the processor socket.

## Installing the processor

### Prerequisites

If you are replacing a component, remove the existing component before performing the installation process.

## About this task

**i** **NOTE:** If either the processor or the fan and heat sink is replaced, use the thermal grease provided in the kit to ensure that thermal conductivity is achieved.

The following image(s) indicate the location of the processor and provides a visual representation of the installation procedure.

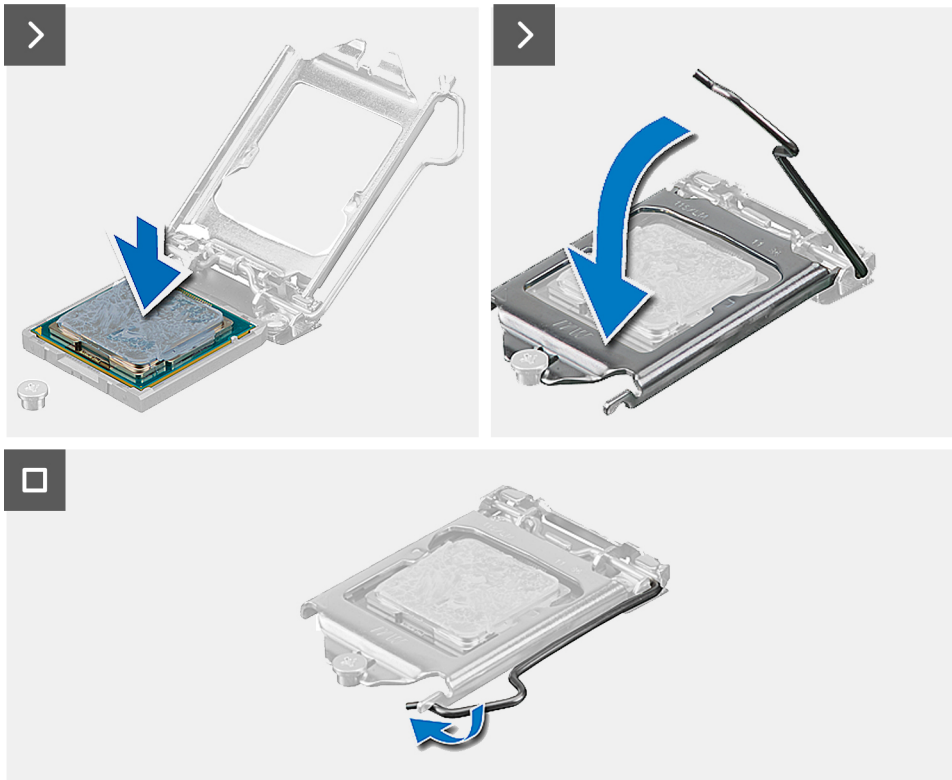
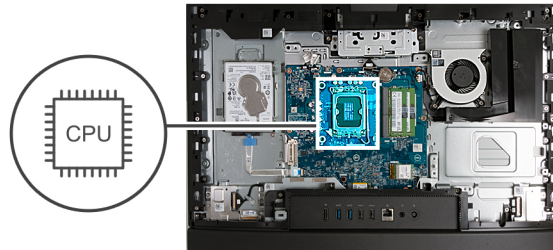

## Steps

1. Ensure that the release lever on the processor socket is fully extended in the open position.

**i** **NOTE:** The pin-1 corner of the processor has a triangle that aligns with the triangle on the pin-1 corner on the processor socket. When the processor is properly seated, all four corners are aligned at the same height. If one or more corners of the processor are higher than the others, the processor is not seated properly.

2. Align the notches on the processor with the tabs on the processor socket and place the processor in the processor socket.

**⚠ CAUTION:** Ensure that the processor-cover notch is positioned underneath the alignment post.

3. When the processor is fully seated in the socket, pivot the release-lever down and place it under the tab on the processor cover.

## Next steps

1. Install the [heat sink](#).
2. Install the [system-board shield](#).
3. Install the [back cover](#).
4. Install the [stand](#).

5. Follow the procedure in [After working inside your computer](#).

## System board

### Removing the system board

#### Prerequisites

1. Follow the procedure in [Before working inside your computer](#).
2. Remove the [stand](#).
3. Remove the [back cover](#).
4. Remove the [memory](#).
5. Remove the [system-board shield](#).
6. Remove the [I/O cover](#).
7. Remove the [bottom cover](#).
8. Remove the [I/O bracket](#).
9. Remove the [M.2 2230 solid-state drive](#) or the [M.2 2280 solid-state drive](#), whichever applicable.
10. Remove the [wireless card](#).
11. Remove the [heat sink](#).
12. Remove the [processor](#).

#### About this task

 **NOTE:** Replacing the system board removes any changes that you have made to the BIOS using the BIOS setup program. Make the appropriate changes again after you replace the system board.

The following image indicates the connectors on your system-board.

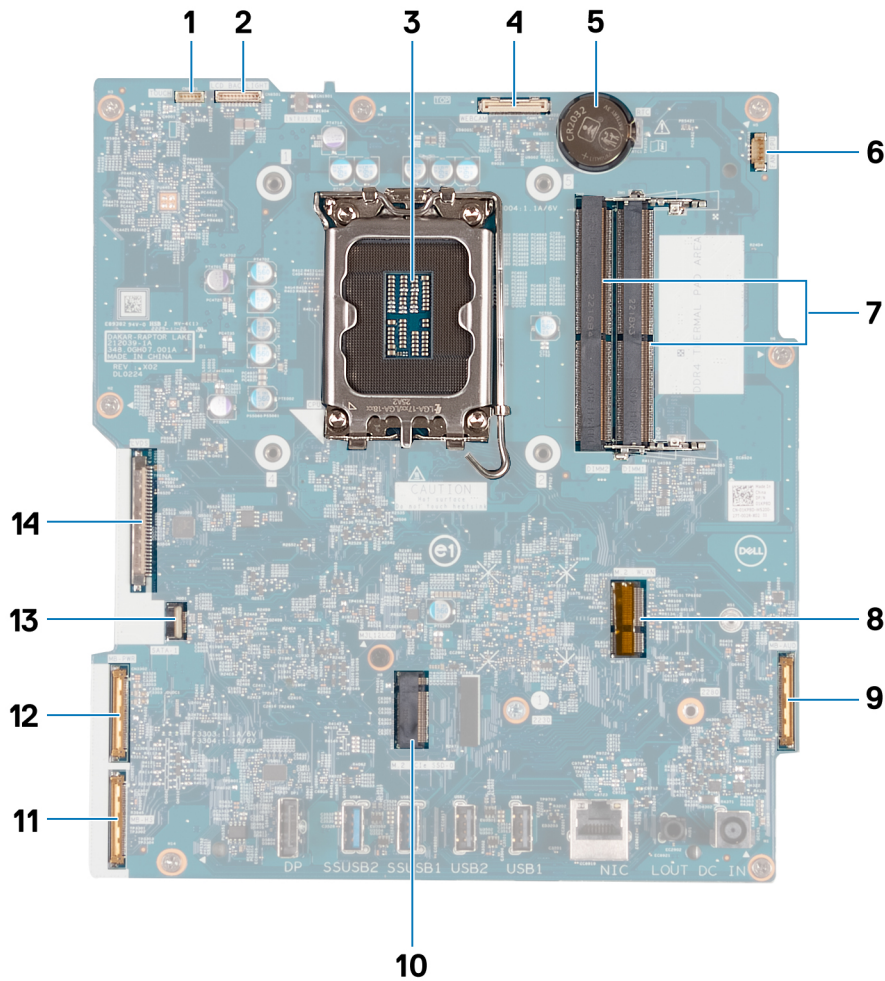

1. Touchscreen cable (TOUCH)
2. Display-backlight cable (LCD BACKLIGHT)
3. Processor socket (CPU)
4. Camera cable (WEBCAM)
5. Coin-cell battery socket (RTC)
6. Fan cable (FAN CPU)
7. Memory slots x2 (DIMM1 + DIMM2)
8. Wireless-card slot (M.2 WLAN)
9. Audio cable (MB-AUDIO)
10. Solid-state drive slot (M.2 PCIe SSD 0)
11. high-speed cable (MB-HS)
12. power cable (MB-PWR)
13. hard-drive cable (SATA 1)
14. display cable (CVDS)

The following image(s) indicate the location of the system board and provides a visual representation of the removal procedure.



7x  
M3x5



1x  
M3x12

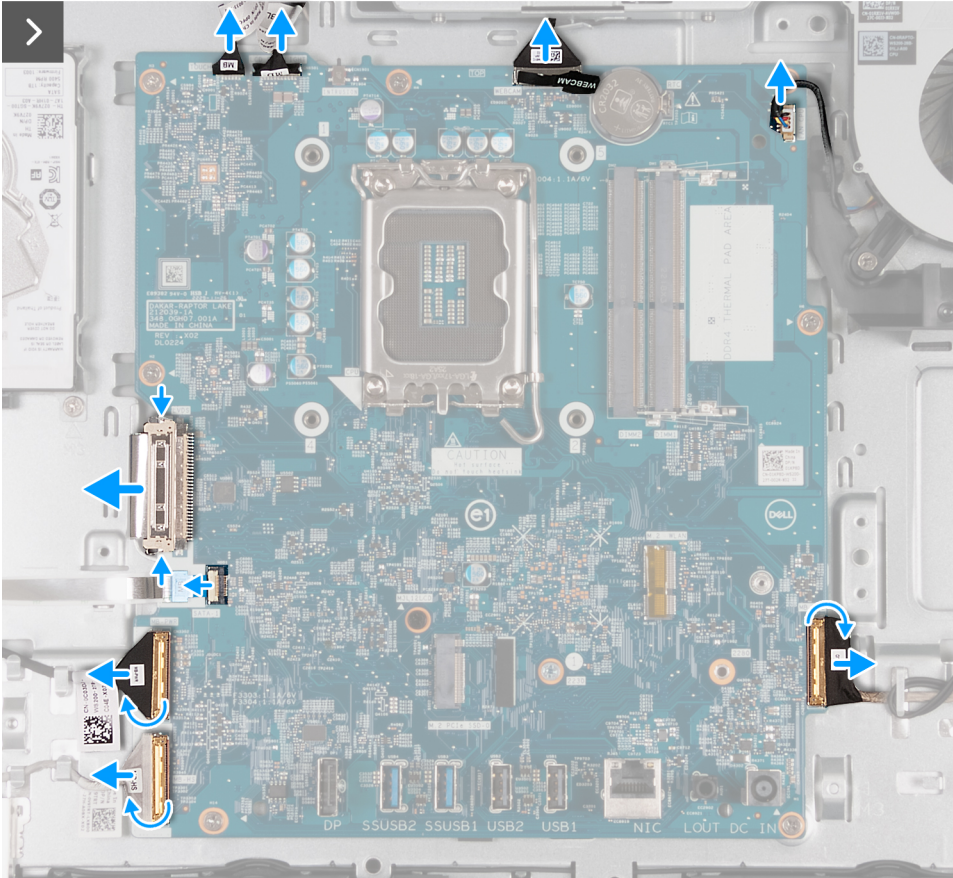
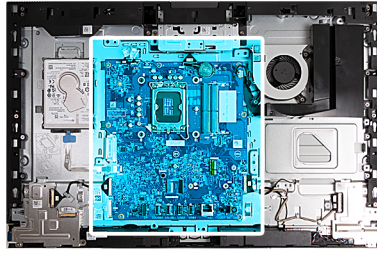

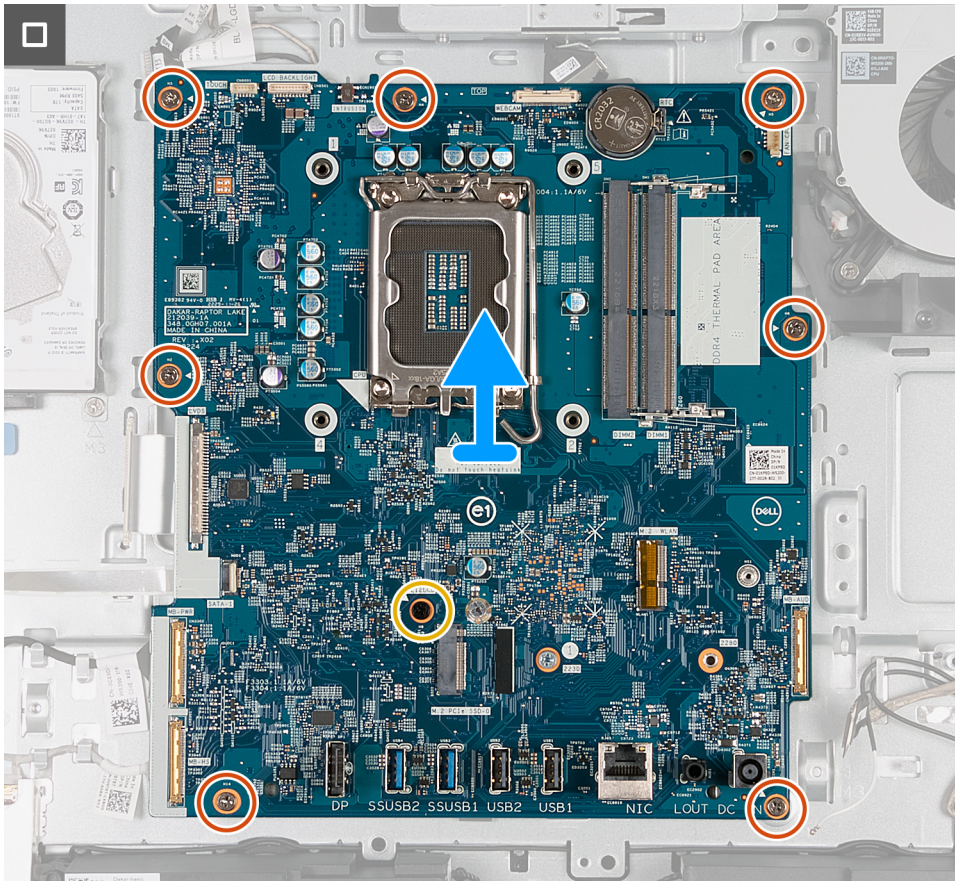

## Steps

1. Disconnect the touchscreen cable (TOUCH) from the system board.
2. Disconnect the display-backlight cable (LCB BACKLIGHT) from the system board.
3. Using the pull tab, disconnect the camera cable (WEBCAM) from the system board.
4. Disconnect the fan cable (FAN CPU) from the system board.
5. Lift the latch and disconnect the audio cable (MB-AUDIO) from the system board.
6. Lift the latch and disconnect the high-speed cable (MB-HS) from the system board.
7. Lift the latch and disconnect the power cable (MB-PWR) from the system board.
8. Pinching the securing clips on either side of the hard-drive cable connector, disconnect the display cable (CVDS) from the system board.
9. Lift the latch and disconnect the hard-drive cable (SATA 1) from the system board.
10. Remove the seven screws (M3x5) that secure the system board to the display-assembly base.
11. Remove the screw (M3x12) that secures the system board to the display-assembly base.
12. Gently lift the system board off the display-assembly base.

## Installing the system board

### Prerequisites

If you are replacing a component, remove the existing component before performing the installation process.

### About this task

- NOTE:** Replacing the system board removes any changes that you have made to the BIOS using the BIOS setup program. Make the appropriate changes again after you replace the system board.

The following image indicates the connectors on your system-board.

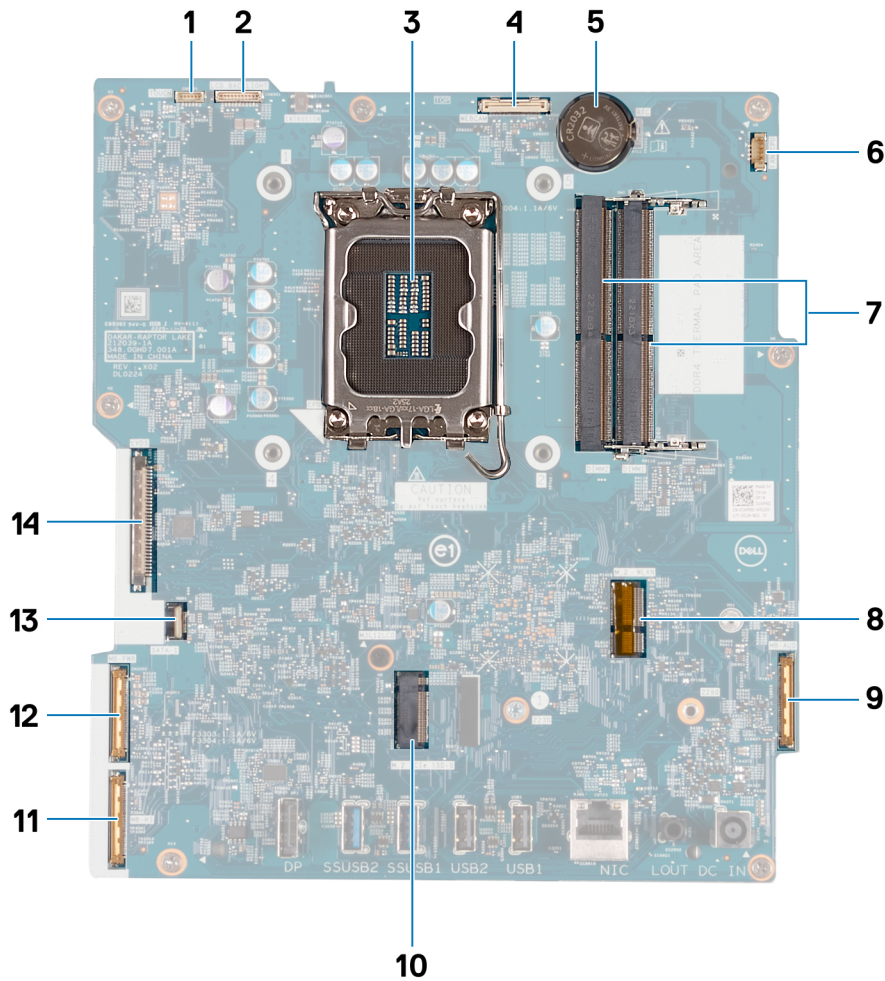

1. Touchscreen cable (TOUCH)
2. Display-backlight cable (LCD BACKLIGHT)
3. Processor socket (CPU)
4. Camera cable (WEBCAM)
5. Coin-cell battery socket (RTC)
6. Fan cable (FAN CPU)
7. Memory slots x2 (DIMM1 + DIMM2)
8. Wireless-card slot (M.2 WLAN)
9. Audio cable (MB-AUDIO)
10. Solid-state drive slot (M.2 PCIe SSD 0)
11. high-speed cable (MB-HS)
12. power cable (MB-PWR)
13. hard-drive cable (SATA 1)
14. display cable (CVDS)

The following image(s) indicate the location of the system board and provides a visual representation of the installation procedure.





7x  
M3x5



1x  
M3x12

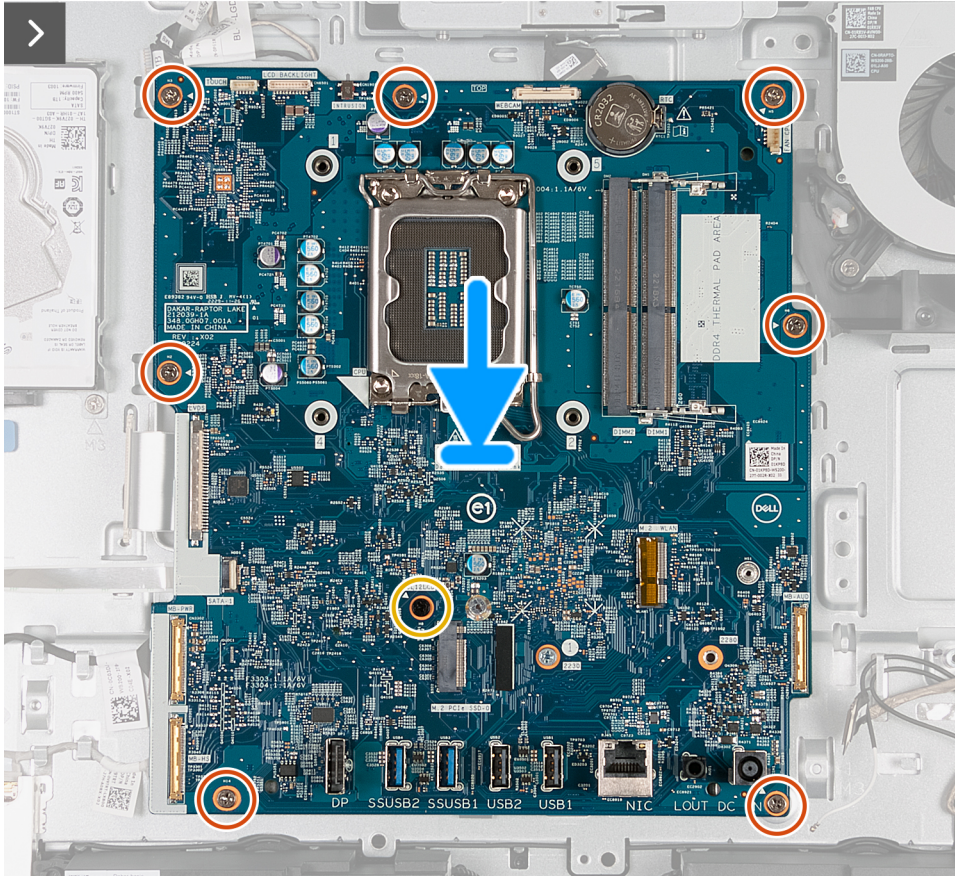
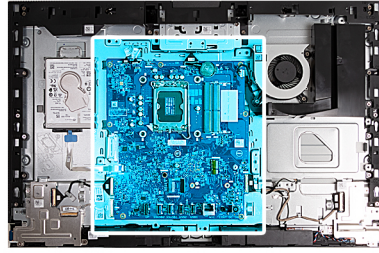

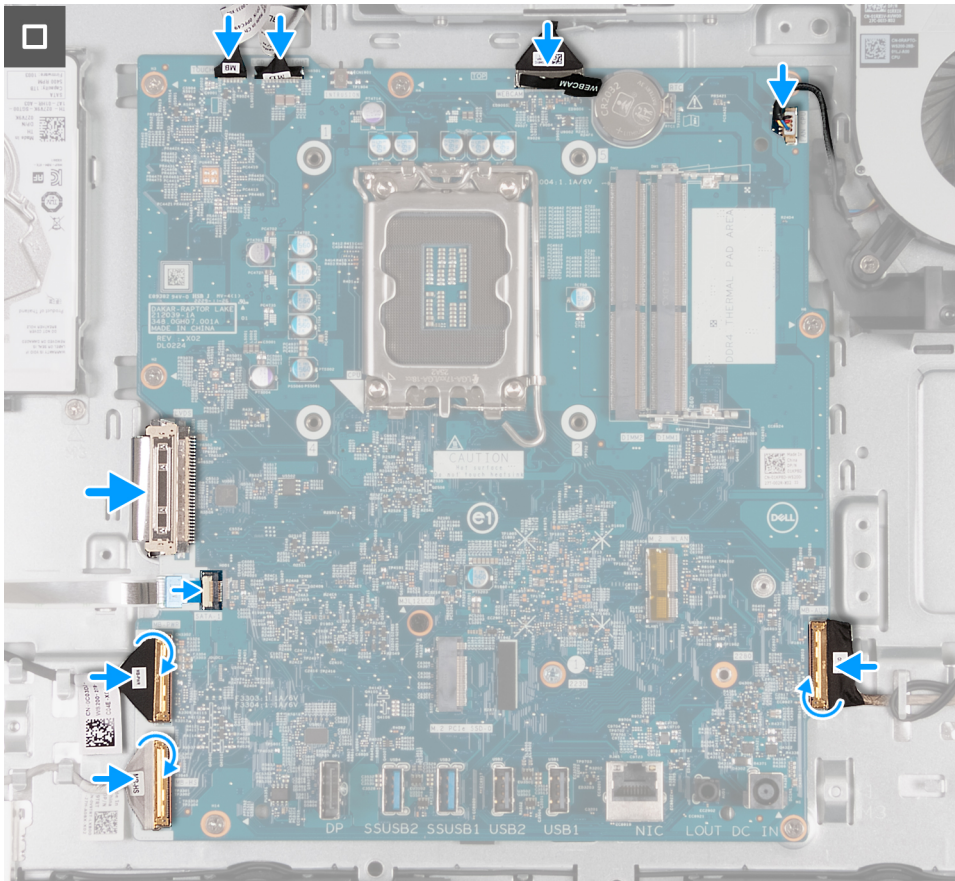

### Steps

1. Gently place the system board on the display-assembly base.
2. Align the screw holes on the system board with the screw holes on the display-assembly base.
3. Replace the seven screws (M3x5) that secure the system board to the display-assembly base.
4. Replace the screw (M3x12) that secures the system board to the display-assembly base.
5. Connect the touchscreen cable (TOUCH) to the system board.
6. Connect the display-backlight cable (LCB BACKLIGHT) to the system board.
7. Connect the camera cable (WEBCAM) to the system board.
8. Connect the fan cable (FAN CPU) to the system board.
9. Connect the audio cable (MB-AUDIO) to the system board and close the latch.
10. Connect the high-speed cable (MB-HS) to the system board and close the latch.
11. Connect the power cable (MB-PWR) to the system board and close the latch.
12. Connect the display cable (CVDS) to the system board.
13. Connect the hard-drive cable (SATA 1) to the system board and close the latch.

### Next steps

1. Install the [processor](#).
2. Install the [heat sink](#).
3. Install the [wireless card](#).
4. Install the [M.2 2230 solid-state drive](#) or the [M.2 2230 solid-state drive](#), whichever applicable.
5. Install the [I/O bracket](#).
6. Install the [bottom cover](#).
7. Install the [I/O cover](#).
8. Install the [system-board shield](#).
9. Install the [memory](#).
10. Install the [back cover](#).

11. Install the [stand](#).
12. Follow the procedure in [After working inside your computer](#).

## Power-button and I/O board

### Removing the power-button and I/O board

#### Prerequisites

1. Follow the procedure in [Before working inside your computer](#).
2. Remove the [stand](#).
3. Remove the [back cover](#).
4. Remove the [system-board shield](#).
5. Remove the [I/O cover](#).
6. Remove the [bottom cover](#).
7. Remove the [I/O bracket](#).

#### About this task

The following image(s) indicate the location of the power-button and I/O board and provides a visual representation of the removal procedure.



**5x**  
M3x5

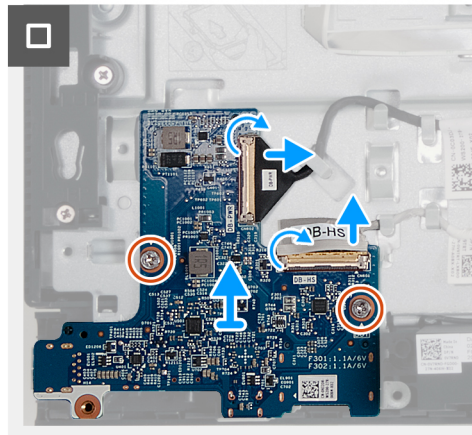
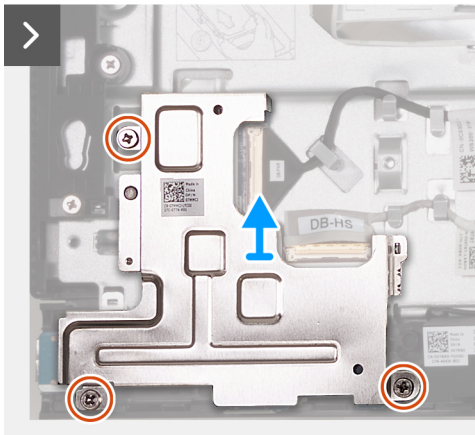
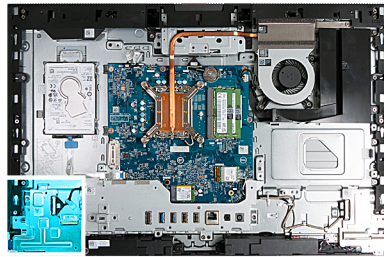

#### Steps

1. Remove the three screws (M3x5) that secure the power-button and I/O board shield to the display-assembly base.
2. Lift the power-button and I/O board shield off the display-assembly base.
3. Lift the latch and disconnect the power cable (DB-PWR) from the power-button and I/O board.
4. Lift the latch and disconnect the high-speed cable (DB-HS) from the power-button and I/O board.
5. Remove the two screws (M3x5) that secure the power-button and I/O board to the display-assembly base.
6. Lift the power-button and I/O board off the display-assembly base.

## Installing the power-button and I/O board

### Prerequisites

If you are replacing a component, remove the existing component before performing the installation process.

### About this task

The following image(s) indicate the location of the power-button and I/O board and provides a visual representation of the installation procedure.



5x  
M3x5

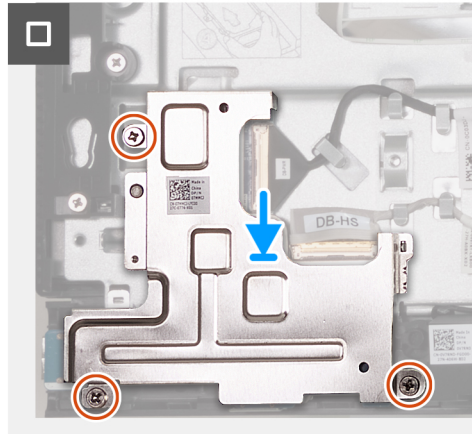
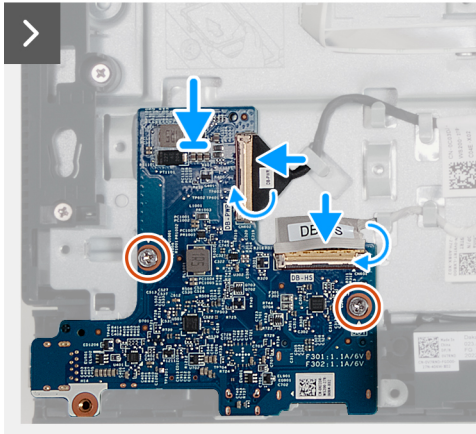
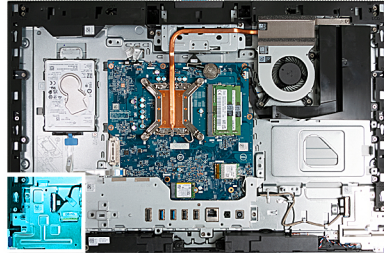

### Steps

1. Place the power-button and I/O board on the display-assembly base.
2. Align the screw holes on the power-button and I/O board with the screw holes on the display-assembly base.
3. Replace the two screws (M3x5) that secure the power-button and I/O board to the display-assembly base.
4. Connect the power cable (DB-PWR) to the power-button and I/O board and close the latch.
5. Connect the high-speed cable (DB-PWR) to the power-button and I/O board and close the latch.
6. Place the power-button and I/O board shield on the display-assembly base.
7. Align the screw holes on the power-button and I/O board shield with the screw holes on the display-assembly base.
8. Replace the three screws (M3x5) that secure the power-button and I/O board shield to the display-assembly base.

### Next steps

1. Install the [I/O bracket](#).
2. Install the [bottom cover](#).
3. Install the [I/O cover](#).
4. Install the [system-board shield](#).
5. Install the [back cover](#).
6. Install the [stand](#).
7. Follow the procedure in [After working inside your computer](#).

# Audio board

## Removing the audio board

### Prerequisites

1. Follow the procedure in [Before working inside your computer](#).
2. Remove the [stand](#).
3. Remove the [back cover](#).
4. Remove the [system-board shield](#).
5. Remove the [I/O cover](#).
6. Remove the [bottom cover](#).
7. Remove the [I/O bracket](#).

### About this task

The following image(s) indicate the location of the audio board and provides a visual representation of the removal procedure.



5x  
M3x5

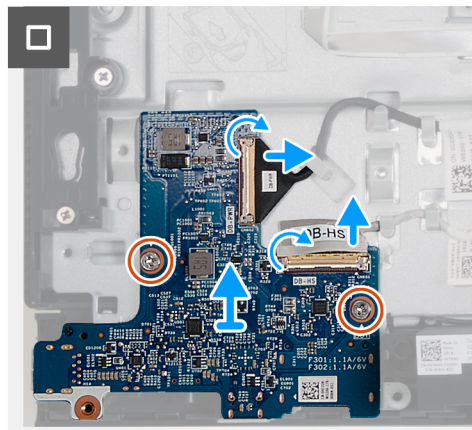
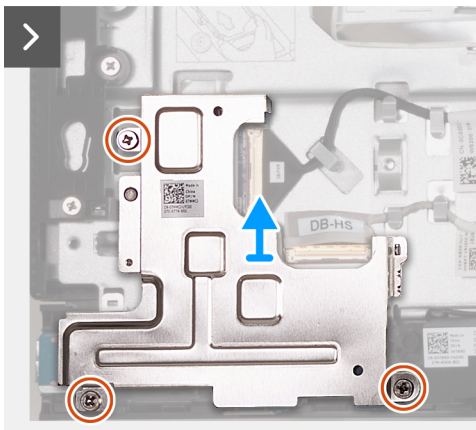
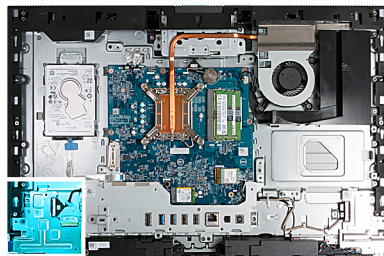

### Steps

1. Remove the three screws (M3x5) that secure the audio-board shield to the display-assembly base.
2. Lift the audio-board shield off the display-assembly base.
3. Lift the latch and disconnect the audio cable (DB-AUDIO) from the audio board.
4. Disconnect the speaker cable (INT SPKR) from the audio board.
5. Remove the two screws (M3x5) that secure the audio board to the display-assembly base.
6. Lift the audio board off the display-assembly base.

## Installing the audio board

### Prerequisites

If you are replacing a component, remove the existing component before performing the installation process.

## About this task

The following image(s) indicate the location of the audio board and provides a visual representation of the installation procedure.



5x  
M3x5

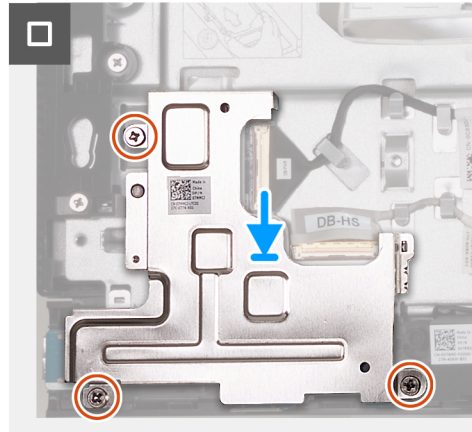
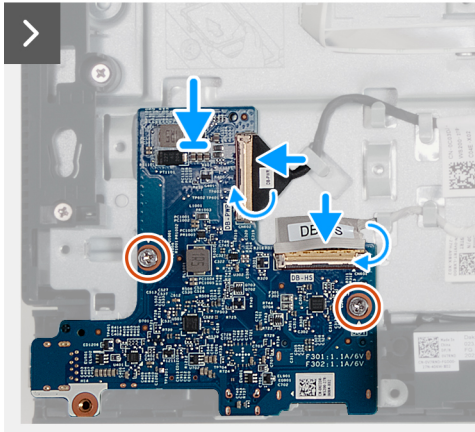
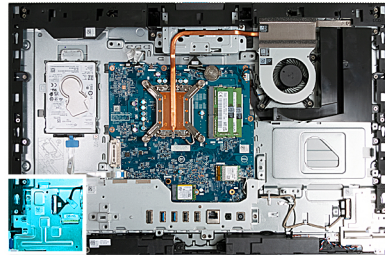

## Steps

1. Place the audio board on the display-assembly base.
2. Align the screw holes on the audio board with the screw holes on the display-assembly base.
3. Replace the two screws (M3x5) that secure the audio board to the display-assembly base.
4. Connect the power cable (DB-PWR) to the audio board and close the latch.
5. Connect the high-speed cable (DB-PWR) to the audio board and close the latch.
6. Place the audio-board shield on the display-assembly base.
7. Align the screw holes on the audio-board shield with the screw holes on the display-assembly base.
8. Replace the three screws (M3x5) that secure the audio-board shield to the display-assembly base.

## Next steps

1. Install the [I/O bracket](#).
2. Install the [bottom cover](#).
3. Install the [I/O cover](#).
4. Install the [system-board shield](#).
5. Install the [back cover](#).
6. Install the [stand](#).
7. Follow the procedure in [After working inside your computer](#).

## Display-assembly base

### Removing the display-assembly base

#### Prerequisites

1. Follow the procedure in [Before working inside your computer](#).
2. Remove the [stand](#).
3. Remove the [back cover](#).

4. Remove the [system-board shield](#).
5. Remove the [wireless card](#).
6. Remove the [hard drive](#).
7. Remove the [I/O cover](#).
8. Remove the [bottom cover](#).
9. Remove the [retractable-camera assembly](#).
10. Remove the [fan](#).
11. Remove the [I/O bracket](#).
12. Remove the [speakers](#).
13. Remove the [heat sink](#).
14. Remove the [system board](#).

**i** **NOTE:** The system board can be removed with the memory, solid-state drive, coin-cell battery, and processor attached.

15. Remove the [audio board](#).
16. Remove the [power-button and I/O board](#).

### About this task

**i** **NOTE:** The display-assembly base includes the following components:

- antenna modules
- display panel
- middle frame

To replace any of these components, replace the entire display-assembly base.

The following image(s) indicate the location of the display-assembly base and provides a visual representation of the removal procedure.

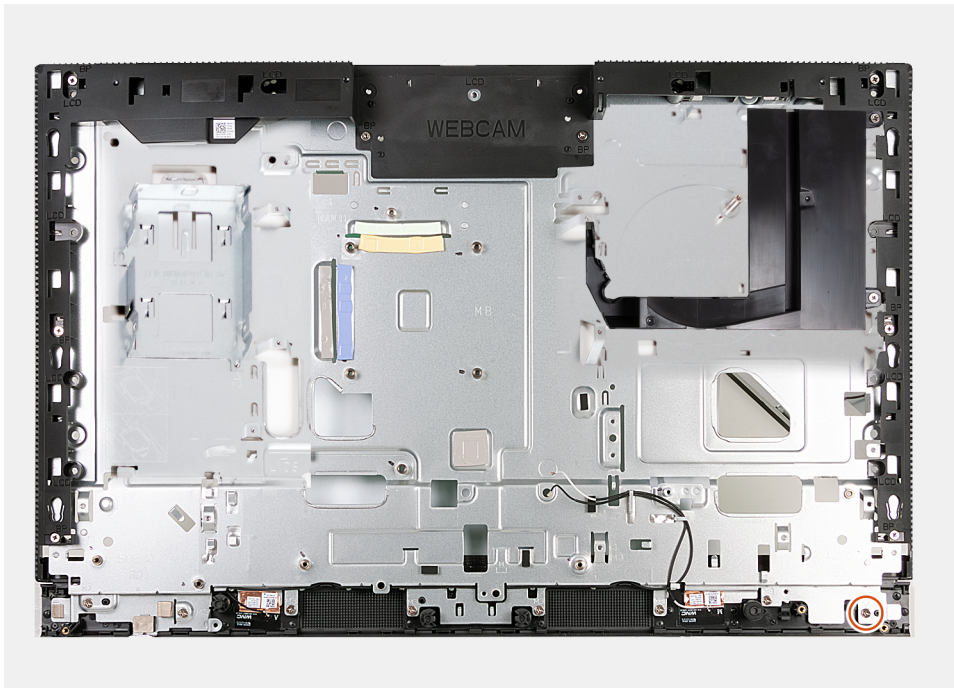

### Steps

After performing the pre-requisites you are left with the display-assembly base.

## Installing the display-assembly base

### Prerequisites

If you are replacing a component, remove the existing component before performing the installation process.

## About this task

**NOTE:** The display-assembly base includes the following components:

- antenna modules
- display panel
- middle frame

To replace any of these components, replace the entire display-assembly base.

The following image(s) indicate the location of the display-assembly base and provides a visual representation of the installation procedure.

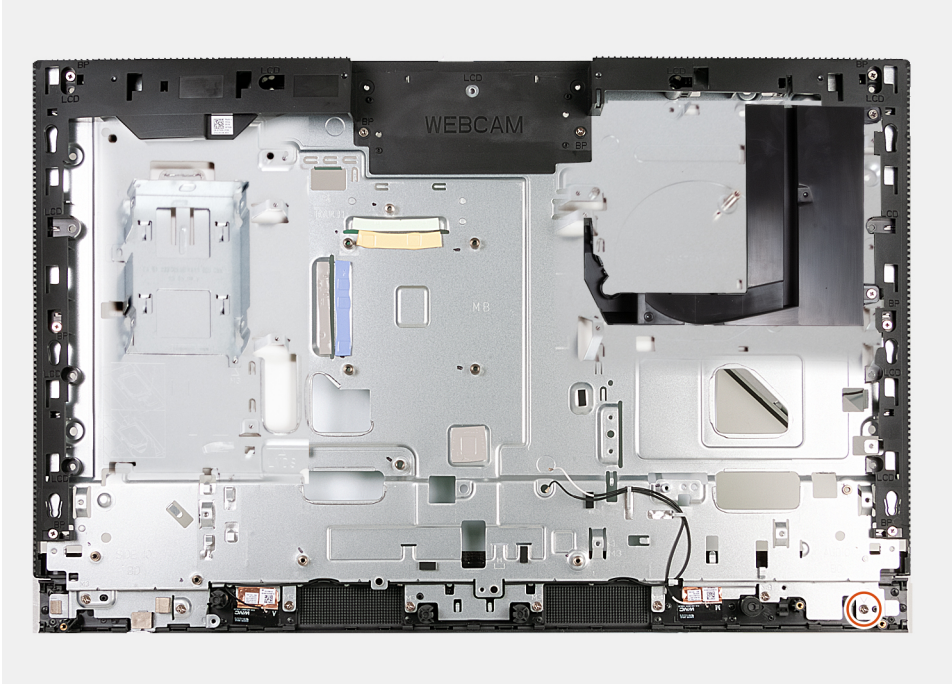

## Steps

To install the display-assembly base, perform all the post-requisite procedures.

## Next steps

1. Install the [power-button and I/O board](#).
2. Install the [audio board](#).
3. Install the [system board](#).

**NOTE:** The system board can be installed with the memory, solid-state drive, coin-cell battery, and processor pre-attached.

4. Install the [heat sink](#).
5. Install the [speakers](#).
6. Install the [I/O bracket](#).
7. Install the [fan](#).
8. Install the [retractable-camera assembly](#).
9. Install the [bottom cover](#).
10. Install the [I/O cover](#).
11. Install the [hard drive](#).
12. Install the [wireless card](#).
13. Install the [system-board shield](#).
14. Install the [back cover](#).
15. Install the [stand](#).
16. Follow the procedure in [After working inside your computer](#).



# Software

This chapter details the supported operating systems along with instructions on how to install the drivers.

## Operating system

Your OptiPlex All-in-One 7410 supports the following operating systems:

- Windows 11 Home, 64-bit
- Windows 11 Pro, 64-bit
- Windows 11 Pro Downgrade (Windows 10 image)
- Windows 11 Pro National Education, 64-bit
- Windows 10 CMIT Government Edition (China only)
- Ubuntu Linux 22.04 LTS, 64-bit

## Drivers and downloads

When troubleshooting, downloading or installing drivers it is recommended that you read the Dell Knowledge Base article, Drivers and Downloads FAQ [000123347](#).

## BIOS setup

**CAUTION:** Unless you are an expert computer user, do not change the settings in the BIOS Setup program. Certain changes can make your computer work incorrectly.

**NOTE:** Depending on the computer and its installed devices, the items listed in this section may or may not be displayed.

**NOTE:** Before you change BIOS Setup program, it is recommended that you write down the BIOS Setup program screen information for future reference.

Use the BIOS Setup program for the following purposes:

- Get information about the hardware installed in your computer, such as the amount of RAM and the size of the hard drive.
- Change the system configuration information.
- Set or change a user-selectable option, such as the user password, type of hard drive installed, and enabling or disabling base devices.

## Entering BIOS setup program

### About this task

Turn on (or restart) your computer and press F2 immediately.

## Navigation keys

**NOTE:** For most of the System Setup options, changes that you make are recorded but do not take effect until you restart the system.

**Table 27. Navigation keys**

Keys	Navigation
Up arrow	Moves to the previous field.
Down arrow	Moves to the next field.
Enter	Selects a value in the selected field (if applicable) or follow the link in the field.
Spacebar	Expands or collapses a drop-down list, if applicable.
Tab	Moves to the next focus area. <b>NOTE:</b> For the standard graphics browser only.
Esc	Moves to the previous page until you view the main screen. Pressing Esc in the main screen displays a message that prompts you to save any unsaved changes and restarts the system.

## One Time Boot menu

To enter **One Time Boot menu**, turn on your computer, and then press F12 immediately.

**NOTE:** It is recommended to shutdown the computer if it is on.

The one-time boot menu displays the devices that you can boot from including the diagnostic option. The boot menu options are:

- Removable Drive (if available)
- STXXXX Drive (if available)
- **i** **NOTE:** XXX denotes the SATA drive number.
- Optical Drive (if available)
- SATA Hard Drive (if available)
- Diagnostics

The boot sequence screen also displays the option to access the System Setup screen.

## System setup options

**i** **NOTE:** Depending on your computer and its installed devices, the items listed in this section may or may not appear.

**Table 28. System setup options—System information menu**

Overview	
BIOS Version	Displays the BIOS version number.
Service Tag	Displays the Service Tag of the computer.
Asset Tag	Displays the Asset Tag of the computer.
Manufacture Date	Displays the manufacture date of the computer.
Ownership Date	Displays the ownership date of the computer.
Express Service Code	Displays the express service code of the computer.
Ownership Tag	Displays the Ownership Tag of the computer.
Signed Firmware Update	Displays whether the Signed Firmware Update is enabled on your computer.
<b>Processor Information</b>	
Processor Type	Displays the processor type.
Maximum Clock Speed	Displays the maximum processor clock speed.
Minimum Clock Speed	Displays the minimum processor clock speed.
Current Clock Speed	Displays the current processor clock speed.
Core Count	Displays the number of cores on the processor.
Processor ID	Displays the processor identification code.
Processor L2 Cache	Displays the processor L2 Cache size.
Processor L3 Cache	Displays the processor L3 Cache size.
Microcode Version	Displays the microcode version.
Intel Hyper-Threading Capable	Displays whether the processor is Hyper-Threading (HT) capable.
64-Bit Technology	Displays whether 64-bit technology is used.
<b>Memory Information</b>	
Memory Installed	Displays the total computer memory installed.
Memory Available	Displays the total computer memory available.
Memory Speed	Displays the memory speed.
Memory Channel Mode	Displays single or dual channel mode.
Memory Technology	Displays the technology used for the memory.
DIMM_SLOT 1	Displays the DIMM 1 memory size.

**Table 28. System setup options—System information menu (continued)**

Overview	
DIMM_SLOT 2	Displays the DIMM 2 memory size.
<b>Devices Information</b>	
Panel Type	Displays the Panel Type of the computer.
Video Controller	Displays the video controller type of the computer.
Video Memory	Displays the video memory information of the computer.
Wi-Fi Device	Displays the wireless device information of the computer.
Native Resolution	Displays the native resolution of the computer.
Video BIOS Version	Displays the video BIOS version of the computer.
Audio Controller	Displays the audio controller information of the computer.
Bluetooth Device	Displays the Bluetooth device information of the computer.
LOM MAC Address	Displays the LAN On Motherboard (LOM) MAC address of the computer.
Slot 1	Displays the M.2 network information of the computer
SATA 0	Displays the SATA hard drive information of the computer.
Slot 2_M.2	Displays the M.2 PCIe SSD information of the computer.
Slot 3_M.2	Displays the M.2 PCIe SSD information of the computer.

**Table 29. System setup options—Boot Configuration menu**

Boot Configuration	
<b>Boot Sequence</b>	
Boot mode	Displays the boot mode.
Boot Sequence	Displays the boot sequence.
<b>Secure Digital (SD) Card Boot</b>	Enable or disable the SD card read-only boot. By default, the <b>Secure Digital (SD) Card Boot</b> option is not enabled.
<b>Secure Boot</b>	
Enable Secure Boot	Enable or disable the secure boot feature. By default, the option is not enabled.
Secure Boot Mode	Enable or disable to change the secure boot mode options. By default, the <b>Deployed Mode</b> is enabled.
<b>Expert Key Management</b>	
Enable Custom Mode	Enable or disable custom mode. By default, the <b>custom mode</b> option is not enabled.
Custom Mode Key Management	Select the custom values for expert key management.

**Table 30. System setup options—Integrated Devices menu**

Integrated Devices	
<b>Date/Time</b>	Displays the current date in MM/DD/YYYY format and current time in HH:MM:SS AM/PM format.
<b>Camera</b>	Enables or disable the camera. By default, the <b>Enable Camera</b> option is selected
<b>Audio</b>	

**Table 30. System setup options—Integrated Devices menu (continued)**

Integrated Devices	
Enable Audio	Enable or disable the integrated audio controller. By default, all the options are enabled.
<b>USB Configuration</b>	<ul style="list-style-type: none"> <li>Enable or disable booting from USB mass storage devices through the boot sequence or boot menu.</li> </ul> By default, all the options are enabled.
<b>Side USB Configuration</b>	Enable or disable the individual side USB ports. By default, the <b>Side USB Port 1 (Bottom)</b> and <b>Side USB Port 2 (Top)</b> option are enabled.
<b>Rear USB Configuration</b>	Enable or disable the individual rear USB ports. By default, all the options are enabled.

**Table 31. System setup options—Storage menu**

Storage	
<b>SATA Operation</b>	Enable or disable the operating mode of the integrated SATA hard drive controller. By default, the <b>RAID On</b> option is enabled.
<b>Storage Interface</b>	
Port Enablement	Enable or disable the onboard drives. By default, <b>SATA HDD</b> , <b>M.2 PCIe SSD-0</b> , and <b>M.2 PCIe SSD-1</b> options are enabled.
<b>SMART Reporting</b>	
Enable SMART Reporting	Enable or disable Self-Monitoring, Analysis, and Reporting Technology (SMART) during computer startup. By default, the <b>Enable SMART Reporting</b> option is not enabled.
<b>Drive Information</b>	
<b>SATA HDD</b>	
Type	Displays the SATA HDD type information of the computer.
Device	Displays the SATA HDD device information of the computer.
<b>M.2 PCIe SSD-0</b>	
Type	Displays the M.2 PCIe SSD-0 type information of the computer.
Device	Displays the M.2 PCIe SSD-0 device information of the computer.
<b>M.2 PCIe SSD-1</b>	
Type	Displays the M.2 PCIe SSD-1 type information of the computer.
Device	Displays the M.2 PCIe SSD-1 device information of the computer.
<b>Enable MediaCard</b>	
Secure Digital (SD) Card	Enable or disable the SD card. By default, the <b>Secure Digital (SD) Card</b> option is enabled.
Secure Digital (SD) Card Read-Only Mode	Enable or disable the SD card read-only mode. By default, the <b>Secure Digital (SD) Card Read-Only Mode</b> option is not enabled.

**Table 32. System setup options—Display menu**

Display	
<b>OSD Button Management</b>	
Disable OSD Buttons	Enable or disable the OSD (On-Screen Display) buttons on the computer.
<b>Full Screen Logo</b>	
	Enable or disable full screen logo. By default, the option is not enabled.

**Table 33. System setup options—Connection menu**

Connection	
<b>Network Controller Configuration</b>	
Integrated NIC	Controls the on-board LAN controller. By default, the <b>Enabled with PXE</b> option is enabled.
<b>Wireless Device Enable</b>	
WLAN	Enable or disable the internal WLAN device By default, the option enabled.
Bluetooth	Enable or disable the internal Bluetooth device By default, the option enabled.
<b>Enable UEFI Network Stack</b>	
	Enable or disable UEFI Network Stack and controls the on-board LAN Controller. By default, the option is enabled.
<b>HTTPs Boot Feature</b>	
HTTPs Boot	Enable or disable the HTTPs Boot feature. By default, the <b>HTTPs Boot</b> option is enabled.
HTTPs Boot Mode	With Auto Mode, the HTTPs Boot extracts Boot URL from the DHCP. With Manual Mode, the HTTPs Boot reads Boot URL from the user-provided data. By default, the <b>Auto Mode</b> option is enabled.

**Table 34. System setup options—Power menu**

Power	
<b>USB PowerShare</b>	
Enable USB PowerShare	Enable or disable the USB PowerShare. By default, the <b>Enable USB PowerShare</b> option is disabled
<b>USB Wake Support</b>	
Enable USB Wake Support	When enabled, you can use the USB devices like a mouse or keyboard to wake your computer from standby. By default, the option is enabled.
<b>AC Behavior</b>	
AC Recovery	Enables the system to turn on automatically, when AC is inserted. By default, the <b>Power Off</b> option is enabled.
<b>Block Sleep</b>	
	Enables to block entering sleep (S3) mode in the operating system. By default, the <b>Block Sleep</b> option is disabled.
<b>Deep Sleep Control</b>	
	Enable or disable the Deep Sleep mode support.

**Table 34. System setup options—Power menu (continued)**

Power	
<b>Fan Control Override</b>	<p>By default, the <b>Enabled in S4 and S5</b> option is enabled.</p> <p>Enable or disable the fan control override feature.</p> <p>By default, the option is disabled.</p>
<b>Intel Speed Shift Technology</b>	<p>Enable or disable the Intel speed shift technology support.</p> <p>By default, the <b>Intel Speed Shift Technology</b> option is enabled.</p>

**Table 35. System setup options—Security menu**

Security	
<b>TPM 2.0 Security</b>	
TPM 2.0 Security On	<p>Enable or disable TPM 2.0 security options.</p> <p>By default, the <b>TPM 2.0 Security On</b> option is enabled.</p>
Attestation Enable	<p>Enables to control whether the Trusted Platform Module (TPM) Endorsement Hierarchy is available to the operating system.</p> <p>By default, the <b>Attestation Enable</b> option is enabled.</p>
Key Storage Enable	<p>Enables to control whether the Trusted Platform Module (TPM) Storage Hierarchy is available to the operating system.</p> <p>By default, the <b>Key Storage Enable</b> option is enabled.</p>
SHA-256	<p>BIOS and the TPM will use the SHA-256 hash algorithm to extend measurements into the TPM PCRs during BIOS boot.</p> <p>By default, the <b>SHA-256</b> option is enabled.</p>
Clear	<p>Enables to clear the TPM owner information and returns the TPM to the default state.</p> <p>By default, the <b>Clear</b> option is disabled.</p>
PPI ByPass for Clear Commands	<p>Controls the TPM Physical Presence Interface (PPI).</p> <p>By default, the <b>PPI ByPass for clear Commands</b> option is disabled.</p>
<b>Chassis intrusion</b>	<p>Controls the chassis intrusion feature.</p> <p>By default, the option is disabled.</p>
<b>SMM Security Mitigation</b>	<p>Enable or disable SMM Security Mitigation.</p> <p>By default, the option is enabled.</p>
<b>Data Wipe on Next Boot</b>	
Start Data Wipe	<p>Enable or disable the data wipe on next boot.</p> <p>By default, the option is disabled.</p>
Absolute	<p>Enable or disable or permanently disable the BIOS module interface of the optional Absolute Persistence Module service from Absolute software.</p> <p>By default, the option is enabled.</p>
UEFI Boot Path Security	<p>Controls whether or not the computer will prompt the user to enter the admin password (if set) when booting to a UEFI boot device from the F12 boot menu.</p> <p>By default, the <b>Always Except Internal HDD</b> option is enabled.</p>
<b>Firmware Device Tamper Detection</b>	
Enable Firmware Device Tamper Detection	<p>Enables or disables Firmware Device Tamper Detection or Firmware Device Tamper Detection (Silent).</p>

**Table 35. System setup options—Security menu (continued)**

<b>Security</b>	
	By default the option for Firmware Device Tamper Detection (Silent) is enabled.
<b>Clear Firmware Device Tamper Detection</b>	
Enable Clear Firmware Device Tamper Detection	Allows the computer to clear the event and boot even when a tamper detection event has occurred.  By default the option is disabled.

**Table 36. System setup options—Passwords menu**

<b>Passwords</b>	
<b>Admin Password</b>	Set, change, or delete the administrator password.
<b>System Password</b>	Set, change, or delete the computer password.
<b>NVMe SSD0</b>	Set, change, or delete the NVMe SSD0 password.
<b>Password Configuration</b>	
Upper Case Letter	Reinforces password must have at least one upper case letter.  By default, the option is disabled.
Lower Case Letter	Reinforces password must have at least one lower case letter.  By default, the option is disabled.
Digit	Reinforces password must have at least one digit.  By default, the option is disabled.
Special Character	Reinforces password must have at least one special character.  By default, the option is disabled.
Minimum Characters	Set the minimum characters allowed for password.
Password Bypass	When enabled, this always prompts for computer and internal hard drive passwords when powered on from the off state.  By default, the <b>Disabled</b> option is enabled.
<b>Password Changes</b>	
Enable Non-Admin Password Changes	Enable or disable to change computer and hard drive password without the need for admin password.  By default, the option is enabled.
<b>Admin Setup Lockout</b>	
Enable Admin Setup Lockout	Enables administrators control over how their users can or cannot access BIOS setup.  By default, the option is disabled.
<b>Master Password Lockout</b>	
Enable Master Password Lockout	When enabled, this will disable the master password support.  By default, the option is disabled.
<b>Allow Non-Admin PSID Revert</b>	
Enable Allow Non-Admin PSID Revert	Controls access to the Physical Security ID (PSID) revert of NVMe hard-drives from the Dell Security Manager prompt.  By default, the option is disabled.



**Table 37. System setup options—Update, Recovery menu**

Update, Recovery	
<b>UEFI Capsule Firmware Updates</b>	Enable or disable BIOS updates through UEFI capsule update packages. By default, the option is enabled.
<b>BIOS Recovery from Hard Drive</b>	Enables the user to recover from certain corrupted BIOS conditions from a recovery file on the user primary hard drive or an external USB key. By default, the option is enabled.
<b>BIOS Downgrade</b> Allow BIOS Downgrade	Enable or disable the flashing of the computer firmware to previous revision is blocked. By default, the option is enabled.
<b>SupportAssist OS Recovery</b>	Enable or disable the boot flow for SupportAssist OS Recovery tool in the event of certain computer errors. By default, the option is enabled.
<b>BIOSConnect</b>	Enable or disable cloud Service OS recovery if the main operating system fails to boot with the number of failures equal to or greater than the value specified by the Auto OS Recovery Threshold setup option and local Service OS does not boot or is not installed. By default, the option is enabled.
<b>Dell Auto OS Recovery Threshold</b>	Controls the automatic boot flow for SupportAssist System Resolution Console and for Dell OS Recovery Tool. By default, the threshold value is set to 2.

**Table 38. System setup options—System Management menu**

System Management	
<b>Service Tag</b>	Display the Service Tag of the computer.
<b>Asset Tag</b>	Create a computer Asset Tag.
<b>Wake on LAN/WLAN</b>	Enable or disable the computer to power on by special LAN signals when it receives a wakeup signal from the WLAN. By default, the <b>Disabled</b> option is selected.
<b>Auto on Time</b>	Enable to set the computer to turn on automatically every day or on a preselected date and time. This option can be configured only if the Auto On Time is set to Everyday, Weekdays, or Selected Days. By default, the option is disabled.
<b>Intel AMT Capability</b> Enable Intel AMT Capability	Enable or disable the Intel AMT capability. By default, the <b>Restrict MEBx Access</b> option is enabled.
<b>MEBx Hotkey</b>	Enable or disable MEBx hotkey. By default, the option is disabled.
<b>USB Provision</b> Enable USB Provision	Enable or disable the Intel AMT provisioning using the local provisioning file through a USB storage device. By default, the option is disabled.
<b>SERR Messages</b>	Enable or disable SERR messages. By default, the option is enabled.

**Table 38. System setup options—System Management menu (continued)**

System Management	
<b>Keyboard Errors</b>	
Enable Keyboard Error Detection	
<b>Numlock LED</b>	
Enable Numlock LED	Enable or disable Numlock LED. By default, the option is enabled.

**Table 39. System setup options—Keyboard menu**

Keyboard	
<b>Keyboard Errors</b>	
Enable Keyboard Error Detection	Enable or disable the keyboard error detection. By default, the option is enabled.
<b>Numlock LED</b>	
Enable Numlock LED	Enable or disable Numlock LED. By default, the option is enabled.

**Table 40. System setup options—Pre-boot Behavior menu**

Pre-boot Behavior	
<b>Warning and Errors</b>	Enable or disable the action to be done when a warning or error is encountered. By default, the <b>Prompt on Warnings and Errors</b> option is enabled.
<b>Fastboot</b>	Enable to set the speed of the boot process. By default, the <b>Thorough</b> option is enabled.
<b>Extend BIOS POST Time</b>	Set the BIOS POST time. By default, the <b>0 seconds</b> option is enabled.

**Table 41. System setup options—Virtualization menu**

Virtualization	
<b>Intel Virtualization Technology</b>	
Enable Intel Virtualization Technology (VT)	Specify whether a Virtual Machine Monitor (VMM) can utilize the additional hardware capabilities provided by Intel Virtualization Technology. By default, the option is enabled.
<b>VT for Direct I/O</b>	Specify whether a Virtual Machine Monitor (VMM) can utilize the additional hardware capabilities provided by Intel Virtualization Technology for Direct I/O. By default, the option is enabled.
<b>Intel Trusted Execution Technology (TXT)</b>	
Enable Intel Trusted Execution Technology (TXT)	Specifies whether a measured Virtual Machine Monitor (MVMM) can utilize the additional hardware capabilities provided by Intel Trusted Execution Technology. By default, the option is disabled.

**Table 42. System setup options—Performance menu**

Performance	
<b>Multi-Core Support</b>	
Active Cores	Enables to change the number of CPU cores available to the operating system. By default, the <b>All Cores</b> options is enabled.
<b>Multiple Atom Cores</b>	
Atom cores	Allows you to change the number of Atom cores available to the operating system. By default, the value is set to the maximum number of Atom cores.
<b>Intel SpeedStep</b>	
Enable Intel SpeedStep Technology	Enables the computer to dynamically adjust processor voltage and core frequency, decreasing average power consumption and heat production. By default, the option is enabled.
<b>C-States Control</b>	
Enable C-State Control	Enable or disable additional processor sleep states. By default, the option is enabled.
<b>Intel Turbo Boost Technology</b>	
Enable Intel Turbo Boost Technology	Enable or disable Intel TurboBoost mode of the processor. By default, the option is enabled.
<b>Intel Hyper-Threading Technology</b>	
Enable Intel Hyper-Threading Technology	Enable or disable Hyper-Threading in the processor. By default, the option is enabled.
<b>PCIe Resizable Base Address Register (BAR)</b>	
Enable PCIe Resizable BAR support	Enable or disable PCIe Resizable Base Address Register (BAR) support. By default, the option is disabled.

**Table 43. System setup options—System Logs menu**

System Logs	
<b>BIOS Event Log</b>	
Clear BIOS Event Log	Display BIOS events. By default, the <b>Keep</b> option is enabled.

## Updating the BIOS

### Updating the BIOS in Windows

#### Steps

1. Go to [www.dell.com/support](http://www.dell.com/support).
2. Click **Product support**. In the **Search support** box, enter the Service Tag of your computer, and then click **Search**.

 **NOTE:** If you do not have the Service Tag, use the SupportAssist feature to automatically identify your computer. You can also use the product ID or manually browse for your computer model.

3. Click **Drivers & Downloads**. Expand **Find drivers**.
4. Select the operating system installed on your computer.
5. In the **Category** drop-down list, select **BIOS**.
6. Select the latest version of BIOS, and click **Download** to download the BIOS file for your computer.
7. After the download is complete, browse the folder where you saved the BIOS update file.
8. Double-click the BIOS update file icon and follow the on-screen instructions.

For more information about how to update the system BIOS, search in the Knowledge Base Resource at [www.dell.com/support](http://www.dell.com/support).

## Updating the BIOS using the USB drive in Windows

### Steps

1. Follow the procedure from step 1 to step 6 in [Updating the BIOS in Windows](#) to download the latest BIOS setup program file.
2. Create a bootable USB drive. For more information, search the Knowledge Base Resource at [www.dell.com/support](http://www.dell.com/support).
3. Copy the BIOS setup program file to the bootable USB drive.
4. Connect the bootable USB drive to the computer that needs the BIOS update.
5. Restart the computer and press **F12**.
6. Select the USB drive from the **One Time Boot Menu**.
7. Type the BIOS setup program filename and press **Enter**.  
The **BIOS Update Utility** appears.
8. Follow the on-screen instructions to complete the BIOS update.

## Updating the BIOS in Linux and Ubuntu

To update the system BIOS on a computer that is installed with Linux or Ubuntu, see the knowledge base article [000131486](#) at [www.dell.com/support](http://www.dell.com/support).

## Updating the BIOS from the F12 One Time Boot menu

Update your computer BIOS using the BIOS update.exe file that is copied to a FAT32 USB drive and booting from the F12 **One Time Boot** menu.

### About this task

#### BIOS Update

You can run the BIOS update file from Windows using a bootable USB drive or you can also update the BIOS from the F12 **One Time Boot** menu on the computer.

Most of the Dell computers built after 2012 have this capability, and you can confirm by booting your computer to the F12 **One Time Boot** Menu to see if BIOS FLASH UPDATE is listed as a boot option for your computer. If the option is listed, then the BIOS supports this BIOS update option.

 **NOTE:** Only computers with BIOS Flash Update option in the F12 **One Time Boot** menu can use this function.

### Updating from the One Time Boot menu

To update your BIOS from the F12 **One Time Boot** menu, you need the following:

- USB drive formatted to the FAT32 file system (key does not have to be bootable)
- BIOS executable file that you downloaded from the Dell Support website and copied to the root of the USB drive
- AC power adapter that is connected to the computer
- Functional computer battery to flash the BIOS

Perform the following steps to perform the BIOS update flash process from the F12 menu:

 **CAUTION:** Do not turn off the computer during the BIOS update process. The computer may not boot if you turn off your computer.

### Steps

1. From a turn off state, insert the USB drive where you copied the flash into a USB port of the computer.
2. Turn on the computer and press F12 to access the **One Time Boot** Menu, select BIOS Update using the mouse or arrow keys then press Enter.  
The flash BIOS menu is displayed.
3. Click **Flash from file**.
4. Select external USB device.
5. Select the file and double-click the flash target file, and then click **Submit**.
6. Click **Update BIOS**. The computer restarts to flash the BIOS.
7. The computer will restart after the BIOS update is completed.

## System and setup password

Table 44. System and setup password

Password type	Description
System password	Password that you must enter to log in to your system.
Setup password	Password that you must enter to access and make changes to the BIOS settings of your computer.

You can create a system password and a setup password to secure your computer.

 **CAUTION:** The password features provide a basic level of security for the data on your computer.

 **CAUTION:** Anyone can access the data that is stored on your computer if it is not locked and left unattended.

 **NOTE:** System and setup password feature is disabled.

## Assigning a system setup password

### Prerequisites

You can assign a new **System or Admin Password** only when the status is in **Not Set**.

### About this task

To enter the system setup, press F12 immediately after a power-on or reboot.

### Steps

1. In the **System BIOS** or **System Setup** screen, select **Security** and press Enter.  
The **Security** screen is displayed.
2. Select **System/Admin Password** and create a password in the **Enter the new password** field.  
Use the following guidelines to assign the system password:
  - A password can have up to 32 characters.
  - At least one special character: ! " # \$ % & ' ( ) \* + , - . / : ; < = > ? @ [ \ ] ^ \_ ` { | }
  - Numbers 0 through 9.
  - Upper case letters from A to Z.
  - Lower case letters from a to z.
3. Type the system password that you entered earlier in the **Confirm new password** field and click **OK**.
4. Press Esc and save the changes as prompted by the pop-up message.
5. Press Y to save the changes.  
The computer restarts.

# Deleting or changing an existing system setup password

## Prerequisites

Ensure that the **Password Status** is Unlocked (in the System Setup) before attempting to delete or change the existing System and/or Setup password. You cannot delete or change an existing System or Setup password, if the **Password Status** is Locked.

## About this task

To enter the System Setup, press F12 immediately after a power-on or reboot.

## Steps

1. In the **System BIOS** or **System Setup** screen, select **System Security** and press Enter.  
The **System Security** screen is displayed.
2. In the **System Security** screen, verify that **Password Status** is **Unlocked**.
3. Select **System Password**, update, or delete the existing system password, and press Enter or Tab.
4. Select **Setup Password**, update, or delete the existing setup password, and press Enter or Tab.  
 **NOTE:** If you change the System and/or Setup password, reenter the new password when prompted. If you delete the System and/or Setup password, confirm the deletion when prompted.
5. Press Esc and a message prompts you to save the changes.
6. Press Y to save the changes and exit from System Setup.  
The computer restarts.

# Clearing CMOS settings

## About this task

 **CAUTION:** Clearing CMOS settings will reset the BIOS settings on your computer.

## Steps

1. Follow the pre-requisites and procedures in [Removing the coin-cell battery](#), for computer with High Performance processors or [Removing the coin-cell battery](#), for computers with Energy Efficient processors.
2. Wait for one minute.
3. Follow the procedures and post-requisites in [Installing the coin-cell battery](#), for computer with High Performance processors or [Installing the coin-cell battery](#), for computers with Energy Efficient processors.

# Clearing BIOS (System Setup) and System passwords

## About this task

To clear the system or BIOS passwords, contact Dell technical support as described at [www.dell.com/contactdell](http://www.dell.com/contactdell).

 **NOTE:** For information on how to reset Windows or application passwords, refer to the documentation accompanying Windows or your application.

# Troubleshooting

## Dell SupportAssist Pre-boot System Performance Check diagnostics

### About this task

SupportAssist diagnostics (also known as system diagnostics) performs a complete check of your hardware. The Dell SupportAssist Pre-boot System Performance Check diagnostics is embedded with the BIOS and is launched by the BIOS internally. The embedded system diagnostics provides a set of options for particular devices or device groups allowing you to:

- Run tests automatically or in an interactive mode
- Repeat tests
- Display or save test results
- Run thorough tests to introduce additional test options to provide extra information about the failed device(s)
- View status messages that inform you if tests are completed successfully
- View error messages that inform you of problems encountered during testing

 **NOTE:** Some tests for specific devices require user interaction. Always ensure that you are present at the computer terminal when the diagnostic tests are performed.

For more information, see <https://www.dell.com/support/kbdoc/000180971>.

## Running the SupportAssist Pre-Boot System Performance Check

### Steps

1. Turn on your computer.
2. As the computer boots, press the F12 key as the Dell logo appears.
3. On the boot menu screen, select the **Diagnostics** option.
4. Click the arrow at the bottom left corner.  
Diagnostics front page is displayed.
5. Click the arrow in the lower-right corner to go to the page listing.  
The items detected are listed.
6. To run a diagnostic test on a specific device, press Esc and click **Yes** to stop the diagnostic test.
7. Select the device from the left pane and click **Run Tests**.
8. If there are any issues, error codes are displayed.  
Note the error code and validation number and contact Dell.

## Power-Supply Unit Built-in Self-Test

Built-in Self-Test (BIST) helps determine if the power-supply unit is working. To run self-test diagnostics on the power-supply unit of a desktop or all-in-one computer, search in the Knowledge Base Resource at [www.dell.com/support](http://www.dell.com/support).

# System-diagnostic lights

This section lists the system-diagnostic lights of your OptiPlex All-in-One 7410.

**Table 45. System-diagnostic lights**

Blinking pattern		Problem description	Suggested resolution
Amber	White		
1	1	TPM detection failure	Replace the system board.
1	2	Unrecoverable SPI Flash Failure	Replace the system board.
1	5	EC unable to program i-Fuse	Replace the system board.
1	6	Generic catch-all for ungraceful EC code flow errors	Disconnect all power source (AC, battery, coin cell) and drain flea power by pressing and holding down power button for 3~5 seconds.
2	1	CPU failure	<ul style="list-style-type: none"> <li>• Run the Dell Support Assist/Dell Diagnostics tool.</li> <li>• If problem persists, replace the system board.</li> </ul>
2	2	System board failure (included BIOS corruption or ROM error)	<ul style="list-style-type: none"> <li>• Flash latest BIOS version</li> <li>• If problem persists, replace the system board.</li> </ul>
2	3	No memory/RAM detected	<ul style="list-style-type: none"> <li>• Confirm that the memory module is installed properly.</li> <li>• If problem persists, replace the memory module.</li> </ul>
2	4	Memory/RAM failure	<ul style="list-style-type: none"> <li>• Reset and swap memory modules among the slots.</li> <li>• If problem persists, replace the memory module.</li> </ul>
2	5	Invalid memory installed	<ul style="list-style-type: none"> <li>• Reset and swap memory modules among the slots.</li> <li>• If problem persists, replace the memory module.</li> </ul>
2	6	System board/Chipset Error	Replace the system board.
2	7	LCD failure (SBIOS message)	Replace the LCD module.
2	8	LCD failure (EC detection of power rail failure)	Replace the system board.
3	1	CMOS battery failure	<ul style="list-style-type: none"> <li>• Reset the main battery connection.</li> <li>• If problem persists, replace the main battery.</li> </ul>
3	2	PCI or Video card/chip failure	Replace the system board.



**Table 45. System-diagnostic lights (continued)**

Blinking pattern		Problem description	Suggested resolution
Amber	White		
3	3	BIOS Recovery image not found	<ul style="list-style-type: none"> <li>Flash latest BIOS version</li> <li>If problem persists, replace the system board.</li> </ul>
3	4	BIOS Recovery image found but invalid	<ul style="list-style-type: none"> <li>Flash latest BIOS version</li> <li>If problem persists, replace the system board.</li> </ul>
3	5	Power rail failure	Replace the system board.
3	6	Flash corruption detected by SBIOS.	<ul style="list-style-type: none"> <li>Press power button for over 25 seconds to do RTC reset. If problem persists, replace the system board.</li> <li>Disconnect all power source (AC, battery, coin cell) and drain flea power by pressing and holding down power button 3~5 seconds to ensure all power are drained.</li> <li>Run "BIOS recovery from USB", and the instructions are in the website <a href="#">Dell support</a>.</li> <li>If problem persists, replace the system board.</li> </ul>
3	7	Timeout waiting on ME to reply to HECI message.	Replace the system board.

## Recovering the operating system

When your computer is unable to boot to the operating system even after repeated attempts, it automatically starts Dell SupportAssist OS Recovery.

Dell SupportAssist OS Recovery is a standalone tool that is preinstalled in all Dell computers installed with Windows operating system. It consists of tools to diagnose and troubleshoot issues that may occur before your computer boots to the operating system. It enables you to diagnose hardware issues, repair your computer, back up your files, or restore your computer to its factory state.

You can also download it from the Dell Support website to troubleshoot and fix your computer when it fails to boot into their primary operating system due to software or hardware failures.

For more information about the Dell SupportAssist OS Recovery, see *Dell SupportAssist OS Recovery User's Guide* at [www.dell.com/serviceabilitytools](http://www.dell.com/serviceabilitytools). Click **SupportAssist** and then, click **SupportAssist OS Recovery**.

## Real Time Clock—RTC reset

The Real Time Clock (RTC) reset function allows you or the service technician to recover the recently launched model Dell Latitude and Precision systems from **No POST/No Boot/No Power** situations. You can initiate the RTC reset on the system from a power-off state only if it is connected to AC power. Press and hold the power button for 25 seconds. The system RTC reset occurs after you release the power button.

**NOTE:** If AC power is disconnected from the system during the process or the power button is held longer than 40 seconds, the RTC reset process gets aborted.

The RTC reset will reset the BIOS to Defaults, un-provision Intel vPro and reset the system date and time. The following items are unaffected by the RTC reset:

- Service Tag
- Asset Tag
- Ownership Tag
- Admin Password
- System Password
- HDD Password
- Key Databases
- System Logs

 **NOTE:** The IT administrator's vPro account and password on the system will be un-provisioned. The system needs to go through the setup and configuration process again to reconnect it to the vPro server.

The below items may or may not reset based on your custom BIOS setting selections:

- Boot List
- Enable Legacy Option ROMs
- Secure Boot Enable
- Allow BIOS Downgrade

## Backup media and recovery options

It is recommended to create a recovery drive to troubleshoot and fix problems that may occur with Windows. Dell proposes multiple options for recovering Windows operating system on your Dell PC. For more information, see [Dell Windows Backup Media and Recovery Options](#).

## Wi-Fi power cycle

### About this task

If your computer is unable to access the Internet due to Wi-Fi connectivity issues a Wi-Fi power cycle procedure may be performed. The following procedure provides the instructions on how to conduct a Wi-Fi power cycle:

 **NOTE:** Some ISPs (Internet Service Providers) provide a modem/router combo device.

### Steps



1. Turn off your computer.
2. Turn off the modem.
3. Turn off the wireless router.
4. Wait for 30 seconds.
5. Turn on the wireless router.
6. Turn on the modem.
7. Turn on your computer.

# Getting help and contacting Dell

## Self-help resources

You can get information and help on Dell products and services using these self-help resources:

**Table 46. Self-help resources**

Self-help resources	Resource location
Information about Dell products and services	<a href="http://www.dell.com">www.dell.com</a>
My Dell app	
Tips	
Contact Support	In Windows search, type <code>Contact Support</code> , and press Enter.
Online help for operating system	<a href="http://www.dell.com/support/windows">www.dell.com/support/windows</a> <a href="http://www.dell.com/support/linux">www.dell.com/support/linux</a>
Access top solutions, diagnostics, drivers and downloads, and learn more about your computer through videos, manuals and documents.	Your Dell computer is uniquely identified by a Service Tag or Express Service Code. To view relevant support resources for your Dell computer, enter the Service Tag or Express Service Code at <a href="http://www.dell.com/support">www.dell.com/support</a> .  For more information on how to find the Service Tag for your computer, see <a href="#">Locate the Service Tag on your computer</a> .
Dell knowledge base articles for a variety of computer concerns	<ol style="list-style-type: none"> <li>1. Go to <a href="http://www.dell.com/support">www.dell.com/support</a>.</li> <li>2. On the menu bar at the top of the Support page, select <b>Support &gt; Knowledge Base</b>.</li> <li>3. In the Search field on the Knowledge Base page, type the keyword, topic, or model number, and then click or tap the search icon to view the related articles.</li> </ol>

## Contacting Dell

To contact Dell for sales, technical support, or customer service issues, see [www.dell.com/contactdell](http://www.dell.com/contactdell).

 **NOTE:** Availability varies by country/region and product, and some services may not be available in your country/region.

 **NOTE:** If you do not have an active Internet connection, you can find contact information about your purchase invoice, packing slip, bill, or Dell product catalog.