



ZH-S 用户手册 1

EN User manual 14



目录

1	您的空气净化器	2
	产品概述	2
	控件概述	3
2	使用入门	3
	安装滤网	3
	Wi-Fi 指示灯	4
	Wi-Fi 连接	4
3	使用空气净化器	4
	空气质量指示灯	4
	打开和关闭	5
	更改模式设置	6
	切换显示指示灯	7
	使用灯光开/关功能	7
	检查滤网状态	8
4	清洁和维护	8
	清洁空气净化器的机身	8
	清洁微粒感应器	8
	清洁滤网表面	9
	更换滤网	10
	滤网重置	11
5	存放	11
6	故障排除	12

1 您的空气净化器

感谢您的惠顾，欢迎光临飞利浦！

为了您能充分享受飞利浦提供的支持，请在以下网站注册您的产品：

www.philips.com/welcome。

产品概述

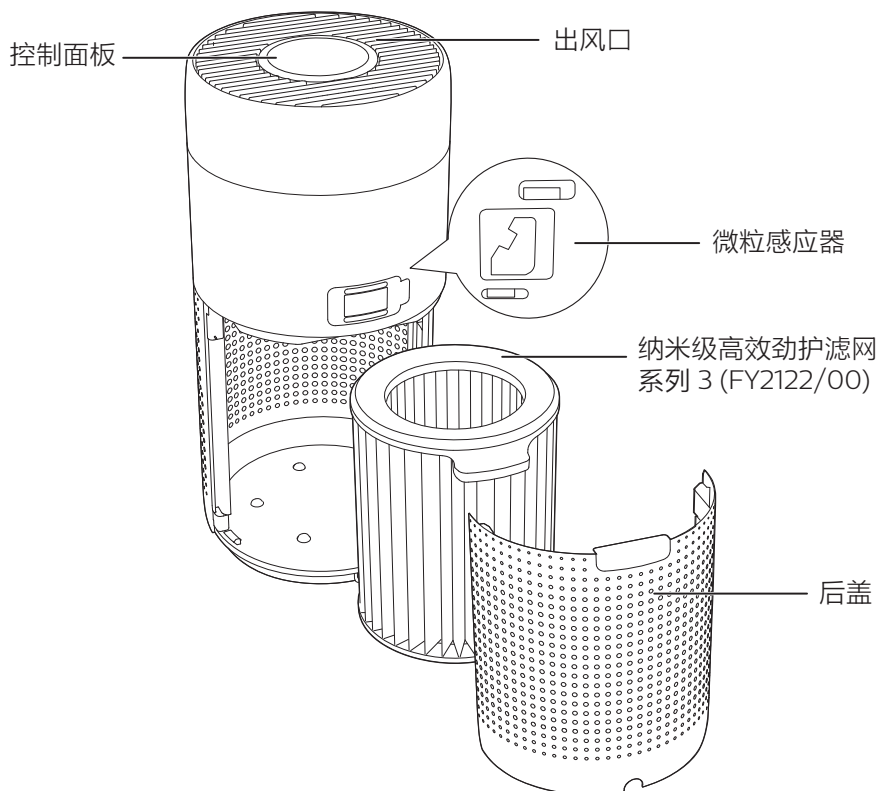

控件概述

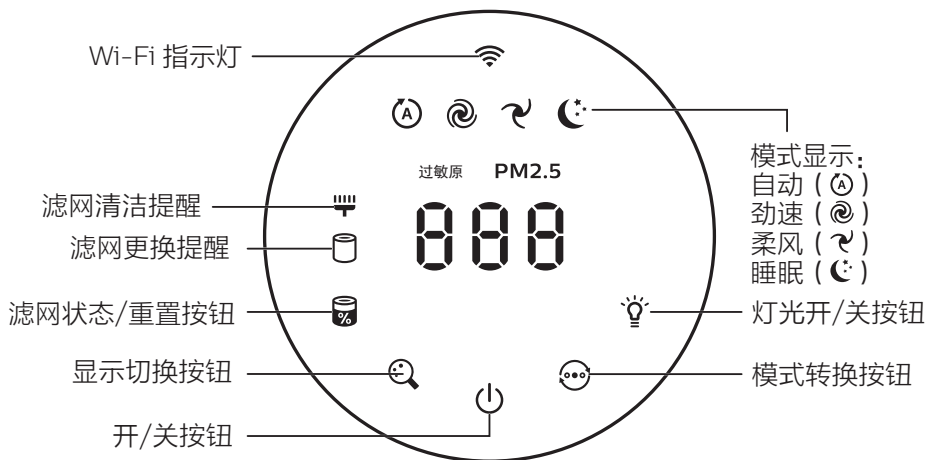

2 使用入门

安装滤网

注意：确保先从电源插座上拔下空气净化器的插头，然后再安装滤网。

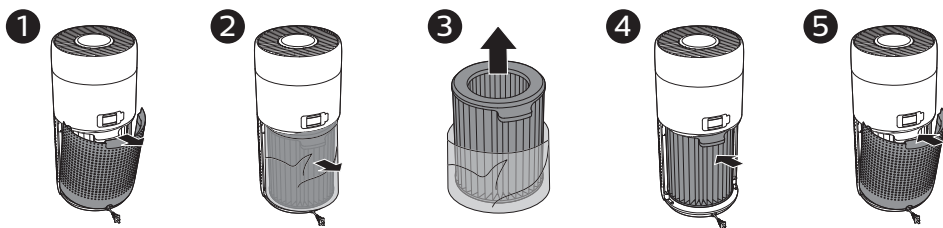

- 1 拉开后盖，并将其从产品上取下。
- 2 从产品上拉下滤网。
- 3 拆掉空气净化滤网的所有包装材料。
- 4 把滤网放回产品内。
- 5 重新装上后盖。

Wi-Fi 指示灯

Wi-Fi 图标状态	Wi-Fi 连接状态
呈橙色闪烁	正在连接智能手机
呈白色闪烁	正在连接路由器
白色常亮	已连接至路由器
关	Wi-Fi 功能已禁用

Wi-Fi 连接

首次连接

- 1 从苹果应用商店或安卓市场下载并安装飞利浦**智净家**应用程序。
- 2 将智能手机或平板电脑连接至 Wi-Fi 网络。
- 3 启动**智净家**应用程序并单击“**连接新设备**”或按屏幕顶部的“+”按钮。按照屏幕上的说明将空气净化器连接至您的网络。



重置 Wi-Fi 连接

- 1 轻触  和  3 秒钟，直至您听到蜂鸣音。
↳ Wi-Fi 指示灯  呈橙色闪烁。
- 2 按照“**首次连接**”部分中的 3 个步骤进行操作。

注意：请访问 www.philips.com/cleanhome 以查看是否有受支持的操作系统和设备可用的最新更新。

3 使用空气净化器

空气质量指示灯

大约 30 秒后，微粒感应器将选择与环境空气悬浮颗粒质量相对应的颜色。

注意：空气质量指示灯的颜色取决于 PM2.5、过敏原和指标读数中危险指数最高的那个参数。

PM2.5 是指尺寸小于 2.5 微米的悬浮颗粒污染物。

PM2.5 水平	空气质量指示灯颜色	空气质量级别
≤35	蓝色	良好
36 - 75	蓝紫色	一般
76 - 115	紫红色	较差
>115	红色	很差

过敏原是指室内空气过敏原的潜在风险级别。

过敏原级别	空气质量指示灯颜色	空气质量级别
1-3	蓝色	良好
4-6	蓝紫色	一般
7-9	紫红色	较差
10-12	红色	很差

打开和关闭

注意：

- 将空气净化器的插头插入电源插座。
- 如果空气净化器关闭后仍与电源插座连接，当再次打开时，它将恢复关闭前的运行（即设置不变）。

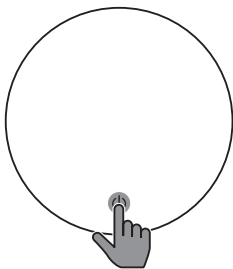

- 轻触  可打开空气净化器。

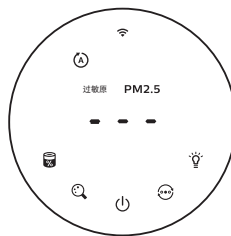

- 启动过程中，屏幕上会显示“---”。然后，空气净化器会在测量空气质量后显示 PM2.5/过敏原级别。

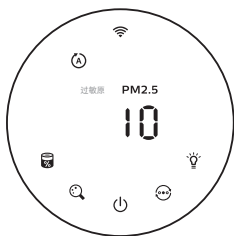

- 空气净化器将在自动模式下工作，并且屏幕上会显示 PM2.5。



- 轻触并按住  按钮 3 秒可关闭空气净化器。

更改模式设置

您可以轻触  按钮选择自动模式、劲速模式、柔风模式或睡眠模式。



自动模式 (A): 空气净化器会根据环境空气质量自动调节风速。

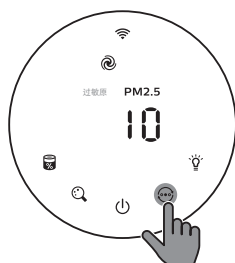

劲速模式 (@): 空气净化器会以最高速度运行。



柔风模式 (🌀): 空气净化器会以低速运行。

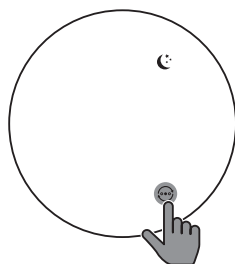

睡眠模式 (🌙): 空气净化器会以低速安静运行。3 秒钟后，屏幕会关闭。

切换显示指示灯

注意：

- 默认情况下，产品会显示 PM2.5 级别。

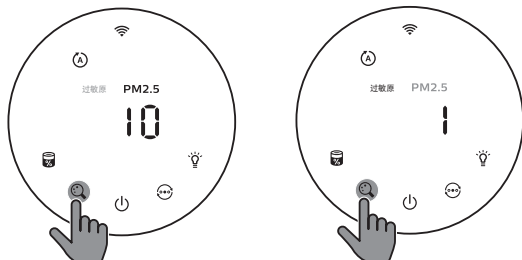

使用灯光开/关功能

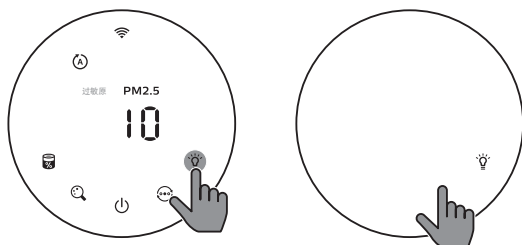

您可以手动轻触灯光开/关按钮  来关闭所有指示灯和控制面板。轻触任何按钮来唤醒所有指示灯。

借助光传感器：

- 控制面板可根据环境光线自动打开、关闭或变暗。
- 当环境光线变暗时，控制面板将关闭或变暗。

您可以轻触任何按钮来唤醒所有指示灯。如果没有进一步操作，所有的指示灯将再次关闭或变暗，以与环境光线保持协调。

检查滤网状态

- 轻触滤网状态检查/重置  按钮可查看滤网使用寿命状态。

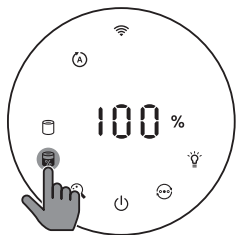

图标颜色	显示屏 (%)
蓝色	16-100
蓝紫色	9-15
紫红色	4-8
红色	0-3

注意：如果 3 秒后没有操作，产品将返回正常显示。

4 清洁和维护

注意：

- 请勿尝试用吸尘器清洁微粒感应器。
- 在进行以下操作之前，先关闭空气净化器并从电源插座上拔下插头。

清洁空气净化器的机身

使用柔软的干布清洁空气净化器的内部和外部及出风口。

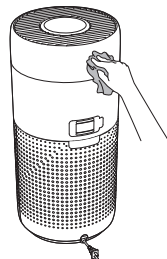

清洁微粒感应器

每 2 个月清洁一次微粒感应器，确保产品以理想性能运行。

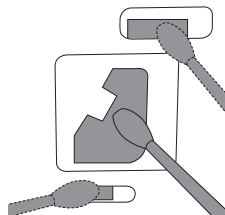
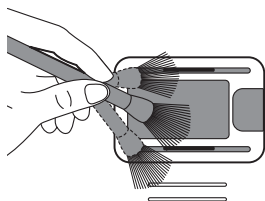

- 1 使用软毛刷清洁微粒感应器进风口和出风口。
- 2 使用湿棉签清洁微粒感应器。使用干棉签彻底擦干所有部件。

清洁滤网表面

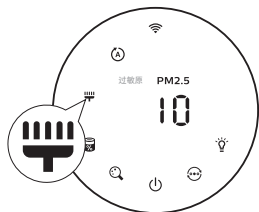

当屏幕上显示滤网清洁提醒  时，用吸尘器清洁滤网表面。



1 拉开后盖，并将其从产品上取下。

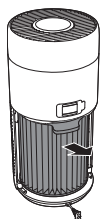

2 从产品上拉下滤网。

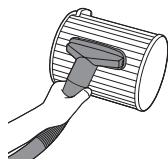

3 使用吸尘器清洁滤网表面。

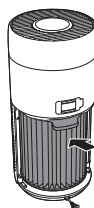

4 把滤网放回产品内。

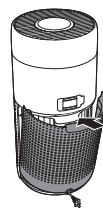

5 重新装上前盖。

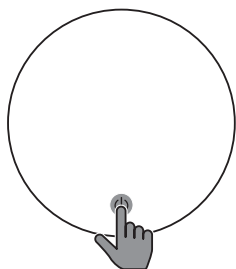

6 轻触  按钮启动产品。



7 轻触并按住滤网状态/重置按钮  3 秒可重置滤网清洁时间。

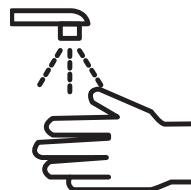



8 清洁滤网后，彻底清洗双手。

更换滤网

注意：

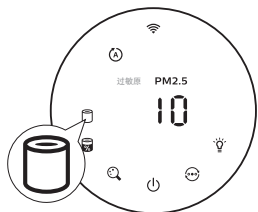
- 滤网不可水洗，也不可重复使用。
- 不要闻滤网的气味，因为滤网上积满了从空气中过滤的污染物。



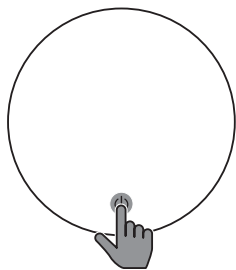

当滤网需要更换时，滤网更换提醒  将呈红色亮起。

- 1 用飞利浦纳米级高效劲护滤网系列 3 (FY2122/00) 来更换该滤网，请按照“安装滤网”一章中的步骤操作。

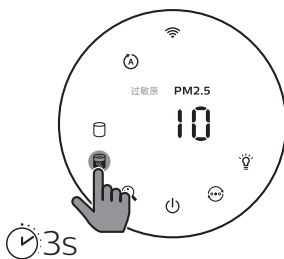

- 2 轻触  按钮启动产品。



- 3 轻触并按住滤网状态/重置按钮  3 秒可重置滤网更换时间。

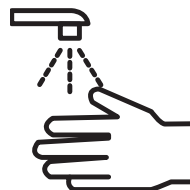

- 4 更换滤网后，彻底清洗双手。

滤网重置

您也可以在屏幕上显示滤网更换提醒(🗑️)之前更换滤网。在更换滤网后，您需要手动重置滤网使用寿命计数器。

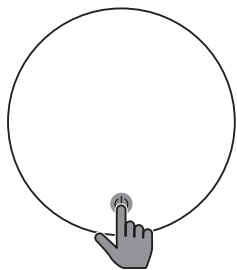

- 1 轻触电源🔌按钮3秒钟以关闭设备并从电源插座拔下插头。

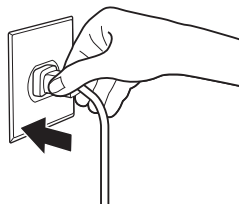

- 2 将电源插头插入电源插座。

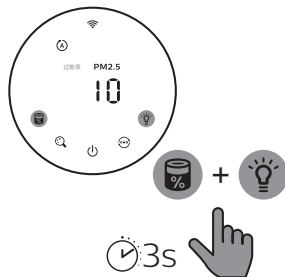

- 3 通电后15秒内，轻触并按住🗑️计时器💡按钮3秒即可重置滤网的使用寿命计数器。

5 存放

- 1 关闭空气净化器，从电源插座上拔下插头。
- 2 清洁空气净化器、微粒感应器和滤网表面（请参阅“清洁和维护”一章）。
- 3 待所有部件完全晾干后再进行存放。
- 4 将滤网装入密封的塑料袋中。
- 5 将空气净化器和滤网存放在阴凉干燥处。
- 6 拆装滤网后，务必彻底洗净双手。

6 故障排除

本章归纳了您在使用本产品时常常遇到的问题。如果您无法根据下面的信息解决问题，请与您所在国家/地区的客户服务中心联系。

问题	可能的解决方法
产品无法正常工作。	<ul style="list-style-type: none">滤网更换提醒指示灯持续亮起，但您未更换相应的滤网。结果是本产品现在已被锁定。在此情况下，更换滤网并长按  重置滤网使用寿命计数器。
出风口排出的气流比之前明显减弱。	<ul style="list-style-type: none">滤网表面变脏。清洁滤网表面（请参阅“清洁和维护”一章）。
即使在产品已经运行很长时间以后，空气质量也未见显著改善。	<ul style="list-style-type: none">检查滤网包装材料是否已去除。滤网没有放入产品内部。确保已正确安装滤网 (FY2122/00)。微粒感应器是湿的。室内湿度过高，因此形成了冷凝水。确保微粒感应器清洁干燥（请参阅“清洁和维护”一章）。房间面积较大或室外空气质量较差。为了获得理想的净化性能，请在使用空气净化器时关闭门窗。室内污染源形式各异。例如，吸烟、烹饪、熏香、香水或酒精。滤网达到了使用寿命的终点。换用新滤网。
空气质量指示灯的颜色始终保持不变。	<ul style="list-style-type: none">微粒感应器变脏。清洁微粒感应器（请参阅“清洁和维护”一章）。
产品散发出一种奇怪的味道。	<ul style="list-style-type: none">前几次使用产品时，其可能会产生塑料味。这是正常的。但是，如果产品在取出滤网后依然发出烧焦的气味，请联系飞利浦经销商或经授权的飞利浦服务中心。由于吸收室内气体，该滤网可能会在使用后发出气味。滤网经过日晒之后即可重复使用，建议您采用这种方式再次激活滤网。如果异味仍然存在，建议更换滤网。

问题

可能的解决方法

产品声音过大。

- 如果产品在劲速模式下运行，这是正常现象。
- 在自动模式下，如果产品声音太大，则设备可能因为空气质量变差而高速运行，或者您在应用程序中的个性化设置触发了较快的风扇速度。您可以选择睡眠模式，或更改应用程序中的设置。
- 如果有异物进入出风口，则还可能会发出较大异常的声音。请立即关闭产品，倒置产品，以从产品中清除异物。
- 如果产品发出异常的声音，请联系您所在国家/地区的客户服务中心。

我已经更换过了滤网，但是产品还是一直指示需要更换滤网。

- 可能是您未重置滤网使用寿命计数器。启动产品。然后轻触并按住重置按钮 () 3 秒钟。

屏幕上显示错误代码“E1”。

- 马达出现故障。请与您所在国家/地区的客户服务中心联系。

Wi-Fi 设置不成功。

- 如果您的净化器连接到的路由器为双频段且当前未连接到 2.4GHz 网络，请切换至同一路由器 (2.4GHz) 的另一频段并尝试再次将净化器配对。不支持 5GHz 网络。如果空气净化器已连接至双频段路由器，请切换至路由器的 2.4GHz 网络，然后尝试再次配对空气净化器。
 - 不支持 Web 验证网络。不支持办公室或酒店网络等公共 Wi-Fi。
 - 检查净化器是否在 Wi-Fi 路由器的范围内。您可以尝试使空气净化器更靠近 Wi-Fi 路由器。
 - 检查 Wi-Fi 密码是否正确。密码区分大小写。
 - 按照“重置 Wi-Fi 连接”部分中的说明重试设置。
 - 使本产品远离可能造成干扰的其他电子设备。
 - 检查移动设备是否处于飞行模式。确保在连接 Wi-Fi 网络时禁用飞行模式。
 - 如果尝试几次后 Wi-Fi 配对都失败，请在智能手机的“设置”部分中关闭蜂窝数据，然后再次开始配对。
 - 如果净化器上的 Wi-Fi 图标呈白色常亮，但在应用程序中未看到该净化器，则单击“连接新设备”，然后在“开始设置”页面的本地列表中添加该净化器。
 - 参阅应用程序中的帮助部分，以获得广泛和最新的故障排除技巧。
-

Contents

1	Your air purifier	15
	Product overview	15
	Controls overview	16
2	Getting started	16
	Installing the filter	16
	Wi-Fi indicator	17
	Wi-Fi connection	17
3	Using the air purifier	17
	Air quality light	17
	Turning On and Off	18
	Changing the mode setting	19
	Switching the display indicator	20
	Using the light on/off function	20
	Checking the filter status	21
4	Cleaning and maintenance	21
	Cleaning the body of the air purifier	21
	Cleaning the particle sensor	21
	Cleaning the surface of the filter	22
	Replacing the filter	23
	Filter reset	24
5	Storage	24
6	Troubleshooting	25

1 Your air purifier

Congratulations on your purchase, and welcome to Philips!

To fully benefit from the support that Philips offers, register your product at www.philips.com/welcome.

Product overview

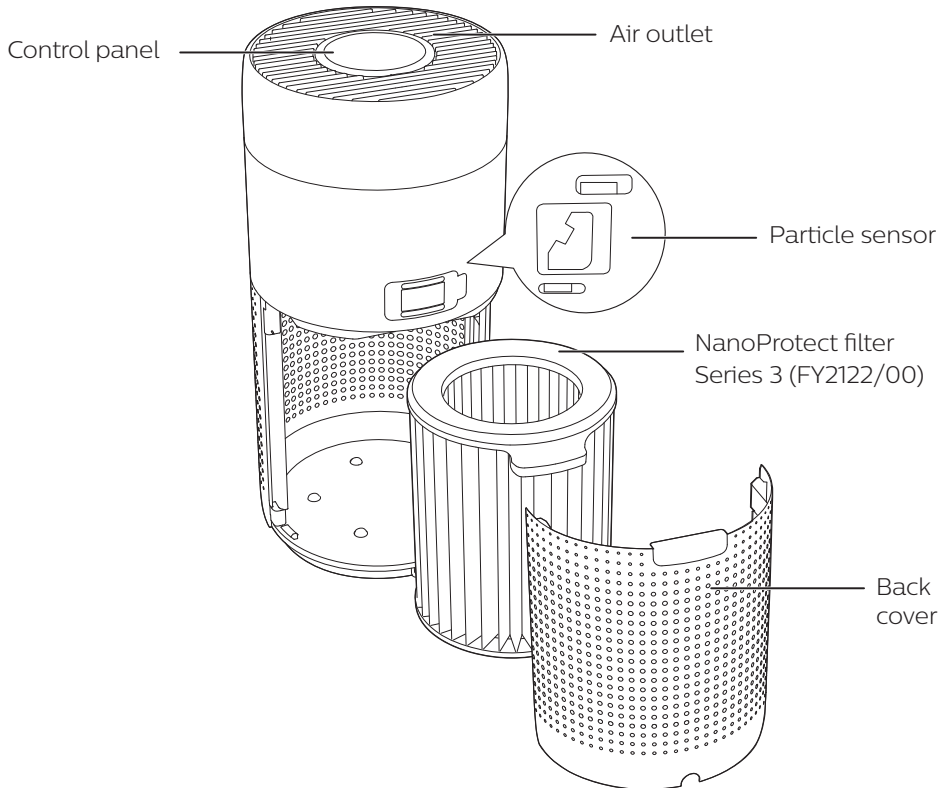

Controls overview

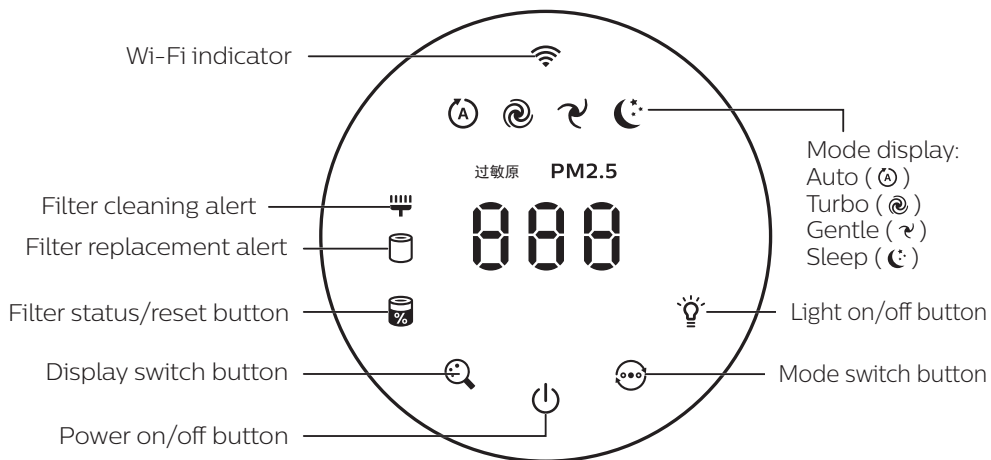

2 Getting started

Installing the filter

Note: Make sure the air purifier is unplugged from the electrical outlet before installing the filter.

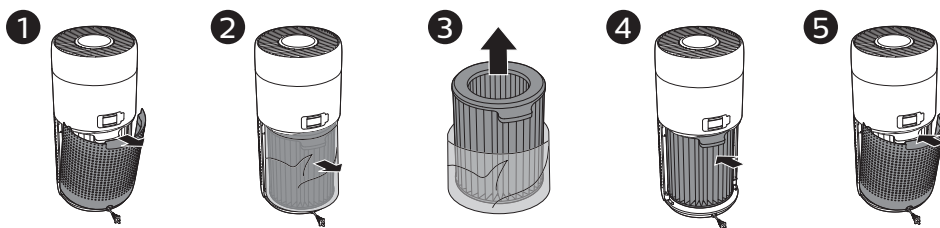

- 1 Pull the back cover and remove it from the appliance.
- 2 Pull the filter from the appliance.
- 3 Remove all packaging materials of the air purification filter.
- 4 Put the filter back into the appliance.
- 5 Reattach the back cover.

Wi-Fi indicator

Wi-Fi icon status	Wi-Fi connection status
Blink in orange	Connecting to the smartphone
Blink in white	Connecting to the router
Stable in white	Connected to the router
Off	Wi-Fi function disabled



Wi-Fi connection

First time connection

- 1 Download and install the Philips “Clean Home+” app from the **App Store** or **Android market**.
- 2 Connect your smartphone or tablet to your Wi-Fi network.
- 3 Launch the “Clean Home+” app and click on “**Connect a New Device**” or press the “+” button on the top of the screen. Follow the onscreen instructions to connect the air purifier to your network.



Reset the Wi-Fi connection

- 1 Touch  and  for 3 seconds until you hear a beep.
↳ The Wi-Fi indicator  blinks orange.
- 2 Follow the steps 3 in “**First time connection**” section.

Note: Please check www.philips.com/cleanhome for the latest update of supported Operation System and devices.

3 Using the air purifier

Air quality light

After approximately 30 seconds, the particle sensor selects the color that corresponds to the surrounding air quality of airborne particles.

Note: The color of the air quality light is determined by the highest risk index among PM2.5 and IAI readings.

PM2.5 refers to airborne particle pollutants smaller than 2.5 micrometers.

PM2.5 level	Air quality light color	Air quality level
≤35	Blue	Good
36-75	Blue-purple	Fair
76-115	Purple-red	Poor
>115	Red	Very poor

IAI refers to the level of indoor air allergen.

IAI level	Air quality light color	Air quality level
1-3	Blue	Good
4-6	Blue-purple	Fair
7-9	Purple-red	Poor
10-12	Red	Very poor

Turning On and Off

Note:

- Put the plug of the air purifier in the power socket.
- If the purifier stays connected to the electrical outlet after turning OFF, the air purifier will operate under the previous settings when turned ON again.

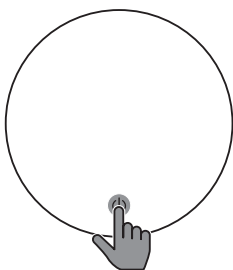

- Touch  to switch on the air purifier.

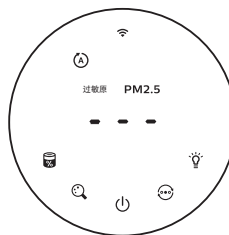

- The “---” displays on the screen during warming up. Then the air purifier shows the PM2.5/IAI level after measuring the air quality.



- The air purifier operates in the auto mode with PM2.5 displayed on the screen.

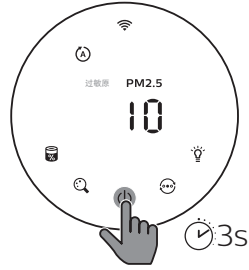

- Touch and hold the  button for 3 seconds to switch off the air purifier.

Changing the mode setting

You can choose Auto mode, Turbo mode, Gentle mode or the Sleep mode by touching the  button.



Auto mode (): The air purifier automatically adjusts the fan speed in accordance with the ambient air quality.



Turbo mode (): The air purifier operates on the highest speed.

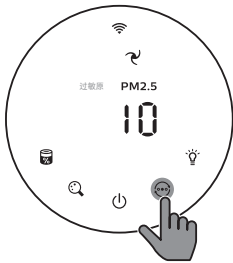

Gentle mode (): The air purifier operates at a low speed.

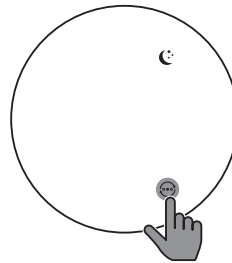

Sleep mode (): The air purifier operates quietly at a low speed. After 3 seconds, the screen lights off.

Switching the display indicator

Note:

- The appliance display PM2.5 level by default.

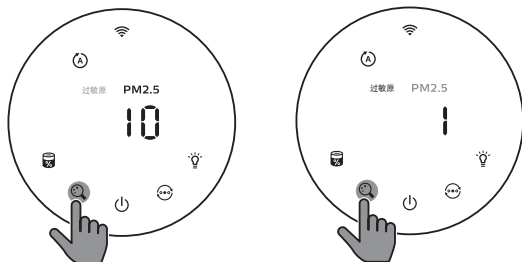

Using the light on/off function

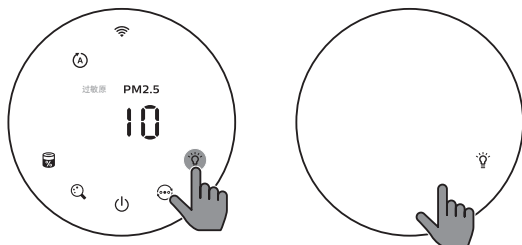

You can touch the light on/off button  manually to turn off all lights and the control panel. Touch any button to wake up all lights.

With the light sensor:

- The control panel can automatically turn on, turn off or dim according to the ambient light.
- The control panel will be off or dim when the ambient light is dark.

You can touch any button to wake up all lights. If no further operation, all lights will be off or dim again to match with the ambient light.

Checking the filter status

- Touch the filter status check/reset  button to check the filter service life status.

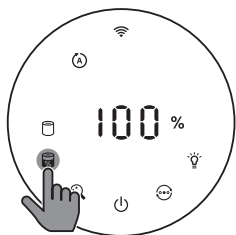

Icon color	Display (%)
Blue	16-100
Blue-purple	9-15
Purple-red	4-8
Red	0-3

Note: The appliance goes back to normal display if no operations after 3 seconds.

4 Cleaning and maintenance

Note:

- Do not attempt to clean the particle sensor with a vacuum cleaner.
- Switch off the air purifier and unplug from the power socket before following action.

Cleaning the body of the air purifier

Use a soft, dry cloth to clean both the interior and exterior of the air purifier and the air outlet.

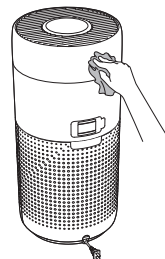

Cleaning the particle sensor

Clean the particle sensor every 2 months for optimal functioning of the appliance.

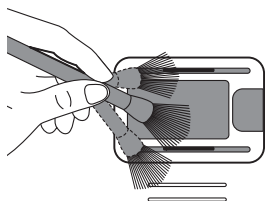

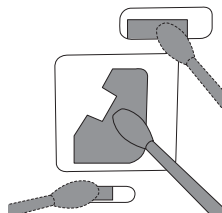

- 1 Clean the particle sensor inlet and outlet with a soft brush.

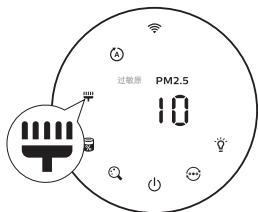

- 2 Clean the particle sensor with a damp cotton swab. Dry all parts thoroughly with a dry cotton swab.

Cleaning the surface of the filter



Clean the surface of filter with vacuum cleaner when the filter cleaning alert  display on the screen.

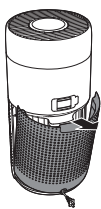

1 Pull the back cover and remove it from the appliance.



2 Pull the filter from the appliance.

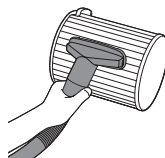

3 Clean the surface of the filter with a vacuum cleaner.

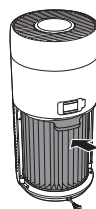

4 Put the filter back into the appliance.

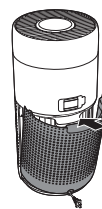

5 Reattach the back cover.

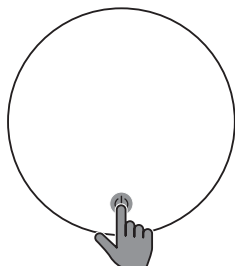

6 Touch the  button to switch on the appliance.



7 Touch and hold the filter status check/reset button  for 3 seconds to reset the filter cleaning time.

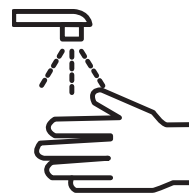

8 Wash your hands thoroughly after cleaning the filter.

Replacing the filter

Note:

- The filter is not washable or reusable.
- Do not smell the filter as it has collected pollutants from the air.

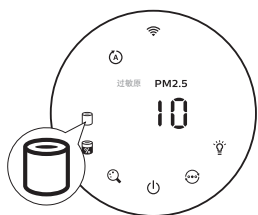

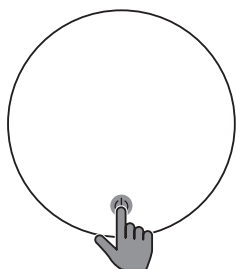

When the filter need to be replaced, the filter replacement alert  lights up red.

- 1 Replace the filter with Philips NanoProtect filter Series 3 (FY2122/00), Please follow the step of Chapter “Installing the filter”.

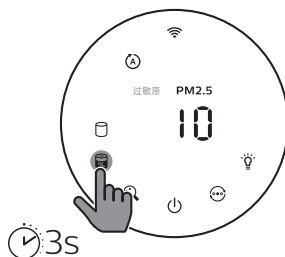

- 2 Touch the  button to switch on the appliance.



- 3 Touch and hold the filter status check/reset button  for 3 seconds to reset the filter replacement time.

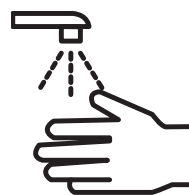

- 4 Wash your hands thoroughly after replacing the filter.

Filter reset

You can also replace the filter before filter replacement alert () displays on the screen. After replacing a filter, you need to reset the filter lifetime counter manually.

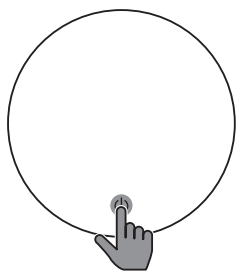

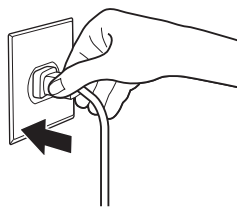

- 1 Touch the power  button for 3 seconds to turn off the appliance and unplug from power socket.



- 2 Put the power plug in the power socket.



- 3 Within 15 seconds after power on, touch and hold  and  button for 3 seconds to reset the filter lifetime counter.

5 Storage

- 1 Turn off the air purifier and unplug from the power socket.
- 2 Clean the air purifier, particle sensor and the surface of the filter (see the chapter “Cleaning and maintenance”).
- 3 Let all parts air dry thoroughly before storing.
- 4 Wrap the filter in air tight plastic bags.
- 5 Store the air purifier, filter in a cool, dry location.
- 6 Always thoroughly wash hands after handling filters.

6 Troubleshooting

This chapter summarizes the most common problems you could encounter with the appliance. If you are unable to solve the problem with the information below, contact the Consumer Care Center in your country.

Problem	Possible solution
The appliance does not work properly.	<ul style="list-style-type: none">• The filter replacement alert has been on continuously but you have not replaced the corresponding filter. As a result, the appliance is now locked. In this case, replace the filter and long press  to reset the filter lifetime counter.
The airflow that comes out of the air outlet is significantly weaker than before.	<ul style="list-style-type: none">• The surface of the filter is dirty. Clean the surface of the filter (see the chapter “Cleaning and maintenance”).
The air quality does not improve, even though the appliance has been operating for a long time.	<ul style="list-style-type: none">• Check if the packing material is removed from the filter.• The filter has not been placed in the appliance. Make sure that the filter (FY2122/00) is properly installed.• The particle sensor is wet. The humidity level in your room is high and causes condensation. Make sure that the particle sensor is clean and dry (see the chapter “Cleaning and maintenance”).• Room size is large or the outdoor air quality is poor. For optimum purification performance, please close the doors and windows when operating the air purifier.• There are indoor pollution resources. For instances, smoking, cooking, incense, perfume or alcohol.• Filter reaches the end of life. Replace the filter with a new one.
The color of the air quality light always stays the same.	<ul style="list-style-type: none">• The particle sensor is dirty. Clean the particle sensor (see the chapter “Cleaning and maintenance”).

Problem	Possible solution
The appliance produces a strange smell.	<ul style="list-style-type: none"> • The first few times you use the appliance, it may produce a plastic smell. This is normal. However, if the appliance produces a burnt smell even if removing filters, contact your Philips dealer or an authorized Philips service center. The filter may produce smell after being used for a while because of the absorption of indoor gases. It's recommended that you reactivate the filter by putting it in direct sunlight for repeated use. If odor still exists, replace the filter.
The appliance is extra loud.	<ul style="list-style-type: none"> • It's normal if the appliance runs at the Turbo mode. • In the Auto mode, if the appliance is too loud, maybe the appliance runs at high speed because air quality becomes worse, or your personalized setting in App triggers a higher fan speed. You can choose the Sleep mode, or change the settings in the App. • If anything drops into air outlet, it may also cause abnormal loud sound. Immediate turn off appliance, turn appliance upside down, to get foreign objectives out of appliance. • If there is abnormal sound, contact the Consumer Care Center in your country.
The appliance still indicates that I need to replace a filter, but I already did.	<ul style="list-style-type: none"> • Perhaps you did not reset the filter lifetime counter. Switch on the appliance. Then touch and hold the reset button () for 3 seconds.
Error code "E1" displays on the screen.	<ul style="list-style-type: none"> • The motor has malfunctions. Contact the Consumer Care Center in your country.

Problem	Possible solution
The Wi-Fi setup is not successful.	<ul style="list-style-type: none"> • If the router your purifier is connected to is dual – band and currently it is not connecting to a 2.4GHz network, please switch to another band of the same router (2.4GHz) and try to pair your purifier again. 5GHz networks are not supported. If your purifier is connected to a dual – band router, please switch to the 2.4GHz network of the router and try to pair your purifier again. • Web authentication networks are not supported. Public Wi-Fi such as office or hotel networks are not supported. • Check if the purifier is within range of the Wi-Fi router. You can try to locate the air purifier closer to the Wi-Fi router. • Check if the Wi-Fi password is correct. The password is case-sensitive. • Retry the setup with the instructions in section “Reset the Wi-Fi connection”. • Keep the appliance away from other electronic devices that may cause interferences. • Check if the mobile device is in airplane mode. Make sure to have the airplane mode deactivated when connecting to the Wi-Fi network. • If the Wi-Fi pairing fails after trying several times, please turn of the cellular data on your smartphone in the Settings section and start the pairing again. • If the Wi-Fi icon on your purifier’s display is in stable white but without seeing the purifier in your app, click on “Connect a New Device” and add the purifier from the local list on “Begin setup” page. • Consult the help section in the App for extensive and up-to-date troubleshooting tips.

PHILIPS

产品保用卡

保修及服务：

此产品是一件设计精良，用高品质元件制造之家用电器，在正常使用及保养下应能发挥其优越性能。在购买日期后二年内，若发生任何因制造工艺或元器件造成之损坏，飞利浦中国维修服务中心将为持证用户提供免费门市维修服务，视情况更换零件或整个产品。无论在保期中或保期后，只要飞利浦正式行销该产品的任何国家皆可获得维修服务。若飞利浦在当地无行销该项产品，飞利浦同样提供维修服务，但可能因未储备所需零件，维修时间可能较长，敬请见谅。请联络当地飞利浦经销商，或飞利浦服务部门。若您需洽询相关资讯，或遇困难事项时，请联络当地飞利浦维修服务中心，或向飞利浦服务热线咨询。

中国顾客服务热线：

4008 800 008（用户需承担本地通话费）。

网址：www.philips.com.cn

网上会员注册与产品注册：

- 1 登陆 www.philips.com.cn/welcome
- 2 点击“创建新账户”，创建您的飞利浦账号
- 3 点击“注册产品”，通过产品名称或产品型号查找产品，完成产品注册

保修条例：

- 在购买日期后二年内，凡经本公司特约维修站人员确认为正常使用情况下，因制造工艺或元器件造成之损坏，您都将获得免费保修服务。
- 此免费服务不包括需时常更换的易耗零配件（吸尘机纸袋，布袋，空气清新机滤网，滤芯，活性炭，咖啡壶过滤网）及附件（如须刀网膜、刀头，咖啡杯，食品加工机杯/刀具等），辅助装置，运输费及维修人员上门服务费。
- 用户请保留此联。
- 此证若经涂改即作废。

- 此证须联同发票正本使用方为有效。
- 以下情况将不能获得免费服务。
 - 1 使用不当引起的人为损坏，例如接入不适当电源、使用不适当配件、不适当之安装、不依说明书使用、错误使用或疏忽而造成损坏等。因运输及其他意外而造成之损坏。非经本公司认可之维修和改装。其他因不可抗力（如自然灾害、电压异常等）造成的损坏。
 - 2 一般家庭以外使用（如工业、商业用）而造成的损坏。
 - 3 正常使用引起的产品老化、磨损等，但不影响产品的正常使用。
- 保修证作为在规定期限及条件之内进行免费维修的保证，并不限制消费者的法定权利。
- 飞利浦提供2年全球联保服务，在产品由飞利浦正式销售的所有国家中，都提供保修和保修期满的维修服务。要求保修时，您需提供发票正本，且请求保修的日期还在保修期限之内。

服务须知

需要此产品的售后服务，拨打服务热线：4008 800 008
在维修服务过程中有任何意见，欢迎致函飞利浦（中国）投资有限公司解决疑难。

飞利浦（中国）投资有限公司
上海市静安区灵石路718号A1幢

产品 : 飞利浦空气净化器 AC2936
型号 : KJ350F-B12
额定电压 : 220V ~
额定频率 : 50Hz
额定输入功率 : 43W
生产日期 : 请见产品本体
产地 : 中国江苏苏州



飞利浦(中国)投资有限公司
上海市静安区灵石路718号A1幢
全国顾客服务热线: 4008 800 008

本产品根据国标 GB4706.1-2005,
GB4706.45-2008, 信部无【2002】353号制造

产品性能指标

目标污染物	洁净空气量(CADR)	累积净化量(CCM)	净化能效等级
颗粒物	360 m ³ /h	P4	高效级
甲醛	220 m ³ /h	F4	高效级

噪声(声功率级)	≤66 dB (A)	适用面积*	25.2 - 43.2 m ²
----------	------------	-------	----------------------------

*适用面积是按照国标GB/T18801-2015根据颗粒物洁净空气量计算得出
以上性能指标数据是在第三方试验室按照国标GB/T18801-2015, 以特定的
烟尘颗粒物或气态污染物为目标污染物测试得出

能源效率标识见机身能效标识。

产品中有害物质的名称及含量

部件名称 (parts name)	有毒有害物质或元素					
	铅(Pb)	汞(Hg)	镉(Cd)	六价铬 (Cr+6)	多溴联苯 (PBB)	多溴二苯醚 (PBDE)
主电路组件	×	○	○	○	○	○
电源电路板组件	×	○	○	○	○	○
传感器板组件	×	○	○	○	○	○
电机组件	×	○	○	○	○	○
电源插头	×	○	○	○	○	○
<p>本表格依据SJ/T 11364的规定编制。</p> <p>○ 表示该有害物质在该部件所有均质材料中的含量均在GB/T 26572规定的限量要求以下。</p> <p>× 表示该有害物质至少在该部件的某一均质材料中的含量超出GB/T 26572规定的限量要求。</p>						

*该表格中所显示的“有害物质”在产品正常使用情况下不会对人身和环境产生任何伤害。

*该表格中所显示的“有害物质”及其存在的部件向消费者和回收处理从业者提供相关物质的存在信息，有助于产品废弃时的妥善处理。

保留备用

出版日期：2020-09-02







© 2020 Koninklijke Philips N.V.

保留所有权利

3000 048 49693

