

Canon

PowerShot V10



Advanced User Guide

E

Contents

Introduction.	6
Package Contents.	7
Supplemental Information.	8
Compatible Accessories.	9
Instruction Manuals.	10
Quick Start Guide.	11
About This Guide.	14
Compatible Cards.	16
Safety Instructions.	17
Handling Precautions.	20
Part Names.	22
Preparation and Basic Operations.	25
Charging the Camera.	26
Inserting/Removing Cards.	27
Using the Screen and Stand.	30
Turning on the Power.	31
Basic Operations.	33
Menu Operations and Settings.	37
Quick Control.	42
Touch-Screen Operation.	45
Shooting and Recording.	47
Movie Recording.	48
Still Photo Shooting.	51
Tab Menus: Movie Recording.	52
Tab Menus: Still Photo Shooting.	54
Shooting Mode.	55
Movie Recording Size.	61
Sound Recording.	66
Movie ISO Speed Settings.	69
Movie Auto Slow Shutter.	70

ND Filter	72
White Balance	73
Autofocus Method	77
Movie Self-Timer	82
IS Settings	83
Movie Auto Level	85
Grid	86
Recording Emphasis	87
Aspect Marker	88
Reverse Display	89
Standby: Low Resolution	90
Display During HDMI Connection	91
Image Quality	93
Still Image Aspect Ratio	94
Touch Shutter	95
Review Duration	97
General Movie Recording Precautions	98
General Still Photo Shooting Precautions	102
Playback	103
Tab Menus: Playback	104
Movie Playback	105
Image Playback	108
Playback on a TV Set	112
Protecting Images	114
Erasing Images	118
Rotating Still Photos	125
Changing Movie Orientation Information	127
Rating Images	129
Resuming from Previous Playback	134
Wireless Features	135
Tab Menus: Wireless Features	136
Connecting to a Smartphone or Tablet	138

Connecting to a Wireless Remote Control.	150
Uploading Images to image.canon.	154
Live Streaming.	160
Advanced Connections.	168
GPS Settings.	171
Basic Communication Settings.	175
Reconnecting via Wi-Fi/Bluetooth.	196
Editing/Deleting Devices for Connections.	198
Airplane Mode.	201
Wi-Fi Settings.	202
Bluetooth Settings.	204
Camera Name.	205
Error Details.	206
Resetting Communication Settings.	207
Virtual Keyboard Operations.	208
Responding to Error Messages.	209
Wireless Communication Precautions.	216
Security.	218
Checking Network Settings.	219
Wireless Communication Status.	220
Set-up.	222
Tab Menu: Set-up.	223
Folder Settings.	225
File Numbering.	228
Card Formatting.	233
Auto Rotate.	235
Adding Orientation Information to Movies.	237
Date/Time/Zone.	238
Language.	241
Video System.	242
Beeps.	243
Volume.	244
Power Saving.	245

Screen Brightness.	247
HDMI Resolution.	248
Communication/Multi-Access Button Function (in Movie Mode).	249
App Selection for USB Connections.	250
Resetting the Camera.	251
Copyright Information.	252
Other Information.	255
Reference.	256
Troubleshooting Guide.	257
Error Codes.	263
Information Display.	264
Specifications.	272
Before Disposal.	283
Trademarks and Licensing.	286

Introduction

Before starting to shoot, be sure to read the following

To avoid shooting problems and accidents, first read the [Safety Instructions](#) and [Handling Precautions](#). Also read this Advanced User Guide carefully to ensure that you use the camera correctly.

Take some test shots, and understand about product liability

After shooting, play images back and check whether they have been properly recorded. If the camera or memory card is faulty and images cannot be recorded or transferred to a computer, Canon cannot be held liable for any loss or inconvenience caused.

Copyrights

Unauthorized public use of images captured with the camera that include copyrighted subjects is prohibited by law. Also be aware that certain public performances, exhibitions, etc. may prohibit photography even for private enjoyment.

- [Package Contents](#)
- [Supplemental Information](#)
- [Compatible Accessories](#)
- [Instruction Manuals](#)
- [Quick Start Guide](#)
- [About This Guide](#)
- [Compatible Cards](#)
- [Safety Instructions](#)
- [Handling Precautions](#)
- [Part Names](#)

Package Contents

Before use, make sure the following items are included in the package. If anything is missing, contact your dealer.

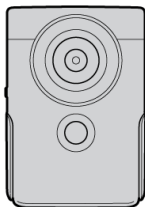

Camera

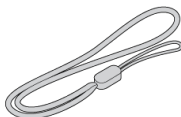

Wrist strap

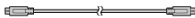

Interface cable

- The camera does not come with a memory card (☑).
- The battery is built into the camera.
- Be careful not to lose any of these items.

Caution

- The transmission rate with the included interface cable is equivalent to Hi-Speed USB (USB 2.0).

Supplemental Information

Check the following website for supplemental information about the camera.

- <https://cam.start.canon/H001/>



Compatible Accessories

Check the following website for details on compatible accessories.

- <https://cam.start.canon/H002/>



Instruction Manuals

- **Instruction Manual (included with the camera)**

Provides basic camera instructions.

- **Advanced User Guide**

Complete instructions are provided in this Advanced User Guide.

For the latest Advanced User Guide, refer to the following website.

<https://cam.start.canon/C014/>



1. Charge the camera (🔌).

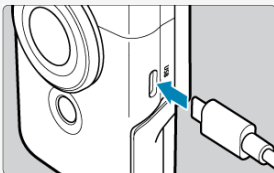

- Charge the camera initially before use (🔌).

2. Insert the card (📷).

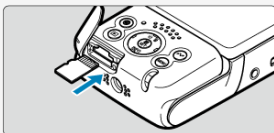

3. Turn the camera on (🔌).

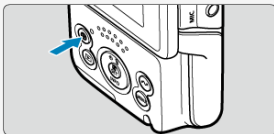

- Press the < 🔌 > button.
- If the language selection screen appears, use < ⬅️ > to select the language, then press < 📷 > (📷).
- If the date/time/zone setting screen appears, use < ⬅️ > to select a setting item, then press < 📷 >. Set with the < ⬆️ / ⬆️ > keys, then press < 📷 > (📷).
- After the **[Welcome]** screen appears, follow the on-screen instructions to connect the camera to your smartphone (📷).
- In areas where the TV video system is PAL, see [Video System](#).

4. Flip out the screen and stand, then set the camera down (📷).

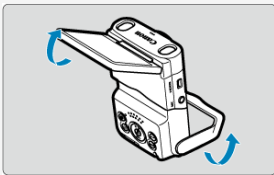

- You can also use the camera in handheld shooting and recording.

5. Record a movie (📷).

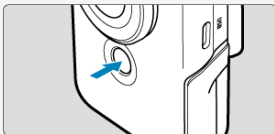

- To start recording, tap [●] or press the Start/Stop button. To stop recording, tap [■] or press the Start/Stop button again.
- [●REC] is displayed in the upper left while movie recording is in progress, and a blinking red frame is displayed around the screen.

6. Review the recorded movie.

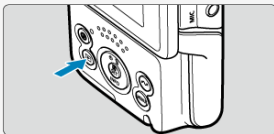

- Press the <▶> button to play the recorded movie on the screen (📷).
- Press the <▶> button again to return to the shooting screen.

⚠ Caution

- Avoid pinching your fingers when opening or closing the stand.



Note



- To stream video, see [Live Streaming](#).

About This Guide





 [Icons in This Guide](#)

 [Basic Assumptions for Operational Instructions and Sample Photos](#)

Icons in This Guide

	Indicates the direction to press the cross keys <  >.
	Indicates the Quick Control/Set button.

- In addition to the above, the icons and symbols used on the camera's buttons and displayed on the screen are also used in this guide when discussing relevant operations and functionality.

	Links to pages with related topics.
	Warning to prevent shooting problems.
	Supplemental information.
	Tips or advice for better shooting.
	Troubleshooting advice.

Basic Assumptions for Operational Instructions and Sample Photos

- Instructions apply to the camera with the power on (🔋).
- It is assumed that all menu settings are set to defaults.
- Sample photos in this guide are only for illustration.

Compatible Cards

In this guide, all supported memory cards are simply referred to as "the card."

The following cards can be used with the camera regardless of capacity. **If the card is new or was previously formatted (initialized) by another camera or computer, format the card with this camera** (🔗).

- **microSD / microSDHC / microSDXC memory cards**

- * SD speed class compatible
- * UHS speed class compatible
- * UHS-I compatible

Cards That Can Record Movies

When recording movies, use a card with ample performance (fast enough writing and reading speeds) for the movie recording quality (🔗).

Safety Instructions

Be sure to read these instructions in order to operate the product safely.
Follow these instructions to prevent injury or harm to the operator of the product or others.



WARNING:

Denotes the risk of serious injury or death.

- Keep the product out of the reach of young children.

A strap wrapped around a person's neck may result in strangulation.

The parts or provided items of cameras or accessories are dangerous if swallowed. If swallowed, seek immediate medical assistance.

- Use only power sources specified in this Advanced User Guide for use with the product.
- Do not disassemble or modify the product.
- Do not expose the product to strong shocks or vibration.
- Do not touch any exposed internal parts.
- Stop using the product in any case of unusual circumstances such as the presence of smoke or a strange smell.
- Do not use organic solvents such as alcohol, benzene or paint thinner to clean the product.
- Do not get the product wet. Do not insert foreign objects or liquids into the product.
- Do not use the product where flammable gases may be present.

This may cause electric shock, explosion or fire.

- Do not touch the product connected to a power outlet during lightning storms.

This may cause electric shock.

- Observe the following instructions when using a battery charger or AC adapter.
 - Periodically remove any dust buildup from the power plug and power outlet using a dry cloth.
 - Do not plug in or unplug the product with wet hands.
 - Do not use the product if the power plug is not fully inserted into the power outlet.
 - Do not expose the power plug and terminals to dirt or let them come into contact with metallic pins or other metal objects.
 - Do not touch the battery charger or AC adapter connected to a power outlet during lightning storms.
- Do not place heavy objects on the power cord. Do not damage, break or modify the power cord.
- Do not wrap the product in cloth or other materials when in use or shortly after use when the product is still warm in temperature.
- Do not unplug the product by pulling the power cord.
- Do not leave the product connected to a power source for long periods of time.
- Do not charge batteries/battery packs at temperatures outside the range of 5 - 40 °C (41 - 104 °F).

This may cause electric shock, explosion or fire.

- Do not allow the product to maintain contact with the same area of skin for extended periods of time during use.

This may result in low-temperature contact burns, including skin redness and blistering, even if the product does not feel hot. The use of a tripod or similar equipment is recommended when using the product in hot places and for people with circulation problems or less sensitive skin.

- Follow any indications to turn off the product in places where its use is forbidden. Not doing so may cause other equipment to malfunction due to the effect of electromagnetic waves and even result in accidents.



CAUTION:

Follow the cautions below. Otherwise physical injury or property damage may result.

- Do not look at the screen or through the viewfinder for prolonged periods of time. This may induce symptoms similar to motion sickness. In such a case, stop using the product immediately and rest for a while before resuming use.
- Do not leave the product in places exposed to extremely high or low temperatures. The product may become extremely hot/cold and cause burns or injury when touched.
- Strap is intended for use on the body only. Hanging the strap with any product attached on a hook or other object may damage the product. Also, do not shake the product or expose the product to strong impacts.
- Do not apply strong pressure on the lens or allow an object to hit it. This may cause injury or damage to the product.
- Do not carry the product when it is mounted on a tripod. This may cause injury or may result in an accident.
- Do not touch any parts inside the product. This may cause injury.
- If any abnormal skin reaction or irritation occurs during or following the use of this product, refrain from further use and get medical advice/attention.

Handling Precautions

Camera care

- This camera is a precision instrument. Do not drop it or subject it to physical shock.
- The camera is not waterproof and cannot be used underwater. If the camera gets wet, contact a Canon Service Center immediately. Wipe off any water droplets with a clean, dry cloth, and if the camera is exposed to salty air, wipe it off with a clean, well-wrung wet cloth.
- Never leave the camera near anything having a strong magnetic field such as a magnet or electric motor. Also, avoid using or leaving the camera near anything emitting strong radio waves, such as a large antenna. Strong magnetic fields can cause camera malfunction or destroy image data.
- Do not leave the camera in excessive heat, such as in a car in direct sunlight. High temperatures can cause the camera to malfunction.
- The camera contains precision electronic circuitry. Never attempt to disassemble the camera yourself.
- If the camera is suddenly brought in from the cold into a warm room, condensation may form on the camera and internal parts. To prevent condensation, first put the camera in a sealed plastic bag and let it adjust to the warmer temperature before taking it out of the bag.
- If condensation forms on the camera, to avoid damage, do not use the camera or remove the card. Turn the camera off and wait until the moisture has fully evaporated before resuming use. Even after the camera is completely dry, if it is still internally cold, do not remove the card until the camera has adjusted to the ambient temperature.
- Condensation may form inside the camera lens if you record 4K movies in **[Smooth skin movie]** mode in humid environments. Keep the camera off until the moisture has evaporated before resuming use. If the condensation does not dissipate, try changing the recording mode or setting the camera to an option other than 4K movies.
- If the camera will not be used for an extended period, store it in a cool, dry, well-ventilated location. Record occasionally during storage to make sure the camera is still working correctly.
- Avoid storing the camera where there are chemicals that result in rust and corrosion such as in a chemical lab.
- If the camera has not been used for an extended period, test all its functions before using it. If you have not used the camera for some time or if there is an important shoot such as a foreign trip coming up, have the camera checked by your nearest Canon Service Center or check the camera yourself and make sure it is working properly.
- The camera may become hot after repeated continuous shooting or still photo/movie shooting over an extended period. This is not a malfunction.
- If there is a bright light source inside or outside the image area, ghosting may occur.
- When shooting with backlighting, keep the sun sufficiently away from the angle of view. Always keep intense light sources such as the sun, lasers, and other intense artificial light sources out of the image area and not near it. Concentrated intense light may cause smoke or damage the image sensor or other internal components.

Screen

The following does not affect images captured by the camera.

- Although the screen is produced under extremely high-precision manufacturing conditions and more than 99.99% of the pixels meet design specifications, 0.01% or fewer pixels may be defective or appear as red or black dots. This is not a malfunction.
- If the screen is left on for a prolonged period, screen burn-in may occur where you see remnants of what was displayed. However, this is only temporary and will disappear when the camera is left unused for a few days.
- The screen display may seem slightly slow in low temperatures or may look black in high temperatures. It will return to normal at room temperature.

Cards









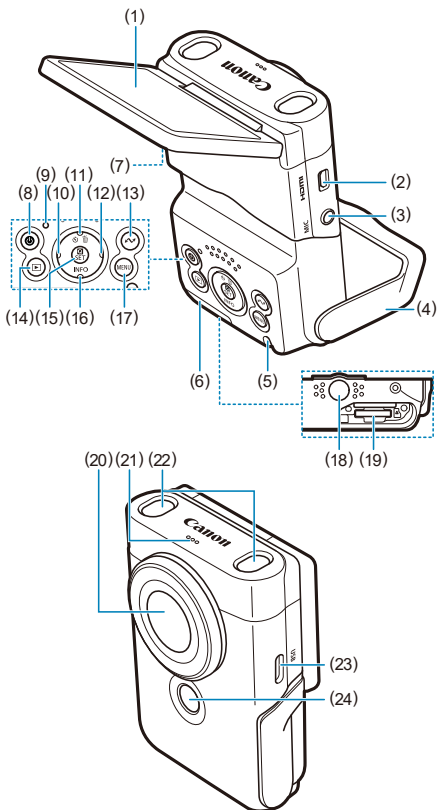

To protect the card and its recorded data, note the following:

- Do not drop, bend, or wet the card. Do not subject it to excessive force, physical shock, or vibration.
- Do not touch the card's electronic contacts with your fingers or anything metallic.
- Do not affix any stickers, etc. on the card.
- Do not store or use the card near anything that has a strong magnetic field, such as a television, speakers, or magnets. Also avoid places prone to having static electricity.
- Do not leave the card in direct sunlight or near a heat source.
- Store the card in a case.
- Do not store the card in hot, dusty, or humid locations.
- Cards may become hot after long sessions of repeated continuous shooting or still photo shooting/movie recording. This is not a malfunction.

Part Names

[Attaching the Strap](#)



(1)	Screen
(2)	HDMI terminal
(3)	External microphone IN terminal
(4)	Stand
(5)	Strap mount
(6)	Card slot cover
(7)	Serial number
(8)	<  > Power button
(9)	Indicator
(10)	<  > Left button
(11)	<  /  /  > Up/Self-timer/Erase button
(12)	<  > Right button
(13)	<  > Comm/Multi-access button
(14)	<  > Playback button
(15)	<  > Quick Control/Set button
(16)	<  / INFO > Down/Info button
(17)	< MENU > Menu button
(18)	Tripod socket
(19)	Card slot
(20)	Lens
(21)	Speaker
(22)	Stereo microphone
(23)	Digital terminal
(24)	Start/Stop button

Attaching the Strap

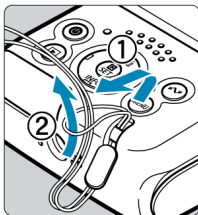

Attach the included wrist strap to the camera strap mount.

Preparation and Basic Operations

This chapter describes preparatory steps before you start shooting and the basic camera operations.

- [Charging the Camera](#)
- [Inserting/Removing Cards](#)
- [Using the Screen and Stand](#)
- [Turning on the Power](#)
- [Basic Operations](#)
- [Menu Operations and Settings](#)
- [Quick Control](#)
- [Touch-Screen Operation](#)

Charging the Camera

1. Charge the camera.

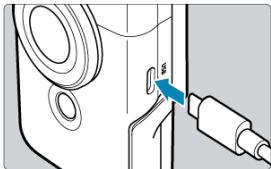

- Charge the camera over a USB connection with the included cable.
- After charging begins, the indicator turns orange.
- The indicator goes off after the camera is fully charged.

- **Charging the camera when it is fully depleted takes approx. 1 hr. and 50 min. at room temperature (23°C/73°F).** The time required to charge the battery will vary greatly depending on the ambient temperature and the battery's remaining capacity.
- For safety, charging in low temperatures (5–10°C/41–50°F) takes longer.
- The camera can also be used while plugged in for charging.

Caution

- Charging may stop if the camera becomes hot.

Note

- For charging and powering the camera, an optional USB Power Adapter PD-E1 is recommended. Some commercially available power adapters (USB Type-C) have also been confirmed to work with the camera. For details, check the Canon website ([@](#)).

- **Upon purchase, the built-in battery is not fully charged.**
Charge the battery before use.
- **Charge the camera on the day you will use it or the day before.**
The built-in battery will gradually lose its charge, even if it is not used.
- **Use the camera where the temperature is 0–35°C (32–95°F).**
For optimal camera performance, use where the ambient temperature is 0–35°C (32–95°F). Lower temperatures may temporarily reduce the performance and life of the built-in battery. Higher temperatures may prevent continuous shooting if the camera becomes hot.

Inserting/Removing Cards

 [Insertion](#)

 [Removal](#)

Caution

- Use of memory cards other than microSD / microSDHC / microSDXC cards is not supported.

Insertion

1. Open the cover.



- Turn the camera off () .
- After making sure the indicator is off, open the cover and rotate it out of the way.

2. Insert the card.



- Insert the card with the label face-down. **Inserting cards the wrong way may damage the camera.**

3. Close the cover.



1. Open the cover.

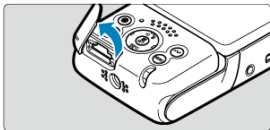

- Turn the camera off (🔒).

2. Remove the card.

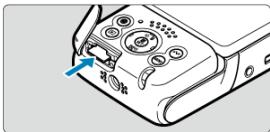

- Press the card in to eject it.
- Pull the card straight out, then close the cover.

Caution

- **A lit indicator indicates that the camera is writing to, reading from, erasing from, or transferring data to the card. Do not open the card slot cover during this time. To avoid image data corruption and damage to cards or the camera, never do any of the following while the indicator is lit.**
 - Removing the card
 - Shaking or striking the camera
- If a card-related error message is displayed on the screen, remove and reinsert the card. If the error persists, use a different card.
If you can transfer images on the card to a computer, transfer all the images and then format the card with the camera (🔒). The card may then return to normal.

Using the Screen and Stand

You can change the direction and angle of the screen.

1. Flip out the screen and stand.

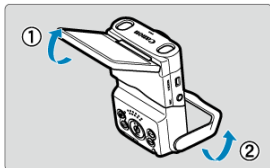

- The screen lifts upward and opens to about 180°.
- Using the stand, you can set up the camera tilting downward in a range of -30° to -10° or upward in a range of 10° to 30°.

! Caution

- Avoid forcing the screen too far open, which puts undue pressure on the hinge.

📄 Note

- A mirror image (right/left reversed) of subjects is displayed when the screen faces subjects in front of the camera (🔄).

Turning on the Power

[Battery Level Indicator](#)

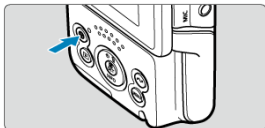

- To turn the camera on, press the <  > button. Press it again to turn the camera off.

Changing the interface language

A language selection screen is displayed on initial startup.

To change the interface language, see [Language](#).

Setting the date, time, and time zone

If the date/time/zone setting screen appears when you turn the camera on, see [Date/Time/Zone](#).

Changing the video system

The video system is set to NTSC.





Change it to PAL in areas where the TV video system is PAL.

To change the video system, see [Video System](#).

Battery Level Indicator

The battery level indicator appears when the camera is turned on.



	Battery level is sufficient.
	Battery level is low, but the camera can still be used.
	Battery will be depleted soon (blinks).
	Charge the battery.

Note

- Doing the following will deplete the battery faster:
 - Using the Wi-Fi function or Bluetooth function.
- Less recording time may be available depending on the actual shooting conditions.
- In low ambient temperatures, shooting may not be possible even with a sufficient battery level.

Basic Operations

- [Start/Stop Button](#)
- [≤ / INFO > Down/Info Button](#)
- [< / > Comm/Multi-Access Button](#)
- [Indicator Display](#)

Start/Stop Button

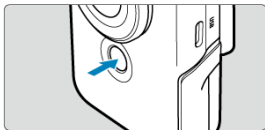

Press the Start/Stop button in Movie mode to start recording. Press it again to stop recording.

Press the Start/Stop button in still photo mode to take one picture.

< ▼ / INFO > Down/Info Button

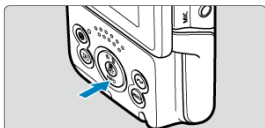

Each press of the < ▼ / INFO > Down/Info button changes the information shown. The following sample screens are for movie recording.

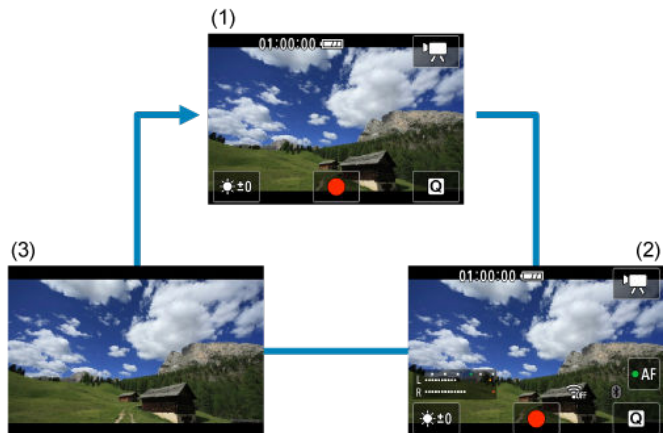





< > Comm/Multi-Access Button



Shows wireless communication features.

The <  > button can also be assigned to frequently used Movie mode functions. To view the setting screen for this button, press and hold the button on the movie recording screen.



- Press the <  > button to set it.
- During playback, you can send images to a smartphone or tablet (collectively referred to as “smartphones”) connected to the camera via Wi-Fi by pressing the <  > button. Select images with the <  > <  > keys, then press the <  > button.

Caution

- Functions assigned to the <  > button may not be available in some recording modes. In this case, a message is displayed when you press the <  > button to indicate that it is not available.

Indicator Display

Indicator display varies depending on the camera status.

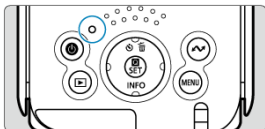

Color	Indicator Status	Camera Status
Green	Turned on	● Recording stills to the memory card, or reading stills from the card
	Slow blinking	● Display off
	Blinking	● Recording movies to the memory card, or reading movies from the card ● Transmitting via Wi-Fi
Orange	Turned on	● Charging via USB
	Blinking	● USB charging error

Menu Operations and Settings

- [Menu Screen](#)
- [Menu Setting Procedure](#)
- [Dimmed Menu Items](#)

Menu Screen

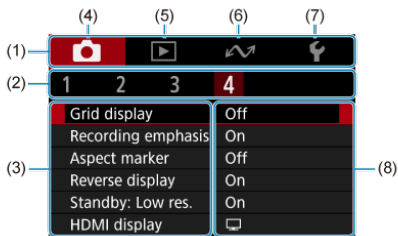

- (1) Main tabs
- (2) Secondary tabs
- (3) Menu items
- (4) : Shooting
- (5) : Playback
- (6) : Wireless communication
- (7) : Set-up
- (8) Menu settings

* Some tabs, menu items, and setting options may not be displayed, depending on the recording mode.

Menu Setting Procedure

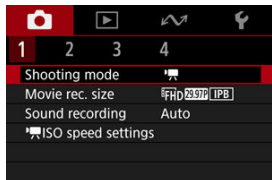

1. Display the menu screen.

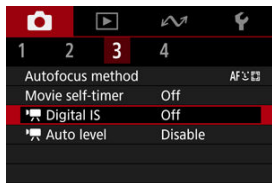

- Press the < MENU > button to display the menu screen.

2. Select an item.



- Press <  > to select an item, then press the <  > button.

3. Select an option.

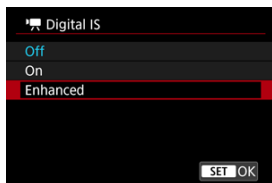

- Press <  > to select an option.
- The current setting is indicated in blue.
- For some setting items, a standby screen is displayed. Select an option to configure the setting.

4. Set the option.

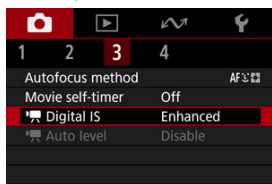

- Press the <  > button to set it.

5. Exit the setting.

- Press the < MENU > button.

Note

- The description of menu functions hereafter assumes that you have pressed the < MENU > button to display the menu screen.
- To cancel the operation, press the < MENU > button.

Dimmed Menu Items

Example: With the Digital IS setting set to [Enhanced]

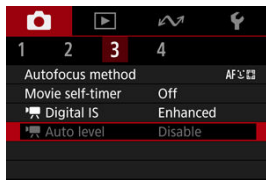

Dimmed menu items cannot be set. The menu item is dimmed if another function setting is overriding it.

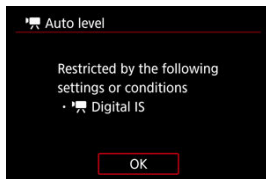

You can see the overriding function by selecting the dimmed menu item and pressing the \langle (Info) \rangle button.

If you cancel the overriding function's setting, the dimmed menu item will become settable.

Caution

- You may not be able to see the overriding function for certain dimmed menu items.

Note

- You can reset menu functions to the default settings by selecting [**W**: **Reset camera**] (Info).

Quick Control

You can directly and intuitively select and set the settings displayed.
Available setting items vary by shooting mode.

1. Press the  button.

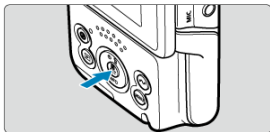

2. Select a setting item and set your preferred option.

Movie recording mode

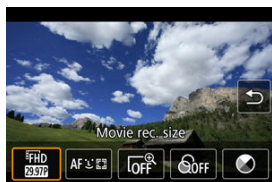

Still photo shooting mode





- Press the < ◀ > ▶ > keys to select an item.

You can also set [Movie rec. size] and [Autofocus method] from menu screens ( , ).

●  **Digital zoom**















You can shoot with up to approx. 3× digital zoom.

 **Caution**

-  **Digital IS** is fixed to **[Off]** and  **Autofocus method** to **[Specified frame AF]**.
- Images look grainier at higher magnifications, because Movie digital zoom applies digital image processing. Noise or dots of light may also become noticeable.

●  **Color filter**

You can adjust colors as you watch the screen.

Filter	Effect	Recommended Scenes
 StoryTeal&Orange	Matte with teal shadows and amber highlights	High-contrast daytime scenes and other scenes with contrast, such as well-lit rooms
 StoryMagenta	Matte with a magenta filter effect overall	
 StoryBlue	Matte with a blue filter effect overall	
 PaleTeal&Orange	Teal shadows and amber highlights	Scenes with contrast that include some amber or yellowish colors
 RetroGreen	Faded with a green filter effect overall	Old buildings, cityscapes
 Sepiatone	Faded with a sepia filter effect overall	
 AccentRed	All colors except reds are faded	Scenes that include some reddish colors
 TastyWarm	High saturation and bright midtones, with warm colors overall	Scenes that include food or beverages in warm tones
 TastyCool	High saturation and bright midtones, with cool colors overall	Scenes that include food or beverages in cool tones
 BrightAmber	Low contrast, light shadows while keeping the ambiance dark, and warm colors	Dimly lit scenes with warm-toned light sources
 BrightWhite	Low contrast, light shadows while keeping the ambiance dark, and cool colors	
 ClearLightBlue	Low contrast, bright shadows, with light blue overall	Bright evening cityscapes, indoor scenes
 ClearPurple	Low contrast, bright shadows, with light purple overall	
 ClearAmber	Low contrast, bright shadows, with light amber overall	

 **Caution**

- Color filters may prevent images from being rendered with smooth gradation and may result in image noise.
- Some camera settings or subjects may prevent you from obtaining your expected colors.

●  **Color tone**

Press to shift color tones toward Blue or Amber, and press the <  > button to shift toward Magenta or Green.

Touch-Screen Operation

☑ [Tapping](#)

☑ [Dragging](#)

Tapping

Sample screen (Quick Control)



- Use your finger to tap (touch briefly and then remove your finger from) the screen.
- For example, when you tap [Q], the Quick Control screen appears. By tapping [↶], you can return to the preceding screen.

Note

- To have the camera beep for touch operations, set [🔊: Beep] to [Enable] (🔊).
- By default, beeping volume for touch operations is set to [0].

Dragging

Sample screen (Menu screen)

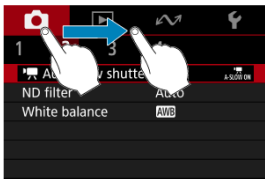

- Slide your finger while touching the screen.
- For example, drag on the main tabs to move to a different tab.

Shooting and Recording

This chapter describes shooting and recording and introduces menu settings on the shooting [📷] tab.

- [Movie Recording](#)
- [Still Photo Shooting](#)
- [Tab Menus: Movie Recording](#)
- [Tab Menus: Still Photo Shooting](#)
- [Shooting Mode](#)
- [Movie Recording Size](#)
- [Sound Recording](#)
- [Movie ISO Speed Settings](#)
- [Movie Auto Slow Shutter](#)
- [ND Filter](#)
- [White Balance](#)
- [Autofocus Method](#)
- [Movie Self-Timer](#)
- [IS Settings](#)
- [Movie Auto Level](#)
- [Grid](#)
- [Recording Emphasis](#)
- [Aspect Marker](#)
- [Reverse Display](#)
- [Standby: Low Resolution](#)
- [Display During HDMI Connection](#)
- [Image Quality](#)
- [Still Image Aspect Ratio](#)
- [Touch Shutter](#)
- [Review Duration](#)
- [General Movie Recording Precautions](#)
- [General Still Photo Shooting Precautions](#)

1. Focus on the subject.



Tracking a subject to focus on it

- Set [: Autofocus method] to [Face tracking AF].
- An AF point is displayed over a person's face or other subject, which the camera keeps in focus.
- To focus on a different subject, tap it. The AF point changes to []. To exit subject selection, press the < MENU > button. Press the < > button again to return to the shooting screen.
- When [] is displayed around an AF point, you can use the < > < > keys to change the subject to focus on.

Focusing on subjects in a specific position

- Set [: Autofocus method] to [Specified frame AF].
- Tap a position to focus on, then move the AF point on the AF point screen.
- Align the AF point with the subject.
- Pressing the < MENU > button returns the AF point to the center.
- Tapping [SET] returns to the shooting screen. To center the AF point, tap [].



Note

- You can tap [**●AF**] to activate autofocus during standby, after which focusing is locked. The icon changes to [**○AF**]. To unlock focusing, tap it again.
- If [**●AF**] is not displayed, press the < **▼** > key.
- A green frame appears once the subject is in focus. A yellow frame is displayed with [**!**] when the camera cannot focus on subjects.



Caution

- If you perform camera operations during movie recording, the camera's built-in microphone may also record sounds of the camera operations.

2. Record the movie.

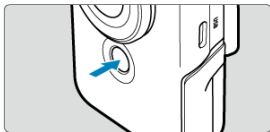

- To start movie recording, tap [●] or press the Start/Stop button.
- [●REC] is displayed in the upper left while movie recording is in progress, and a blinking red frame is displayed around the screen.

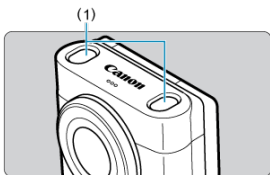
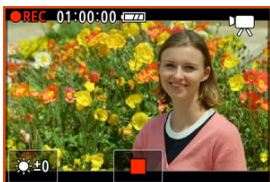

- Sound is recorded by the microphone (1).
- To stop movie recording, tap [■] or press the Start/Stop button.
- To review the recorded movie, press the < [▶] > button (🔍).

Note



- Audio is recorded in stereo.
- The microphone picks up sound in front of and behind the camera, on the left and right, and above it.

Still Photo Shooting

- To focus, tap a subject you want to capture. Press the Start/Stop button to shoot.
- A yellow frame is displayed when the camera cannot focus on subjects.



Note

- For fully automatic operation from focusing to shooting, simply by tapping a subject, set : **Touch Shutter** to **[Enable]** .

Tab Menus: Movie Recording

Note

- *1 Not displayed in [Smooth skin movie] mode or [Movie IS mode].
- *2 Available only in [Auto movie] or [Manual exposure movie] mode.
- *3 Not displayed in [Smooth skin movie] mode.

● Shooting 1

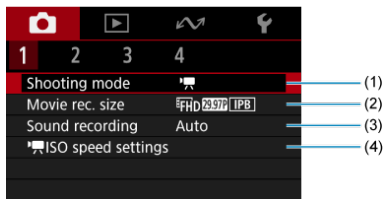

- (1) [Shooting mode](#)
- (2) [Movie rec. size](#)
- (3) [Sound recording](#)
- (4) [ISO speed settings](#)^{*2}

● Shooting 2

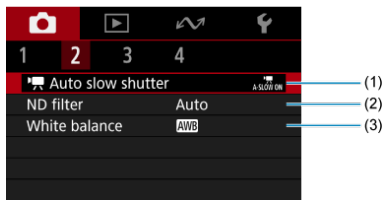

- (1) [Auto slow shutter](#)^{*1}
- (2) [ND filter](#)
- (3) [White balance](#)^{*1}

● Shooting 3



- (1) [Autofocus method](#)
- (2) [Movie self-timer](#)
- (3) [Digital IS](#)
- (4) [Auto level](#)

● Shooting 4

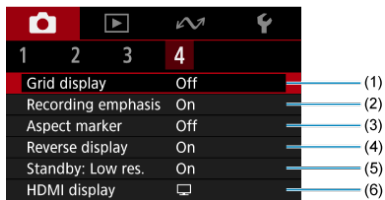

- (1) [Grid display](#)
- (2) [Recording emphasis](#)
- (3) [Aspect marker](#)
- (4) [Reverse display](#)
- (5) [Standby: Low res.](#)^{*3}
- (6) [HDMI display](#)^{*1}

Tab Menus: Still Photo Shooting

For still photo shooting, set the shooting mode to [Auto photo].

● Shooting 1

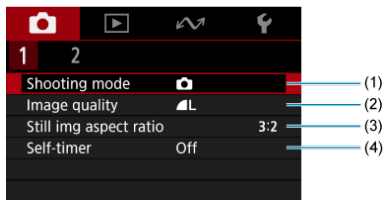

- (1) [Shooting mode](#)
- (2) [Image quality](#)
- (3) [Still img aspect ratio](#)
- (4) [Self-timer](#)

● Shooting 2

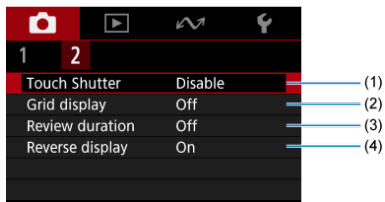

- (1) [Touch Shutter](#)
- (2) [Grid display](#)
- (3) [Review duration](#)
- (4) [Reverse display](#)

Shooting Mode

- [Auto Movie](#)
- [Smooth Skin Movie](#)
- [Movie IS Mode](#)
- [Manual Exposure Movie](#)
- [Auto Photo](#)

You can change the recording mode to suit the scene.

1. Select [📷: Shooting mode].

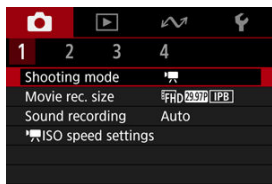

2. Select a shooting mode.



- Press the <◀>>> keys to select the recording mode, then press the <Ⓜ> button.
- To switch to Photo mode, press the <📷> button.

Auto Movie

Select [📷].

Exposure is controlled automatically to suit the brightness.



Screen brightness can be adjusted by selecting [☀️].

Smooth Skin Movie

Select [].

Image processing makes skin look smoother.

The level of this effect can be set in **[Smooth skin effect]** on the Quick Control screen.



Screen brightness can be adjusted by selecting [].

Shooting tips

- **Enable the camera to detect faces.**

Frames are displayed around any main subjects detected for skin smoothing. For more effective skin smoothing, you can move closer to or farther from the subject so that the frame is displayed on the subject's face.

- **Focus on the face.**

Before shooting, make sure [] appears on the subject's face when you are focusing.

Caution

- Areas other than people's skin may be modified, depending on the shooting conditions.
- If the smooth skin effect is too strong, images may not look as expected. Take some test shots in advance and check the results.

4K movie recording precautions

- Image quality on the standby screen may differ from image quality on the screen during movie recording.
- Briefly when you start recording movies, image display may remain on the current frame instead of being updated.

Note

- The **[Smooth skin effect]** setting is retained even if you change shooting modes or turn the camera off.

Movie IS Mode

Select [📷].

Enables movie recording with reduced camera shake.

You can select [📷 Digital IS] or [📷 Auto level] on the Quick Control screen (🔗, 🔗).



Screen brightness can be adjusted by selecting [☀️].

⚠️ Caution

- [📷: 📷 Digital IS] is set to [Off] when you have specified digital zoom.

Manual Exposure Movie

Select [M].

Enables you to set the shutter speed, aperture value, and ISO speed.

With ISO speed set to [AUTO], you can set exposure compensation.



1. Select [Q].



2. Select an item.





- Set by pressing the < ◀ ▶ > keys.
- Check the exposure level mark (2) to see how far the current exposure level is from the standard exposure level (1).

Auto Photo



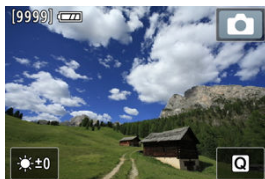

























Select .

The camera analyzes the scene and sets the optimum settings automatically.



Screen brightness can be adjusted by selecting .

An icon representing the type of scene detected appears in the upper right of the screen during shooting.

Subject Background		People		Subjects Other Than People			Background Color
			In Motion	Nature/ Outdoor Scene	In Motion	Close	
Bright						Gray	
Backlit							
Blue Sky Included						Light blue	
Backlit							
Sunset	*1			*1		Orange	
Spotlight						Dark blue	
Dark							
Night Scenes					*1		

* 1: Icons of scenes selected from those that can be detected are displayed.



Note

- For certain scenes or shooting conditions, the icon displayed may not match the actual scene.

Movie Recording Size

- [4K Movie Recording](#)
- [Cards That Can Record Movies](#)
- [Movie Recording Time Limit](#)

You can set the recording size, frame rate, and compression method in [ : **Movie rec. size**].

Note that the frame rate is updated automatically to match the [ : **Video system**] setting ().

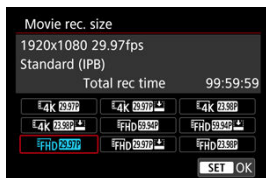



	Image Size	Aspect Ratio
	3840×2160	16:9
	1920×1080	16:9

Frame rate (fps: frames per second)

- **[59.94P] 59.94 fps / [29.97P] 29.97 fps**
For areas using the NTSC TV system, such as North America, Japan, South Korea, and Mexico.
- **[50.00P] 50.00 fps / [25.00P] 25.00 fps**
For areas using the PAL TV system, such as Europe, Russia, China, and Australia.
- **[23.98P] 23.98 fps**
Mainly for cinematic purposes. Available when [📺: Video system] is set to [For NTSC].

Compression method

- **[IPB] IPB (Standard)**
Compresses multiple frames at a time efficiently for recording.
- **[IPB] IPB (Light)**
Since the movie is recorded at a bit rate lower than with IPB (Standard), the file size will be smaller than with IPB (Standard) and the playback compatibility will be higher. This will make the available recording time longer than with IPB (Standard) (with a card of the same capacity).

Movie recording format

- **[MP4] MP4**
All movies you record with the camera are recorded as movie files in MP4 format (file extension ".MP4").



⚠ Caution

- If you change the [📺: Video system] setting, also set [📷: Movie rec. size] again.
- Normal playback of files such as 4K or [FHD] 59.94P/50.00P movies may not be possible on other devices, because playback is processing-intensive.
- Image quality (sense of resolution, noise, etc.) varies slightly depending on the movie recording size setting.

📌 Note

- To obtain better performance with the card, formatting the card with the camera before recording movies is recommended (🔗).
- Movies cannot be recorded in HD or VGA quality.

4K Movie Recording

- Recording 4K movies requires a stable card with a fast writing speed. For details, see [Cards That Can Record Movies](#).
- 4K movie recording greatly increases the processing load, which may increase the internal camera temperature faster or higher than for regular movies. **If a white  or red  icon appears during movie recording, the card may be hot, so stop recording the movie and let the camera cool down before removing the card. (Do not remove the card immediately.)**
- Condensation may form inside the camera lens if you record 4K movies in **[Smooth skin movie]** mode in humid environments.

Cards That Can Record Movies

See [Card performance requirements](#) for details on cards supporting all movie recording sizes.

Test cards by recording a few movies to make sure they can record correctly at your specified size (🔗).

Caution

- If you use a slow-writing card when recording movies, the movie may not be recorded properly. Also, if you play back a movie on a card with a slow reading speed, the movie may not be played back properly.
- When recording movies, use high-performance cards with a writing speed sufficiently higher than the bit rate.
- When movies cannot be recorded properly, format the card and try again. If formatting the card does not resolve the problem, refer to the card manufacturer's website, etc.

Note

- To obtain better performance with the card, formatting the card with the camera before recording movies is recommended (🔗).
- To check the card's writing/reading speed, refer to the card manufacturer's website, etc.

Movie Recording Time Limit

The maximum recording time per movie is 1 hr. Once 1 hr. is reached, recording stops automatically. You can start recording a movie again by pressing the Start/Stop button (which records the movie as a new file).

Caution

- The camera's internal temperature may rise and less recording time may be available after extended movie playback/Live View display.

Sound Recording

 [Sound Recording/Sound-Recording Level](#)

 [Wind Filter](#)

You can record movies while recording sound with the built-in stereo microphone or an external stereo microphone. You can also freely adjust the sound-recording level.

Use : **Sound recording**] to set sound recording functions.

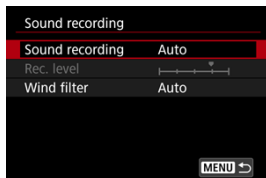

Caution

- Sounds from Wi-Fi operations may be captured with built-in or external microphones. For best results, avoid using wireless features when recording.
- If you perform camera operations during movie recording, the camera's built-in microphone may also record sounds of lens or camera operations. If so, it may help reduce these sounds if you use an external microphone equipped with an output plug and position it away from the camera.
- Do not connect anything other than an external microphone to the camera's external microphone IN terminal.

Note

- Audio is also output when the camera is connected to televisions via HDMI, unless **[Sound recording]** is set to **[Disable]**. In case of feedback from television audio output, move the camera away from the television or turn down the volume.
- The volume balance between L/R (left/right) cannot be adjusted.

Sound Recording/Sound-Recording Level

● Auto

The sound-recording level is adjusted automatically. Auto level control will take effect automatically in response to the sound level.

● Manual

You can adjust the sound-recording level as needed. Select **[Rec. level]** and press the <◀> <▶> keys while looking at the level meter to adjust the sound-recording level. Look at the peak hold indicator, and adjust so that the level meter sometimes lights up on the right of the "12" (-12 dB) mark for the loudest sounds. If it exceeds "0," the sound will be distorted.

You can adjust the recording level during recording by tapping **[M]**.

● Disable

Sound will not be recorded.

Wind Filter

Set to **[Auto]** to reduce audio distortion in windy outdoor scenes. Disabled when external microphone is connected to the external microphone IN terminal. When the wind filter function takes effect, part of the low bass sounds will also be reduced.

Movie ISO Speed Settings

- **ISO speed**

You can set your preferred ISO speed. Select **[ISO speed]** to access the ISO speed setting screen. Set by pressing the <◀> <▶> keys. You can also select ISO Auto by pressing the <↻> button.

- **Max for ISO speed**

Enables you to set the maximum value for **[ISO speed]** used for Full HD movie recording.

- **Max for 4K**

Enables you to set the maximum value for **[ISO speed]** used for 4K movie recording.

 **Caution**

- **[Max for ISO speed]** and **[Max for 4K]** do not determine the maximum value for ISO Auto.

Movie Auto Slow Shutter

You can choose whether to record movies that are brighter and less affected by image noise than when set to **[Disable]** by automatically slowing the shutter speed under low light.

Available in **[Movie]** recording mode. With **[Movie IS mode]**, this feature is fixed to **[Enable]**, and with **[Smooth skin movie]**, to **[Disable]**. Applies when the frame rate of the movie recording size is **59.94P** or **50.00P**.

1. Select **[Auto slow shutter]**.

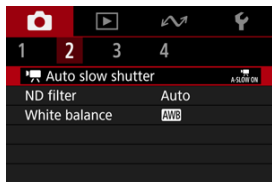

2. Select an option.

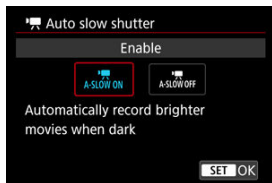

- **Disable**
Enables you to record movies with smoother, more natural movement, less affected by subject shake than when set to **[Enable]**. Note that under low light, movies may be darker than when set to **[Enable]**.
- **Enable**
Enables you to record brighter movies than when set to **[Disable]** by automatically reducing the shutter speed to 1/30 sec. (NTSC) or 1/25 sec. (PAL) under low light.



Note

- Setting to **[Disable]** is recommended when recording moving subjects under low light, or when afterimages such as trails may occur.

ND Filter

For optimal brightness in the scenes you shoot, Auto ND filter reduces light intensity to 1/8 the actual level, by an amount equivalent to three stops. Besides **[Auto]**, you can also select **[Off]** or **[On]**.

1. Select **[📷: ND filter]**.

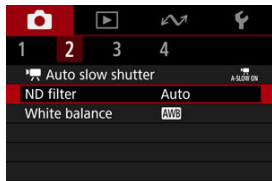

2. Select an option.

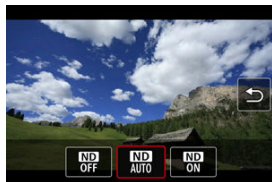

! Caution

- Selecting **[On]** or **[Auto]** makes it more likely that image noise will occur, even in bright scenes, because it is easier for the ISO speed to increase.
- ND: Neutral Density

Precaution on using Auto ND filter

- ND filter status does not change once recording begins for movie recording or streaming, even when **[Auto]** is set.
- For best results, set to **[Off]** if you will go from a bright to a dark environment while recording movies.
- **[📷: ND filter]** is set to **[Off]** when the camera is used as webcam.

White Balance

 [\[AWB\] Auto White Balance](#)

 [\[K\] Color Temperature](#)





White balance (WB) is for making the white areas look white. Normally, the Auto [\[AWB\]](#) (Ambience priority) or [\[AWBW\]](#) (White priority) setting will obtain the correct white balance. If natural-looking colors cannot be obtained with Auto, you can select a white balance corresponding to the light source.

[\[AWB\]](#) (Ambience priority) is set automatically for [\[Smooth skin movie\]](#), [\[Movie IS mode\]](#), or [\[Auto photo\]](#) modes.

Note

- The human eye adapts to changes in lighting so that white objects look white under all kinds of lighting. Cameras determine white from the color temperature of lighting and, based on this, apply image processing to make color tones look natural in your shots.
- For [\[AWB\]](#) and [\[AWBW\]](#) setting instructions, see [\[AWB\] Auto White Balance](#).
- To set your preferred color temperature, select [\[K\]](#) in [\[📷: White balance\]](#), press [<↖>](#), then press the [<◀>](#) [<▶>](#) keys.

(Approx.)

Display	Mode	Color Temperature (K: Kelvin)
[AWB]	Auto (Ambience priority)	3000–7000
[AWBW]	Auto (White priority)	
	Daylight	5200
	Shade	7000
	Cloudy, twilight, sunset	6000
	Tungsten light	3200
	White fluorescent light	4000
[K]	Color temperature	2500–10000

[AWB] Auto White Balance

With [AWB] (Ambience priority), you can slightly increase the intensity of the image's warm color cast when shooting a tungsten-light scene.

If you select [AWBW] (White priority), you can reduce the intensity of the image's warm color cast.

1. Select [📷: White balance].

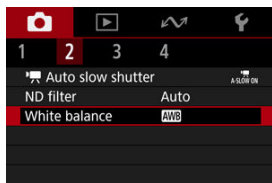

2. Select [AWB].



- With [AWB] selected, press the <📶> button.

3. Select an option.



 Caution

Precautions when set to [AWB] (White priority)

- The warm color cast of subjects may fade.
- When multiple light sources are included in the scene, the warm color cast of the picture may not be reduced.

[K] Color Temperature

A value can be set representing the white balance color temperature.

1. Select [📷: White balance].

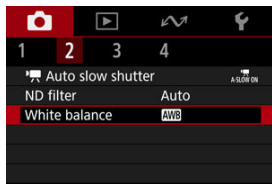

2. Set the color temperature.

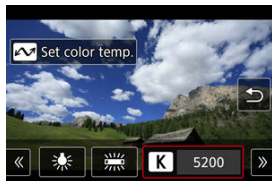

- Select [K], then press <↩>.
- Press the <◀> <▶> keys to set your preferred color temperature, then press the <📷> button.
- The color temperature can be set from approx. 2500K to 10000K in 100K increments.

Note

- When setting the color temperature for an artificial light source, correct the white balance (toward magenta or green) in [📷] on the Quick Control screen as needed.
- When setting [K] to a value measured with a commercially available color temperature meter, take some test shots in advance and adjust the setting as needed to compensate for any difference between the color temperature meter and the camera.

Autofocus Method

- [Face Tracking AF](#)
- [Specified Frame AF](#)
- [AF Shooting Tips](#)
- [Shooting Conditions That Make Focusing Difficult](#)

You can change the method of autofocusing (autofocus method) to suit the subject and scene you are shooting.

1. Select [CAMERA]: Autofocus method].

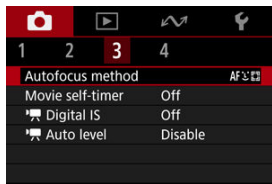

2. Select an autofocus method.

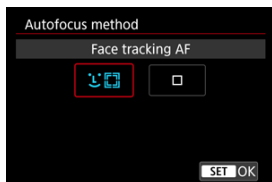

Face Tracking AF

The camera detects and focuses on people's faces.
When no face is detected, focusing areas are determined automatically.

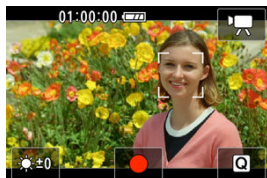

⚠ Caution

- An object other than a human face may be detected as a face.
- The camera may not detect faces that are very small or large in the picture, too bright or dark, or partly hidden.
- AF may not detect subjects or people's faces at the edges of the screen.
Recompose the shot to center the subject or bring the subject closer to the center.

Specified Frame AF

The camera focuses in a single AF point that you specify. You can move the AF point to your preferred position by tapping, dragging, or using the <▲> <▼> <◀> <▶> keys after tapping the screen to display the AF point selection screen.



AF Shooting Tips

- It may take some time to focus, depending on the subject and shooting conditions.
- The available autofocus range varies depending on the aspect ratio, image stabilization, and other settings.

Shooting Conditions That Make Focusing Difficult

- Subjects with low contrast, such as a blue sky or flat surfaces in solid colors, or other cases when highlight or shadow details are clipped.
- Subjects in low light.
- Stripes and other patterns where there is contrast only in the horizontal direction.
- Fine lines and subject outlines.
- Under light sources with constantly changing brightness, colors, or patterns.
- Night scenes or points of light.
- The image flickers under fluorescent or LED lighting.
- Extremely small subjects.
- Subjects at the edge of the screen.
- Strongly backlit or reflective subjects (Example: Car with a highly reflective surfaces, etc.).
- Near and distant subjects covered by an AF point (Example: Animal in a cage, etc.).
- Subjects that keep moving within the AF point and will not stay still due to camera shake or subject blur.
- Performing AF when the subject is very far out of focus.
- Noise (dots of light, banding, etc.) appears on the screen during AF.

Movie Self-Timer

Recording can be started by the self-timer.

1. Select [📷: Movie self-timer].

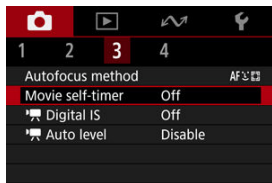

2. Select an option.

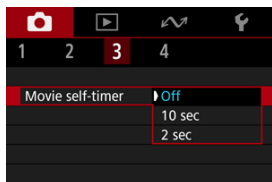

3. Record the movie.

- After you press the Start/Stop button, the camera beeps and displays number of seconds left before recording.

Note

- Can also be set by pressing the <▲> key on the shooting screen.
- To cancel the self-timer, either tap the screen or press the <📷> button.

IS Settings

You can reduce camera shake as movies are recorded.

Caution

- Set [📷: 🗨️ Auto level] to [Disable].

1. Select [📷: 🗨️ Digital IS].

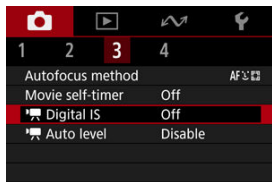

2. Select an option.

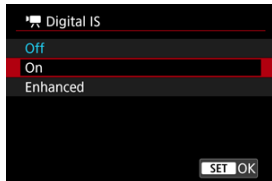

- **Off** (🗨️ Off)
Deactivates image stabilization.
- **On** (🗨️ On)
Camera shake will be corrected. The image will be slightly magnified.
- **Enhanced** (🗨️ Enhanced)
Compared to when [On] is set, stronger camera shake can be corrected. The image will be more magnified.

 Caution

- Stabilization from the Digital IS setting may be less effective at some movie recording sizes.
- Consider setting to **[Off]** when using a tripod.
- Depending on the subject and shooting conditions, subject blur may be noticeable (subjects may look out of focus momentarily) due to the effect of the Digital IS setting.
- Images look more grainy due to the Digital IS setting, which magnifies images. Noise, dots of light, etc. may also become noticeable.

Movie Auto Level

Auto leveling helps keep movies straight as you record them. With this feature set, the display area may narrow, and subjects may be enlarged.

⚠ Caution

- Set [📷: 🗨 Digital IS] to [Off].

1. Select [📷: 🗨 Auto level].

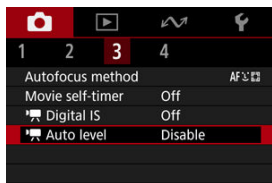

2. Select an option.

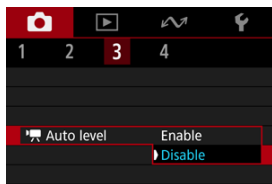

Grid

A grid can be displayed on the screen.

1. Select [CAMERA]: Grid display].

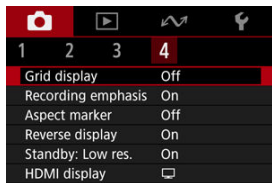

2. Select an option.

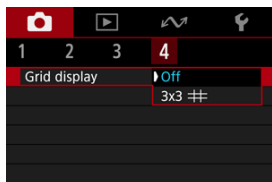

Recording Emphasis

Displays a blinking red frame around the screen during movie recording. This makes it easy to see at a glance that recording is in progress.

1. Select [: Recording emphasis].

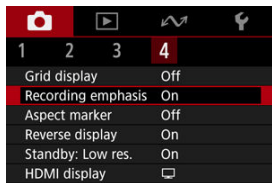

2. Select [On].

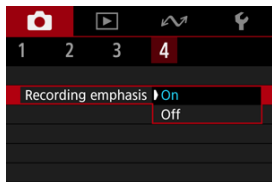

Aspect Marker

If you will change the image aspect ratio when editing the recorded movie, you can display aspect markers on the movie recording screen (during standby and recording) to be aware of the final angle of view after editing.

1. Select [: Aspect marker].

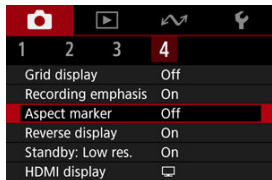

2. Select an option.

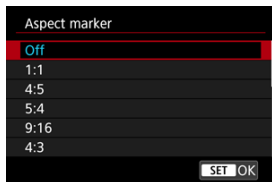

- To hide the markers, select [**Off**].

Caution

- Markers are not included in recorded movies.

Reverse Display

A mirror image can be displayed when you shoot with the screen rotated toward the subject (toward the front of the camera).

1. Select [: Reverse display].

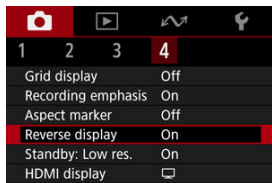

2. Select [**On**].

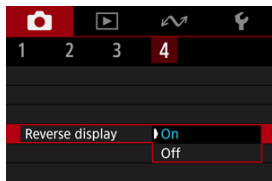

- Select [**Off**] if you prefer not to reverse display when the screen is facing the subject.

Standby: Low Resolution

Set to [On] to conserve battery power and control the rise of camera temperature during standby.

As a result, it may enable you to record movies over a longer period.

1. Select [📷: Standby: Low res.].

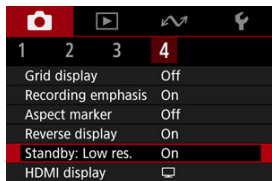

2. Select [On].

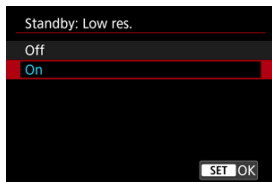

! Caution

- Image quality on the standby screen may differ from image quality on the screen during movie recording.
- Briefly when you start recording movies, image display may remain on the current frame instead of being updated.

Display During HDMI Connection

You can specify how movies are displayed as they are recorded via HDMI to an external device. Movie output itself corresponds to the [CAMERA: Movie rec. size] setting.

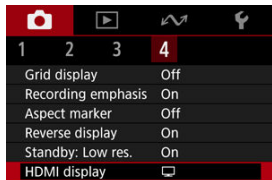

The default setting is [MONITOR].

1. Select [CAMERA: HDMI display].

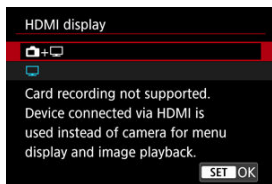

2. Select an option.





-  Enables movie display both on the camera screen and on the other device, via HDMI output. Camera operations such as image playback or menu display are shown on the other device via HDMI, not on the camera screen.
-  Deactivates the camera screen during output via HDMI, so that the screen is blank. Shooting information, AF points, and other information is shown in the HDMI video output.

Caution

- Card recording is not performed with **[HDMI display]** set to . Camera menus and image playback are only displayed on the screen connected via HDMI.
- The HDMI output resolution and frame rate are automatically adjusted to suit the movie recording size.

? For longer HDMI output

To continue HDMI output for longer than 30 min., select , then set **[Auto power off]** in : **[Power saving]** to **[Disable]** . HDMI output will continue after the camera screen turns off when the time set in **[Screen off]** elapses.

Caution

- HDMI output without information prevents display of warnings about the card space, battery level, or high internal temperature  via HDMI.
- During HDMI output, display of the next image may take some time if you switch between movies of different recording sizes or frame rates.
- Avoid operating the camera when recording movies to external devices, which may cause information to be displayed in the HDMI video output.
- Brightness and color of movies recorded with the camera may look different from those of HDMI video output recorded by external devices, depending on the viewing environment.

Note

- By pressing the **<INFO>** button, you can change the information displayed.
- Audio is also output via HDMI, except when set to **[Sound recording: [Disable]]**.

Image Quality

You can select the pixel count and the image quality.

1. Select [📷: Image quality].

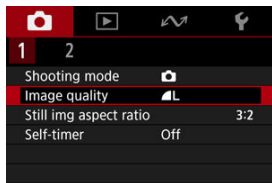

2. Select an option.

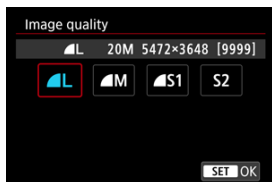

Still Image Aspect Ratio

You can change the image's aspect ratio.

1. Select [📷: Still img aspect ratio].

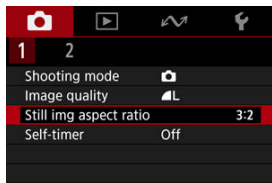

2. Select an option.

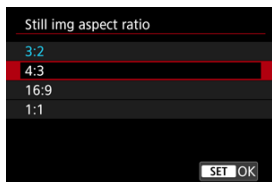

Touch Shutter

Just by tapping the screen, you can focus and take the picture automatically.

1. Select [📷: Touch Shutter].

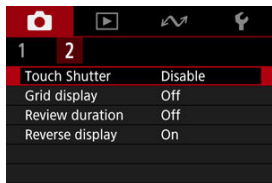

2. Select [Enable].

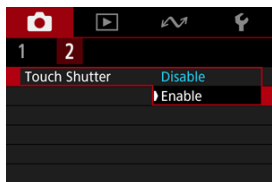

3. Tap the screen to shoot.

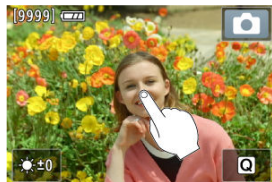

- Tap the face or subject on the screen.
- After the camera focuses, the AF point turns green and a picture is taken automatically.
- The AF point turns yellow if the camera cannot focus, but a picture is still taken.

 **Caution**

- When shooting by tapping with [: **Review duration**] set to [**Hold**], you can take the next shot by tapping [].

Review Duration

To keep the image displayed immediately after you shoot, set to **[Hold]**, and if you prefer not to have the image displayed, set to **[Off]**.

1. Select **[: Review duration]**.

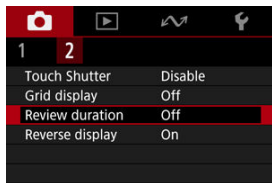

2. Select an option.

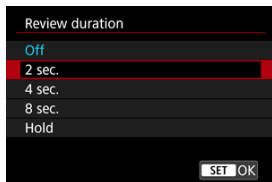

Note

- When **[Hold]** is set, images are displayed as long as the time set in the **[Screen off]** option of **[: Power saving]**.

General Movie Recording Precautions

- [Guidance Display Before Movie Recording](#)
- [Warning Indicator Display in Movie Recording](#)
- [Warning Icon for Low-Temperature Contact Burns](#)
- [Other Precautions](#)

Guidance Display Before Movie Recording

Guidance may be displayed when the camera starts up, after settings are adjusted, or in other situations.

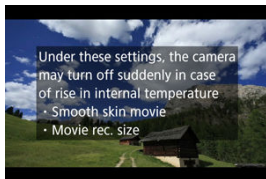

The guidance warns that the camera may become hot internally if movies are recorded under the current settings, and that if you continue recording, the camera may turn off automatically.

If you will record over an extended period, consider changing the setting indicated by the guidance, so that you can record without the camera displaying guidance.

If you prefer to record without changing the settings, note any warning indicators displayed as you record.

Warning Indicator Display in Movie Recording

A 10-level indicator (1) is displayed during movie recording in case of excessive internal camera temperature.



As the internal temperature rises, the level on the indicator extends to the right. How fast the level increases will depend on shooting conditions. Levels 1–7 are marked in white, but once the temperature reaches level 8, the color changes.



[P03] flashes in red if you continue recording after the indicator reaches level 9, marked in orange. A flashing icon indicates that the camera will soon turn off automatically.



A message is displayed if you continue to record while the icon is flashing, and the camera automatically turns off.

● Subsequent recording

To keep recording under the same settings, leave the camera off and let it cool down a while. Note that the camera may overheat again after you resume recording.

Warning Icon for Low-Temperature Contact Burns

[] is displayed if the camera becomes warm during streaming or during image output to external devices. To avoid low-temperature contact burns at this time, do not touch the camera over an extended period.



- The camera may turn off automatically if communication or an external device connection is lost.

Caution

Precautions for movie recording

- Do not point the camera toward an intense light source, such as the sun or an intense artificial light source. Doing so may damage the image sensor or the camera's internal components.
- If you record something that has fine detail, moire or false colors may result.
- If [AWB] or [AWBW] is set and the ISO speed or aperture value changes during movie recording, the white balance may also change.
- If you record a movie under fluorescent or LED lighting, the movie image may flicker.
- Large aperture values may delay or prevent accurate focusing.
- Performing AF during movie recording may cause the following kinds of issues: significant temporary loss of focus, recording of changes in movie brightness, temporary stopping of movie recording, or recording of mechanical lens sounds.
- Avoid covering the built-in microphone with your fingers or other objects.
- Connecting or disconnecting an HDMI cable during movie recording will end recording.
- If necessary, also see [General Still Photo Shooting Precautions](#).
- The camera may become warm during streaming or during image output to external devices. Use the stand or a tripod, or take other measures to avoid handheld recording.

Recording and image quality

- If there is a very bright light source in the image, the bright area may appear black on the screen. Movies are recorded almost exactly as they appear on the screen.
- Image noise (such as dots of light or banding) or irregular colors may occur when shooting at high ISO speeds, high temperatures, slow shutter speeds, or under low light. Movies are recorded almost exactly as they appear on the screen.
- Video and audio quality of recorded movies may be worse on other devices, and playback may not be possible, even if the devices support MP4 formats.

Note

Notes for movie recording

- Each time you record a movie, a new movie file is created on the card.
- With some cards, a new file is created each time the file size exceeds approx. 4 GB.
- Field of view (coverage) is approx. 100%.
- Most external microphones equipped with a 3.5 mm mini-plug can be used.
- Any connected external microphone is used instead of the built-in microphone.

General Still Photo Shooting Precautions



Caution

- Do not point the camera toward an intense light source, such as the sun or an intense artificial light source. Doing so may damage the image sensor or the camera's internal components.

Image quality

- Shooting in high temperatures may cause noise and irregular colors in the image.
- Frequent shooting over an extended period may cause high internal temperatures and affect image quality. When you are not shooting, always turn off the camera.



White internal temperature warning icon

- A white  icon indicates high internal camera temperature. The white  icon indicates that the image quality of still photos will decline. Stop shooting for a while and allow the camera to cool down.
- If the camera's internal temperature is high, the quality of images shot with a high ISO speed may decline even before the white  icon is displayed.

Images and display

- Under low- or bright-light conditions, the displayed image may not reflect the brightness of the captured image.
- Pointing the camera at different direction may momentarily prevent correct display of brightness. Wait until the brightness level stabilizes before shooting.
- If there is a very bright light source in the image, the bright area may appear black on the screen. However, the actual captured image will correctly show the bright area.
- Under low light, bright [: **Screen brightness**] settings may cause noise or irregular colors in images. However, the noise or irregular colors will not be recorded in the captured image.
- When you magnify the image, the image sharpness may look more pronounced than in the actual image.

Note

- Field of view (coverage) is approx. 100%.
- If the camera is idle over an extended period, the screen will turn off automatically after the time set in [**Auto power off**] or [**Screen off**] under [: **Power saving**]. If the screen turns off automatically after the time set in [**Screen off**], the camera will then turn off automatically after the time set in [**Auto power off**] ().
- Using a commercially available HDMI cable, you can display images on a television (). Note that no sound will be output.

Playback

This chapter covers topics related to playback—playing back captured still photos and movies—and introduces menu settings on the playback [▶] tab.

! Caution

- Normal display or selection on this camera may not be possible for images captured on other cameras, or images from this camera that have been edited or renamed on a computer.

- [Tab Menus: Playback](#)
- [Movie Playback](#)
- [Image Playback](#)
- [Playback on a TV Set](#)
- [Protecting Images](#)
- [Erasing Images](#)
- [Rotating Still Photos](#)
- [Changing Movie Orientation Information](#)
- [Rating Images](#)
- [Resuming from Previous Playback](#)

Tab Menus: Playback

● Playback 1

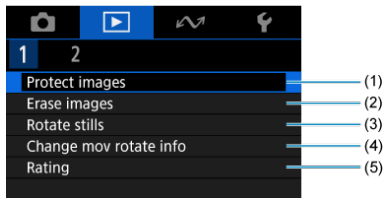

- (1) [Protect images](#)
- (2) [Erase images](#)
- (3) [Rotate stills](#)
- (4) [Change mov rotate info](#)
- (5) [Rating](#)

● Playback 2

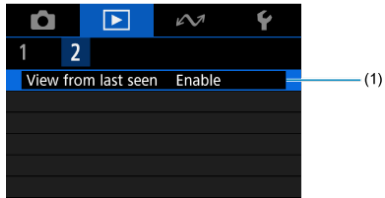

- (1) [View from last seen](#)

Movie Playback

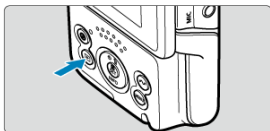

1. Switch to playback.





- Press the <  > button.

2. Select a movie.



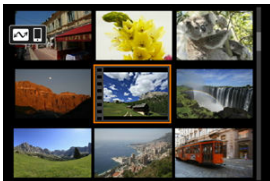



- Press the <  > <  > keys to select a movie to play.
- In single-image display, a  icon in the center of the screen indicates that the image is a movie.



- In index display, perforations at the left edge of a thumbnail indicate a movie. Movies cannot be played from index display, so press the <  > button to switch to single-image display.



3. In single-image display, press the <  > button.



- The movie will start playing back. Sound is played through the speaker.
- You can pause playback and access the movie playback panel by pressing the <  > button (). Press it again to resume the playback.
- Press the <  > <  > keys to adjust the volume (even during playback).

Movie playback panel



Item	Playback Operations
▶ Playback	Pressing the <  > button toggles between playing movies and pausing playback.
◀ Skip backward	Skips backward approx. 1 sec. each time you press the < ◀ > key. Holding down the < ◀ > key will rewind the movie.
▶ Skip forward	Skips forward approx. 1 sec. each time you press the < ▶ > key. Holding down the < ▶ > key will fast forward the movie.
	Playback position
hh:mm:ss	Playback time (hours:minutes:seconds)
🔊 Volume	Press the < ▲ > < ▼ > keys to adjust the speaker volume.
↶	Press the < MENU > button to return to single-image display.

⚠ Caution

- Adjust the volume using television controls when the camera is connected to a television for movie playback () , because volume cannot be adjusted by pressing the < ▲ > < ▼ > keys.
- Movie playback may stop if the card's read speed is too slow or movie files have corrupted frames.

Image Playback

[✔ Single-Image Display](#)

[✔ Touch Playback](#)

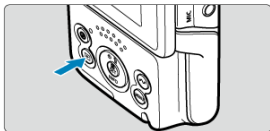

Single-Image Display

1. Switch to playback.



- Press the <  > button.
- The last image captured or played back is displayed.

2. Browse images.

- To play back images starting with your most recent shot, press the <  > key. To play back images starting with the first captured image, press the <  > key.
- Each time you press the < **INFO** > button, the display will change.

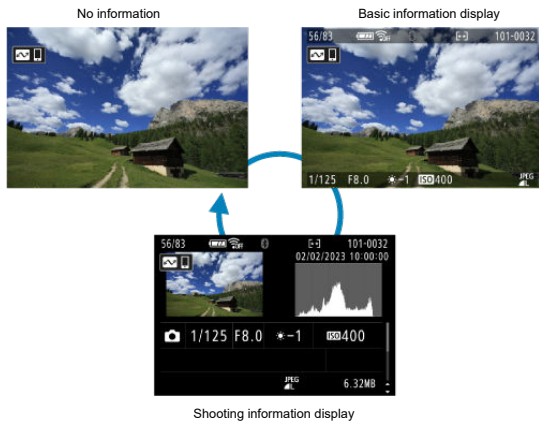

- With the shooting information screen displayed, you can swipe up or down to view other information.

3. Exit image playback.

- Press the <  > button to exit image playback and return to shooting standby.

Touch Playback

The camera features a touch-screen panel that you can touch to control playback. Supported touch operations are like those used with smartphones and similar devices. First, press the <  > button to prepare for touch playback.

Browse images



Index display



Magnified view





Note

- You can also magnify display by double-tapping with one finger.

Playback on a TV Set

By connecting the camera to a television with a commercially available HDMI cable, you can play back the captured still photos and movies on the television.

If the image does not appear on the TV screen, confirm that [**☛**: Video system] is correctly set to [For NTSC] or [For PAL] (depending on the video system of your television).

1. Connect the HDMI cable to the camera.

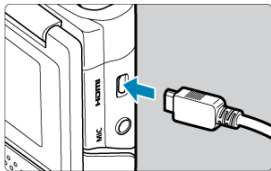

- Insert the HDMI cable in the camera's < **HDMI** > terminal.

2. Connect the HDMI cable to the television.

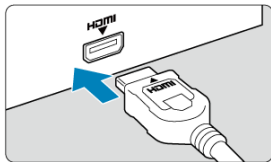

- Connect the HDMI cable to the television's HDMI IN port.

3. Turn on the television and switch the television's video input to select the connected port.
4. Turn the camera on.

5. Press the < ▶ > button.

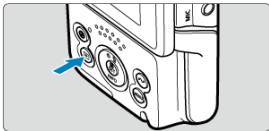

- Images are now displayed on the television, with nothing displayed on the camera screen.
- The images will automatically be displayed at the optimum resolution matching the connected television.

! Caution

- Adjust movie sound volume with the television. The sound volume cannot be adjusted with the camera.
- Before connecting or disconnecting the cable between the camera and television, turn off the camera and television.
- Depending on the television, part of the image displayed may be cut off.
- Do not connect any other device's output to the camera's < **HDMI** > terminal. Doing so may cause a malfunction.
- Certain televisions may not display the images due to incompatibility.
- It may take some time before images are displayed. To avoid delay, set [**⚙**: **HDMI resolution**] to [**1080p**] (**🔒**).
- Touch-screen operations are not supported while connected to a television with the camera screen off.

Protecting Images

- ✔ [Protecting Individual Images](#)
- ✔ [Specifying the Range of Images to Protect](#)
- ✔ [Protecting All Images in a Folder or on a Card](#)

You can protect important images from being accidentally erased.

! Caution

- If you format the card (🗑️), the protected images will also be erased.

📄 Note

- Once an image is protected, it cannot be erased by the camera's erase function. To erase a protected image, you must first cancel the protection.
- If you erase all the images (🗑️), only the protected images will remain. This is convenient when you want to erase all unneeded images at once.

Protecting Individual Images

1. Select [📄: Protect images].

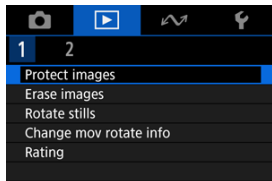

2. Select [Select images].

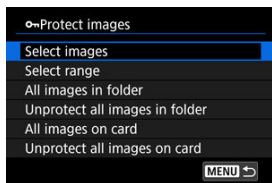





3. Select the image to protect.

- Press the < ◀ > ▶ > keys to select the image to protect.

4. Protect the image.



- Press the <  > button to protect the selected image, after which it will be labeled with a  icon (1) at the top of the screen.
- To cancel protection and clear the  icon, press the <  > button again.
- To protect another image, repeat steps 3 and 4.

Specifying the Range of Images to Protect

While looking at the images in the index display, you can specify the first and last images for a range to protect all the specified images at once.

1. Select [Select range].

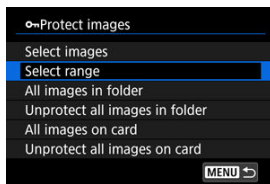

- Select [Select range] in [▶]: Protect images].

2. Specify the range of images.

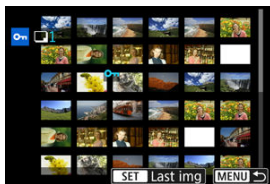

- Select the first image (start point).
- Next, select the last image (end point). The images in the specified range will be protected and the [P] icon will appear.
- To select another image to protect, repeat step 2.

Protecting All Images in a Folder or on a Card

You can protect all the images in a folder or on a card at once.

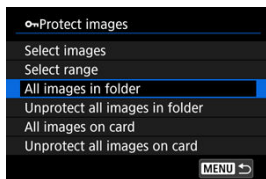

- When you select [**All images in folder**] or [**All images on card**] in [**▶**]: **Protect images**], all the images in the folder or on the card will be protected.
- To cancel protection, select [**Unprotect all images in folder**] or [**Unprotect all images on card**].

Erasing Images





- [Erasing Images Individually](#)
- [Selecting \(\[√\]\) Multiple Images to Erase Together](#)
- [Specifying the Range of Images to Erase](#)
- [Erasing All Images in a Folder or on a Card](#)

You can either select and erase unnecessary images individually or erase them in one batch. Protected images (🔒) will not be erased.

⚠ Caution

- **Once an image is erased, it cannot be recovered. Make sure you no longer need the image before erasing it. To prevent important images from being erased accidentally, protect them.**

Erasing Images Individually

1. Press the <  > button.
2. Select the image to be erased.
 - Press the <  >  > keys to select the image to erase.
3. Press the <  > button.

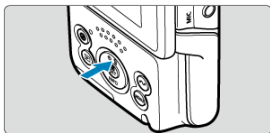

4. Erase the image.

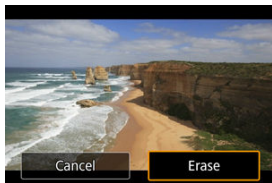

- Select [**Erase**].

Selecting ([✓]) Multiple Images to Erase Together

By adding checkmarks to the images to be erased, you can erase all those images at once.

1. Select [▶]: Erase images].

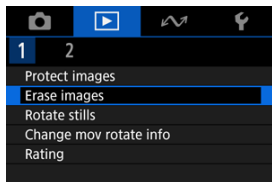

2. Select [Select and erase images].

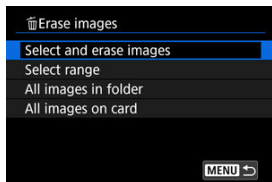

3. Browse images.



- Press the <◀> <▶> keys to select the image to erase, then press the <MENU> button.
- To select another image to be erased, repeat step 3.
- Press the <MENU> button.

4. Erase the images.

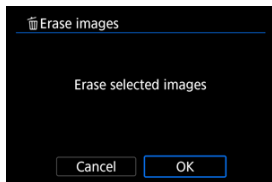

- Select **[OK]**.

Specifying the Range of Images to Erase

While looking at the images in the index display, you can specify the first and last images for a range to erase all the specified images at once.

1. Select [Select range].

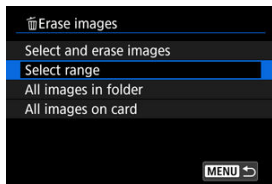

- Select [Select range] in [▶]: Erase images].

2. Specify the range of images.



- Select the first image (start point).
- Next, select the last image (end point). A checkmark [✓] will be appended to all the images within the range between first and last images.
- To select another image to be erased, repeat step 2.

3. Press the <MENU> button.

4. Erase the images.

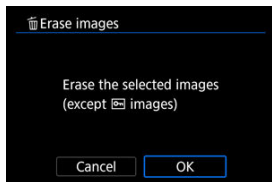

- Select **[OK]**.

Erasing All Images in a Folder or on a Card

You can erase all the images in a folder or on a card at once.

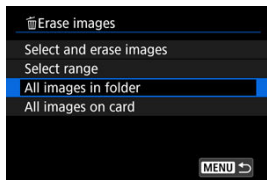

- When you select **[All images in folder]** or **[All images on card]** in []: **Erase images**, all the images in the folder or on the card will be erased.

Note

- To erase all the images including protected images, format the card ().

Rotating Still Photos

You can use this feature to rotate the displayed image to the desired orientation.

1. Select [▶]: Rotate stills].

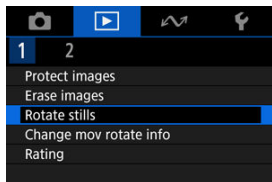

2. Select an image to rotate.

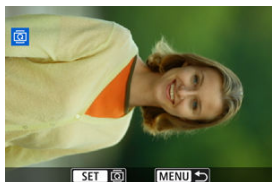

- Press the <◀> <▶> keys to select an image.



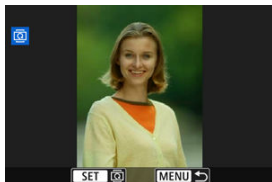

3. Rotate the image.



- Each time you press the <Ⓜ> button, the image is rotated clockwise as follows: 90° → 270° → 0°.
- To rotate another image, repeat steps 2 and 3.



Note

- If you set [**⚙**: **Auto rotate**] to [**On**] () before taking pictures, you need not rotate the image with this function.
- If the rotated image is not displayed in the rotated orientation during image playback, set [**⚙**: **Auto rotate**] to [**On**].
- Movies cannot be rotated.

Changing Movie Orientation Information

You can manually edit movie playback orientation information (which determines which side is up).

1. Select []: Change mov rotate info].

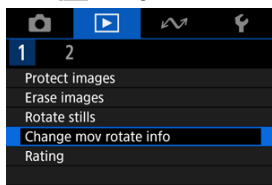

2. Select a movie.

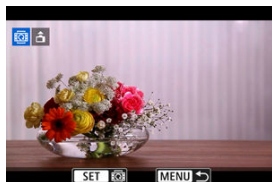

- Press the <◀> <▶> keys to select the movie with orientation information to change.

3. Change the orientation information.

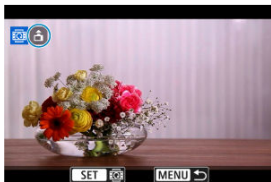

- As you watch the camera and ▲ icon in the upper left of the screen, press the < (Ⓜ) > button to specify which side is up. Each press of the < (Ⓜ) > button edits the movie orientation information as follows: [📷] → [📷] → [📷].

⚠ Caution

- Movies are played horizontally on the camera and via HDMI video output, regardless of the [📷: Add '📷 rotate info] setting (🔒).
- Movie orientation information of movies recorded with other cameras cannot be edited with this camera.

Rating Images

- [Rating Individual Images](#)
- [Rating by Specifying the Range](#)
- [Rating All Images in a Folder or on a Card](#)

You can rate images on a scale of 1–5 ([*]/[* *]/[* * *]/[* * * *]/[* * * * *]). This function is called rating.
* Rating images can help you organize them.

Rating Individual Images

1. Select [▶]: Rating].

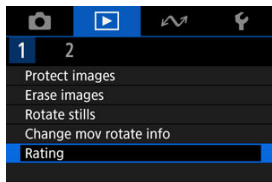

2. Select [Select images].

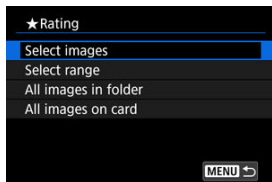

3. Select the image to be rated.



- Press the <◀>>▶> keys to select the image to rate.

4. Rate the image.



- Press the <Ⓢ/1> > button so that the current rating is outlined in blue, as shown.
- Press the <▲>><▼> keys to select a rating mark, then press the <Ⓢ/1> > button.
- When you append a rating mark to the image, the number beside the set rating will increase by one.
- To rate another image, repeat steps 3 and 4.

Rating by Specifying the Range

While looking at the images in the index display, you can specify the first and last images for a range to rate all the specified images at once.

1. Select [Select range].

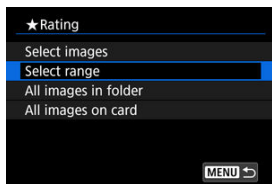

- Select [Select range] in [▶]: Rating.

2. Specify the range of images.



- Select the first image (start point).
- Next, select the last image (end point). A checkmark [✓] will be appended to all the images within the range between first and last images.
- To select other images, repeat step 2.

3. Press the <MENU> button.

4. Rate the image.



- Press the < ▲ > < ▼ > keys to select a rating mark, then select [OK]. All the images in the specified range will be rated (same rating) at once.

Rating All Images in a Folder or on a Card

You can rate all the images in a folder or on a card at once.

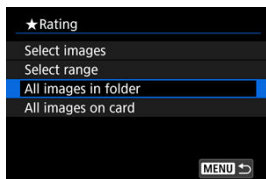

- Under [**▶**]: **Rating**], when you select [**All images in folder**] or [**All images on card**], all the images in the folder or on the card will be rated.



- Press the < ▲ > < ▼ > keys to select a rating, then select [**OK**].
- When you are not rating images or canceling the rating, select [**OFF**].

Note

- Values next to rating marks are displayed as [###] if more than 1,000 images have that rating.

Resuming from Previous Playback

1. Select [▶]: View from last seen.

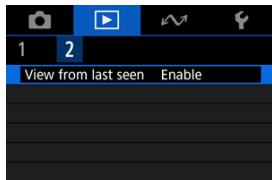

2. Select an option.

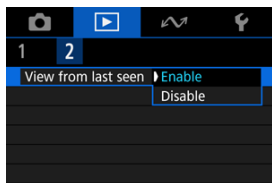

- **[Enable]**: Playback resumes from the last image displayed (unless you have just finished shooting).
- **[Disable]**: Playback resumes from your most recent shot whenever the camera is restarted.

Wireless Features

This chapter describes how to stream or perform other operations over a Bluetooth® or Wi-Fi connection.

Caution

Important

- Note that Canon cannot be held liable for any loss or damage caused by erroneous wireless communication settings when using the camera. In addition, Canon cannot be held liable for any other loss or damage caused by use of the camera. When using wireless communication functions, establish appropriate security at your own risk and discretion. Canon cannot be held liable for any loss or damage caused by unauthorized access or other security breaches.

- [Tab Menus: Wireless Features](#)
- [Connecting to a Smartphone or Tablet](#)
- [Connecting to a Wireless Remote Control](#)
- [Uploading Images to image.canon](#)
- [Live Streaming](#)
- [Advanced Connections](#)
- [GPS Settings](#)
- [Basic Communication Settings](#)
- [Reconnecting via Wi-Fi/Bluetooth](#)
- [Editing/Deleting Devices for Connections](#)
- [Airplane Mode](#)
- [Wi-Fi Settings](#)
- [Bluetooth Settings](#)
- [Camera Name](#)
- [Error Details](#)
- [Resetting Communication Settings](#)
- [Virtual Keyboard Operations](#)
- [Responding to Error Messages](#)
- [Wireless Communication Precautions](#)
- [Security](#)
- [Checking Network Settings](#)
- [Wireless Communication Status](#)

Tab Menus: Wireless Features

● Communication functions 1

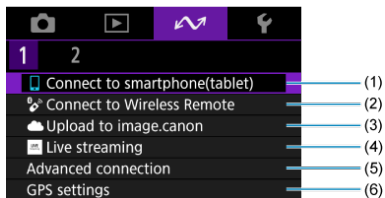

- (1) [Connect to smartphone\(tablet\)](#)
- (2) [Connect to Wireless Remote](#)
- (3) [Upload to image.canon](#)
- (4) [Live streaming](#)
- (5) [Advanced connection](#)
- (6) [GPS settings](#)

● Communication functions 2

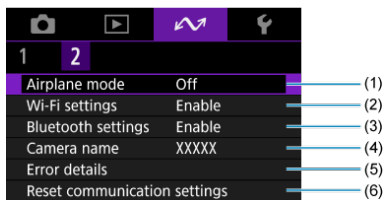

- (1) [Airplane mode](#)
- (2) [Wi-Fi settings](#)
- (3) [Bluetooth settings](#)
- (4) [Camera name](#)
- (5) [Error details](#)
- (6) [Reset communication settings](#)

 **Caution**

- Some menu items cannot be configured while the camera is connected to computers or other devices via an interface cable.
- Wi-Fi connections are terminated when you turn the camera off.
- With a Wi-Fi connection established, the camera's auto power off does not function.

Connecting to a Smartphone or Tablet

 [Preparing the Smartphone](#)





 [Connecting to a Smartphone via Wi-Fi](#)

 [Main Functions of Camera Connect](#)



 [Maintaining a Wi-Fi Connection When the Camera Is Off](#)

 [Canceling the Pairing](#)

You can do the following after pairing the camera with a smartphone.

- Establish a Wi-Fi connection using only the smartphone ()
- Establish a Wi-Fi connection with the camera even when it is off ()
- Geotag images with GPS information acquired by the smartphone ()
- Control the camera remotely from a smartphone ()

You can also do the following after connecting the camera to a smartphone via Wi-Fi.

- Browse and save images on the camera from a smartphone ()
 - Control the camera remotely from a smartphone ()
-

Turning on Bluetooth and Wi-Fi on a Smartphone

Turn on Bluetooth and Wi-Fi from the smartphone settings screen. Note that pairing with the camera is not possible from the smartphone's Bluetooth settings screen.

Installing Camera Connect on a Smartphone

The dedicated app Camera Connect (free of charge) must be installed on the smartphone on which Android or iOS is installed.

- Use the latest version of the smartphone OS.
- Camera Connect can be installed from Google Play or App Store. Google Play or App Store can also be accessed using the QR codes that appear when the camera is paired or connected via Wi-Fi to a smartphone.



Note

- For the operating system versions supported by Camera Connect, refer to the download site of Camera Connect.
- Sample screens and other details in this guide may not match the actual user interface elements after camera firmware updates or updates to Camera Connect, Android, or iOS.

Connecting to a Smartphone via Wi-Fi

If the **[Welcome]** screen displayed initially indicates that the smartphone and camera are already paired, go to step 10.

1. Select [**Wi-Fi**]: **[Connect to smartphone(tablet)]**.

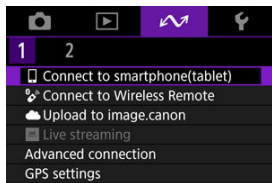

2. Select **[OK]**.



- This screen is not displayed if the Wi-Fi setting is already set to **[Enable]**.

3. Select **[Add a device to connect to]**.

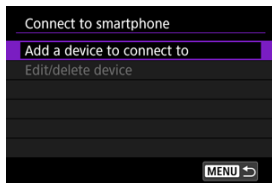

4. Select [OK].

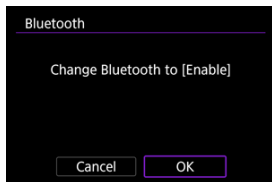

- This screen is not displayed if the Bluetooth setting is already set to [Enable].

5. Press the < [SET] > button.

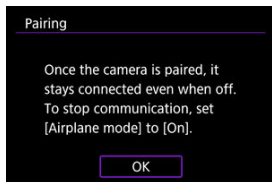

6. Start pairing.



- Press the < [SET] > button to start pairing.
- If Camera Connect is not installed, use the smartphone to scan the QR code on the screen, go to Google Play or App Store to install Camera Connect, then press the < [SET] > button to start pairing.

7. Start Camera Connect.

- Following the instructions in the app, select the camera for pairing.

8. Establish a Bluetooth connection.

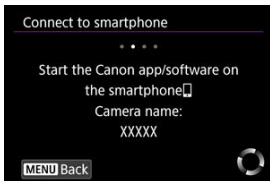

- When a message appears on the smartphone, use the smartphone as indicated.



- Press the <  > button.

9. Complete the pairing process.



- Press the <  > button to finish pairing.

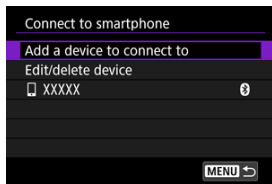

- The name of the connected device is displayed.

Caution

- The camera cannot be connected to two or more devices at the same time via Bluetooth. To switch to a different smartphone for the Bluetooth connection, see [Reconnecting via Wi-Fi/Bluetooth](#).
- Keep in mind that the camera battery level may be low the next time you want to use it, because Bluetooth connections consume battery power even when the camera is off.

Troubleshooting pairing

- Keeping pairing records for previously paired cameras on your smartphone will prevent it from pairing with this camera. Before you try pairing again, remove pairing records for previously paired cameras from your smartphone's Bluetooth settings screen.

10. Tap a Camera Connect function.

- For details on Camera Connect functions, see [Main Functions of Camera Connect](#).
- Tap a Camera Connect function to initiate a Wi-Fi connection.

11. Confirm that the devices are connected via Wi-Fi.

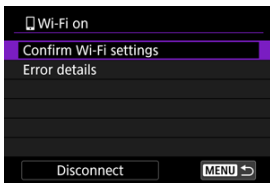

- [Wi-Fi on] is displayed on the camera screen (📷).

The Wi-Fi connection to a smartphone is now complete.

- To end the Wi-Fi connection, select [Disconnect] on the [Wi-Fi on] screen.
- Terminating the Wi-Fi connection will switch the camera to the Bluetooth connection.
- To reconnect, start Camera Connect and tap the function you will use.

[Wi-Fi on] screen



- **Confirm Wi-Fi settings**
You can check setting details for Wi-Fi connections.
- **Error details**
After any Wi-Fi connection errors, you can check the error details ([🔗](#)).
- **Disconnect**
Terminates the Wi-Fi connection.

Main Functions of Camera Connect

Images on camera

- Images can be browsed, deleted, or rated.
- Images can be saved on a smartphone.

Remote live view shooting

- Enables remote shooting as you view a live image on the smartphone.

Bluetooth remote controller

- Enables remote control of the camera from a smartphone paired via Bluetooth. (Not available when connected via Wi-Fi.)
- Auto power off is disabled while you are using the Bluetooth remote controller feature.

Camera settings

- Camera settings can be changed.

You can check other functions from the main Camera Connect screen.

Maintaining a Wi-Fi Connection When the Camera Is Off

You can use a smartphone to browse images on the camera or perform other operations even when the camera is off, as long as it is paired to the smartphone via Bluetooth. If you prefer not to stay connected to the camera via Wi-Fi or Bluetooth when it is off, either set [📶: Airplane mode] to [On] or set [📶: Bluetooth settings] to [Disable].

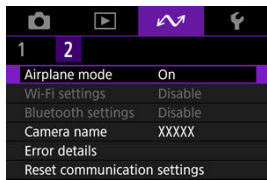

⚠ Caution

- This function can no longer be used if the wireless settings are reset or the smartphone connection information is erased.

Canceling the Pairing

Cancel pairing with a smartphone as follows.

1. Select [MENU]: [Connect to smartphone(tablet)].

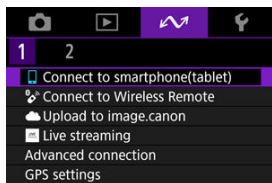

2. Select [Edit/delete device].

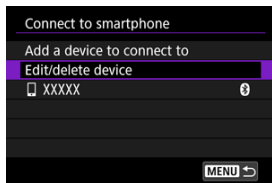

3. Select the smartphone to cancel pairing with.

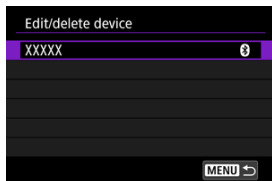

- Smartphones currently paired with the camera are labeled [0].

4. Select [Delete connection information].

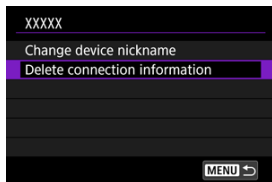

5. Select [OK].

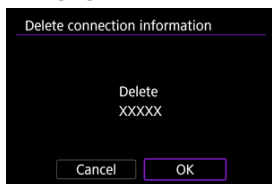

6. Clear the camera information on the smartphone.

- In the smartphone's Bluetooth setting menu, clear the camera information registered on the smartphone.

Connecting to a Wireless Remote Control

[Canceling the Pairing](#)

This camera can also be connected to Wireless Remote Control BR-E1 (sold separately) via Bluetooth for remote control shooting.

1. Select [ Connect to Wireless Remote].

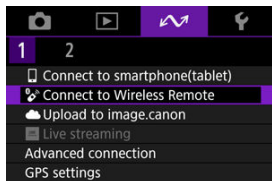

2. Select [**Add a device to connect to**].

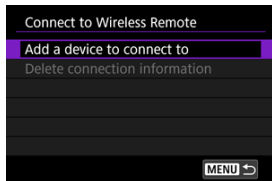

The following message appears if the camera is paired with a smartphone:
[End the current Bluetooth connection and pair with the Wireless Remote].

3. Select [OK].

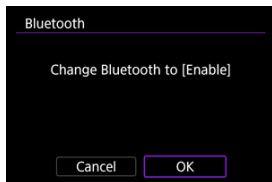

- This screen is not displayed if the Bluetooth setting is already set to [Enable].

4. Pair the devices.

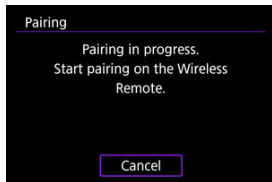

- When the screen shown above appears, press and hold the <W> and <T> buttons on the BR-E1 simultaneously for at least 3 sec.
- After a message confirms that the camera is paired with the BR-E1, press the <Ⓜ> button.

5. Set up the camera for remote shooting.



- For instructions after the pairing is complete, refer to the BR-E1's Instruction Manual.

Caution

- Keep in mind that the camera battery level may be low the next time you want to use it, because Bluetooth connections consume battery power even when the camera is off.



Note

- When you will not use Bluetooth, setting [: **Bluetooth settings**] to [**Disable**] is recommended ().

Canceling the Pairing

Before pairing with a different BR-E1, clear the information about the connected remote control.

1. Select [ Connect to Wireless Remote].

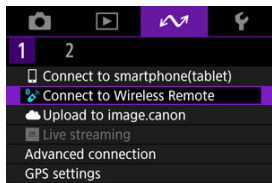

2. Select [Delete connection information].



3. Select [OK].

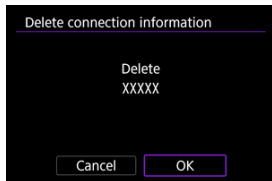

Uploading Images to image.canon

Link the camera to image.canon to send images directly from the camera.

- A smartphone with a browser and internet connection is required.
 - You will need to enter an email address used on the smartphone.
 - For instructions on how to use image.canon services and details on countries and regions where it is available, visit the image.canon site (<https://image.canon/>).
 - Separate ISP connection and access point fees may apply.
-

1. Select [↗]: Upload to image.canon].

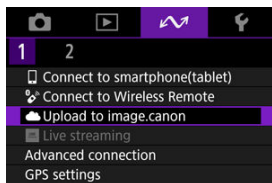

2. Select [OK].

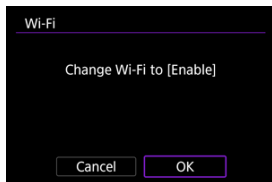

- This screen is not displayed if the Wi-Fi setting is already set to [Enable].

3. Select [Connect].

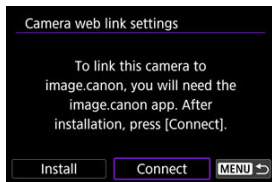

- If the dedicated app has not been installed, select [Install].

4. Select [OK].

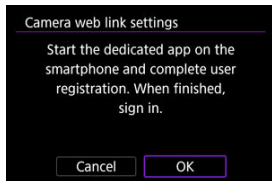

5. Scan the QR code with the dedicated app.



- Select [OK].

6. Establish a Wi-Fi connection.

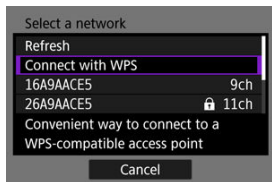

- Connect to an access point via Wi-Fi. Follow the instructions for the connection method used.
 - Connecting via WPS (🔗, 🔗)
 - Connecting manually to detected networks (🔗)
 - Connecting manually by specifying access point information (🔗)

7. Confirm that the number is displayed in the dedicated app.

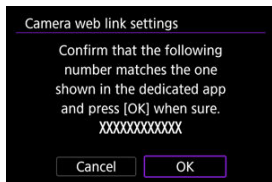

- Select **[OK]**.

8. Set up automatic image transfer.

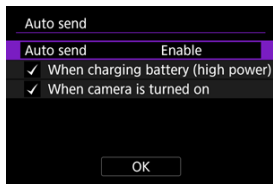

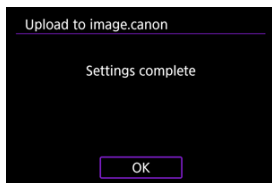

- Complete the [**Auto send**] setting item as needed.
- [**When charging battery (high power)**]: Auto send starts when the camera is off and connected to a power source to charge it over USB. Note that auto send will start after the camera has been charged for a while if the remaining capacity is initially low.
- [**When camera is turned on**]: Auto send starts when the camera is turned on.
- Select [**OK**], then press the <  > button.

9. Complete the settings.



- Press the button.

 **Note**

- The [> icon changes to [>].

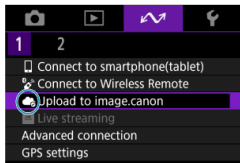

- The camera model name is registered at image.canon.

[Upload to image.canon] screen

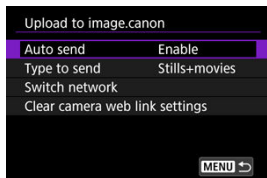

- **Auto send**
Change the auto send settings.
- **Type to send**
Select the type of images uploaded.
- **Switch network**
Change the settings for Wi-Fi connections.
- **Clear camera web link settings**
Clear the camera web link settings.

Live Streaming

 [Pairing with a Smartphone via Bluetooth](#)

 [Connecting to an Access Point via Wi-Fi](#)

You can live-stream images from the camera.

Check the streaming requirements and terms of service in advance on the streaming site.

Pairing with a Smartphone via Bluetooth

Go to step 11 if the smartphone and camera are already paired.

1. Prepare the smartphone .
2. Select : Connect to smartphone(tablet).

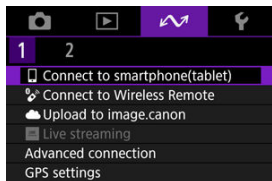

3. Select [OK].



- This screen is not displayed if the Wi-Fi setting is already set to [Enable].

4. Select [Add a device to connect to].

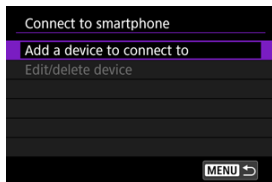

5. Select [OK].

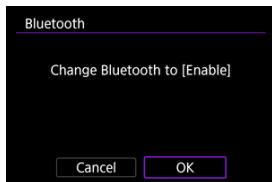

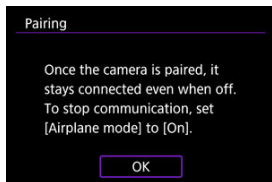

- This screen is not displayed if the Bluetooth setting is already set to [Enable].

6. Press the <  > button.



7. Start pairing.



- Press the <  > button to start pairing.
- If Camera Connect is not installed, use the smartphone to scan the QR code on the screen, go to Google Play or App Store to install Camera Connect, then press the <  > button to start pairing.

8. Start Camera Connect.

- Following the instructions in the app, select the camera for pairing.

9. Establish a Bluetooth connection.



- Press the <  > button.



- When a message appears on the smartphone, use the smartphone as indicated.

10. Complete the pairing process.



- Press the <  > button to finish pairing.

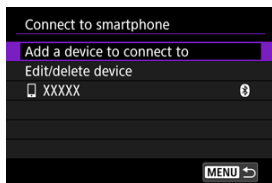

- The name of the connected device is displayed.
- Press the < MENU > button.

11. Select [Live streaming].

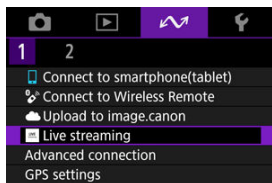

Connecting to an Access Point via Wi-Fi

- The camera automatically reconnects to access points used previously.
- These instructions are for connecting via WPS (PBC mode). To connect a different way, see Basic Communication Settings (🔗).

1. Select [Connect with WPS].

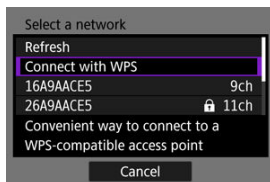

2. Select [WPS (PBC mode)].

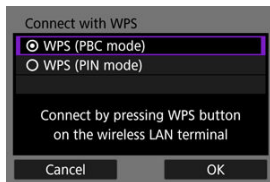

- Select [OK].

3. Connect to the access point.

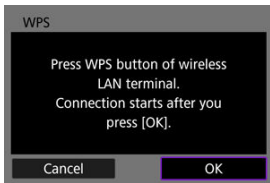

- Press the access point's WPS button. For details on where the button is and how long to press it, refer to the access point user manual.
- Select **[OK]** to initiate connection with the access point.
- The following screen is displayed once the camera is connected to the access point.

4. Select [Auto setting].

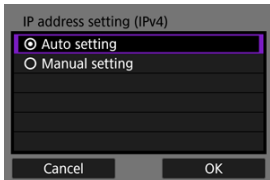

- Select **[OK]**.
- If an error is displayed for **[Auto setting]**, set the IP address manually (🔗).

5. Complete the streaming settings in Camera Connect.

- Select the streaming platform you will use, then configure the settings accordingly.
- You can enter a URL on the screen to select a streaming site.
- As the streaming quality, select 6 Mbps or 3.5 Mbps, depending on the communication environment.

6. Start streaming.

- [STBY] is shown on the recording standby screen.
- Use Camera Connect to start and stop streaming. You can also stop streaming by pressing the Start/Stop button on the camera.

Caution

- Video and audio may be noisy during streaming, depending on the communication environment. Test streaming in advance and check the video and audio quality.
- Try the following if video and audio is noisy or skips. These steps may improve the quality.
 - Bring the camera and access point (wireless router, tethering smartphone, etc.) closer together, change their relative positions, and keep the space between them free of people and objects.
 - Indoors, set up the access point and camera in the same room.
 - Set up away from devices that use the 2.4 GHz band, such as microwave ovens or cordless phones.
- If noise from an external microphone is distracting, try placing the microphone on the side of the camera with the external microphone IN terminal as far from the camera as possible.
- Although selecting 3.5 Mbps as the streaming quality in Camera Connect may enable more stable streaming than with 6 Mbps, image quality will be lower.
- The camera will become warmer during streaming. Use the stand or a tripod, or take other measures to avoid handheld recording. Once the camera becomes hot,  appears on the screen as a warning.
- Note that Canon is in no way responsible for third-party services.
- No image is recorded to the card during streaming (but a card must be in the camera).
- Test streaming in advance to make sure the image is straight and in the correct orientation, and adjust the orientation as needed.
- Be sure to read [Wireless Communication Precautions](#).

Advanced Connections

[Connecting to a Smartphone or Tablet](#)

Connecting to a Smartphone or Tablet

You can establish a direct Wi-Fi connection with a smartphone and use Camera Connect to control the camera.

1. Select []: **Advanced connection**].

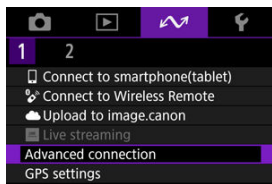

2. Select [**OK**].



- This screen is not displayed if the Wi-Fi setting is already set to **[Enable]**.

3. Select [Connect to smartphone(tablet)].

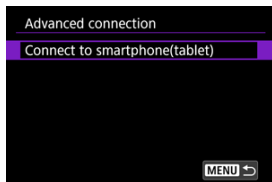

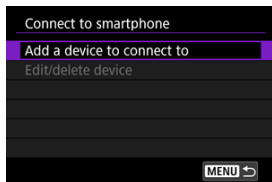

4. Select [Add a device to connect to].



5. Start searching for access points.



- Press the <  > button to start searching.
- If Camera Connect is not installed, use the smartphone to scan the QR code on the screen, go to Google Play or App Store to install Camera Connect, then press the <  > button to start searching.

6. Establish a Wi-Fi connection.

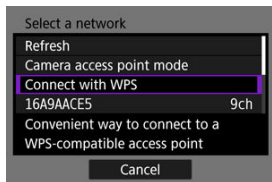

- Connect to an access point via Wi-Fi. Follow the instructions for the connection method used.
 - Connecting via WPS (🔗, 🔗)
 - Connecting manually to detected networks (🔗)
 - Connecting manually by specifying access point information (🔗)

7. Start Camera Connect and tap the camera name.

8. Select [OK].

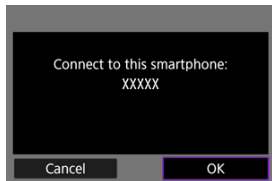

- [📶Wi-Fi on] is displayed on the camera screen (🔗).

GPS Settings

[GPS via Mobile](#)

[GPS Information Display](#)

GPS via Mobile

You can geotag images with a Bluetooth-compatible smartphone. Complete these settings after installing the dedicated Camera Connect app (📱) on the smartphone.

1. On the smartphone, activate location services.

2. Establish a Bluetooth connection.

- Start Camera Connect and pair the camera and smartphone via Bluetooth.

3. Select [📶: GPS settings].

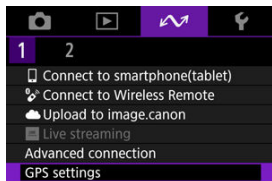

4. Select [GPS via mobile].

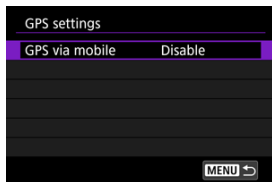

5. Select [Enable].

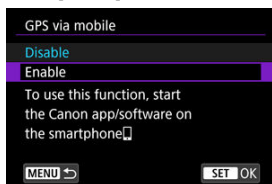

6. Take the picture.

- Images are geotagged with the information from the smartphone.

GPS Information Display

You can check the location information added to your shots on the shooting information screen (📷).



- (1) Latitude
- (2) Longitude
- (3) Elevation
- (4) UTC (Coordinated Universal Time)

⚠ Caution

- Location information is acquired from the smartphone only while the camera is paired with it via Bluetooth.
- Direction information is not acquired.
- Acquired location information may not be accurate, depending on traveling conditions or smartphone status.
- It may take some time to acquire location information from the smartphone after you turn the camera on.
- Location information is no longer acquired after any of the following operations.
 - Pairing with a wireless remote control via Bluetooth
 - Turning the camera off
 - Quitting Camera Connect
 - Deactivating location services on the smartphone
- Location information is no longer acquired in any of the following situations.
 - The camera power turns off
 - The Bluetooth connection is ended
 - The smartphone's remaining battery level is low

**Note**

- Coordinated Universal Time, abbreviated as UTC, is essentially the same as Greenwich Mean Time.
- For movies, the GPS information initially acquired is added.

Basic Communication Settings

- [Checking the Type of Access Point](#)
- [Connecting via WPS \(PBC Mode\)](#)
- [Connecting via WPS \(PIN Mode\)](#)
- [Connecting Manually to Detected Networks](#)
- [Connecting Manually by Specifying Networks](#)
- [Connecting in Camera Access Point Mode](#)
- [Setting the IP Address](#)

Checking the Type of Access Point



When connecting via an access point, check whether the access point supports WPS*, which simplifies connections between Wi-Fi devices.

If you are unsure about WPS compatibility, refer to the access point user manual or other documentation.



* Stands for Wi-Fi Protected Setup.

● When WPS is supported

Two connection methods are available, as follows. You can connect more easily via WPS in PBC mode.

- Connecting via WPS (PBC mode) 
- Connecting via WPS (PIN mode) 

● When WPS is not supported

- Connecting manually to detected networks 
- Connecting manually by specifying networks 

Access point encryption

The camera supports the following options for **[Authentication]** and **[Encryption settings]**. For this reason, the encryption used by the access point must be set to one of the following when you will connect to detected networks manually.

- **[Authentication]**: Open system, shared key, or WPA/WPA2/WPA3-Personal
- **[Encryption settings]**: WEP, TKIP, or AES

Caution

- **Connections may not be possible when access point stealth functions are enabled. Deactivate stealth functions.**
- Ask any network administrator in charge of networks you will join for setting details.

Note

- If MAC address filtering is used on networks you will join, add the camera's MAC address to the access point. The MAC address can be checked on the **[MAC address]** screen .

Connecting via WPS (PBC Mode)

Instructions in this section are continued from [Checking the Type of Access Point](#).

This is a connection method used with access points compatible with WPS. In pushbutton connection mode (PBC mode), the camera and access point can be connected simply by pressing the WPS button on the access point.

- Connecting may be more difficult if multiple access points are active nearby. If so, try to connect with **[WPS (PIN mode)]**.
- Check the position of the WPS button on the access point in advance.
- It may take approx. 1 min. to establish a connection.

1. Select **[Connect with WPS]** on the **[Select a network]** screen.

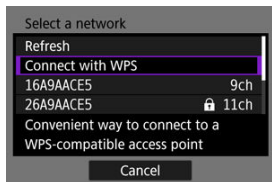

2. Select **[WPS (PBC mode)]**.

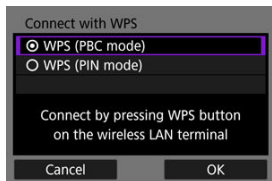

- Select **[OK]**.

3. Connect to the access point.

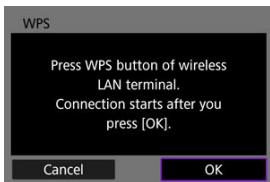

- Press the access point's WPS button. For details on where the button is and how long to press it, refer to the access point user manual.
- Select **[OK]** to initiate connection with the access point.
- The following screen is displayed once the camera is connected to the access point.

4. Set the IP address.

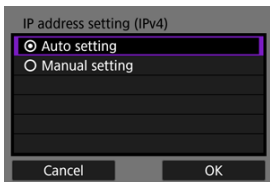

- Go to [Setting the IP Address](#).

Connecting via WPS (PIN Mode)

Instructions in this section are continued from [Checking the Type of Access Point](#).

This is a connection method used with access points compatible with WPS. In PIN code connection mode (PIN mode), an 8-digit identification number indicated on the camera is entered on the access point to establish a connection.

- Even if multiple access points are active nearby, connecting by using this shared identification number is relatively reliable.
- It may take approx. 1 min. to establish a connection.

1. Select [Connect with WPS] on the [Select a network] screen.

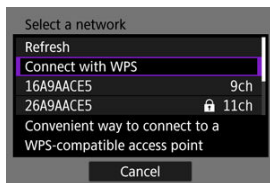

2. Select [WPS (PIN mode)].

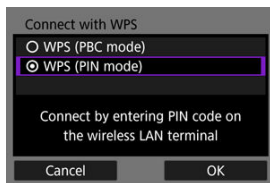

- Select [OK].

3. Enter the PIN code.

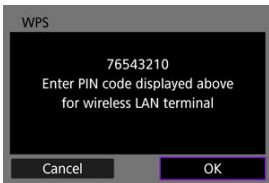

- On the access point, enter the 8-digit PIN code displayed on the camera screen.
- For instructions on entering PIN codes on the access point, refer to the access point's Instruction Manual.
- After entering the PIN code, select **[OK]** on the camera.

4. Connect to the access point.

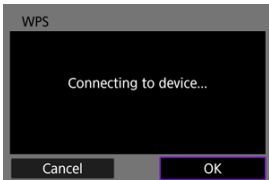

- Select **[OK]** to initiate connection with the access point.
- The following screen is displayed once the camera is connected to the access point.

5. Set the IP address.

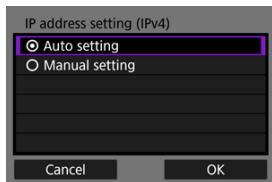

- Go to [Setting the IP Address](#).

Connecting Manually to Detected Networks

Instructions in this section are continued from [Checking the Type of Access Point](#). Connect to an access point by selecting its SSID (or ESS-ID) in a list of active access points nearby.

Selecting the access point

1. Select an access point on the [Select a network] screen.

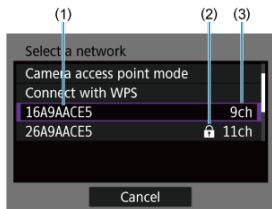

(1) SSID

(2) Security icon (only for encrypted access points)

(3) Channel used

- Turn the < ⬅ ➡ > dial to select the access point to connect to in the list of access points.

Note

[Refresh]

- To display **[Refresh]**, scroll down the screen in step 1.
- Select **[Refresh]** to search for access points again.

Entering the access point encryption key

- Enter the encryption key (password) set on the access point. For details on the encryption key that has been set, refer to the access point's user manual.
- The screens displayed in steps 2–3 vary depending on the authentication and encryption set on the access point.
- Go to [Setting the IP Address](#) if the [IP address set.] screen is displayed instead of the screens shown for steps 2–3.

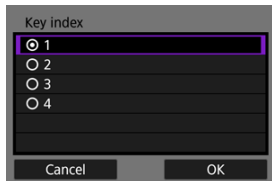

2. Select a key index.

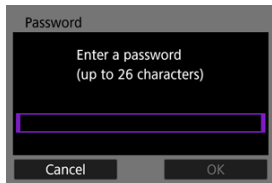

- The [Key index] screen is displayed for WEP-encrypted access points.
- Select the key index number set on the access point.
- Select [OK].

3. Enter the encryption key.



- Press the <  > button to access the virtual keyboard (), then enter the encryption key.
- Select [OK] to initiate connection with the access point.
- The following screen is displayed once the camera is connected to the access point.

4. Set the IP address.

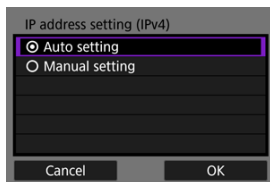

- Go to [Setting the IP Address](#).

Connecting Manually by Specifying Networks

Instructions in this section are continued from [Checking the Type of Access Point](#). Connect to an access point by entering its SSID (or ESS-ID).

Entering the SSID

1. Select **[Manual settings]** on the **[Select a network]** screen.

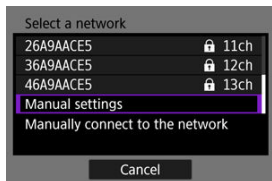

2. Enter the SSID (network name).

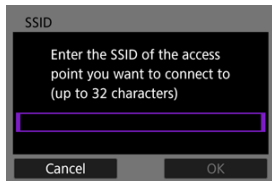

- Press the button to access the virtual keyboard (img alt="Virtual keyboard icon" data-bbox="765 675 785 695"/>), then enter the SSID.
- Select **[OK]**.

3. Select the authentication method.

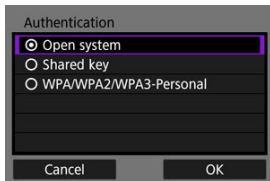

- Select an option and then **[OK]** to go to the next screen.
- On the **[Encryption settings]** screen displayed if **[Open system]** is selected, select **[Disable]** or **[WEP]**.

Entering the access point encryption key

- Enter the encryption key (password) set on the access point. For details on the encryption key that has been set, refer to the access point's user manual.
- The screens displayed in steps 4–5 vary depending on the authentication and encryption set on the access point.
- Go to [Setting the IP Address](#) if the **[IP address set.]** screen is displayed instead of the screens shown for steps 4–5.

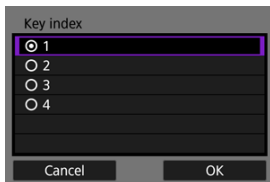

4. Select a key index.

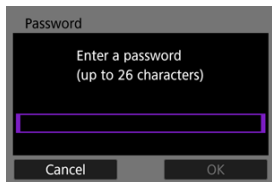

- The **[Key index]** screen is displayed if you have selected **[Shared key]** or **[WEP]** in step 3.
- Select the key index number set on the access point.
- Select **[OK]**.

5. Enter the encryption key.



- Press the <  > button to access the virtual keyboard (), then enter the encryption key.
- Select [**OK**] to initiate connection with the access point.
- The following screen is displayed once the camera is connected to the access point.

6. Set the IP address.

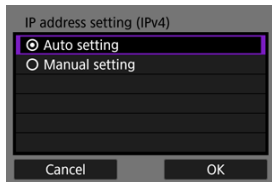

- Go to [Setting the IP Address](#).

Connecting in Camera Access Point Mode

Camera access point mode is a connection method for directly connecting the camera and other devices via Wi-Fi without using an access point. Two connection methods are available, as follows.

Connecting with Easy connection

Network settings for camera access point mode are configured automatically.

- For instructions on using the devices you will connect to, refer to the device instruction manual.

1. Select **[Camera access point mode]** on the **[Select a network]** screen.

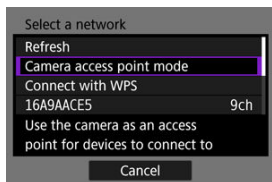

2. Select **[Easy connection]**.

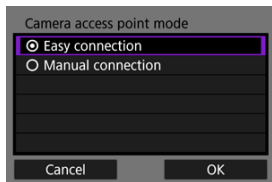

- Select **[OK]**.

3. Use the other device to connect to the camera.

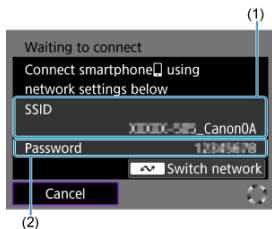

(1) SSID (network name)

(2) Encryption key (password)

- In other device's Wi-Fi settings, select the SSID (network name) shown on the camera screen, then enter the password.

4. Complete the connection settings based on the device to connect to.

Connecting with Manual connection

Network settings for camera access point mode are configured manually. Set **[SSID]**, **[Channel setting]**, and **[Encryption settings]** on each screen displayed.

1. Select **[Manual connection]**.

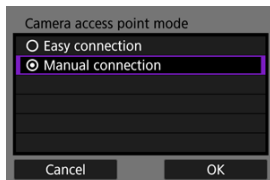

- Select **[OK]**.

2. Enter the SSID (network name).

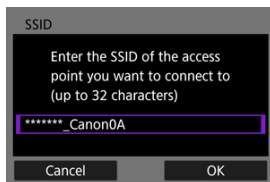

- Press the **< [V] >** button to access the virtual keyboard **[V]**, then enter the SSID. After input, press **< MENU >**.
- Select **[OK]**.

3. Select a channel setting option.

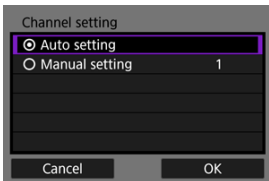

- To specify the settings manually, select [**Manual setting**], then press the <◀> <▶> keys.
- Select [**OK**].

4. Select an encryption setting option.

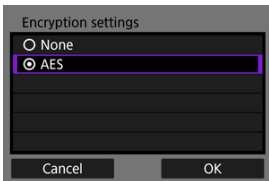

- For encryption, select [**AES**].
- Select [**OK**].
- When [**AES**] is selected, the [**Password**] screen is displayed. Press the <Ⓜ> button to access the virtual keyboard (Ⓜ), then enter the encryption key. After input, press the <MENU> button.

5. Select [Auto setting].

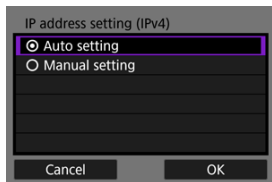

- Select [OK].
- If an error is displayed for [Auto setting], set the IP address manually (🔗).

6. Use the other device to connect to the camera.

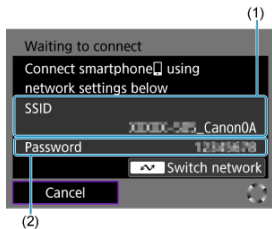

- (1) SSID (network name)
- (2) Encryption key (password)

7. Complete connection settings for the communication function.

Setting the IP Address

Select a method of setting the IP address, and then set the IP address on the camera.

Setting the IP address automatically

Set up the IP address settings automatically.

1. Select **[Auto setting]**.

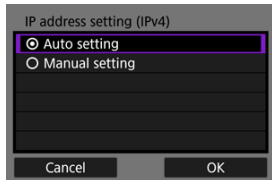

- Select **[OK]**.
- If an error is displayed for **[Auto setting]**, set the IP address manually (☑).

2. Complete the connection settings based on the device to connect to.

Setting the IP address manually

Set up the IP address settings manually. Note that the items displayed vary depending on the communication function.

1. Select [Manual setting].

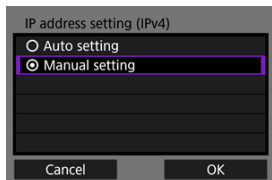

- Select [OK].

2. Select an option to configure.

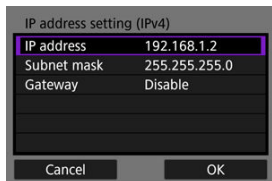

- Select an option to access the screen for numerical input.

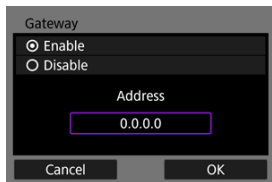

- To use a gateway or DNS address, select [Enable], then select [Address].

3. Enter the number.



- Use <↔> to select an input position in the upper area, then select numbers to enter. Press the <Ⓜ> button to enter the selected number.
- To set the entered numbers and return to the screen for step 2, press the <MENU> button.

4. Select [OK].

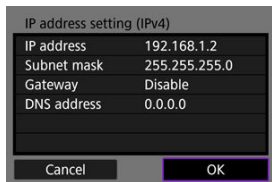

- When you have completed setting the necessary items, select [OK]. The next screen is displayed.
- If you are unsure what to enter, see [Checking Network Settings](#) or ask the network administrator or other person in charge of the network.

5. Complete the connection settings based on the device to connect to.

Reconnecting via Wi-Fi/Bluetooth

The camera keeps a record of past Wi-Fi or Bluetooth connections. You can use this record to reconnect to the same device. Here, [Wi-Fi]: [Connect to smartphone(tablet)] is used as an example.

1. Select the record for the device to connect to.

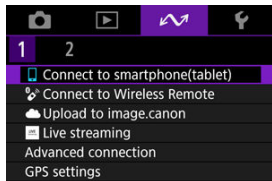

- After the [Wi-Fi on] screen appears, select [Disconnect], then repeat step 1.

2. Select the device for the connection.

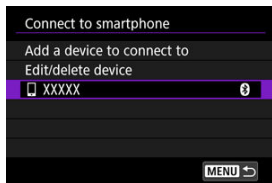

- Select an option to connect to via Wi-Fi or Bluetooth from the past connections listed. If the option is not shown, press the <▲> <▼> keys to switch screens.



Note

- Records for up to 10 connections for all wireless communication functions are retained.

3. Use the connected device as needed.

Editing/Deleting Devices for Connections

[☑ Changing Device Nicknames](#)

[☑ Deleting Connection Information](#)

Before editing or deleting connection settings for other devices, end the Wi-Fi connection. Here, [📶: 📱Connect to smartphone(tablet)] is used as an example.

Changing Device Nicknames

You can change the nickname of devices the camera connects to.

1. Select an item.

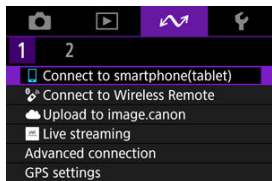

- After the [Wi-Fi on] screen appears, select [Disconnect], then repeat step 1.

2. Select [Edit/delete device].

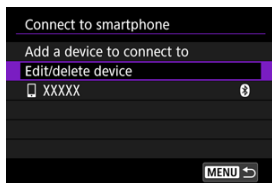

3. Select the device.

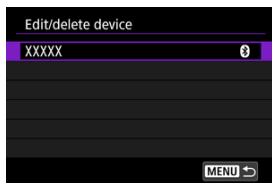

4. Select [Change device nickname].

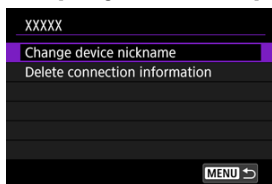

5. Change the nickname.

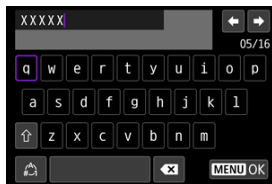

- Use the virtual keyboard (📄) to enter the nickname.

6. Press the <MENU> button, then select [OK].

Deleting Connection Information

1. Access the screen for the connected device.
 - Follow steps 1–3 in [Changing Device Nicknames](#).
 - For [✓]:  **Connect to Wireless Remote**], see [Canceling the Pairing](#).
2. Select [Delete connection information].

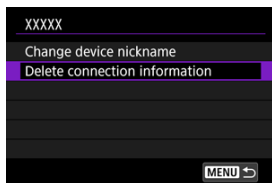

3. Select [OK].



Airplane Mode

You can temporarily disable Wi-Fi and Bluetooth functions.

1. Select [: Airplane mode].

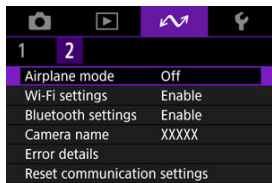

2. Set to [On].

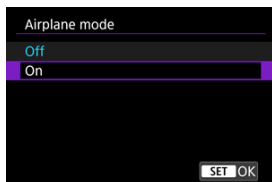

- [] is displayed on the screen.

Note

- [] may not be displayed in still photo shooting, movie recording, or playback, depending on display settings. If it is not displayed, press the <INFO> button repeatedly to access detailed information display.

Wi-Fi Settings

[Checking the MAC Address](#)

1. Select [: Wi-Fi settings].

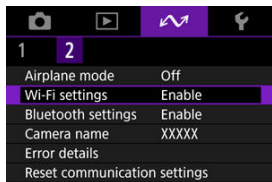

2. Select an option.

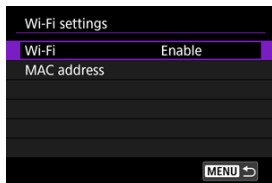

- **Wi-Fi**
When the use of electronic devices and wireless devices is prohibited, such as on board airplanes or in hospitals, set it to **[Disable]**.
- **MAC address**
You can check the MAC address of the camera.

Checking the MAC Address

You can check the camera's MAC address.

1. Select [: Wi-Fi settings].

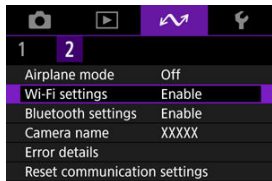

2. Select [MAC address].

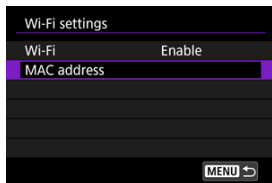

3. Check the MAC address.

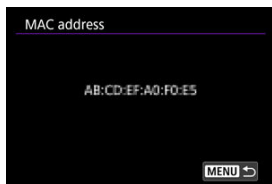

Bluetooth Settings

1. Select [: Bluetooth settings].

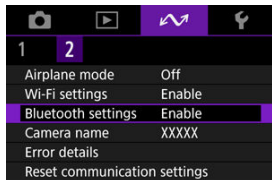

2. Select an option.

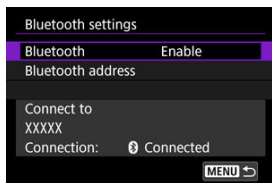

- **Bluetooth**
If you will not use the Bluetooth function, select [**Disable**].
- **Bluetooth address**
You can check the camera's Bluetooth address.
- **Connect to**
You can check the name and communication status of the paired device.

Camera Name

You can change the camera name (displayed on smartphones and other cameras) as needed.

1. Select [**W**: Camera name].

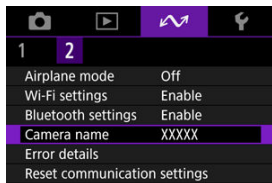

2. Change the camera name.

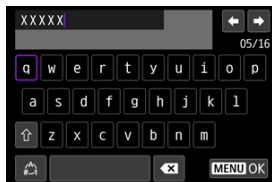

- Use the virtual keyboard () to enter the camera name.

3. Press the <MENU> button, then select [OK].

Error Details

You can display details of errors affecting the camera's wireless communication functions.

1. Select [: Error details].

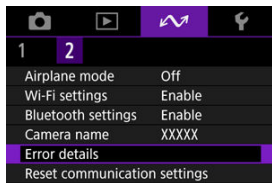

- Details of errors that have occurred are displayed.
- For more information on errors, see [Responding to Error Messages](#).

Resetting Communication Settings

All wireless communication settings can be deleted. By deleting the wireless communication settings, you can prevent their information from being exposed when you lend or give your camera to other people.

1. Select [: Reset communication settings].

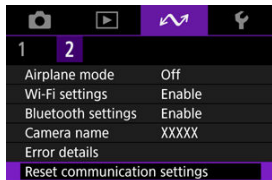

2. Select [OK].



Caution

- If you have paired the camera with a smartphone, on the smartphone's Bluetooth settings screen, delete the connection information of the camera for which you restored default wireless communication settings.

Note

- All wireless communication settings can be cleared by selecting the [**Communication settings**] option for [**Other settings**] in [: **Reset camera**].

Virtual Keyboard Operations

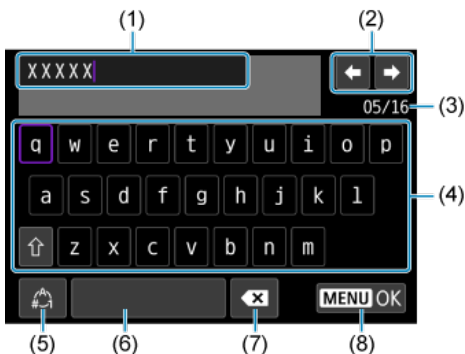

-
- (1) Input area, for entering text
 - (2) Cursor keys, for moving in the input area
 - (3) Current no. of characters/no. available
 - (4) Keyboard
 - (5) Switch input modes
 - (6) Space
 - (7) Delete a character in the input area
 - (8) Exit input
-

- Use < ⬅ ➡ > to move within (2) and (4)–(7).
- Press the < Ⓜ > button to confirm input or when switching input modes.

Responding to Error Messages

When an error occurs, display the details of the error by following one of the procedures below. Then, eliminate the cause of the error by referring to the examples shown in this chapter.

- Select [: **Error details**].
- Select [**Error details**] on the [**Wi-Fi on**] screen.

Click the following error numbers to jump to the corresponding section.

11	12							
21	23							
61	64	65						
91								
121	125	127						
130	131	132	133	134	135	136	137	



Note

- In case of errors, [**Err****] is displayed to the right of [: **Error details**]. It is no longer displayed after the camera is turned off.

11: Connection target not found

- **In the case of [Connect to smartphone(tablet)], is Camera Connect running?**
 - Establish a connection using Camera Connect (🔗).
- **Are the camera and the access point set to use the same encryption key for authentication?**
 - This error occurs if the encryption keys do not match when the authentication method for encryption is **[Open system]**.
Check upper- and lower-case letters, and make sure the correct encryption key for authentication is set on the camera (🔗).

12: Connection target not found

- **Are the other device and access point for the connection turned on?**
 - Turn on the other device and access point, then wait a while. If a connection still cannot be established, perform the procedures to establish the connection again.

21: No address assigned by DHCP server

What to check on the camera

- **On the camera, the IP address is set to [Auto setting]. Is this the correct setting?**
 - If no DHCP server is used, configure the setting after setting the IP address to **[Manual setting]** on the camera (🔗).

What to check on the DHCP server

- **Is the power of the DHCP server on?**
 - Turn on the DHCP server.
- **Are there enough addresses for assignment by the DHCP server?**
 - Increase the number of addresses assigned by the DHCP server.
 - Remove devices assigned addresses by the DHCP server from the network to reduce the number of addresses in use.
- **Is the DHCP server working correctly?**
 - Check the DHCP server settings to make sure it is working correctly as a DHCP server.
 - If applicable, ask your network administrator to ensure the DHCP server is available.

23: Device with same IP address exists on selected network

- **Is another device on the camera network using the same IP address as the camera?**
 - Change the camera's IP address to avoid using the same address as another device on the network. Otherwise, change the IP address of the device that has a duplicate address.
 - If the camera's IP address is set to **[Manual setting]** in network environments using a DHCP server, change the setting to **[Auto setting]** (🔗).

Note

Responding to error messages 21–23

- Also check the following points when responding to errors numbered 21–23.
Are the camera and the access point set to use the same password for authentication?
 - This error occurs if the passwords do not match when the authentication method for encryption is set to **[Open system]**. Check upper- and lower-case letters, and make sure the correct password for authentication is set on the camera (🔗).

61: Selected SSID wireless LAN network not found

- **Are any obstacles blocking the line of sight between the camera and the antenna of the access point?**
 - Move the antenna of the access point to a position clearly visible from the point of view of the camera.

What to check on the camera

- **Does the SSID set on the camera match that of the access point?**
 - Check the SSID at the access point, then set the same SSID on the camera (🔗).

What to check at the access point

- **Is the access point turned on?**
 - Turn on the power of the access point.
- **If filtering by MAC address is active, is the MAC address of the camera in use registered at the access point?**
 - Register the MAC address of the camera used to the access point. The MAC address can be checked on the [MAC address] screen (🔗).

64: Cannot connect to wireless LAN terminal

- **Are the camera and the access point set to use the same encryption method?**
 - The camera supports the following encryption methods: WEP, TKIP, and AES (🔗).
- **If filtering by MAC address is active, is the MAC address of the camera in use registered at the access point?**
 - Register the MAC address of the camera used to the access point. The MAC address can be checked on the [MAC address] screen (🔗).

65: Wireless LAN connection lost

- **Are any obstacles blocking the line of sight between the camera and the antenna of the access point?**
 - Move the antenna of the access point to a position clearly visible from the point of view of the camera.
- **The wireless LAN connection was lost, for some reason, and the connection cannot be restored.**
 - The following are possible reasons: excessive access to the access point from another device, a microwave oven or similar appliance in use nearby (interfering with IEEE 802.11b/g/n (2.4 GHz band)), or influence of rain or high humidity.

91: Other error

- **A problem other than error code number 11 to 83 occurred.**
 - Turn the camera's power switch off and on.

121: Not enough free space on server

- **The target Web server does not have enough free space.**
 - Delete unnecessary images on the Web server, check the free space on the Web server, then try sending the data again.

125: Check the network settings

- **Is the network connected?**
 - Check the connection status of the network.

127: An error has occurred

- **A problem other than error code number 121 to 125 occurred while the camera is connected to the Web service.**
 - Try again to establish the Wi-Fi connection.

130: The server is currently busy Please wait a moment and try again

- **The image.canon site is busy at the moment.**
 - Try accessing image.canon over Wi-Fi again later.

131: Try again

- **An error occurred when connecting to image.canon over Wi-Fi.**
 - Try again to establish the Wi-Fi connection to image.canon.

132: Error detected on server Try again later

- **The image.canon site is currently offline for maintenance.**
 - Try accessing image.canon over Wi-Fi again later.

133: Cannot log in to Web service

- **An error occurred when signing in to image.canon.**
 - Check the image.canon settings.
 - Try accessing image.canon over Wi-Fi again later.

134: Set the correct date and time

- **The date, time, and time zone settings are incorrect.**
 - Check the [📅: **Date/Time/Zone**] settings.

135: Web service settings have been changed

- **The settings for image.canon were changed.**
 - Check the image.canon settings.

136: The QR code shown on the camera was not scanned correctly by the dedicated app. Try camera web link setup again.

- **The QR code was not scanned correctly by the smartphone.**
 - Reconfigure camera web link settings and scan the QR code displayed again on the camera.

137: The QR code shown on the camera has expired. Try camera web link setup again.

- **The QR code displayed has expired.**
 - Reconfigure camera web link settings and scan the QR code displayed again on the camera.

Wireless Communication Precautions

- [Distance Between the Camera and the Smartphone](#)
- [Installation Location of Access Point Antenna](#)
- [Nearby Electronic Devices](#)
- [Precautions for Using Multiple Cameras](#)

If the transmission rate drops, the connection is lost, or other problems occur when using the wireless communication functions, try the following corrective actions.

Distance Between the Camera and the Smartphone

If the camera is too far from the smartphone, a Wi-Fi connection may not be established even when Bluetooth connection is possible. In this case, bring the camera and the smartphone closer together, then establish a Wi-Fi connection.

Installation Location of Access Point Antenna

- When using indoors, install the device in the room where you are using the camera.
- Install the device where people or objects do not come between the device and the camera.

Nearby Electronic Devices

If the Wi-Fi transmission rate drops because of the influence of the following electronic devices, stop using them or move further away from the devices to transmit communication.

- The camera communicates over Wi-Fi via IEEE 802.11b/g/n using radio waves in the 2.4 GHz band. For this reason, the Wi-Fi transmission rate will drop if there are Bluetooth devices, microwave ovens, cordless telephones, microphones, smartphones, other cameras, or similar devices operating on the same frequency band nearby.

Precautions for Using Multiple Cameras

- When connecting multiple cameras to one access point via Wi-Fi, make sure the cameras' IP addresses are different.
- When multiple cameras are connected to one access point via Wi-Fi, the transmission rate drops.
- When there are multiple IEEE 802.11b/g/n (2.4 GHz band) access points, leave a gap of five channels between each Wi-Fi channel to reduce radio wave interference. For example, use channels 1, 6, and 11, channels 2 and 7, or channels 3 and 8.

Security

If security settings have not been properly set, the following problems may occur.

- **Transmission monitoring**
Third parties with malicious intent may monitor wireless LAN transmissions and attempt to acquire the data you are sending.
- **Unauthorized network access**
Third parties with malicious intent may gain unauthorized access to the network you are using to steal, modify, or destroy information. Additionally, you could fall victim to other types of unauthorized access such as impersonation (where someone assumes an identity to gain access to unauthorized information) or springboard attacks (where someone gains unauthorized access to your network as a springboard to cover their tracks when infiltrating other systems).

It is recommended to make use of the systems and functions to thoroughly secure your network, preventing these types of problems from occurring.

Checking Network Settings

Windows

Open the Windows **[Command Prompt]**, then enter `ipconfig/all` and press the <Enter> key. In addition to the IP address assigned to the computer, the subnet mask, gateway, and DNS server information are also displayed.

macOS

In macOS, open the **[Terminal]** application, enter `ifconfig -a`, and press the <Return> key. The IP address assigned to the computer is indicated in the **[enX]** item (X: number) next to **[inet]**, in the format `****.***.***.***`.

For information about the **[Terminal]** application, refer to the macOS help.

To avoid using the same IP address for the computer and other devices on the network, change the rightmost number when configuring the IP address assigned to the camera in the processes described in [Setting the IP address manually](#).

Example: 192.168.1.**10**

Wireless Communication Status

Wireless communication status can be checked on the screen.











Recording standby screen





Information display screen during playback



- (1) Wi-Fi function
- (2) Bluetooth function
- (3) Wireless signal strength

Communication Status		Screen	
		Wi-Fi Function	Wireless Signal Strength
Not connected	Wi-Fi: Disable		Off
	Wi-Fi: Enable		
Connecting			
Connected			
Sending data			
Connection error			

Bluetooth Function Indicator

Bluetooth Function	Connection Status	Screen
Other than [Disable]	Bluetooth connected	
	Bluetooth not connected	
[Disable]	Bluetooth not connected	Not displayed

Set-up

This chapter describes menu settings on the set-up [🔧] tab.

- [Tab Menus: Set-up](#)
- [Folder Settings](#)
- [File Numbering](#)
- [Card Formatting](#)
- [Auto Rotate](#)
- [Adding Orientation Information to Movies](#)
- [Date/Time/Zone](#)
- [Language](#)
- [Video System](#)
- [Beeps](#)
- [Volume](#)
- [Power Saving](#)
- [Screen Brightness](#)
- [HDMI Resolution](#)
- [Communication/Multi-Access Button Function \(in Movie Mode\)](#)
- [App Selection for USB Connections](#)
- [Resetting the Camera](#)
- [Copyright Information](#)
- [Other Information](#)

Tab Menus: Set-up

● Set-up 1

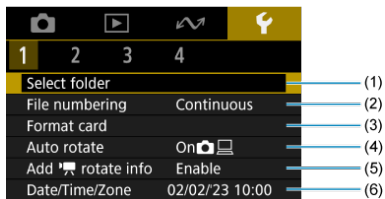

- (1) [Select folder](#)
 - [Creating a Folder](#)
- (2) [File numbering](#)
- (3) [Format card](#)
- (4) [Auto rotate](#)
- (5) [Add rotate info](#)
- (6) [Date/Time/Zone](#)

● Set-up 2

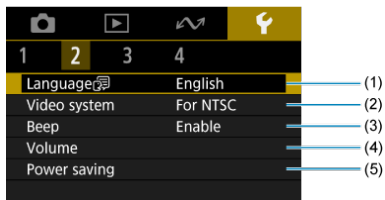

- (1) [Language](#)
- (2) [Video system](#)
- (3) [Beep](#)
- (4) [Volume](#)
- (5) [Power saving](#)

● Set-up 3

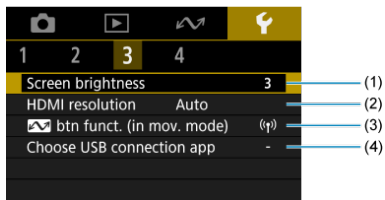

- (1) [Screen brightness](#)
- (2) [HDMI resolution](#)
- (3) [btn funct. \(in mov. mode\)](#)
- (4) [Choose USB connection app](#)

● Set-up 4

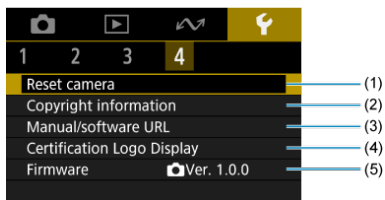

- (1) [Reset camera](#)
- (2) [Copyright information](#)
- (3) [Manual/software URL](#)
- (4) [Certification Logo Display](#)
- (5) [Firmware](#)

Folder Settings

[Creating a Folder](#)

[Selecting a Folder](#)

You can freely create and select the folder where the captured images are to be saved.

Creating a Folder

1. Select [: Select folder].

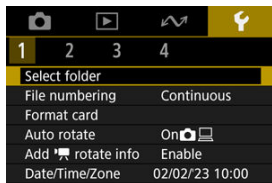

2. Select [Create folder].

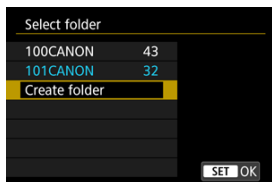

3. Select [OK].

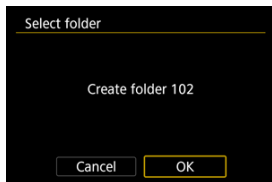

Selecting a Folder

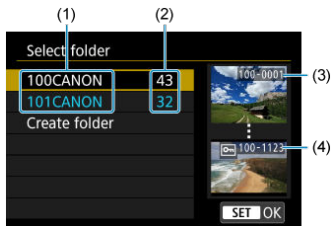

- (1) Folder name
- (2) Number of images in folder
- (3) Lowest file number
- (4) Highest file number

- Select a folder on the folder selection screen.
- Captured images are stored in your selected folder.

Note

Folders

- A folder can contain up to 9999 images (file number 0001–9999). When a folder becomes full, a new folder with the folder number increased by one is created automatically. Also, if manual reset (Ⓢ) is executed, a new folder will be created automatically. Folders numbered from 100 to 999 can be created.

Creating folders with a computer

- With the card open on the screen, create a new folder with "DCIM" as the name. Open the DCIM folder and create as many folders as necessary to save and organize your images. "100ABC_D" is the required format for folder names, and the first three digits must be a folder number in the range 100–999. The last five characters can be any combination of upper- and lower-case letters from A to Z, numerals, and the underscore "_". The space cannot be used. Also note that two folder names cannot share the same three-digit folder number (for example, "100ABC_D" and "100W_XYZ") even if the remaining five characters in each name are different.

File Numbering

[Continuous](#)

[Auto Reset](#)

[Manual Reset](#)

The captured images saved in a folder are assigned a file number from 0001 to 9999. You can change how the image files are numbered.

(Example)
IMG_0001.JPG
|
(1)
(1) File number

1. Select [: File numbering].

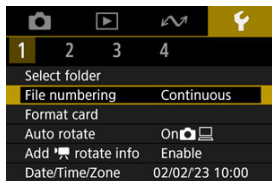

2. Set the item.

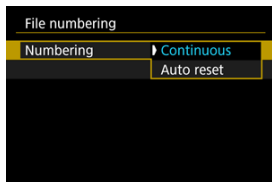

- Select [**Numbering**].
- Select [**Continuous**] or [**Auto reset**].

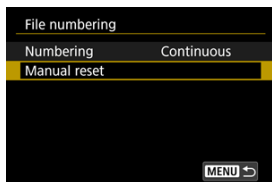

- If you want to reset the file numbering, select [**Manual reset**] (🔗).

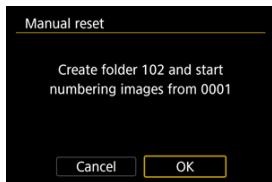

- Select [**OK**] to create a new folder, and the file number will start with 0001.

⚠ Caution

- If the file number in folder 999 reaches 9999, shooting will not be possible even if the card still has free space. After a message requesting you to replace the card is displayed, switch to a new card.

For continuous file numbering regardless of switching cards or creating folders

Even after you replace the card or create a new folder, the file numbering continues in sequence up to 9999. This is useful when you want to save images numbered anywhere between 0001 to 9999 on multiple cards or in multiple folders into one folder on a computer. If the replacement card or existing folder already contains images recorded previously, the file numbering of the new images may continue from the file numbering of the existing images on the card or in the folder. If you want to use continuous file numbering, it is recommended that you use a newly formatted card each time.

File numbering after replacing the card

Card 1

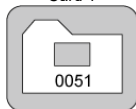

Card 2



(1)

(1) Next sequential file number

File numbering after creating a folder

Card 1

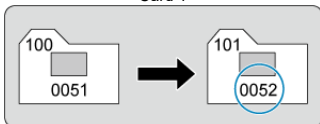

For restarting file numbering from 0001 after switching cards or creating folders

When you replace the card or create a folder, the file numbering restarts from 0001 for the new images saved. This is useful if you want to organize images by cards or folders. If the replacement card or existing folder already contains images recorded previously, the file numbering of the new images may continue from the file numbering of the existing images on the card or in the folder. If you want to save images with the file numbering starting from 0001, use a newly formatted card each time.

File numbering after replacing the card

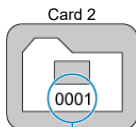
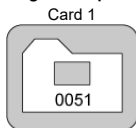

(1)

(1) File numbering is reset

File numbering after creating a folder

Card 1

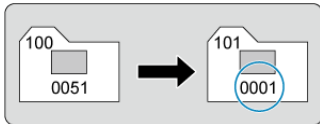

For resetting file numbering to 0001 or starting from 0001 in new folders

When you reset the file numbering manually, a new folder is created automatically and the file numbering of images saved to that folder starts from 0001.

This is useful, for example, if you want to use different folders for the images taken yesterday and the ones taken today.

Card Formatting

Use this camera to format (initialize) the card in the following cases.

- The card is new.
- The card was formatted by a different camera or a computer.
- The card is full of images or data.
- A card-related error is displayed (🔗).

⚠ Caution

- **Formatting a card will erase all data on it. Before formatting, check what is on the card. If necessary, transfer the images and data to a computer, etc. before formatting the card.**

1. Select [🔗: Format card].

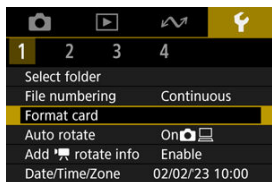

2. Format the card.

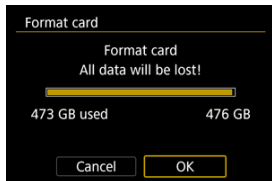

- Select [OK].

Card file formats

microSD cards will be formatted in FAT12/16, microSDHC cards in FAT32, and microSDXC in exFAT.

Caution

- It may not be possible to use microSDXC cards formatted with this camera in other cameras. Also note that exFAT-formatted cards may not be recognized by some computer operating systems or card readers.
- Formatting or erasing data on a card does not completely erase the data. Be aware of this when selling or discarding the card. When disposing of cards, take steps to protect personal information if necessary, as by physically destroying cards.

Note

- The card capacity displayed on the card format screen may be smaller than the capacity indicated on the card.
- This device incorporates exFAT technology licensed from Microsoft.

Auto Rotate

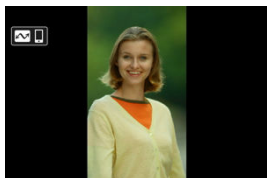

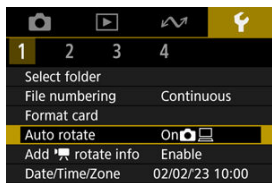

You can change the auto rotation setting that straightens images shot in vertical orientation when they are displayed.

1. Select [: Auto rotate].

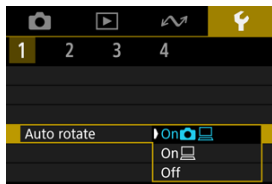

2. Select an option.



- **On** 
Automatically rotates images for display on both the camera and computers.
- **On** 
Automatically rotates images only for display on computers.
- **Off**
Images are not automatically rotated.

Caution

- Images captured with auto rotation set to **[Off]** will not rotate during playback even if you later set auto rotation to **[On]**.

Note

- If a picture is taken while the camera is aimed up or down, automatic rotation to the proper orientation for viewing may not be performed correctly.

Adding Orientation Information to Movies

For movies recorded with the camera held vertically, orientation information indicating which side is up can be added automatically to enable playback in the same orientation on smartphones or other devices.

1. Select [: Add  rotate info].

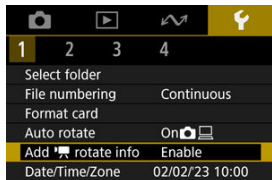

2. Select an option.

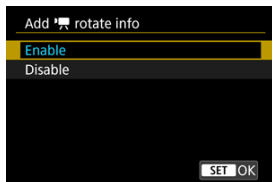

- **Enable**
Play movies on smartphones or other devices in the orientation in which they were recorded.
- **Disable**
Play movies horizontally on smartphones or other devices, regardless of the recording orientation.

Caution

- Movies are played horizontally on the camera and via HDMI video output, regardless of this setting.

Date/Time/Zone

When you turn on the power for the first time or if the date/time/zone have been reset, follow these steps to set the time zone first.

By setting the time zone first, you can simply adjust this setting as needed in the future and the date/time will be updated to match it.

Since the captured images will be appended with the shooting date and time information, be sure to set your date/time.

1. Select [: Date/Time/Zone].

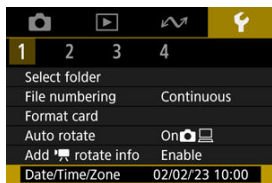

2. Set the time zone.

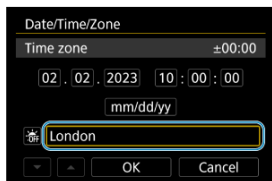

- Press <  > to select [Time zone].

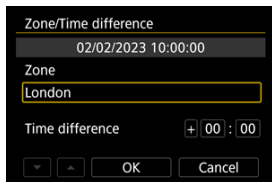

- Press the <  > button.

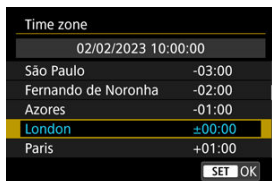

- Select the time zone.
- If your time zone is not listed, press the <MENU> button, then set the difference from UTC in [Time difference].

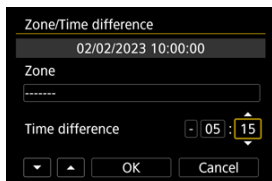

- Select a [Time difference] option (+-/hour/minute), then press the <SET> button.
- After setting the item, press the <MENU> button.
- After entering the time zone or time difference, select [OK].

3. Set the date and time.

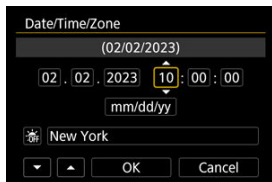

- Select an item, then press the <MENU> button.
- After setting the item, press the <SET> button.

4. Set daylight saving time.

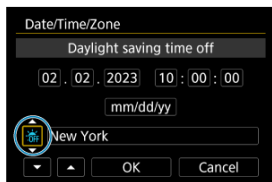

- Set it as necessary.
- Select [☀️] or [🌑], then press the <⏪> button.
- When the daylight saving time is set to [☀️], the time set in step 3 will advance by 1 hour. If [🌑] is set, the daylight saving time will be canceled and the time will go back by 1 hour.

5. Exit the setting.

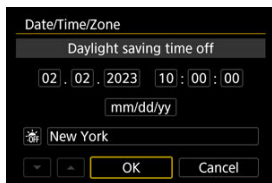

- Select [OK].

⚠️ Caution

- Date, time, and time zone settings may be reset when the battery is depleted, or if the camera is exposed to freezing temperatures for an extended period. If this happens, set them once again.
- After changing [Zone/Time difference], check that the correct date/time are set.

📌 Note

- Auto power off time may be extended while the [👉: Date/Time/Zone] screen is displayed.

Language

1. Select [: Language ].

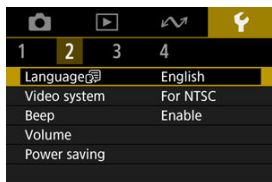

- To set it initially, select [: Language ].

2. Set the desired language.



Video System

Set the video system of any television used for display. This setting determines the frame rates available when you record movies.

1. Select [: Video system].

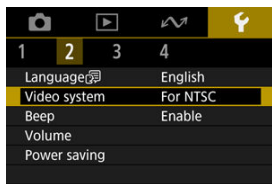

2. Select an option.

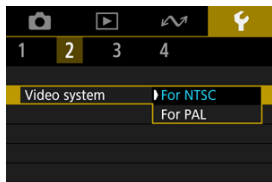

- **For NTSC**
For areas using the NTSC TV system, such as North America, Japan, South Korea, and Mexico.
- **For PAL**
For areas using the PAL TV system, such as Europe, Russia, China, and Australia.

1. Select [: Beep].

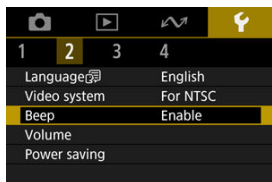

2. Select an option.

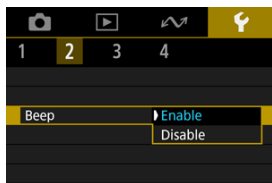

- **Enable**
The camera beeps after focusing and in response to touch operations.
- **Disable**
Disables beeping for focusing, self-timer, shutter, and touch operations.

Note

- By default, beeping volume for touch operations is set to [0] ().

Volume

The volume of camera sounds is adjustable.

1. Select [: Volume].

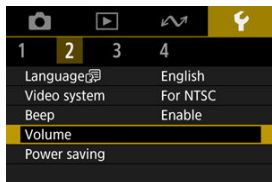

2. Set the option.

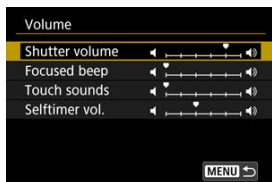

- Select an option, then press the <◀▶> keys to adjust the volume.

Power Saving

You can adjust the timing of when the screen turns off and when the camera turns off after the camera is left idle (Screen off and Auto power off).

1. Select [: Power saving].

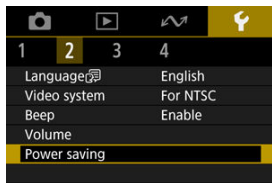

2. Select an option.

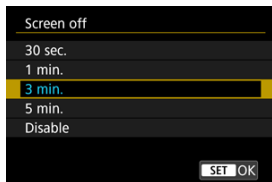
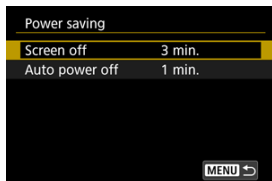



Note

- **[Screen off]** applies while the shooting screen is displayed. These settings do not apply during menu display or image playback.
- The camera turns off during menu display or image playback after the time set in **[Screen off]** and **[Auto power off]** elapses.
- To protect the screen, the screen turns off 30 min. after it is dimmed (although the camera itself remains on), even if **[Screen off]** and **[Auto power off]** are set to **[Disable]**.
- Power saving settings do not apply during shooting, or when connected via USB or wirelessly.

Screen Brightness

1. Select [: Screen brightness].

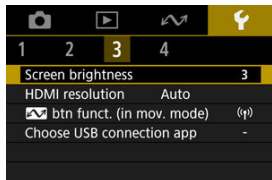

2. Make the adjustment.

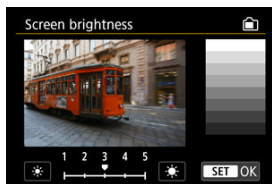

- Referring to the gray image, press the <◀> <▶> keys to adjust brightness, then press the <Ⓜ> button. Check the effect on the screen.

Note

- To check the image's exposure, referring to the histogram is recommended ()

HDMI Resolution

Set the image output resolution used when the camera is connected to a television or external recording device with an HDMI cable.

1. Select [: HDMI resolution].

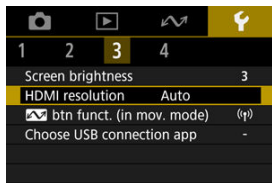



2. Select an option.



- **Auto**
The images will automatically be displayed at the optimum resolution matching the connected television.
- **1080p**
Output at 1080p resolution. Select if you prefer to avoid display or delay issues when the camera switches resolution.

Communication/Multi-Access Button Function (in Movie Mode)

The <  > button can be assigned to frequently used Movie mode functions.

1. Select [:  btn funct. (in mov. mode)].

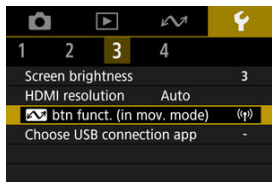

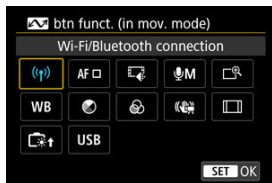

2. Select a function to assign.



- Press the <  > button to set it.

Note

- To clear the function you have assigned, select [ btn funct. (in mov. mode)] from [Other settings] in [: Reset camera].
- You can also change the setting by pressing and holding the <  > button on the movie recording screen.

App Selection for USB Connections

By connecting the camera to a smartphone or computer with the interface cable, you can transfer images or import images to the smartphone or computer.

1. Select [: Choose USB connection app].

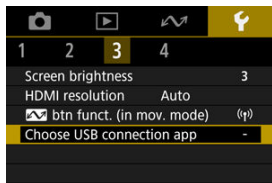

2. Select an option.

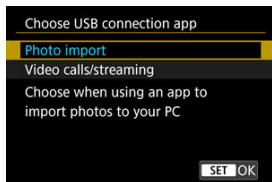

- **Photo import**
Select when importing images to a computer.
- **Video calls/streaming**
Select if you will use UVC/UAC-compatible applications after connecting to a computer.
After selecting [**Video calls/streaming**], use the interface cable to connect to the computer, then start the application.
The resolution and frame rate of image output is 2K (1920×1080) at 30 fps.

Resetting the Camera

The camera's settings for shooting functions and menu functions can be restored to their defaults.

1. Select [: Reset camera].

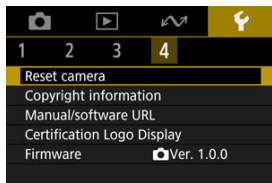

2. Select an option.

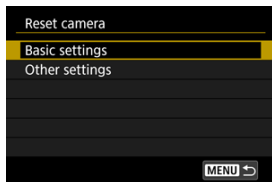

- **Basic settings**
Restores default settings for camera shooting functions and menu settings.
 - **Other settings**
Settings for individual selected options can be reset.
3. Clear the settings.
 - Select [**OK**] on the confirmation screen.

Copyright Information

[Checking the Copyright Information](#)

[Deleting the Copyright Information](#)

When you set the copyright information, it will be recorded to the image as Exif information.

⚠ Caution

- If the entry for "Author" or "Copyright" is long, it may not be displayed entirely when you select **[Display copyright info.]**.

1. Select [: Copyright information].

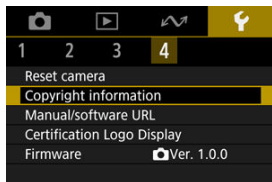

2. Select an option.



3. Enter text.

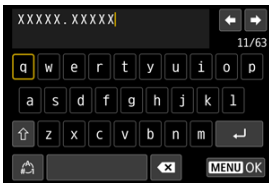

- Use the <↩> dial to select a character, then press the <Ⓜ> button to enter it.
- By selecting [🏠], you can change the input mode.
- Select [✖] to delete a character.

4. Exit the setting.

- Press the <MENU> button, then press [OK].

Checking the Copyright Information

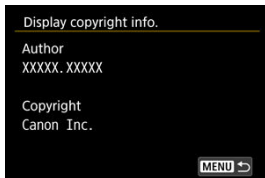

When you select [**Display copyright info.**] in step 2, you can check the [**Author**] and [**Copyright**] information that you entered.

Deleting the Copyright Information

When you select **[Delete copyright information]** in step 2, you can delete the **[Author]** and **[Copyright]** information.

Other Information

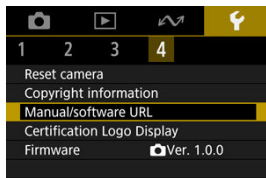

- **Manual/software URL**

To download instruction manuals, select [**Wrench icon**: **Manual/software URL**] and scan the displayed QR code with a smartphone. You can also use a computer to access the website at the URL displayed and download software.

- **Certification Logo Display**

Select [**Wrench icon**: **Certification Logo Display**] to display some of the logos of the camera's certifications. Other certification logos can be found on the camera body and packaging.

- **Firmware**







Select [**Wrench icon**: **Firmware**] to update the camera firmware.

Reference

This chapter provides reference information on camera features.

- [Troubleshooting Guide](#)
- [Error Codes](#)
- [Information Display](#)
- [Specifications](#)
- [Before Disposal](#)

Troubleshooting Guide

-  [Power-related problems](#)
-  [Shooting-related problems](#)
-  [Problems with wireless features](#)
-  [Operation problems](#)
-  [Display problems](#)
-  [Playback problems](#)

If a problem occurs with the camera, first refer to this Troubleshooting Guide. If this Troubleshooting Guide does not resolve the problem, contact your dealer or nearest Canon Service Center.

Power-related problems

Cannot charge the camera.

- In case of charging issues, see [Charging the Camera](#).
- If charging does not begin, an internal error may have occurred. Force the camera off by holding down the < MENU > and < ⏻ > buttons together for 8 sec. Wait a while before restarting the camera by pressing the < ⏻ > button.

The camera is not activated even when turned on.

- Charge the camera ().

The indicator lamp is still lit or blinking when the camera is off.

- The indicator lamp will remain on or continue to blink for a few seconds if the camera is turned off while an image is being recorded to the card. When the image recording is complete, the power will turn off automatically.

Battery life does not last long.

- Using the camera when it is fully charged is recommended ().
- The following operations reduce battery life and the number of shots available.
 - Recording movies over an extended period
 - Using the wireless communication functions

The camera turns off by itself.

- A power-saving feature is enabled (🔒).

Shooting-related problems

No images can be shot or recorded.

- Make sure the card is properly inserted (🔗).
- If the card is full, replace the card or delete unnecessary images to make space (🔗, 🔗).

The card cannot be used.

- If a card error message is displayed, see [Inserting/Removing Cards](#) and [Error Codes](#).

The image is out of focus or blurred.

- Press the Start/Stop button gently to prevent camera shake (🔗).

Subjects look distorted during recording.

- If you move the camera from left to right (panning) or shoot a moving subject during recording, the image may look distorted.

A white or red icon is displayed during movie recording.

- Indicates that the camera's internal temperature is high. For details, see the information on warning indicator display in movie recording (🔗).

During movie recording, the red icon is displayed.

- It indicates that the camera's internal temperature is high. Display of the red  icon indicates that movie recording will soon stop automatically.

Movie recording stops by itself.

- If the card's writing speed is slow, movie recording may stop automatically. For details on cards that can record movies, see [Cards That Can Record Movies](#). To find out the card's writing speed, refer to the card manufacturer's website, etc.
- Format the card if the writing or reading speed seems slow (🔗).
- Movie recording stops automatically at 1 hr.

The image flickers or horizontal stripes appear during movie recording.

- Flickering, horizontal stripes (noise), or irregular exposures can be caused by fluorescent lighting, LED lighting, or other light sources during movie recording. Also, changes in the exposure (brightness) or color tone may be recorded.

I cannot take still photos during movie recording.

- Still photos cannot be taken during movie recording. Stop movie recording before shooting still photos.

Cannot pair with a smartphone.

- Use a smartphone compliant with Bluetooth Specification Version 4.2 or later.
- Turn on Bluetooth from the smartphone settings screen.
- Note that pairing with the camera is not possible from the smartphone's Bluetooth settings screen. Install the dedicated app Camera Connect (free of charge) on the smartphone (📄).
- Pairing with a previously paired smartphone is not possible if pairing information registered for another camera remains on the smartphone. In this case, remove the camera's registration retained in the Bluetooth settings on the smartphone and try pairing again (📄).

Operations such as shooting and playback are not possible.

- With a Wi-Fi connection established, operations such as shooting and playback may not be possible. Terminate the Wi-Fi connection, then perform the operation.

Cannot reconnect to a smartphone.

- Reconnecting may not be possible, even with the same camera and smartphone, if you have changed the settings or selected other settings. In this case, delete the camera connection settings from the Wi-Fi settings on the smartphone and set up a connection again.
- A connection may not be established if Camera Connect is running when you reconfigure connection settings. In this case, quit Camera Connect for a moment and then restart it.

Operation problems

Camera operation is erratic. The buttons are unresponsive.

- An internal error may have occurred. Force the camera off by holding down the < MENU > and < ⏻ > buttons together for 8 sec. Wait a while before restarting the camera by pressing the < ⏻ > button.

Display problems

The shooting date and time displayed are incorrect.

- Make sure the correct date and time are set (📅).
- Check the time zone and daylight saving time (🌞).

Playback problems

Still photos and movies cannot be played back.

- The camera may not be able to play back images taken with another camera.
- Movies edited with a computer cannot be played back with the camera.

Mechanical sounds or sounds of camera operations can be heard during movie playback.

- If you perform camera operations during movie recording, the camera's built-in microphone may also record sounds of the camera operations.

The movie appears to freeze momentarily.

- Significant changes in exposure during movie recording may cause recording to stop momentarily until the brightness stabilizes.

Error Codes

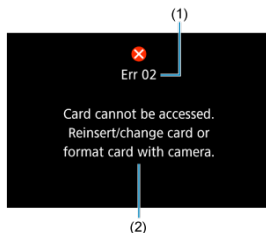

(1) Error number

(2) Cause and countermeasures

If there is a problem with the camera, an error message will appear. Follow the on-screen instructions.

If the problem persists, write down the error code (Err xx) and request service.

Information Display

- [Movie Recording Screen](#)
- [Still Photo Shooting Screen](#)
- [Playback Screen](#)

Movie Recording Screen

Each time you press the <INFO> button, the information display will change.

- The display will show only the settings currently applied.

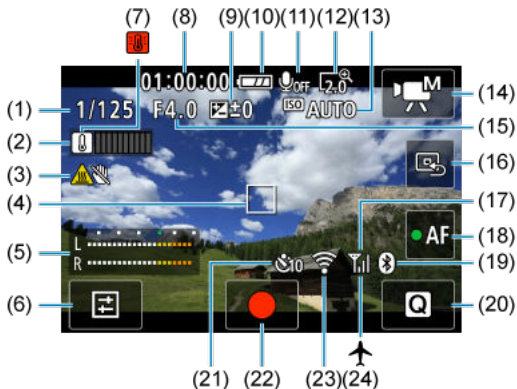

- (1) Shutter speed
- (2) Temperature increase
- (3) High temperature warning
- (4) AF point
- (5) Audio recording level indicator
- (6) Shutter speed/Aperture value/Exposure compensation amount/ISO speed
- (7) Overheating warning
- (8) Movie recording time available/Elapsed recording time
- (9) Exposure compensation amount
- (10) Battery level
- (11) Sound recording off
- (12) Digital zoom
- (13) ISO speed
- (14) Shooting mode
- (15) Aperture value
- (16) Set AF point to center
- (17) Wi-Fi signal strength
- (18) Autofocus status
- (19) Bluetooth function
- (20) Quick Control button
- (21) Self-timer
- (22)  Movie shooting button
- (23) Wi-Fi function
- (24) Airplane mode

Caution

- The grid cannot be displayed during movie recording (and if it is currently displayed, recording a movie will clear the display).
- When movie recording starts, the movie recording remaining time will change to the elapsed time.

Note

- Other icons may be displayed temporarily after setting adjustments.
- Flipping out the screen switches the display position of the information shown.

Still Photo Shooting Screen

Each time you press the <INFO> button, the information display will change.

- The display will show only the settings currently applied.



- | | |
|------|-----------------------------------|
| (1) | Available shots |
| (2) | Battery level |
| (3) | Wi-Fi function |
| (4) | Self-timer |
| (5) | Brightness |
| (6) | High temperature warning |
| (7) | Still photo image quality warning |
| (8) | Overheating warning |
| (9) | Shooting mode |
| (10) | Wi-Fi signal strength |
| (11) | Bluetooth function |
| (12) | Quick Control button |
| (13) | Airplane mode |



Note

- Other icons may be displayed temporarily after setting adjustments.
- Flipping out the screen switches the display position of the information shown.

Detailed information display for movies



- | | |
|------|-------------------------------|
| (1) | Movie recording mode |
| (2) | Color tone |
| (3) | White balance |
| (4) | Color filter |
| (5) | Movie recording size |
| (6) | Frame rate |
| (7) | Movie compression method |
| (8) | Movie orientation information |
| (9) | Exposure compensation amount |
| (10) | Digital IS setting |
| (11) | Recording time |

* For simplicity, explanations are omitted for items that are also included in basic/detailed information display for still photos, which are not shown here.

Basic information display for still photos

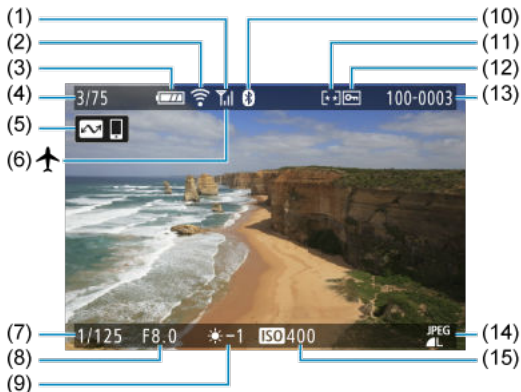

(1) Wi-Fi signal strength

(2) Wi-Fi function

(3) Battery level

(4) Playback number/Total images recorded

(5) Send images to smartphone

(6) Airplane mode

(7) Shutter speed

(8) Aperture value

(9) Brightness

(10) Bluetooth function

(11) Rating

(12) Image protection

(13) Folder no.-File no.

(14) Image quality

(15) ISO speed

 **Caution**

- If the image was taken by another camera, certain shooting information may not be displayed.
- It may not be possible to play back images taken with this camera on other cameras.

Detailed information display for still photos



- | | |
|------|----------------------------|
| (1) | Shutter speed |
| (2) | Shooting mode |
| (3) | Aperture value |
| (4) | Brightness |
| (5) | Shooting date and time |
| (6) | Histogram (Brightness/RGB) |
| (7) | ISO speed |
| (8) | Scroll bar |
| (9) | Image quality |
| (10) | File size |

Specifications

Lens

Focal length	During Movie recording (Full HD, 16:9)	6.6 mm (Approx. 19 mm equivalent, 35mm format equivalent)
	During Still photo shooting	6.6 mm (Approx. 18mm equivalent, 35mm format equivalent)
Angle of view	During Movie recording (Full HD, 16:9)	97.5°
	During Still photo shooting	100.2°
Optical zoom		None
Focusing range		0.05 m / 0.16 ft. to infinity

Image sensor

Type: 1-inch high-sensitivity CMOS sensor (back-illuminated)

Effective pixels* ¹	During Movie recording (Full HD, 16:9)	Approx. 13.1 megapixels
	During Still photo shooting	Approx. 15.2 megapixels
Total pixels* ¹		Approx. 20.9 megapixels

* 1: Rounded to the nearest 100,000.

Recording system

Image recording format: Compliant with Design rule for Camera File system 2.0 and Exif 2.31*1

* 1: Supports time offset information

Image type and extension

Image type		Extension
Still photos	JPEG	.JPG
Movies	IPB (Standard) / IPB (Light)	.MP4





Recording media

microSD, microSDHC, and microSDXC memory cards

UHS-II	Not supported
UHS-I	Supported
UHS speed class	Supported
SD speed class	Supported

Still photo recording

Still photo pixel count

Image size		Resolution (pixels)			
		Aspect ratio			
		3:2	4:3	16:9	1:1
JPEG		Approx. 20.0 megapixels (5472 × 3648)	Approx. 17.7 megapixels (4864 × 3648)	Approx. 16.8 megapixels* ¹ (5472 × 3072)	Approx. 13.3 megapixels (3648 × 3648)
		Approx. 8.9 megapixels (3648 × 2432)	Approx. 7.9 megapixels* ¹ (3248 × 2432)	Approx. 7.5 megapixels* ¹ (3648 × 2048)	Approx. 5.9 megapixels (2432 × 2432)
		Approx. 5.0 megapixels (2736 × 1824)	Approx. 4.4 megapixels (2432 × 1824)	Approx. 4.2 megapixels* ¹ (2736 × 1536)	Approx. 3.3 megapixels (1824 × 1824)
		Approx. 3.8 megapixels (2400 × 1600)	Approx. 3.4 megapixels* ¹ (2112 × 1600)	Approx. 3.2 megapixels* ¹ (2400 × 1344)	2.6 megapixels (1600 × 1600)

* Values for recorded pixels are rounded off to the nearest 100,000th.





* Image quality for L / M / S1: Fixed to Fine.

* HEIF / RAW / C-RAW: Not supported

* Because distortion correction is applied, the camera's effective pixel count may be lower than the image pixel count.

* 1: Aspect ratios are slightly different for these image sizes.

File size/number of shots available

Image quality		File size [Approx. MB]	Available shots [Approx.]* ¹
JPEG		9.6	2880
		4.8	5270
		2.8	7940
		1.9	15630

* 1: Number of shots using a 32 GB card that conforms to Canon testing standards.

* File sizes are determined based on Canon testing standards.

* File size and number of shots available vary by shooting conditions (such as aspect ratio, subject, ISO speed, and Custom Functions).

Movie recording

Movie recording format

Container format	MP4
Compression	H.264 / MPEG-4 AVC
Audio	AAC

Movie recording size overview

Movie recording size	Resolution	Aspect ratio	Frame rate (fps)		Video compression	Audio compression
			NTSC	PAL		
4K UHD	3840×2160	16:9	29.97 23.98	25.00	IPB (Standard) IPB (Light)	AAC
Full HD	1920×1080	16:9	59.94 29.97	50.00 25.00		
			23.98	25.00	IPB (Standard)	

Video system: NTSC / PAL

Movie recording angle of view

Movie recording size	Recording angle of view (approx. %)	
	Horizontal	Vertical
4K UHD	100	84.4
Full HD	100	84.3

* Based on the angle of view of a still photo (JPEG 3:2) (100%).

Estimated recording time, movie bit rate, and file size

Movie recording size			Total recording time (approx.)			Video bit rate (Approx. Mbps)	File size (Approx. MB/min.)
			32 GB	128 GB	512 GB		
4K UHD	29.97 fps 25.00 fps 23.98 fps	IPB (Standard)	35 min.	2 hr. 21 min.	9 hr. 27 min.	120	860
		IPB (Light)	1 hr. 10 min.	4 hr. 43 min.	18 hr. 52 min.	60	431
Full HD	59.94 fps 50.00 fps	IPB (Standard)	1 hr. 10 min.	4 hr. 43 min.	18 hr. 52 min.	60	431
		IPB (Light)	2 hr. 1 min.	8 hr. 4 min.	32 hr. 15 min.	35	252
	29.97 fps 25.00 fps	IPB (Standard)	2 hr. 20 min.	9 hr. 23 min.	37 hr. 35 min.	30	216
		IPB (Light)	5 hr. 47 min.	23 hr. 11 min.	92 hr. 47 min.	12	88
	23.98 fps	IPB (Standard)	2 hr. 20 min.	9 hr. 23 min.	37 hr. 35 min.	30	216

* Bit rate only applies to video output, not audio or metadata.

* Movie recording stops when the maximum recording time per movie is reached.

* No audio is recorded for approx. the last two frames with the compression method for movie recording quality set to IPB (Standard) or IPB (Light). Moreover, the video and sound may be slightly out of sync when movies are played back in Windows.

Maximum file size

Card capacity (format)	Maximum file size
SDXC: exFAT	Unlimited
SDHC: FAT32	4 GB (If exceeded, a new file is created for movie recording.)
SD: FAT16 / FAT12	2 GB

Card performance requirements (movie recording) [write/read speed]

Movie recording size			Card performance requirements
4K UHD	29.97 fps 25.00 fps 23.98 fps	IPB (Standard)	UHS Speed Class 3 or higher
		IPB (Light)	SD Speed Class 10 or higher
Full HD	59.94 fps 50.00 fps	IPB (Standard)	SD Speed Class 10 or higher
		IPB (Light)	SD Speed Class 6 or higher
	29.97 fps 25.00 fps 23.98 fps	IPB (Standard)	SD Speed Class 6 or higher
		IPB (Light)	SD Speed Class 4 or higher

Built-in microphone: Stereo microphones

Auto stopping of movie recording

Maximum recording time per recording

Normal movie and during movie recording other than below	Maximum: Approx. 1 hr.
Smooth skin movie [4K movie recording]	Maximum: Approx. 5 min.

* Longest time available per recording.

* Except when recording stops from overheating or due to the power source used, errors, or other reasons.

Autofocus (AF)

Focusing method: Contrast detection

Focusing operation

	Still photo shooting	Movie recording
AF operation	• One-Shot AF	• Movie Servo AF
AF method	• Face tracking AF	• Face tracking AF • Specified frame AF
AF lock	• Not supported	• Tap to start/stop AF*1
Manual focus (MF)	Not supported	

* 1: Activated by the right cross key during output to a single screen over HDMI.

* AF lock icon is displayed only in the detailed information screen.

Focusing area

Still photo shooting (with face detection): Approx. 100% vertical and horizontal coverage

Movie recording (with face detection): Approx. 100% vertical and horizontal coverage

Number of AF areas for One-Shot AF (still photos): Max. 31 areas (7×5; corners not available)

Screen

Type: TFT color, liquid-crystal monitor

Screen size: 2.0 inch (aspect ratio of 3:2)

Dot count: Approx. 460,000 dots

Touch-screen: Capacitive sensing

Angle adjustment

Tilt: Approx. 180° upward

Reverse display: On / Off

Auto invert display: Automatically inverts images by detecting the camera orientation and whether the screen is open.

Exposure control

Metering mode: 384-zone (24×16) metering using the image sensor

Metering mode: Evaluative metering

Shutter

Still photo shooting

Type: Rolling shutter, using the image sensor

Shutter speed: 1/2000–1/8 sec.

* Up to 1.0 sec. depending on the scene.

Movie recording

Type: Rolling shutter, using the image sensor

Shutter Speed:

1/4000–1/25 sec.

* Varies by movie recording mode and frame rate.

Manual exposure movies: 1/4000–1/8 sec.

External interface

Digital terminal

Terminal type	USB Type-C
Transmission	Equivalent to Hi-Speed USB (USB 2.0)
Applications	<ul style="list-style-type: none">• For computer communication• USB battery charging / camera power supply

HDMI output terminal: HDMI micro OUT terminal (Type D)

* Resolution switches automatically

* HDMI CEC not supported

* Images not displayed unless [For NTSC] or [For PAL] is set correctly for the TV video system

External microphone input terminal: 3.5 mm diameter stereo mini jack

* Stereo Microphone DM-E100 is recommended if plug-in power will be used.

Power source

Battery: Built-in rechargeable lithium-ion battery

* Not user-replaceable.

USB charging time

Battery charger used	Charging time
PD-E1 (at room temperature)	Approx. 1 hr. 50 min.

* To fully recharge a completely depleted battery (unless over-discharged; details conform to Canon testing standards).

* The charging time required and the amount charged vary depending on ambient temperature and remaining capacity.

* Charging is possible in a range of 5–40°C / 41–104°F. For safety, charging takes longer in colder environments (5–10°C / 41–50°F).

Number of shots available: Approx. 290

* At 23°C / 73°F.

* The number of shots available may vary greatly depending on the shooting environment.

Available operating time

Conditions of use			Temperature	Available operating time
Time available for movie recording	4K	• IPB (Standard) • 29.97 fps / 25.00 fps	+23°C / 73°F	Approx. 55 min.
			0°C / 32°F	Approx. 55 min.
	Full HD	• IPB (Standard) • 59.94 fps / 50.00 fps	+23°C / 73°F	Approx. 1 hr. 20 min.
			0°C / 32°F	Approx. 1 hr. 20 min.
Time available for continuous playback (normal playback)	4K	• IPB (Standard) • 29.97 fps / 25.00 fps	+23°C / 73°F	Approx. 2 hr. 40 min.

* With a fully charged new battery

Dimensions and weight

Dimensions

(W) × (H) × (D)	Approx. 63.4 × 90.0 × 34.3mm / Approx. 2.50 × 3.54 × 1.35 in.
-----------------	---

Weight

	Exterior color	Weight
Body (including card)	Black	Approx. 211 g / Approx. 7.44 oz.
	Silver	Approx. 211 g / Approx. 7.44 oz.

Operating environment

Operating temperature: 0–40°C / 32–104°F

Operating humidity: 10%–90%

Wi-Fi (Wireless LAN) communication

Supported standards (equivalent to IEEE 802.11b/g/n standards)

Wi-Fi standards	Transmission method	Maximum link speed
IEEE 802.11b	DSSS modulation	11 Mbps
IEEE 802.11g	OFDM modulation	54 Mbps
IEEE 802.11n		72.2 Mbps

* Not compatible with MIMO (Multiple-input and multiple-output).

Transmission frequency (Center frequency)

Frequency	2412 to 2462 MHz
Channels	1 to 11 ch

Authentication and data encryption methods

Connection method	Authentication	Encryption	
		Encryption	Key format and length
Camera access point	WPA2 / WPA3-Personal	AES	ASCII 8 characters
	Open	Disable	
Infrastructure	Open	WEP	Hexadecimal 10 digits Hexadecimal 26 digits ASCII 5 characters ASCII 13 characters
		Disable	
	Shared key	WEP	Hexadecimal 10 digits Hexadecimal 26 digits ASCII 5 characters ASCII 13 characters
	WPA / WPA2 / WPA3-Personal	TKIP AES	1–127 characters

Bluetooth

Standards compliance: Bluetooth Specification Version 4.2 compliant (Bluetooth Low Energy technology)

Transmission method: GFSK modulation

Before Disposal

⚠ Caution

- DISPOSE OF USED BATTERIES ACCORDING TO LOCAL REGULATIONS.

📄 Note

- A screwdriver for M1.4 Phillips head screws is recommended for screw removal.

1. Turn the camera off.
2. Remove the eight screws.

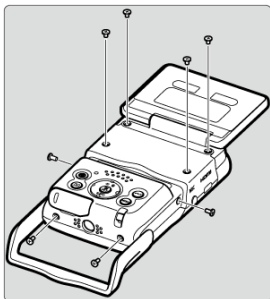

3. Remove the back cover.

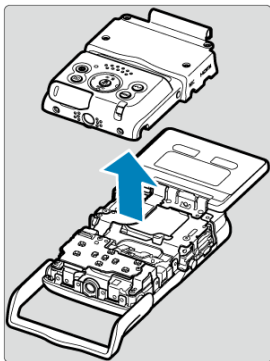

4. Remove the seven screws.

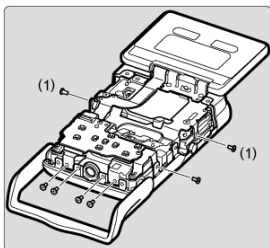

- There is no need to remove the small screws next to screw (1).

5. Remove the front cover as shown, holding it by the side.

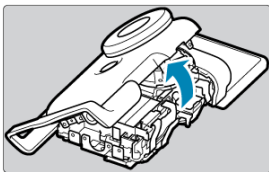

- A tab that holds the cover in place is located near the top of the front cover. The tab may make it difficult to remove the cover, so gradually apply some force as you remove the cover.

6. Remove the battery by hand as shown.

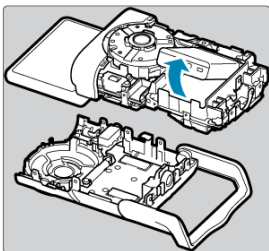

Trademarks and Licensing

[☑ Trademarks](#)

[☑ About MPEG-4 Licensing](#)

[☑ Accessories](#)

Trademarks

- Microsoft and Windows are trademarks or registered trademarks of Microsoft Corporation in the United States and/or other countries.
- App Store and macOS are trademarks of Apple Inc., registered in the U.S. and other countries.
- Google Play and Android are trademarks of Google LLC.
- IOS is a trademark or registered trademark of Cisco in the U.S. and other countries and is used under license.
- QR Code is a trademark of Denso Wave Inc.
- SDXC logo is a trademark of SD-3C, LLC.
- The terms HDMI, HDMI High-Definition Multimedia Interface, HDMI Trade dress and the HDMI Logos are trademarks or registered trademarks of HDMI Licensing Administrator, Inc.
- The Wi-Fi CERTIFIED logo and the Wi-Fi Protected Setup mark are trademarks of the Wi-Fi Alliance.
- The Bluetooth® word mark and logos are registered trademarks owned by Bluetooth SIG, Inc. and any use of such marks by Canon Inc. is under license. Other trademarks and trade names are those of their respective owners.
- USB Type-C™ and USB-C™ are trademarks of USB Implementers Forum.
- All other trademarks are the property of their respective owners.

About MPEG-4 Licensing

"This product is licensed under AT&T patents for the MPEG-4 standard and may be used for encoding MPEG-4 compliant video and/or decoding MPEG-4 compliant video that was encoded only (1) for a personal and non-commercial purpose or (2) by a video provider licensed under the AT&T patents to provide MPEG-4 compliant video. No license is granted or implied for any other use for MPEG-4 standard."

THIS PRODUCT IS LICENSED UNDER THE AVC PATENT PORTFOLIO LICENSE FOR THE PERSONAL USE OF A CONSUMER OR OTHER USES IN WHICH IT DOES NOT RECEIVE REMUNERATION TO (i) ENCODE VIDEO IN COMPLIANCE WITH THE AVC STANDARD ("AVC VIDEO") AND/OR (ii) DECODE AVC VIDEO THAT WAS ENCODED BY A CONSUMER ENGAGED IN A PERSONAL ACTIVITY AND/OR WAS OBTAINED FROM A VIDEO PROVIDER LICENSED TO PROVIDE AVC VIDEO. NO LICENSE IS GRANTED OR SHALL BE IMPLIED FOR ANY OTHER USE. ADDITIONAL INFORMATION MAY BE OBTAINED FROM MPEG LA, L.L.C. SEE [HTTP://WWW.MPEGLA.COM](http://www.mpegla.com)

* Notice displayed in English as required.

Accessories

Use of genuine Canon accessories is recommended

This product is designed to achieve optimum performance when used with genuine Canon accessories. Therefore, using this product with genuine accessories is highly recommended. Canon shall not be liable for any damage to this product and/or accidents such as malfunction, fire, etc. caused by the failure of non-genuine Canon accessories. Please note that repairs arising out of the malfunction of non-genuine accessories will not be covered by the warranty for repairs, although you may request such repairs on a chargeable basis.