

OptiPlex Small Form Factor 7010

Owner's Manual

Notes, cautions, and warnings

 **NOTE:** A NOTE indicates important information that helps you make better use of your product.

 **CAUTION:** A CAUTION indicates either potential damage to hardware or loss of data and tells you how to avoid the problem.

 **WARNING:** A WARNING indicates a potential for property damage, personal injury, or death.

Chapter 1: Views of OptiPlex Small Form Factor 7010	7
Display.....	8
Back.....	10
Chapter 2: Set up your computer	12
Chapter 3: Specifications of OptiPlex Small Form Factor 7010	19
Dimensions and weight.....	19
Processor.....	19
Chipset.....	21
Operating system.....	21
Memory.....	21
Memory matrix.....	22
External ports.....	22
Internal slots.....	23
Ethernet.....	23
Wireless module.....	23
Audio.....	24
Storage.....	24
Power ratings.....	25
Power supply connector.....	26
GPU—Integrated.....	26
Video port resolution (GPU—Integrated).....	26
External display support (GPU—Integrated).....	27
GPU—Discrete.....	27
External display support (GPU—Discrete).....	27
Hardware security.....	28
Environmental.....	28
Regulatory compliance.....	29
Operating and storage environment.....	29
Chapter 4: Working inside your computer	30
Safety instructions.....	30
Before working inside your computer.....	30
Safety precautions.....	31
Electrostatic discharge—ESD protection.....	31
ESD field service kit	32
Transporting sensitive components.....	33
After working inside your computer.....	33
BitLocker.....	33
Recommended tools.....	33
Screw list.....	34
Major components of OptiPlex Small Form Factor 7010.....	35

Chapter 5: Side cover.....	38
Removing the side cover.....	38
Installing the side cover.....	38
Chapter 6: Removing and installing Customer Replaceable Units (CRUs).....	40
Front bezel	40
Removing the front bezel.....	40
Installing the front bezel.....	41
Hard drive.....	42
2.5-inch hard drive.....	42
3.5-inch hard drive.....	46
Disk-drive cage.....	50
Removing the disk-drive cage.....	50
Installing the disk-drive cage.....	52
Optical drive.....	54
Removing the optical drive.....	54
Installing the optical drive.....	55
Memory.....	57
Removing the memory.....	57
Installing the memory.....	58
Solid-state drives.....	59
Solid-state drive (half-length).....	59
Solid-state drive (full-length).....	61
Dell Ultra Speed Drive Gen3 card.....	63
Wireless card.....	68
Removing the wireless card.....	68
Installing the wireless card.....	69
Expansion card.....	70
Removing the graphics card.....	70
Installing the graphics card.....	71
Internal speaker.....	73
Removing the speaker.....	73
Installing the speaker.....	73
Coin-cell battery.....	74
Removing the coin-cell battery.....	74
Installing the coin-cell battery.....	75
Chapter 7: Removing and installing Field Replaceable Units (FRUs).....	77
Power button.....	77
Removing the power button.....	77
Installing the power button.....	78
Intrusion switch.....	79
Removing the intrusion switch.....	79
Installing the Intrusion switch	80
Power-supply unit.....	81
Removing the power-supply unit.....	81
Installing the power-supply unit.....	83
Processor fan and heat-sink assembly.....	85

Removing the processor fan and heat-sink assembly.....	85
Installing the processor fan and heat-sink assembly.....	86
Processor.....	87
Removing the processor fan and heat-sink assembly.....	87
Installing the processor.....	88
Internal antenna kit.....	89
Removing the internal antenna kit.....	89
Installing the internal antenna kit.....	91
SMA Antenna	93
Removing the external SMA antenna kit.....	93
Installing the SMA antenna kit.....	94
Optional Input/Output modules.....	96
Serial module.....	96
VGA module.....	97
DP module.....	99
HDMI module.....	101
System board.....	103
Removing the system board.....	103
Installing the system board.....	107
Chapter 8: Software.....	110
Operating system.....	110
Drivers and downloads.....	110
Chapter 9: BIOS Setup.....	111
Entering BIOS setup program.....	111
Navigation keys.....	111
F12 One Time Boot menu.....	111
System setup options.....	112
Updating the BIOS.....	119
Updating the BIOS in Windows.....	119
Updating the BIOS in Linux and Ubuntu.....	119
Updating the BIOS using the USB drive in Windows.....	119
Updating the BIOS from the F12 One-Time boot menu.....	120
System and setup password.....	120
Assigning a System Setup password.....	121
Deleting or changing an existing system setup password.....	121
Clearing BIOS (System Setup) and System passwords.....	122
Chapter 10: Troubleshooting.....	123
Dell SupportAssist Pre-boot System Performance Check diagnostics.....	123
Running the SupportAssist Pre-Boot System Performance Check.....	123
Power-Supply Unit Built-in Self-Test	123
System-diagnostic lights.....	124
Recovering the operating system.....	124
Real Time Clock—RTC reset.....	125
Backup media and recovery options.....	125
Wi-Fi power cycle.....	125

Chapter 11: Getting help and contacting Dell..... 127

Views of OptiPlex Small Form Factor 7010

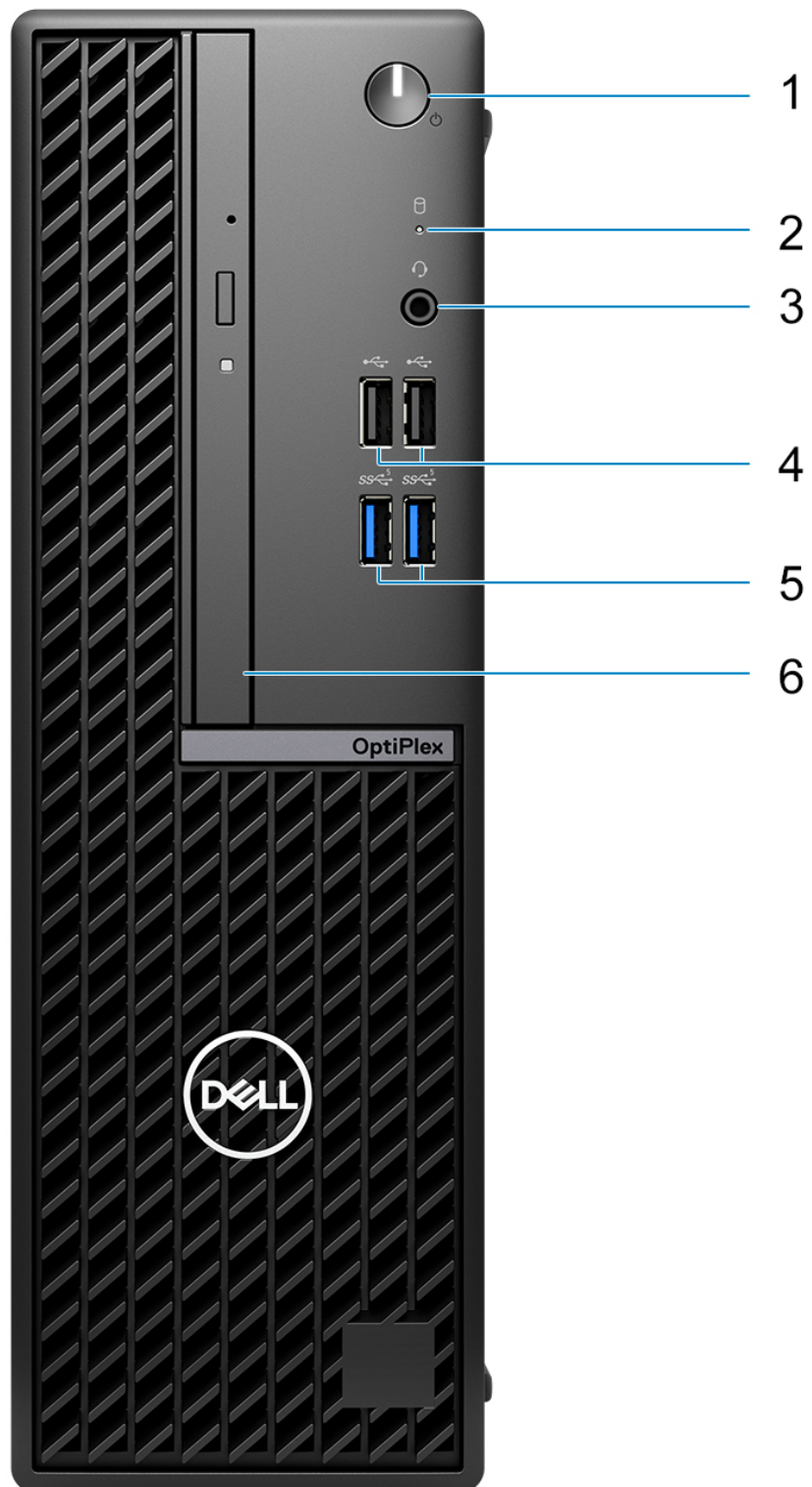

Display

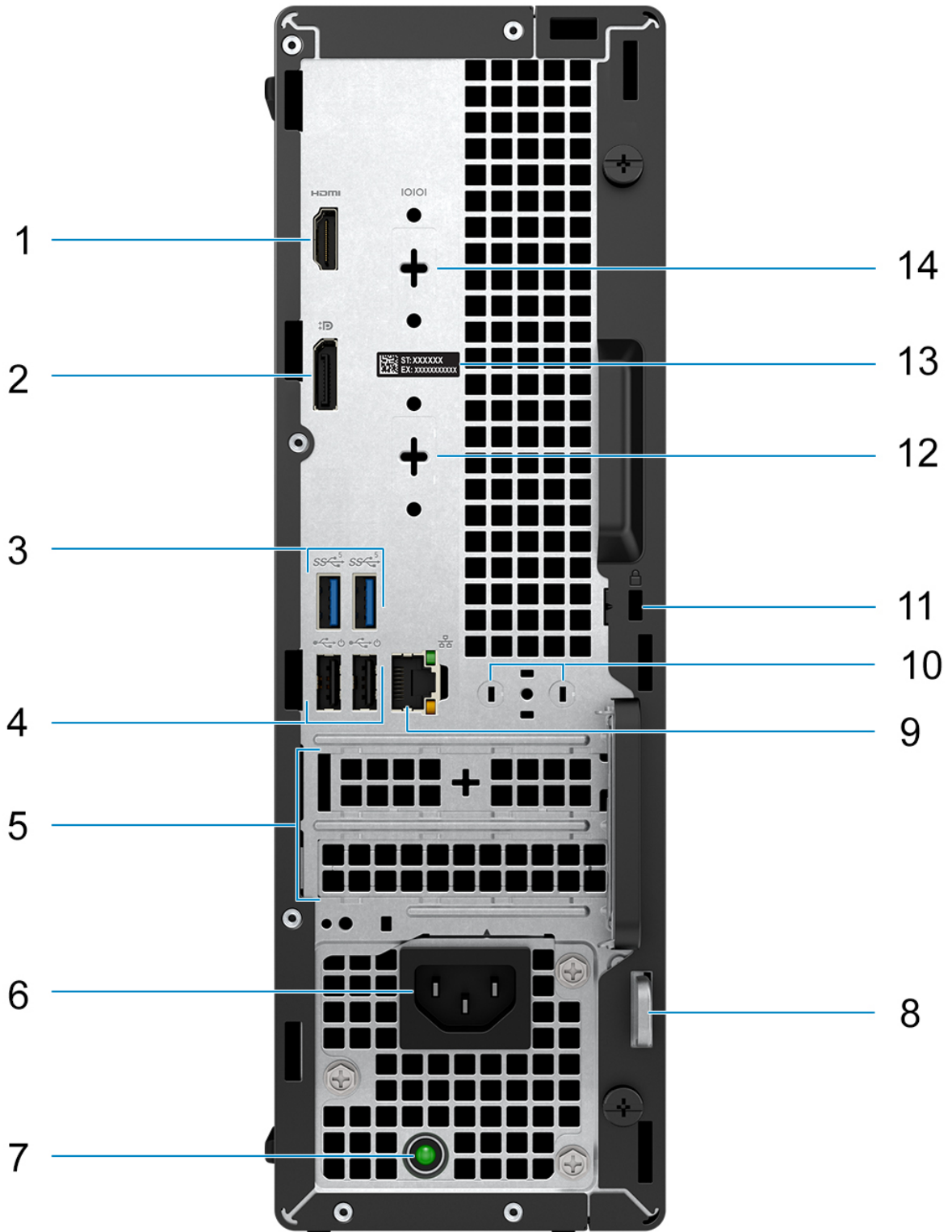

1. Power button with diagnostic LED
2. Hard-drive activity light
3. Universal audio jack port
4. Two USB 2.0 ports
5. Two USB 3.2 Gen 1 ports
6. Slim optical drive (optional)

Back



1. One HDMI 1.4b port
 -  **NOTE:** Maximum resolution up to 1920 x 1200 @ 60Hz.
2. One DisplayPort 1.4a port (HBR2)
 -  **NOTE:** Maximum resolution up to 4096 x 2304 @60Hz.
3. Two USB 3.2 Gen 1 ports
4. Two USB 2.0 ports with Smart Power On
5. Two expansion card slots
6. Power cable connector
7. Power-supply diagnostics light
8. Padlock ring
9. RJ45 Ethernet port 10/100/1000 Mbps
10. External antenna connector (optional)
11. One Security-cable slot (for Kensington locks)
12. One video port (HDMI 2.1/DisplayPort 1.4a (HBR3)/VGA) (optional)
 -  **NOTE:** Maximum resolution
 - **HDMI 2.1:** up to 4096 x 2160 @60Hz
 - **DisplayPort 1.4a (HBR3):** up to 5120 x 3200 @60Hz
 - **VGA:** up to 1920 x 1200 @60Hz
13. Service Tag label
14. One Serial port (optional)

Set up your computer

Steps

1. Connect the keyboard and mouse.

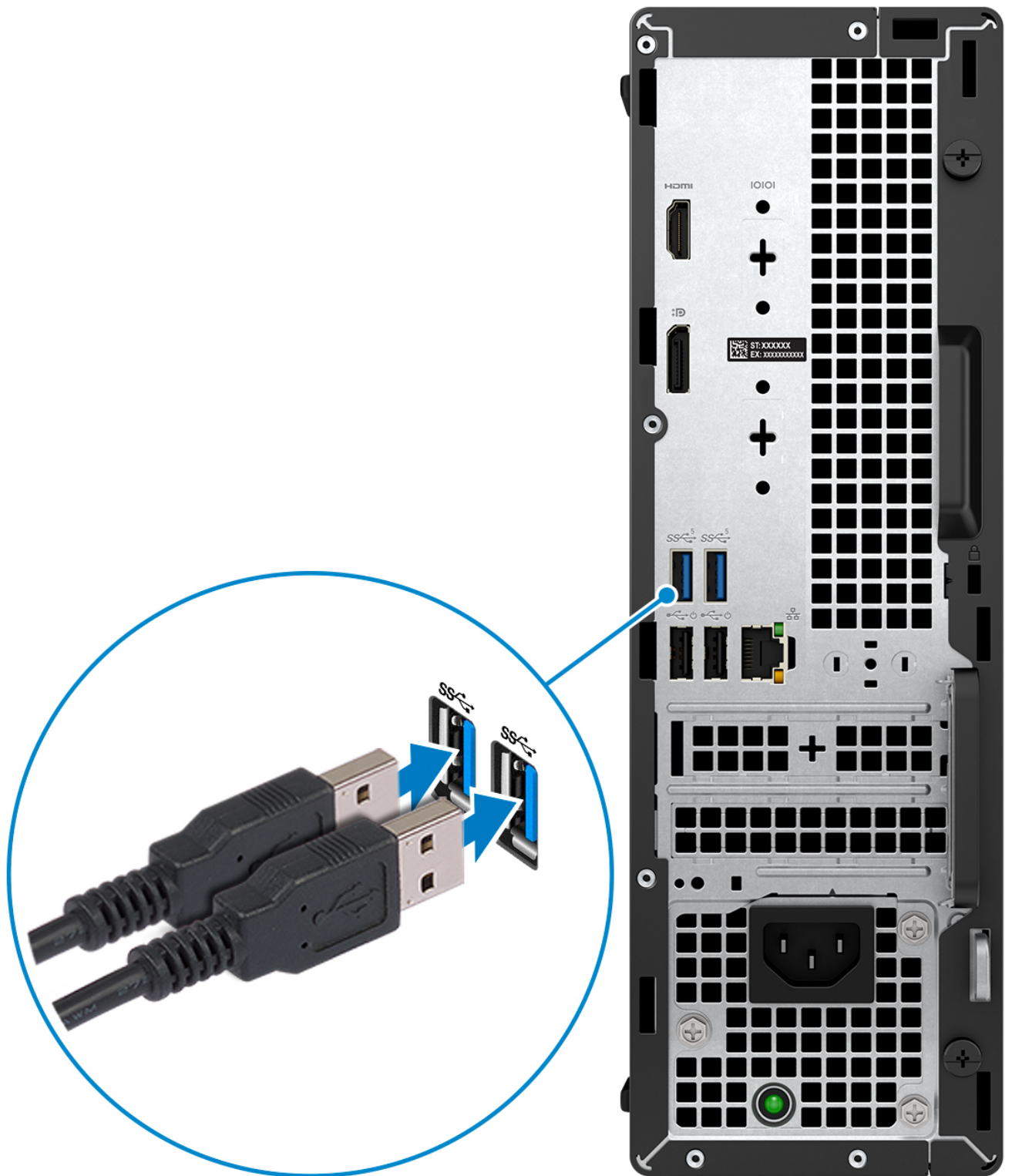

2. Connect to your network using a cable, or connect to a wireless network.

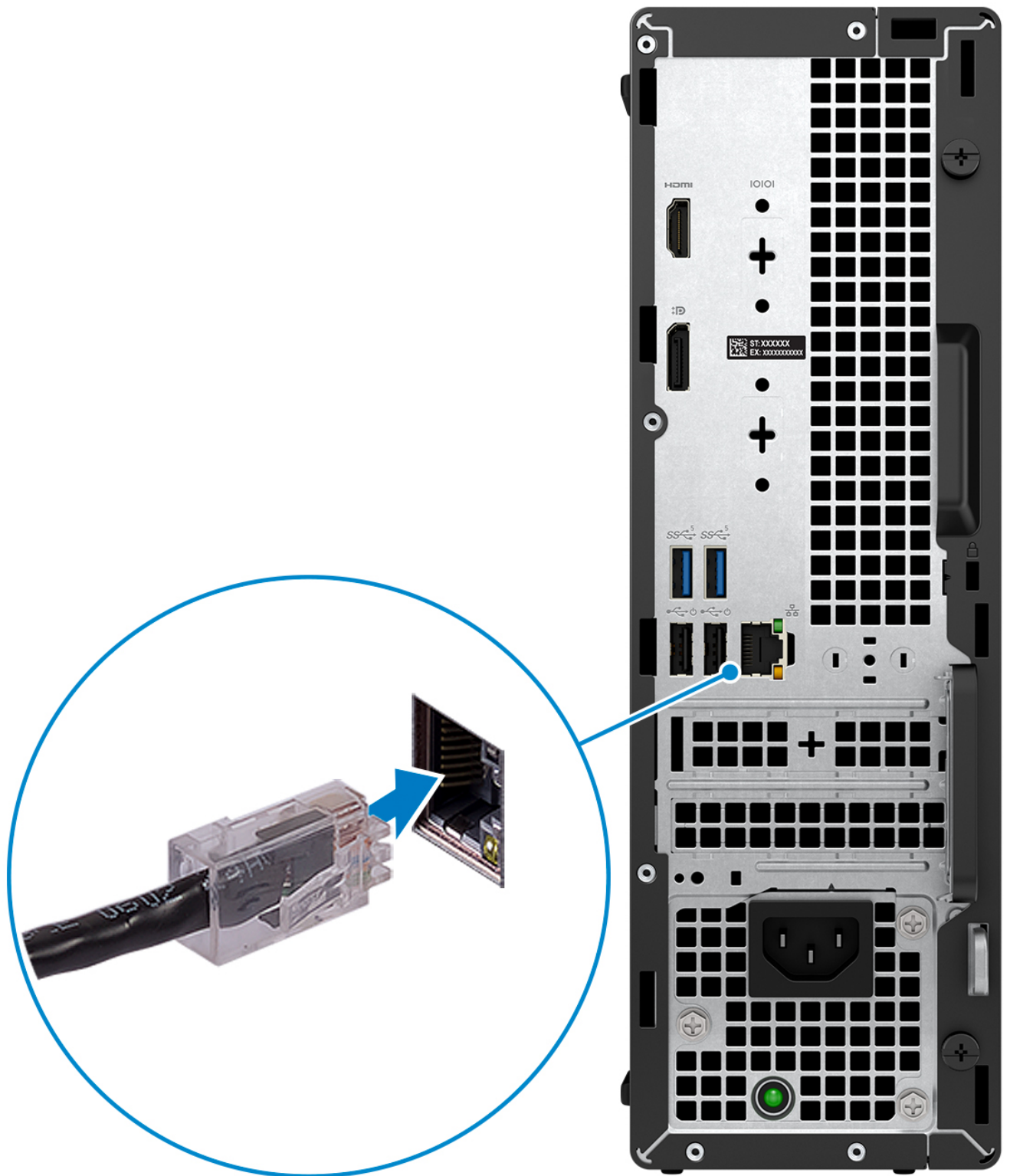

3. Connect the display.



4. Connect the power cable.

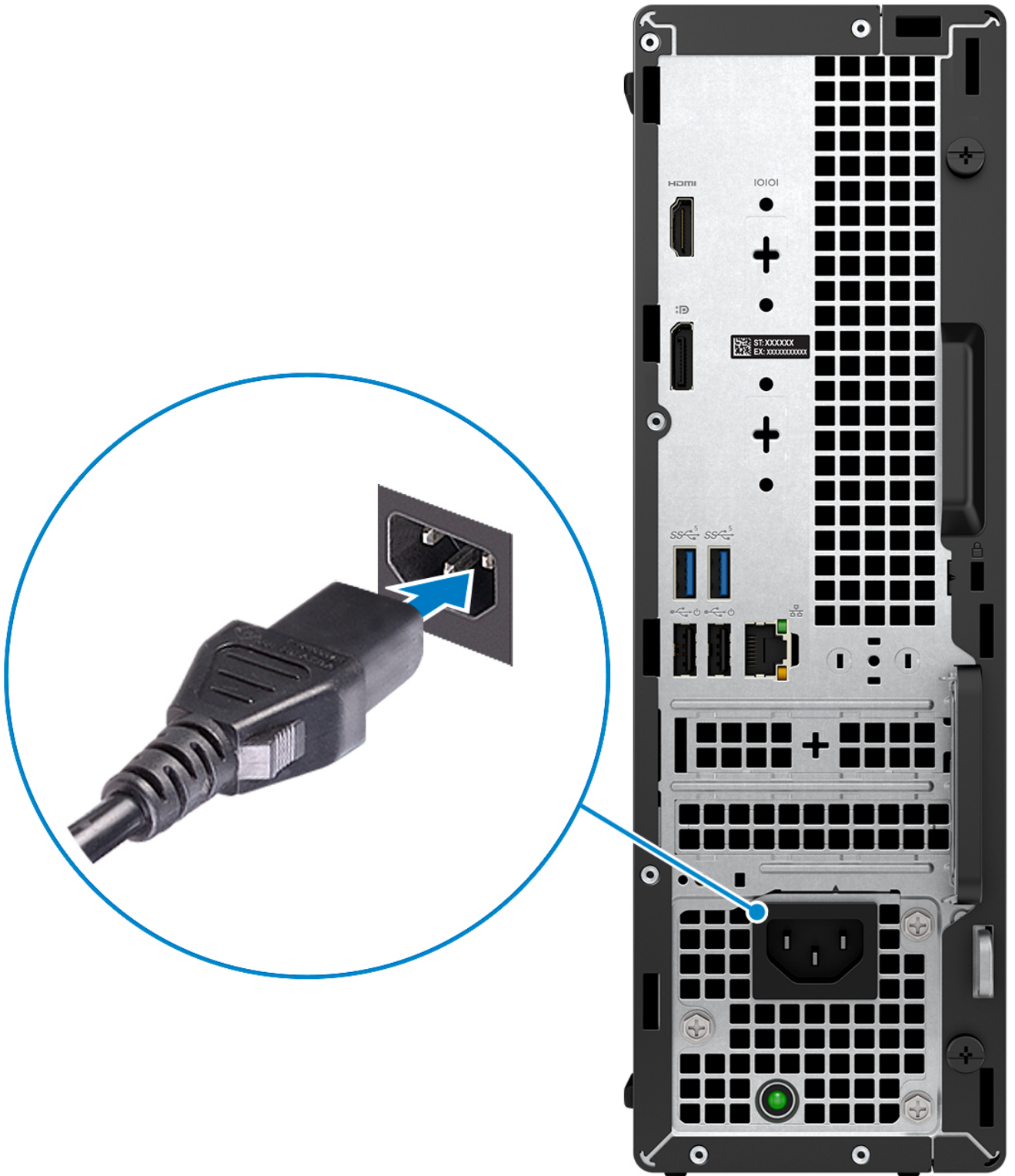

5. Press the power button.



6. Finish operating system setup.

For Ubuntu:

Follow the on-screen instructions to complete the setup. For more information about installing and configuring Ubuntu, search in the Knowledge Base Resource at www.dell.com/support.





For Windows:

Follow the on-screen instructions to complete the setup. When setting up, Dell recommends that you:

- Connect to a network for Windows updates.
 - ① **NOTE:** If connecting to a secured wireless network, enter the password for the wireless network access when prompted.
- If connected to the internet, sign-in with or create a Microsoft account. If not connected to the internet, create an offline account.
- On the **Support and Protection** screen, enter your contact details.

7. Locate and use Dell apps from the Windows Start menu—Recommended

Table 1. Locate Dell apps

Resources	Description
	My Dell Centralized location for key Dell applications, help articles, and other important information about your computer. It also notifies you about the warranty status, recommended accessories, and software updates if available.
	SupportAssist SupportAssist proactively and predictively identifies hardware and software issues on your computer and automates the engagement process with Dell Technical support. It addresses performance and stabilization issues, prevents security threats, monitors, and detects hardware failures. For more information, see <i>SupportAssist for Home PCs User's Guide</i> at www.dell.com/serviceabilitytools . Click SupportAssist and then, click SupportAssist for Home PCs . ① NOTE: In SupportAssist, click the warranty expiry date to renew or upgrade your warranty.
	Dell Update Updates your computer with critical fixes and latest device drivers as they become available. For more information on using Dell Update, search in the Knowledge Base Resource at www.dell.com/support .
	Dell Digital Delivery Download software applications, which are purchased but not preinstalled on your computer. For more information on using Dell Digital Delivery, search in the Knowledge Base Resource at www.dell.com/support .

Specifications of OptiPlex Small Form Factor 7010

Dimensions and weight

The following table lists the height, width, depth, and weight of your OptiPlex Small Form Factor 7010.

Table 2. Dimensions and weight

Description	Values
Height	290.00 mm (11.42 in.)
Width	92.60 mm (3.65 in.)
Depth	292.80 mm (11.53 in.)
Weight  NOTE: The weight of your computer depends on the configuration ordered and manufacturing variability.	<ul style="list-style-type: none"> Weight (minimum): 3.68 kg (8.10 lb) Weight (maximum): 4.87 kg (10.72 lb)

Processor

The following table lists the details of the processors supported by your OptiPlex Small Form Factor 7010.

Table 3. Processor

Description	Option one	Option two	Option three	Option four	Option five	Option six
Processor type	13 th Generation Intel Core i3-13100	13 th Generation Intel Core i5-13400	13 th Generation Intel Core i5-13500	13 th Generation Intel Core i5-13600	Intel Celeron G6900	Intel Pentium G7400
Processor wattage	60 W	65 W	65 W	65 W	46 W	46 W
Processor total core count	4	10	14	14	2	2
Performance-cores	4	6	6	6	2	2
Efficient-cores	0	4	8	8	0	0
Processor total thread counts	8	16	20	20	2	4
 NOTE: Intel® Hyper-Threading Technology is only available on Performance-cores.						
Processor speed	3.40 GHz to 4.50 GHz	2.50 GHz to 4.60 GHz	2.50 GHz to 4.80 GHz	2.70 GHz to 5.00 GHz turbo	Up to 3.40 GHz	Up to 3.70 GHz
Performance-cores frequency						
Processor base frequency	3.40 GHz	2.50 GHz	2.50 GHz	2.70 GHz	3.40 GHz	3.70 GHz
Maximum turbo frequency	4.50 GHz	4.60 GHz	4.80 GHz	5.00 GHz	NA	NA
Efficient-cores frequency						
Processor base frequency	NA	1.8 GHz	1.8 GHz	2.00 GHz	NA	NA
Maximum turbo frequency	NA	3.30 GHz	3.50 GHz	3.70 GHz	NA	NA
Processor cache	12 MB	20 MB	24 MB	24 MB	4 MB	6 MB
Integrated graphics	Intel UHD Graphics 730	Intel UHD Graphics 730	Intel UHD Graphics 770	Intel UHD Graphics 770	Intel UHD Graphics 710	Intel UHD Graphics 710

Chipset

The following table lists the details of the chipset supported by your OptiPlex Small Form Factor 7010.

Table 4. Chipset

Description	Values
Chipset	Intel Q670
Processor	Intel Core i3/i5/Intel Celeron/Pentium
DRAM bus width	64-bit/128-bit
Flash EPROM	32 MB RPMC+16 MB nRPMC
PCIe bus	Up to Gen3

Operating system

Your OptiPlex Small Form Factor 7010 supports the following operating systems:

- Windows 11 Home
- Windows 11 Pro
- Windows 11 Pro Downgrade (Windows 10 image)
- Windows 11 Pro National Education
- Windows 10 CMIT Government Edition (China only)
- Ubuntu Linux 22.04 LTS

Memory

The following table lists the memory specifications of your OptiPlex Small Form Factor 7010.

Table 5. Memory specifications

Description	Values
Memory slots	Two-UDIMM slots
Memory type	DDR4
Memory speed	Up to 3200 MT/s
Maximum memory configuration	64 GB
Minimum memory configuration	4 GB
Memory size per slot	4 GB, 8 GB, 16 GB, 32 GB
Memory configurations supported	<ul style="list-style-type: none">• 4 GB, 1 x 4 GB, DDR4, 3200 MT/s, single-channel• 8 GB, 1 x 8 GB, DDR4, 3200 MT/s, single-channel• 8 GB, 2 x 4 GB, DDR4, 3200 MT/s, dual-channel• 16 GB, 1 x 16 GB, DDR4, 3200 MT/s, single-channel• 16 GB, 2 x 8 GB, DDR4, 3200 MT/s, dual-channel• 32 GB, 1 x 32 GB, DDR4, 3200 MT/s, single-channel• 32 GB, 2 x 16 GB, DDR4, 3200 MT/s, dual-channel• 64 GB, 2 x 32 GB, DDR4, 3200 MT/s, dual-channel

Memory matrix

The following table lists the memory configurations supported on your OptiPlex Small Form Factor 7010.

Table 6. Memory matrix

Configuration	Slot	
	DIMM1	DIMM2
4 GB DDR4	4 GB	NA
8 GB DDR4	8 GB	NA
8 GB DDR4	4 GB	4 GB
16 GB DDR4	16 GB	NA
16 GB DDR4	8 GB	8 GB
32 GB DDR4	32 GB	NA
32 GB DDR4	16 GB	16 GB
64 GB DDR4	32 GB	32 GB

External ports

The following table lists the external ports of your OptiPlex Small Form Factor 7010.

Table 7. External ports

Description	Values
Network port	One RJ-45 Ethernet port 10/100/1000 Mbps
USB ports	<ul style="list-style-type: none"> • Two USB 3.2 Gen 1 (5 Gbps) ports (Front) • Two USB 2.0 (480 Mbps) ports (Front) • Two USB 3.2 Gen 1 (5 Gbps) ports (Rear) • Two USB 2.0 (480 Mbps) ports with Smart Power On (Rear)
Audio port	<ul style="list-style-type: none"> • One Universal audio jack (Front)
Video port	<ul style="list-style-type: none"> • One optional video port (HDMI 2.1/Displayport 1.4a (HBR3)/VGA) <ul style="list-style-type: none"> ① NOTE: The maximum resolution supported by HDMI 2.1 is up to 4096 x 2160 @60Hz. ① NOTE: The maximum resolution supported by DisplayPort 1.4a (HBR3) is up to 5120 x 3200 @60Hz. ① NOTE: The maximum resolution supported by VGA is up to 1920 x 1200 @60Hz. • One DisplayPort 1.4a port (HBR2) • One HDMI 1.4b port (Rear) <ul style="list-style-type: none"> ① NOTE: The maximum resolution supported by HDMI 1.4b port is 1920 x 1200 @ 60 Hz.
Media-card reader	Not supported
Power-adaptor port	Not supported
Security-cable slot	<ul style="list-style-type: none"> • Security-cable slot (for Kensington locks)

Table 7. External ports (continued)

Description	Values
	<ul style="list-style-type: none"> One Padlock ring

Internal slots

The following table lists the internal slots of your OptiPlex Small Form Factor 7010.

Table 8. Internal slots

Description	Values
Expansion	<ul style="list-style-type: none"> One Half-height Gen3 PCIe x16 slot One Half-height Gen3 PCIe x1 slot
M.2	<ul style="list-style-type: none"> One M.2 2230 slot for WiFi and Bluetooth combo card One M.2 2230/2280 slot for solid-state drive <p>NOTE: To learn more about the features of different types of M.2 cards, search in the Knowledge Base Resource at www.dell.com/support.</p>
SATA slots	Two SATA 3.0 slots for 2.5-inch/3.5-inch hard drive and slim optical drive

Ethernet

The following table lists the wired Ethernet Local Area Network (LAN) specifications of your OptiPlex Small Form Factor 7010.

Table 9. Ethernet specifications

Description	Values
Model number	Intel WGI219LM
Transfer rate	10/100/1000 Mbps

Wireless module

The following table lists the Wireless Local Area Network (WLAN) module specifications of your OptiPlex Small Form Factor 7010.

Table 10. Wireless module specifications

Description	Option one	Option two	Option three
Model number	Intel AX210	Realtek RTL8852BE	Realtek RTL8822CE
Transfer rate	Up to 2400 Mbps	Up to 1201 Mbps	Up to 433 Mbps
Frequency bands supported	2.40 GHz/5 GHz/6 GHz	2.40 GHz/5 GHz	2.40 GHz/5 GHz
Wireless standards	<ul style="list-style-type: none"> WiFi 802.11a/b/g Wi-Fi 4 (WiFi 802.11n) Wi-Fi 5 (WiFi 802.11ac) Wi-Fi 6E (WiFi 802.11ax) 	<ul style="list-style-type: none"> WiFi 802.11a/b/g Wi-Fi 4 (WiFi 802.11n) Wi-Fi 5 (WiFi 802.11ac) Wi-Fi 6 (WiFi 802.11ax) 	<ul style="list-style-type: none"> WiFi 802.11a/b/g Wi-Fi 4 (WiFi 802.11n) Wi-Fi 5 (WiFi 802.11ac)

Table 10. Wireless module specifications (continued)

Description	Option one	Option two	Option three
Encryption	<ul style="list-style-type: none"> 64-bit/128-bit WEP AES-CCMP TKIP 	<ul style="list-style-type: none"> 64-bit/128-bit WEP AES-CCMP TKIP 	<ul style="list-style-type: none"> 64-bit/128-bit WEP AES-CCMP TKIP
Bluetooth wireless card	Bluetooth wireless card	Bluetooth wireless card	Bluetooth wireless card
	 NOTE: The version of the Bluetooth wireless card may vary depending on the operating system that is installed on your computer.		

Audio

The following table lists the audio specifications of your OptiPlex Small Form Factor 7010.

Table 11. Audio specifications

Description	Values	
Audio controller	Realtek ALC3246-CG	
Stereo conversion	Supported	
Internal audio interface	High definition audio	
External audio interface	Universal audio jack	
Number of speakers	One	
Internal-speaker amplifier	Codec built-in amp	
External volume controls	Not supported	
Speaker output:		
	Average speaker output	2 W
	Peak speaker output	2.5 W
Subwoofer output	Not supported	
Microphone	Internal Mic not available	

Storage

This section lists the storage options on your OptiPlex Small Form Factor 7010.

Table 12. Storage matrix

Storage	2.5-inch hard-disk drive	3.5-inch hard-disk drive	M.2 2230/2280 socket	M.2 via PCIe card
M.2 solid-state drive	No	No	Yes	No
M.2 solid-state drive + 2.5-inch hard-disk drive	Yes	No	Yes	No
M.2 solid-state drive + 3.5-inch hard-disk drive	No	Yes	Yes	No

Table 12. Storage matrix (continued)

Storage	2.5-inch hard-disk drive	3.5-inch hard-disk drive	M.2 2230/2280 socket	M.2 via PCIe card
M.2 solid-state drive + M.2 solid-state drive (via M.2 expansion card)	No	No	Yes	Yes
M.2 solid-state drive + 3.5-inch hard-disk drive + M.2 solid-state drive (via M.2 expansion card)	No	Yes	Yes	Yes
M.2 solid-state drive + 2.5-inch hard-disk drive + M.2 solid-state drive (via M.2 expansion card)	Yes	No	Yes	Yes
2.5-inch hard-disk drive	Yes	No	No	No
3.5-inch hard-disk drive	No	Yes	No	No

Table 13. Storage specifications

Storage type	Interface type	Capacity
2.5-inch hard-disk drive	SATA 3.0	Up to 1 TB
3.5-inch hard-disk drive	SATA 3.0	Up to 2 TB
M.2 2230 solid-state drive, Class 35	PCIe NVMe, up to 64 Gbps	Up to 1 TB
M.2 2280 solid-state drive, Class 40, Self-Encrypting drive	PCIe NVMe, up to 64 Gbps	Up to 1 TB
M.2 2230 solid-state drive, Class 25	PCIe NVMe, up to 64 Gbps	Up to 1 TB

Power ratings

The following table lists the power rating specifications of OptiPlex Small Form Factor 7010.

Table 14. Power ratings

Description	Option one	Option two
Type	180 W internal power supply unit (PSU), 85% Efficient, 80 Plus Bronze	300 W internal power supply unit (PSU), 92% Efficient, 80 Plus Platinum
Input voltage	90 VAC - 264 VAC	90 VAC - 264 VAC
Input frequency	47 Hz - 63 Hz	47 Hz - 63 Hz
Input current (maximum)	3.0 A	4.2 A
Output current (continuous)	<ul style="list-style-type: none"> • 12 VA / 15 A • 12 VB / 14 A Standby mode: <ul style="list-style-type: none"> • 12 VA / 1.5 A • 12 VB / 3.3 A 	<ul style="list-style-type: none"> • 12 VA / 18 A • 12 VB / 18 A Standby mode: <ul style="list-style-type: none"> • 12 VA / 1.5 A • 12 VB / 3.3 A
Rated output voltage	1. +12 VA 2. +12 VB	1. +12 VA 2. +12 VB
Temperature range		
Operating	5°C to 45°C (41°F to 113°F)	5°C to 45°C (41°F to 113°F)

Table 14. Power ratings (continued)

Description	Option one	Option two
Storage	-40°C to 70°C (-40°F to 158°F)	-40°C to 70°C (-40°F to 158°F)

Power supply connector

The following table lists the Power supply connector specifications of your OptiPlex Small Form Factor 7010.

Table 15. Power supply connector

Power supply unit	Connectors
180 W (80 Plus Bronze)	<ul style="list-style-type: none"> Two 4 pin connectors for processor One 8 pin connector for system board
300 W (80 Plus Platinum)	<ul style="list-style-type: none"> Two 4 pin connectors for processor One 8 pin connector for system board

GPU—Integrated

The following table lists the specifications of the integrated Graphics Processing Unit (GPU) supported by your OptiPlex Small Form Factor 7010.

Table 16. GPU—Integrated

Controller	External display support	Memory size	Processor
Intel UHD Graphics 710	One DisplayPort 1.4a (HBR2, 4096 x 2304 @60Hz max. resolution)/ One HDMI 1.4b port (1920x1200@60Hz max. resolution)	Shared system memory	Intel Celeron G6900 and Intel Pentium Gold G7400 processors
Intel UHD Graphics 730	One DisplayPort 1.4a (HBR2, 4096 x 2304 @60Hz max. resolution)/ One HDMI 1.4b port (1920x1200@60Hz max. resolution)	Shared system memory	13th Generation Intel Core i3-13100 and i5-13400 processors
Intel UHD Graphics 770	One DisplayPort 1.4a (HBR2, 4096 x 2304 @60Hz max. resolution)/ One HDMI 1.4b port (1920x1200@60Hz max. resolution)	Shared system memory	13th Generation Intel Core i5-13500, i5-13600, processors

Video port resolution (GPU—Integrated)

Table 17. Video port resolution (GPU—Integrated)

Graphics card	Video ports	Maximum supported resolution
Intel UHD Graphics	<ul style="list-style-type: none"> One HDMI 1.4b port One DisplayPort 1.4a port (HBR2) One video port (HDMI 2.1/ Displayport 1.4a (HBR3)/VGA) (optional) 	<ul style="list-style-type: none"> HDMI 1.4b port - 1920 x 1200 @ 60 Hz DisplayPort 1.4a port - 4096 x 2304 @60Hz One video port (HDMI 2.1/ Displayport 1.4a (HBR3)/VGA)

Table 17. Video port resolution (GPU—Integrated)

Graphics card	Video ports	Maximum supported resolution
		(optional) - maximum resolution supported by HDMI 2.1 is up to 4096 x 2160 @60Hz, DisplayPort 1.4a (HBR3) is up to 5120 x 3200 @60Hz, VGA is up to 1920 x 1200 @60Hz

External display support (GPU—Integrated)

Display support for the integrated graphics card

Table 18. Display support specifications

Graphics card	Supported external displays
Intel UHD Graphics 710/730/770	4
Intel UHD Graphics 710/730/770 + optional module	4

 **NOTE:** MST/daisy-chaining supports 4 displays.

GPU—Discrete

The following table lists the specifications of the discrete Graphics Processing Unit (GPU) supported by your OptiPlex Small Form Factor 7010.

Table 19. GPU—Discrete

Controller	Memory size	Memory type
AMD Radeon RX6500	4 GB	GDDR6
AMD Radeon RX6300	2 GB	GDDR6

External display support (GPU—Discrete)

Table 20. External display support (GPU—Discrete)

Graphics Card	Video ports	Number of supported external displays	DisplayPort Multi-Stream Transport (MST) support
AMD Radeon RX6300	Two DisplayPort 1.4a (DP1.4a*2)	4	Supported
AMD Radeon RX6500	Two DisplayPort 1.4a (DP1.4a*2)	4	Supported

 **NOTE:** DisplayPort Multi-Stream Transport (MST) allows you to daisy chain monitors that have DisplayPort 1.2 and above ports and MST support. For more information about using DisplayPort Multi-Stream Transport, see www.dell.com/support.

Hardware security

The following table lists the hardware security of your OptiPlex Small Form Factor 7010.

Table 21. Hardware security

Hardware security
Kensington security-cable slot
Padlock loop
Chassis lock slot support
Chassis intrusion switch
Lockable cable covers
SafelD including Trusted Platform Module (TPM) 2.0
Smart card keyboard (FIPS)
Microsoft 10 Device Guard and Credential Guard (Enterprise SKU)
Microsoft Windows Bitlocker
Local hard drive data wipe through BIOS (Secure Erase)
Self-encrypting storage drives (Opal, FIPS)
Trusted Platform Module TPM 2.0
China TPM
Intel Secure Boot
Intel Authenticate
SafeBIOS: includes Dell Off-host BIOS Verification, BIOS Resilience, BIOS Recovery, and additional BIOS Controls
OptiPlex SFF Cable Cover

Environmental

The following table lists the environmental specifications of your OptiPlex Small Form Factor 7010.

Table 22. Environmental

Feature	Values
Recyclable packaging	Yes
BFR/PVC—free	No
Vertical orientation packaging support	No
Multi-Pack packaging	Yes
Energy-Efficient Power Supply	Standard
ENV0424 compliant	Yes

i NOTE: Wood-based fiber packaging contains a minimum of 35% recycled content by total weight of wood-based fiber. Packaging that contains without wood-based fiber can be claimed as Not Applicable. The anticipated required criteria for EPEAT 2018.

Regulatory compliance

The following table lists the regulatory compliance of your OptiPlex Small Form Factor 7010.

Table 23. Regulatory compliance

Regulatory compliance
Product Safety, EMC and Environmental Datasheets
Dell Regulatory Compliance Home Page
Dell and the Environment

Operating and storage environment

This table lists the operating and storage specifications of your OptiPlex Small Form Factor 7010.

Airborne contaminant level: G1 as defined by ISA-S71.04-1985

Table 24. Computer environment

Description	Operating	Storage
Temperature range	10°C to 35°C (50°F to 95°F)	-40°C-70°C (-40°F-158°F)
Relative humidity (maximum)	20% to 80% (non-condensing, Max dew point temperature = 26°C)	5% to 95% (non-condensing, Max dew point temperature = 33°C)
Vibration (maximum)*	0.26 GRMS random at 5 Hz to 350 Hz	1.37 GRMS random at 5 Hz to 350 Hz
Shock (maximum)	Bottom/Right half-sine pulse 40G, 2 ms	105G, 2 ms half-sine pulse
Altitude range	-15.2 m to 3048 m (-49.8 ft to 10,000 ft)	-15.2 m to 10,668 m (-49.8 ft to 35,000 ft)
Airborne Contaminants	ISA-71 G1**à: <300A/month copper coupon corrosion AND <200A/month of silver coupon corrosion	ISA-71 G1**à: <300A/month copper coupon corrosion AND <200A/month of silver coupon corrosion
<p>]</p> <p>CAUTION: Operating and storage temperature ranges may differ among components, so operating or storing the device outside these ranges may impact the performance of specific components.</p>		











* Measured using a random vibration spectrum that simulates user environment.

† Measured using a 2 ms half-sine pulse.

Working inside your computer

Safety instructions

Use the following safety guidelines to protect your computer from potential damage and to ensure your personal safety. Unless otherwise noted, each procedure included in this document assumes that you have read the safety information that shipped with your computer.

-  **WARNING:** Before working inside your computer, read the safety information that is shipped with your computer. For more safety best practices, see the Regulatory Compliance home page at www.dell.com/regulatory_compliance.
-  **WARNING:** Disconnect your computer from all power sources before opening the computer cover or panels. After you finish working inside the computer, replace all covers, panels, and screws before connecting your computer to an electrical outlet.
-  **CAUTION:** To avoid damaging the computer, ensure that the work surface is flat, dry, and clean.
-  **CAUTION:** To avoid damaging the components and cards, handle them by their edges, and avoid touching the pins and the contacts.
-  **CAUTION:** You should only perform troubleshooting and repairs as authorized or directed by the Dell technical assistance team. Damage due to servicing that is not authorized by Dell is not covered by your warranty. See the safety instructions that is shipped with the product or at www.dell.com/regulatory_compliance.
-  **CAUTION:** Before touching anything inside your computer, ground yourself by touching an unpainted metal surface, such as the metal at the back of the computer. While you work, periodically touch an unpainted metal surface to dissipate static electricity which could harm internal components.
-  **CAUTION:** When you disconnect a cable, pull it by its connector or its pull tab, not the cable itself. Some cables have connectors with locking tabs or thumbscrews that you must disengage before disconnecting the cable. When disconnecting cables, keep them evenly aligned to avoid bending the connector pins. When connecting cables, ensure that the ports and the connectors are correctly oriented and aligned.
-  **CAUTION:** Press and eject any installed card from the media-card reader.
-  **CAUTION:** Exercise caution when handling rechargeable Li-ion batteries in laptops. Swollen batteries should not be used and should be replaced and disposed properly.
-  **NOTE:** The color of your computer and certain components may appear differently than shown in this document.

Before working inside your computer

About this task

-  **NOTE:** The images in this document may differ from your computer depending on the configuration you ordered.

Steps

1. Save and close all open files and exit all open applications.
2. Shut down your computer. For Windows operating system, click **Start** >  **Power** > **Shut down**.

 **NOTE:** If you are using a different operating system, see the documentation of your operating system for shut-down instructions.

3. Disconnect your computer and all attached devices from their electrical outlets.
4. Disconnect all attached network devices and peripherals, such as keyboard, mouse, and monitor from your computer.

 **CAUTION:** To disconnect a network cable, first unplug the cable from your computer and then unplug the cable from the network device.

5. Remove any media card and optical disc from your computer, if applicable.

Safety precautions

The safety precautions chapter details the primary steps to be taken before performing any disassembly instructions.

Observe the following safety precautions before you perform any installation or break/fix procedures involving disassembly or reassembly:

- Turn off the system and all attached peripherals.
- Disconnect the system and all attached peripherals from AC power.
- Disconnect all network cables, telephone, and telecommunications lines from the system.
- Use an ESD field service kit when working inside any desktop to avoid electrostatic discharge (ESD) damage.
- After removing any system component, carefully place the removed component on an anti-static mat.
- Wear shoes with non-conductive rubber soles to reduce the chance of getting electrocuted.

Standby power

Dell products with standby power must be unplugged before you open the case. Systems that incorporate standby power are essentially powered while turned off. The internal power enables the system to be remotely turned on (wake on LAN) and suspended into a sleep mode and has other advanced power management features.

Unplugging, pressing, and holding the power button for 15 seconds should discharge residual power in the system board.

Bonding

Bonding is a method for connecting two or more grounding conductors to the same electrical potential. This is done through the use of a field service electrostatic discharge (ESD) kit. When connecting a bonding wire, ensure that it is connected to bare metal and never to a painted or non-metal surface. The wrist strap should be secure and in full contact with your skin, and ensure that you remove all jewelry such as watches, bracelets, or rings prior to bonding yourself and the equipment.

Electrostatic discharge—ESD protection

ESD is a major concern when you handle electronic components, especially sensitive components such as expansion cards, processors, memory DIMMs, and system boards. Very slight charges can damage circuits in ways that may not be obvious, such as intermittent problems or a shortened product life span. As the industry pushes for lower power requirements and increased density, ESD protection is an increasing concern.

Due to the increased density of semiconductors used in recent Dell products, the sensitivity to static damage is now higher than in previous Dell products. For this reason, some previously approved methods of handling parts are no longer applicable.

Two recognized types of ESD damage are catastrophic and intermittent failures.

- **Catastrophic** – Catastrophic failures represent approximately 20 percent of ESD-related failures. The damage causes an immediate and complete loss of device functionality. An example of catastrophic failure is a memory DIMM that has received a static shock and immediately generates a "No POST/No Video" symptom with a beep code emitted for missing or nonfunctional memory.
- **Intermittent** – Intermittent failures represent approximately 80 percent of ESD-related failures. The high rate of intermittent failures means that most of the time when damage occurs, it is not immediately recognizable. The DIMM receives a static shock, but the tracing is merely weakened and does not immediately produce outward symptoms related to the damage. The weakened trace may take weeks or months to melt, and in the meantime may cause degradation of memory integrity, intermittent memory errors, etc.

The more difficult type of damage to recognize and troubleshoot is the intermittent (also called latent or "walking wounded") failure.

Perform the following steps to prevent ESD damage:

- Use a wired ESD wrist strap that is properly grounded. The use of wireless anti-static straps is no longer allowed; they do not provide adequate protection. Touching the chassis before handling parts does not ensure adequate ESD protection on parts with increased sensitivity to ESD damage.
- Handle all static-sensitive components in a static-safe area. If possible, use anti-static floor pads and workbench pads.
- When unpacking a static-sensitive component from its shipping carton, do not remove the component from the anti-static packing material until you are ready to install the component. Before unwrapping the anti-static packaging, ensure that you discharge static electricity from your body.
- Before transporting a static-sensitive component, place it in an anti-static container or packaging.

ESD field service kit

The unmonitored Field Service kit is the most commonly used service kit. Each Field Service kit includes three main components: anti-static mat, wrist strap, and bonding wire.

Components of an ESD field service kit

The components of an ESD field service kit are:

- **Anti-Static Mat** – The anti-static mat is dissipative and parts can be placed on it during service procedures. When using an anti-static mat, your wrist strap should be snug and the bonding wire should be connected to the mat and to any bare metal on the system being worked on. Once deployed properly, service parts can be removed from the ESD bag and placed directly on the mat. ESD-sensitive items are safe in your hand, on the ESD mat, in the system, or inside a bag.
- **Wrist Strap and Bonding Wire** – The wrist strap and bonding wire can be either directly connected between your wrist and bare metal on the hardware if the ESD mat is not required, or connected to the anti-static mat to protect hardware that is temporarily placed on the mat. The physical connection of the wrist strap and bonding wire between your skin, the ESD mat, and the hardware is known as bonding. Use only Field Service kits with a wrist strap, mat, and bonding wire. Never use wireless wrist straps. Always be aware that the internal wires of a wrist strap are prone to damage from normal wear and tear, and must be checked regularly with a wrist strap tester in order to avoid accidental ESD hardware damage. It is recommended to test the wrist strap and bonding wire at least once per week.
- **ESD Wrist Strap Tester** – The wires inside of an ESD strap are prone to damage over time. When using an unmonitored kit, it is a best practice to regularly test the strap prior to each service call, and at a minimum, test once per week. A wrist strap tester is the best method for doing this test. If you do not have your own wrist strap tester, check with your regional office to find out if they have one. To perform the test, plug the wrist-strap's bonding-wire into the tester while it is strapped to your wrist and push the button to test. A green LED is lit if the test is successful; a red LED is lit and an alarm sounds if the test fails.
- **Insulator Elements** – It is critical to keep ESD sensitive devices, such as plastic heat sink casings, away from internal parts that are insulators and often highly charged.
- **Working Environment** – Before deploying the ESD Field Service kit, assess the situation at the customer location. For example, deploying the kit for a server environment is different than for a desktop or portable environment. Servers are typically installed in a rack within a data center; desktops or portables are typically placed on office desks or cubicles. Always look for a large open flat work area that is free of clutter and large enough to deploy the ESD kit with additional space to accommodate the type of system that is being repaired. The workspace should also be free of insulators that can cause an ESD event. On the work area, insulators such as Styrofoam and other plastics should always be moved at least 12 inches or 30 centimeters away from sensitive parts before physically handling any hardware components
- **ESD Packaging** – All ESD-sensitive devices must be shipped and received in static-safe packaging. Metal, static-shielded bags are preferred. However, you should always return the damaged part using the same ESD bag and packaging that the new part arrived in. The ESD bag should be folded over and taped shut and all the same foam packing material should be used in the original box that the new part arrived in. ESD-sensitive devices should be removed from packaging only at an ESD-protected work surface, and parts should never be placed on top of the ESD bag because only the inside of the bag is shielded. Always place parts in your hand, on the ESD mat, in the system, or inside an anti-static bag.
- **Transporting Sensitive Components** – When transporting ESD sensitive components such as replacement parts or parts to be returned to Dell, it is critical to place these parts in anti-static bags for safe transport.

ESD protection summary

It is recommended to use the traditional wired ESD grounding wrist strap and protective anti-static mat at all times when servicing Dell products. In addition, it is critical to keep sensitive parts separate from all insulator parts while performing service and that they use anti-static bags for transporting sensitive components.

Transporting sensitive components

When transporting ESD sensitive components such as replacement parts or parts to be returned to Dell, it is critical to place these parts in anti-static bags for safe transport.

Lifting equipment

Adhere to the following guidelines when lifting heavy weight equipment:

 **CAUTION: Do not lift greater than 50 pounds. Always obtain additional resources or use a mechanical lifting device.**

1. Get a firm balanced footing. Keep your feet apart for a stable base, and point your toes out.
2. Tighten stomach muscles. Abdominal muscles support your spine when you lift, offsetting the force of the load.
3. Lift with your legs, not your back.
4. Keep the load close. The closer it is to your spine, the less force it exerts on your back.
5. Keep your back upright, whether lifting or setting down the load. Do not add the weight of your body to the load. Avoid twisting your body and back.
6. Follow the same techniques in reverse to set the load down.

After working inside your computer

About this task

 **NOTE:** Leaving stray or loose screws inside your computer may severely damage your computer.

Steps

1. Replace all screws and ensure that no stray screws remain inside your computer.
2. Connect any external devices, peripherals, or cables you removed before working on your computer.
3. Replace any media cards, discs, or any other parts that you removed before working on your computer.
4. Connect your computer and all attached devices to their electrical outlets.
5. Turn on your computer.

BitLocker

 **CAUTION: If BitLocker is not suspended before updating the BIOS, the next time you reboot the system it will not recognize the BitLocker key. You will then be prompted to enter the recovery key to progress, and the system will ask for this on each reboot. If the recovery key is not known this can result in data loss or an unnecessary operating system reinstall. For more information about this subject, see Knowledge Article: [updating the BIOS on Dell systems with BitLocker enabled.](#)**

The installation of the following components triggers BitLocker:

- Hard disk drive or solid state drive
- System board

Recommended tools

The procedures in this document may require the following tools:

- Phillips screwdriver #0
- Phillips screwdriver #1
- Torx #5 (T5) screwdriver
- Plastic scribe

Screw list

NOTE: When removing screws from a component, it is recommended to note the screw type, the quantity of screws, and then place them in a screw storage box. This is to ensure that the correct number of screws and correct screw type is restored when the component is replaced.

NOTE: Some computers have magnetic surfaces. Ensure that the screws are not left attached to such surfaces when replacing a component.

NOTE: Screw color may vary with the configuration ordered.

Table 25. Screw list













Component	Screw type	Quantity	Screw image
M.2 2230/M.2 2280 Solid-state drive	M2x3.5	1	
Hard-drive and optical-drive supporting bracket	#6-32	1	
Optical-drive supporting bracket	M2x2	1	
2.5-inch Hard-drive	M3x3.5	4	
3.5-inch Hard-drive	#6-32	4	
Serial/VGA module	M2x5	2	
DP/HDMI/Type-C module	M3x3	2	
SD-card reader	M3x5	1	
WLAN card	M2x3	1	
Processor-fan and heat-sink assembly	Captive	4	
Voltage regulator heat-sink	Captive	4	
Power-supply unit	#6-32	3	

Table 25. Screw list (continued)

Component	Screw type	Quantity	Screw image
System board	#6-32	5	

Major components of OptiPlex Small Form Factor 7010

The following image shows the major components of OptiPlex Small Form Factor 7010.

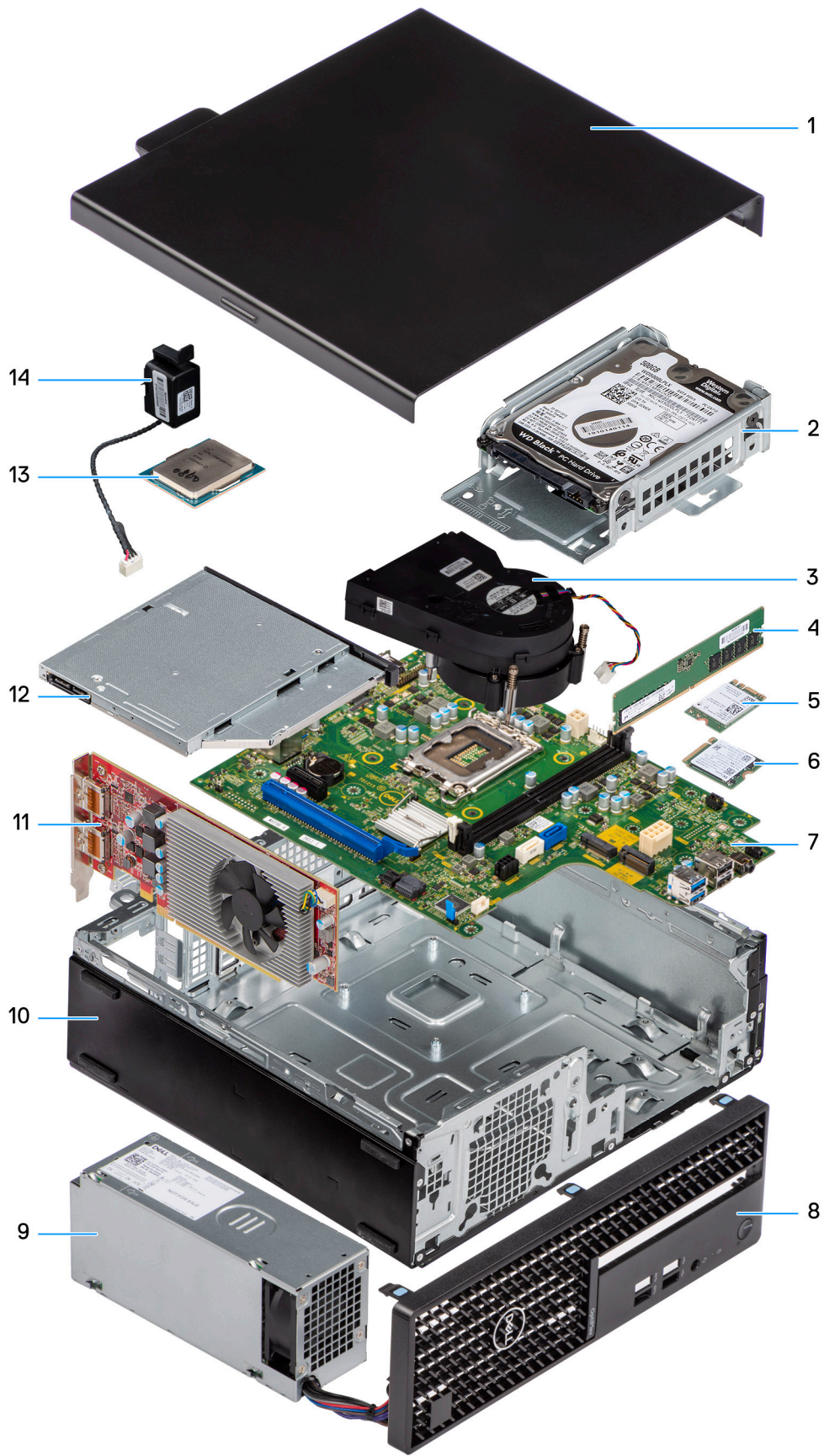

1. Side cover
2. Hard-drive assembly
3. Heat-sink and fan assembly
4. Memory module
5. Wireless card
6. M.2 solid-state drive
7. System board
8. Front bezel
9. Power-supply unit
10. Chassis
11. Expansion card
12. Optical drive
13. Processor
14. Speaker

i **NOTE:** Dell provides a list of components and their part numbers for the original system configuration purchased. These parts are available according to warranty coverages purchased by the customer. Contact your Dell sales representative for purchase options.

Side cover

Removing the side cover

Prerequisites

1. Follow the procedure in [Before working inside your computer](#).

About this task

The following image indicates the location of the side cover and provides a visual representation of the removal procedure.

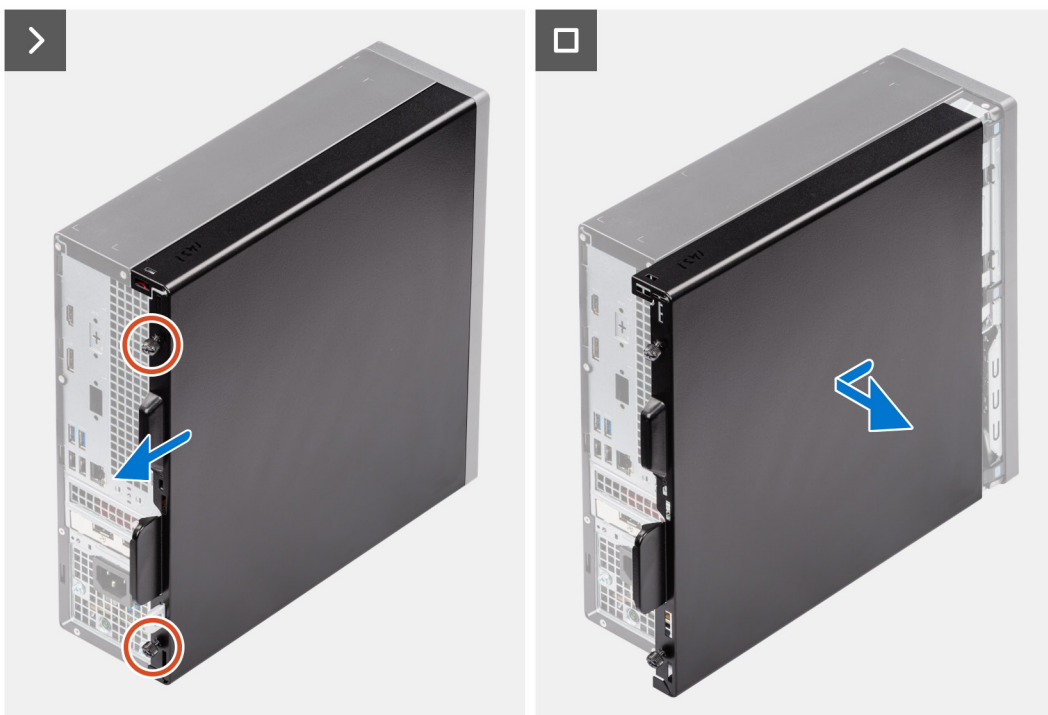

Steps

1. Loosen the two captive screws that secure the side cover to the chassis.
2. Slide the side cover towards the back of the computer.
3. Lift the side cover from the chassis.

Installing the side cover

Prerequisites

If you are replacing a component, remove the existing component before performing the installation procedure.

About this task

The following image indicates the location of the side cover and provides a visual representation of the installation procedure.

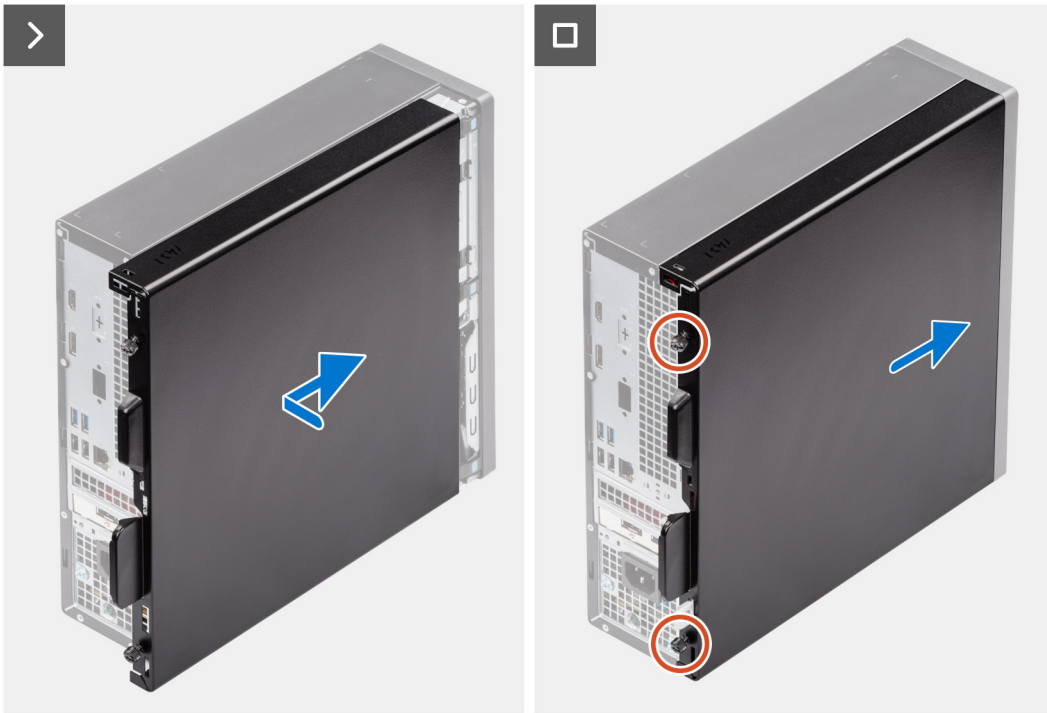

Steps

1. Align the tabs on the side cover with the slots on the chassis.
2. Slide the side cover towards the front of the computer.
3. Tighten the two captive screws to secure the side cover to the chassis.

Next steps

1. Follow the procedure in [After working inside your computer](#).

Removing and installing Customer Replaceable Units (CRUs)

The replaceable components in this chapter are Customer Replaceable Units (CRUs).

 **CAUTION:** Customers can replace only the Customer Replaceable Units (CRUs) following the safety precautions and replacement procedures.

 **NOTE:** The images in this document may differ from your computer depending on the configuration you ordered.

Front bezel

Removing the front bezel

Prerequisites

1. Follow the procedure in [Before working inside your computer](#).
2. Remove the [side cover](#).

About this task

The following images indicate the location of the front bezel and provides a visual representation of the removal procedure.

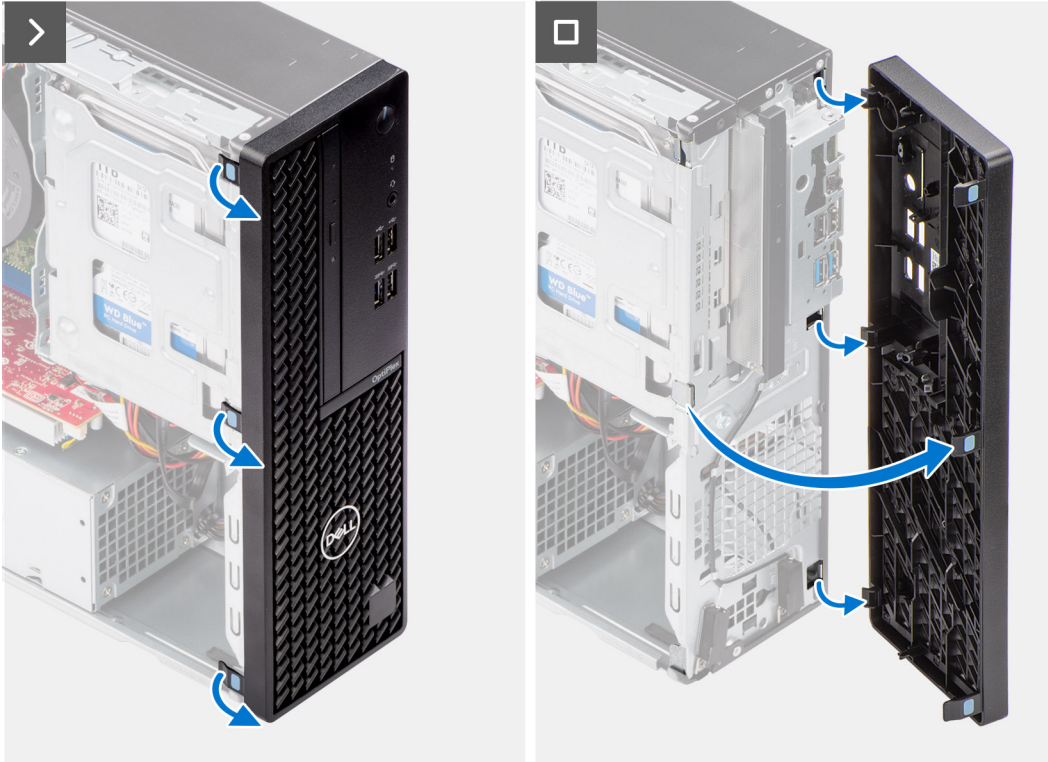

Steps

1. Gently pry and release the front-bezel tabs sequentially from the top.
2. Rotate the front bezel outward from the chassis and remove the front bezel.

Installing the front bezel

Prerequisites

If you are replacing a component, remove the existing component before performing the installation procedure.

About this task

The following images indicate the location of the front bezel and provides a visual representation of the installation procedure.

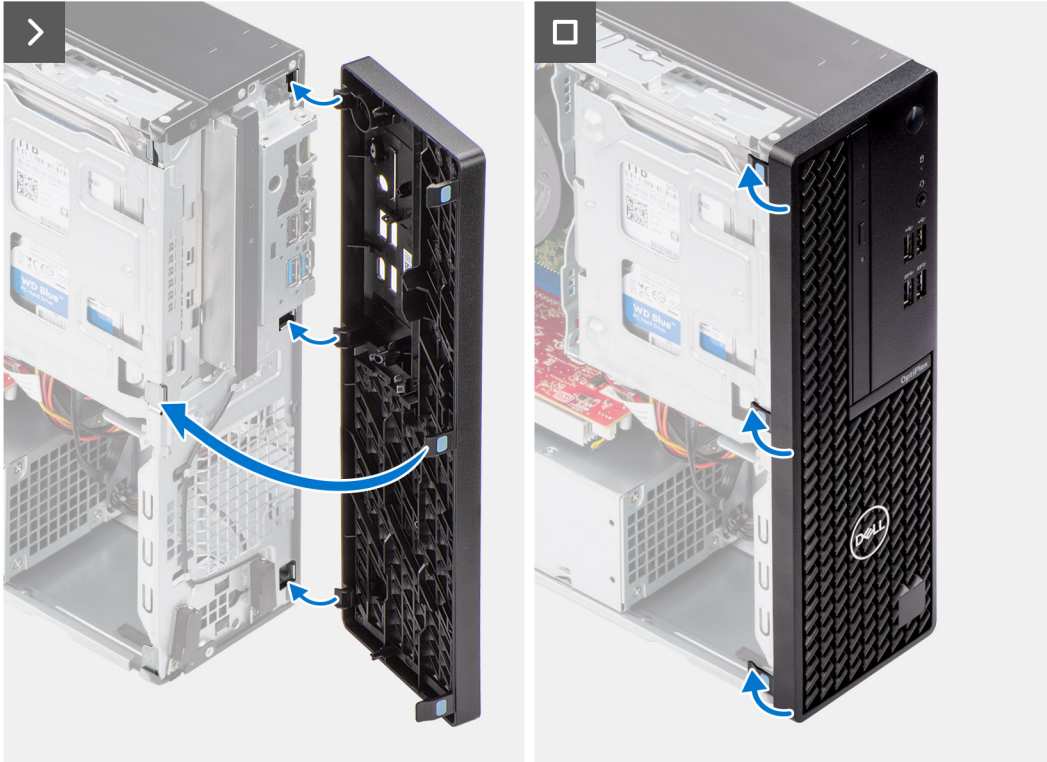

Steps

1. Align the front-cover tabs with the slots on the chassis.
2. Rotate the front cover towards the chassis and snap it into place.

Next steps

1. Install the [side cover](#).
2. Follow the procedure in [After working inside your computer](#).

Hard drive

2.5-inch hard drive

Removing the 2.5-inch hard drive

Prerequisites

1. Follow the procedure in [Before working inside your computer](#).
2. Remove the [side cover](#).

About this task

The following image indicates the location of the 2.5-inch hard-drive assembly and provide a visual representation of the removal procedure.



1x
6-32

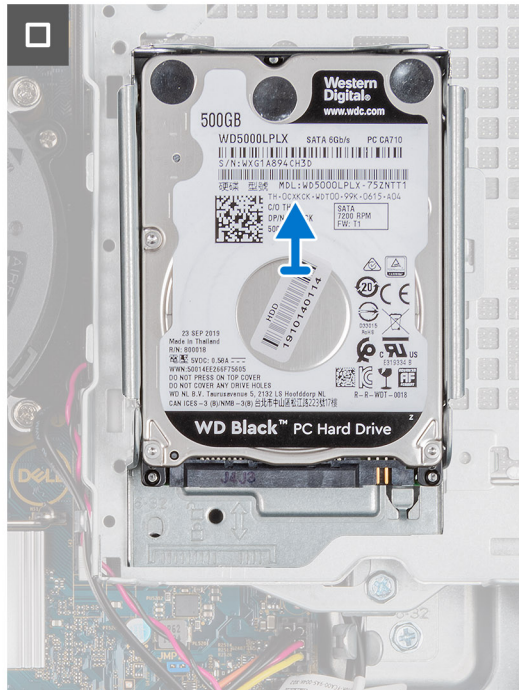
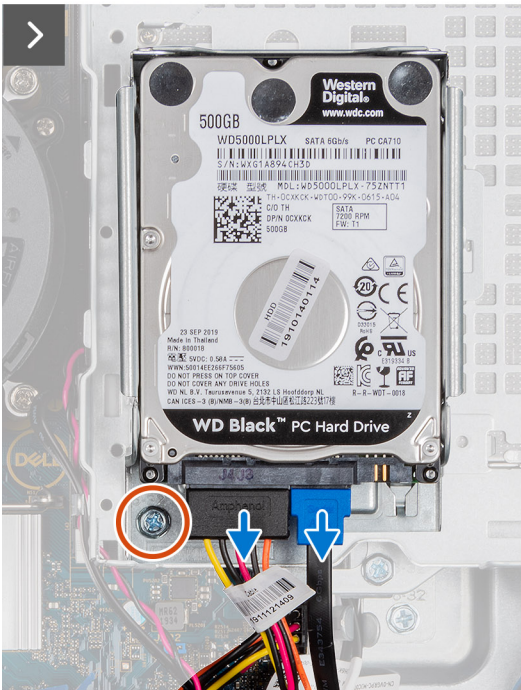

4x
M3x3.5

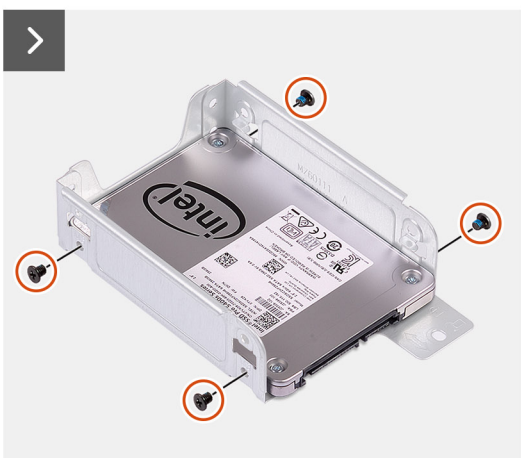

Steps

1. Disconnect the data and power cables from the hard drive.

2. Remove the screw (#6-32) that secures the hard drive carrier to the chassis.
3. Remove the four screws (M3x3.5) that secure the hard drive to the hard-drive carrier.
4. Slide and lift the 2.5-inch hard drive off the hard-drive carrier.

i **NOTE:** Note the orientation or the SATA connector marking on the hard-drive carrier so that you can replace it correctly.

Installing the 2.5-inch hard drive

Prerequisites

If you are replacing a component, remove the existing component before performing the installation procedure.

About this task

The following image indicates the location of the 2.5-inch hard drive and provides a visual representation of the installation procedure.



4x
M3x3.5



1x
6-32

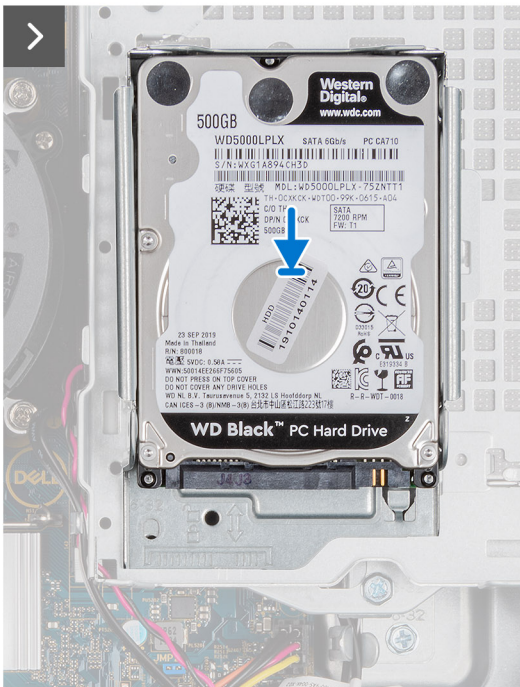

Steps

1. Insert and align the hard drive into the hard-drive carrier.
2. Replace the four screws (M3x3) that secure the hard drive to the hard-drive carrier.
3. Align the tabs on the hard-drive carrier with the slots on the chassis and snap the hard-drive carrier into place.

4. Replace the screw (#6-32) to secure the hard-drive carrier to the chassis.
5. Connect the data and power cables to the connectors on the hard drive.

Next steps

1. Install the [side cover](#).
2. Follow the procedure in [After working inside your computer](#).

3.5-inch hard drive

Removing the 3.5-inch hard drive

Prerequisites

1. Follow the procedure in [Before working inside your computer](#).
2. Remove the [side cover](#).

About this task

The following image indicates the location of the 3.5-inch hard-drive assembly and provide a visual representation of the removal procedure.



2x
6-32

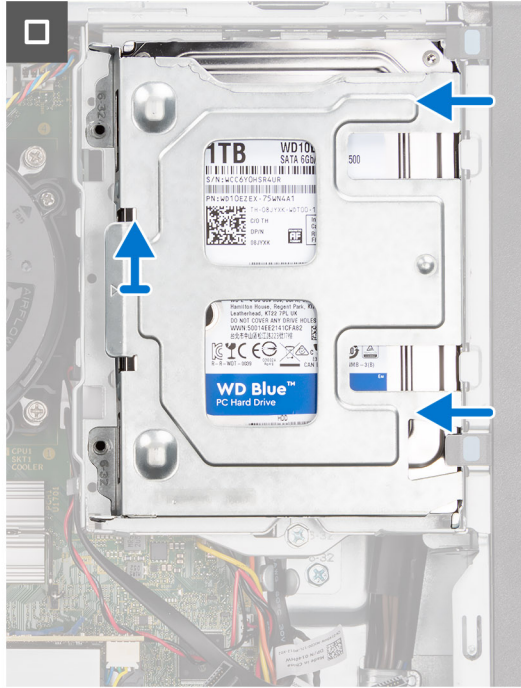
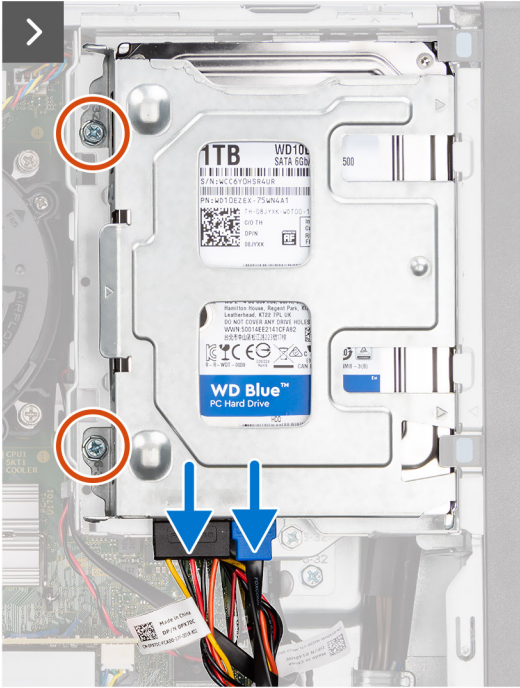
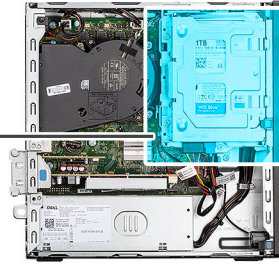

2x
6-32

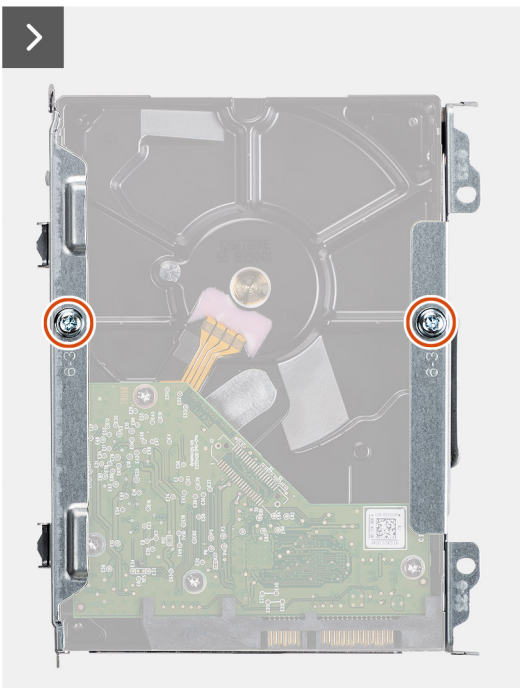

Steps

1. Disconnect the data and power cables from the hard drive.
2. Remove the two screws (6-32) that secure the hard-drive carrier to the chassis.
3. Slide the hard-drive carrier away from the chassis and lift hard-drive carrier out of the disk-drive cage.
4. Remove the two screws (6-32) that secure the hard drive to the hard-drive carrier.
5. Slide and remove the hard drive from the hard-drive carrier.

Installing the 3.5-inch hard drive

Prerequisites

If you are replacing a component, remove the existing component before performing the installation procedure.

About this task

The following image indicates the location of the 3.5-inch hard drive and provide a visual representation of the installation procedure.



2x
6-32

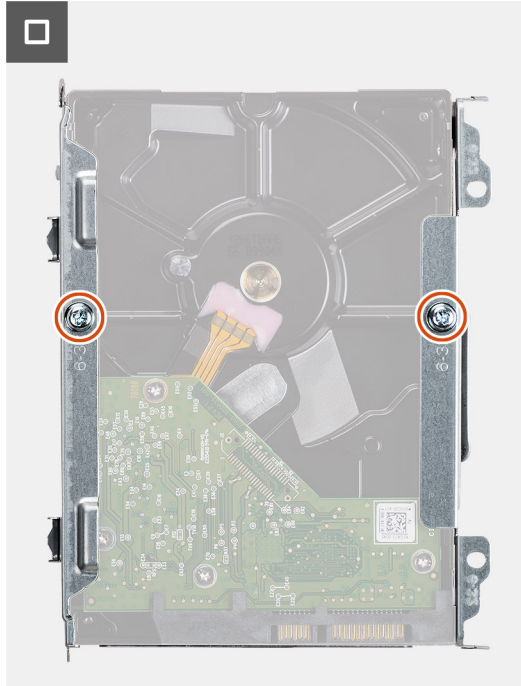
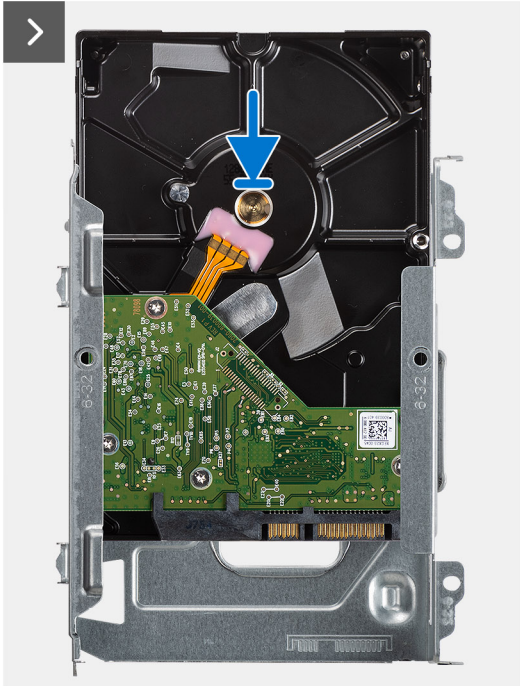

2x
6-32

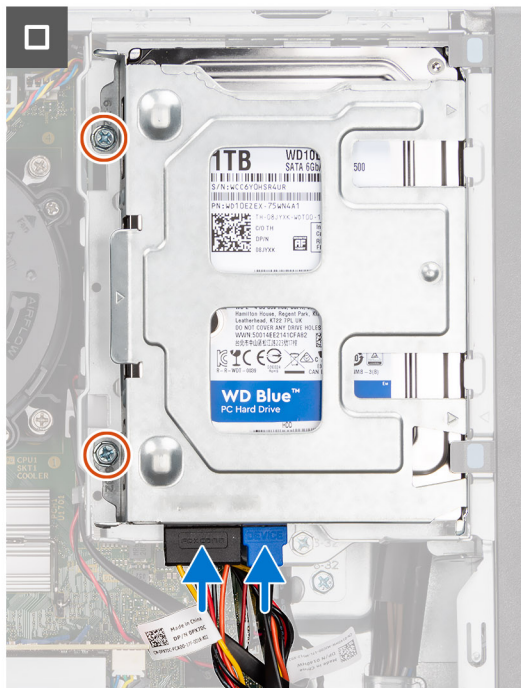
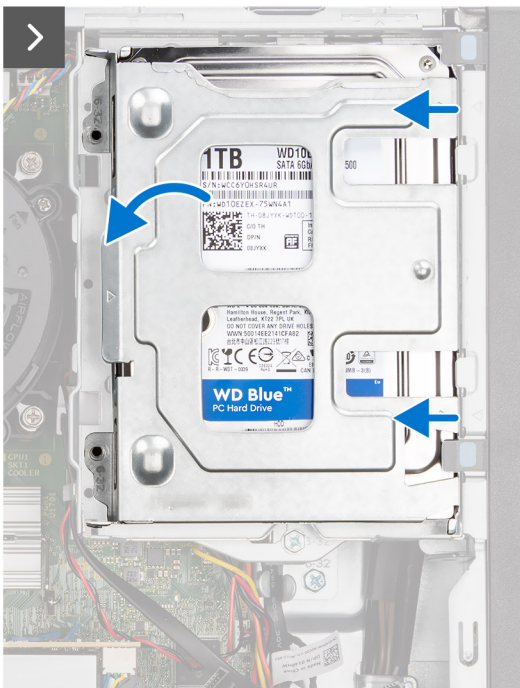

Steps

1. Slide the hard drive into the hard-drive carrier.
2. Replace the two screws (6-32) to secure the hard drive to the hard-drive carrier.
3. Align the tabs on the hard-drive carrier with the slots on the chassis and snap the hard-drive carrier onto the disk-drive cage.
4. Replace the two screws (6-32) to secure the hard drive carrier on the chassis.
5. Connect the data and power cables to the connectors on the hard drive.

Next steps

1. Install the [side cover](#).
2. Follow the procedure in [After working inside your computer](#).

Disk-drive cage

Removing the disk-drive cage

Prerequisites

1. Follow the procedure in [Before working inside your computer](#).
2. Remove the [side cover](#).
3. Remove the [front bezel](#).
4. Remove the [2.5-inch hard drive](#) if applicable.
5. Remove the [3.5-inch hard drive](#) if applicable.

About this task

The following image indicates the location of the disk-drive cage and provides a visual representation of the removal procedure.



1x
6-32

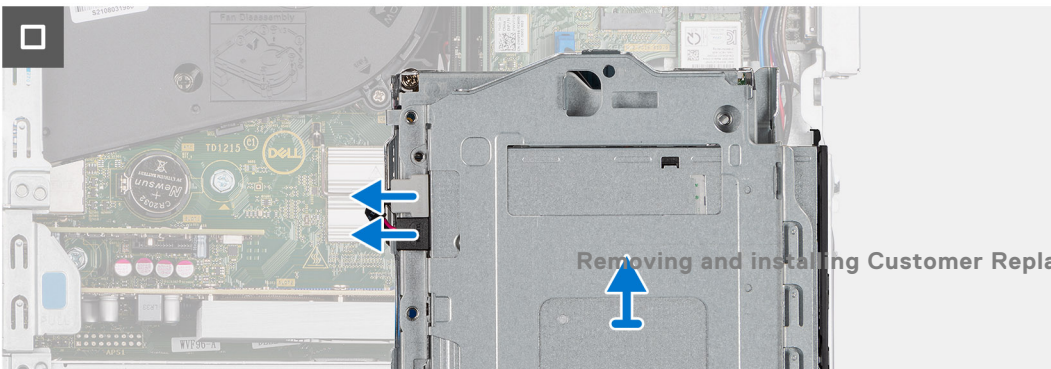
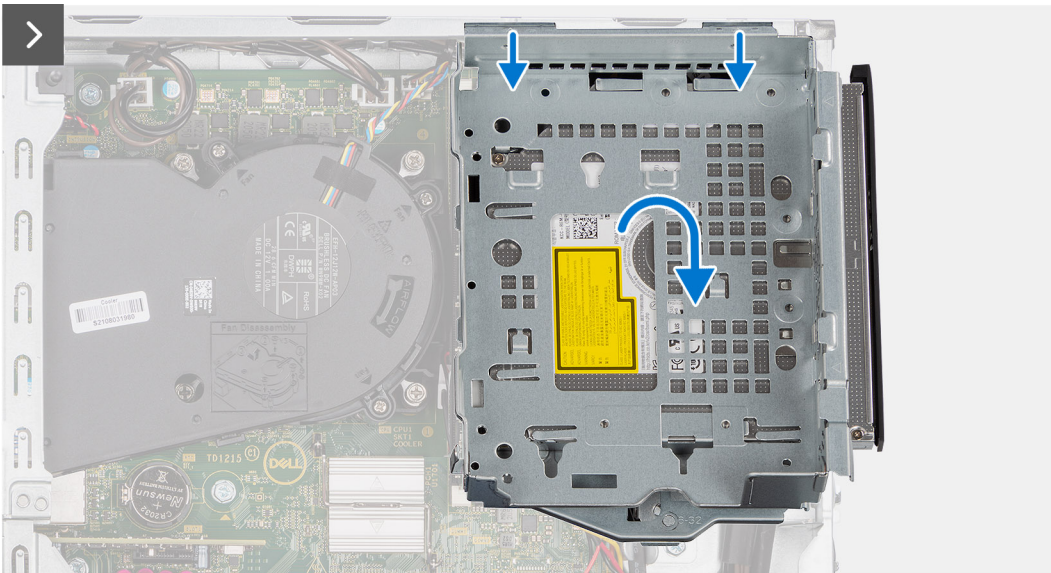
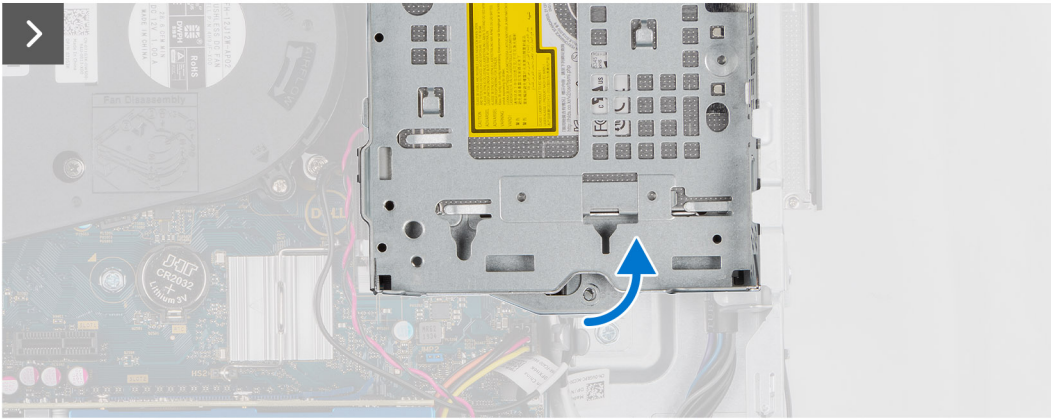
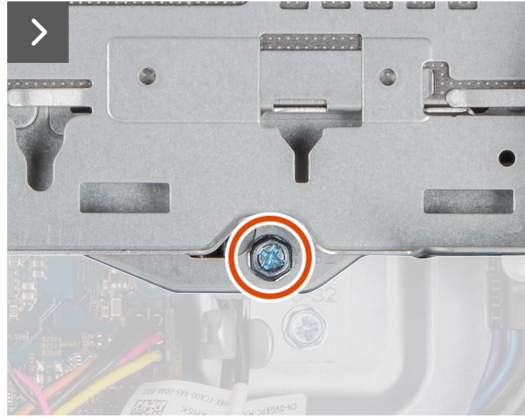
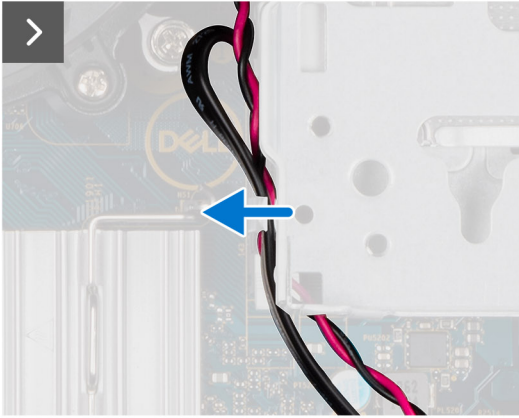

Steps

1. If the optical drive is installed, remove the data and power cables from the routing points on the disk-drive cage.
2. Remove the single (6-32) screw to release the disk-drive cage from the chassis..
3. Lift the disk-drive and detach it from the mounting points on the chassis.
4. Rotate the drive-cage and place it on the chassis.
5. If the optical drive is installed, disconnect the power and data cables from the connectors on the optical drive.
6. Lift the disk-drive cage away from the computer.

Installing the disk-drive cage

Prerequisites

If you are replacing a component, remove the existing component before performing the installation procedure.

About this task

The following images indicate the location of the disk-drive cage and provides a visual representation of the installation procedure.



1x
6-32

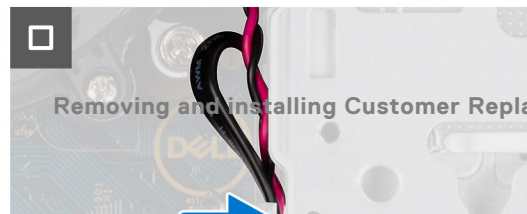
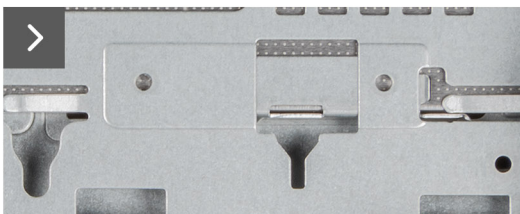
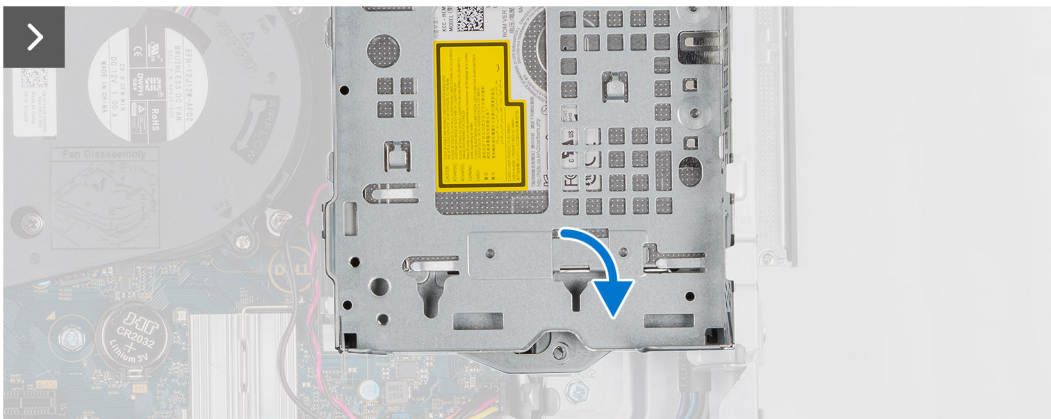
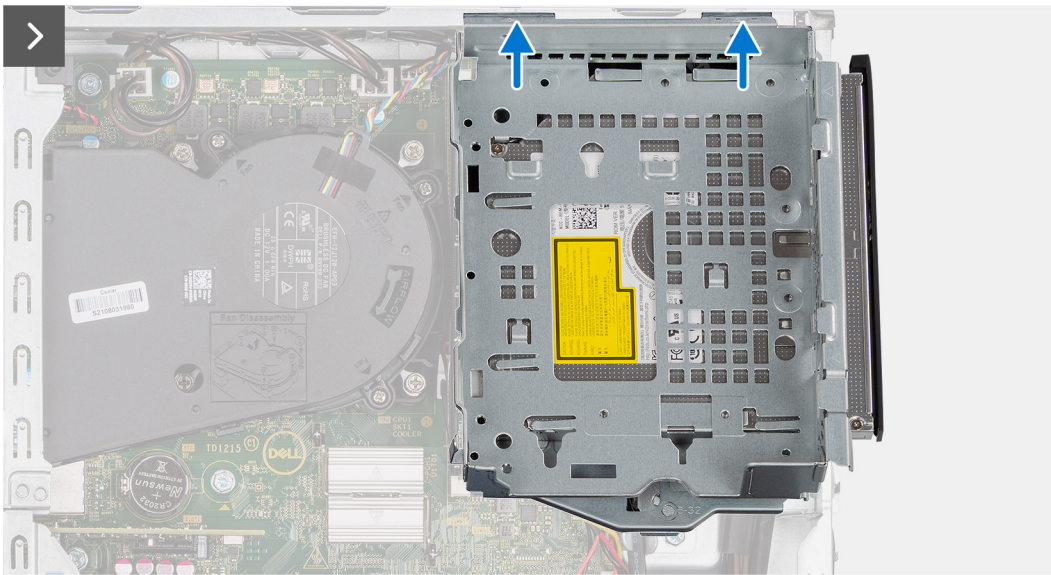
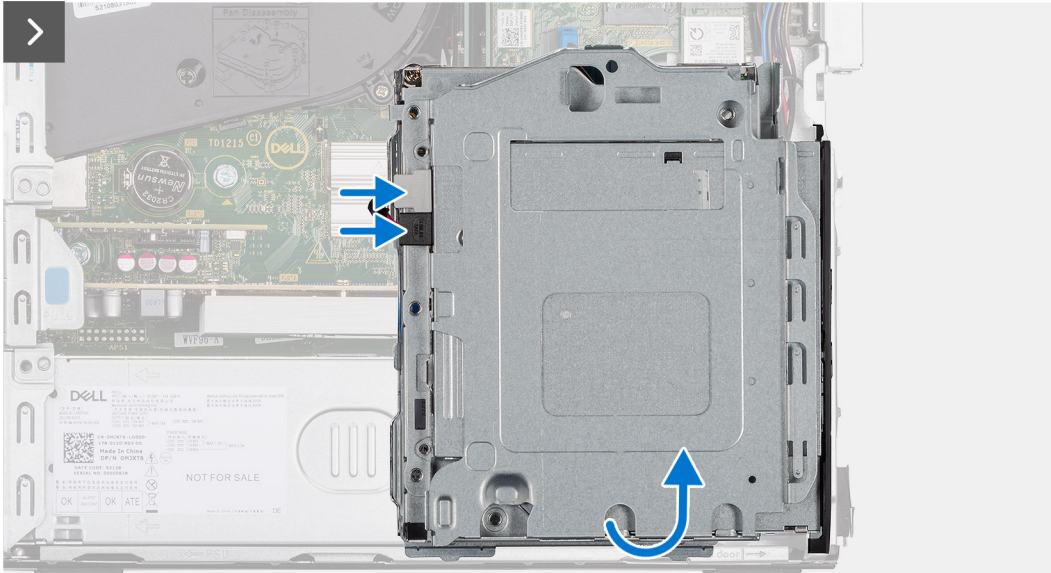

Steps

1. Place the disk-drive cage upside down on the chassis.
2. If the optical drive is installed, connect the data and power cable to the connectors on the optical drive.
3. Hold the disk-drive cage upright and align the mounting points on the disk-drive cage with the slots on the chassis.
4. Align the screw hole on the cage with the screw hole on the chassis.
5. Install the single (6-32) screw to secure the disk-drive cage in place.
6. If the optical drive is installed, route the power and data cables through the routing guide on the disk-drive cage.

Next steps

1. Install the [3.5-inch hard drive](#) if applicable.
2. Install the [2.5-inch hard drive](#) if applicable.
3. Install the [front bezel](#).
4. Install the [side cover](#).
5. Follow the procedure in [After working inside your computer](#).

Optical drive

Removing the optical drive

Prerequisites

1. Follow the procedure in [Before working inside your computer](#).
2. Remove the [side cover](#).
3. Remove the [front bezel](#).
4. Remove the [2.5-inch hard drive](#) if applicable.
5. Remove the [3.5-inch hard drive](#) if applicable.
6. Remove the [disk-drive cage](#).

About this task

The following image indicates the location of the optical-drive assembly and provides a visual representation of the removal procedure.



1x
M2x2

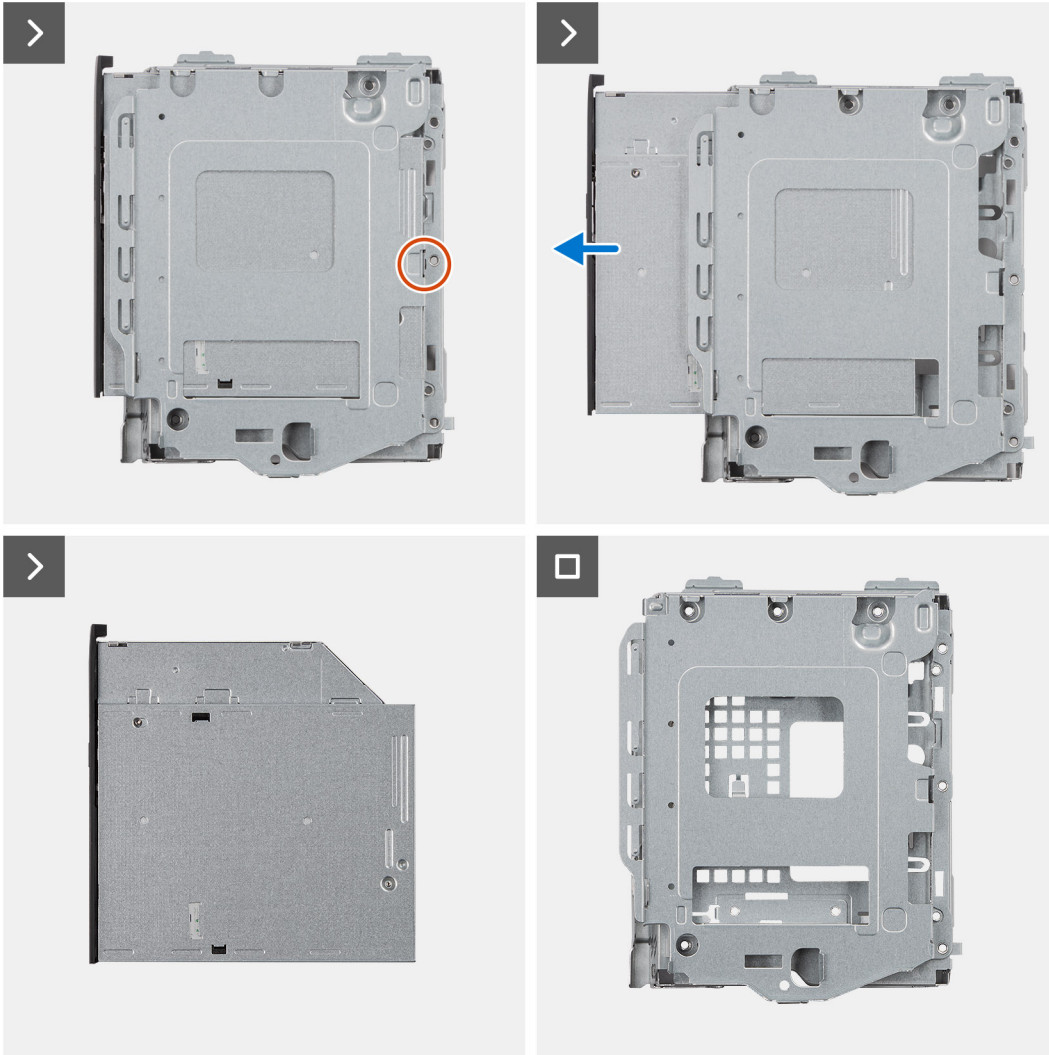

Steps

1. Remove the single (M2x2) screw to release the optical drive from the disk-drive cage.
2. Slide the optical drive out of the disk-drive cage.

Installing the optical drive

Prerequisites

If you are replacing a component, remove the existing component before performing the installation procedure.

About this task

The following image indicates the location of the optical drive and provides a visual representation of the installation procedure.



1x
M2x2

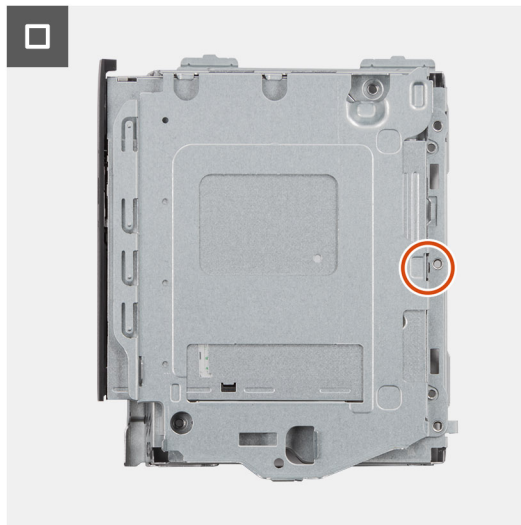
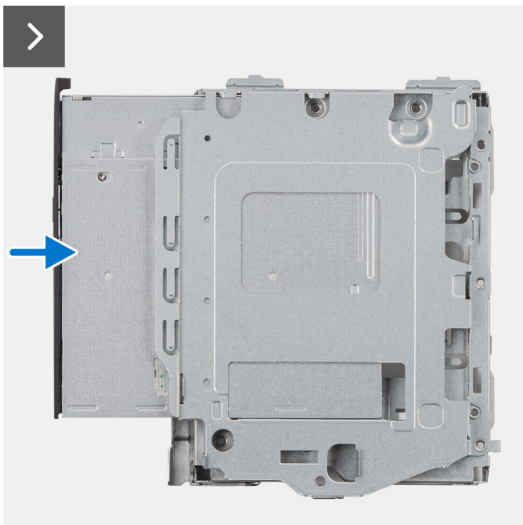

Steps

1. Slide the optical drive into the disk-drive cage until it snaps into place.
2. Install the single (M2x2) screw to secure the optical drive from the disk-drive cage.

Next steps

1. Install the [3.5-inch hard drive](#) if applicable.
2. Install the [2.5-inch hard drive](#) if applicable.
3. Install the [disk-drive cage](#).
4. Install the [front bezel](#).
5. Install the [side cover](#).
6. Follow the procedure in [After working inside your computer](#).

Memory

Removing the memory

Prerequisites

1. Follow the procedure in [Before working inside your computer](#).
2. Remove the [side cover](#).
3. Remove the [front bezel](#).
4. Remove the [2.5-inch hard drive](#) if applicable.
5. Remove the [3.5-inch hard drive](#) if applicable.
6. Remove the [disk-drive cage](#).

About this task

The following image indicates the location of the memory modules and provides a visual representation of the removal procedure.

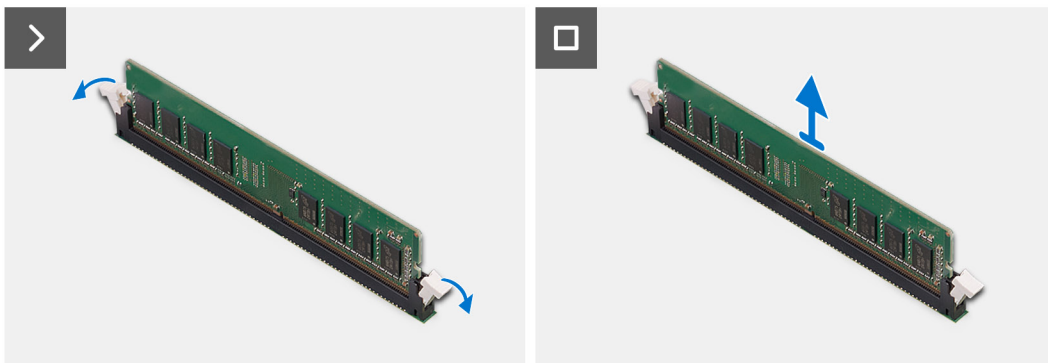
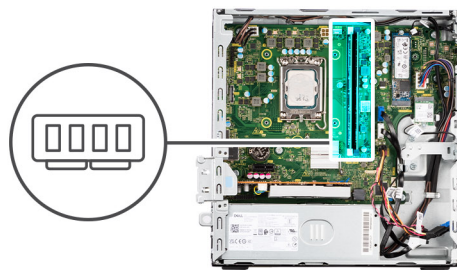

Steps

1. Use your fingertips to carefully spread apart the securing-clips on each end of the memory-module slot.
2. Grasp the memory module near the securing clip, and then gently ease the memory module out of the memory-module slot.

CAUTION: To prevent damage to the memory module, hold the memory module by the edges. Do not touch the components on the memory module.

NOTE: Repeat step 1 to step 2 to remove any other memory modules installed in your computer.

NOTE: Note the slot and the orientation of the memory module in order to replace it in the correct slot.

NOTE: If the memory module is difficult to remove, gently ease the memory module back and forth to remove it from the slot.

Installing the memory

Prerequisites

If you are replacing a component, remove the existing component before performing the installation procedure.

About this task

The following image indicates the location of the memory modules and provides a visual representation of the installation procedure.

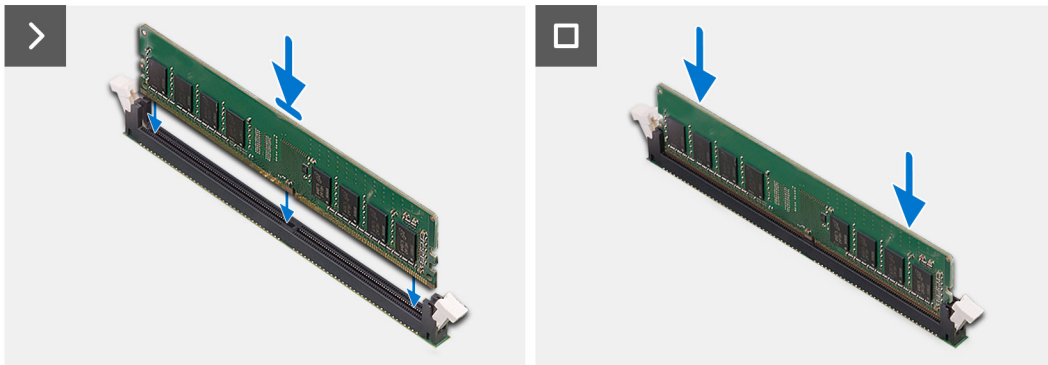
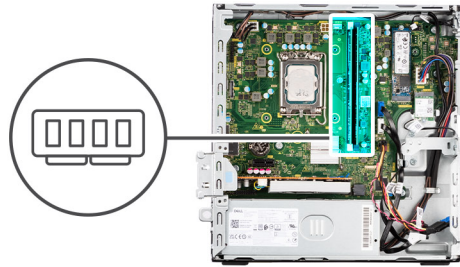

Steps

1. Ensure that the securing clips are in an open position.
2. Align the notch on the memory module with the tab on the memory-module slot.
3. Press down on the memory module until the memory module snaps into position and the securing clip locks in place.

CAUTION: To prevent damage to the memory module, hold the memory module by the edges. Do not touch the components on the memory module.

NOTE: Repeat step 1 to step 3 to install more than one memory module in your computer.

Next steps

1. Install the [disk-drive cage](#).
2. Install the [3.5-inch hard drive](#) if applicable.
3. Install the [2.5-inch hard drive](#) if applicable.
4. Install the [front bezel](#).
5. Install the [side cover](#).
6. Follow the procedure in [After working inside your computer](#).

Solid-state drives

Solid-state drive (half-length)

Removing the M.2 2230 solid-state drives

Prerequisites

1. Follow the procedure in [Before working inside your computer](#).
2. Remove the [side cover](#).
3. Remove the [front bezel](#).
4. Remove the [2.5-inch hard drive](#) if applicable.
5. Remove the [3.5-inch hard drive](#) if applicable.
6. Remove the [disk-drive cage](#).

About this task

The following image indicates the location of the M.2 2230 solid-state drives and provides a visual representation of the removal procedure.

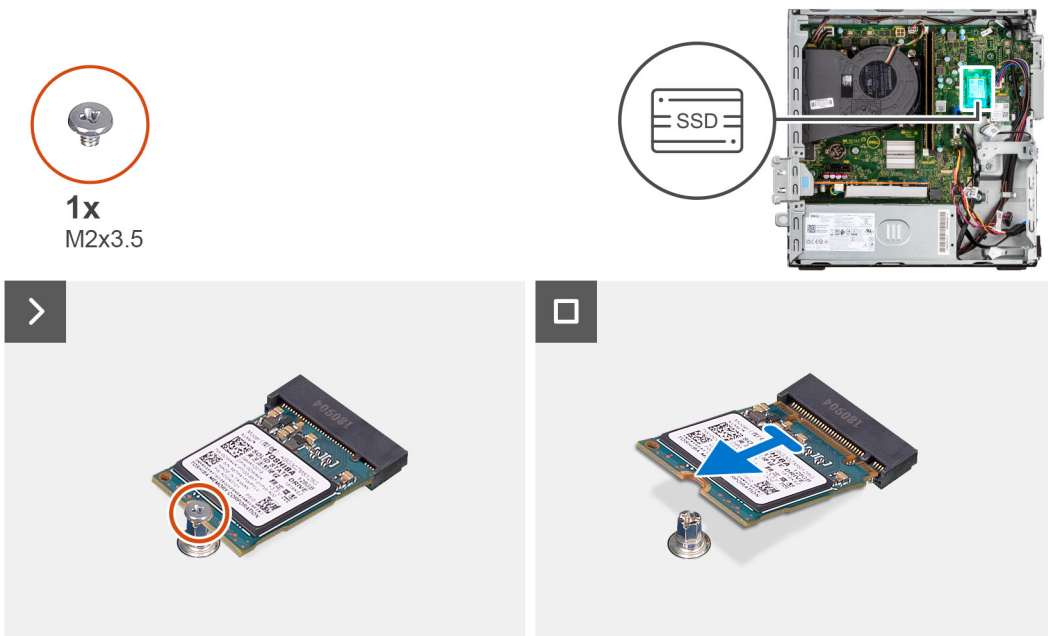

Steps

1. Remove the screw (M2x3.5) that secures the M.2 2230 solid-state drive to the system board.
2. Slide and lift the M.2 2230 solid-state drive from the M.2 card slot on the system board.

Installing the M.2 2230 solid-state drives

Prerequisites

If you are replacing a component, remove the existing component before performing the installation procedure.

About this task

NOTE: If you are replacing a M.2 2280 solid-state drive with a M.2 2230 solid-state drive, ensure the M.2 2280 solid-state drive is removed first.

NOTE: The following image indicates the location to install the solid-state drive screw mount based on form factor.



The following image indicates the location of the M.2 2230 solid-state drives and provides a visual representation of the installation procedure.

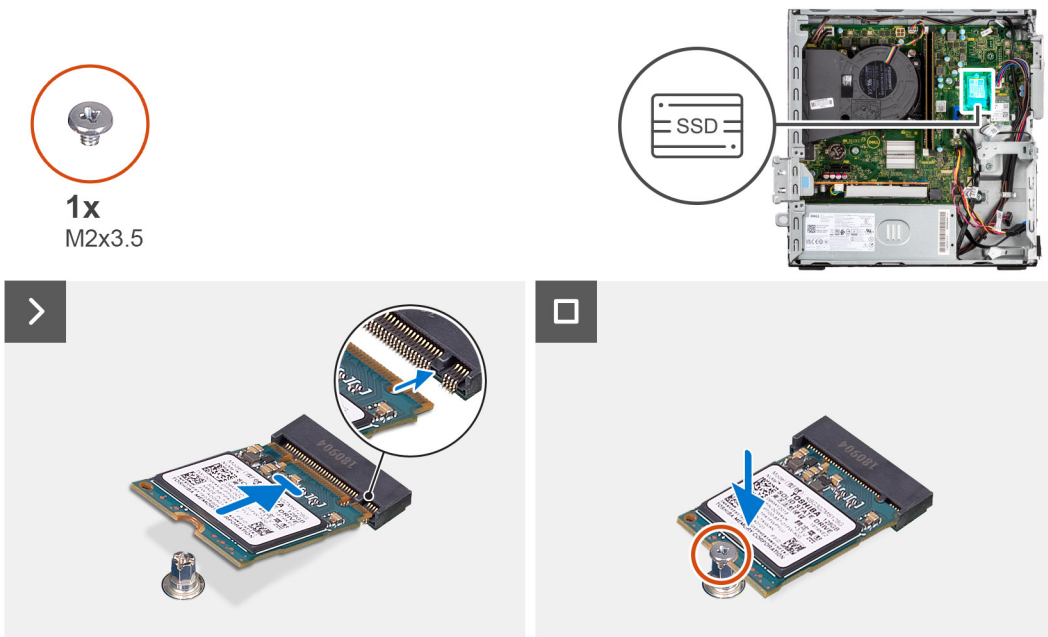

Steps

1. Peel off the protection film on the thermal pad and align and adhere the thermal pad on the M.2 2230 solid-state drive slot on the system board.

NOTE: The thermal pad is re-usable. The thermal pad is pre-installed on systems shipped with solid-state drive. If the solid-state drive is purchased separately, the thermal pad is not bundled with the solid-state drive kit and is to be purchased separately.

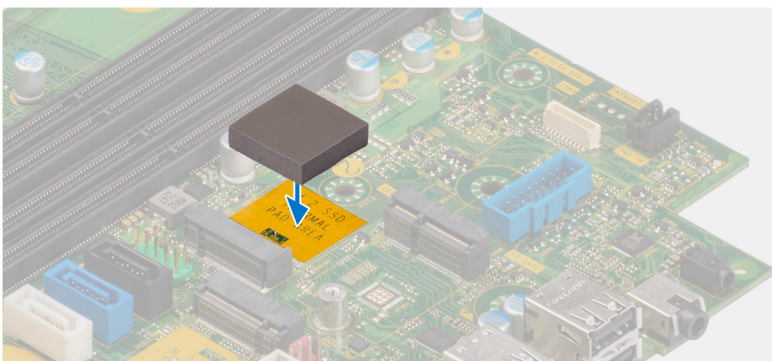

2. Peel off the protective Mylar on the thermal pad.
3. Align the notch on the M.2 2230 solid-state drive with the tab on the M.2 card slot on the system board.
4. Slide the M.2 2230 solid-state drive into the M.2 card slot on the system board.
5. Replace the screw (M2x3.5) to secure the M.2 2230 solid-state drive to the system board.

Next steps

1. Install the [disk-drive cage](#).
2. Install the [3.5-inch hard drive](#) if applicable.
3. Install the [2.5-inch hard drive](#) if applicable.
4. Install the [front bezel](#).
5. Install the [side cover](#).
6. Follow the procedure in [After working inside your computer](#).

Solid-state drive (full-length)

Removing the M.2 2280 solid-state drive

Prerequisites

1. Follow the procedure in [Before working inside your computer](#).
2. Remove the [side cover](#).
3. Remove the [front bezel](#).
4. Remove the [2.5-inch hard drive](#) if applicable.
5. Remove the [3.5-inch hard drive](#) if applicable.
6. Remove the [disk-drive cage](#).

About this task

The following image indicates the location of the M.2 2280 solid-state drive and provides a visual representation of the removal procedure.



1x
M2x3.5

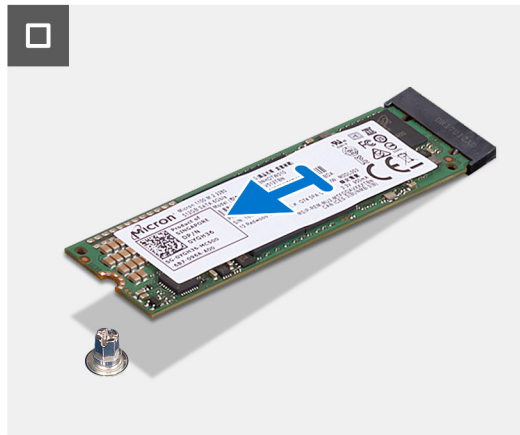
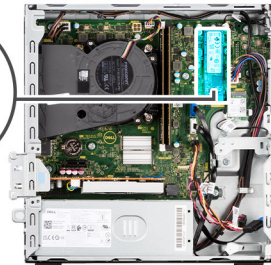

Steps

1. Remove the screw (M2x3.5) that secures the M.2 2280 solid-state drive to the system board.

- Slide and lift the M.2 2280 solid-state drive from the M.2 card slot on the system board.

Installing the M.2 2280 solid-state drive

Prerequisites

If you are replacing a component, remove the existing component before performing the installation procedure.

About this task

- NOTE:** If you are replacing a M.2 2230 solid-state drive with a M.2 2280 solid-state drive, ensure the M.2 2230 solid-state drive is removed first.
- NOTE:** The following image indicates the location to install the solid-state drive screw mount based on form factor.

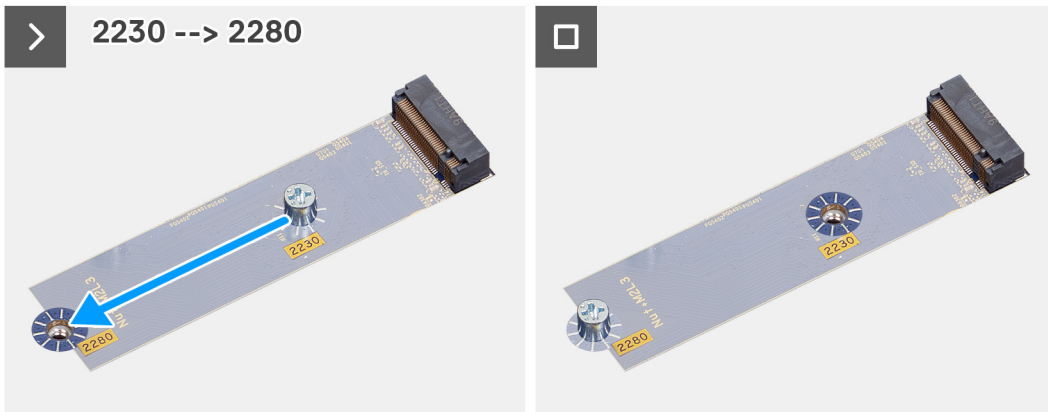

The following image indicates the location of the M.2 2280 solid-state drive and provides a visual representation of the installation procedure.



Steps

- Peel off the protection film on the thermal pad and align and adhere the thermal pad on the M.2 2230 solid-state drive slot on the system board.

NOTE: The thermal pad is re-usable. The thermal pad is pre-installed on systems shipped with solid-state drive. If the solid-state drive is purchased separately, the thermal pad is not bundled with the solid-state drive kit and is to be purchased separately.

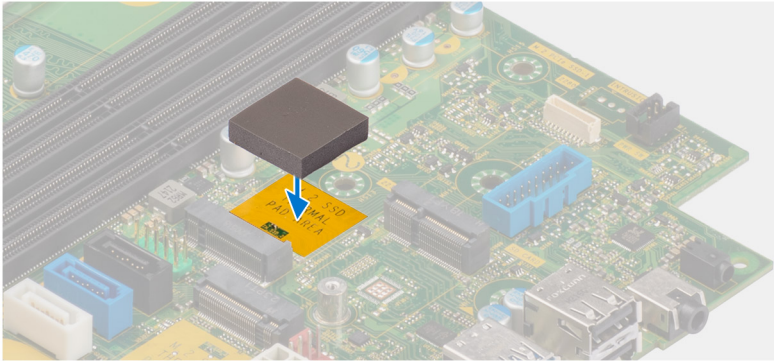

2. Peel off the protection mylar on the thermal pad.
3. Align the notch on the M.2 2280 solid-state drive with the tab on the M.2 card slot on the system board.
4. Slide the M.2 2280 solid-state drive into the M.2 card slot on the system board.
5. Replace the screw (M2x3.5) to secure the M.2 2280 solid-state drive to the system board.

Next steps

1. Install the [disk-drive cage](#).
2. Install the [3.5-inch hard drive](#) if applicable.
3. Install the [2.5-inch hard drive](#) if applicable.
4. Install the [front bezel](#).
5. Install the [side cover](#).
6. Follow the procedure in [After working inside your computer](#).

Dell Ultra Speed Drive Gen3 card

Removing Dell Ultra Speed Drive Gen3 card

Prerequisites

1. Follow the procedure in [before working inside your computer](#).

About this task

The following images indicate the location of the Dell Ultra Speed Drive Gen3 card and provide a visual representation of the removal procedure.

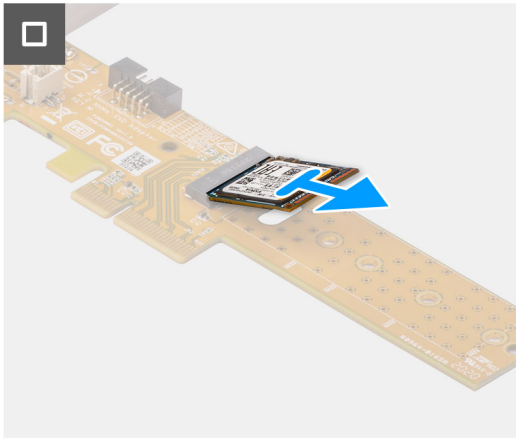
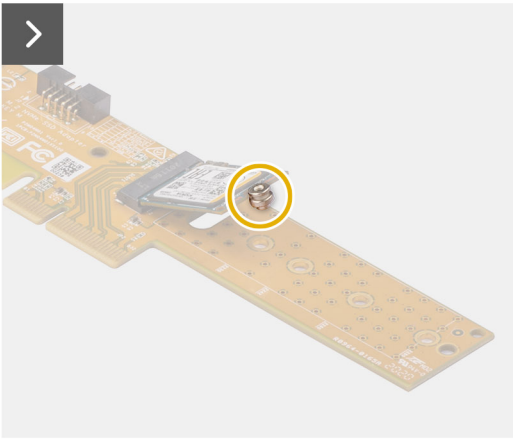
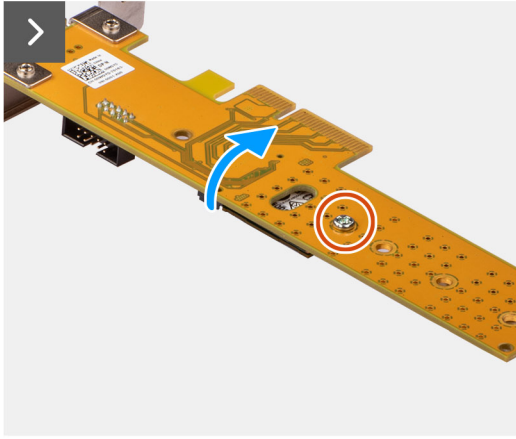
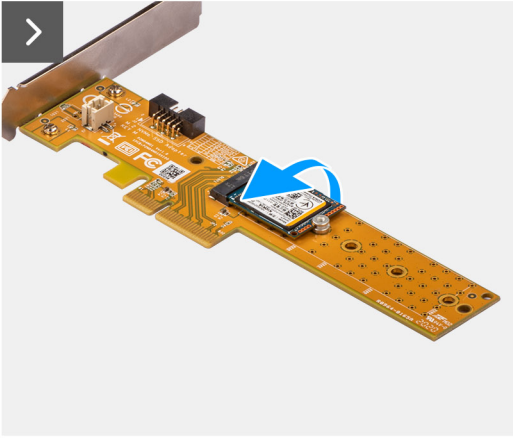
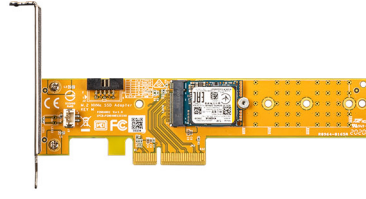

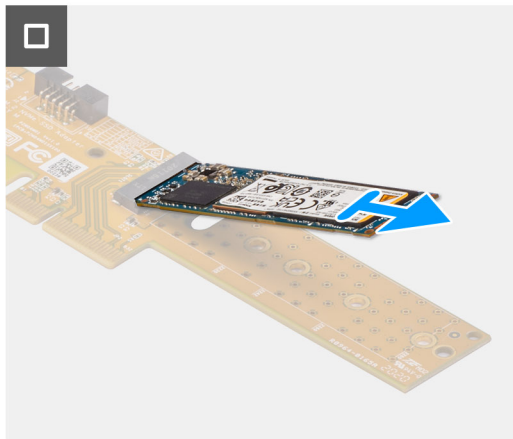
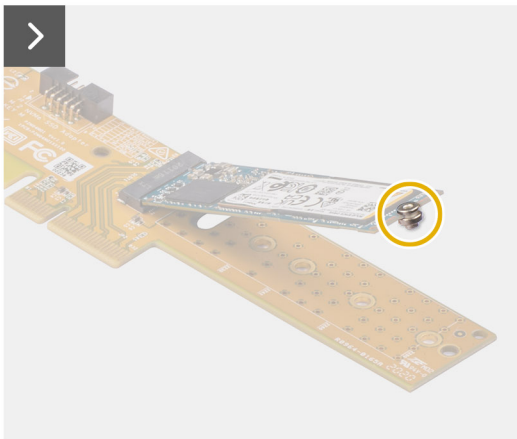
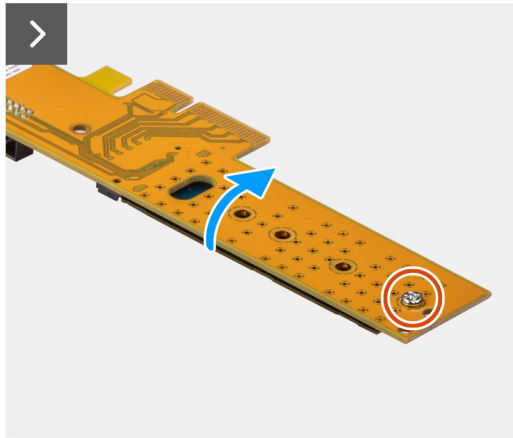
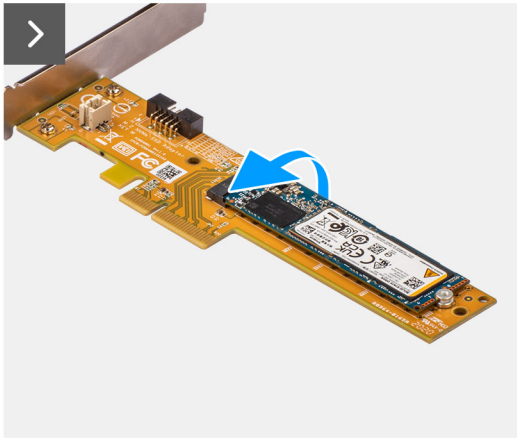
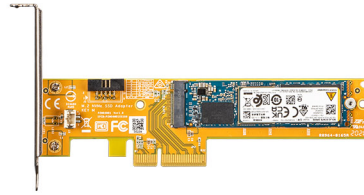

Steps

1. Pull the tab to open the PCIe door.
2. Press down on the release tab and lift the Dell Ultra Speed Drive Gen3 card off the system board.
3. Turn the Dell Ultra Speed Drive Gen3 card over.
4. Remove the (M2x5) screw that secures the M.2 2230 or 2280 Solid-state drive to the Dell Ultra Speed Drive Gen3 card.
5. Turn the Dell Ultra Speed Drive Gen3 card over.
6. Remove the M.2 Solid-state drive standoff nut from the M.2 2230 or 2280 Solid-state drive.
7. Slide the M.2 2230 or 2280 solid state drive out of the M.2 2230 or 2280 slot on the Dell Ultra Speed Drive Gen3 card.

Installing the Dell Ultra Speed Drive Gen3 card

About this task

The following image provides a visual representation of the Dell Ultra Speed Drive Gen3 card installation procedure.

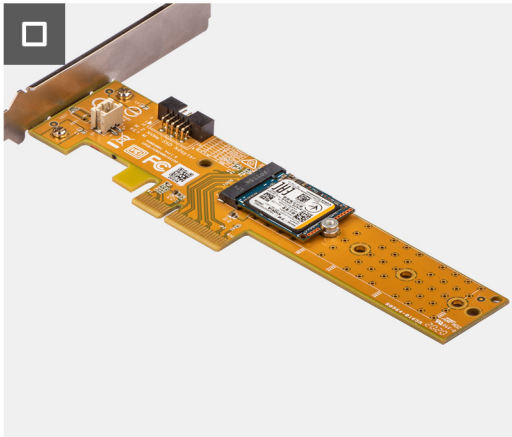
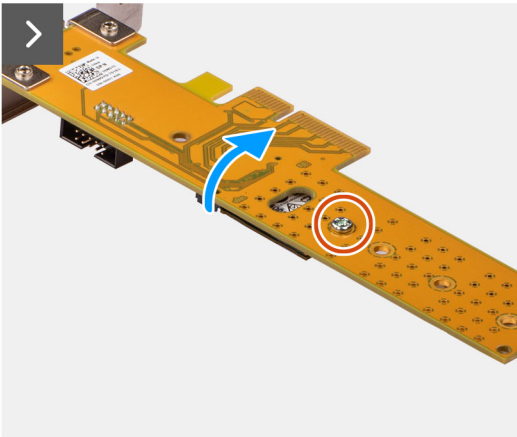
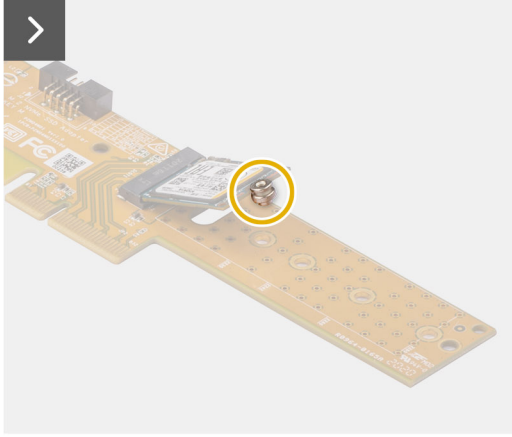
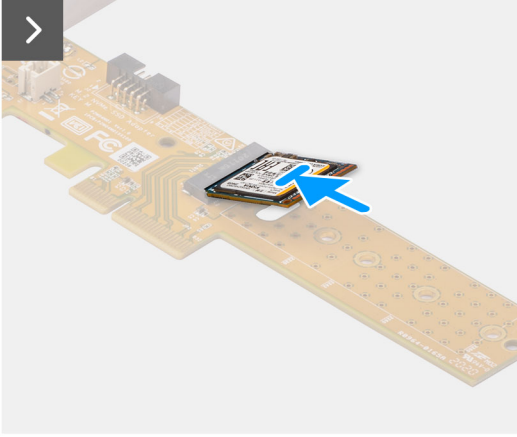
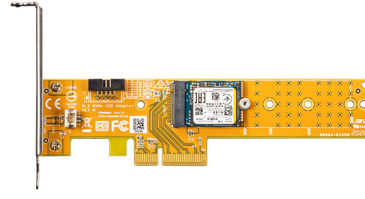

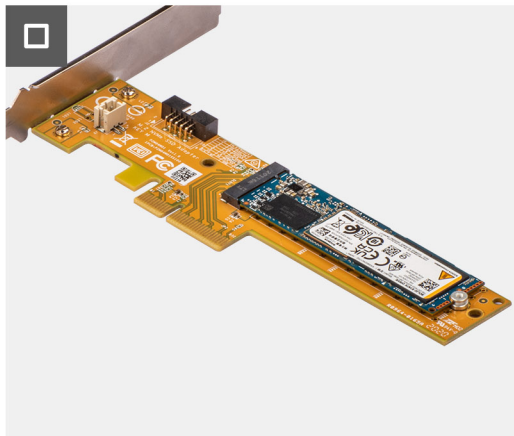
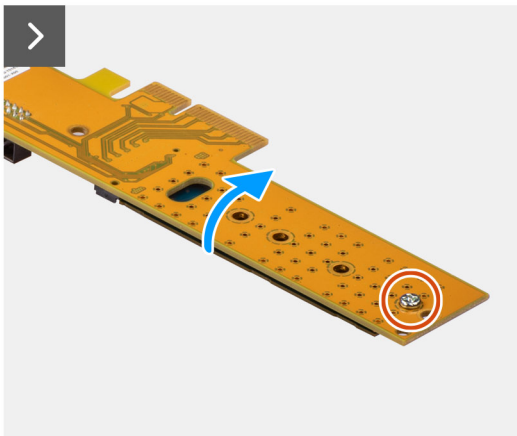
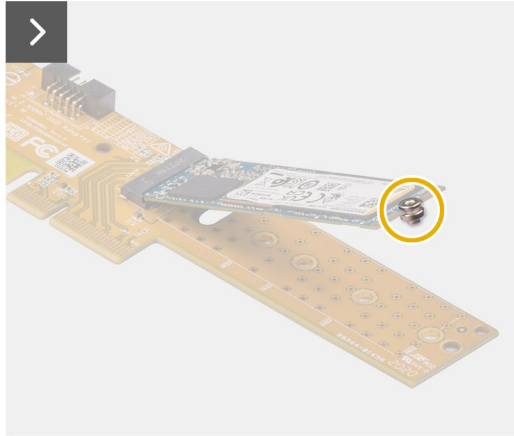
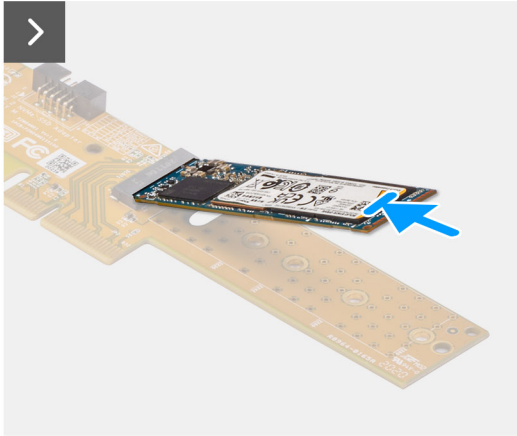
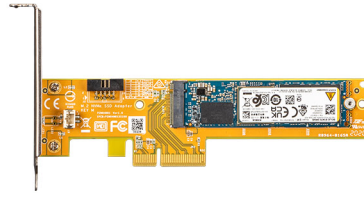

Steps

1. Slide the M.2 2230 or 2280 Solid-state drive into the M.2 2230 or 2280 slot on the Dell Ultra Speed Drive Gen3 card.
2. Install the M.2 Solid-state drive standoff nut on to the M.2 2230 or 2280 Solid-state drive.
3. Align the screw holes on the standoff nut with screw holes on the Dell Ultra Speed Drive Gen3 card.
4. Turn the Dell Ultra Speed Drive Gen3 card over.
5. Install the (M2x5) screw that secures the M.2 2230 or 2280 Solid-state drive to the Dell Ultra Speed Drive Gen3 card.
6. Turn the Dell Ultra Speed Drive Gen3 card over.
7. **i** **NOTE:** The Dell Ultra Speed Drive Gen3 card must be installed in the PCIe x16 slot.

Align the Dell Ultra Speed Drive Gen3 card with the PCIe slot on the system board.

8. Using the alignment post on the PCIe slot, insert the card into its connector and press down firmly.
9. Ensure that the card is firmly seated.
10. Close the PCIe door.

Next steps

1. Follow the procedure in [after working inside your computer](#).

Wireless card

Removing the wireless card

Prerequisites

1. Follow the procedure in [Before working inside your computer](#).
2. Remove the [side cover](#).
3. Remove the [front bezel](#).
4. Remove the [2.5-inch hard drive](#) if applicable.
5. Remove the [3.5-inch hard drive](#) if applicable.
6. Remove the [disk-drive cage](#).

About this task

The following image indicates the location of the wireless card and provides a visual representation of the removal procedure.



1x
M2x3.5

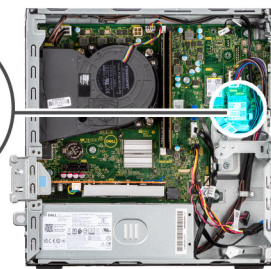

Steps

1. Remove the (M2x3.5) screw that secures the wireless card bracket to the system board.
2. Slide and lift the wireless card bracket away from the wireless card.
3. Disconnect the antenna cables from the wireless card.
4. Slide and remove the wireless card from the connector on the system board.

Installing the wireless card

Prerequisites

If you are replacing a component, remove the existing component before performing the installation procedure.

About this task

The following image indicates the location of the wireless card and provides a visual representation of the installation procedure.

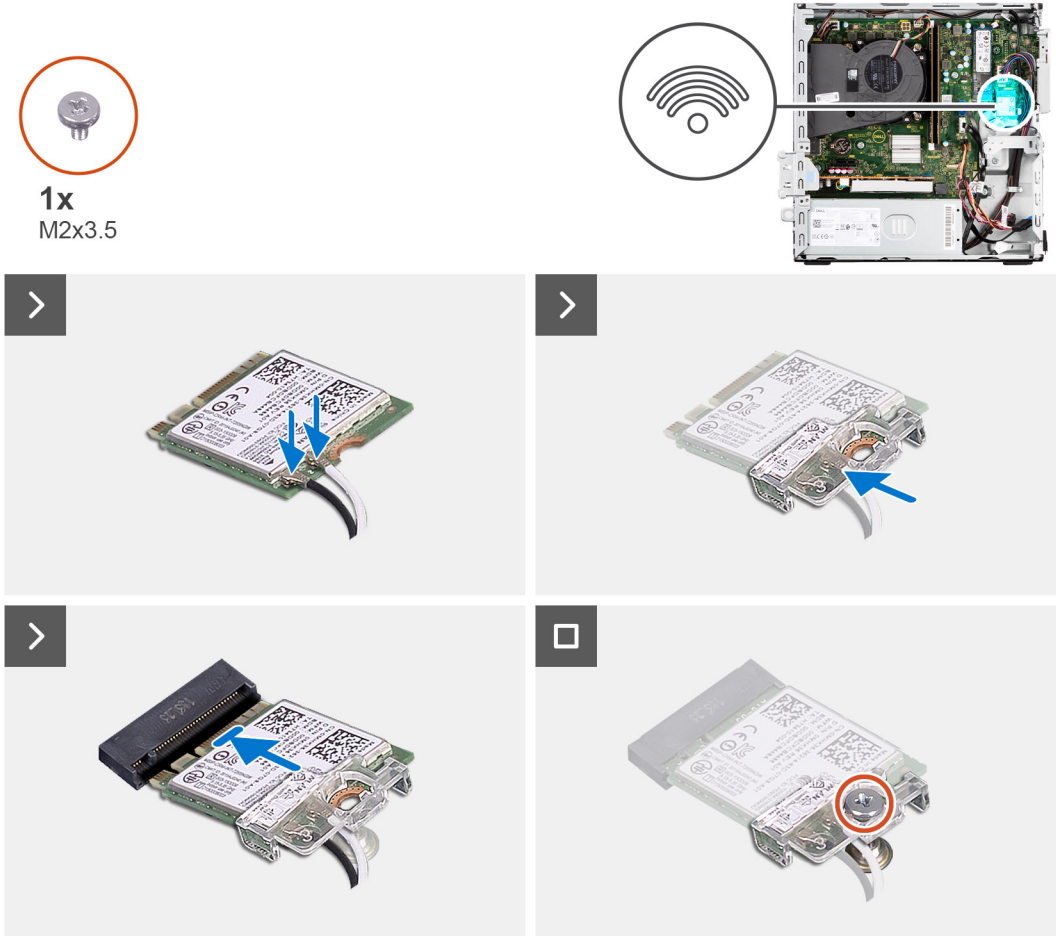

Steps

1. Connect the antenna cables to the wireless card.

The following table provides the antenna-cable color scheme for the wireless card of your computer.

Table 26. Antenna-cable color scheme

CONNECTORS ON THE WIRELESS CARD	ANTENNA-CABLE COLOR
Main (white triangle)	White
Auxiliary (black triangle)	Black

2. Slide and place the wireless-card bracket on the wireless card.
3. Align the notch on the wireless card with the tab on the wireless-card slot.
4. Slide the wireless card at an angle into the wireless-card slot.
5. Replace the screw (M2x3.5) to secure the wireless card to the system board.

Next steps

1. Install the [disk-drive cage](#).
2. Install the [3.5-inch hard drive](#) if applicable.
3. Install the [2.5-inch hard drive](#) if applicable.
4. Install the [front bezel](#).
5. Install the [side cover](#).
6. Follow the procedure in [After working inside your computer](#).

Expansion card

Removing the graphics card

Prerequisites

1. Follow the procedure in [Before working inside your computer](#).
2. Remove the [side cover](#).
3. Remove the [front bezel](#).
4. Remove the [2.5-inch hard drive](#) if applicable.
5. Remove the [3.5-inch hard drive](#) if applicable.
6. Remove the [disk-drive cage](#).

About this task

The following image indicates the location of the graphics card and provides a visual representation of the removal procedure.

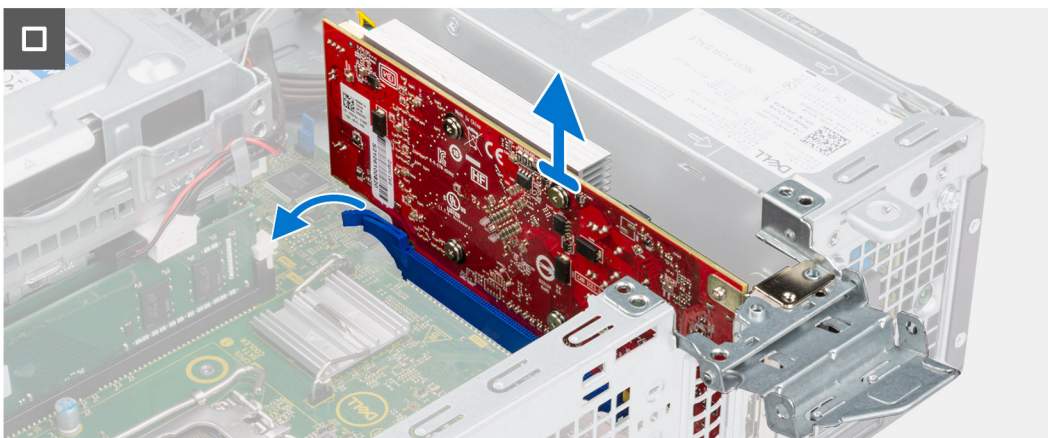
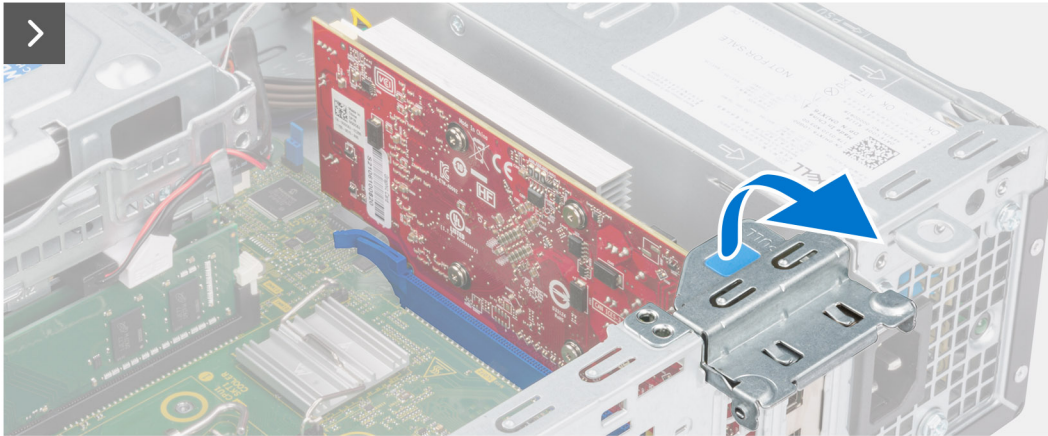

Steps

1. Pull to open the PCIe latch that secures the graphics card.
2. Push and hold the securing tab on the graphics-card slot and lift the graphics card from the graphics-card slot

Installing the graphics card

Prerequisites

If you are replacing a component, remove the existing component before performing the installation procedure.

About this task

The following image indicates the location of the graphics card and provides a visual representation of the installation procedure.

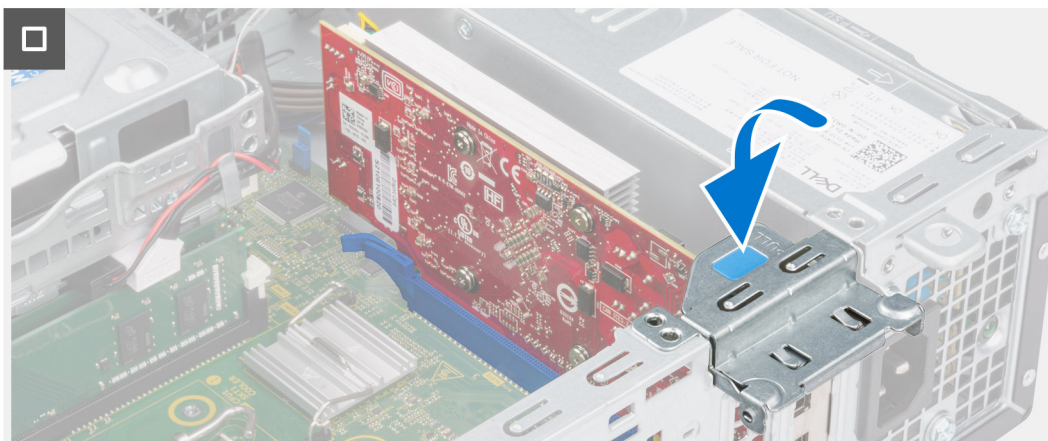
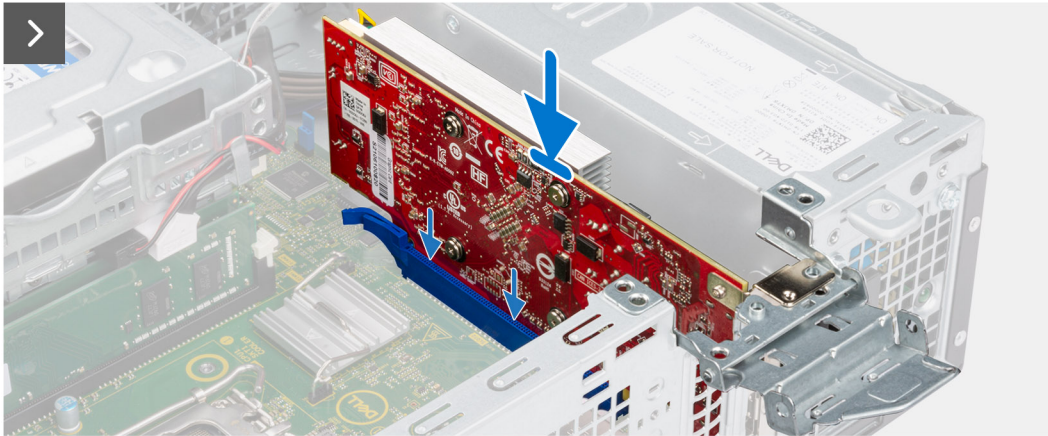
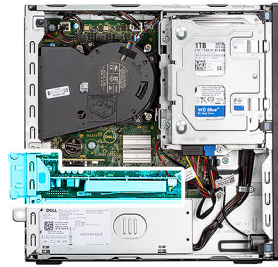

Steps

1. Align the graphics card with the connector on the system board.
2. Using the alignment post, connect the card in the connector and press down firmly. Ensure that the card is firmly seated.
3. Close the PCIe latch to secure the graphics card in the slot.

Next steps

1. Install the [disk-drive cage](#).
2. Install the [3.5-inch hard drive](#) if applicable.
3. Install the [2.5-inch hard drive](#) if applicable.
4. Install the [front bezel](#).
5. Install the [side cover](#).
6. Follow the procedure in [After working inside your computer](#).

Internal speaker

Removing the speaker

Prerequisites

1. Follow the procedure in [Before working inside your computer](#).
2. Remove the [side cover](#).

About this task

The following image indicates the location of the speaker and provides a visual representation of the removal procedure.

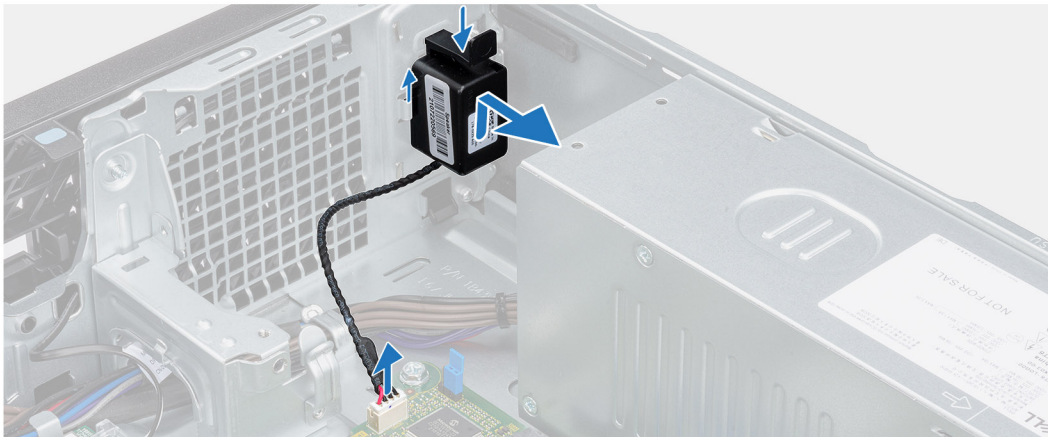
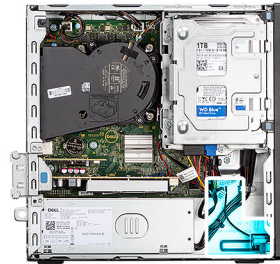

Steps

1. Disconnect the speaker cable from the connector on the system board.
2. Press the tab, lift and slide the speaker along with the cable from the slot on the chassis.

Installing the speaker

Prerequisites

If you are replacing a component, remove the existing component before performing the installation procedure.

About this task

The following image indicates the location of the speaker and provides a visual representation of the installation procedure.

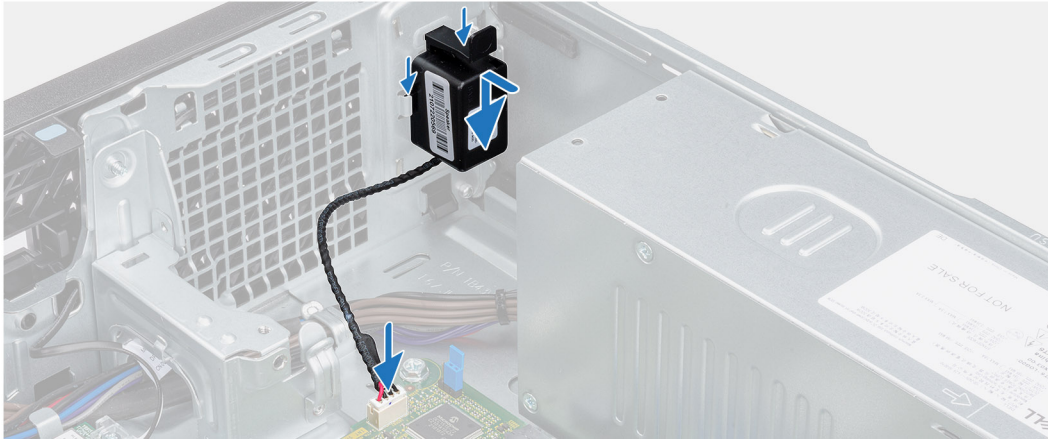

Steps

1. Press the tab on the speaker and slide the speaker into the slot on the chassis until it snaps into place.
2. Connect the speaker cable to the connector on the system board.

Next steps

1. Install the [side cover](#).
2. Follow the procedure in [After working inside your computer](#).

Coin-cell battery

Removing the coin-cell battery

Prerequisites

1. Follow the procedure in [Before working inside your computer](#).
2. Remove the [side cover](#).

About this task

The following image indicates the location of the coin-cell battery and provides a visual representation of the removal procedure.

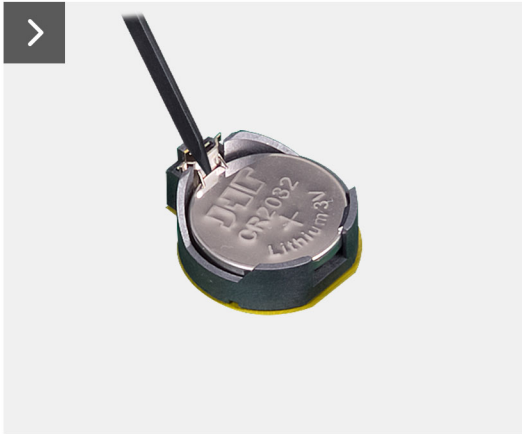
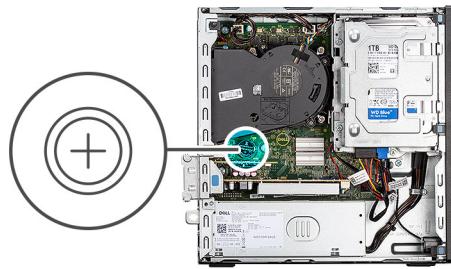

Steps

1. Push the coin-cell battery-release lever on the coin-cell battery socket to release the coin-cell battery out of the socket.
2. Remove the coin-cell battery.

Installing the coin-cell battery

Prerequisites

If you are replacing a component, remove the existing component before performing the installation procedure.

About this task

The following image indicates the location of the speaker and provides a visual representation of the installation procedure.

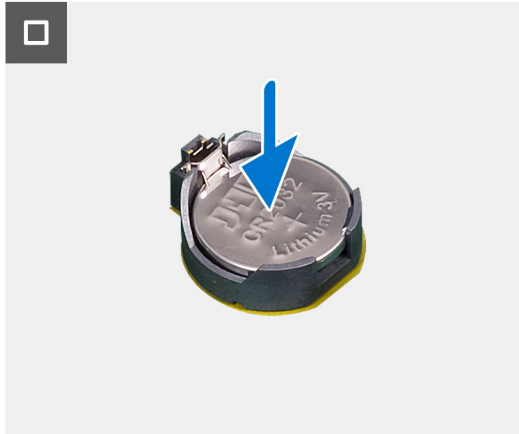
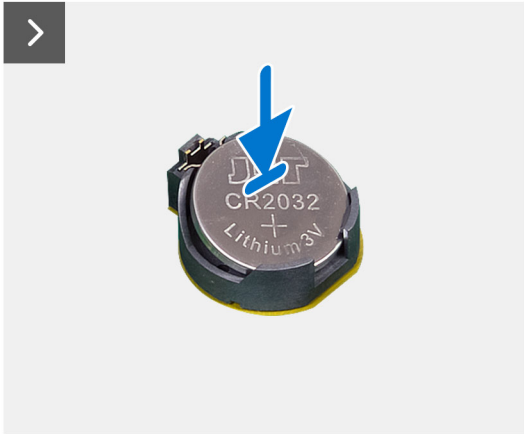
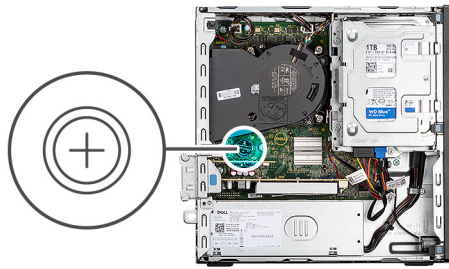

Steps

Insert the coin-cell battery into the socket with the positive side (+) label facing up and snap the battery in the socket.

Next steps

1. Install the [side cover](#).
2. Follow the procedure in [After working inside your computer](#).

Removing and installing Field Replaceable Units (FRUs)

The replaceable components in this chapter are Field Replaceable Units (FRUs).

CAUTION: The information in this section is intended for authorized service technicians only.

CAUTION: To avoid any potential damage to the component or loss of data, ensure that an authorized service technician replaces the Field Replaceable Units (FRUs).

CAUTION: Dell Technologies recommends that this set of repairs, if needed, to be conducted by trained technical repair specialists.

CAUTION: As a reminder, your warranty does not cover damages that may occur during the courses of FRU repairs that are not authorized by Dell Technologies.

NOTE: The images in this document may differ from your computer depending on the configuration you ordered.

Power button

Removing the power button

Prerequisites

1. Follow the procedure in [Before working inside your computer](#).
2. Remove the [side cover](#).

About this task

The following image indicates the location of the power button and provides a visual representation of the removal procedure.

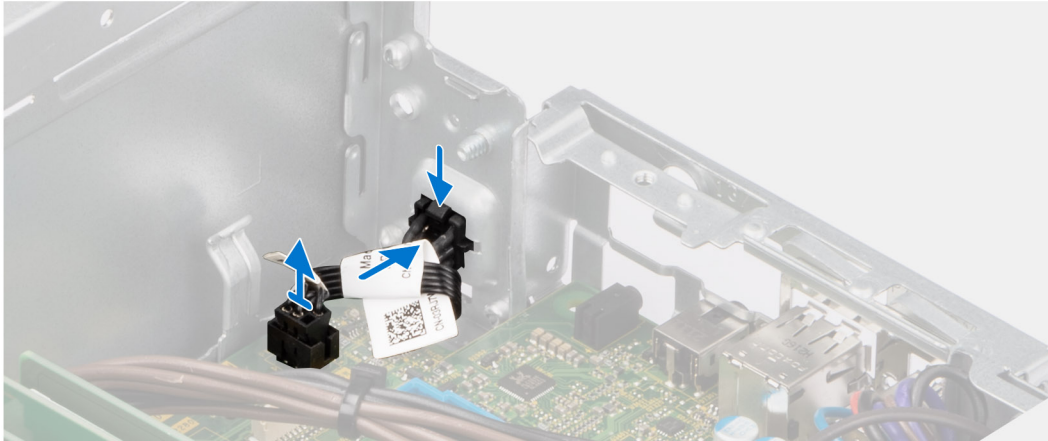
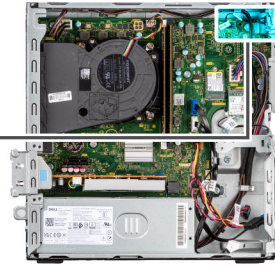

Steps

1. Disconnect the power button cable from the connector on the system board.
2. Slide and lift the power button away from the computer.

Installing the power button

Prerequisites

If you are replacing a component, remove the existing component before performing the installation procedure.

About this task

The following image indicates the location of the power button and provides a visual representation of the installation procedure.

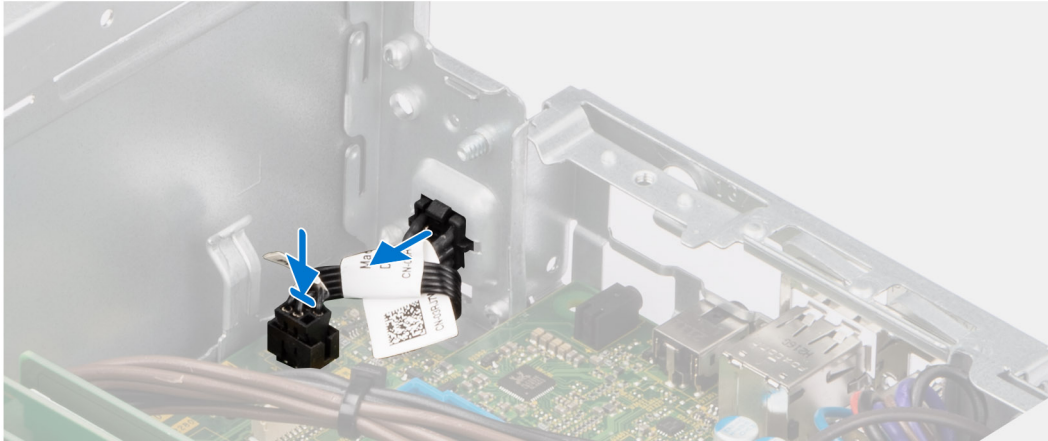
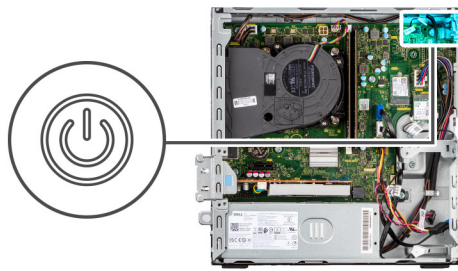

Steps

1. Slide the power button into the slot on the chassis.
2. Connect the power button cable to the connector on the system board.

Next steps

1. Install the [side cover](#).
2. Follow the procedure in [After working inside your computer](#).

Intrusion switch

Removing the intrusion switch

Prerequisites

1. Follow the procedure in [Before working inside your computer](#).
2. Remove the [side cover](#).

About this task

The following image indicates the location of the intrusion switch and provides a visual representation of the removal procedure.

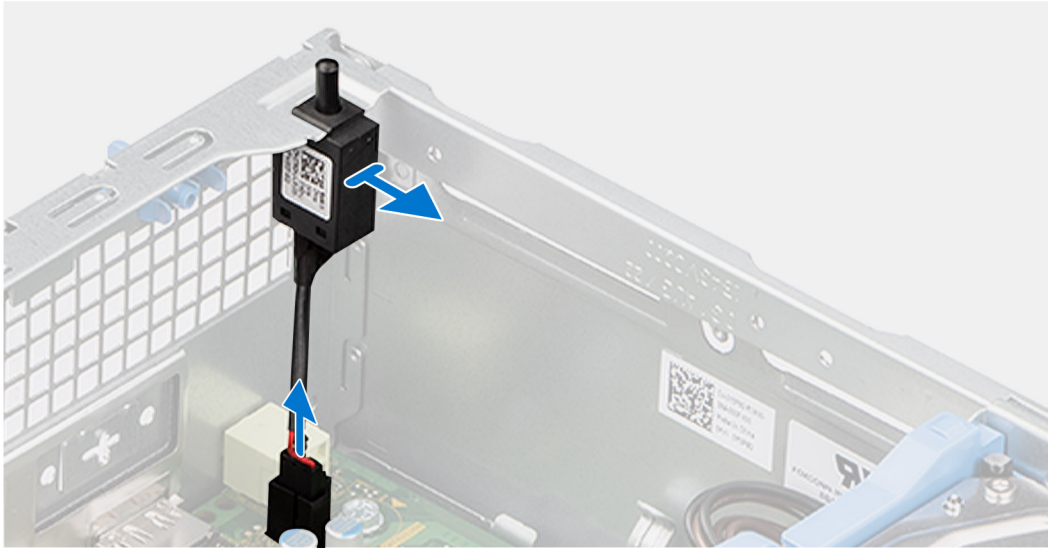

Steps

1. Remove the intrusion-switch cable from the routing guides on the chassis.
2. Disconnect the intrusion-switch cable from the connector on the system board.
3. Slide and lift the Intrusion switch away from the computer.

Installing the Intrusion switch

Prerequisites

If you are replacing a component, remove the existing component before performing the installation procedure.

About this task

The following image indicates the location of the Intrusion switch and provides a visual representation of the installation procedure.

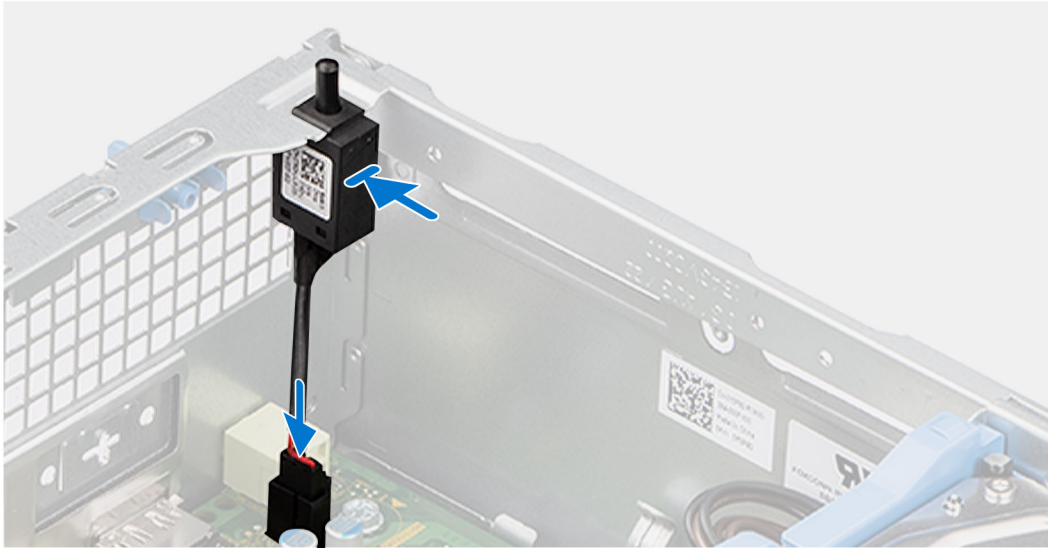
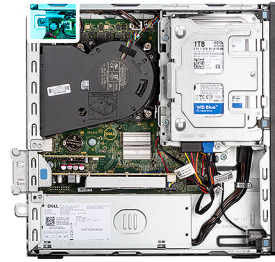

Steps

1. Slide the intrusion switch into the slot on the chassis.
2. Route the intrusion-switch cable through the routing guides on the chassis.
3. Connect the intrusion-switch cable to the connector on the system board.

Next steps

1. Install the [side cover](#).
2. Follow the procedure in [After working inside your computer](#).

Power-supply unit

Removing the power-supply unit

CAUTION: The information in this section is intended for authorized service technicians only.

Prerequisites

1. Follow the procedure in [Before working inside your computer](#).
2. Remove the [side cover](#).
3. Remove the [front bezel](#).
4. Remove the [2.5-inch hard drive](#) if applicable.
5. Remove the [3.5-inch hard drive](#) if applicable.
6. Remove the [disk-drive cage](#).

About this task

The following image indicates the location of the power-supply unit and provides a visual representation of the removal procedure.



3x
6-32

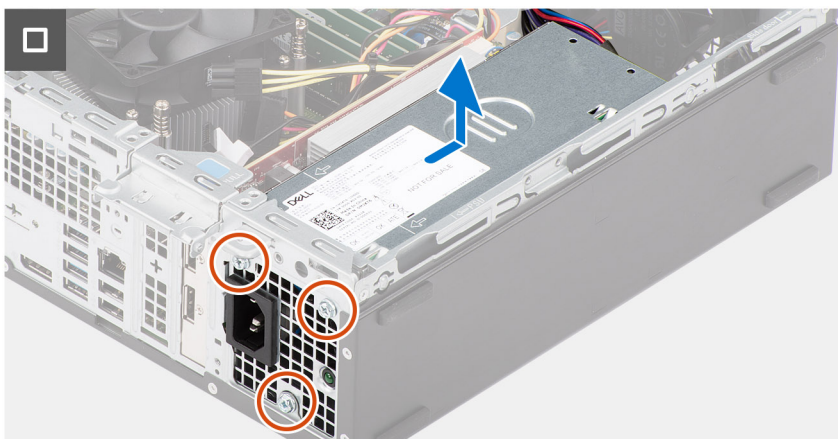
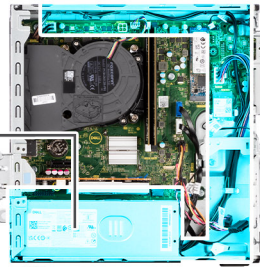
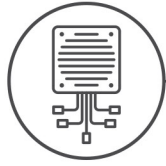

Steps

1. Disconnect the power-supply cables from their connectors on the system board.
2. Un-route the power-supply cables from the routing guides on the chassis.
3. Remove the three screws (M6-32) that secure the power-supply unit to the chassis.
4. Slide and lift the power-supply unit off the chassis.

Installing the power-supply unit

 **CAUTION:** The information in this section is intended for authorized service technicians only.

Prerequisites

If you are replacing a component, remove the existing component before performing the installation procedure.

About this task

The following image indicates the location of the power-supply unit and provides a visual representation of the installation procedure.



3x
6-32

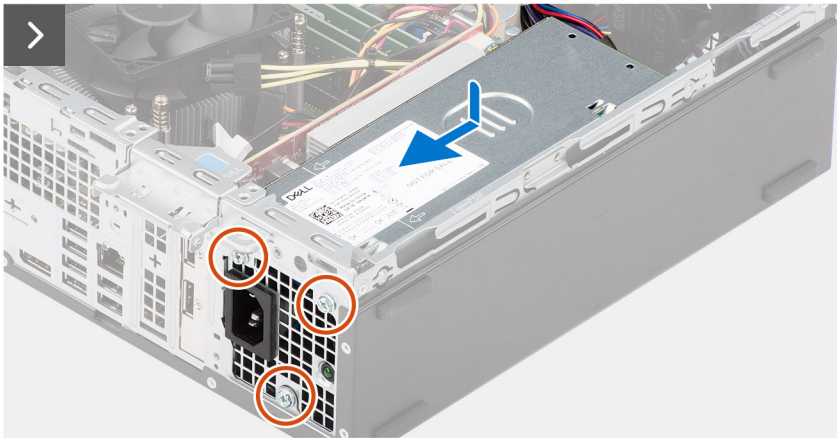
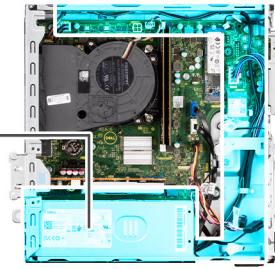
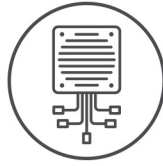

Steps

1. Place the power-supply unit on the chassis and slide it towards the back of the chassis.
2. Replace the three (M6-32) screws to secure the power-supply unit to the chassis.
3. Route the power-supply cables through their routing guides on the chassis.
4. Connect the power-supply cables to their connectors on the system board.

Next steps

1. Install the [disk-drive cage](#).
2. Install the [3.5-inch hard drive](#) if applicable.
3. Install the [2.5-inch hard drive](#) if applicable.
4. Install the [front bezel](#).
5. Install the [side cover](#).
6. Follow the procedure in [After working inside your computer](#).

Processor fan and heat-sink assembly

Removing the processor fan and heat-sink assembly

CAUTION: The information in this section is intended for authorized service technicians only.

Prerequisites

1. Follow the procedure in [Before working inside your computer](#).
2. Remove the [side cover](#).
3. Remove the [front bezel](#).
4. Remove the [2.5-inch hard drive](#) if applicable.
5. Remove the [3.5-inch hard drive](#) if applicable.
6. Remove the [disk-drive cage](#).

About this task

The following image indicates the location of the processor fan and heat-sink assembly and provides a visual representation of the removal procedure.

CAUTION: For maximum cooling of the processor, do not touch the heat transfer areas on the heat sink. The oils in your skin can reduce the heat transfer capability of the thermal grease.

NOTE: The heat sink may become hot during normal operation. Allow sufficient time for the heat sink to cool before you touch it.

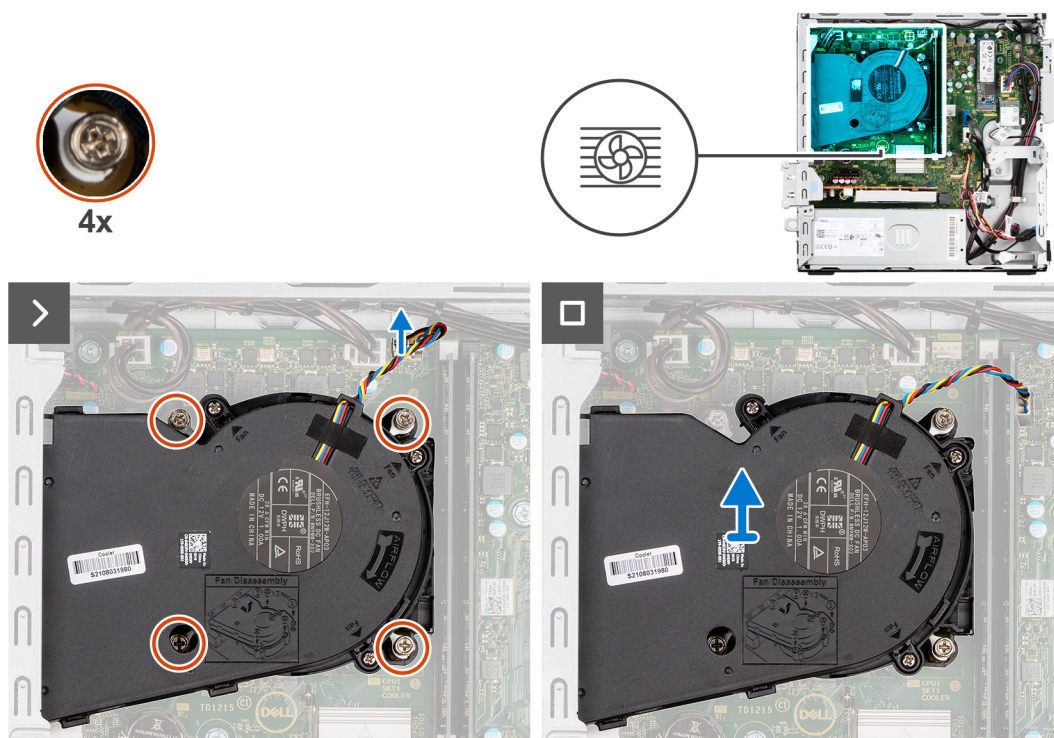

Steps

1. Disconnect the processor-fan cable from the connector on the system board.
2. In the reverse sequential order (4->3->2->1), loosen the captive screws that secure the processor fan and heat-sink assembly to the system board.
3. Lift the processor fan and heat-sink assembly off the system board.

Installing the processor fan and heat-sink assembly

CAUTION: The information in this section is intended for authorized service technicians only.

Prerequisites

If you are replacing a component, remove the existing component before performing the installation procedure.

About this task

The following image indicates the location of the processor fan and heat-sink assembly and provides a visual representation of the installation procedure.

CAUTION: If either the processor or the fan and heat-sink assembly is replaced, use the thermal grease provided in the kit to ensure that thermal conductivity is achieved.

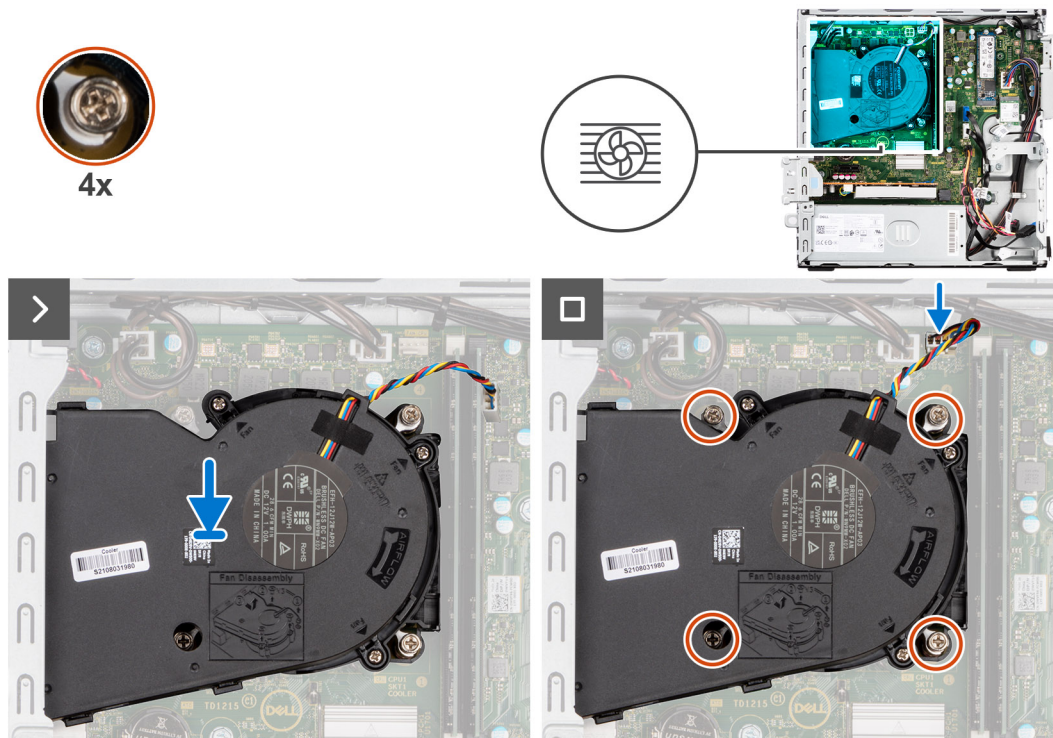

Steps

1. Place the processor fan and heat-sink assembly on the system board and align the captive screws to the screw holes on the system board.
2. Tighten the four captive screws that secure the heat sink to the system board.
3. Connect the processor-fan cable to the connector on the system board.

Next steps

1. Install the [disk-drive cage](#).
2. Install the [3.5-inch hard drive](#) if applicable.
3. Install the [2.5-inch hard drive](#) if applicable.
4. Install the [front bezel](#).

5. Install the [side cover](#).
6. Follow the procedure in [After working inside your computer](#).

Processor

Removing the processor fan and heat-sink assembly

CAUTION: The information in this section is intended for authorized service technicians only.

Prerequisites

1. Follow the procedure in [Before working inside your computer](#).
2. Remove the [side cover](#).
3. Remove the [front bezel](#).
4. Remove the [2.5-inch hard drive](#) if applicable.
5. Remove the [3.5-inch hard drive](#) if applicable.
6. Remove the [disk-drive cage](#).
7. Remove the [processor fan and heat-sink assembly](#).

About this task

The following image indicates the location of the processor and provides a visual representation of the removal procedure.

WARNING: The processor might still be hot after the computer is shut down. Allow the processor to cool down before removing it.

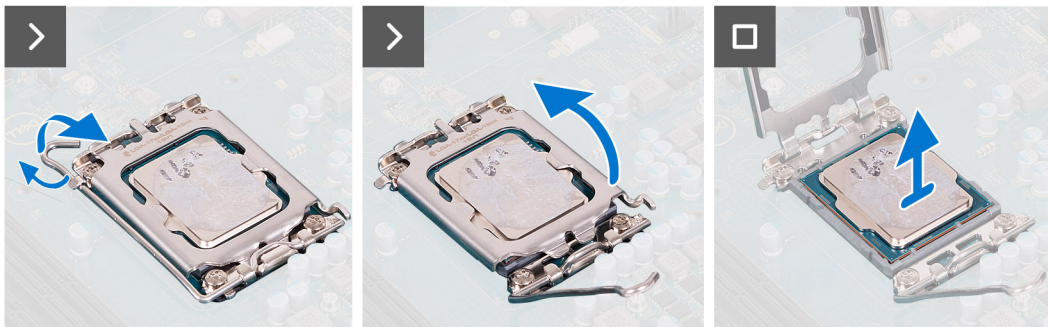
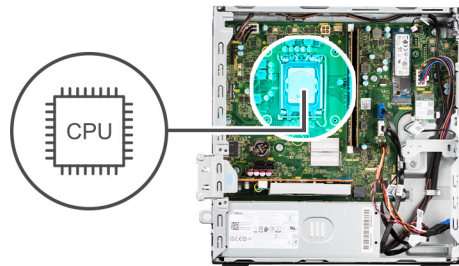

Steps

1. Press the release lever down and then push it away from the processor to release it from the securing tab.
2. Extend the release lever completely and open the processor cover.

CAUTION: When removing the processor, do not touch any of the pins inside the socket or allow any objects to fall on the pins in the socket.

3. Gently lift the processor from the processor socket.

Installing the processor

CAUTION: The information in this section is intended for authorized service technicians only.

Prerequisites

If you are replacing a component, remove the existing component before performing the installation procedure.

About this task

The following image indicates the location of the processor and provides a visual representation of the installation procedure.

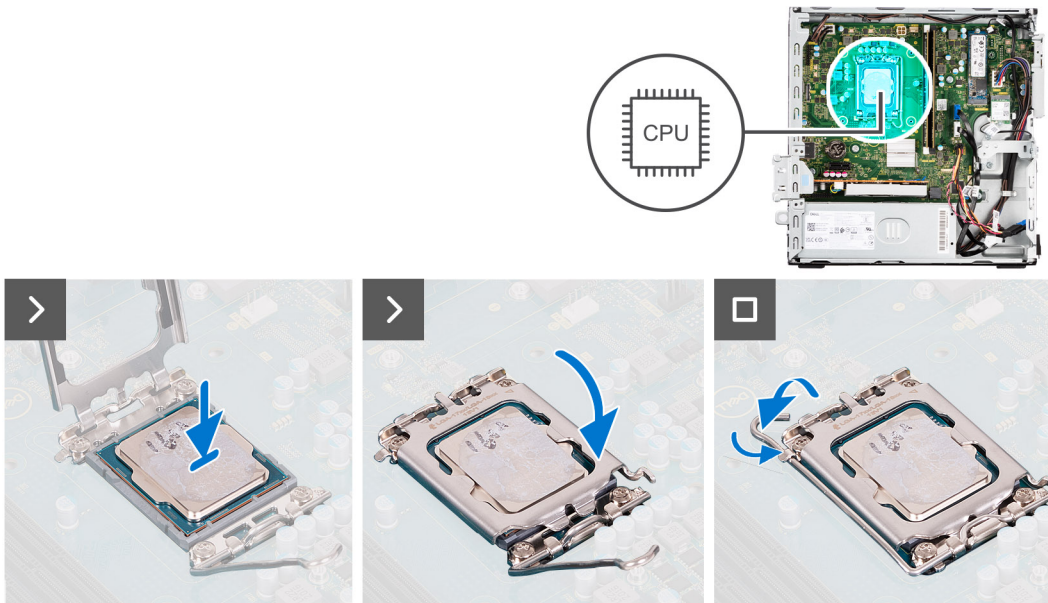

Steps

1. Ensure that the release lever on the processor socket is fully extended in the open position.

NOTE: The pin-1 corner of the processor has a triangle that aligns with the triangle on the pin-1 corner on the processor socket. When the processor is properly seated, all four corners are aligned at the same height. If one or more corners of the processor are higher than the others, the processor is not seated properly.

2. Align the notches on the processor with the tabs on the processor socket and place the processor in the processor socket.

CAUTION: Ensure that the processor-cover notch is positioned underneath the alignment post.

3. When the processor is fully seated in the socket, pivot the release-lever down and place it under the tab on the processor cover.

Next steps

1. Install the [processor fan and heat-sink assembly](#).
2. Install the [disk-drive cage](#).
3. Install the [3.5-inch hard drive](#) if applicable.
4. Install the [2.5-inch hard drive](#) if applicable.
5. Install the [front bezel](#).
6. Install the [side cover](#).
7. Follow the procedure in [After working inside your computer](#).

Internal antenna kit

Removing the internal antenna kit

 **CAUTION:** The information in this section is intended for authorized service technicians only.

Prerequisites

1. Follow the procedure in [Before working inside your computer](#).
2. Remove the [side cover](#).
3. Remove the [front bezel](#).
4. Remove the [2.5-inch hard drive](#) if applicable.
5. Remove the [3.5-inch hard drive](#) if applicable.
6. Remove the [disk-drive cage](#).
7. Remove the [wireless card](#) if applicable.

About this task

The following image indicates the location of the internal antenna kit and provides a visual representation of the removal procedure.



2x
M3x3

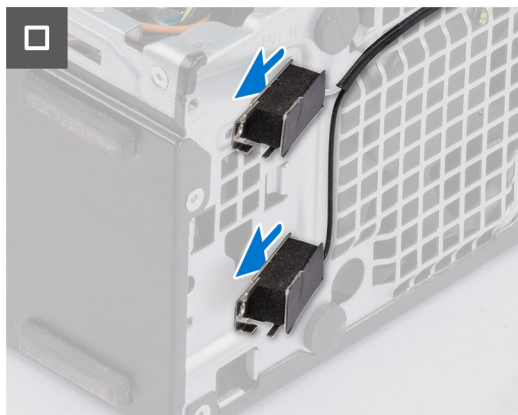
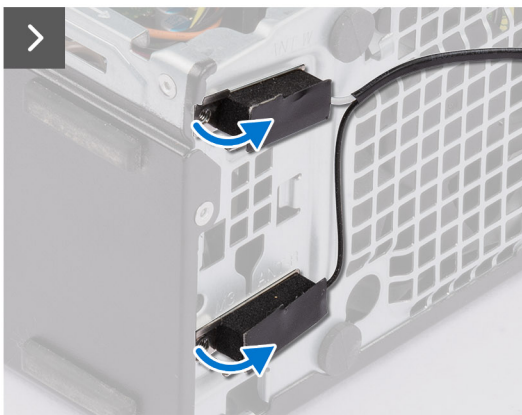
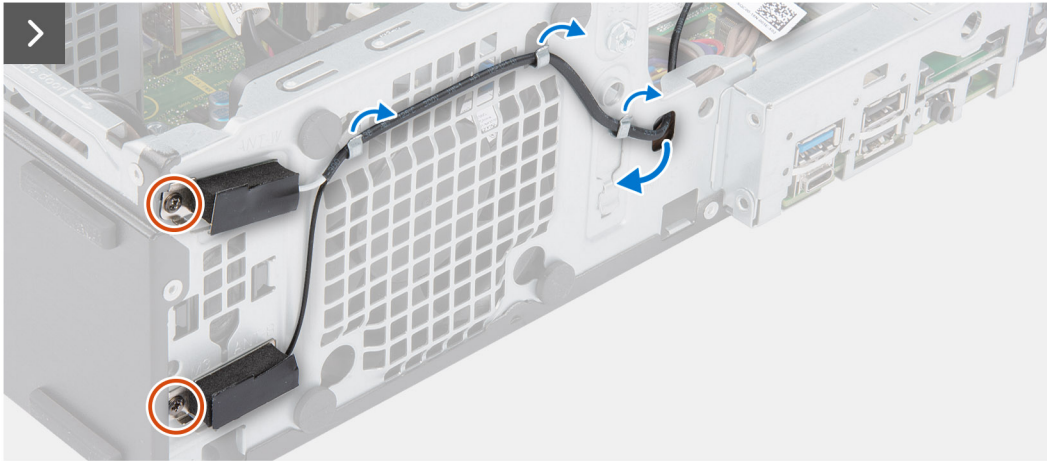

Steps

1. Remove the two screws (M3x3) that secure the internal antenna kits to the chassis.
2. Remove the internal antenna kits from the chassis.
3. Un-route the internal antenna kit cable from the routing guides on the chassis
4. Gently pull the internal antenna kit cable out from the hole on the chassis.

Installing the internal antenna kit

 **CAUTION:** The information in this section is intended for authorized service technicians only.

Prerequisites

If you are replacing a component, remove the existing component before performing the installation procedure.

About this task

The following image indicates the location of the internal antenna kit and provides a visual representation of the installation procedure.

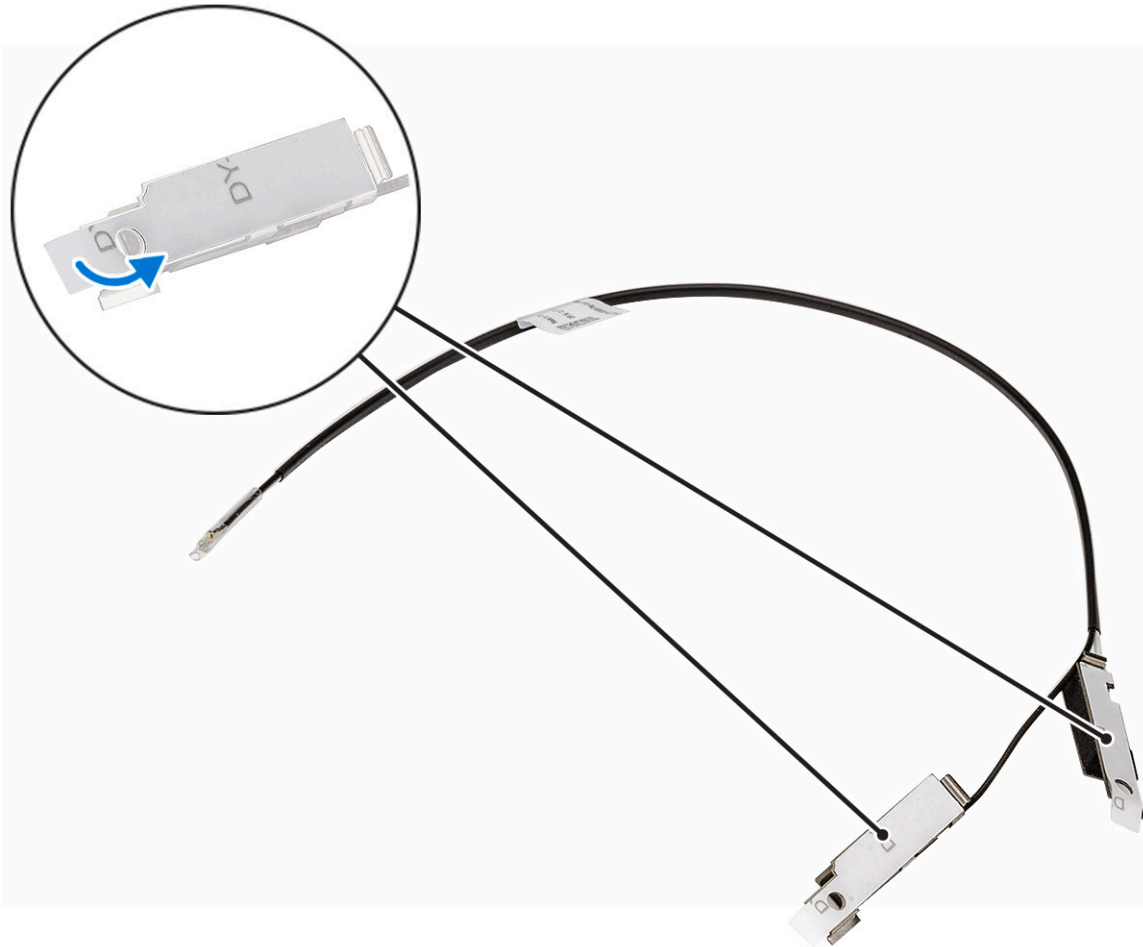

2x
M3x3

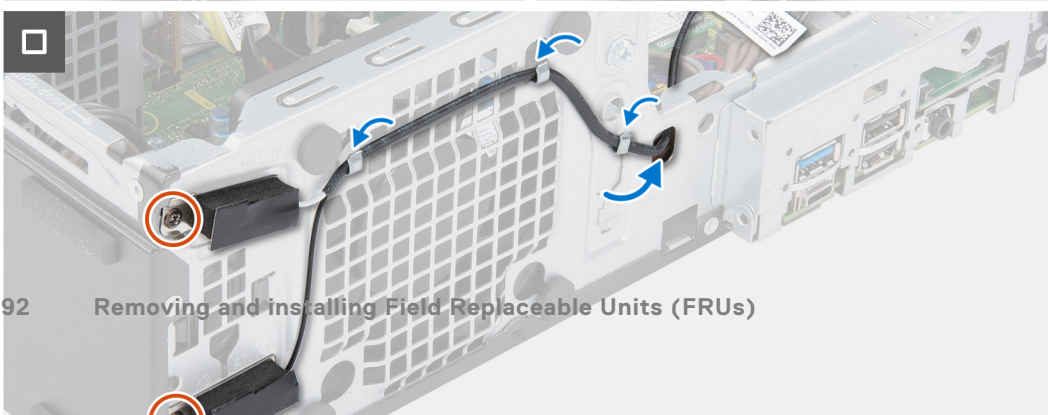
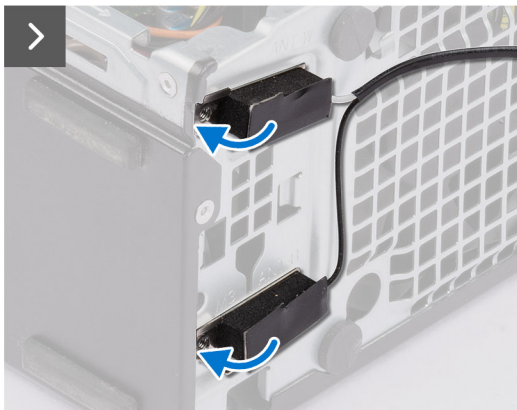
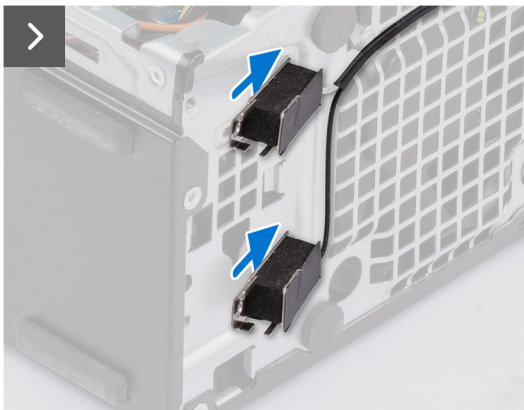

Steps

1. Remove the protection mylars from the internal antennas.
2. Insert the antennas into the slots on the chassis.

The antennas should be installed on the appropriate slots on the chassis. The following table provides guidance on the correct installation method.

Table 27. Antenna-cable color Scheme

CHASSIS LABEL	ANTENNA-CABLE COLOR
ANT-W	White
ANT-B	Black

3. Replace the two screws (M3x3) that secure the internal antennas to the chassis.
4. Route the internal-antenna cable through the routing guides on the chassis.

Next steps

1. Install the [wireless card](#) if applicable.
2. Install the [disk-drive cage](#).
3. Install the [3.5-inch hard drive](#) if applicable.
4. Install the [2.5-inch hard drive](#) if applicable.
5. Install the [front bezel](#).
6. Install the [side cover](#).
7. Follow the procedure in [After working inside your computer](#).

SMA Antenna

Removing the external SMA antenna kit

 **CAUTION:** The information in this section is intended for authorized service technicians only.

Prerequisites

1. Follow the procedure in [Before working inside your computer](#).
2. Remove the [side cover](#).
3. Remove the [front bezel](#).
4. Remove the [2.5-inch hard drive](#) if applicable.
5. Remove the [3.5-inch hard drive](#) if applicable.
6. Remove the [disk-drive cage](#).

About this task

The following image indicates the location of the external SMA antenna kit and provides a visual representation of the removal procedure.

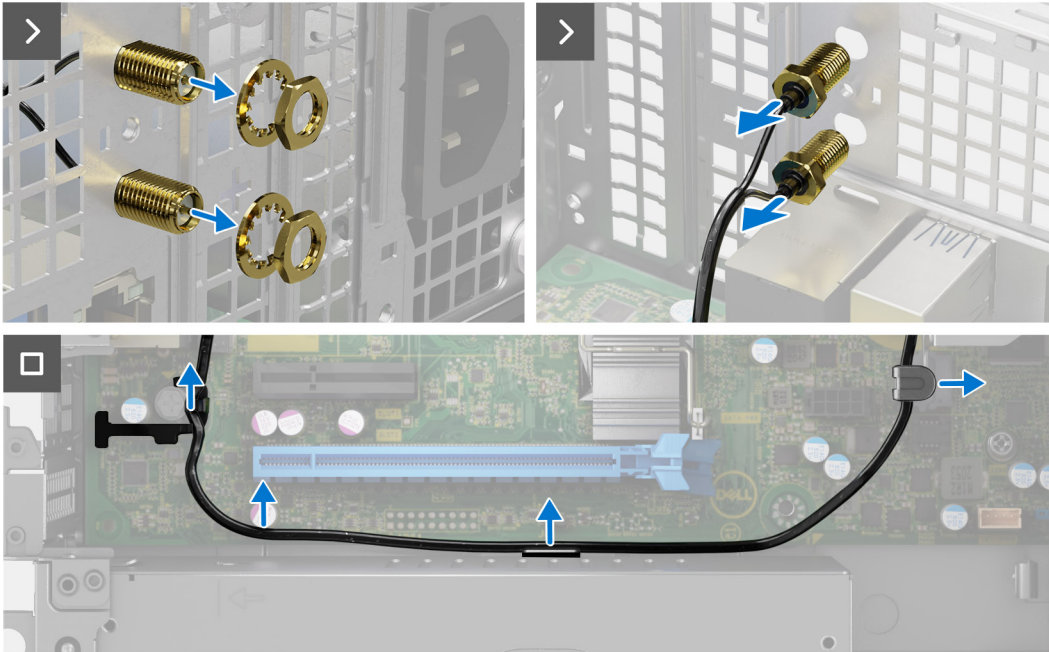

Steps

1. Remove the nut and washer from the two antenna heads.
2. Gently pry and remove the antenna heads from the chassis.
3. Remove the antenna cables from routing guides on the system board.
4. Remove the external SMA antenna kit off the system board.

Installing the SMA antenna kit

CAUTION: The information in this section is intended for authorized service technicians only.

Prerequisites

If you are replacing a component, remove the existing component before performing the installation procedure.

About this task

The following image indicates the location of the external SMA antenna kit and provides a visual representation of the installation procedure.

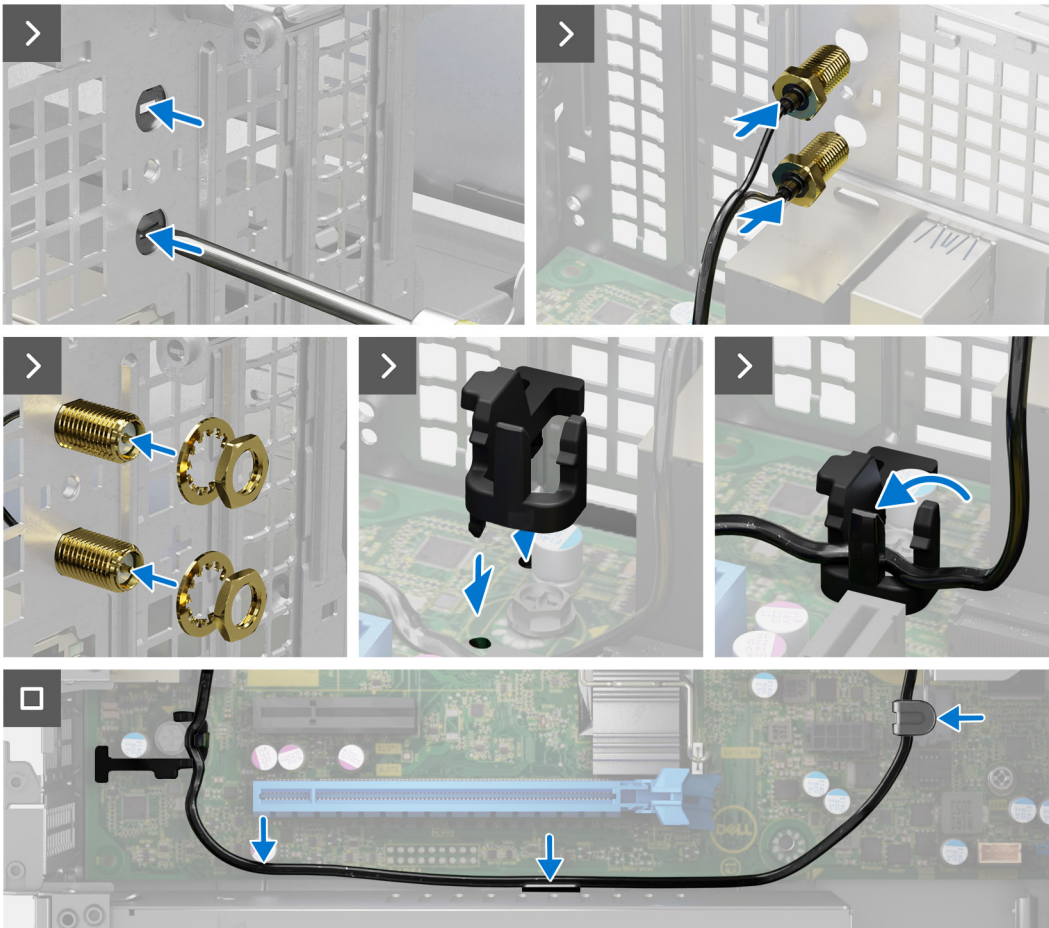

Steps

1.  **NOTE:** Steps 1, 2, and 3 are required when installing the external SMA antenna kit for the first time.

Using a screw driver, push and remove the antenna cover from the chassis.

2. Remove the antenna cover from the screw driver and dispose the antenna cover.
3. Align the pins on the clip with the holes on the system board and press the clip to secure the clip to the system board.
4. Push the antennas into the slots on the back of the chassis.
5. Install the nut and washer to secure the antennas to the chassis.
6. Route the antenna cables through the routing guides on the system board.
7. Press the antenna cable into the clip on the system board.

Next steps

1. Install the [wireless card](#) if applicable.
2. Install the [disk-drive cage](#).
3. Install the [3.5-inch hard drive](#) if applicable.
4. Install the [2.5-inch hard drive](#) if applicable.
5. Install the [front bezel](#).
6. Install the [side cover](#).

7. Follow the procedure in [After working inside your computer](#).

Optional Input/Output modules

Serial module

Removing the serial module

Prerequisites

1. Follow the procedure in [Before working inside your computer](#).
2. Remove the [side cover](#).

About this task

The following image indicates the location of the serial module and provides a visual representation of the removal procedure.



2x
M2x5

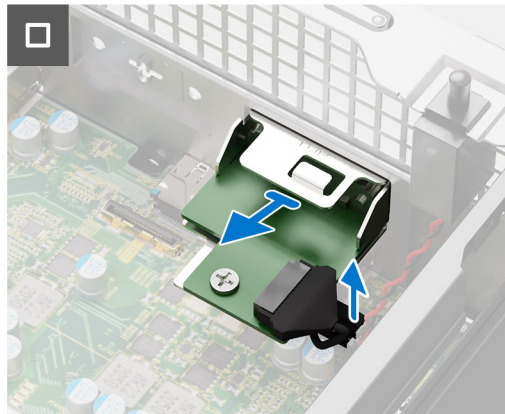
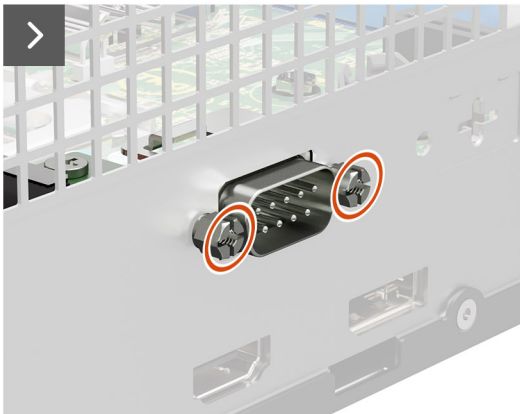
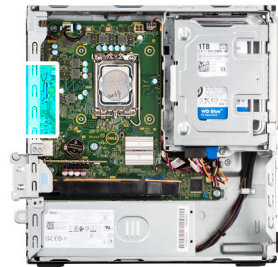

Steps

1. Remove the two (M2x5) cross-type screws that secure the serial module to the chassis.
2. Disconnect the serial-module cable from the connector on the system board.
3. Lift the serial module off the system board.

Installing the serial module

Prerequisites

If you are replacing a component, remove the existing component before performing the installation procedure.

About this task

The following image indicates the location of the serial module and provides a visual representation of the installation procedure.



2x
M2x5

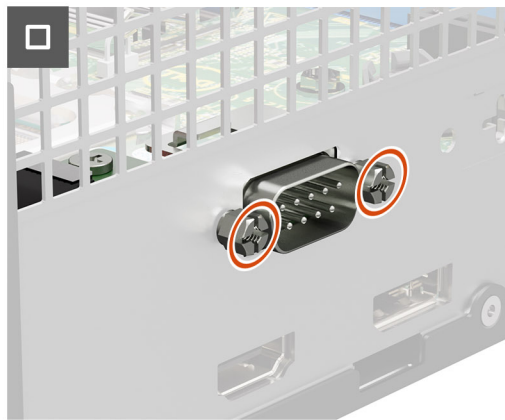
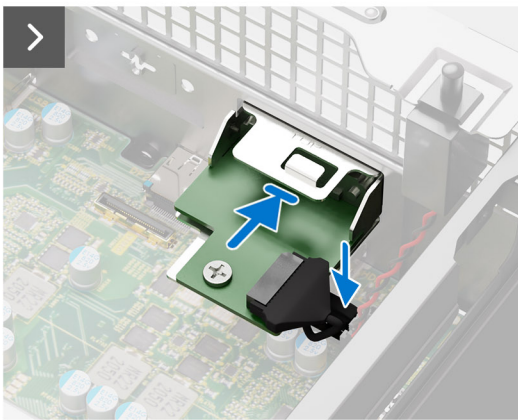
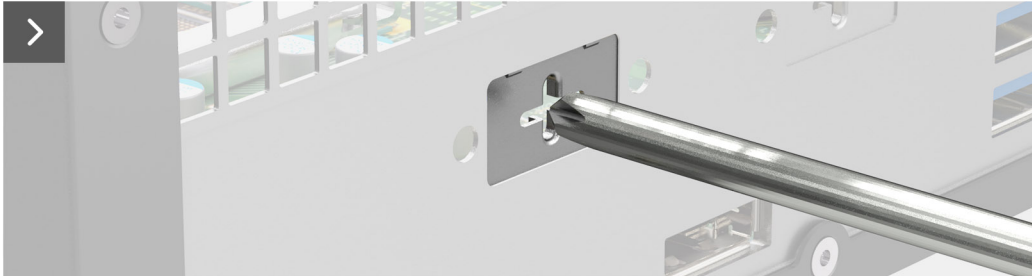
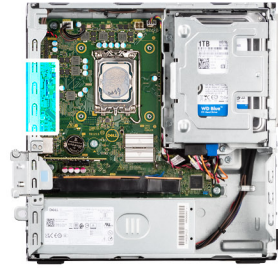

Steps

1. Using a screwdriver, remove the serial module cover from the chassis.
NOTE: This step is applicable only when the serial module is being installed for the first time.
2. Connect the serial-module cable to the connector (KB_MS_SERIAL) on the system board
3. Insert the serial module into the slot on the chassis.
4. Replace the two (M2x5) cross type screws to secure the serial module to the chassis.

Next steps

1. Install the [side cover](#).
2. Follow the procedure in [After working inside your computer](#).

VGA module

Removing the VGA module

Prerequisites

1. Follow the procedure in [Before working inside your computer](#).
2. Remove the [side cover](#).

About this task

The following image indicates the location of the VGA module and provides a visual representation of the removal procedure.



2x
M2x5

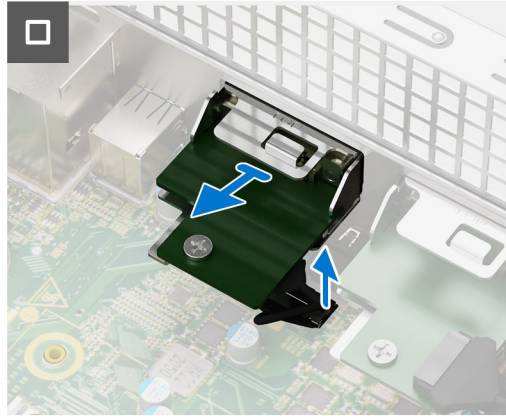
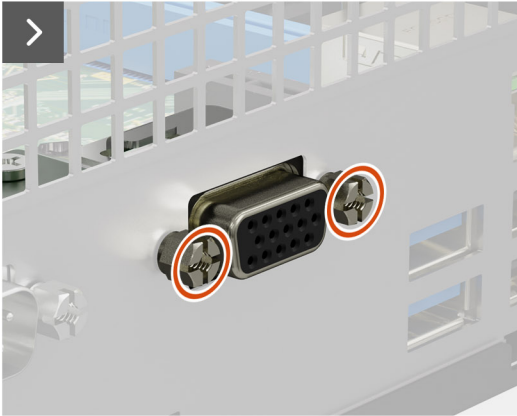
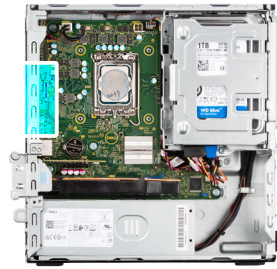

Steps

1. Remove the two (M2x5) cross-type screws that secure the VGA module to the chassis.
2. Disconnect the VGA-module cable from the connector on the system board.
3. Lift the VGA module off the system board.

Installing the VGA module

Prerequisites

If you are replacing a component, remove the existing component before performing the installation procedure.

About this task

The following image indicates the location of the VGA module and provides a visual representation of the installation procedure.



2x
M2x5

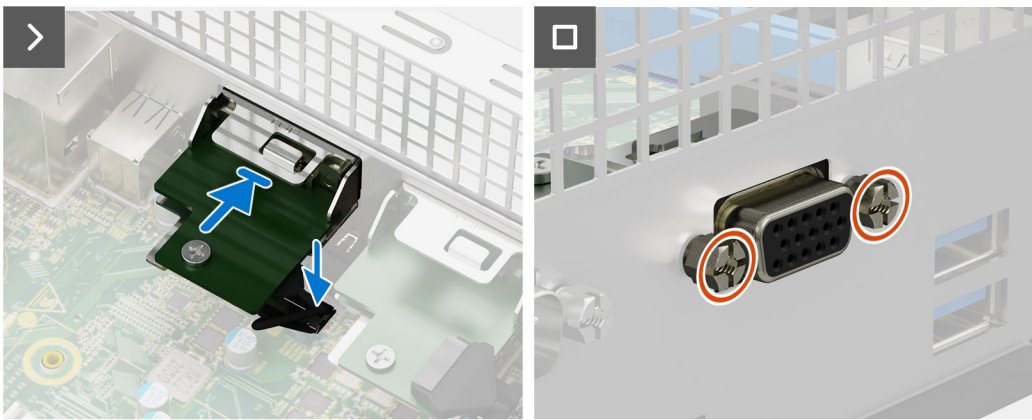
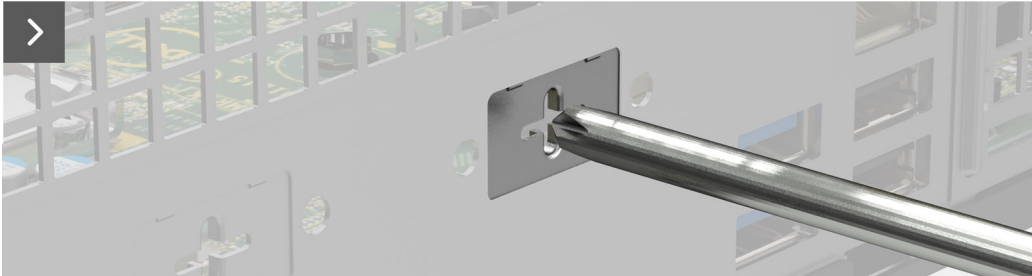
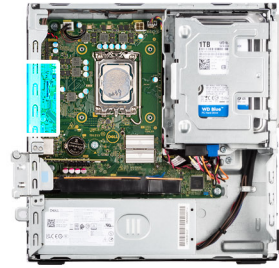

Steps

1. Using a screwdriver, remove the VGA module cover from the chassis.
i **NOTE:** This step is applicable only when the VGA module is being installed for the first time.
2. Connect the VGA-module cable to the connector (VIDEO) on the system board.
3. Insert the VGA module into the slot on the chassis.
4. Replace the two (M2x5) cross type screws to secure the VGA module to the chassis.

Next steps

1. Install the [side cover](#).
2. Follow the procedure in [After working inside your computer](#).

DP module

Removing the DP module

Prerequisites

1. Follow the procedure in [Before working inside your computer](#).
2. Remove the [side cover](#).

About this task

The following image indicates the location of the DP module and provides a visual representation of the removal procedure.



2x
M3x3

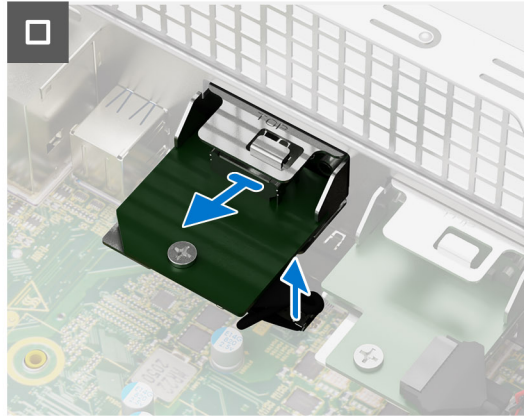
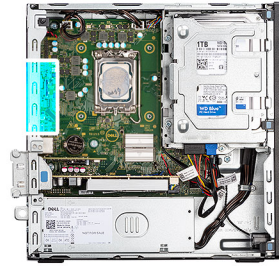

Steps

1. Remove the two (M3x3) screws that secure the DP module to the chassis.
2. Disconnect the DP-module cable from the connector on the system board.
3. Lift the DP module off the system board.

Installing the DP module

Prerequisites

If you are replacing a component, remove the existing component before performing the installation procedure.

About this task

The following image indicates the location of the DP module and provides a visual representation of the installation procedure.



2x
M3x3

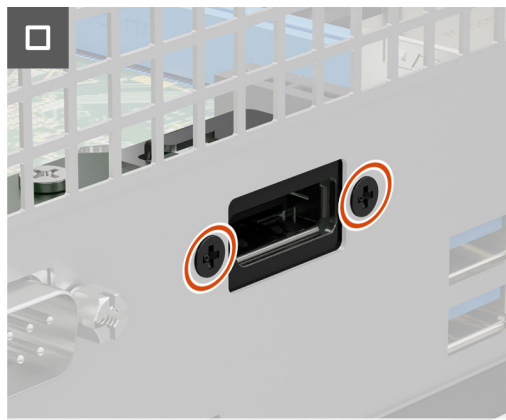
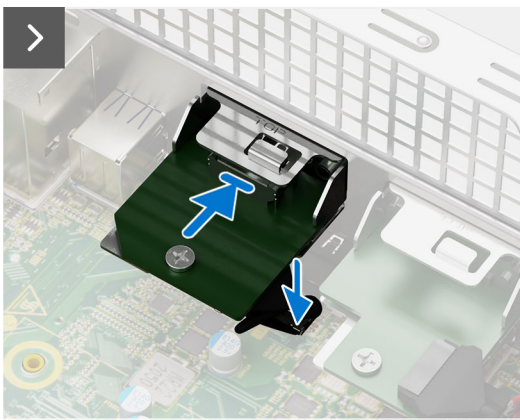
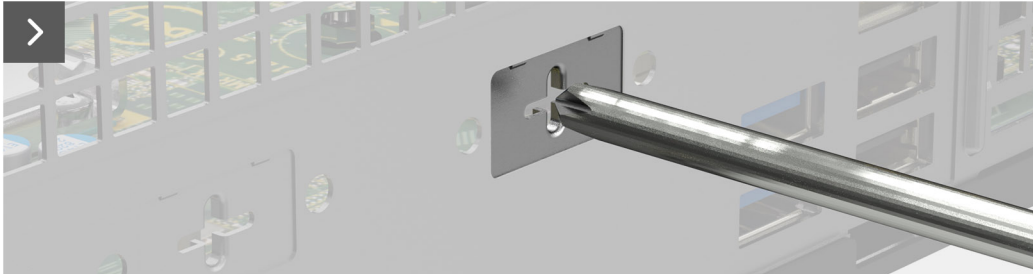
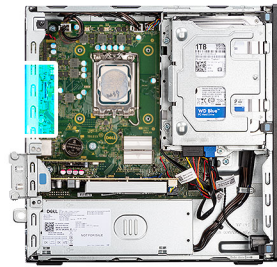

Steps

1. Using a screwdriver, remove the DP module cover from the chassis.
NOTE: This step is applicable only when the DP module is being installed for the first time.
2. Connect the DP-module cable to the connector (VIDEO) on the system board.
3. Insert the DP module into the slot on the chassis.
4. Replace the two (M3x3) screws to secure the DP module to the chassis.

Next steps

1. Install the [side cover](#).
2. Follow the procedure in [After working inside your computer](#).

HDMI module

Removing the HDMI module

Prerequisites

1. Follow the procedure in [Before working inside your computer](#).
2. Remove the [side cover](#).

About this task

The following image indicates the location of the HDMI module and provides a visual representation of the removal procedure.



2x
M3x3

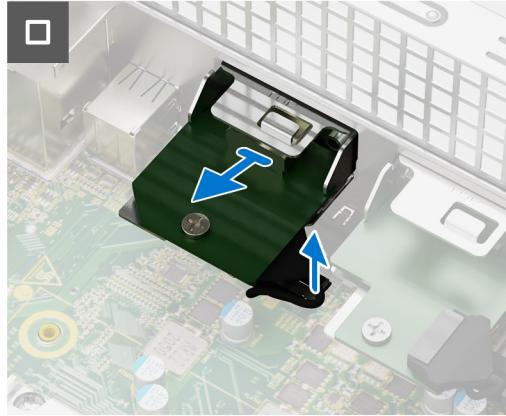
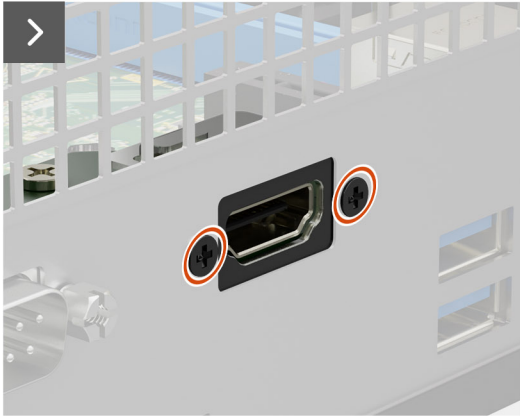
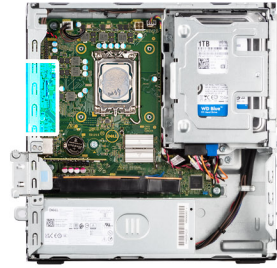

Steps

1. Remove the two (M3x3) screws that secure the HDMI module to the chassis.
2. Disconnect the HDMI-module cable from the connector on the system board.
3. Lift the HDMI module off the system board.

Installing the HDMI module

Prerequisites

If you are replacing a component, remove the existing component before performing the installation procedure.

About this task

The following image indicates the location of the HDMI module and provides a visual representation of the installation procedure.



2x
M3x3

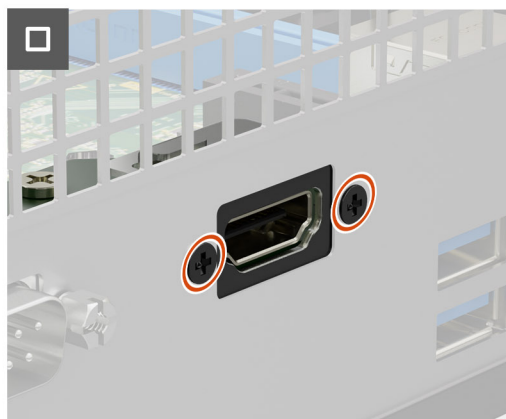
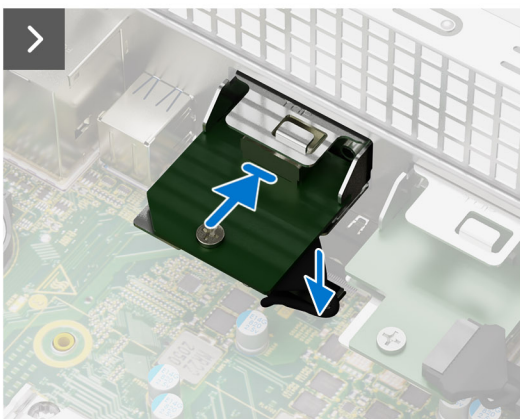
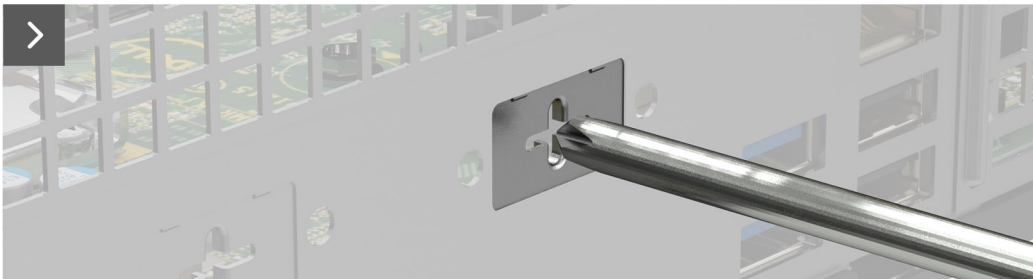
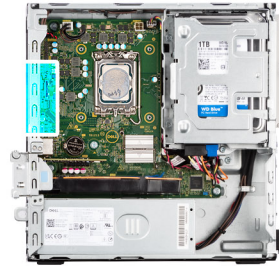

Steps

1. Using a screwdriver, remove the HDMI module cover from the chassis.
NOTE: This step is applicable only when the HDMI module is being installed for the first time.
2. Connect the HDMI-module cable to the connector (VIDEO) on the system board.
3. Insert the HDMI module into the slot on the chassis.
4. Replace the two (M3x3) screws that secure the HDMI module to the chassis.

Next steps

1. Install the [side cover](#).
2. Follow the procedure in [After working inside your computer](#).

System board

Removing the system board

Prerequisites

1. Follow the procedure in [Before working inside your computer](#).
2. Remove the [side cover](#).
3. Remove the [front bezel](#).
4. Remove the [2.5-inch hard drive](#) if applicable.
5. Remove the [3.5-inch hard drive](#) if applicable.

6. Remove the [disk-drive cage](#).
7. Remove the [Optional I/O modules](#).
8. Remove the [expansion card](#).
9. Remove the [memory modules](#).
10. Remove the [solid-state drive](#).
11. Remove the [WLAN card](#).
12. Remove the [heat-sink and fan assembly](#).
13. Remove the [processor](#).

About this task

The following image indicates the connectors on your system board.

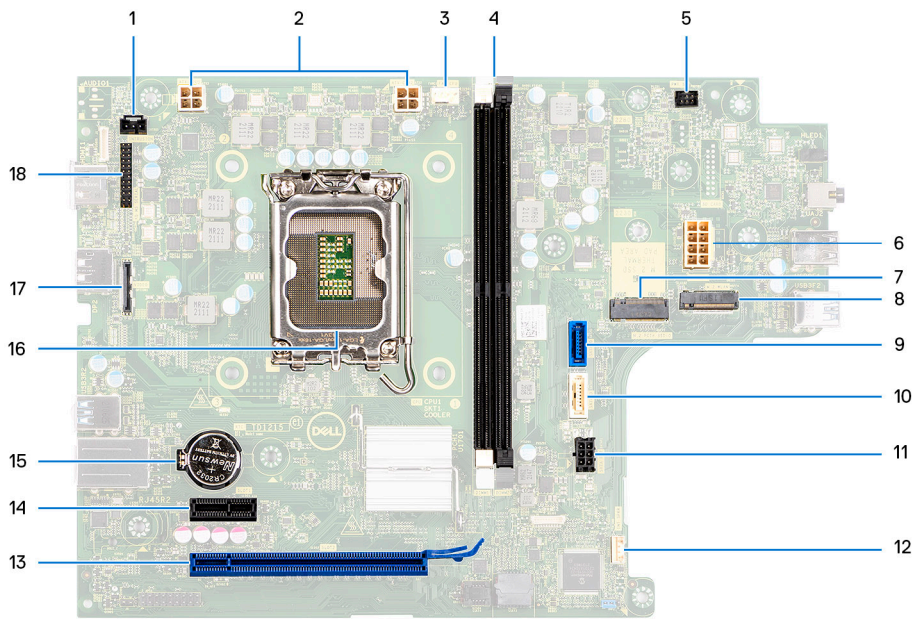

- | | |
|---|--|
| <ol style="list-style-type: none"> 1. Intrusion-switch cable 3. Processor-fan connector 5. Power-button connector 7. M.2 2230/2280 solid-state drive slot 9. Hard-drive data connector (SATA 0) 11. SATA power connector 13. PCIe x16 slot (SLOT 2) 15. Coin-cell battery socket 17. Video connector | <ol style="list-style-type: none"> 2. ATX CPU power connector 4. UDIMM slots From the left (a>b):
DIMM 1
DIMM 2 6. System-power connector 8. M.2 WLAN slot 10. Optical-drive/hard-drive data connector (SATA 1) 12. Internal-speaker connector 14. PCIe x1 slot (SLOT 1) 16. Processor socket 18. I/O connector |
|---|--|

The following images indicate the location of the system board and provide a visual representation of the removal procedure.



7x
6-32

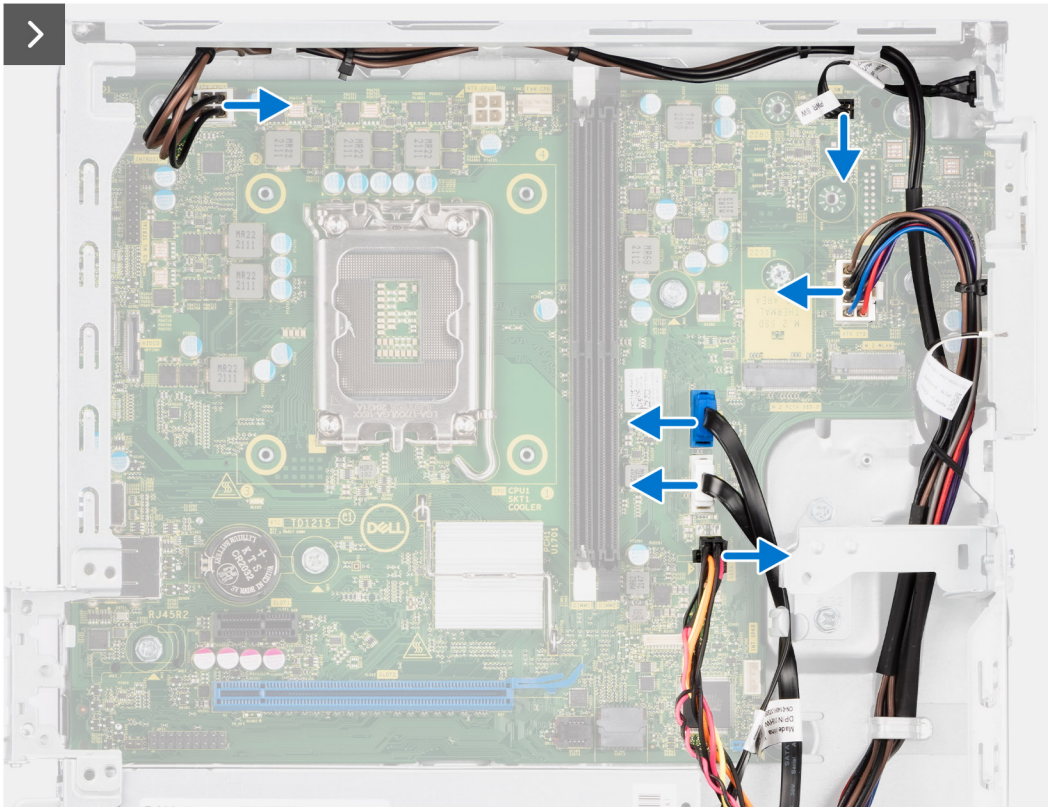
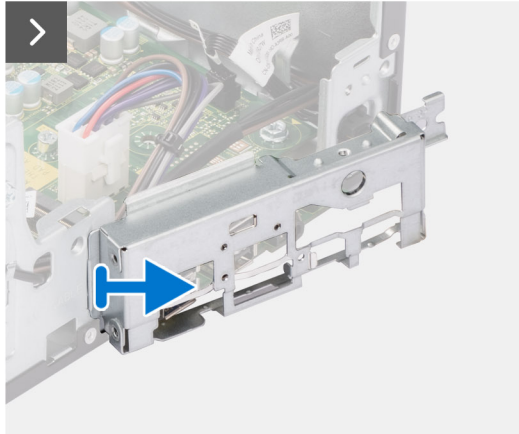
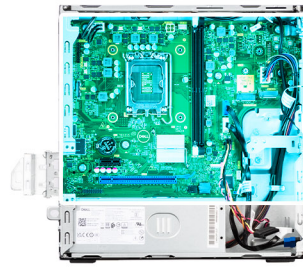

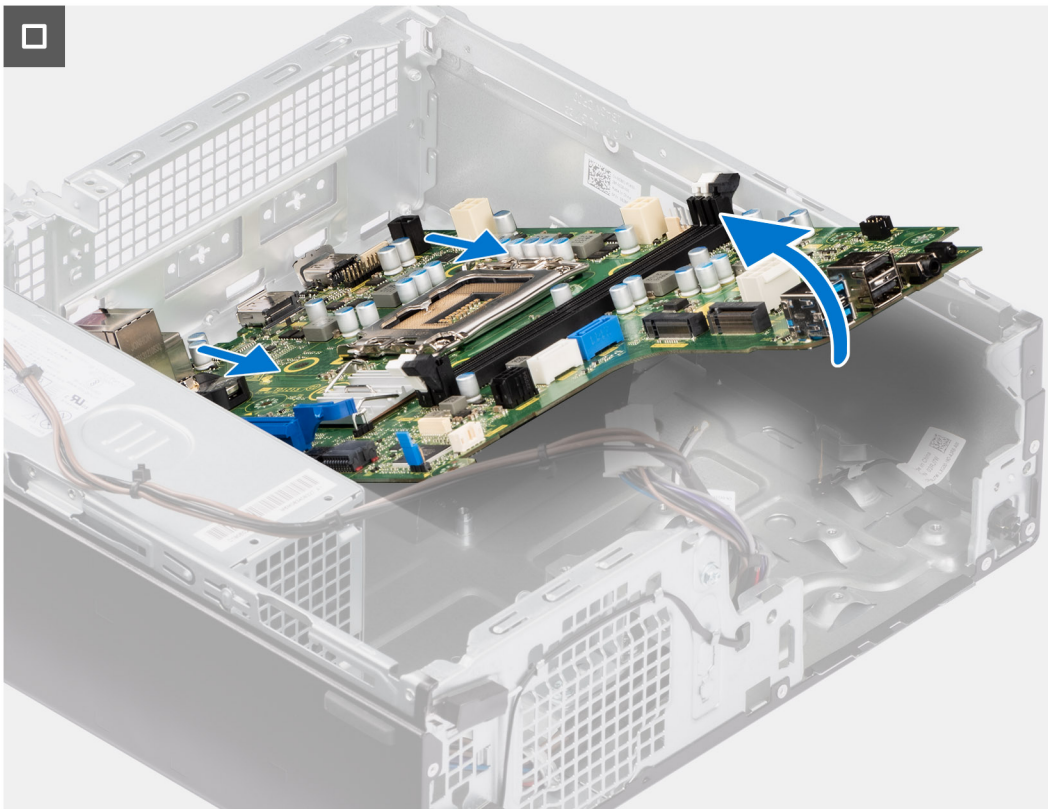
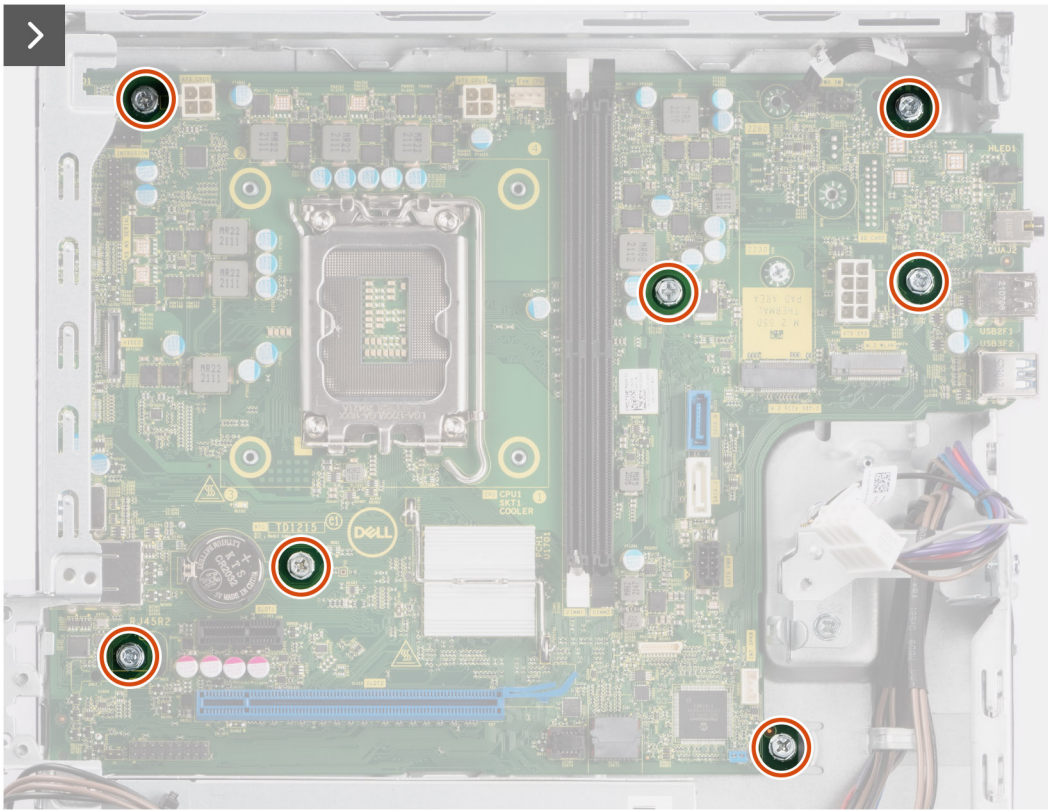

Steps

1. Remove the screw (6-32) that secures the front I/O bracket to the chassis.
2. Rotate and remove the front I/O-bracket from the chassis
3. Disconnect all the cables that are connected to the system board.
4. Remove the seven (#6-32) screws that secure the system board to the chassis.

5. Free the system board from the back I/O panel by sliding it towards the right and lift the system board out of the chassis.

Installing the system board

Prerequisites

If you are replacing a component, remove the existing component before performing the installation procedure.

About this task

The following image indicates the connectors on your system board.

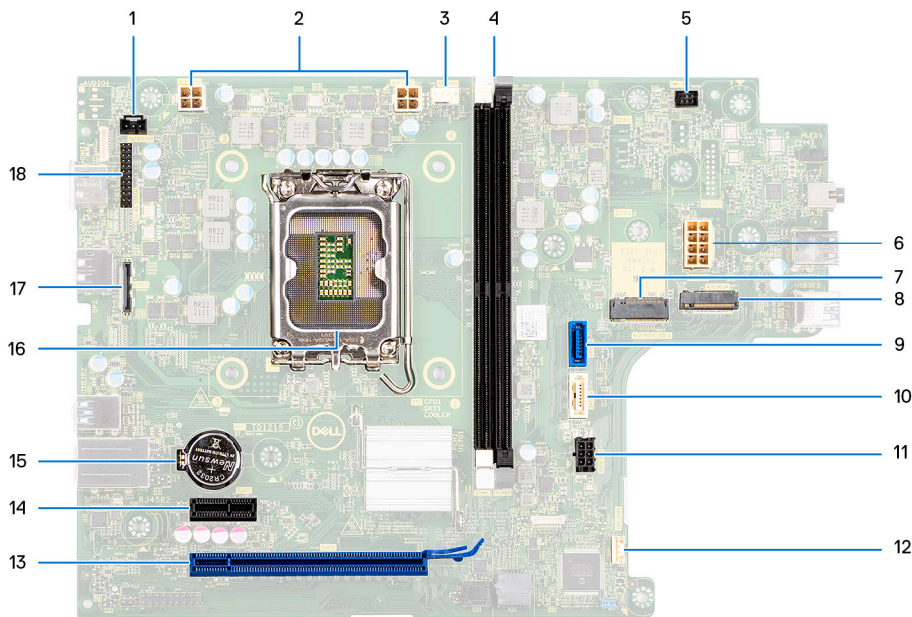

1. Intrusion-switch cable

3. Processor-fan cable

2. Processor-power cable

4. UDIMM slots

From the left (a>b):

DIMM 1

DIMM 2

5. Power-button cable

7. M.2 2230/2280 solid-state drive slot

9. Hard-drive data cable (SATA 0)

11. SATA power cable

13. PCIe x16 slot (SLOT 2)

15. Coin-cell battery socket

17. Video cable

6. System-power cable

8. M.2 WLAN slot

10. Optical-drive/hard-drive data cable (SATA 1)

12. Internal-speaker cable

14. PCIe x1 slot (SLOT 1)

16. Processor socket

18. I/O cable

The following image indicates the location of the system board and provides a visual representation of the installation procedure.



7x
6-32

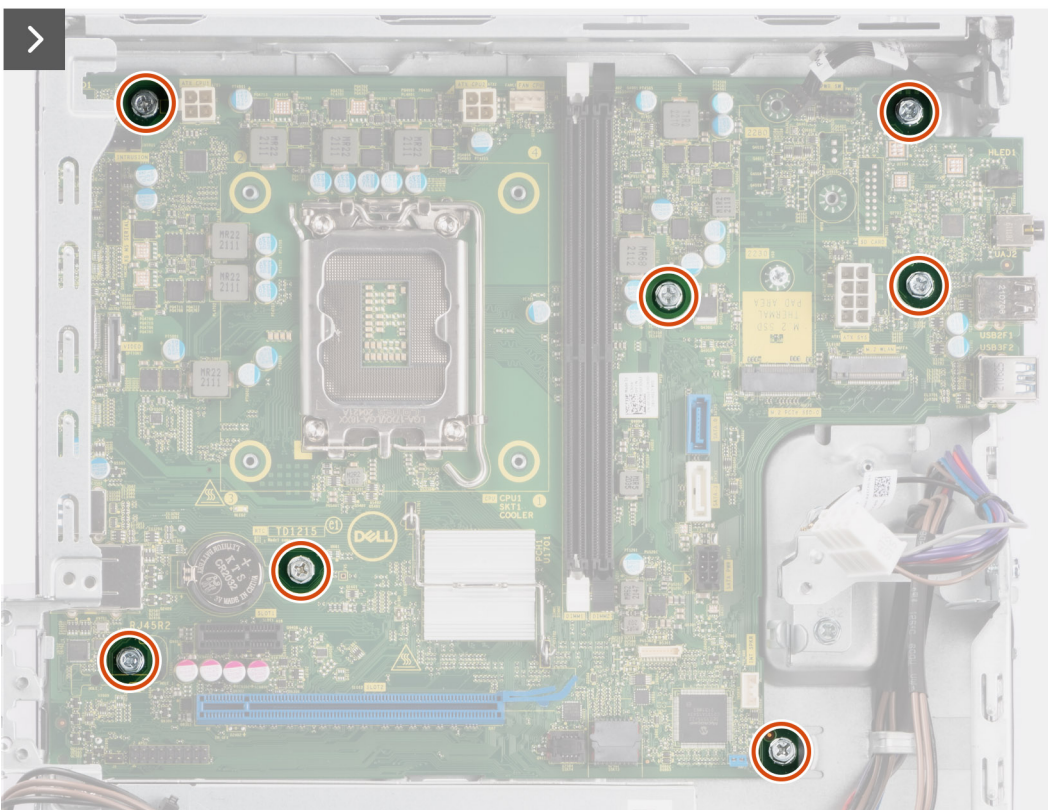
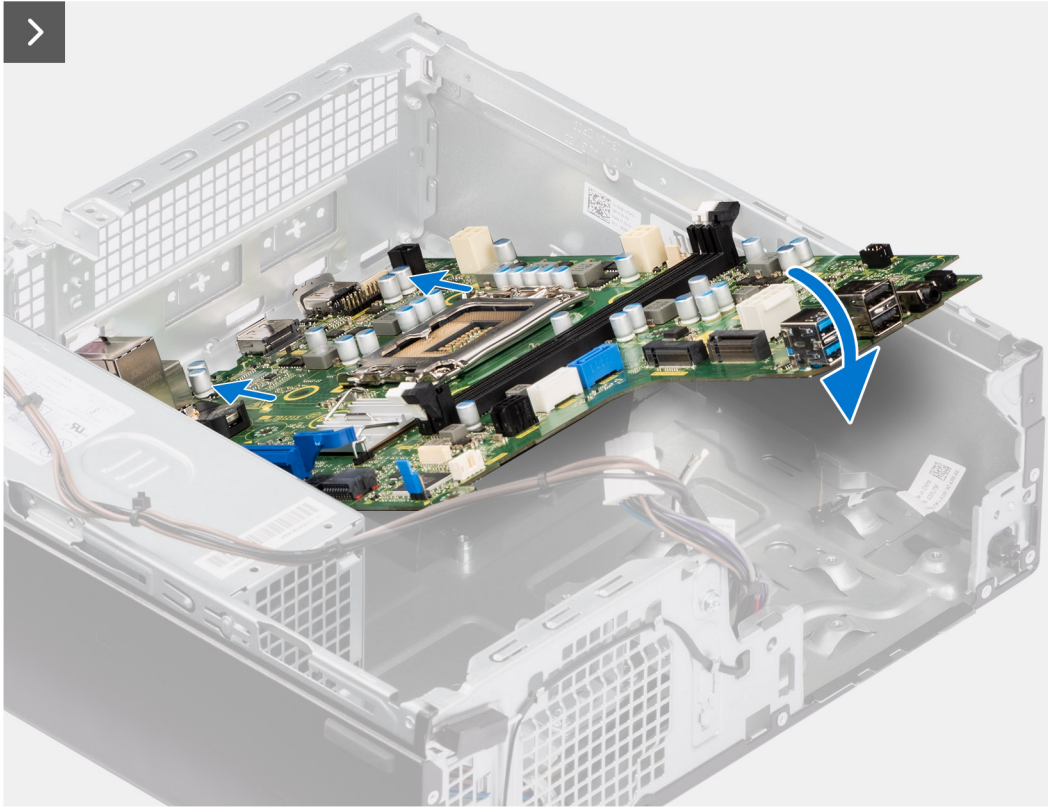

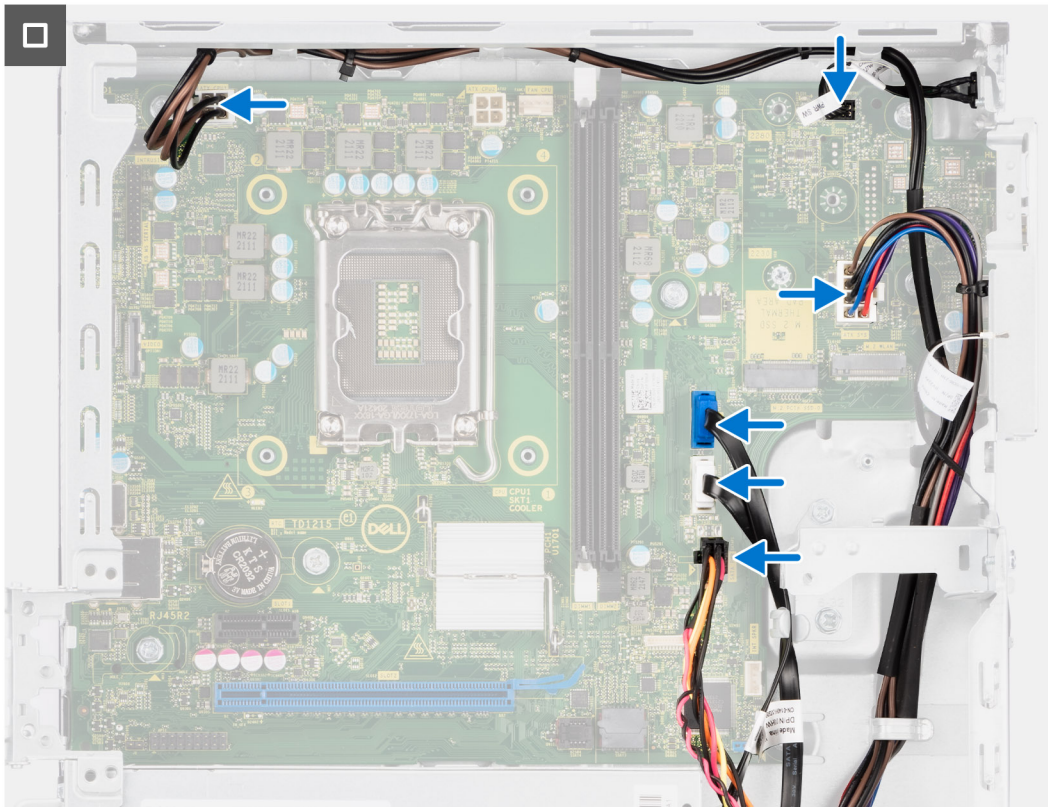

Steps

1. Align and lower the system board into the system until the stand-off points at the back of the system board align with those on the chassis.
2. Replace the seven (#6-32) screws to secure the system board to the chassis.
3. Route and connect all the cables that you disconnected from the system board.
4. Place and align the front I/O-bracket with I/O slot on the chassis.
5. Replace the screw (#6-32) that secures the front I/O-bracket to the chassis.

Next steps

1. Install the [processor](#).
2. Install the [heat-sink and fan assembly](#).
3. Install the [WLAN card](#).
4. Install the [solid-state drive](#).
5. Install the [memory modules](#).
6. Install the [expansion card](#).
7. Install the [Optional I/O modules](#).
8. Install the [disk-drive cage](#).
9. Install the [3.5-inch hard drive](#) if applicable.
10. Install the [2.5-inch hard drive](#) if applicable.
11. Install the [front bezel](#).
12. Install the [side cover](#).
13. Follow the procedure in [After working inside your computer](#).

Software

This chapter details the supported operating systems along with instructions on how to install the drivers.

Operating system

Your OptiPlex Small Form Factor 7010 supports the following operating systems:

- Windows 11 Home
- Windows 11 Pro
- Windows 11 Pro Downgrade (Windows 10 image)
- Windows 11 Pro National Education
- Windows 10 CMIT Government Edition (China only)
- Ubuntu Linux 22.04 LTS

Drivers and downloads

When troubleshooting, downloading or installing drivers it is recommended that you read the Dell Knowledge Base article, Drivers and Downloads FAQs [000123347](#).

BIOS Setup

CAUTION: Unless you are an expert computer user, do not change the settings in the BIOS Setup. Certain changes can make your computer work incorrectly.

NOTE: Depending on the computer and its installed devices, the items listed in this section may or may not be displayed.

NOTE: Before you change the settings in BIOS Setup, it is recommended that you note down the original settings for future reference.

Use BIOS Setup for the following purposes:

- Get information about the hardware installed in your computer, such as the amount of RAM and the size of the hard drive.
- Change the system configuration information.
- Set or change a user-selectable option, such as the user password, type of hard drive installed, and enabling or disabling base devices.

Entering BIOS setup program

About this task

Turn on (or restart) your computer and press F2 immediately.

Navigation keys

NOTE: For most of the System Setup options, changes that you make are recorded but do not take effect until you restart the system.

Table 28. Navigation keys

Keys	Navigation
Up arrow	Moves to the previous field.
Down arrow	Moves to the next field.
Enter	Selects a value in the selected field (if applicable) or follow the link in the field.
Spacebar	Expands or collapses a drop-down list, if applicable.
Tab	Moves to the next focus area. NOTE: For the standard graphics browser only.
Esc	Moves to the previous page until you view the main screen. Pressing Esc in the main screen displays a message that prompts you to save any unsaved changes and restarts the system.

F12 One Time Boot menu

To enter the One Time Boot menu, turn on your computer, and then press F12 immediately.

NOTE: It is recommended to shutdown the computer if it is on.

The F12 One Time Boot menu displays the devices that you can boot from including the diagnostic option. The boot menu options are:

- Removable Drive (if available)
- STXXXX Drive (if available)
- **i** **NOTE:** XXX denotes the SATA drive number.
- Optical Drive (if available)
- SATA Hard Drive (if available)
- Diagnostics

The boot sequence screen also displays the option to access System Setup.

System setup options

i **NOTE:** Depending on this computer and its installed devices, the items listed in this section may or may not appear.

Table 29. System setup options—System information menu

General-System Information	
System Information	
BIOS Version	Displays the BIOS version number.
Service Tag	Displays the Service Tag of the computer.
Asset Tag	Displays the Asset Tag of the computer.
Ownership Tag	Displays the ownership tag of the computer.
Manufacture Date	Displays the manufacture date of the computer.
Ownership Date	Displays the ownership date of the computer.
Express Service Code	Displays the express service code of the computer.
Signed Firmware Update	Displays the signed firmware update of the computer.
Memory Information	
Memory Installed	Displays the total computer memory installed.
Memory Available	Displays the total computer memory available.
Memory Speed	Displays the memory speed.
Memory Channel Mode	Displays single or dual channel mode.
Memory Technology	Displays the technology used for the memory.
DIMM 1 Size	Displays the DIMM 1 memory size.
DIMM 2 Size	Displays the DIMM 2 memory size.
DIMM 3 Size	Displays the DIMM 3 memory size.
DIMM 4 Size	Displays the DIMM 4 memory size.
Processor Information	
Processor Type	Displays the processor type.
Core Count	Displays the number of cores on the processor.
Processor ID	Displays the processor identification code.
Current Clock Speed	Displays the current processor clock speed.
Minimum Clock Speed	Displays the minimum processor clock speed.
Maximum Clock Speed	Displays the maximum processor clock speed.
Processor L2 Cache	Displays the Processor L2 Cache size.

Table 29. System setup options—System information menu (continued)

General-System Information	
Processor L3 Cache	Displays the Processor L2 Cache size.
Microcode Version	Displays whether the microcode version.
Intel Hyper-Threading Capable	Displays whether the computer is Intel Hyper-Threading capable.
64-Bit Technology	Displays whether 64-bit technology is used.
Device Information	
Slot 1	Displays the slot 1 information of the computer.
Slot 2	Displays the slot 2 information of the computer.
LOM MAC Address	Displays the LOM MAC address of the computer.
Video Controller	Displays the video controller type of the computer.
Video Memory	Displays the video memory of the computer.
Native Resolution	Displays the native resolution of the computer.
Video BIOS version	Displays the video BIOS version of the computer.
Audio Controller	Displays the audio controller information of the computer.
Wi-Fi Device	Displays the wireless device information of the computer.
Bluetooth Device	Displays the Bluetooth device information of the computer.
dGPU Video Controller	Displays the dGPU video controller of the computer.

Table 30. System setup options—Boot Configuration menu

Boot Configuration	
Boot Sequence	
Boot Sequence	Displays the boot sequence.
Boot List Option	Displays the available boot options.
Force PXE on Next Boot	This option is disabled by default.
Secure Digital (SD) Card Boot	This option is disabled by default.
Secure Boot	
Enable Secure Boot	This option is disabled by default.
Enable Microsoft UEFI CA	This option is enabled by default.
Secure Boot Mode	The option Deployed mode is enabled by default.
Expert Key Management	
Enable Custom Mode	This option is disabled by default.
Custom Mode Key Management	The option PK is enabled by default.

Table 31. System setup options—Integrated devices

Integrated Devices	
Date/Time	Displays the date and time configuration of the computer.
Memory Mapped I/O above 4 Gig	This option is enabled by default.
Audio	The option Enable Audio is enabled by default.
USB configuration	All options are enabled by default.
Front USB configuration	All options are enabled by default.
Rear USB configuration	All options are enabled by default.

Table 31. System setup options—Integrated devices (continued)

Integrated Devices	
Dust Filter Maintenance	The disabled option is enabled by default.

Table 32. System setup options—Storage

Storage	
SATA/NVMe Operation	The option RAID on is enabled by default.
Storage Interface	All options are enabled by default.
SMART Reporting	This option is disabled by default.
Drive information	Displays drive information about this computer.
Enable MediaCard	The option Secure Digital SD card is enabled by default.

Table 33. System setup options—Display

Display	
Multi-Display	This option is enabled by default.
Primary display	The auto option is enabled by default.
Full screen logo	This option is disabled by default.

Table 34. System setup options—Connection

Connection	
Network Controller Configuration	
Integrated NIC	The option Enabled with PXE is enabled by default.
Wireless Device Enable	WLAN and Bluetooth options are enabled by default.
Enable UEFI Network Stack	The option Auto Enabled is enabled by default.
HTTP(s) Boot Feature	The option is enabled by default.
HTTP(s) Boot Mode	The Auto Mode option is enabled by default.

Table 35. System setup options—Power

Power	
USB PowerShare	This option is disabled by default.
USB Wake Support	The option is enabled by default.
AC Behavior	The Power Off option is enabled by default.
Active State Power Management	The option Auto is enabled by default.
Block Sleep	The option is disabled by default.
Deep Sleep Control	The option Enabled in S4 and S5 is enabled by default.
Fan Control Override	This option is disabled by default.
Intel Speed Shift Technology	This option is enabled by default.

Table 36. System setup options—Security

Security	
TPM 2.0 Security	The option is enabled by default.
Attestation Enable	This option is enabled by default.
Key Storage Enable	This option is enabled by default.

Table 36. System setup options—Security (continued)

Security	
SHA-256	This option is enabled by default.
Clear	This option is disabled by default.
PBI Bypass for Clear Commands	This option is disabled by default.
Intel Total Memory Encryption	The Multi-Key Total Memory Encryption (Up to 16 keys) option is disabled by default.
SMM Security Mitigation	This option is disabled by default.
Absolute	This option is enabled by default.
Chassis intrusion	This option is disabled by default.
Block Boot Until Cleared	This option is disabled by default.
Data Wipe on Next Boot	This option is disabled by default.
UEFI Boot Path Security	The option Always Except Internal HDD is enabled by default.
Authenticated BIOS interface	This option is disabled by default.
Legacy Manageability Interface Access	This option is disabled by default.

Table 37. System setup options—Passwords menu

Passwords	
Admin Password	Set, change, or delete the administrator password.
System Password	Set, change, or delete the computer password.
Internal HDD-0 Password	Set, change, or delete the Internal HDD-0 password.
M.2 PCIe SSD-0	Set, change, or delete the M.2 PCIe SSD-0 password.
Password Configuration	
Upper Case Letter	Reinforces password must have at least one upper case letter. By default, the option is disabled.
Lower Case Letter	Reinforces password must have at least one lower case letter. By default, the option is disabled.
Digit	Reinforces password must have at least one digit. By default, the option is disabled.
Special Character	Reinforces password must have at least one special character. By default, the option is disabled.
Minimum Characters	Set the minimum characters allowed for password.
Password Bypass	When enabled, this always prompts for computer and internal hard drive passwords when powered on from the off state. By default, the Disabled option is enabled.
Password Changes	
Enable Non-Admin Password Changes	Enable or disable to change computer and hard drive password without the need for admin password. By default, the option is enabled.
Admin Setup Lockout	

Table 37. System setup options—Passwords menu (continued)

Passwords	
Enable Admin Setup Lockout	Enables administrators control over how their users can or cannot access BIOS setup. By default, the option is disabled.
Master Password Lockout	
Enable Master Password Lockout	When enabled, this will disable the master password support. By default, the option is disabled.
Allow Non-Admin PSID Revert	
Enable Allow Non-Admin PSID Revert	Controls access to the Physical Security ID (PSID) revert of NVMe hard-drives from the Dell Security Manager prompt. By default, the option is disabled.

Table 38. System setup options—Update, Recovery menu

Update, Recovery	
UEFI Capsule Firmware Updates	Enable or disable BIOS updates through UEFI capsule update packages. By default, the option is enabled.
BIOS Recovery from Hard Drive	Enables the user to recover from certain corrupted BIOS conditions from a recovery file on the user primary hard drive or an external USB key. By default, the option is enabled.
BIOS Downgrade	
Allow BIOS Downgrade	Enable or disable the flashing of the computer firmware to previous revision is blocked. By default, the option is enabled.
SupportAssist OS Recovery	Enable or disable the boot flow for SupportAssist OS Recovery tool in the event of certain computer errors. By default, the option is enabled.
BIOSConnect	Enable or disable cloud Service OS recovery if the main operating system fails to boot with the number of failures equal to or greater than the value specified by the Auto OS Recovery Threshold setup option and local Service OS does not boot or is not installed. By default, the option is enabled.
Dell Auto OS Recovery Threshold	Controls the automatic boot flow for SupportAssist System Resolution Console and for Dell OS Recovery Tool. By default, the threshold value is set to 2.

Table 39. System setup options—System Management menu

System Management	
Service Tag	Display the Service Tag of the computer.
Asset Tag	Create a computer Asset Tag.
Wake on LAN/WLAN	Enable or disable the computer to power on by special LAN signals when it receives a wakeup signal from the WLAN. By default, the Disabled option is selected.

Table 39. System setup options—System Management menu (continued)

System Management	
Auto on Time	Enable to set the computer to turn on automatically every day or on a preselected date and time. This option can be configured only if the Auto On Time is set to Everyday, Weekdays, or Selected Days. By default, the option is disabled.
SERR Messages	Enable or disable SERR messages. By default, the option is enabled.
First Power On Date	The Set Ownership Date is disabled by default.
Diagnostics	The option OS Agent Requests
Power-on-Self-Test Automatic Recovery	The option is enabled by default.

Table 40. System setup options—Keyboard menu

Keyboard	
Keyboard Errors	Enable Keyboard Error Detection
	Enable or disable the keyboard error detection. By default, the option is enabled.
Numlock LED	Enable Numlock LED
	Enable or disable Numlock LED. By default, the option is enabled.
Device Configuration Hotkey Access	Device Configuration Hotkey Access
	Enable or disable users to access device configuration by using hotkeys. By default, the option is enabled.

Table 41. System setup options—Pre-boot Behavior menu

Pre-boot Behavior	
Warning and Errors	Enable or disable the action to be done when a warning or error is encountered. By default, the Prompt on Warnings and Errors option is enabled.
Fastboot	Enable to set the speed of the boot process. By default, the option is enabled.
Extend BIOS POST Time	Set the BIOS POST time. By default, the 0 seconds option is enabled.

Table 42. System setup options—Virtualization menu

Virtualization	
Intel Virtualization Technology	Enable Intel Virtualization Technology (VT)
	Specify whether a Virtual Machine Monitor (VMM) can utilize the additional hardware capabilities that are provided by Intel Virtualization Technology. By default, the option is enabled.
VT for Direct I/O	Specify whether a Virtual Machine Monitor (VMM) can utilize the additional hardware capabilities that are provided by Intel Virtualization Technology for Direct I/O. By default, the option is enabled.

Table 42. System setup options—Virtualization menu (continued)

Virtualization	
Intel Trusted Execution Technology (TXT)	
Enable Intel Trusted Execution Technology (TXT)	Specifies whether a measured Virtual Machine Monitor (MVMM) can utilize the additional hardware capabilities that are provided by Intel Trusted Execution Technology. By default, the option is disabled.
DMA Protection	
Enable Pre-Boot DMA Support	The option is enabled by default.
Enable OS Kernel DMA Support	The option is enabled by default.

Table 43. System setup options—Performance menu

Performance	
Multi Core Support	
Active Cores	Enables to change the number of CPU cores available to the operating system. By default, the All Cores options are enabled.
Intel SpeedStep	
Enable Intel SpeedStep Technology	Enables the computer to dynamically adjust processor voltage and core frequency, decreasing average power consumption and heat production. By default, the option is enabled.
C-States Control	
Enable C-State Control	Enable or disable additional processor sleep states. By default, the option is enabled.
Intel Turbo Boost Technology	
Enable Intel Turbo Boost Technology	Enable or disable Intel TurboBoost mode of the processor. By default, the option is enabled.
Intel Hyper-Threading Technology	
Enable Intel Hyper-Threading Technology	Enable or disable Hyper-Threading in the processor. By default, the option is enabled.
PCIe Resizable Base Address Register (BAR)	This option is disabled by default.

Table 44. System setup options—System Logs menu

System Logs	
BIOS Event Log	
Clear BIOS Event Log	Display BIOS events. By default, the Keep option is enabled.

Updating the BIOS

Updating the BIOS in Windows

About this task

CAUTION: If BitLocker is not suspended before updating the BIOS, the next time you reboot the computer it will not recognize the BitLocker key. You will then be prompted to enter the recovery key to progress and the system will ask for this on each reboot. If the recovery key is not known this can result in data loss or an unnecessary operating system re-install. For more information on this subject, search in the Knowledge Base Resource at www.dell.com/support.

Steps

1. Go to www.dell.com/support.
2. Click **Product support**. In the **Search support** box, enter the Service Tag of your computer, and then click **Search**.
NOTE: If you do not have the Service Tag, use the SupportAssist feature to automatically identify your computer. You can also use the product ID or manually browse for your computer model.
3. Click **Drivers & Downloads**. Expand **Find drivers**.
4. Select the operating system installed on your computer.
5. In the **Category** drop-down list, select **BIOS**.
6. Select the latest version of BIOS, and click **Download** to download the BIOS file for your computer.
7. After the download is complete, browse the folder where you saved the BIOS update file.
8. Double-click the BIOS update file icon and follow the on-screen instructions.
For more information, search in the Knowledge Base Resource at www.dell.com/support.

Updating the BIOS in Linux and Ubuntu

To update the system BIOS on a computer that is installed with Linux or Ubuntu, see the knowledge base article [000131486](https://www.dell.com/support/000131486) at www.dell.com/support.

Updating the BIOS using the USB drive in Windows

About this task

CAUTION: If BitLocker is not suspended before updating the BIOS, the next time you reboot the system it will not recognize the BitLocker key. You will then be prompted to enter the recovery key to progress and the system will ask for this on each reboot. If the recovery key is not known this can result in data loss or an unnecessary operating system re-install. For more information on this subject, search in the Knowledge Base Resource at www.dell.com/support.

Steps

1. Follow the procedure from step 1 to step 6 in [Updating the BIOS in Windows](#) to download the latest BIOS setup program file.
2. Create a bootable USB drive. For more information, search in the Knowledge Base Resource at www.dell.com/support.
3. Copy the BIOS setup program file to the bootable USB drive.
4. Connect the bootable USB drive to the computer that needs the BIOS update.
5. Restart the computer and press **F12**.
6. Select the USB drive from the **One Time Boot Menu**.
7. Type the BIOS setup program filename and press **Enter**.
The **BIOS Update Utility** appears.
8. Follow the on-screen instructions to complete the BIOS update.

Updating the BIOS from the F12 One-Time boot menu

Update your computer BIOS using the BIOS update.exe file that is copied to a FAT32 USB drive and booting from the F12 One-Time boot menu.

About this task

CAUTION: If BitLocker is not suspended before updating the BIOS, the next time you reboot the computer it will not recognize the BitLocker key. You will then be prompted to enter the recovery key to progress and the computer will ask for this on each reboot. If the recovery key is not known this can result in data loss or an unnecessary operating system re-install. For more information on this subject, search in the Knowledge Base Resource at www.dell.com/support.

BIOS Update

You can run the BIOS update file from Windows using a bootable USB drive or you can also update the BIOS from the F12 One-Time boot menu on the computer.

Most of the Dell computers built after 2012 have this capability, and you can confirm by booting your computer to the F12 One-Time Boot Menu to see if BIOS FLASH UPDATE is listed as a boot option for your computer. If the option is listed, then the BIOS supports this BIOS update option.

NOTE: Only computers with BIOS Flash Update option in the F12 One-Time boot menu can use this function.

Updating from the One-Time boot menu

To update your BIOS from the F12 One-Time boot menu, you need the following:

- USB drive formatted to the FAT32 file system (key does not have to be bootable)
- BIOS executable file that you downloaded from the Dell Support website and copied to the root of the USB drive
- AC power adapter that is connected to the computer
- Functional computer battery to flash the BIOS

Perform the following steps to perform the BIOS update flash process from the F12 menu:

CAUTION: Do not turn off the computer during the BIOS update process. The computer may not boot if you turn off your computer.

Steps

1. From a turn off state, insert the USB drive where you copied the flash into a USB port of the computer.
2. Turn on the computer and press F12 to access the One-Time Boot Menu, select BIOS Update using the mouse or arrow keys then press Enter.
The flash BIOS menu is displayed.
3. Click **Flash from file**.
4. Select external USB device.
5. Select the file and double-click the flash target file, and then click **Submit**.
6. Click **Update BIOS**. The computer restarts to flash the BIOS.
7. The computer will restart after the BIOS update is completed.

System and setup password

Table 45. System and setup password

Password type	Description
System password	Password that you must enter to log in to your system.
Setup password	Password that you must enter to access and make changes to the BIOS settings of your computer.

You can create a system password and a setup password to secure your computer.

 **CAUTION:** The password features provide a basic level of security for the data on your computer.

 **CAUTION:** Anyone can access the data that is stored on your computer if it is not locked and left unattended.

 **NOTE:** System and setup password feature is disabled.

Assigning a System Setup password

Prerequisites

You can assign a new **System or Admin Password** only when the status is in **Not Set**.

About this task

To enter BIOS System Setup, press F2 immediately after a power-on or reboot.

Steps

1. In the **System BIOS** or **System Setup** screen, select **Security** and press Enter.
The **Security** screen is visible.
2. Select **System/Admin Password** and create a password in the **Enter the new password** field.
Use the following guidelines to assign the system password:
 - A password can have up to 32 characters.
 - At least one special character: ! " # \$ % & ' () * + , - . / : ; < = > ? @ [\] ^ _ ` { | }
 - Numbers 0 through 9.
 - Upper case letters from A to Z.
 - Lower case letters from a to z.
3. Type the system password that you entered earlier in the **Confirm new password** field and click **OK**.
4. Press Esc and save the changes as prompted by the pop-up message.
5. Press Y to save the changes.
The computer restarts.

Deleting or changing an existing system setup password

Prerequisites

Ensure that the **Password Status** is Unlocked (in the System Setup) before attempting to delete or change the existing System and/or Setup password. You cannot delete or change an existing System or Setup password, if the **Password Status** is Locked.

About this task

To enter the System Setup, press F12 immediately after a power-on or reboot.

Steps

1. In the **System BIOS** or **System Setup** screen, select **System Security** and press Enter.
The **System Security** screen is displayed.
2. In the **System Security** screen, verify that **Password Status** is **Unlocked**.
3. Select **System Password**, update, or delete the existing system password, and press Enter or Tab.
4. Select **Setup Password**, update, or delete the existing setup password, and press Enter or Tab.
 **NOTE:** If you change the System and/or Setup password, reenter the new password when prompted. If you delete the System and/or Setup password, confirm the deletion when prompted.
5. Press Esc and a message prompts you to save the changes.
6. Press Y to save the changes and exit from System Setup.
The computer restarts.

Clearing BIOS (System Setup) and System passwords

About this task

To clear the system or BIOS passwords, contact Dell technical support as described at www.dell.com/contactdell.

 **NOTE:** For information on how to reset Windows or application passwords, refer to the documentation accompanying Windows or your application.

Troubleshooting

Dell SupportAssist Pre-boot System Performance Check diagnostics

About this task

SupportAssist diagnostics (also known as system diagnostics) performs a complete check of your hardware. The Dell SupportAssist Pre-boot System Performance Check diagnostics is embedded with the BIOS and is launched by the BIOS internally. The embedded system diagnostics provides a set of options for particular devices or device groups allowing you to:

- Run tests automatically or in an interactive mode
- Repeat tests
- Display or save test results
- Run thorough tests to introduce additional test options to provide extra information about the failed device(s)
- View status messages that inform you if tests are completed successfully
- View error messages that inform you of problems encountered during testing

 **NOTE:** Some tests for specific devices require user interaction. Always ensure that you are present at the computer terminal when the diagnostic tests are performed.

For more information, see the knowledge base article [000180971](#).

Running the SupportAssist Pre-Boot System Performance Check

Steps

1. Turn on your computer.
2. As the computer boots, press the F12 key as the Dell logo appears.
3. On the boot menu screen, select the **Diagnostics** option.
4. Click the arrow at the bottom left corner.
Diagnostics front page is displayed.
5. Click the arrow in the lower-right corner to go to the page listing.
The items detected are listed.
6. To run a diagnostic test on a specific device, press Esc and click **Yes** to stop the diagnostic test.
7. Select the device from the left pane and click **Run Tests**.
8. If there are any issues, error codes are displayed.
Note the error code and validation number and contact Dell.

Power-Supply Unit Built-in Self-Test

Built-in Self-Test (BIST) helps determine if the power-supply unit is working. To run self-test diagnostics on the power-supply unit of a desktop or all-in-one computer, search in the Knowledge Base Resource at www.dell.com/support.

System-diagnostic lights

Table 46. Diagnostic LED behavior

Blinking pattern		Problem description
Amber	White	
1	1	TPM Detection Failure
1	2	Unrecoverable SPI Flash Failure
1	3	Short in hinge cable tripped OCP1
1	4	Short in hinge cable tripped OCP2
1	5	EC unable to program i-Fuse
1	6	Generic catch-all for ungraceful EC code flow errors
1	7	Non-RPMC Flash on Boot Guard fused system
2	1	CPU failure
2	2	Motherboard, covers BIOS corruption or ROM error
2	3	No Memory/RAM detected
2	4	Memory/RAM failure
2	5	Invalid memory installed
2	6	Motherboard/Chipset Error
2	7	LCD failure - SBIOS message
2	8	Motherboard - EC detection of LCD power rail failure
3	1	CMOS battery failure
3	2	PCI of Video card/chip failure
3	3	Recovery Image not found
3	4	Recovery image found but not valid
3	5	EC ran into power sequencing failure
3	6	Flash corruption detected by SBIOS
3	7	Timeout waiting on ME to reply to HECI message
4	1	Memory DIMM power rail failure
4	2	CPU Power Cable Connection Issue

Recovering the operating system

When your computer is unable to boot to the operating system even after repeated attempts, it automatically starts Dell SupportAssist OS Recovery.

Dell SupportAssist OS Recovery is a standalone tool that is preinstalled in all Dell computers installed with Windows operating system. It consists of tools to diagnose and troubleshoot issues that may occur before your computer boots to the operating

system. It enables you to diagnose hardware issues, repair your computer, back up your files, or restore your computer to its factory state.

You can also download it from the Dell Support website to troubleshoot and fix your computer when it fails to boot into their primary operating system due to software or hardware failures.

For more information about the Dell SupportAssist OS Recovery, see *Dell SupportAssist OS Recovery User's Guide* at www.dell.com/serviceabilitytools. Click **SupportAssist** and then, click **SupportAssist OS Recovery**.

Real Time Clock—RTC reset

The Real Time Clock (RTC) reset function allows you or the service technician to recover the recently launched model Dell Latitude and Precision systems from **No POST/No Boot/No Power** situations. You can initiate the RTC reset on the system from a power-off state only if it is connected to AC power. Press and hold the power button for 25 seconds. The system RTC reset occurs after you release the power button.

NOTE: If AC power is disconnected from the system during the process or the power button is held longer than 40 seconds, the RTC reset process gets aborted.

The RTC reset will reset the BIOS to Defaults, un-provision Intel vPro and reset the system date and time. The following items are unaffected by the RTC reset:

- Service Tag
- Asset Tag
- Ownership Tag
- Admin Password
- System Password
- HDD Password
- Key Databases
- System Logs

NOTE: The IT administrator's vPro account and password on the system will be un-provisioned. The system needs to go through the setup and configuration process again to reconnect it to the vPro server.

The below items may or may not reset based on your custom BIOS setting selections:

- Boot List
- Enable Legacy Option ROMs
- Secure Boot Enable
- Allow BIOS Downgrade

Backup media and recovery options

It is recommended to create a recovery drive to troubleshoot and fix problems that may occur with Windows. Dell proposes multiple options for recovering Windows operating system on your Dell PC. For more information, see [Dell Windows Backup Media and Recovery Options](#).

Wi-Fi power cycle

About this task

If your computer is unable to access the Internet due to Wi-Fi connectivity issues a Wi-Fi power cycle procedure may be performed. The following procedure provides the instructions on how to conduct a Wi-Fi power cycle:

NOTE: Some ISPs (Internet Service Providers) provide a modem/router combo device.

Steps

1. Turn off your computer.
2. Turn off the modem.
3. Turn off the wireless router.



4. Wait for 30 seconds.
5. Turn on the wireless router.
6. Turn on the modem.
7. Turn on your computer.

Getting help and contacting Dell

Self-help resources

You can get information and help on Dell products and services using these self-help resources:

Table 47. Self-help resources

Self-help resources	Resource location
Information about Dell products and services	www.dell.com
My Dell app	
Tips	
Contact Support	In Windows search, type <code>Contact Support</code> , and press Enter.
Online help for operating system	www.dell.com/support/windows www.dell.com/support/linux
Access top solutions, diagnostics, drivers and downloads, and learn more about your computer through videos, manuals and documents.	Your Dell computer is uniquely identified by a Service Tag or Express Service Code. To view relevant support resources for your Dell computer, enter the Service Tag or Express Service Code at www.dell.com/support . For more information on how to find the Service Tag for your computer, see Locate the Service Tag on your computer .
Dell knowledge base articles for a variety of computer concerns	<ol style="list-style-type: none"> 1. Go to www.dell.com/support. 2. On the menu bar at the top of the Support page, select Support > Knowledge Base. 3. In the Search field on the Knowledge Base page, type the keyword, topic, or model number, and then click or tap the search icon to view the related articles.

Contacting Dell

To contact Dell for sales, technical support, or customer service issues, see www.dell.com/contactdell.

 **NOTE:** Availability varies by country/region and product, and some services may not be available in your country/region.

 **NOTE:** If you do not have an active Internet connection, you can find contact information about your purchase invoice, packing slip, bill, or Dell product catalog.