



# Professional display

## Safety & Recommendations

[English](#)

[Deutsch](#)

[Nederlands](#)

[Français](#)

[Español](#)

## Table of contents

|                                       |          |
|---------------------------------------|----------|
| <b>01 IMPORTANT INFORMATION</b>       | <b>3</b> |
| <b>1.1 USE</b>                        | <b>3</b> |
| <b>1.2 EXEMPTIONS</b>                 | <b>4</b> |
| <b>02 SAFETY INSTRUCTIONS</b>         | <b>4</b> |
| <b>2.1 SAFETY PRECAUTIONS</b>         | <b>4</b> |
| <b>2.2 MOVING AND CARRYING NOTICE</b> | <b>5</b> |
| <b>2.3 INSTALLATION</b>               | <b>5</b> |
| <b>2.4 WALLMOUNT SAFETY NOTICE</b>    | <b>6</b> |
| <b>2.5 RECOMMENDED USE</b>            | <b>7</b> |
| <b>2.6 CLEANING</b>                   | <b>8</b> |
| <b>03 WARRANTY DETAILS</b>            | <b>9</b> |
| <b>3.1 STANDARD WARRANTY A</b>        | <b>9</b> |
| <b>3.2 STANDARD WARRANTY B</b>        | <b>9</b> |
| <b>3.3 ADDITIONAL WARRANTY</b>        | <b>9</b> |

# IMPORTANT INFORMATION

## 1. IMPORTANT INFORMATION



**WARNING:**

TO PREVENT FIRE OR SHOCK HAZARDS, DO NOT EXPOSE THIS UNIT TO RAIN OR MOISTURE. ALSO, DO NOT USE THIS UNIT'S POLARIZED PLUG WITH AN EXTENSION CORD RECEPTACLE OR OTHER OUTLETS UNLESS THE PRONGS CAN BE FULLY INSERTED. REFRAIN FROM OPENING THE SCREEN'S HOUSING AS THERE ARE HIGH VOLTAGE COMPONENTS INSIDE.



**CAUTION:**

TO REDUCE THE RISK OF ELECTRIC SHOCK, MAKE SURE POWER CORD IS UNPLUGGED FROM WALL SOCKET. TO FULLY DISENGAGE THE POWER TO THE UNIT, PLEASE DISCONNECT THE POWER CORD FROM THE AC OUTLET. DO NOT REMOVE COVER (OR BACK). NO USER SERVICEABLE PARTS INSIDE. REFER SERVICING TO QUALIFIED SERVICE.



**WARNING:**

FOR CONTINUED SAFETY, DEVICES WITH CLASS I CONSTRUCTION SHALL BE CONNECTED TO A MAIN SOCKET OUTLET WITH A PROTECTIVE EARTHING CONNECTION.



**WARNING:**

THIS IS A CLASS A PRODUCT MEANT TO BE USED IN PROFESSIONAL ENVIRONMENTS. - THIS PRODUCT MUST NOT BE USED IN RESIDENTIAL AREAS.

### 1.1. USE

- Transport the product upright with proper packaging. Avoid placing the product face up or down. Handle with care!
- Do not send a static (non-moving) image to the screen, it may cause image 'burn-in' or image retention.
- "Burn in" and/or image retention is not covered under warranty.
- Make sure to change the image on the screen periodically. It is recommended to turn off the e-screen for at least 6 hours after 16 hours of usage in a 24-hour period to help avoid image retention.

# SAFETY INSTRUCTIONS

## 1.2. EXEMPTIONS

- This product isn't warranted for any damage caused by natural disaster (such as earthquake, thunder, etc.), fire, acts by third parties, accidents, owner's intentional misuse and fault, or use in other improper conditions.
- This product isn't warranted for incidental damages (such as profit loss or interruption in business, modification or erasure of record data, etc.) caused by use or inability to use of this product.
- This product isn't warranted for any damage caused by inappropriate operation, or from not following the user manual.
- This product isn't warranted for any damage caused by misuse or malfunction through simultaneous use of this product and the connected equipment or software.
- This product isn't warranted for any damage caused by neglect of the installation instructions.
- This product isn't warranted for any damage caused by improper installation.
- This product isn't warranted for any damage caused by disassembly, modification or repair by non-authorized service centers or people.

## 2. SAFETY INSTRUCTIONS

Before using this screen, please read this user manual thoroughly to help protect against property damage and to ensure your personal safety and the safety of others.

- Read and follow all instructions and safety-warnings found in this manual.
- For installation or adjustment, please follow the instructions in this manual and refer all servicing to qualified service personnel.

## 2.1 SAFETY PRECAUTIONS

**If smoke or a peculiar smell comes from the Screen, remove the power plug from the outlet immediately.** Failure to do so may result in fire or electrical shock.

Contact your dealer for inspection.

**If the Screen has been turned on but there is no picture, remove the power plug from the outlet immediately.** Failure to do so may result in fire or electrical shock.

Contact your dealer for inspection.

**If water is spilled or objects are dropped inside the Screen, remove the power plug from the outlet immediately.** Failure to do so may result in fire or electrical shock.

Contact your dealer for inspection.

**If the Screen is dropped or the screen's housing is damaged, remove the power plug from the outlet immediately.** Failure to do so may result in fire or electrical shock.

Contact your dealer for inspection.

**If the power cord or plug is damaged or becomes hot, turn off the main power switch of the Screen, make sure the power plug has cooled down and remove the power plug from the outlet.**

If the Screen is still used in this condition, it may cause fire or electrical shock. Contact your dealer for replacement.

# SAFETY INSTRUCTIONS

## 2.2 MOVING AND CARRYING NOTICE

### Moving the product:

Moving the product may require up to four people. Attempting to move the product with fewer people may result in damage to the product or in serious injury of the people handling the screen. When moving a display in its shipping carton, lift the carton using the white handles.



### Carrying the product:

This product is heavy; please follow proper lifting techniques, as pictured below. Failure to do so may cause injury.



## 2.3 INSTALLATION

### Don't install in a high-temperature environment.

If the screen is used in high-temperatures or in direct sunlight, it may cause the housing of the product or other parts to become distorted or damaged, resulting in overheating or electrical shock.

### Don't install in a high-humidity environment.

This may cause overheating or electrical shock.

### Don't install near any heat sources such as radiators, heat registers, stoves, or other apparatus that produce heat.

This may cause fire or electrical shock.

**Don't overload outlets or cables beyond electrical capacity.** Don't use extension cords as it may cause fire or electrical shock.

**Don't insert the power plug into an outlet other than 100~240V AC.**

This may cause fire or electrical shock.

- Don't use a damaged power plug or worn outlet.
- Don't insert an improper power plug it may cause fire or electric shock.

**Don't place the screen on an unstable shelf or surface.** The screen may fall, causing injury. Please install on a horizontal, stable, level surface.

### Don't place objects on the e-screen.

- If the screen is covered or the vents are blocked, the display could overheat and cause a fire.
- If objects or liquids get inside the screen, this may cause fire or electrical shock.
- Do not put heavy objects on the screen as they may fall, causing injury.
- Please keep a 10 cm minimum distance between screen, wall and/or other objects to ensure sufficient ventilation.

# SAFETY INSTRUCTIONS

Don't move the screen when it is connected to the power cord and AV cables.

- When moving the e-screen, make sure to remove all cables first.
- When unpacking or carrying the screen, up to 4 people might be needed. Make sure the screen is carried upright.
- Transport the screen upright. Avoid placing the e-screen face up or down.
- Handle the screen gently. Do not drop.

## 2.4 WALLMOUNT SAFETY NOTICE

1. Please make sure that the bracket is mounted on a solid surface.

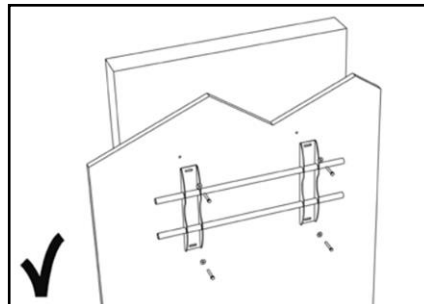
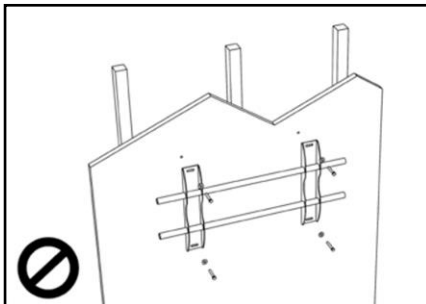

2. After mounting the screen, do not pull, push or shake the screen.

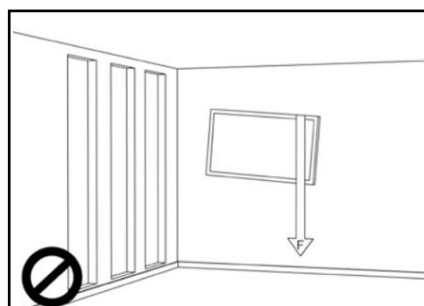
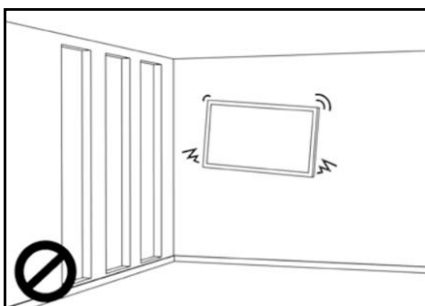

# SAFETY INSTRUCTIONS

1. Do not install screens in direct sunlight, humid conditions, or high temperatures.

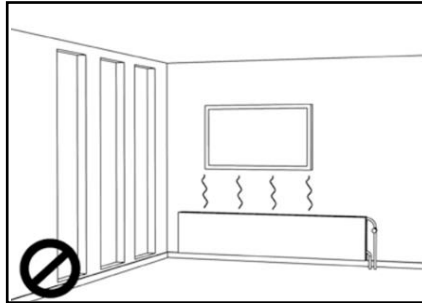
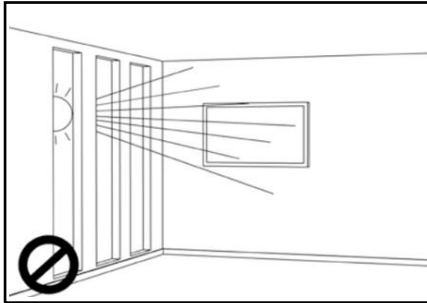

4.

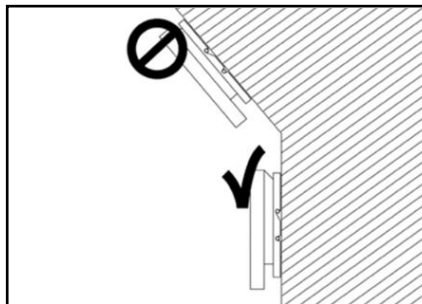
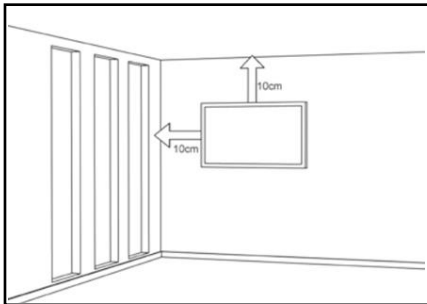

## 2.5 RECOMMENDED USE

If you encounter a problem during installation, please contact your supplier for assistance. Don't repair or open the screen by yourself. Failure to do so may result in fire or electrical shock.

Contact your dealer for inspection.

Protect and correctly use the power cord/plug.

- Don't pinch the power cord/plug between hard surfaces.
- Don't step on the power cord/plug.
- Before inserting the power plug into the wall outlet, connect the power cord to the display.
- Using an screen with a damaged or non-original power cord can damage the screen, cause fires or electrical shocks.

Using extension cords (not recommended)

If an extension cord must be used, ensure the voltage rating exceeds the max power consumption of the display. If the voltage rating is less than the display, it will cause the extension cord to overheat.

Do not operate the screen during thunder or lightning.

Remove the powerplug from the power outlet.

# SAFETY INSTRUCTIONS

**Don't use any kind of liquid on the screen.**

- If liquid is spilled on the screen, remove the power plug from the wall socket and ask qualified service personnel to check the product.
- If liquid gets on screens glass plate, clean it with a dry and soft cloth immediately.
- Don't use any chemicals on the screen.
- If metal or liquids get into the screen, it may cause a fire or an electrical shock.

**Don't install or remove the power plug with wet hands.** This may cause an electrical shock.

**If the screen will not be used for a long period of time, unplug the display. Preventing to do so may cause premature wear of electrical components or fire.**

**Handle the screen with care, prevent glass breakage.**

- If the glass of the screen is broken, liquids may escape. Please don't touch the liquid.
- If these liquids come into contact with skin or eyes, immediately wash it away with clean water and consult a medical professional.

**Precautions with the remote-control batteries**

- Please only use approved AAA type batteries.
- Please be sure to insert batteries by matching the + and -.
- Don't recharge, heat, disassemble, short or throw batteries into a fire.
- Don't mix a new battery with a used one.
- Don't mix different types of batteries together (only use the specified type).

## 2.6 CLEANING

Remove the power plug from the power outlet before cleaning.

Failure to do so may result in electrical shock or damage.

Cleaning the surface of the screen

- When the surface of the screen becomes dirty, wipe the surface lightly with a soft, clean cloth.
- If the surface requires additional cleaning, lightly moisten the cloth.
- Do not to let any kind of liquid enter the screen as it may cause electrical shock or damage.
- Do not clean the screen with alcohol, solvents or ammonia, as this could damage the e-screen.



# WARRANTY DETAILS

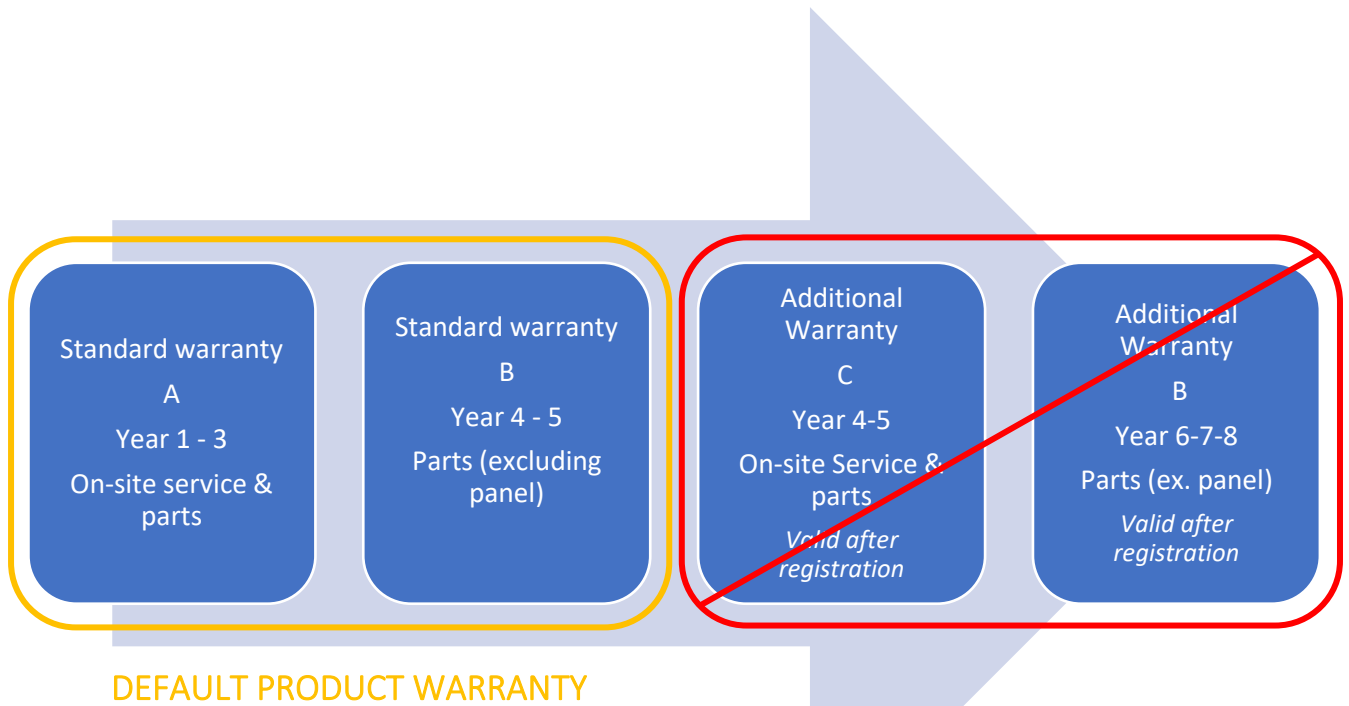

## 3.1 STANDARD WARRANTY A

Legamaster guarantees 'on-site' repair of the product for a period of 3 years. When necessary and at the discretion of Legamaster International B.V., a defective unit can be replaced by a similar – functioning – unit in at least the same condition, whereas the remainder of the original warranty-period will be transferred to the replacement unit.

Replacement parts used in repairing a defective product are warranted to be free from defects and to remain so during the remainder of the original warranty period of the product. Replacement parts do not prolong the warranty period of the product.

## 3.2 STANDARD WARRANTY B

In year 4 and 5 of the life-time of the product (calculated from the date of purchase as mentioned on the invoice) Legamaster International B.V. offers an additional 2 year warranty period on parts and/or components, excluding the panel of the product. During this 3 year period, following conditions apply:

In year 4 and 5 Legamaster International B.V. guarantees the replacement of defective parts and / or components of the product, excluding the panel of the product. Legamaster B.V. will offer the end-user a replacement component for the defective component that is warranted to be free from defects and to remain so for the remainder of the warranty-period of the product. Replacement parts do not prolong the warranty period of the product.

During this warranty period, if needed, Legamaster International B.V. will assist end-user in repairing the defective unit, either on-site or when needed at our own service department in Lochem, Netherlands. The end-user will be charged – after consultation with the end-user – a service fee of which the amount is dependent on the labor time and travelling distance needed to perform the mentioned repair.

When necessary and at the discretion of Legamaster International B.V., a defective unit can be replaced by a similar – functioning – unit in at least the same condition, whereas the remainder of the original warranty-period will be transferred to the replacement unit.

## 3.3 ADDITIONAL WARRANTY

On applicable products sold in applicable markets Legamaster B.V. can offer an additional warranty option, as specified under 'Additional Warranty C' and 'Additional Warranty B'.

Please head over to [legamaster.com/service/warranty](https://legamaster.com/service/warranty) for more information about our warranty details.

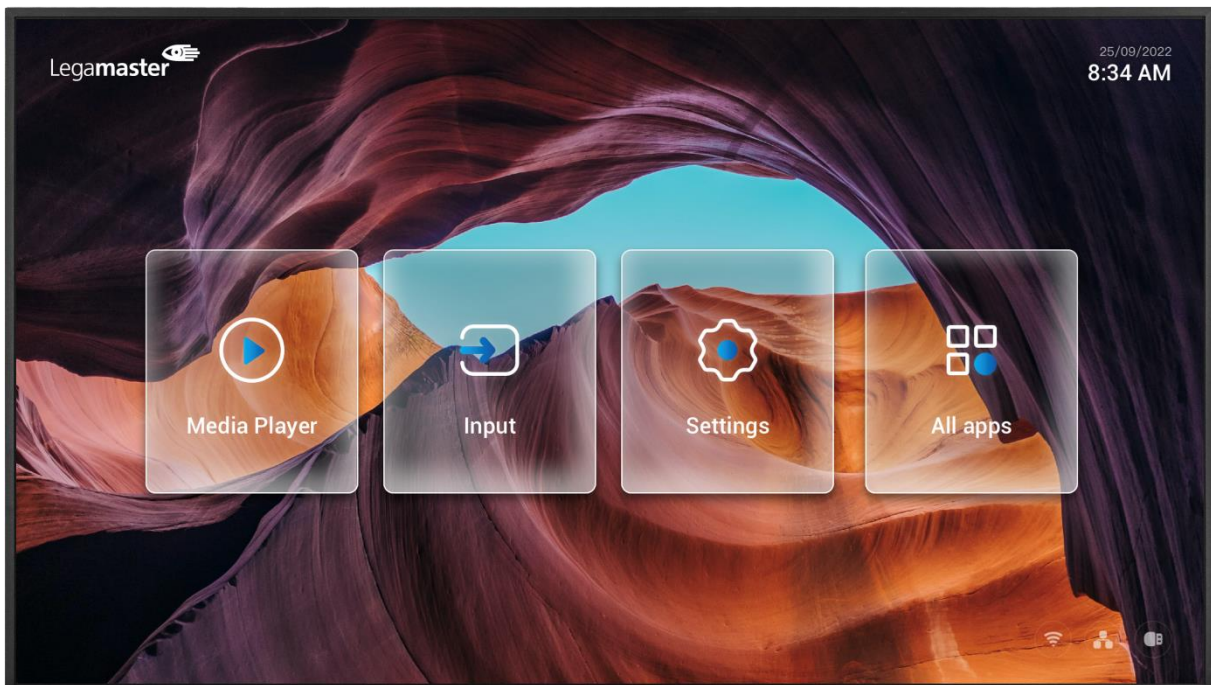

## Discover 2 Professional display Product Content & Operation

[English](#)

[Deutsch](#)

[Nederlands](#)

[Français](#)

[Español](#)

## Table of contents

|   |    |
|---|----|
| <b>01 PACKAGE CONTENT</b>                 |    |
| 1.1 UNPACKING                             | 12 |
| 1.2 INCLUDED ACCESORIES                   | 12 |
| <b>02 INSTALLATION</b>                    |    |
| 2.1 ENVIROMENT CONDITIONS                 | 12 |
| 2.2 GENERAL OVERVIEW OF THE SCREEN        | 13 |
| 2.3 INPUT / OUTPUT CONNECTOR INFORMATION  | 14 |
| 2.4 REMOTE CONTROL                        | 14 |
| 2.4.1 CHANGING THE REMOTE-CONTROL BATTERY | 15 |
| <b>03 OPERATING THE SCREEN</b>            |    |
| 3.1 TURNING THE DISPLAY ON AND OFF        | 15 |
| 3.2 SETTINGS MENU                         | 16 |
| 3.3 UPDATING THE SCREEN                   | 19 |
| 3.4 ENABLING THE TILING FUNCTION          | 19 |
| 3.5 DROPIING CONTENT TO YOUR SCREEN       | 20 |
| 3.6 AUTO-ROTATING FUNCTION                | 20 |
| <b>04 TROUBLESHOOTING</b>                 | 20 |

# PACKAGE CONTENT / INSTALLATION

## 1. PACKAGE CONTENT

### 1.1. UNPACKING

- The Professional Display is packed using cushions to protect the product during shipping.
- Before unpacking, prepare a stable, level, and clean surface near a wall outlet.
- Step 1: Place the box in an up-right stable position.
- Step 2: Remove the white handles and cut the banding
- Step 3: Smoothly lift the upper part of the box, this will reveal the Professional Display box content
- Step 4: Remove the top cushion and take the accessory bag out.
- Step 5: Extend the bag up and carefully cut the upper layer to unseal the Professional Display
- Step 6: Prepare your screen for installation, and then remove it from the box by lifting it.

### 1.2. INCLUDED ACCESORIES.

| ITEMS           |
|-----------------|
| Power Cord 1.8m |
| Remote Control  |
| Wi-Fi Adapter   |

## 2. INSTALLATION

### 2.1 ENVIROMENT CONDITIONS

When operating the screen, ambient room conditions should not exceed the following:

- Operating temperature: 0°C to 40°C (32°F to 104°F)
- Humidity: less than 90% RH (Max)

# OVERVIEW

## 2.2 GENERAL OVERVIEW OF THE SCREEN

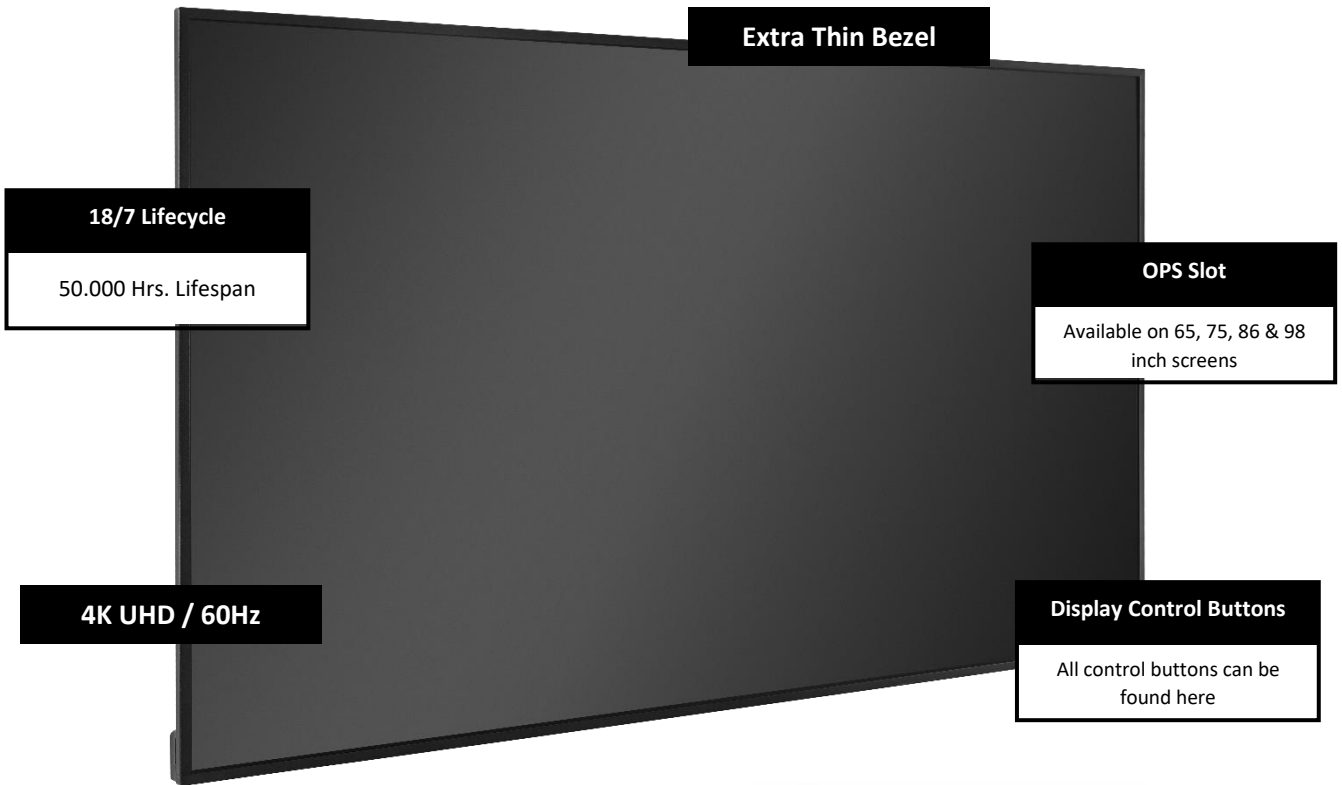

# OVERVIEW

## 2.3 INPUT / OUTPUT CONNECTOR INFORMATION

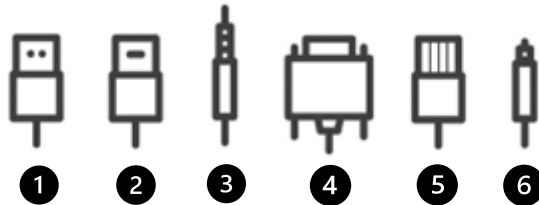

- 1 USB-A 2.0 (x2)
- 2 HDMI 2.0 (x2 or x3 Model related)
- 3 Minijack 3,5 Stereo Out (x1)
- 4 RS-232 (Serial)
- 5 RJ-45 (x1 IN) / RJ-45 (x1 Out)
- 6 SPDIF (Optical Audio)

## 2.4 REMOTE CONTROL

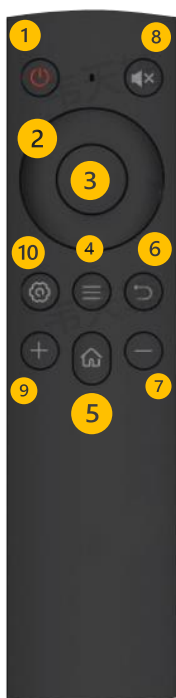

- 1 Turn the display ON and OFF.
- 2 Navigation Buttons Easy navigation wheel
- 3 Select / Confirm: Confirm your on screen selection
- 4 Settings MENU Direct access to the main settings MENU
- 5 Home: Head directly to the main home page
- 6 Back / Return to previous MENU Returns to the previously selection.
- 7 Volume Down Lowers the audio volume.
- 8 Mute: Silence Audio output
- 9 Volume Up Raises the audio volume.
- 10 Quick Menu Will open a quick menu for some quick settings options.

# OVERVIEW / OPERATING THE SCREEN

## 2.4.1 CHANGING THE REMOTE-CONTROL BATTERY

### 1. Remove the battery cover:

On the backside of the remote-control, slide down the battery cover.

### 2. Insert batteries:

Use two AAA batteries and insert them according to the plus and minus indicators in the remote control.

### 3. Close the battery cover by sliding it back into place.

I. Discard batteries according to the local waste reduction and recovery regulations.

II. Do not keep used, empty batteries in the remote control. They can leak and result in damages to the remote control.

III. Only use batteries according to the instructions and regulations found in this manual and to the instructions and regulations set forth by the batterie's manufacturer.

#### About the remote control

- Do not drop, shake, or bump.
- Avoid moist conditions, liquids, high-temperatures and/or exposure to direct sunlight.
- Don't dismantle.

## 3.1 TURNING THE DISPLAY ON AND OFF

Please make sure the display is connected to an AC power-socket using the supplied power cable.

Set the AC-switch to "I". The Professional Display will start up, if not.

To switch the display on, push the power-button on the screen once, or push the power-button on the remote control.

To switch the display off, press the power-button on the screen, or push the power button on the remote control. The display will switch to stand-by mode.

To turn off power completely, turn the AC switch to "O" or disconnect the AC power cord from the power outlet.

# OPERATING THE SCREEN

## 3.2 SETTINGS MENU

| Main Settings      | Setting category  | Level1   | Level2                  | Explanation                                 |   |
|--------------------|---|--|-------------------------|---|---|
| WIRELESS & NETWORK | Wi-Fi   | Wi-Fi  | ON/OFF                  | Toggle Wi-Fi on and off                     |   |
|                    |   | Choose a Network   |                         | Select an available network to connect to   |   |
|                    |   | For Manually adding a network you may select the + sign on the top right corner  |                         |   |   |
|                    |   | More Wi-Fi preferences are available on the integrated Wi-Fi menu on the top right corner (network certificate installing, IP address and MAC address) |                         |   |   |
|                    | Ethernet  | Ethernet   | ON/OFF                  |   | Toggles the Ethernet connection on and off                      |
|                    |   | MAC address  |                         |   | shows the MAC address for the wired connection                  |
|                    |   | IP address Automatic   | ON/OFF                  |   | Toggles the manual and automatic IP configuration               |
|                    |   | IP Address   |                         |   | IP address used by the device                                   |
|                    |   | Default Gateway  |                         |   | Default Gateway used by the device                              |
|                    |   | Netmask  |                         |   | Netmask used by the device                                      |
|                    |   | DNS 1  |                         |   | DNS 1 Information   |
|                    |   | DNS 2  |                         |   | DNS 2 Information   |
|                    | Hotspot   | Proxy  | None/ Manual/ Automatic |   | Select the proxy configuration                                  |
|                    |   | Hotspot  | ON/OFF                  |   | Toggle the hotspot-functionality on / off                       |
|                    |   | Hotspot Name   |                         |   | Set-up the hotspot's Name (SSID)                                |
|                    | Bluetooth   | Hotspot Password   |                         |   | Set-up the hotspot's Password                                   |
|                    |   | Bluetooth  |                         |   | Toggle Bluetooth on/ off, show / connect with available devices |
|                    | More Bluetooth preferences are available on the integrated menu on the top right corner (Renaming & Received files) |  |                         |   |   |
|                    | VPN   | Add VPN  |                         |   | Add a VPN for encrypted network connection                      |
|                    | SAMBA Service   | Samba Logging  |                         |   | SAMBA Logging information                                       |
|                    |   | Samba Password setting   |                         |   | Allows you to set a security password for the SAMBA protocol    |
|                    | Hostname  |  |                         |   | Allows you to modify the hostname of the screen                 |
|                    | PERSONAL  | Wallpaper  | Still                   |   | Select a still image to use as background                       |
| Dynamic            |   |  |                         | Select a dynamic image to use as background |   |
| Auto-Rotate        |   | ON/OFF   |                         |   | Toggle the autorotation for the screen (Landscape/Portrait)     |



## OPERATING THE SCREEN

| Main Settings  | Setting category  | Level1                    | Level2                | Explanation   |   |
|----------------|---|---------------------------|-----------------------|---|---|
| INPUT & OUTPUT | Sound   | Touch Sounds              | ON/OFF                | Toggle touch sounds for option selections                                       |   |
|                |   | Sound Output Settings     | Speaker/Lineout/Mixed | Select the audio output settings  |   |
|                | Input Settings  | ON/OFF                    |                       | Input naming settings   |   |
|                | External Source Display Settings  | inLink CEC                | ON/OFF                |   | Toggle the inLink CEC function          |
|                |   | Tiling                    |                       | ON/OFF  | Toggle tiling function<br>ON/OFF        |
|                |   |                           | H Monitors            |   | Set the number of horizontal monitors   |
|                |   |                           | V Monitors            |   | Set the number of vertical monitors     |
|                |   |                           | Position              |   | Position of screen in the tiling scheme |
| Frame Comp     |   | Toggle frame compensation |                       |   |   |
| Application    | Application list  |                           |                       | List of installed apps, disable, force stop, open by default, permissions, etc) |   |
|                | More Application preferences are available on the integrated menu on the top right corner (Show system Apps, Reset App preferences) |                           |                       |   |   |

## OPERATING THE SCREEN

| Main Settings | Setting category    | Level1                                      | Level2   | Explanation                                      |
|---------------|---------------------|---|--|--|
| SYSTEM        | Date & Time         | Use 24-Hour Format                          | ON/OFF   | Toggle the use of the 24-Hour format ON/OFF      |
|               |                     | Automatic Data & Time                       | ON/OFF   | Toggle automatic date & time ON/OFF              |
|               |                     | Date Format                                 |  | Select your date format                          |
|               |                     | Time Zone                                   |  | Select your time zone                            |
|               | Language & Keyboard | Languages                                   |  | Select your language                             |
|               |                     | Virtual Keyboard                            |  | Select a virtual keyboard input                  |
|               |                     | Physical Keyboard                           |  | Select a physical keyboard input                 |
|               | Region              |   |  | Select your Region                               |
|               | Pixel Pitch         | OFF/ interval 2, 3, 5, 30, 60 minutes       |  | Select your pixel pitch interval                 |
|               | Switch Delay        | OFF/ 2, 5, 10, 15, 30, 40, 50, 60 seconds   |  | Select your device switch ON delay               |
|               | Storage             |   |  | Internal storage space used                      |
|               | System Updates      | System version                              |  | Current system version on the device             |
|               |                     | Check for updates                           |  | Check for online updates                         |
|               | Advanced settings   | Install unknown Apps                        | ON/OFF   | Toggle the unknown apps installation ON/OFF      |
|               |                     | Enable USB Drive                            | ON/OFF   | Toggle the recognition of external drives ON/OFF |
|               |                     | LED Control                                 | ON/OFF   | Toggle the frontal LED ON/OFF                    |
|               |                     | Remote control Lock                         | OFF/All/ Except Power & Volume                 | Lock the Remote-control functionality            |
|               |                     | Keypad Lock                                 | OFF/All/ Power Lock/ Power & Input & Menu Lock | Lock the keypad functionality                    |
|               |                     | System Lock                                 |  | Lock the entire system                           |
|               |                     | Reset Factory                               |  | Reset the device to factory default settings     |
|               | Trusted credentials | Device credentials information and Addition |  |  |

## OPERATING THE SCREEN

| Main Settings | Setting category  | Level1                                     | Level2 | Explanation |
|---------------|-------------------|--|--------|-------------|
| ABOUT         | Legal Information | Legal information, included licenses, etc. |        |             |
|               | Model Number      | Model Number of the device                 |        |             |
|               | Android Version   | Android Version                            |        |             |
|               | Kernel Version    | Android Kernel version                     |        |             |
|               | Build Number      | Build Number                               |        |             |

### 3.3 UPDATING THE SCREEN

Before first using the screen, please update it to the latest firmware version.

To update to the latest firmware version using a USB Drive, open the Setting Menu and navigate to User Configurations from this menu select the option System Update and then Firmware Upgrade (USB)

### 3.4 ENABLING THE TILING FUNCTION

The Tiling function is a pre-built tool on the main screen settings that will enable the more commonly known use of “videowall” for multiple screens. The main concept is to have the same image being shared to multiple displays, in this case 4 or 9 screens, that can form one main image using those displays.

To enable the tiling functionality, you can head over to INPUT & OUTPUT -> External Source Display Settings” -> Tiling -> set Tiling to ON.

A small configuration menu will be enabled for you to set up what structuring of the tiling function.

**Horizontal monitors:** total number of horizontal screens

**Vertical monitors:** total number of vertical screens

**Position:** position of the screen on the videowall structure, starting from bottom left.

**Frame compensation:** Enabling this option will automatically compensate for the screen’s bezel width.

**Note:** Only HDMI inputs can be paired with the tiling functionality. Android does not support the tiling function.

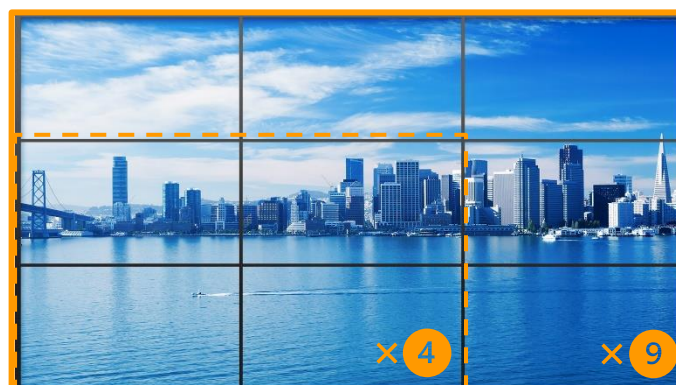

# OPERATING THE SCREEN

## 3.5 DROPIING CONTENT TO YOUR SCREEN

An integrated content player is installed on the device, this content player is designed to play content and create playlists for said content.

The option of creating a regular playlist and manage a schedule for the screen to not only display said content but also manage the device ON and OFF status is an integrated tool within this App.

There are two ways to load your content to the device:

- A. Place your content on a USB drive and connect it to the screen's USB back port, you may transfer the contents from the USB drive to the screen or keep the USB drive as an external storage.
- B. If the screen is connected to a network, you will see a QR code being displayed within the content player App, you may scan this QR code with your mobile devise to be able to navigate your devise content and copy it to the screen's internal storage.

Compatible file formats: MP3, MP4, JPEG, PNG.

*Note: the standard resolution for the content is up to 4K, please consider that the content might be scaled.*

## 3.6 AUTO-ROTATING FUNTION

The Discover 2 screens incorporate a new autorotation feature, this option is set to ON as a default and will actuate whenever the screen is tilted over a 45-degree angle.

To de-activate this function you can follow this path: Personal -> Auto-Rotate -> Set to OFF.

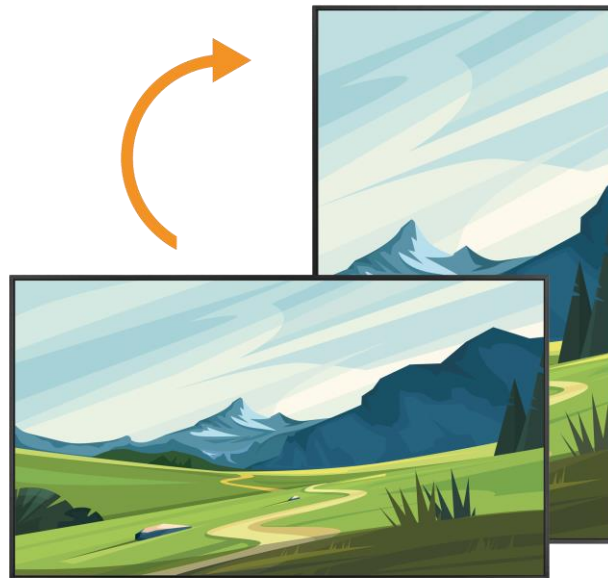

## 4. TROUBLESHOOTING

FOR FREQUENTLY ASKED QUESTIONS, PLEASE VISIT: [FAQ.LEGAMASTER.COM](https://faq.legamaster.com)