

Service Manual–AW2724DFB

Version: 01

Date:2023/03/06

Content Index

1. General Safety Instructions 3
 1.1 SAFETY: General Safety 3
 1.2 SAFETY: General Power Safety 5

2. Exploded view diagram with list of items 6

3. Wiring connectivity diagram 8

4. How to connect and disconnect power cable/ connectivity cable 9

5. Disassembly and Assembly Procedures 11
 5.1 Disassembly SOP 11
 5.2 Assembly SOP 16

6. Trouble shooting instructions 21

1. General Safety Instructions

Use the following safety guidelines to help ensure your own personal safety and to help protect your equipment and working environment from potential damage.

NOTE: In this section, equipment refers to monitors.

IMPORTANT NOTICE FOR USE IN HEALTHCARE ENVIRONMENTS:

Dell products are not medical devices and are not listed under UL or IEC 60601 (or equivalent). As a result, they must not be used within 6 feet of a patient or in a manner that directly or indirectly contacts a patient

1.1 SAFETY: General Safety

WARNING: To prevent the spread of fire, keep candles or other open flames away from this product at all times.

When setting up the equipment for use:

- Place the equipment on a hard, level surface. Leave 10.2 cm (4 in) minimum of clearance on all vented sides of the computer to permit the airflow required for proper ventilation.
- Restricting airflow can damage the computer or cause a fire.
- Do not stack equipment or place equipment so close together that it is subject to recirculated or preheated air.
- NOTE: Review the weight limits referenced in your computer documentation before placing a monitor or other devices on top of your computer.
- Ensure that nothing rests on your equipment's cables and that the cables are not located where they can be stepped on or tripped over.
- Ensure that all cables are connected to the appropriate connectors. Some connectors have a similar appearance and may be easily confused (for example, do not plug a telephone cable into the network connector).
- Do not place your equipment in a closed-in wall unit or on a bed, sofa, or rug.
- Keep your device away from radiators and heat sources.
- Keep your equipment away from extremely hot or cold temperatures to ensure that it is used within the specified operating range.
- Do not push any objects into the air vents or openings of your equipment. Doing so can cause fire or electric shock by shorting out interior components.
- Avoid placing loose papers underneath your device. Do not place your device in a closed-in wall unit, or on a soft, fabric surface such as a bed, sofa, carpet, or a rug.

When operating your equipment:

- Do not use your equipment in a wet environment, for example, near a bath tub, sink, or swimming pool or in a wet basement.
- Do not use AC powered equipment during an electrical storm. Battery powered devices may be used if all cables have been disconnected.
- Do not spill food or liquids on your equipment.
- Before you clean your equipment, disconnect it from the electrical outlet. Clean your device with a soft cloth dampened with water. Do not use liquids or aerosol cleaners, which may contain flammable substances.
- Clean the monitor display with a soft, clean cloth and water. Apply the water to the cloth, then stroke the cloth across the display in one direction, moving from the top of the display to the bottom. Remove moisture from the display quickly and keep the display dry.
- Long-term exposure to moisture can damage the display. Do not use a commercial window cleaner to clean your display.
- If your equipment does not operate normally - in particular, if there are any unusual sounds or smells coming from it - unplug it immediately and contact an authorized dealer or service center.

Protecting Against Electrostatic Discharge

Electrostatic discharge (ESD) events can harm electronic components inside your equipment. Under certain conditions, ESD may build up on your body or an object, such as a peripheral, and then discharge into another object, such as your computer. To prevent ESD damage, you should discharge static electricity from your body before you interact with any of your equipment's internal electronic components, such as a memory module. You can protect against ESD by touching a metal grounded object (such as an unpainted metal surface on your computer's I/O panel) before you interact with anything electronic. When connecting a peripheral (including handheld digital assistants) to your equipment, you should always ground both yourself and the peripheral before connecting it. In addition, as you work inside the equipment, periodically discharge any static charge your body may have accumulated.

You can also take the following steps to prevent damage from electrostatic discharge:

- When unpacking a static-sensitive component from its shipping carton, do not remove the component from the antistatic packing material until you are ready to install the component. Just before unwrapping the antistatic package, be sure to discharge static electricity from your body.
- When transporting a sensitive component, first place it in an antistatic container or packaging.
- Handle all electrostatic sensitive components in a static-safe area. If possible, use antistatic floor pads and work bench pads.

1.2 SAFETY: General Power Safety

Observe the following guidelines when connecting your equipment to a power source:

- Check the voltage rating before you connect the equipment to an electrical outlet to ensure that the required voltage and frequency match the available power source.
- Do not plug the equipment power cables into an electrical outlet if the power cable is damaged
- Norway and Sweden: If this product is provided with a 3-prong power cable, connect the power cable to a grounded electrical outlet only.
- If you use an extension power cable, ensure that the total ampere rating of the products plugged in to the extension power cable does not exceed the ampere rating of the extension cable.
- If you must use an extension cable or power strip, ensure the extension cable or power strip is connected to a wall power outlet and not to another extension cable or power strip. The extension cable or power strip must be designed for grounded plugs and plugged into a grounded wall outlet.
- If you are using a multiple-outlet power strip, use caution when plugging the power cable into the power strip. Some power strips may allow you to insert a plug incorrectly. Incorrect insertion of the power plug could result in permanent damage to your equipment, as well as risk of electric shock and/or fire. Ensure that the ground prong of the power plug is inserted into the mating ground contact of the power strip.
- Be sure to grasp the plug, not the cable, when disconnecting equipment from an electric socket.

If your equipment uses an AC adapter:

- Use only the Dell provided AC adapter approved for use with this device. Use of another AC adapter may cause a fire or explosion.
- NOTE: Refer to your system rating label for information on the proper adapter model approved for use with your device.
- Place the AC adapter in a ventilated area, such as a desk top or on the floor, when you use it to run the computer or to charge the battery. Do not cover the AC adapter with papers or other items that will reduce cooling; also, do not use the AC adapter inside a carrying case.
- The AC adapter may become hot during normal operation of your computer. Use care when handling the adapter during or immediately after operation.
- It is recommended that you lay the adapter on the floor or desk so that the green light is visible. This will alert you if the adapter should accidentally go off due to external effects. If for any reason the green light goes off, disconnect the AC power cord from the wall for a period of ten seconds, and then reconnect the power cord.
- Japan Only: Use only the Dell-provided AC power cable with the AC adapter. Use of any other power cable may damage the device or AC adapter or may present risk of fire or electric shock.

2. Exploded view diagram with list of items

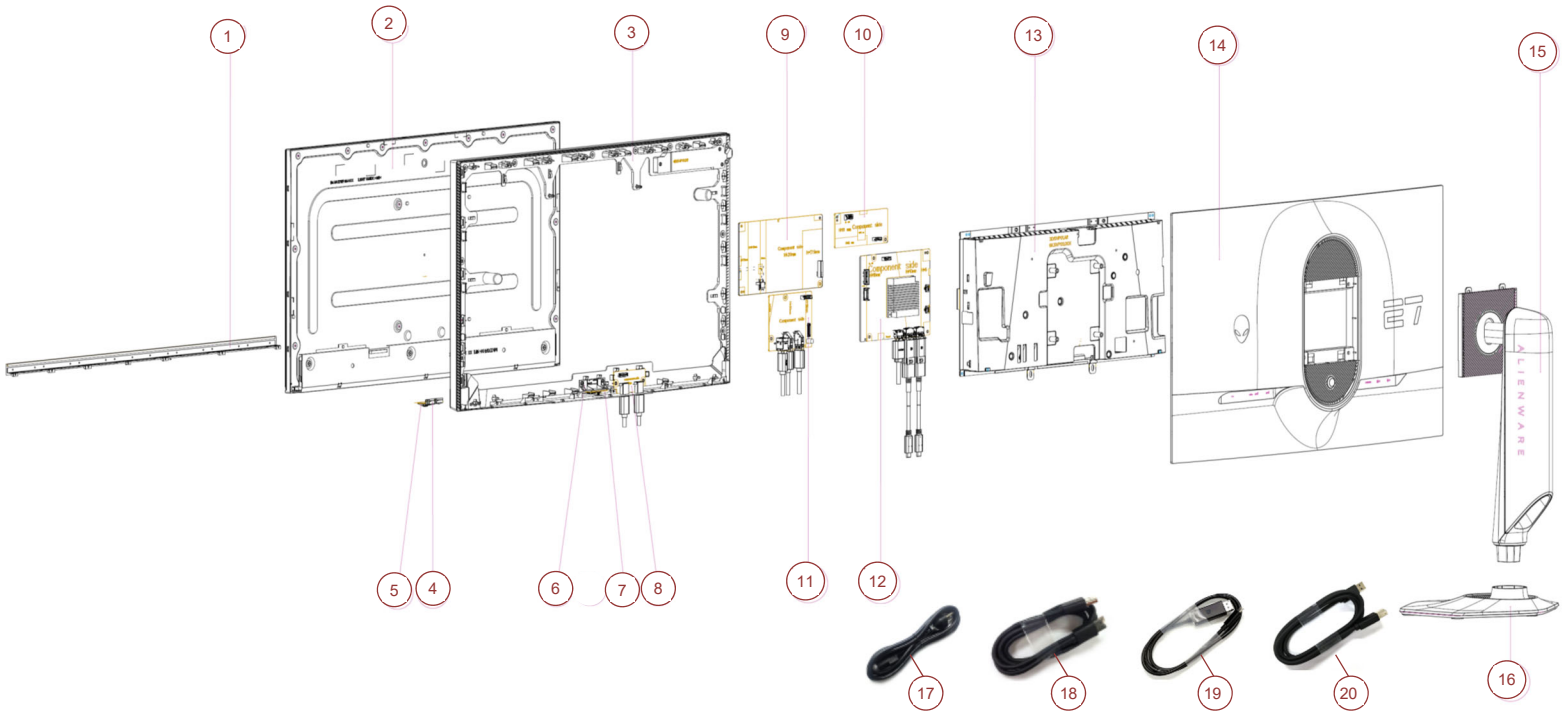

Item	Description	Q'ty	Remark
1	ASSY BKT CHIN	1	For EMEA Only, not for other regions
2	Panel	1	
3	ASSY MF	1	
4	BTN POWER	1	
5	PCBA LENS BD	1	
6	HOLDER L	1	
7	PCBA KEY BD	1	
8	PCBA USB BD	1	
9	PCBA I/F BD	1	
10	PCBA LED DRV BD	1	
11	PCBA USB B BD	1	
12	PCBA SPS BD	1	
13	ASSY MAIN SHD	1	
14	ASSY RC	1	
15	ASSY CLMN	1	
16	ASSY BASE	1	
17	Power cable	1	See "NOTE"
18	DisplayPort to DisplayPort 1.4 cable	1	See "NOTE"
19	USB-C to DisplayPort 1.4 cable	1	See "NOTE"
20	USB 3.2 Gen 1 (5 Gbps) upstream cable	1	See "NOTE"

NOTE:

For replacement of power cord, connectivity cable and external power supply (if applicable), contact Dell:

1. Go to <https://www.dell.com/support>.
2. Verify your country or region in the Choose A Country/Region drop-down menu at the bottom-right corner of the page.
3. Click Contact Us next to the country dropdown.
4. Select the appropriate service or support link based on your need.
5. Choose the method of contacting Dell that is convenient for you

3. Wiring connectivity diagram

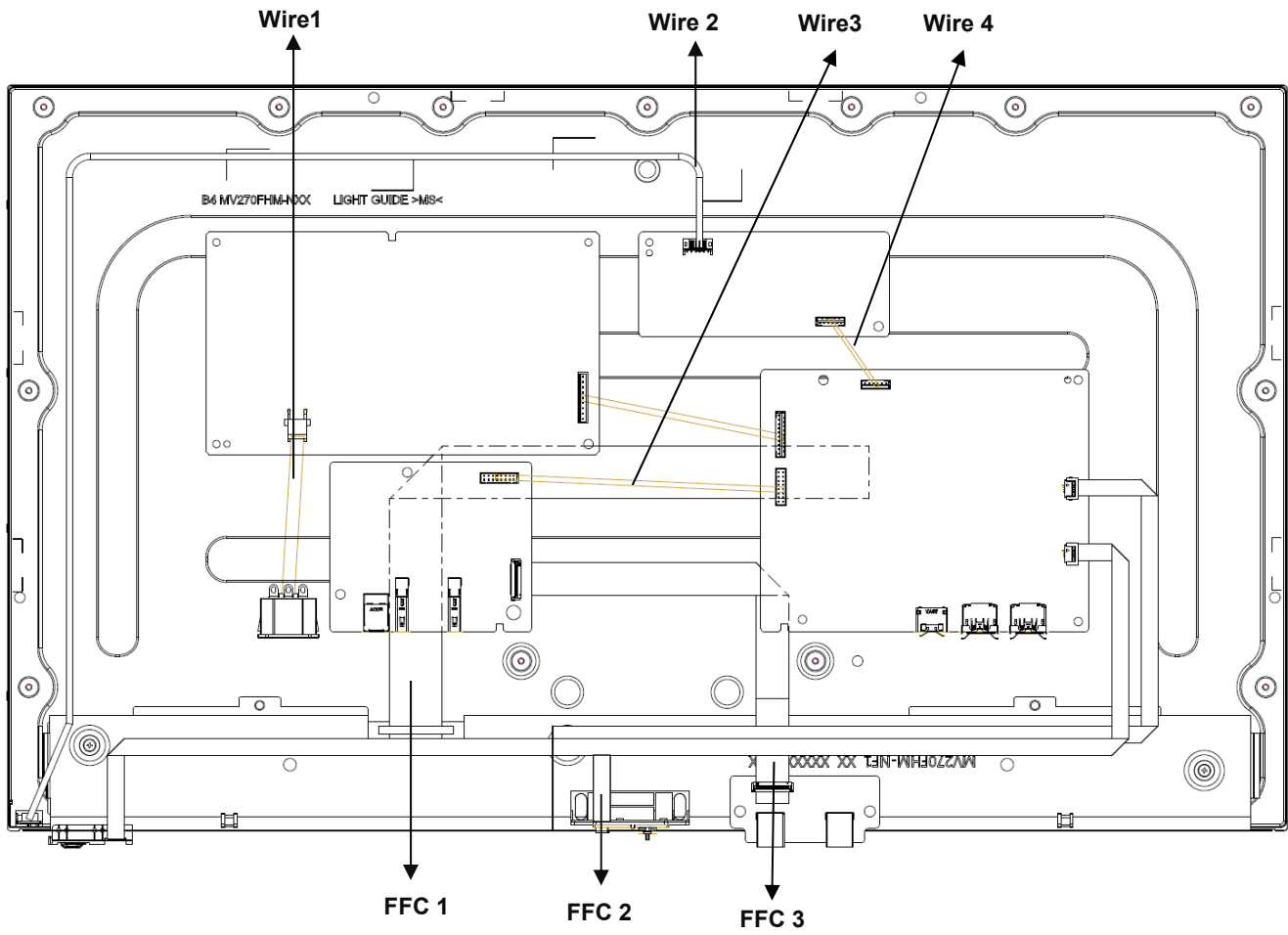

4. How to connect and disconnect power cable/ connectivity cable

WARNING: To change power cable/ connectivity cable, switch off power before unplugging the cable and replugging in required cable.

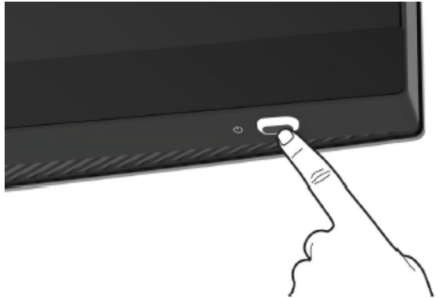

Connect/ disconnecting the DisplayPort (DP to DP) and USB cables



Connect/ disconnecting the DisplayPort (USB-C to DP) and USB cables

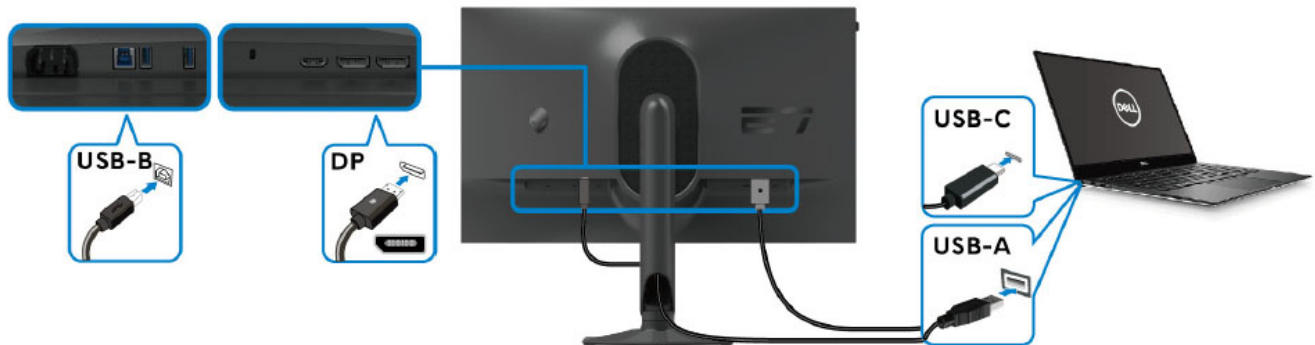

Connect/ disconnecting the HDMI and USB cables (optional)



Connect/ disconnecting the power cables of your computer and monitor into a wall outlet



5. Disassembly and Assembly Procedures

NOTE:

This “Disassembly and Assembly Procedures” is for EMEA only, not for other regions. Please note that Dell will deem warranty void if any disassembly is done on the monitors.



5.1 Disassembly SOP

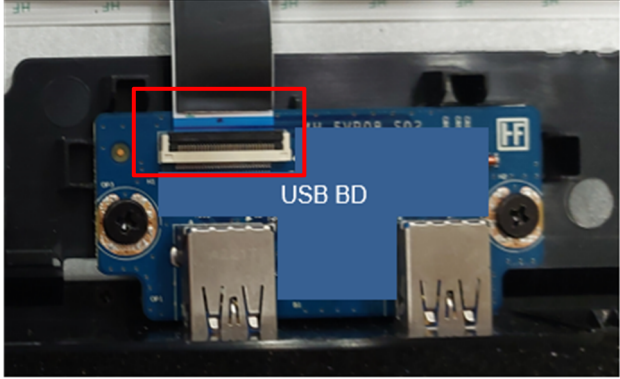
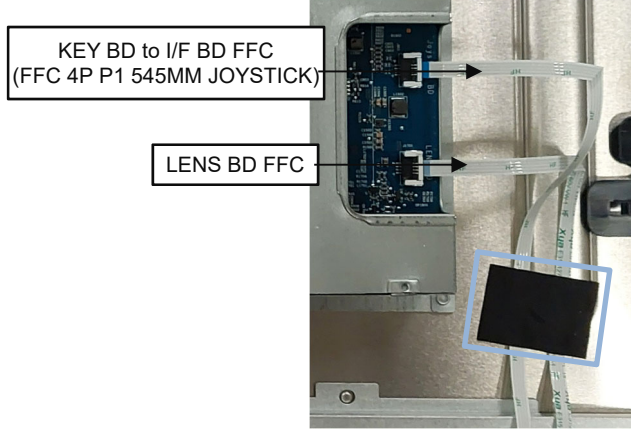
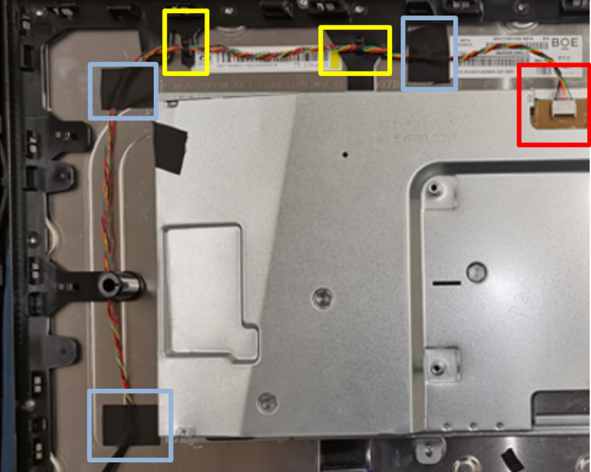
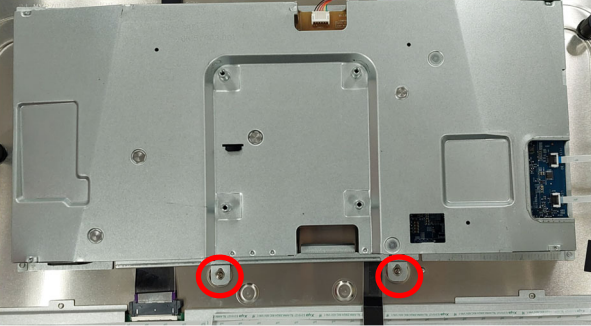

Preparation before disassembly

1. Clean the room for work
2. Identify the area for material
3. Prepare the implement, equipment, materials as bellow :
 - 1) Working table
 - 2) Philips-head screwdriver
 - 3) Gloves
 - 4) Cleaning cloth
 - 5) ESD protection

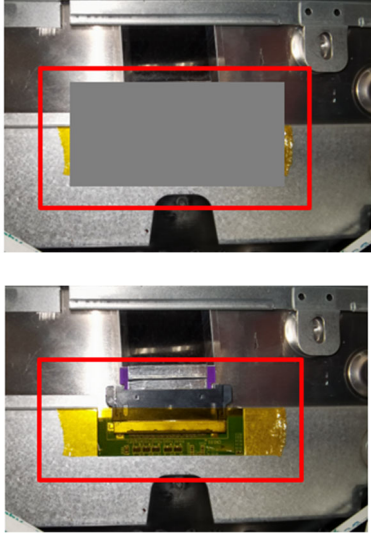
Item	Picture	Operation	Tool	Notes
1		<ol style="list-style-type: none"> 1. Turn off the monitor 2. Place the monitor on a soft cloth or cushion 3. Press and hold the stand release button at the back of the display 4. Lift the stand assembly up and away from the monitor 		
2		<ol style="list-style-type: none"> 1. Unlock 4 screws on Rear Cover 2. Use hands or scraper bar to disassemble “Rear Cover” from monitor <p>Notice the disassembly order: Top Side=> Right / Left Side =>Bottom Side</p>	Philips-head screwdriver (Screw Torque: 8-10 Kgf) Scraper bar	

Item	Picture	Operation	Tool	Notes
3		<ol style="list-style-type: none"> 1. Unplug "FFC USB3 30/30" from USB BD 		
4		<ol style="list-style-type: none"> 1. Tear off a tape from "LENS BD FFC" and "KEY BD to I/F BD FFC" on Panel 2. Unplug "LENS BD FFC" from I/F BD and tear off it from Panel 3. Unplug "KEY BD to I/F BD FFC" from I/F BD and tear off it from Panel 		
5		<ol style="list-style-type: none"> 1. Tear off 3 tapes from the backlight wire on panel (See blue mark) 2. Unplug "Backlight Wire" from "LED DRV BD" (See red mark), then, disassemble it from the hooks on the upper left of Middle Frame (See yellow mark) 		
6		<ol style="list-style-type: none"> 1. Unlock 2 screws to disassemble "Main SHD" from Panel 	<p>Philips-head screwdriver</p> <p>(Screw Torque-SHD to panel: 4.0±0.5 kgf)</p>	

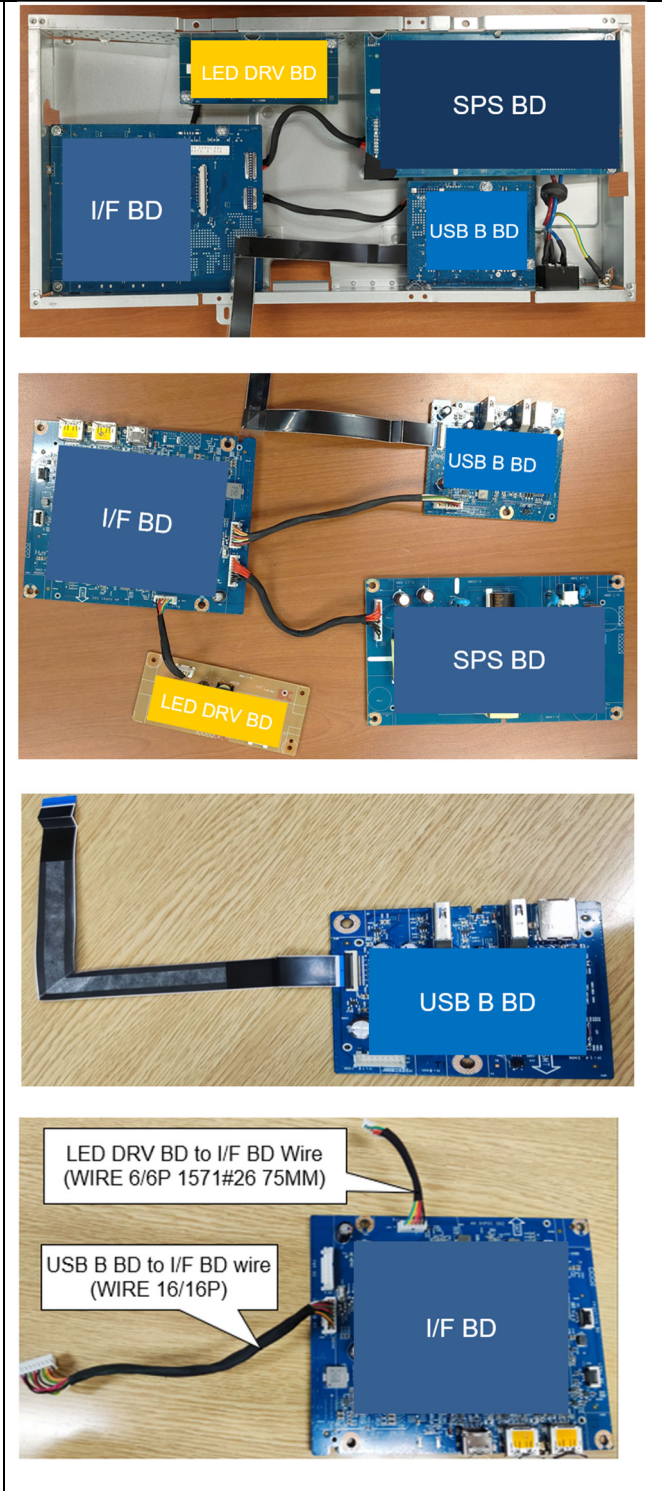
Item	Picture	Operation	Tool	Notes
6		<ol style="list-style-type: none"> 2. Tear off a conductive cloth from “FFC EDP 51P/51P” on panel 3. Tear off a yellow tape from “FFC EDP 51P/51P” on panel 4. Unplug “FFC EDP 51P/51P” from panel 5. Take off “Main SHD” from Panel 		
7		<ol style="list-style-type: none"> 1. Disassemble “MYLAR PWR” from Main SHD 2. Unplug “FFC EDP 51P/51P” from I/F BD 3. Tear off 2 acetate tapes from “SPS BD Wire” and “USB B BD to I/F BD wire” on Main SHD 4. Unlock 11 PCBA screws 	<p>Philips-head screwdriver</p> <p>(Screw Torque: 8.5±1 Kgf)</p>	

Item	Picture	Operation	Tool	Notes
7		<ol style="list-style-type: none"> 5. Disassemble “USB B BD” from Main SHD and unplug “USB B BD to I/F BD wire” from “USB B BD” 6. Disassemble “LED DRV BD” from Main SHD and Uplug “LED DRV BD to I/F BD Wire” from “LED DRV BD” 7. Disassemble I/F BD from Main SHD and unplug “SPS BD Wire” from I/F BD 8. Unplug “FFC USB3 30/30” from “USB B BD” 9. Unplug “LED DRV BD to I/F BD Wire” and “USB B BD to I/F BD wire” from I/F BD 	<p>Philips-head screwdriver</p> <p>(Screw Torque: 8.5±1 Kgf)</p>	<p>Do not touch the component without wearing insulating gloves when disassembling and assembling Power BD</p> 

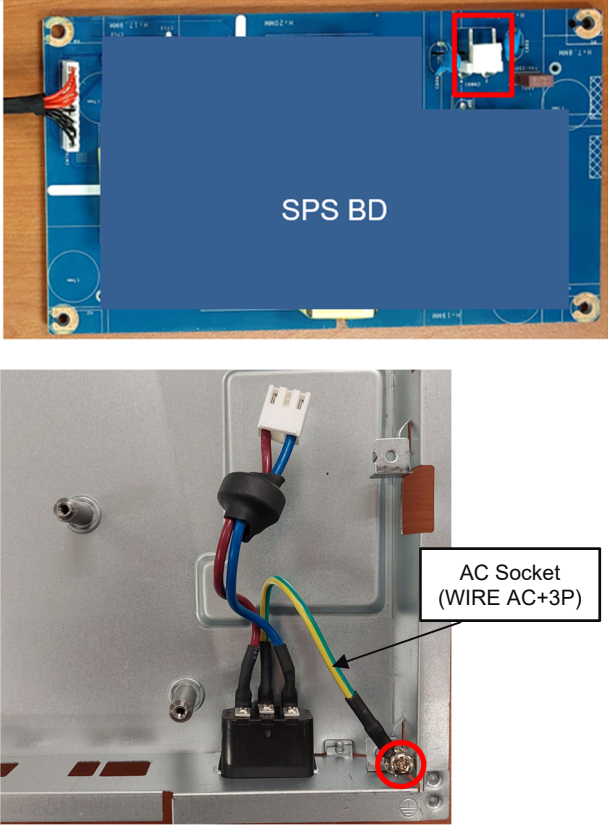
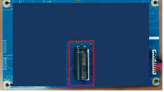

Item	Picture	Operation	Tool	Notes
7		<p>10. Disassemble SPS BD from Main SHD and unplug "WIRE AC+3P" from SPS BD</p> <p>11. Unlock 1 ground screw and disassemble "WIRE AC+3P" from Main SHD</p>		<p>Do not touch the component without wearing insulating gloves when disassembling and assembling Power BD</p> 

5.2 Assembly SOP

Preparation before assembly

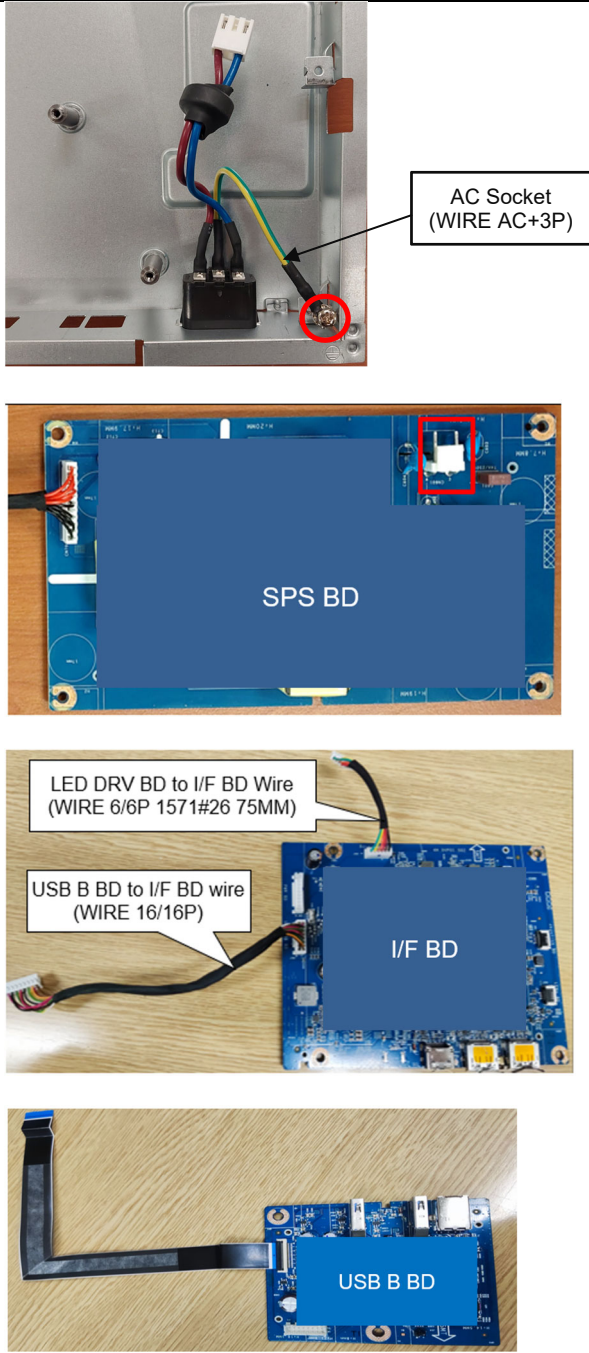
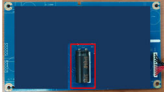
1. Clean the room for work
2. Identify the area for material
3. Prepare the implement, equipment, materials as bellow:
 - 1) Working table
 - 2) Philips-head screwdriver
 - 3) Gloves
 - 4) Cleaning cloth
 - 5) ESD protection

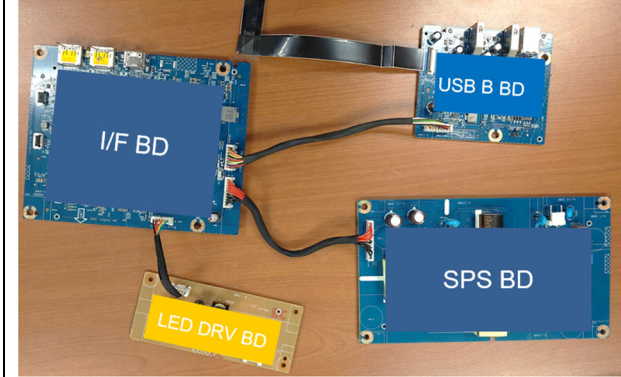
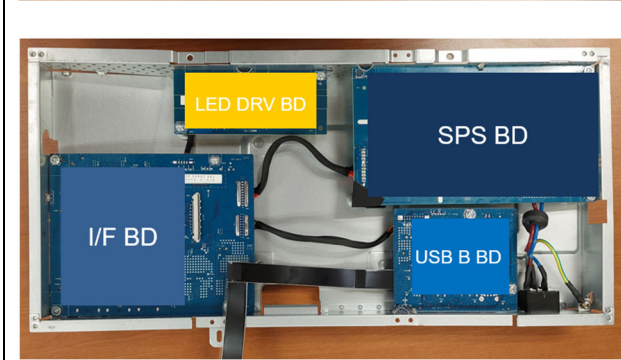
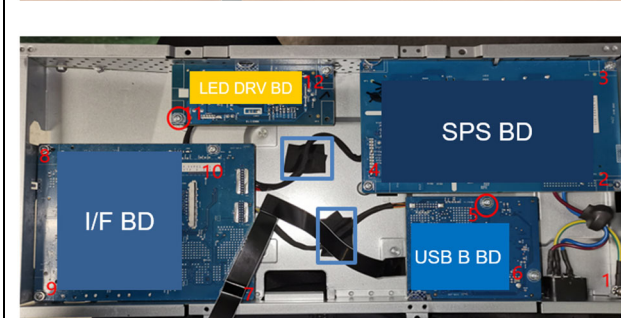
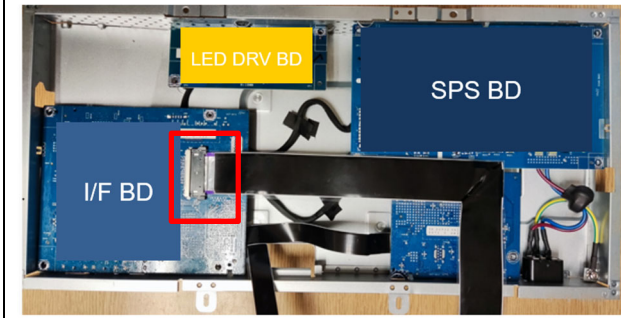
Item	Picture	Operation	Tool	Notes
1		<ol style="list-style-type: none"> 1. Assemble "WIRE AC+3P" to Main SHD and lock 1 ground screw. 2. Insert "WIRE AC+3P" to SPS BD and assemble SPS BD to Main SHD 3. Insert "LED DRV BD to I/F BD Wire" and "USB B BD to I/F BD wire" to I/F BD 4. Insert "FFC USB3 30/30" to "USB B BD" 	<p>Philips-head screwdriver</p> <p>(Screw Torque: 8.5±1 Kgf)</p>	<p>Do not touch the component without wearing insulating gloves when disassembling and assembling Power BD</p> 

Item	Picture	Operation	Tool	Notes	
1		5. Insert "SPS BD Wire" to I/F BD and assemble I/F BD to Main SHD	Philips-head screwdriver		
		6. Insert "LED DRV BD to I/F BD Wire" to "LED DRV BD" and assemble "LED DRV BD" to Main SHD	(Screw Torque: 8.5±1 Kgf)		
		7. Insert "USB B BD to I/F BD wire" to "USB B BD" and assemble "USB B BD" to Main SHD			
	8. Lock 11 PCBA screws		9. Use 2 acetate tapes to fix "SPS BD Wire" and "USB B BD to I/F BD wire" on Main SHD		
		10. Insert "FFC EDP 51P/51P" to I/F BD			
		11. Assemble "MYLAR PWR" to Main SHD			

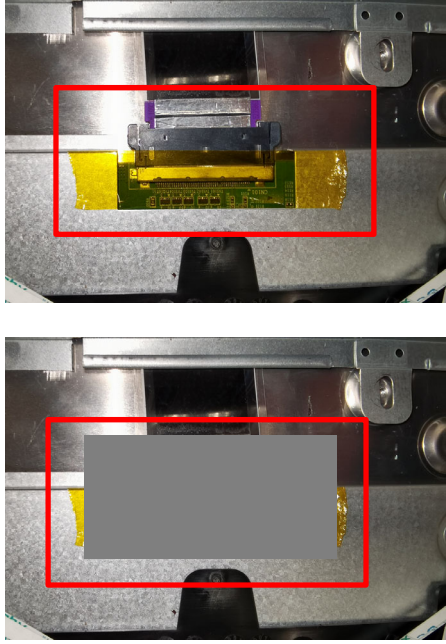
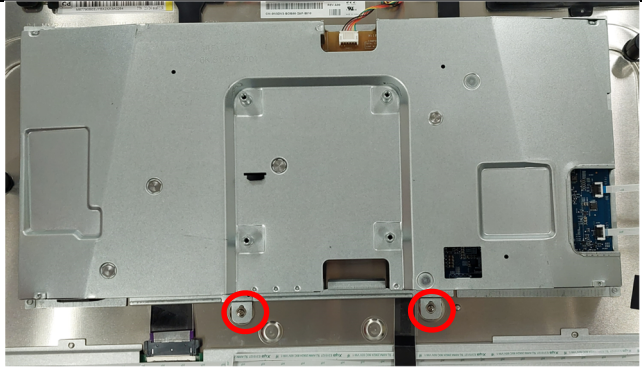
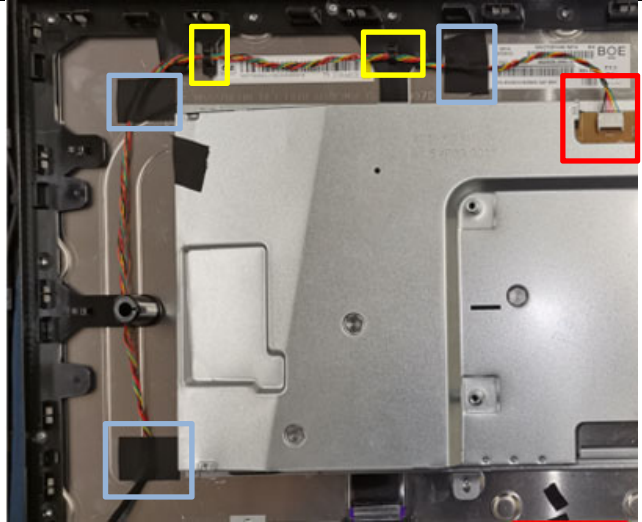
Item	Picture	Operation	Tool	Notes
2		<ol style="list-style-type: none"> 1. Insert "FFC EDP 51P/51P" to panel 2. Paste a yellow tape to fix "FFC EDP 51P/51P" on panel 3. Paste a conductive cloth to cover the yellow tape 		
3		<ol style="list-style-type: none"> 1. Place Main SHD on Panel and lock 2 screws to fix it on Panel 	Philips-head screwdriver (Screw Torque-SHD to panel: 4.0±0.5 kgf)	
4		<ol style="list-style-type: none"> 1. Arrange "Backlight Wire" into the hooks on the upper left of Middle Frame (See yellow mark), then, insert "Backlight Wire" into "LED DRV BD" (See red mark) 2. Adhere 3 acetate tapes to fix "Backlight Wire" on Panel (See blue mark) 		

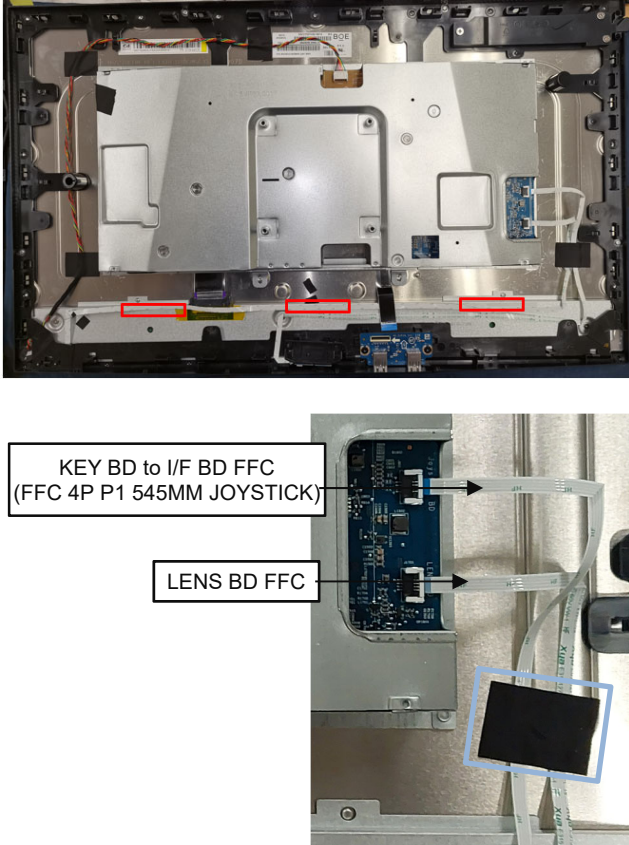
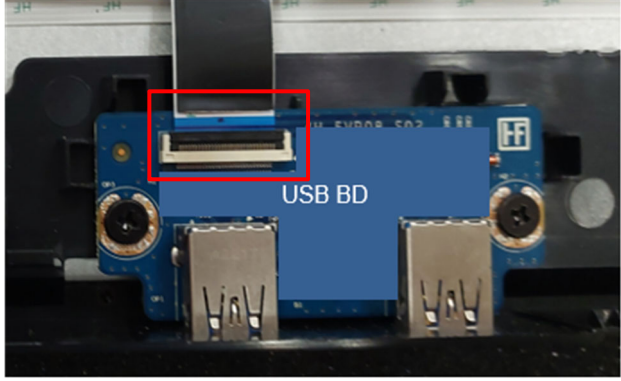
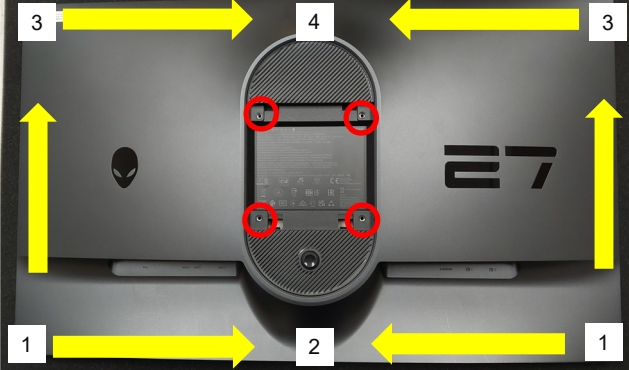
Item	Picture	Operation	Tool	Notes
5		<ol style="list-style-type: none"> 1. Tear off the release paper from "LENS BD FFC" and stick "LENS BD FFC" on Panel 2. Tear off the release paper from "KEY BD to I/F BD FFC" and stick "KEY BD to I/F BD FFC" on Panel 3. Insert "LENS BD FFC" and "KEY BD to I/F BD FFC" to I/F BD 4. Adhere a tape to fix "LENS BD FFC" and "KEY BD to I/F BD FFC" on Panel 		
6		<ol style="list-style-type: none"> 1. Insert "FFC USB3 30/30" to "USB BD" 		
7		<ol style="list-style-type: none"> 1. Follow the order to assemble Rear Cover with Middle Frame 2. Lock 4 screws on Rear Cover 	Philips-head screwdriver (Screw Torque: 8-10Kgf)	

Item	Picture	Operation	Tool	Notes
8		<p>To assemble stand:</p> <ol style="list-style-type: none"> 1. Align and place the stand riser on the stand base. 2. Open the screw handle at the bottom of the stand base and turn it clockwise to secure the stand assembly. 3. Close the screw handle. 4. Carefully insert the tabs on the stand riser into the slots on the display back-cover and press down the stand assembly to snap it into place. 		

6. Trouble shooting instructions

Troubleshooting

⚠ WARNING: Before you begin any of the procedures in this section, follow the [Safety instructions](#).

Self-test

Your monitor provides a self-test feature that allows you to check whether your monitor is functioning properly. If your monitor and computer are properly connected but the monitor screen remains dark, run the monitor self-test by performing the following steps:

1. Turn off both your computer and the monitor.
2. Unplug the video cable from the computer.
3. Turn on the monitor.

A dialog box should appear on the screen, indicating that the monitor is working correctly and it is not receiving a video signal. While in self-test mode, the power LED remains white (default color).

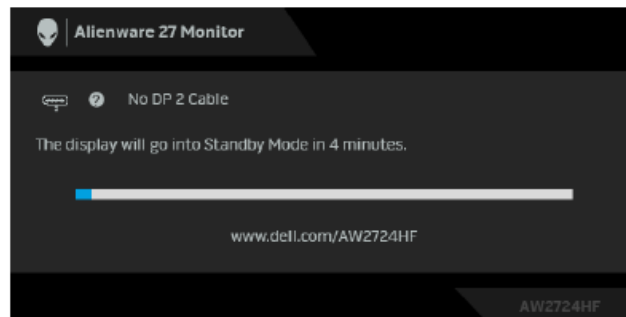

✎ NOTE: This dialog box also appears during normal operation, if the video cable is disconnected or damaged.

4. Turn off your monitor and reconnect the video cable; then turn on both your computer and the monitor.

After performing the above steps, if the monitor displays no video output, then the problem may be with the graphics card or the computer.

Common problems

The following table contains general information about common monitor problems you might encounter and the possible solutions:

Common symptoms	What you experience	Possible solutions
No video/power LED off	No picture	<ul style="list-style-type: none">▪ Ensure that the video cable connecting the monitor and the computer is properly connected and secure.▪ Verify that the power outlet is functioning properly using any other electrical equipment.▪ Ensure that you have pressed the power button properly.▪ Ensure that the correct input source is selected in the Input Source menu.
No video/power LED on	No picture or no brightness	<ul style="list-style-type: none">▪ Increase brightness and contrast controls in the Brightness/Contrast menu.▪ Perform monitor self-test feature check.▪ Check for bent or broken pins in the video cable connector.▪ Run the built-in diagnostics. For more information, see Self-Diagnostic.▪ Ensure that the correct input source is selected in the Input Source menu.
Poor focus	Picture is fuzzy, blurry, or ghosting	<ul style="list-style-type: none">▪ Eliminate video extension cables.▪ Reset the monitor to factory settings. For more information, see Factory Reset.▪ Change the video resolution to the correct aspect ratio.

Common symptoms	What you experience	Possible solutions
Shaky/jittery video	Wavy picture or fine movement	<ul style="list-style-type: none"> ▪ Reset the monitor to factory settings. For more information, see Factory Reset. ▪ Check environmental factors. ▪ Relocate the monitor and test in another room.
Missing pixels	LCD screen has spots	<ul style="list-style-type: none"> ▪ Cycle power On-Off. ▪ Pixel that is permanently off is a natural defect that can occur in LCD technology. ▪ For more information on Dell Monitor Quality and Pixel Policy, see www.dell.com/pixelguidelines.
Stuck-on pixels	LCD screen has bright spots	<ul style="list-style-type: none"> ▪ Cycle power On-Off. ▪ Pixel that is permanently off is a natural defect that can occur in LCD technology. ▪ For more information on Dell Monitor Quality and Pixel Policy, see www.dell.com/pixelguidelines.
Brightness problems	Picture too dim or too bright	<ul style="list-style-type: none"> ▪ Reset the monitor to factory settings. For more information, see Factory Reset. ▪ Adjust brightness and contrast controls in the Brightness/Contrast menu.
Geometric distortion	Screen not centered correctly	Reset the monitor to factory settings. For more information, see Factory Reset .

Common symptoms	What you experience	Possible solutions
Horizontal/ vertical lines	Screen has one or more lines	<ul style="list-style-type: none"> ▪ Reset the monitor to factory settings. For more information, see Factory Reset. ▪ Perform monitor self-test feature check and determine if these lines also appear in self-test mode. ▪ Check for bent or broken pins in the video cable connector. ▪ Run the built-in diagnostics. For more information, see Self-Diagnostic.
Synchronization problems	Screen is scrambled or appears torn	<ul style="list-style-type: none"> ▪ Reset the monitor to factory settings. For more information, see Factory Reset. ▪ Perform monitor self-test feature check to determine if the scrambled screen appears in self-test mode. ▪ Check for bent or broken pins in the video cable connector. ▪ Restart the computer in the <i>safe mode</i>.
Safety related issues	Visible signs of smoke or sparks	<ul style="list-style-type: none"> ▪ Do not perform any troubleshooting steps. ▪ Contact Dell immediately.
Intermittent problems	Monitor malfunctions on and off	<ul style="list-style-type: none"> ▪ Ensure that the video cable connecting the monitor to the computer is connected properly and is secure. ▪ Reset the monitor to factory settings. For more information, see Factory Reset. ▪ Perform monitor self-test feature check to determine if the intermittent problem occurs in self-test mode.

Common symptoms	What you experience	Possible solutions
Missing color	Picture missing color	<ul style="list-style-type: none"> Perform monitor self-test feature check. Ensure that the video cable connecting the monitor to the computer is connected properly and is secure. Check for bent or broken pins in the video cable connector.
Wrong color	Picture color not good	<ul style="list-style-type: none"> Reset all settings under the Game menu to the factory defaults using Reset Game. Change the Input Color Format to RGB or YCbCr/YPbPr in the Display settings OSD. Run the built-in diagnostics. For more information, see Self-Diagnostic.
Wrong color in HDR mode	Color banding in the pictures	Try to lower down the frequency (DP: 1920 x 1080 at 60 Hz, HDMI: 1920 x 1080 at 60 Hz).
Screen image is too small	Image is centered on screen, but does not fill entire viewing area	<ul style="list-style-type: none"> Check the Aspect Ratio settings in the Display menu OSD. Reset the monitor to factory settings. For more information, see Factory Reset.
Cannot adjust the monitor with the joystick	OSD does not appear on the screen	<ul style="list-style-type: none"> Turn off the monitor, unplug the power cord, plug it back, and then turn on the monitor. Check whether the OSD menu is locked. If yes, move and hold the joystick forward/back/left/right for 4 seconds to unlock. For more information, see Locking the control buttons.

Common symptoms	What you experience	Possible solutions
No input signal when user controls are pressed	No picture, the LED light is white	<ul style="list-style-type: none"> ▪ Check the signal source. Ensure that the computer is not in the power saving mode by moving the mouse or pressing any key on the keyboard. ▪ Check whether the signal cable is plugged in properly. Re-plug the signal cable if necessary. ▪ Reset the computer or video player.
The picture does not fill the entire screen	The picture cannot fill the height or width of the screen	<ul style="list-style-type: none"> ▪ Due to different video formats (aspect ratio), the monitor may display in full screen. ▪ Run the built-in diagnostics. For more information, see Self-Diagnostic.
The displayed pictures appear incorrectly when the DP/HDMI cable is connected through a USB-C adapter or dock to your laptop or desktop	Display will freeze, has black screen or display abnormal screen	Do not use a USB-C adapter or dock. Connect the DP/HDMI cable directly to your laptop or desktop.

Common symptoms	What you experience	Possible solutions
Screen flickering	There are some noticeable flickering in the displayed pictures	<ul style="list-style-type: none"> ▪ Use the native resolution of your monitor (1920 x 1080 at 60 Hz) or higher refresh rate. ▪ If the variable refresh rate (VRR) of your device is turned on, turn off variable refresh rate (VRR). ▪ If you are using an NVIDIA graphics card and G-Sync is turned on, turn off G-Sync. ▪ If you are using an AMD graphics card and Free-Sync is turned on, turn off Free-Sync. ▪ Update the graphics card driver and firmware to the latest version. ▪ Change the cable connecting the monitor to the computer. A defective cable can cause the signal to break while being transmitted across the wire. ▪ Check the surroundings. Electromagnetic fields can cause screen flickering. If there is another device plugged into the same power strip as the monitor, try to remove it.
Image retention from a static image left on the monitor for a long period of time	Faint shadow from the static image displayed appears on the screen	<ul style="list-style-type: none"> ▪ Set the screen to turn off after a few minutes of screen idle time. These can be adjusted in Windows Power Options or Mac Energy Saver setting. ▪ Alternatively, use a dynamically changing screensaver.
Cannot adjust the gaming features using AWCC	No SETTINGS panel	<ul style="list-style-type: none"> ▪ Check whether the signal cable is plugged in properly. Re-plug the signal cable as necessary. ▪ Reboot your computer.

Universal Serial Bus (USB) specific problems

Specific symptoms	What you experience	Possible solutions
USB interface is not working	USB peripherals are not working	<ul style="list-style-type: none">▪ Check that your monitor is turned on.▪ Reconnect the upstream cable to your computer.▪ Reconnect the USB peripherals (downstream connector).▪ Turn off and then turn on the monitor again.▪ Reboot your computer.▪ Some USB devices like external portable HDD require higher electric current; connect the device directly to the computer system.
SuperSpeed USB 5 Gbps (USB 3.2 Gen 1) interface is slow	SuperSpeed USB 5 Gbps (USB 3.2 Gen 1) peripherals working slowly or not working at all	<ul style="list-style-type: none">▪ Check that your computer is SuperSpeed USB 5 Gbps (USB 3.2 Gen 1)-compatible.▪ Some computers have USB 3.2 and USB 2.0 ports. Ensure that the correct USB port is used.▪ Reconnect the upstream cable to your computer.▪ Reconnect the USB peripherals (downstream connector).▪ Reboot your computer.
Wireless USB peripherals stop working when a USB 3.2 device is plugged in	Wireless USB peripherals responding slowly or only working as the distance between itself and its receiver decreases	<ul style="list-style-type: none">▪ Increase the distance between the USB 3.2 peripherals and the wireless USB receiver.▪ Position your wireless USB receiver as close as possible to the wireless USB peripherals.▪ Use a USB-extender cable to position the wireless USB receiver as far away as possible from the USB 3.2 port.