

Latitude 7430/Latitude 7430 2-in-1

Service Manual

Notes, cautions, and warnings

 **NOTE:** A NOTE indicates important information that helps you make better use of your product.

 **CAUTION:** A CAUTION indicates either potential damage to hardware or loss of data and tells you how to avoid the problem.

 **WARNING:** A WARNING indicates a potential for property damage, personal injury, or death.

Chapter 1: Working inside your computer	6
Safety instructions.....	6
Before working inside your computer.....	6
Safety precautions.....	7
Electrostatic discharge—ESD protection.....	7
ESD field service kit	8
Transporting sensitive components.....	9
After working inside your computer.....	9
BitLocker.....	9
Chapter 2: Removing and installing components	10
Recommended tools.....	10
Screw list.....	10
Major components of Latitude 7430.....	11
microSIM-card tray.....	13
Removing the microSIM-card tray	13
Installing the microSIM-card tray	14
Base cover.....	14
Removing the base cover	14
Installing the base cover	17
M.2 solid-state drive (for clamshell computers).....	19
Removing the M.2 2230 solid-state drive (for computers shipped without a thermal plate)	19
Installing the M.2 2230 solid-state drive (for computers shipped without a thermal plate)	20
Removing the M.2 2230 solid-state drive (for computers shipped with a thermal plate)	22
Installing the M.2 2230 solid-state drive (for computers shipped with a thermal plate)	23
Removing the M.2 2280 solid-state drive	24
Installing the M.2 2280 solid-state drive	25
M.2 solid-state drive (for 2-in-1 computers).....	26
Removing the M.2 2230 solid-state drive (for computers shipped with a thermal plate)	26
Installing the M.2 2230 solid-state drive (for computers shipped with a thermal plate)	27
Removing the M.2 2280 solid-state drive	29
Installing the M.2 2280 solid-state drive	30
WWAN card.....	31
Removing the 4G WWAN card	31
Installing the 4G WWAN card	32
Removing the 5G WWAN card	35
Installing the 5G WWAN card	36
Battery.....	38
Lithium-ion battery precautions.....	38
Removing the 3-cell battery	39
Installing the 3-cell battery	40
Removing the 4-cell battery	42
Installing the 4-cell battery	43
Heat-sink.....	45

Removing the heat-sink	45
Installing the heat-sink	46
WLAN-antenna module.....	48
Removing the WLAN-antenna module	48
Installing the WLAN-antenna module	49
Coin-cell battery.....	51
Removing the coin-cell battery	51
Installing the coin-cell battery	51
Display assembly.....	52
Removing the display assembly	52
Installing the display assembly	56
Audio daughter-board.....	61
Removing the audio daughter-board	61
Installing the audio daughter-board	62
Speakers.....	63
Removing the speakers	63
Installing the speakers	64
Smart card reader.....	66
Removing the smart card reader	66
Installing the smart card reader	68
System board.....	71
Removing the system board	71
Installing the system board	78
I/O daughter-board.....	85
Removing the I/O daughter-board	85
Installing the I/O daughter-board	87
Power button with optional fingerprint reader.....	88
Removing the power button with optional fingerprint reader	88
Installing the power button with optional fingerprint reader	89
Keyboard.....	90
Removing the keyboard	90
Installing the keyboard	92
Palm-rest assembly.....	95
Removing the palm-rest assembly	95
Installing the palm-rest assembly	96

Chapter 3: Drivers and downloads..... 98

Chapter 4: BIOS setup..... 99











BIOS overview.....	99
Entering BIOS setup program.....	99
Navigation keys.....	99
One time boot menu.....	100
System setup options.....	100
Updating the BIOS.....	111
Updating the BIOS in Windows.....	111
Updating the BIOS in Linux and Ubuntu.....	111
Updating the BIOS using the USB drive in Windows.....	111
Updating the BIOS from the F12 One-Time boot menu.....	112

System and setup password.....	112
Assigning a system setup password.....	113
Deleting or changing an existing system setup password.....	113
Clearing BIOS (System Setup) and System passwords.....	114
Clearing chassis intrusion alert	114
Chapter 5: Troubleshooting.....	116
Handling swollen Lithium-ion batteries.....	116
Dell SupportAssist Pre-boot System Performance Check diagnostics.....	116
Running the SupportAssist Pre-Boot System Performance Check.....	117
Built-in self-test (BIST).....	117
M-BIST.....	117
LCD Power rail test (L-BIST).....	118
LCD Built-in Self Test (BIST).....	118
System-diagnostic lights.....	118
Recovering the operating system.....	120
Real-Time Clock (RTC Reset).....	120
Backup media and recovery options.....	121
WiFi power cycle.....	121
Drain residual flea power (perform hard reset).....	121
Chapter 6: Getting help and contacting Dell.....	122

Working inside your computer



Safety instructions

Use the following safety guidelines to protect your computer from potential damage and to ensure your personal safety. Unless otherwise noted, each procedure included in this document assumes that you have read the safety information that shipped with your computer.

-  **WARNING:** Before working inside your computer, read the safety information that is shipped with your computer. For more safety best practices, see the Regulatory Compliance home page at www.dell.com/regulatory_compliance.
-  **WARNING:** Disconnect your computer from all power sources before opening the computer cover or panels. After you finish working inside the computer, replace all covers, panels, and screws before connecting your computer to an electrical outlet.
-  **CAUTION:** To avoid damaging the computer, ensure that the work surface is flat, dry, and clean.
-  **CAUTION:** To avoid damaging the components and cards, handle them by their edges, and avoid touching the pins and the contacts.
-  **CAUTION:** You should only perform troubleshooting and repairs as authorized or directed by the Dell technical assistance team. Damage due to servicing that is not authorized by Dell is not covered by your warranty. See the safety instructions that is shipped with the product or at www.dell.com/regulatory_compliance.
-  **CAUTION:** Before touching anything inside your computer, ground yourself by touching an unpainted metal surface, such as the metal at the back of the computer. While you work, periodically touch an unpainted metal surface to dissipate static electricity which could harm internal components.
-  **CAUTION:** When you disconnect a cable, pull it by its connector or its pull tab, not the cable itself. Some cables have connectors with locking tabs or thumbscrews that you must disengage before disconnecting the cable. When disconnecting cables, keep them evenly aligned to avoid bending the connector pins. When connecting cables, ensure that the ports and the connectors are correctly oriented and aligned.
-  **CAUTION:** Press and eject any installed card from the media-card reader.
-  **CAUTION:** Exercise caution when handling Lithium-ion batteries in laptops. Swollen batteries should not be used and should be replaced and disposed properly.
-  **NOTE:** The color of your computer and certain components may appear differently than shown in this document.

Before working inside your computer

Steps

1. Save and close all open files and exit all open applications.
2. Shut down your computer. For Windows operating system, click **Start** >  **Power** > **Shut down**.
 -  **NOTE:** If you are using a different operating system, see the documentation of your operating system for shut-down instructions.
3. Disconnect your computer and all attached devices from their electrical outlets.
4. Disconnect all attached network devices and peripherals, such as keyboard, mouse, and monitor from your computer.

5. Remove any media card and optical disk from your computer, if applicable.
6. Enter the service mode, if you are able to power on your computer.

Service Mode

Service Mode is used to cut-off power, without disconnecting battery cable from system board prior conducting repairs in the computer.

CAUTION: If you are unable to turn on the computer to put it into Service Mode or the computer does not support Service Mode then proceed to disconnect the battery cable. To disconnect the battery cable, follow the steps in [Removing the battery](#).

NOTE: Ensure that your computer is shut down and the AC adapter is disconnected.

- a. Hold **** key on the keyboard and press the power button for 3 seconds or until the Dell logo appears on the screen.
- b. Press any key to continue.
- c. If the AC adapter is not disconnected, a message prompting you to remove the AC adapter appears on the screen. Remove the AC adapter and then press any key to continue the **Service Mode** procedure. The **Service Mode** procedure automatically skips the following step if the **Owner Tag** of the computer is not set up in advance by the user.
- d. When the ready-to-proceed message appears on the screen, press any key to proceed. The computer emits three short beeps and shuts down immediately.
- e. Once the computer shuts down, it has successfully entered Service Mode.

NOTE: If you are unable to power on your computer or unable to enter service mode skip this process.

Safety precautions

The safety precautions chapter details the primary steps to be taken before performing any disassembly instructions.

Observe the following safety precautions before you perform any installation or break/fix procedures involving disassembly or reassembly:

- Turn off the system and all attached peripherals.
- Disconnect the system and all attached peripherals from AC power.
- Disconnect all network cables, telephone, and telecommunications lines from the system.
- Use an ESD field service kit when working inside any notebook to avoid electrostatic discharge (ESD) damage.
- After removing any system component, carefully place the removed component on an anti-static mat.
- Wear shoes with non-conductive rubber soles to reduce the chance of getting electrocuted.

Standby power

Dell products with standby power must be unplugged before you open the case. Systems that incorporate standby power are essentially powered while turned off. The internal power enables the system to be remotely turned on (wake on LAN) and suspended into a sleep mode and has other advanced power management features.

Unplugging, pressing and holding the power button for 15 seconds should discharge residual power in the system board.

Bonding

Bonding is a method for connecting two or more grounding conductors to the same electrical potential. This is done through the use of a field service electrostatic discharge (ESD) kit. When connecting a bonding wire, ensure that it is connected to bare metal and never to a painted or non-metal surface. The wrist strap should be secure and in full contact with your skin, and ensure that you remove all jewelry such as watches, bracelets, or rings prior to bonding yourself and the equipment.

Electrostatic discharge—ESD protection

ESD is a major concern when you handle electronic components, especially sensitive components such as expansion cards, processors, memory DIMMs, and system boards. Very slight charges can damage circuits in ways that may not be obvious, such as intermittent problems or a shortened product life span. As the industry pushes for lower power requirements and increased density, ESD protection is an increasing concern.

Due to the increased density of semiconductors used in recent Dell products, the sensitivity to static damage is now higher than in previous Dell products. For this reason, some previously approved methods of handling parts are no longer applicable.

Two recognized types of ESD damage are catastrophic and intermittent failures.

- **Catastrophic** – Catastrophic failures represent approximately 20 percent of ESD-related failures. The damage causes an immediate and complete loss of device functionality. An example of catastrophic failure is a memory DIMM that has received a static shock and immediately generates a "No POST/No Video" symptom with a beep code emitted for missing or nonfunctional memory.
- **Intermittent** – Intermittent failures represent approximately 80 percent of ESD-related failures. The high rate of intermittent failures means that most of the time when damage occurs, it is not immediately recognizable. The DIMM receives a static shock, but the tracing is merely weakened and does not immediately produce outward symptoms related to the damage. The weakened trace may take weeks or months to melt, and in the meantime may cause degradation of memory integrity, intermittent memory errors, etc.

The more difficult type of damage to recognize and troubleshoot is the intermittent (also called latent or "walking wounded") failure.

Perform the following steps to prevent ESD damage:

- Use a wired ESD wrist strap that is properly grounded. The use of wireless anti-static straps is no longer allowed; they do not provide adequate protection. Touching the chassis before handling parts does not ensure adequate ESD protection on parts with increased sensitivity to ESD damage.
- Handle all static-sensitive components in a static-safe area. If possible, use anti-static floor pads and workbench pads.
- When unpacking a static-sensitive component from its shipping carton, do not remove the component from the anti-static packing material until you are ready to install the component. Before unwrapping the anti-static packaging, ensure that you discharge static electricity from your body.
- Before transporting a static-sensitive component, place it in an anti-static container or packaging.

ESD field service kit

The unmonitored Field Service kit is the most commonly used service kit. Each Field Service kit includes three main components: anti-static mat, wrist strap, and bonding wire.

Components of an ESD field service kit

The components of an ESD field service kit are:

- **Anti-Static Mat** – The anti-static mat is dissipative and parts can be placed on it during service procedures. When using an anti-static mat, your wrist strap should be snug and the bonding wire should be connected to the mat and to any bare metal on the system being worked on. Once deployed properly, service parts can be removed from the ESD bag and placed directly on the mat. ESD-sensitive items are safe in your hand, on the ESD mat, in the system, or inside a bag.
- **Wrist Strap and Bonding Wire** – The wrist strap and bonding wire can be either directly connected between your wrist and bare metal on the hardware if the ESD mat is not required, or connected to the anti-static mat to protect hardware that is temporarily placed on the mat. The physical connection of the wrist strap and bonding wire between your skin, the ESD mat, and the hardware is known as bonding. Use only Field Service kits with a wrist strap, mat, and bonding wire. Never use wireless wrist straps. Always be aware that the internal wires of a wrist strap are prone to damage from normal wear and tear, and must be checked regularly with a wrist strap tester in order to avoid accidental ESD hardware damage. It is recommended to test the wrist strap and bonding wire at least once per week.
- **ESD Wrist Strap Tester** – The wires inside of an ESD strap are prone to damage over time. When using an unmonitored kit, it is a best practice to regularly test the strap prior to each service call, and at a minimum, test once per week. A wrist strap tester is the best method for doing this test. If you do not have your own wrist strap tester, check with your regional office to find out if they have one. To perform the test, plug the wrist-strap's bonding-wire into the tester while it is strapped to your wrist and push the button to test. A green LED is lit if the test is successful; a red LED is lit and an alarm sounds if the test fails.
- **Insulator Elements** – It is critical to keep ESD sensitive devices, such as plastic heat sink casings, away from internal parts that are insulators and often highly charged.
- **Working Environment** – Before deploying the ESD Field Service kit, assess the situation at the customer location. For example, deploying the kit for a server environment is different than for a desktop or portable environment. Servers are typically installed in a rack within a data center; desktops or portables are typically placed on office desks or cubicles. Always look for a large open flat work area that is free of clutter and large enough to deploy the ESD kit with additional space to accommodate the type of system that is being repaired. The workspace should also be free of insulators that can cause an ESD event. On the work area, insulators such as Styrofoam and other plastics should always be moved at least 12 inches or 30 centimeters away from sensitive parts before physically handling any hardware components

- **ESD Packaging** – All ESD-sensitive devices must be shipped and received in static-safe packaging. Metal, static-shielded bags are preferred. However, you should always return the damaged part using the same ESD bag and packaging that the new part arrived in. The ESD bag should be folded over and taped shut and all the same foam packing material should be used in the original box that the new part arrived in. ESD-sensitive devices should be removed from packaging only at an ESD-protected work surface, and parts should never be placed on top of the ESD bag because only the inside of the bag is shielded. Always place parts in your hand, on the ESD mat, in the system, or inside an anti-static bag.
- **Transporting Sensitive Components** – When transporting ESD sensitive components such as replacement parts or parts to be returned to Dell, it is critical to place these parts in anti-static bags for safe transport.

ESD protection summary

It is recommended to use the traditional wired ESD grounding wrist strap and protective anti-static mat at all times when servicing Dell products. In addition, it is critical to keep sensitive parts separate from all insulator parts while performing service and that they use anti-static bags for transporting sensitive components.

Transporting sensitive components

When transporting ESD sensitive components such as replacement parts or parts to be returned to Dell, it is critical to place these parts in anti-static bags for safe transport.

After working inside your computer

About this task

 **CAUTION:** Leaving stray or loose screws inside your computer may severely damage your computer.

Steps

1. Replace all screws and ensure that no stray screws remain inside your computer.
2. Connect any external devices, peripherals, or cables you removed before working on your computer.
3. Replace any media cards, discs, or any other parts that you removed before working on your computer.
4. Connect your computer and all attached devices to their electrical outlets.
 -  **NOTE:** To exit service mode, ensure to connect the AC adapter to the power-adapter port on your computer.
5. Press the power button to turn on the computer. Your computer will automatically return to normal functioning mode.

BitLocker

 **CAUTION:** If BitLocker is not suspended before updating the BIOS, the next time you reboot the system it will not recognize the BitLocker key. You will then be prompted to enter the recovery key to progress, and the system will ask for this on each reboot. If the recovery key is not known this can result in data loss or an unnecessary operating system reinstall. For more information about this subject, see [Knowledge Article: updating the BIOS on Dell systems with BitLocker enabled](#).

The installation of the following components triggers BitLocker:

- Hard disk drive or solid state drive
- System board

Removing and installing components

NOTE: The images in this document may differ from your computer depending on the configuration you ordered.

Recommended tools

The procedures in this document may require the following tools:

- Phillips screwdriver #0
- Phillips screwdriver #1
- Plastic scribe

Screw list

NOTE: When removing screws from a component, it is recommended to note the screw type, the quantity of screws, and then place them in a screw storage box. This is to ensure that the correct number of screws and correct screw type is restored when the component is replaced.

NOTE: Some computers have magnetic surfaces. Ensure that the screws are not left attached to such surfaces when replacing a component.

NOTE: Screw color may vary with the configuration ordered.

Table 1. Screw list























Component	Screw type	Quantity	Screw image
Base cover	Captive screws NOTE: Screws are part of the base cover.	8	
3-cell battery/4-cell battery	Captive screws	3	
M.2 2230 solid-state drive (SSD) extension bracket	M2x2	2	
M.2 2230/2280 solid-state drive (SSD) thermal plate	M2x2	<ul style="list-style-type: none"> • Clamshell: 2 • 2-in-1: 1 	
M.2 2280 solid-state drive (SSD) (only for 2-in-1 models)	M2x2	2-in-1: 1	
WWAN card bracket	M2x2.5	1	
Heat-sink	M2x2.5	6	

Table 1. Screw list (continued)

Component	Screw type	Quantity	Screw image
WLAN-antenna module bracket (for 4G antennas)	M2x2	1	
WWAN shielding cover (for 5G antennas)	M2x2.5	3	
WLAN-antenna module	M2x2.5	2	
Darwin bracket	M2x2.5	1	
Display-cable bracket	M2x2	2	
Display hinges	M2.5x4	4	
Audio daughter-board	M2x2.5	1	
Smart card reader	M2x2.5	4	
Fingerprint reader bracket	M2x2.5	1	
System board	<ul style="list-style-type: none"> • M2x2.5 • M2x3 • M2x4 	<ul style="list-style-type: none"> • 3/4 • 2 • 2 	  
I/O daughter-board	M2x4	2	
Power button with optional fingerprint reader	M1.6x1.7	2	
Keyboard assembly	M1.6x1.7	<ul style="list-style-type: none"> • Aluminum - 19 • Carbon fiber - 26 	
Keyboard	M2x2	2	

Major components of Latitude 7430

The following image shows the major components of Latitude 7430.

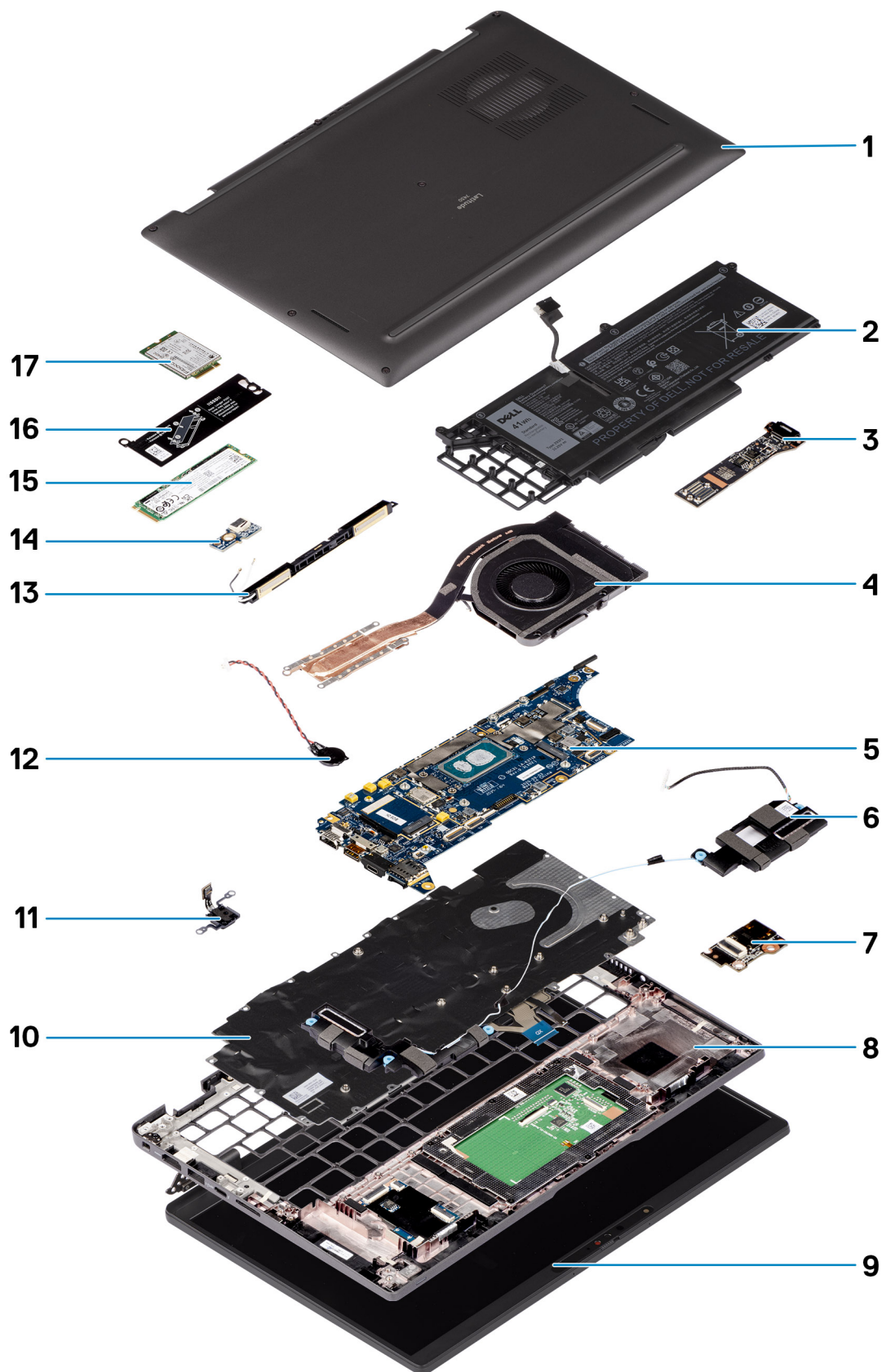

- 1. Base cover
- 3. I/O daughter-board
- 5. System board
- 7. Audio daughter-board

- 2. Battery
- 4. Heat-sink
- 6. Speakers
- 8. Palm-rest assembly

- 9. Display assembly
- 10. Keyboard assembly
- 11. Power button with optional fingerprint reader
- 12. Coin-cell battery
- 13. WLAN-antenna module
- 14. LED daughter-board
- 15. M.2 2280 solid-state drive
- 16. M.2 solid-state drive thermal plate
- 17. WWAN card

NOTE: Dell provides a list of components and their part numbers for the original system configuration purchased. These parts are available according to warranty coverages purchased by the customer. Contact your Dell sales representative for purchase options.

microSIM-card tray

Removing the microSIM-card tray

Prerequisites

1. Follow the procedure in [Before working inside your computer](#).

About this task

NOTE: This procedure applies only to computers shipped with a microSIM-card tray installed.

The following images indicate the location of the microSIM-card tray and provide a visual representation of the removal procedure.

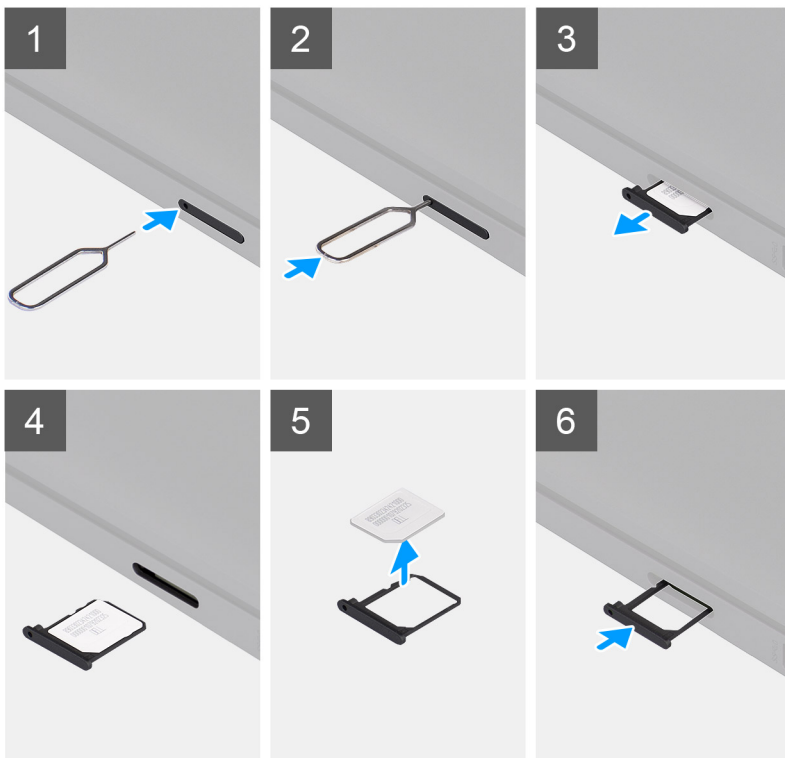

Steps

1. Insert a pin into the microSIM-card tray release hole to release the microSIM-card tray.
2. Push the pin to disengage the lock, and eject the microSIM-card tray.
3. Slide the microSIM-card tray out of the slot on the computer.
4. Remove the microSIM card from the microSIM-card tray.

5. Slide the microSIM-card tray into the microSIM-card tray slot on the computer, and push it to lock in place.

Installing the microSIM-card tray

Prerequisites

If you are replacing a component, remove the existing component before performing the installation procedure.

About this task

The following images indicate the location of the microSIM-card tray and provide a visual representation of the installation procedure.

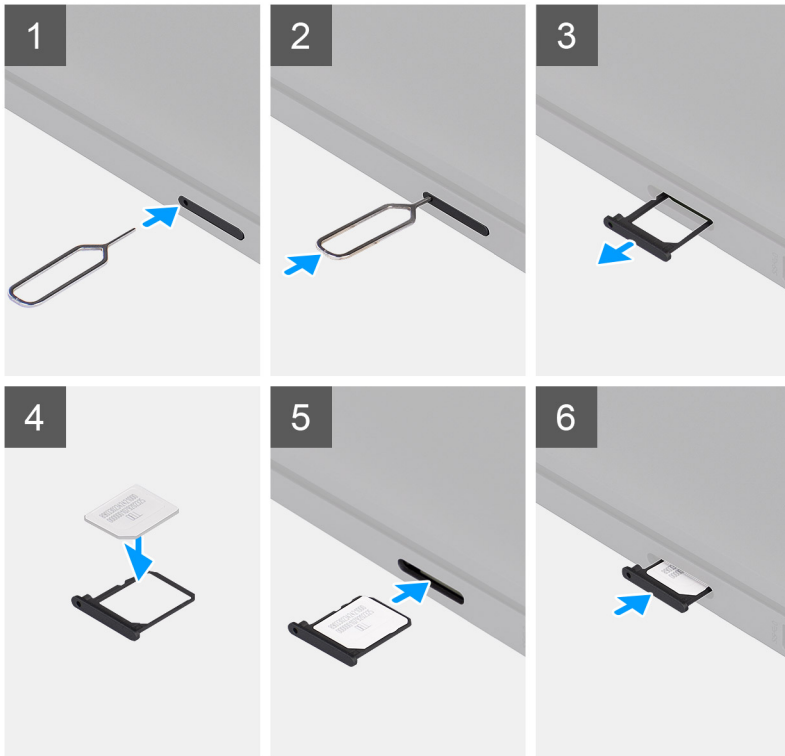

Steps

1. Insert a pin into the microSIM-card tray release hole to release the microSIM-card tray.
2. Push the pin to disengage the lock, and eject the microSIM-card tray.
3. Align and place the microSIM card in the microSIM-card slot on the microSIM-card tray.
4. Slide the microSIM-card tray into the microSIM-card tray slot on the computer, and push it to lock in place.

Next steps

1. Follow the procedure in [After working inside your computer](#).

Base cover

Removing the base cover

Prerequisites

1. Follow the procedure in [Before working inside your computer](#).

About this task

The following images indicate the location of the base cover and provide a visual representation of the removal procedure.

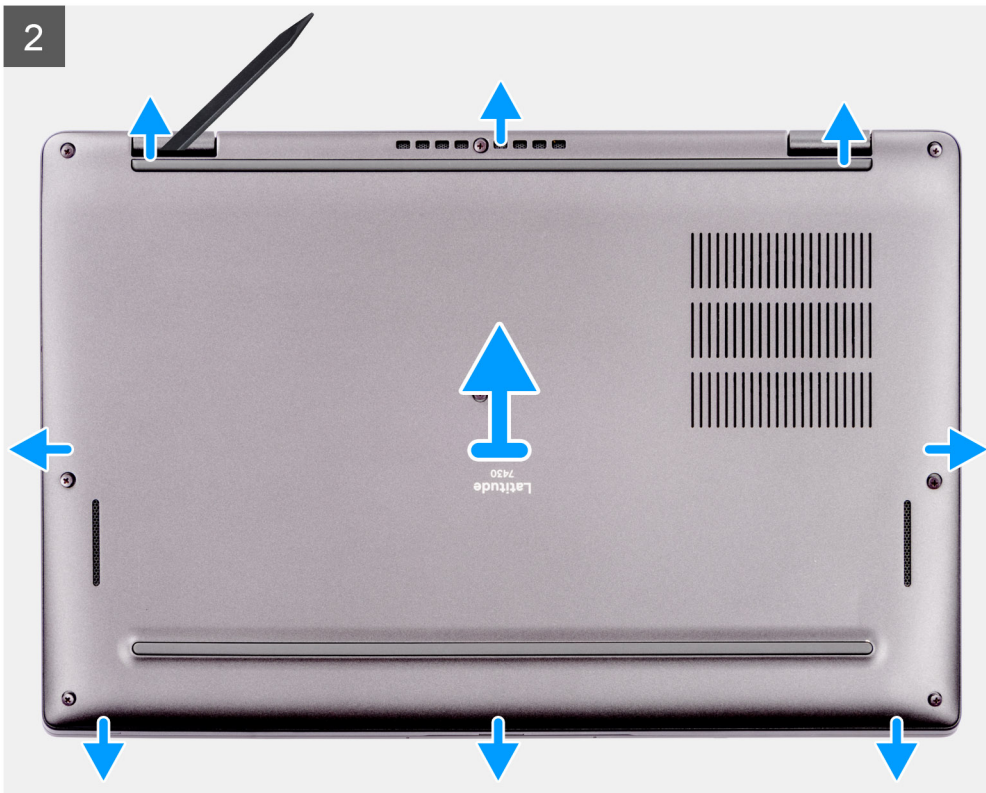

Steps

1. Loosen the eight captive screws that secure the base cover to the palm-rest and keyboard assembly.
2. Using a plastic scribe, pry open the base cover starting from the recesses, which are located in the U-shaped indents at the top edge of the base cover, near the hinges.



CAUTION: Do not slide the scribe through the edge of the top side of the base cover as it damages the latches inside the base cover.



CAUTION: Do not pry upwards from the edge near the vents, at the top side of the base cover, as it damages the base cover.



3. Pry open the top side of the base cover and continue working on the left, right and, bottom sides to open the base cover.
4. Lift the base cover from the left and right sides and remove the base cover off the palm-rest and keyboard assembly.

Installing the base cover

Prerequisites

If you are replacing a component, remove the existing component before performing the installation procedure.

About this task

The following images indicate the location of the base cover and provide a visual representation of the installation procedure.

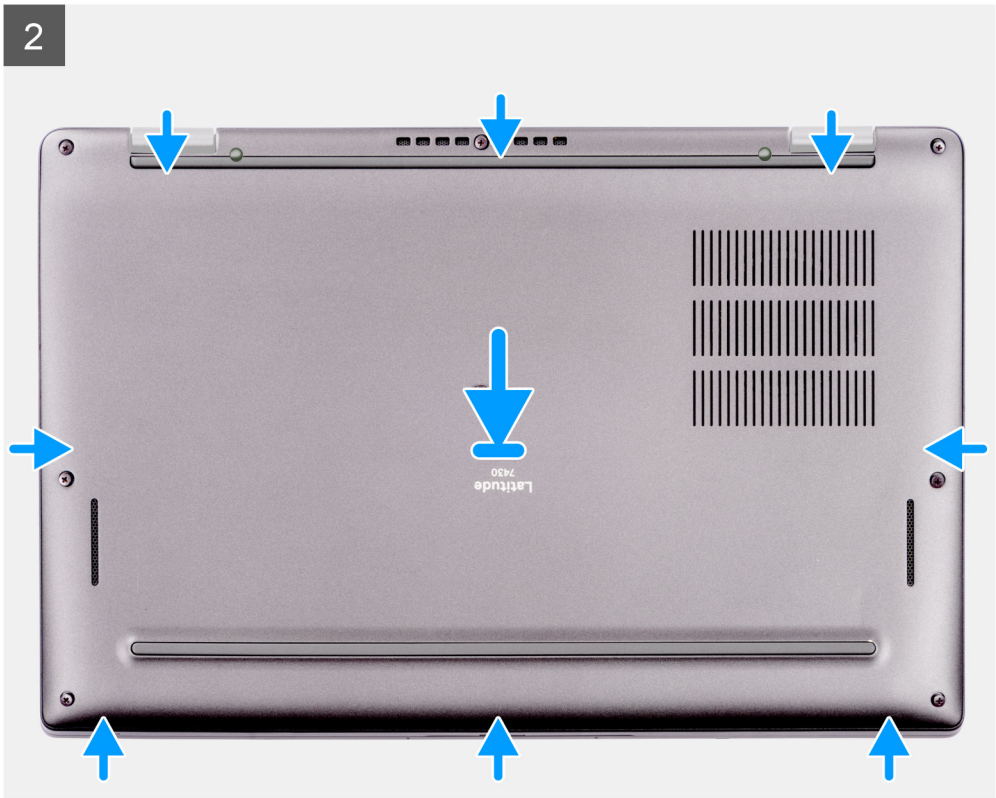

Steps

1. Place the base cover on top of the palm-rest and keyboard assembly.
2. Align the screw holes on the base cover with the screw holes on the palm-rest and keyboard assembly, and snap the base cover latches into place.
3. Tighten the eight captive screws to secure the base cover to the palm-rest and keyboard assembly.

Next steps

1. Follow the procedure in [After working inside your computer](#).

M.2 solid-state drive (for clamshell computers)

Removing the M.2 2230 solid-state drive (for computers shipped without a thermal plate)

Prerequisites

1. Follow the procedure in [Before working inside your computer](#).
2. Remove the [base cover](#).

About this task

NOTE: This procedure applies only to computers shipped with a M.2 2230 solid-state drive installed.

NOTE: The M.2 card that is installed on your computer depends on the configuration ordered. Supported card configurations on the M.2 card slot are:

- M.2 2230 solid-state drive
- M.2 2280 solid-state drive

The following image indicates the location of the M.2 2230 solid-state drive and provides a visual representation of the removal procedure.

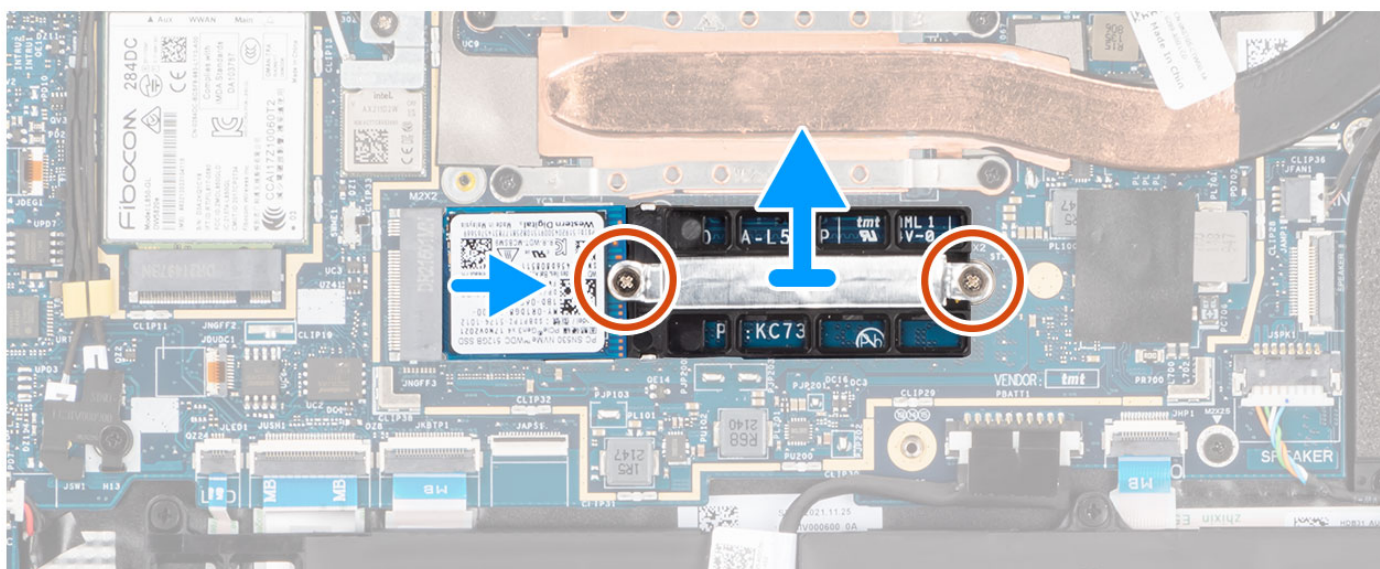
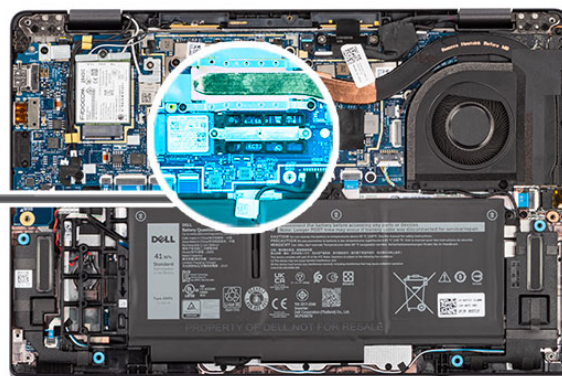

Steps

1. Remove the two screws (M2x2) that secure the M.2 2230 solid-state drive extension bracket to the palm-rest and keyboard assembly.
2. Slide and remove the M.2 2230 solid-state drive extension bracket from the M.2 card slot on the system board.
3. Slide and remove the M.2 2230 solid-state drive from the M.2 card slot on the system board.

i NOTE: For computers shipped without a solid-state drive thermal plate, a thermal pad sticker is adhered to the system board underneath the solid-state drive. If in the process of replacing the solid-state drive, the thermal pad is separated from the plate or gets adhered to the solid-state drive, reattach the thermal pad to the system board before reinstalling the solid-state drive to the system.

Installing the M.2 2230 solid-state drive (for computers shipped without a thermal plate)

Prerequisites

If you are replacing a component, remove the existing component before performing the installation procedure.

About this task

The following image indicates the location of the M.2 2230 solid-state drive and provides a visual representation of the installation procedure.

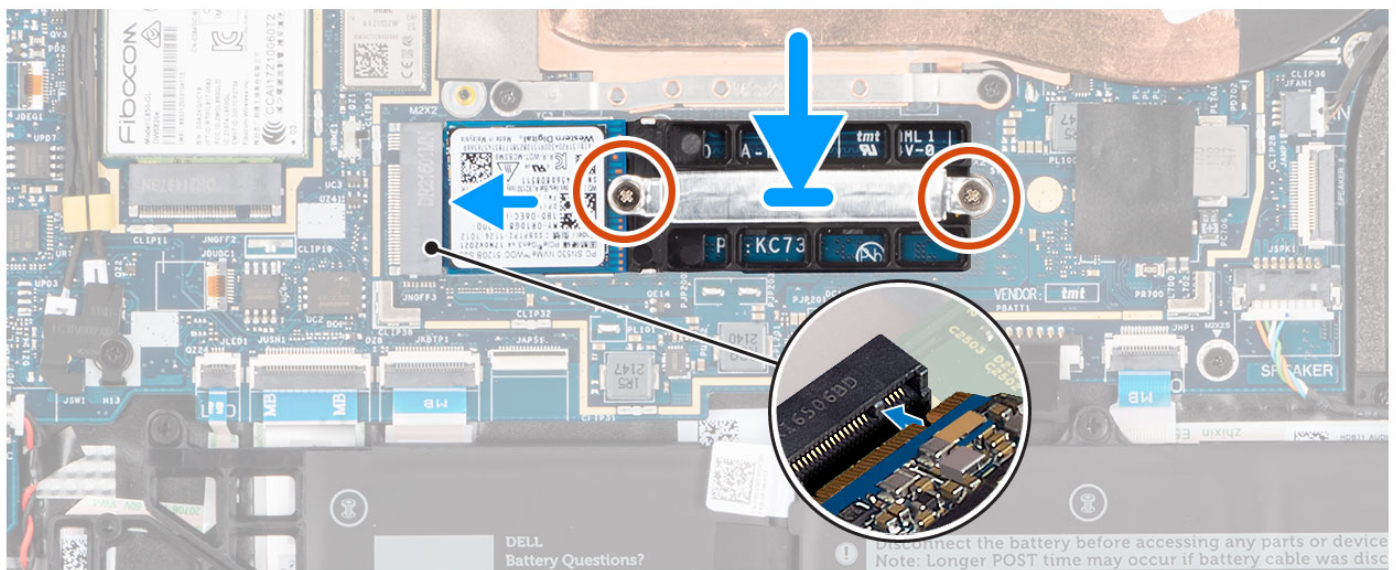
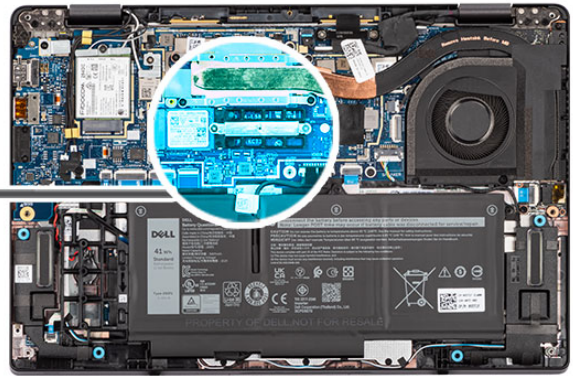

Steps

1. Align the notch on the M.2 2230 solid-state drive with the tab on the M.2 card slot on the system board.
2. Slide and place the M.2 2230 solid-state drive into the M.2 card slot on the system board.
 - NOTE:** For computers shipped without a solid-state drive thermal plate, a thermal pad sticker is adhered to the system board underneath the solid-state drive. If in the process of replacing the solid-state drive, the thermal pad is separated from the plate or gets adhered to the solid-state drive, readhere the thermal pad to the system board before reinstalling the solid-state drive to the system.
3. Place the M.2 2230 solid-state drive extension bracket into the M.2 card slot on the system board.
4. Align the screw holes on the M.2 2230 solid-state drive extension bracket with the screw holes on the palm-rest and keyboard assembly.
5. Replace the two screws (M2x2) to secure the M.2 2230 solid-state drive extension bracket to the palm-rest and keyboard assembly.

Next steps

1. Install the [base cover](#).
2. Follow the procedure in [After working inside your computer](#).
3. Verify if the storage device is installed correctly:
 - a. Turn on or restart your system.
 - b. Press F2 when the Dell logo is displayed on the screen to enter the system setup (BIOS) program.
 - NOTE:** A list of storage devices are displayed under the **System Information** in the **General** group.

- c. If you have replaced the primary storage device that had the operating system installed, search in the Knowledge Base Resource at www.dell.com/support.

Removing the M.2 2230 solid-state drive (for computers shipped with a thermal plate)

Prerequisites

1. Follow the procedure in [Before working inside your computer](#).
2. Remove the [base cover](#).

About this task

NOTE: This procedure applies only to computers shipped with a M.2 2230 solid-state drive installed.

NOTE: The M.2 card that is installed on your computer depends on the configuration ordered. Supported card configurations on the M.2 card slot are:

- M.2 2230 solid-state drive
- M.2 2280 solid-state drive

The following images indicate the location of the M.2 2230 solid-state drive and provide a visual representation of the removal procedure.

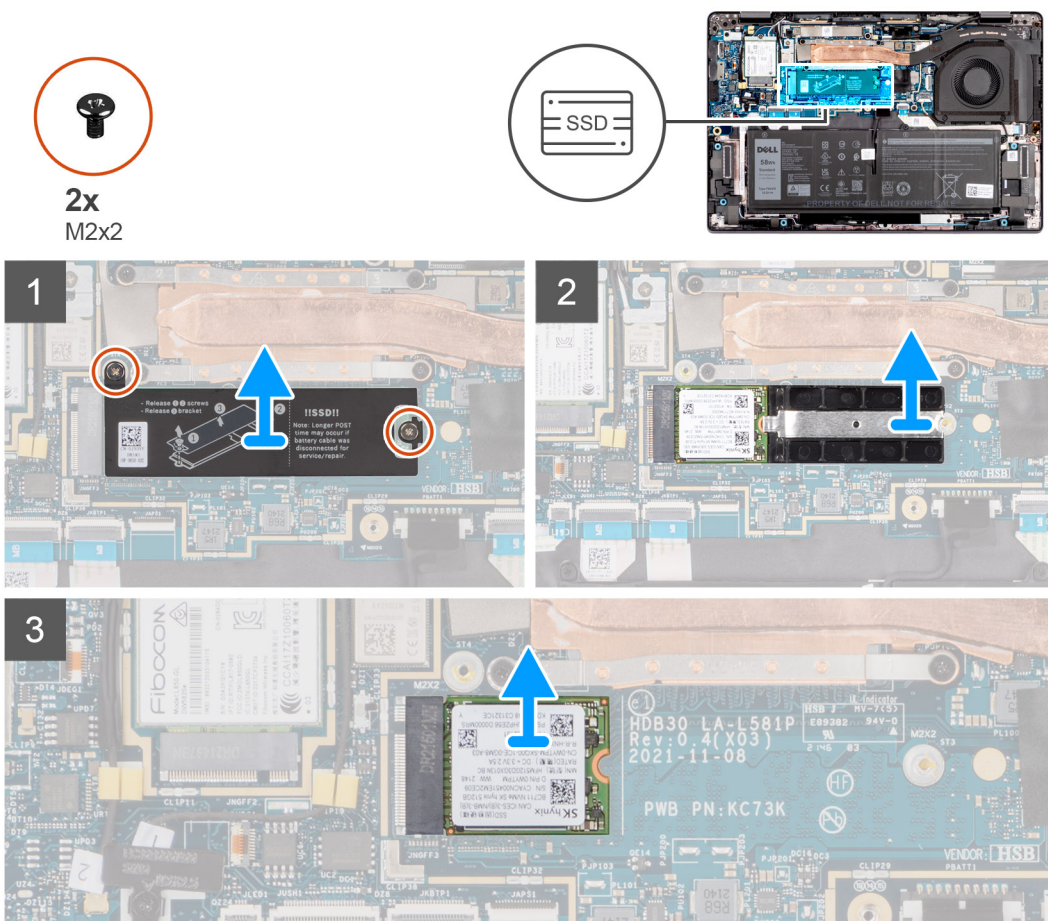

Steps

1. Remove the two screws (M2x2) that secure the M.2 2230 solid-state drive thermal plate to the palm-rest and keyboard assembly.
2. Slide and lift the M.2 2230 solid-state drive thermal plate off the M.2 2230 solid-state drive.

NOTE: A thermal pad is included with the solid-state drive thermal plate and must always be adhered to the plate. If in the process of replacing the solid-state drive, the thermal pad is separated from the thermal plate or gets adhered to the solid-state drive, readhere the thermal pad to the solid-state drive thermal plate before reinstalling the thermal plate to the system.

- Slide and remove the M.2 2230 solid-state drive extension bracket from the M.2 card slot on the system board.
- Slide and remove the M.2 2230 solid-state drive from the M.2 card slot on the system board.

Installing the M.2 2230 solid-state drive (for computers shipped with a thermal plate)

Prerequisites

If you are replacing a component, remove the existing component before performing the installation procedure.

About this task

The following images indicate the location of the M.2 2230 solid-state drive and provide a visual representation of the installation procedure.

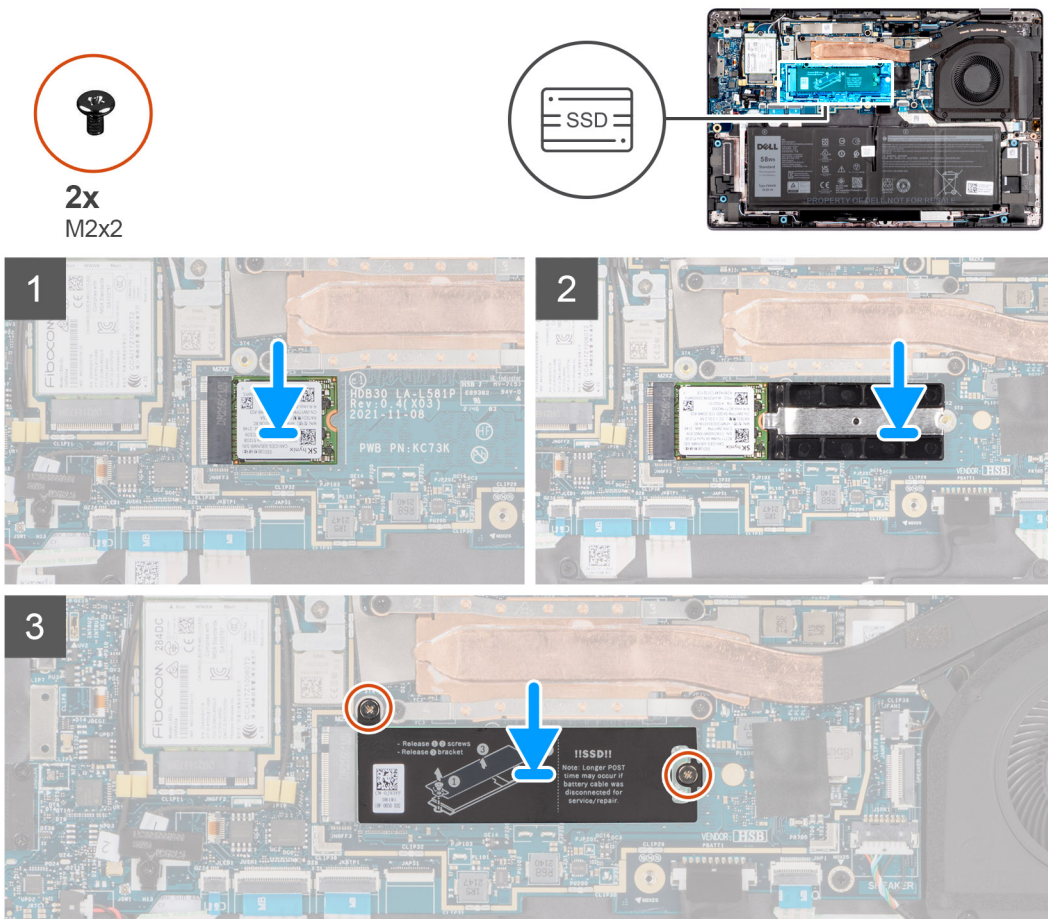

Steps

- Align the notch on the M.2 2230 solid-state drive with the tab on the M.2 card slot on the system board.
- Slide and place the M.2 2230 solid-state drive into the M.2 card slot on the system board.
- Place the M.2 2230 solid-state drive extension bracket into the M.2 card slot on the system board.
- Place the M.2 2230 solid-state drive thermal plate on the M.2 2230 solid-state drive.

NOTE: A thermal pad is included with the solid-state drive thermal plate and must always be adhered to the plate. If in the process of replacing the solid-state drive, the thermal pad is separated from the thermal plate or gets adhered to the solid-state drive, readhere the thermal pad to the solid-state drive thermal plate before reinstalling the thermal plate to the system.

- Align the screw holes on the M.2 2230 solid-state drive thermal plate with the screw holes on the palm-rest and keyboard assembly.
- Replace the two screws (M2x2) to secure the M.2 2230 solid-state drive thermal plate to the palm-rest and keyboard assembly.

Next steps

- Install the [base cover](#).
- Follow the procedure in [After working inside your computer](#).
- Verify if the storage device is installed correctly:
 - Turn on or restart your system.
 - Press F2 when the Dell logo is displayed on the screen to enter the system setup (BIOS) program.

NOTE: A list of storage devices are displayed under the **System Information** in the **General** group.
 - If you have replaced the primary storage device that had the operating system installed, search in the Knowledge Base Resource at www.dell.com/support.

Removing the M.2 2280 solid-state drive

Prerequisites

- Follow the procedure in [Before working inside your computer](#).
- Remove the [base cover](#).

About this task

- NOTE:** This procedure applies only to computers shipped with a M.2 2280 solid-state drive installed.
- NOTE:** The M.2 card that is installed on your computer depends on the configuration ordered. Supported card configurations on the M.2 card slot are:
- M.2 2230 solid-state drive
 - M.2 2280 solid-state drive

The following images indicate the location of the M.2 2280 solid-state drive and provide a visual representation of the removal procedure.

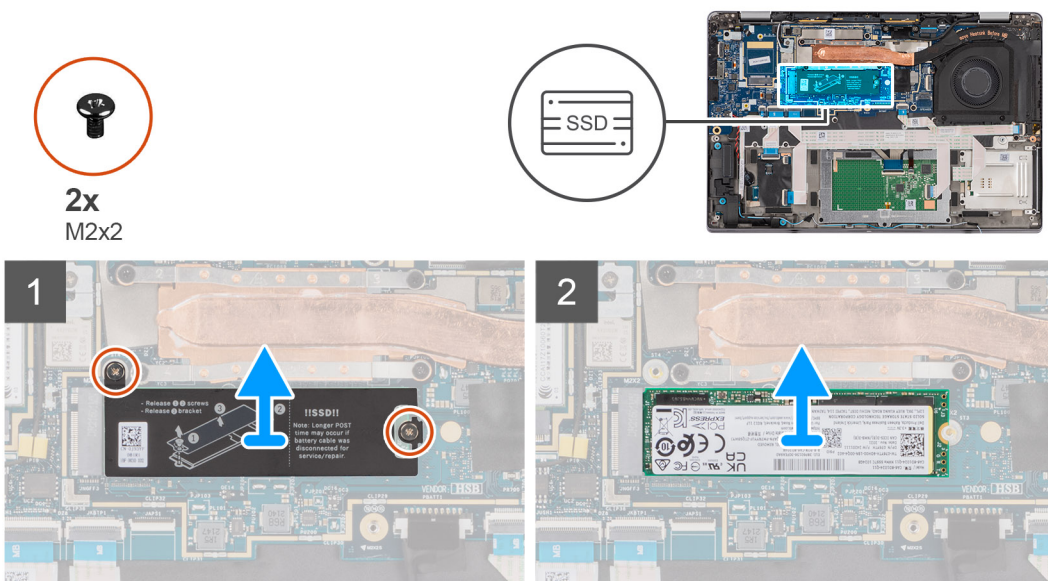

Steps

1. Remove the two screws (M2x2) that secure the M.2 2280 solid-state drive thermal plate to the palm-rest and keyboard assembly.
2. Slide and remove the M.2 2280 solid-state drive thermal plate off the palm-rest and keyboard assembly.
 - i NOTE:** A thermal pad is included with the solid-state drive thermal plate and must always be adhered to the plate. If in the process of replacing the solid-state drive, the thermal pad is separated from the thermal plate or gets adhered to the solid-state drive, readhere the thermal pad to the solid-state drive thermal plate before reinstalling the thermal plate to the system.
3. Slide and remove the M.2 2280 solid-state drive from the M.2 card slot on the system board.

Installing the M.2 2280 solid-state drive

Prerequisites

If you are replacing a component, remove the existing component before performing the installation procedure.

About this task

The following images indicate the location of the M.2 2280 solid-state drive and provide a visual representation of the installation procedure.

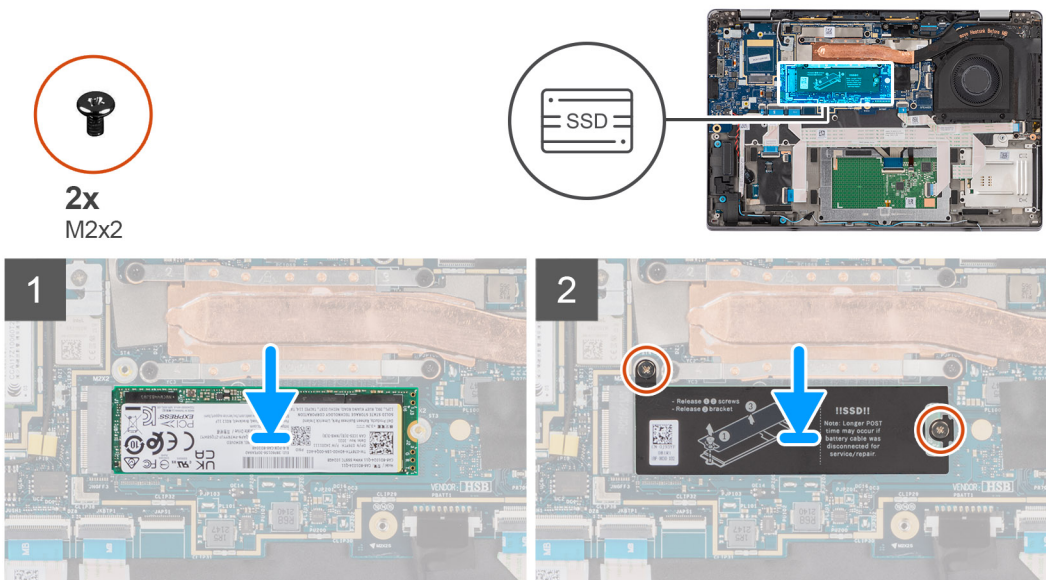

Steps

1. Align the notch on the M.2 2280 solid-state drive with the tab on the M.2 card slot on the system board.
2. Slide and place the M.2 2280 solid-state drive into the M.2 card slot on the system board.
3. Place the M.2 2280 solid-state drive thermal plate on the M.2 2280 solid-state drive.
 - i NOTE:** A thermal pad is included with the solid-state drive thermal plate and must always be adhered to the plate. If in the process of replacing the solid-state drive, the thermal pad is separated from the thermal plate or gets adhered to the solid-state drive, readhere the thermal pad to the solid-state drive thermal plate before reinstalling the thermal plate to the system.
4. Align the screw hole on the M.2 2280 solid-state drive thermal plate with the screw hole on the palm-rest and keyboard assembly.
5. Replace the two screws (M2x2) to secure the M.2 2280 solid-state drive thermal plate to the palm-rest and keyboard assembly.

Next steps

1. Install the [base cover](#).
2. Follow the procedure in [After working inside your computer](#).
3. Verify if the storage device is installed correctly:
 - a. Turn on or restart your system.
 - b. Press F2 when the Dell logo is displayed on the screen to enter the system setup (BIOS) program.
i **NOTE:** A list of storage devices are displayed under the **System Information** in the **General** group.
 - c. If you have replaced the primary storage device that had the operating system installed, search in the Knowledge Base Resource at www.dell.com/support.

M.2 solid-state drive (for 2-in-1 computers)

Removing the M.2 2230 solid-state drive (for computers shipped with a thermal plate)

Prerequisites

1. Follow the procedure in [Before working inside your computer](#).
2. Remove the [base cover](#).

About this task

i **NOTE:** This procedure applies only to computers shipped with a M.2 2230 solid-state drive installed.

i **NOTE:** The M.2 card that is installed on your computer depends on the configuration ordered. Supported card configurations on the M.2 card slot are:

- M.2 2230 solid-state drive
- M.2 2280 solid-state drive

The following images indicate the location of the M.2 2230 solid-state drive and provide a visual representation of the removal procedure.



3x
M2x2

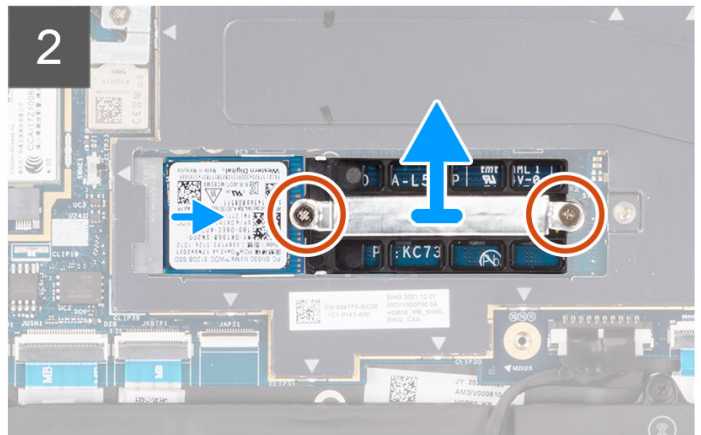
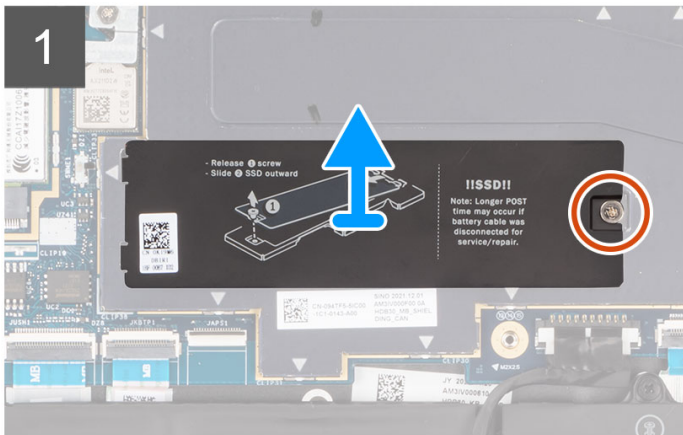
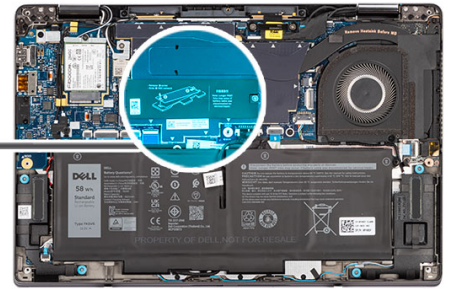

Steps

1. Remove the screw (M2x2) that secures the M.2 2230 solid-state drive thermal plate to the palm-rest and keyboard assembly.
2. Slide and lift the M.2 2230 solid-state drive thermal plate off the M.2 2230 solid-state drive.
 - i NOTE:** A thermal pad is included with the solid-state drive thermal plate and must always be adhered to the plate. If in the process of replacing the solid-state drive, the thermal pad is separated from the thermal plate or gets adhered to the solid-state drive, reattach the thermal pad to the solid-state drive thermal plate before reinstalling the thermal plate to the system.
3. Remove the two screws (M2x2) that secure the M.2 2230 solid-state drive extension bracket to the palm-rest and keyboard assembly.
4. Slide and remove the M.2 2230 solid-state drive extension bracket from the M.2 card slot on the system board.
5. Slide and remove the M.2 2230 solid-state drive from the M.2 card slot on the system board.

Installing the M.2 2230 solid-state drive (for computers shipped with a thermal plate)

Prerequisites

If you are replacing a component, remove the existing component before performing the installation procedure.

About this task

The following images indicate the location of the M.2 2230 solid-state drive and provide a visual representation of the installation procedure.



3x
M2x2

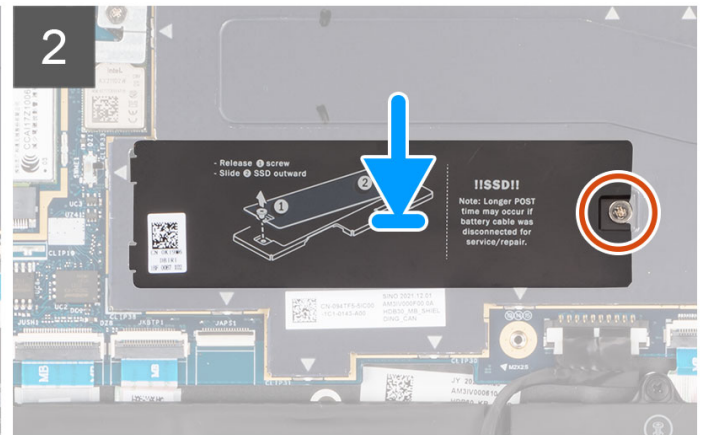
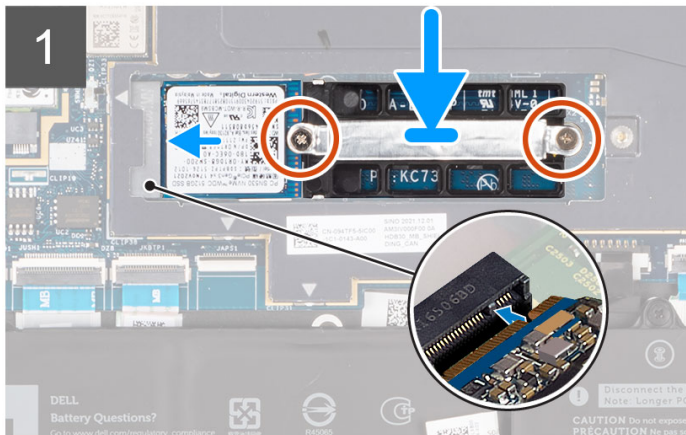
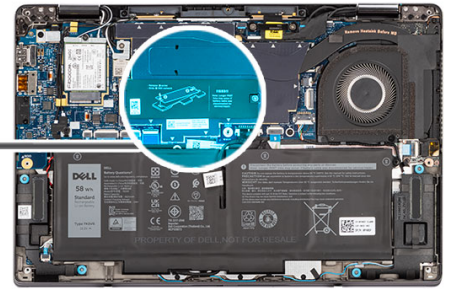

Steps

1. Align the notch on the M.2 2230 solid-state drive with the tab on the M.2 card slot on the system board.
2. Slide and place the M.2 2230 solid-state drive into the M.2 card slot on the system board.
3. Place the M.2 2230 solid-state drive extension bracket into the M.2 card slot on the system board.
4. Align the screw holes on the M.2 2230 solid-state drive extension bracket with the screw holes on the system board.
5. Replace the two screws (M2x2) to secure the M.2 2230 solid-state drive extension bracket to the M.2 card slot on the system board.
6. Place the M.2 2230 solid-state drive thermal plate on the M.2 2230 solid-state drive.
 - i** **NOTE:** A thermal pad is included with the solid-state drive thermal plate and must always be adhered to the plate. If in the process of replacing the solid-state drive, the thermal pad is separated from the thermal plate or gets adhered to the solid-state drive, reattach the thermal pad to the solid-state drive thermal plate before reinstalling the thermal plate to the system.
7. Align the screw hole on the M.2 2230 solid-state drive thermal plate with the screw hole on the palm-rest and keyboard assembly.
8. Replace the screw (M2x2) to secure the M.2 2230 solid-state drive thermal plate to the palm-rest and keyboard assembly.

Next steps

1. Install the [base cover](#).
2. Follow the procedure in [After working inside your computer](#).
3. Verify if the storage device is installed correctly:
 - a. Turn on or restart your system.
 - b. Press F2 when the Dell logo is displayed on the screen to enter the system setup (BIOS) program.
 - i** **NOTE:** A list of storage devices are displayed under the **System Information** in the **General** group.
 - c. If you have replaced the primary storage device that had the operating system installed, search in the Knowledge Base Resource at www.dell.com/support.

Removing the M.2 2280 solid-state drive

Prerequisites

1. Follow the procedure in [Before working inside your computer](#).
2. Remove the [base cover](#).

About this task

NOTE: This procedure applies only to computers shipped with a M.2 2280 solid-state drive installed.

NOTE: The M.2 card that is installed on your computer depends on the configuration ordered. Supported card configurations on the M.2 card slot are:

- M.2 2230 solid-state drive
- M.2 2280 solid-state drive

The following images indicate the location of the M.2 2280 solid-state drive and provide a visual representation of the removal procedure.

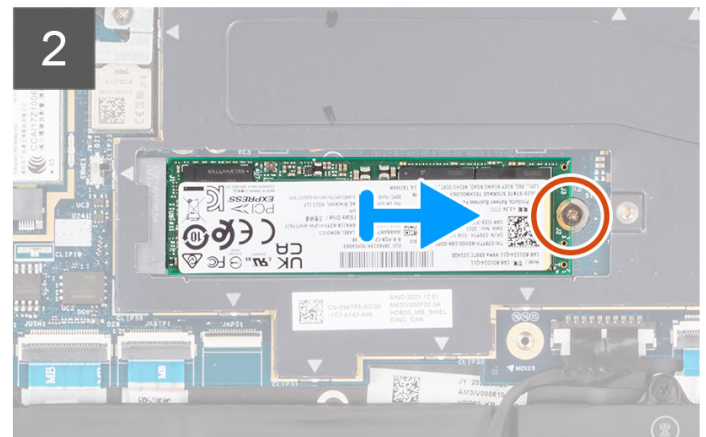
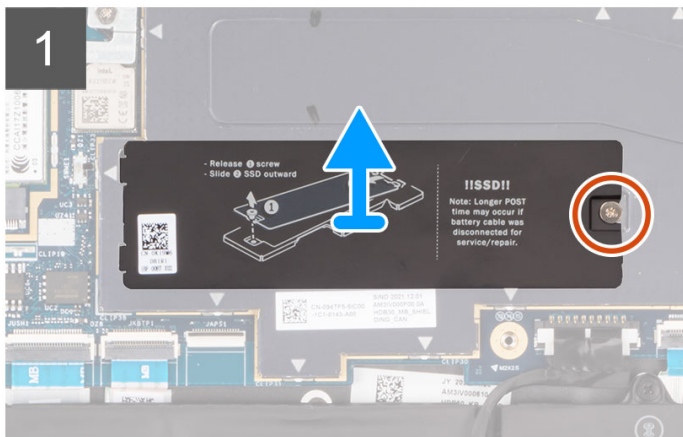
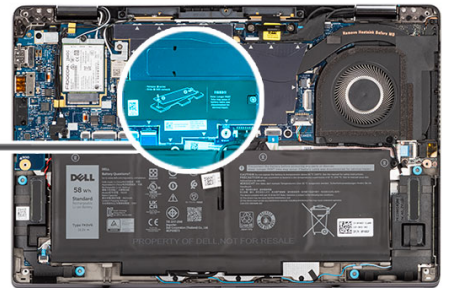

Steps

1. Remove the screw (M2x2) that secures the M.2 2280 solid-state drive thermal plate to the palm-rest and keyboard assembly.
2. Slide and remove the M.2 2280 solid-state drive thermal plate off the palm-rest and keyboard assembly.

NOTE: A thermal pad is included with the solid-state drive thermal plate and must always be adhered to the plate. If in the process of replacing the solid-state drive, the thermal pad is separated from the thermal plate or gets adhered to the solid-state drive, readhere the thermal pad to the solid-state drive thermal plate before reinstalling the thermal plate to the system.

3. Remove the screw (M2x2) that secures the M.2 2280 solid-state drive to the M.2 card slot on the system board.
4. Slide and remove the M.2 2280 solid-state drive from the M.2 card slot on the system board.

Installing the M.2 2280 solid-state drive

Prerequisites

If you are replacing a component, remove the existing component before performing the installation procedure.

About this task

The following images indicate the location of the M.2 2280 solid-state drive and provide a visual representation of the installation procedure.

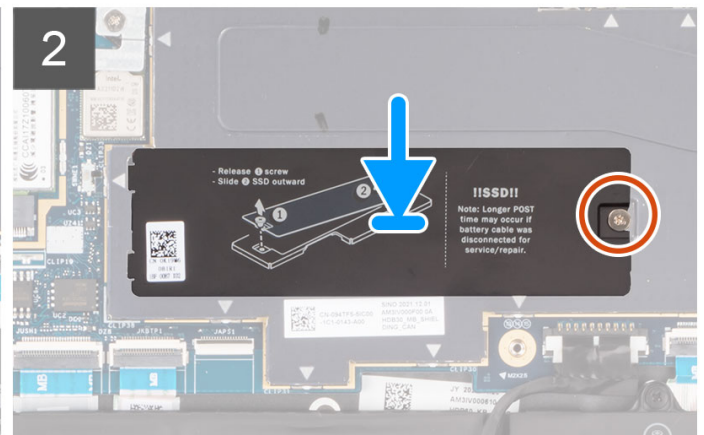
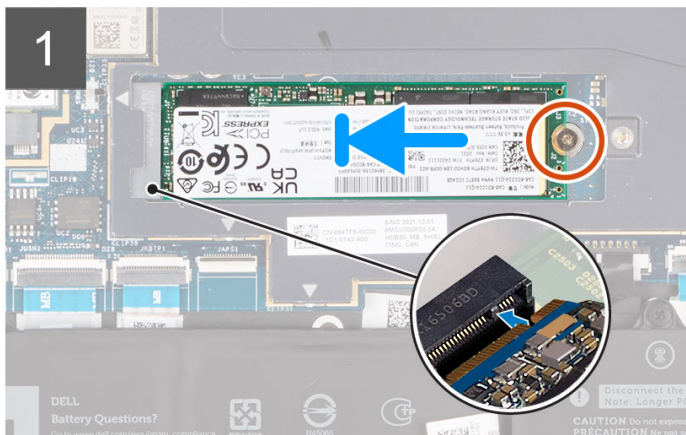
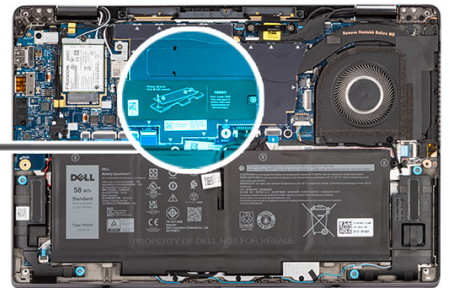

Steps

1. Align the notch on the M.2 2280 solid-state drive with the tab on the M.2 card slot on the system board.
2. Slide and place the M.2 2280 solid-state drive into the M.2 card slot on the system board.
3. Align the screw hole on the M.2 2280 solid-state drive with the screw hole on the system board.
4. Replace the screw (M2x2) to secure the M.2 2280 solid-state drive to the M.2 card slot on the system board.
5. Place the M.2 2280 solid-state drive thermal plate on the M.2 2280 solid-state drive.

i NOTE: A thermal pad is included with the solid-state drive thermal plate and must always be adhered to the plate. If in the process of replacing the solid-state drive, the thermal pad is separated from the thermal plate or gets adhered to the solid-state drive, readhere the thermal pad to the solid-state drive thermal plate before reinstalling the thermal plate to the system.

6. Align the screw hole on the M.2 2280 solid-state drive thermal plate with the screw hole on the palm-rest and keyboard assembly.
7. Replace the screw (M2x2) to secure the M.2 2280 solid-state drive thermal plate to the palm-rest and keyboard assembly.

Next steps

1. Install the [base cover](#).
2. Follow the procedure in [After working inside your computer](#).
3. Verify if the storage device is installed correctly:
 - a. Turn on or restart your system.

- b. Press F2 when the Dell logo is displayed on the screen to enter the system setup (BIOS) program.
 - NOTE:** A list of storage devices are displayed under the **System Information** in the **General** group.
- c. If you have replaced the primary storage device that had the operating system installed, search in the Knowledge Base Resource at www.dell.com/support.

WWAN card

Removing the 4G WWAN card

Prerequisites

1. Follow the procedure in [Before working inside your computer](#).
2. Remove the [base cover](#).

About this task

- NOTE:** This procedure applies only to computers shipped with a 4G WWAN card installed.
- NOTE:** WWAN card is configured at point of sales for 2-in-1 computers, WWAN card upgrade (CUS Kit) is not available for 2-in-1 computers.

The following images indicate the location of the 4G WWAN card and provide a visual representation of the removal procedure.

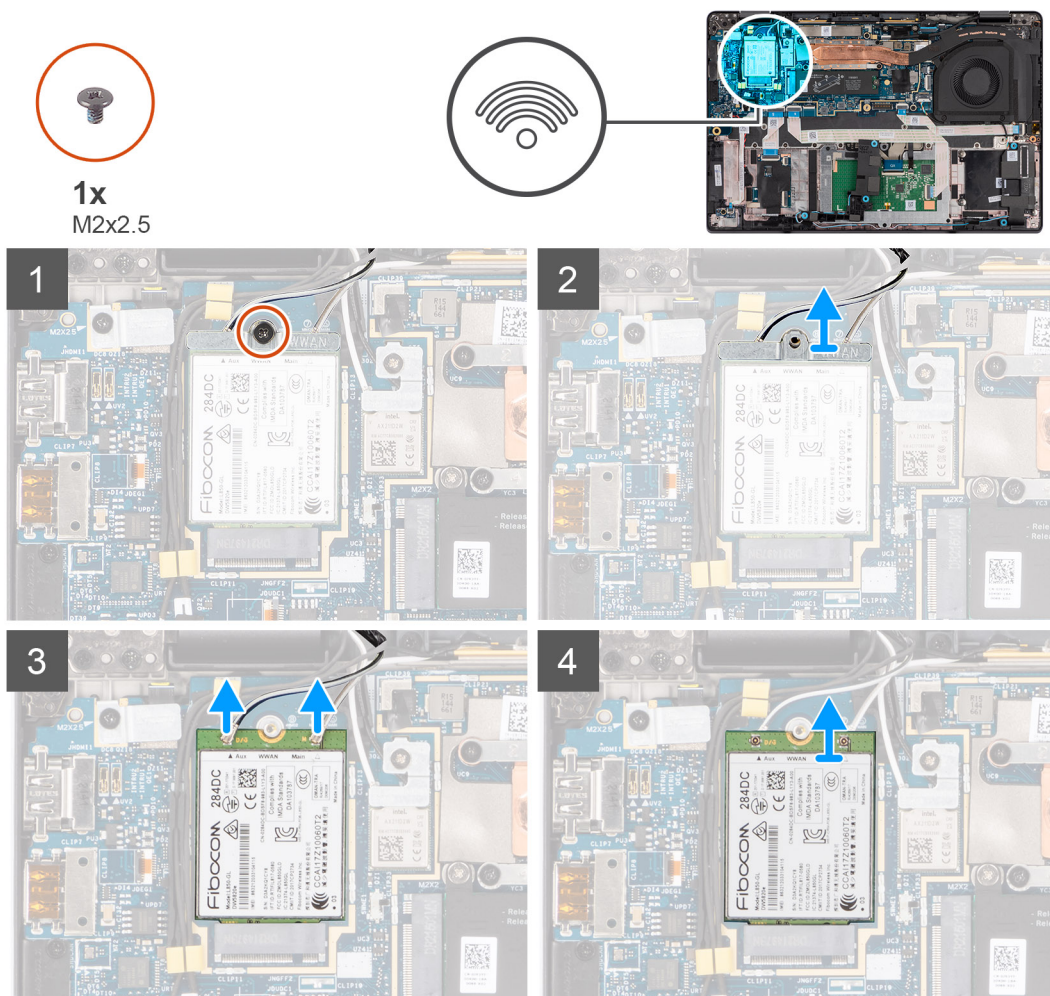

Steps

1. Using a plastic scribe, pry and remove the 4G WWAN-card shield covering the WWAN card.

NOTE: Pry open the 4G WWAN-card shield from the recess on the upper left corner.

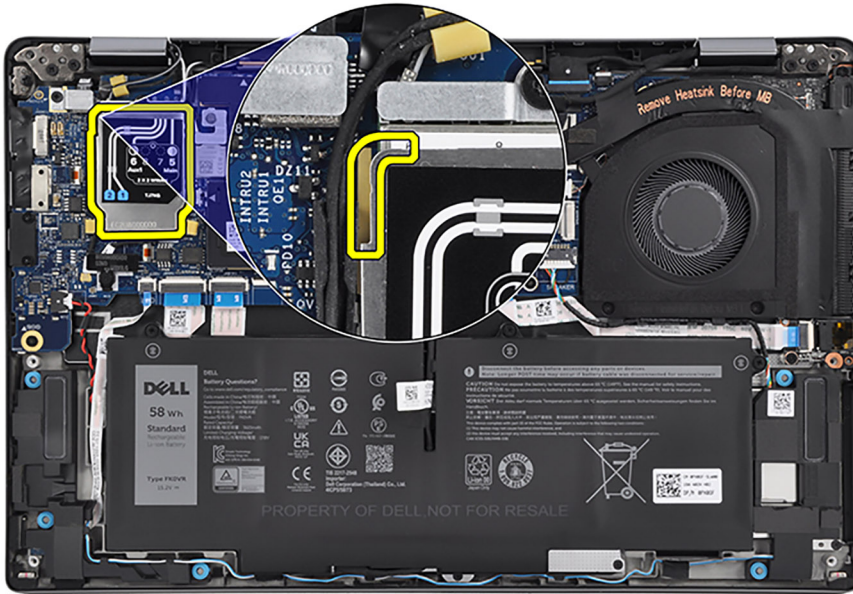

2. Remove the screw (M2x2.5) that secures the 4G WWAN-card bracket to the system board.
3. Lift the 4G WWAN-card bracket off the system board.
4. Disconnect the antenna cables from the connectors on the 4G WWAN card.
5. Slide and remove the 4G WWAN card from the M.2-card slot on the system board.

Installing the 4G WWAN card

Prerequisites

If you are replacing a component, remove the existing component before performing the installation procedure.

About this task

The following images indicate the location of the 4G WWAN card and provide a visual representation of the installation procedure.



1x
M2x2.5

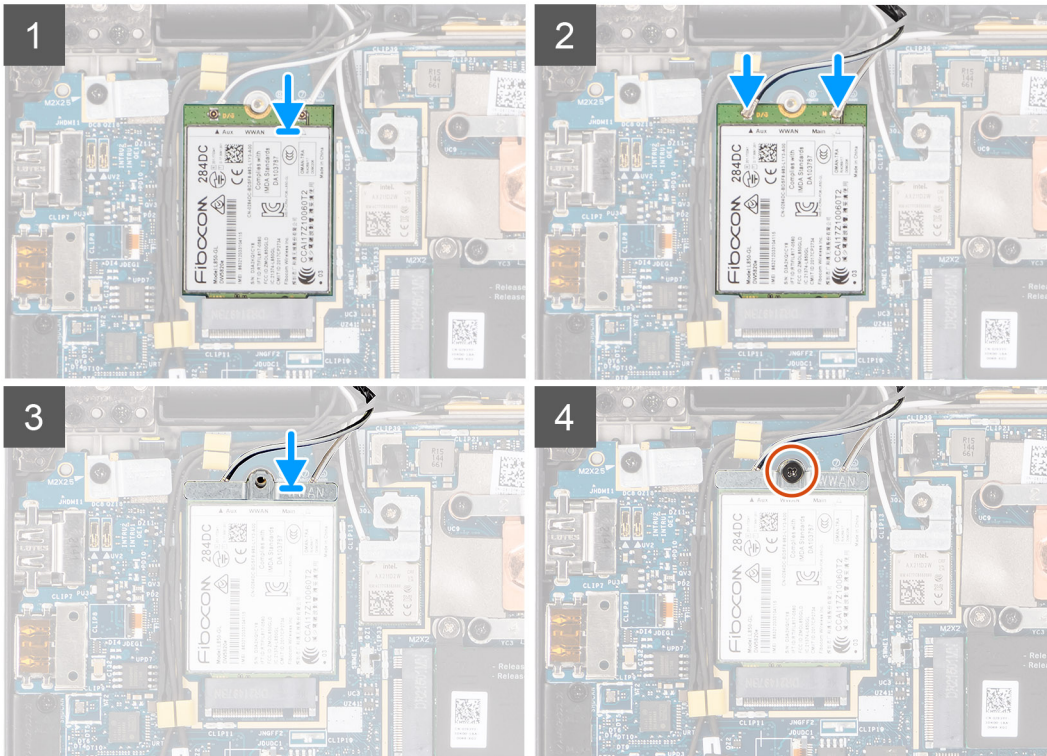
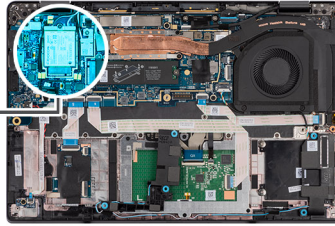

Steps

1. Align the notch on the 4G WWAN card with the tab on the M.2-card slot on the system board.
2. Slide the 4G WWAN card firmly into the M.2-card slot on the system board.
3. Connect the antenna cables to the connectors on the 4G WWAN card.

i NOTE: For computers shipped with a Cat 16 WWAN card that has four connectors, connect the #5 white/gray antenna cable to the main connector at the very right of the WWAN card and the #6 black/gray antenna cable to the Aux 1 connector at the very left.

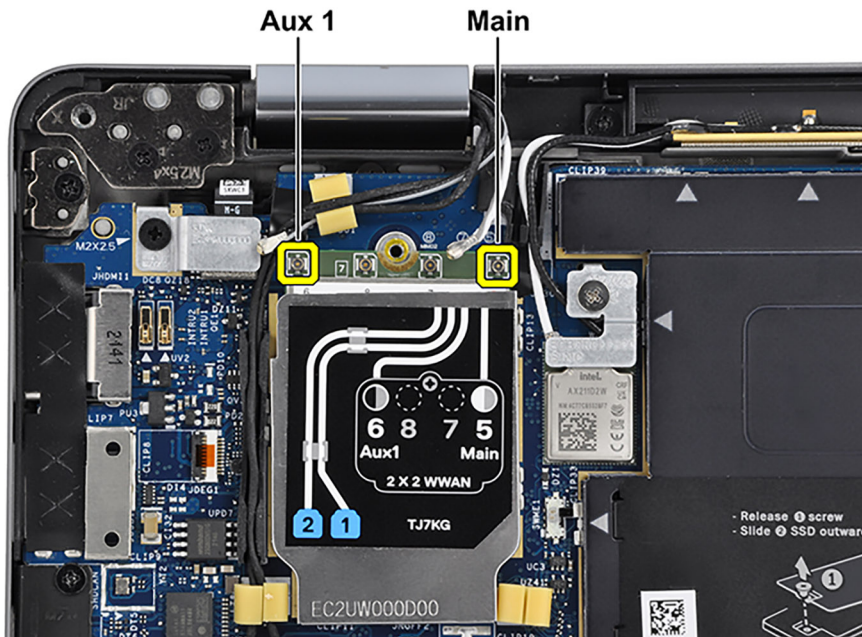

The following table provides the antenna-cable color scheme for the wireless card supported by your system.

Table 2. 4G WWAN-antenna cable color scheme

Connectors on the wireless card	Antenna cable color
Main (white triangle)	White
Auxiliary (black triangle)	Black

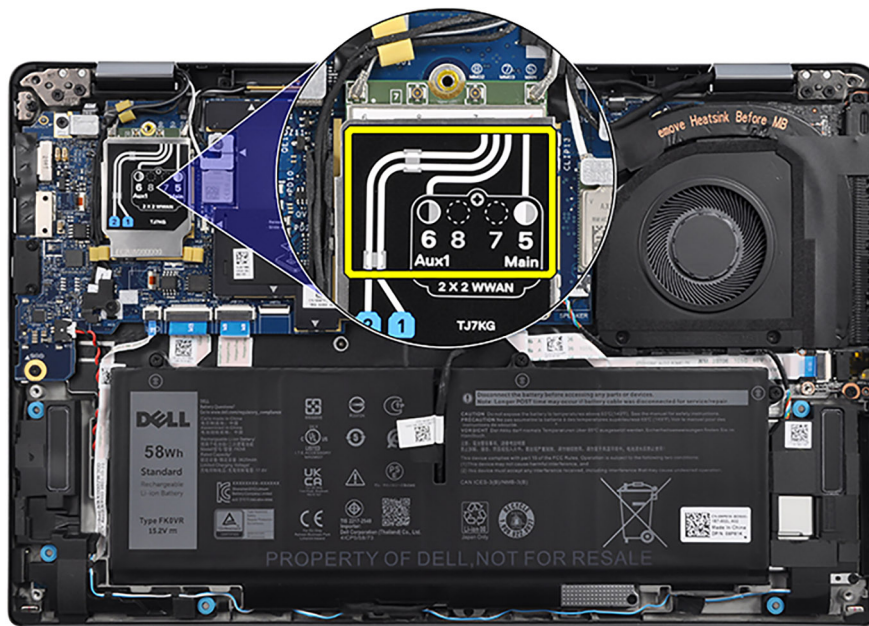
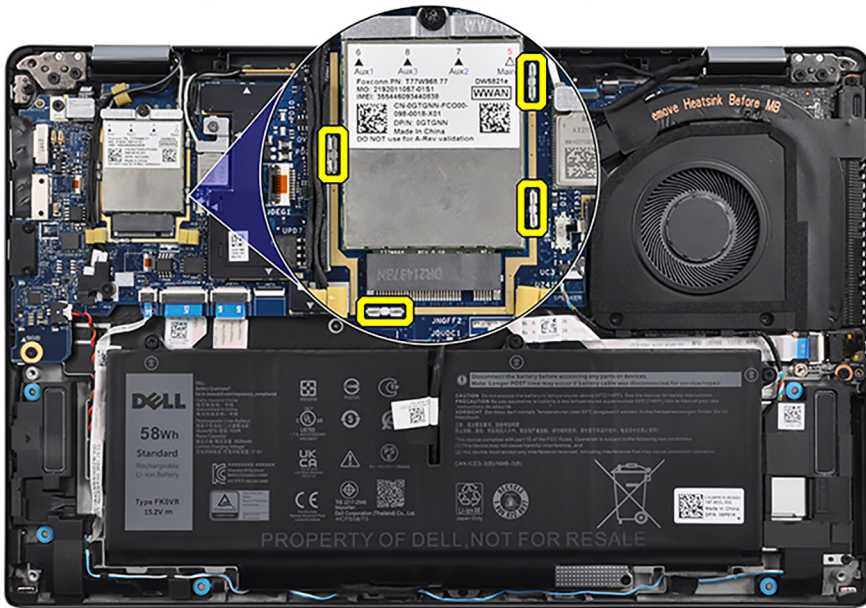

Figure 1. 4G WWAN configuration

4. Place the 4G WWAN-card bracket on the 4G WWAN card.
5. Align the screw hole on the 4G WWAN-card bracket with the screw hole on the system board.
6. Replace the screw (M2x2.5) to secure the 4G WWAN-card bracket and the 4G WWAN card to the system board.
7. Place the 4G WWAN-card shield over the 4G WWAN card and secure it in place.

NOTE: Insert the edges of the 4G WWAN-card shield into the clips on the system board to secure it in place.



NOTE: For instructions on how to find your computer's International Mobile Station Equipment Identity (IMEI) number, search in the Knowledge Base Resource at www.dell.com/support.

Next steps

1. Install the [base cover](#).
2. Follow the procedure in [After working inside your computer](#).

Removing the 5G WWAN card

Prerequisites

1. Follow the procedure in [Before working inside your computer](#).
2. Remove the [base cover](#).

About this task

NOTE: This procedure applies only to systems shipped with a 5G WWAN card installed.

NOTE: WWAN card is configured at point of sales for 2-in-1 computers, WWAN card upgrade (CUS Kit) is not available for 2-in-1 computers.

The following images indicate the location of the 5G WWAN card and provide a visual representation of the removal procedure.

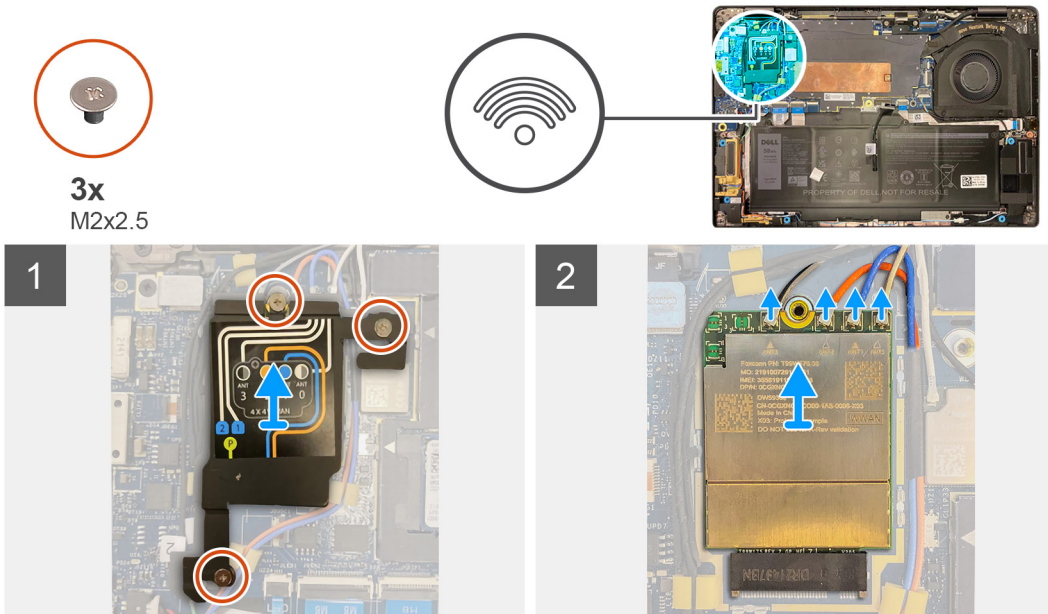

Steps

1. Remove the three screws (M2x2.5) that secure the 5G WWAN shielding cover to the system board.
2. Remove the 5G WWAN shielding cover from the system board.

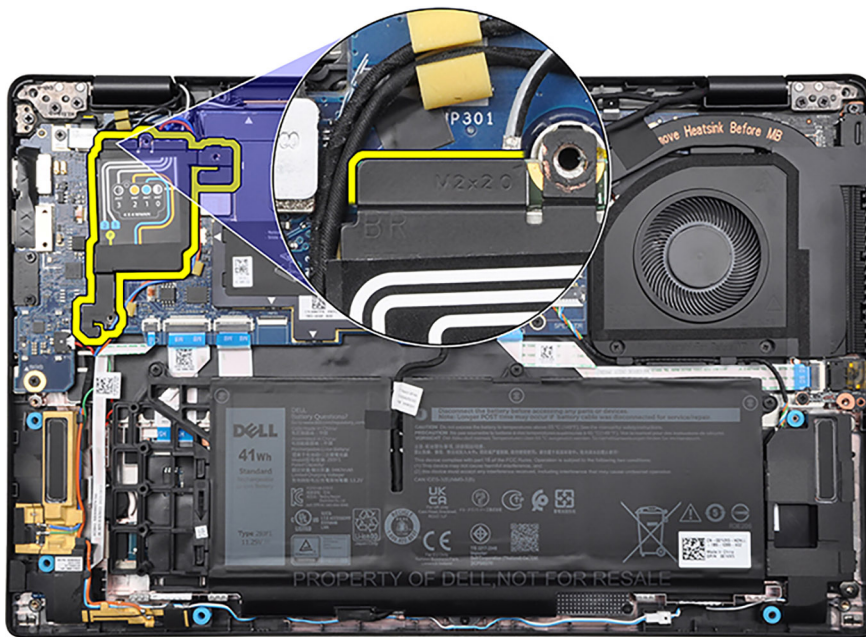

3. Disconnect the antenna cables from the connectors on the 5G WWAN card.
4. Slide and remove the 5G WWAN card from the M.2-card slot on the system board.

Installing the 5G WWAN card

Prerequisites

If you are replacing a component, remove the existing component before performing the installation procedure.

About this task

The following images indicate the location of the 5G WWAN card and provide a visual representation of the installation procedure.

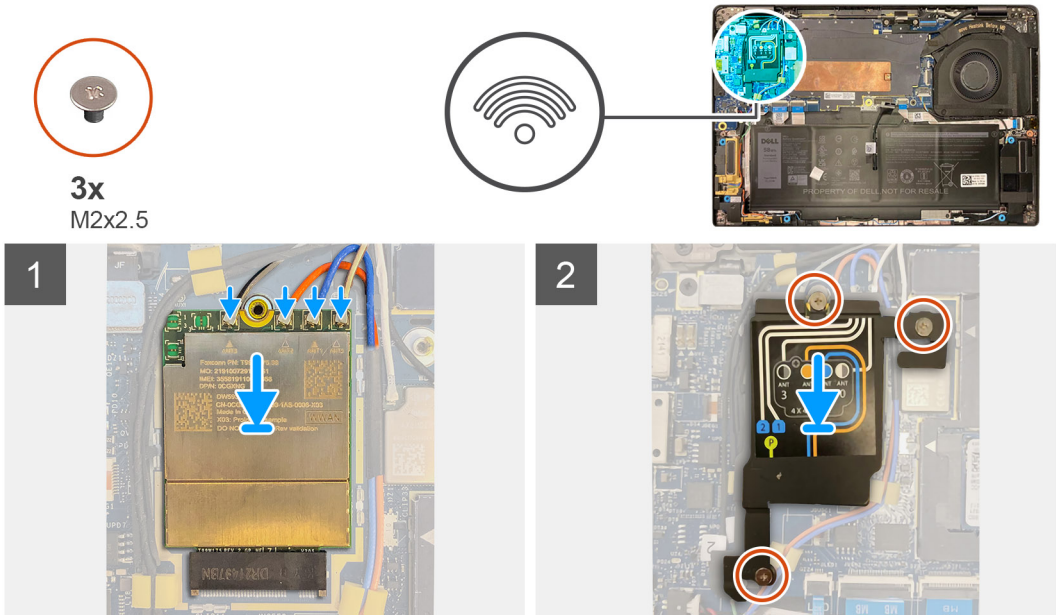

Steps

1. Align the notch on the 5G WWAN card with the tab on the M.2-card slot on the system board.
2. Slide the 5G WWAN card firmly into the M.2-card slot on the system board.
3. Connect the antenna cables to the connectors on the 5G WWAN card.

The following table provides the antenna-cable color scheme for the wireless card supported by your system.

Table 3. 5G WWAN-antenna cable color scheme

Connectors on the wireless card	Antenna cable color
Pin number 0	White/Gray
Pin number 1	Blue
Pin number 2	Orange
Pin number 3	Black/Gray

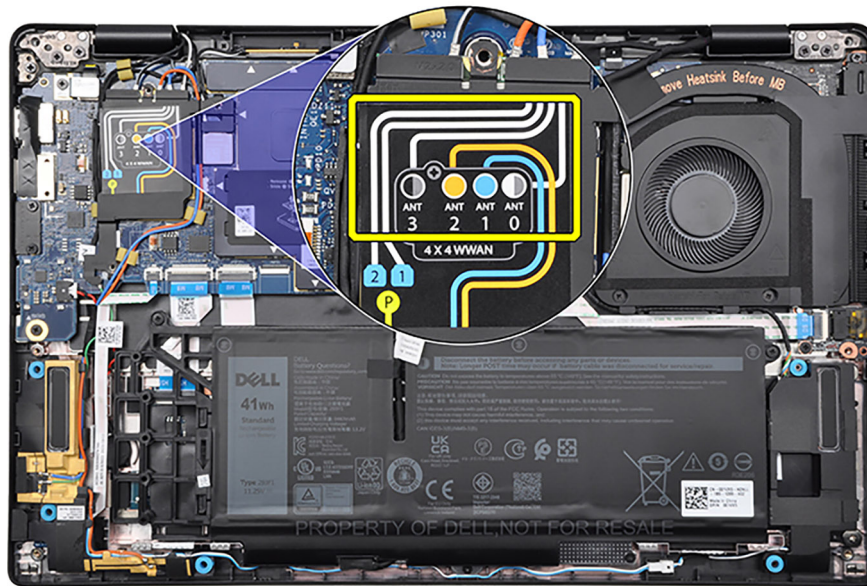

Figure 2. 5G WWAN configuration

4. Place the 5G WWAN shielding cover on the 5G WWAN card.
 - NOTE:** Insert the edges of the 5G WWAN shielding cover into the clips on the system board to secure it in place.
5. Align the screw hole on the 5G WWAN shielding cover with the screw hole on the system board.
6. Replace the three screws (M2x2.5) to secure the 5G WWAN shielding cover and the 5G WWAN card to the system board.
 - NOTE:** For instructions on how to find your computer's International Mobile Station Equipment Identity (IMEI) number, search in the Knowledge Base Resource at www.dell.com/support.

Next steps

1. Install the [base cover](#).
2. Follow the procedure in [After working inside your computer](#).

Battery

Lithium-ion battery precautions

CAUTION:

- Exercise caution when handling Lithium-ion batteries.
- Discharge the battery completely before removing it. Disconnect the AC power adapter from the system and operate the computer solely on battery power—the battery is fully discharged when the computer no longer turns on when the power button is pressed.
- Do not crush, drop, mutilate, or penetrate the battery with foreign objects.
- Do not expose the battery to high temperatures, or disassemble battery packs and cells.
- Do not apply pressure to the surface of the battery.
- Do not bend the battery.
- Do not use tools of any kind to pry on or against the battery.
- Ensure any screws during the servicing of this product are not lost or misplaced, to prevent accidental puncture or damage to the battery and other system components.

- If the battery gets stuck inside your computer as a result of swelling, do not try to release it as puncturing, bending, or crushing a lithium-ion battery can be dangerous. In such an instance, contact Dell technical support for assistance. See www.dell.com/contactdell.
- Always purchase genuine batteries from www.dell.com or authorized Dell partners and resellers.
- Swollen batteries should not be used and should be replaced and disposed properly. For guidelines on how to handle and replace swollen Lithium-ion batteries, see [Handling swollen Lithium-ion batteries](#).

Removing the 3-cell battery

Prerequisites

1. Follow the procedure in [Before working inside your computer](#).
2. Remove the [base cover](#).

About this task

The following image indicates the location of the 3-cell battery and provides a visual representation of the removal procedure.

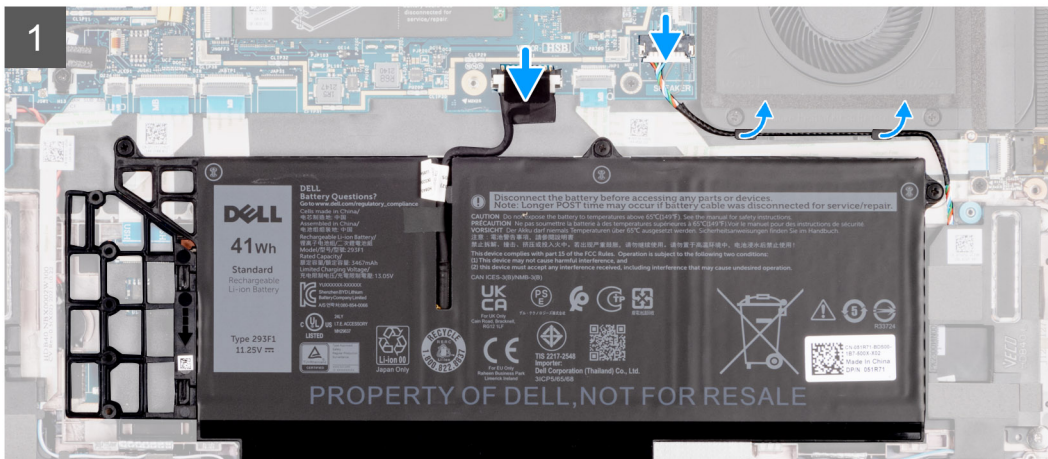
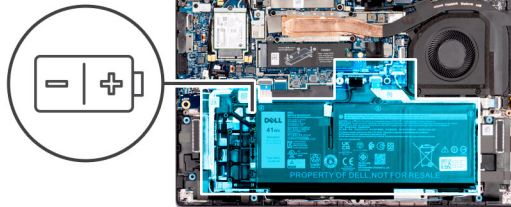

Steps

1. Use the pull tab to disconnect the battery cable from the connector on the system board.
2. Loosen the three captive screws that secure the 3-cell battery to the palm-rest and keyboard assembly.
3. Lift the 3-cell battery along with the battery cable off the palm-rest and keyboard assembly.
4. Disconnect the battery cable from the connector on the 3-cell battery.
5. Carefully push the battery filler downwards to remove it from the 3-cell battery.

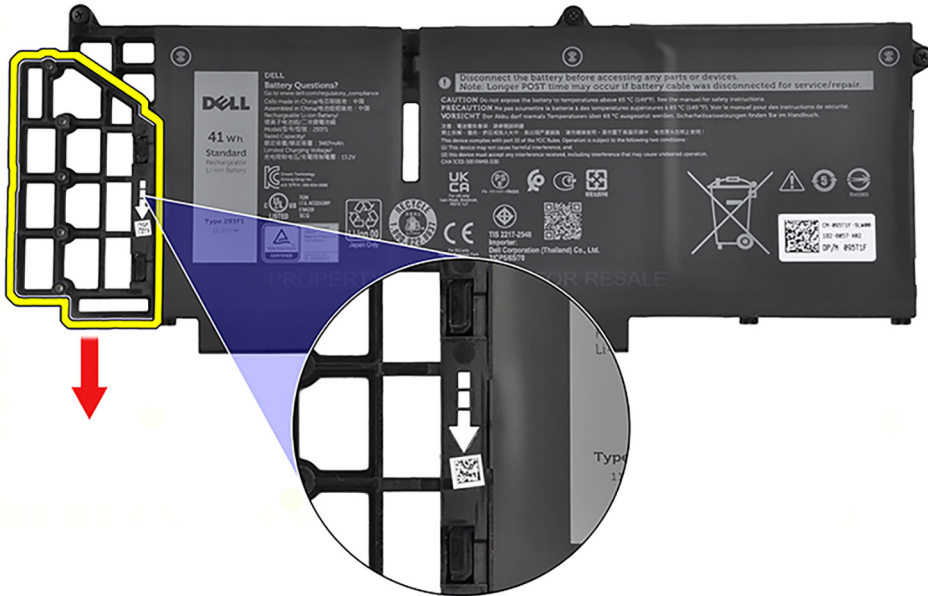

Installing the 3-cell battery

Prerequisites

If you are replacing a component, remove the existing component before performing the installation procedure.

About this task

The following image indicates the location of the 3-cell battery and provides a visual representation of the installation procedure.



3x

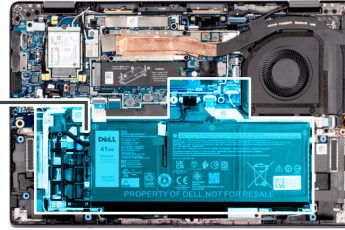
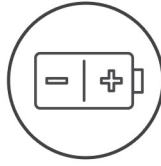

Steps

1. Carefully push the battery filler upwards to attach it to the 3-cell battery.

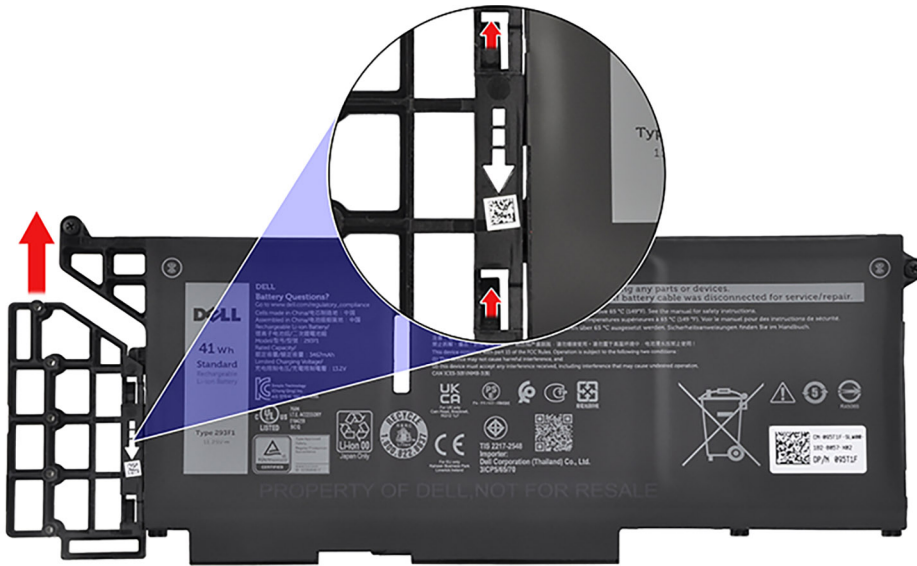

2. Place the 3-cell battery along with the battery cable on the palm-rest and keyboard assembly.
3. Align the screw holes on the 3-cell battery to the screw holes on the palm-rest and keyboard assembly.
4. Tighten the three captive screws to secure the 3-cell battery to the palm-rest and keyboard assembly.
5. Connect the battery cable to the connector on the system board.

Next steps

1. Install the [base cover](#).
2. Follow the procedure in [After working inside your computer](#).

Removing the 4-cell battery

Prerequisites

1. Follow the procedure in [Before working inside your computer](#).
2. Remove the [base cover](#).

About this task

The following image indicates the location of the 4-cell battery and provides a visual representation of the removal procedure.



3x

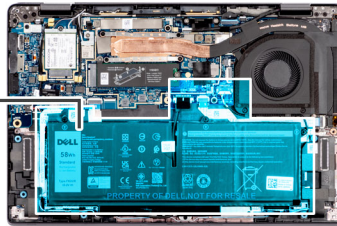
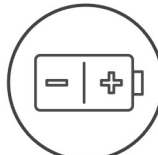

Steps

1. Use the pull tab to disconnect the battery cable from the connector on the system board.
2. Loosen the three captive screws that secure the 4-cell battery to the palm-rest and keyboard assembly.
3. Lift the 4-cell battery along with the battery cable off the palm-rest and keyboard assembly.

Installing the 4-cell battery

Prerequisites

If you are replacing a component, remove the existing component before performing the installation procedure.

About this task

The following image indicates the location of the 4-cell battery and provides a visual representation of the installation procedure.



3x

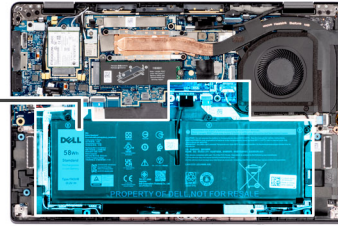
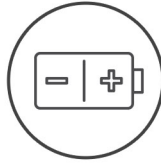

Steps

1. Place the 4-cell battery along with the battery cable on the palm-rest and keyboard assembly.
2. Align the screw holes on the 4-cell battery to the screw holes on the palm-rest and keyboard assembly.
3. Tighten the three captive screws to secure the 4-cell battery to the palm-rest and keyboard assembly.
4. Connect the battery cable to the connector on the system board.

Next steps

1. Install the [base cover](#).
2. Follow the procedure in [After working inside your computer](#).

Heat-sink

Removing the heat-sink

Prerequisites

1. Follow the procedure in [Before working inside your computer](#).
2. Remove the [base cover](#).

About this task

- NOTE:** The heat-sink may become hot during normal operation. Allow sufficient time for the heat-sink to cool before you touch it.
- NOTE:** For maximum cooling of the processor, do not touch the heat transfer areas on the heat-sink. The oils in your skin can reduce the heat transfer capability of the thermal grease.

The following image indicates the location of the heat-sink and provides a visual representation of the removal procedure.

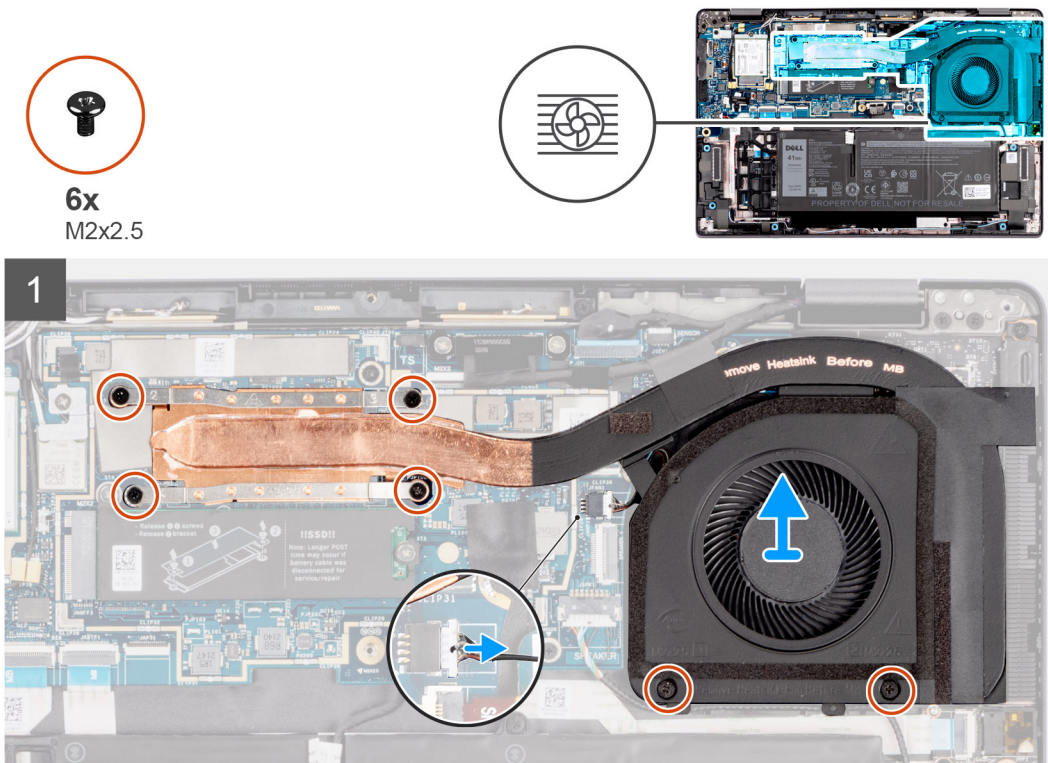

Steps

1. For Latitude 7430 2-in-1 computers, use a plastic scribe to pry the system-board shield off the system board along with the solid-state drive thermal plate, starting from the top-right side of the system-board shield.

- NOTE:** This step applies only to Latitude 7430 2-in-1 computers.

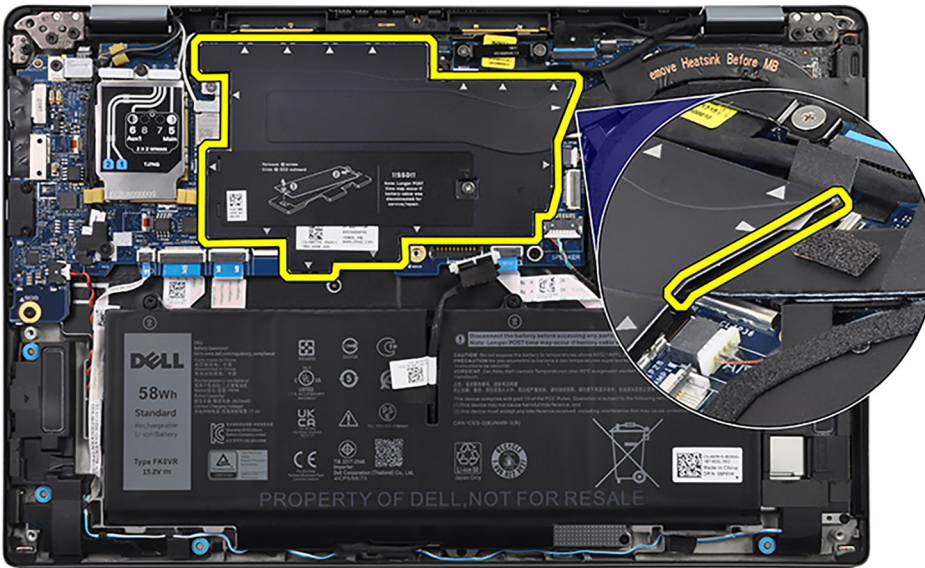

2. Disconnect the thermal-fan cable from the connector on the system board.
3. Disconnect the speaker cable from the connector on the system board.
4. Unroute the speaker cable from its routing guides, along the bottom side of the thermal fan.

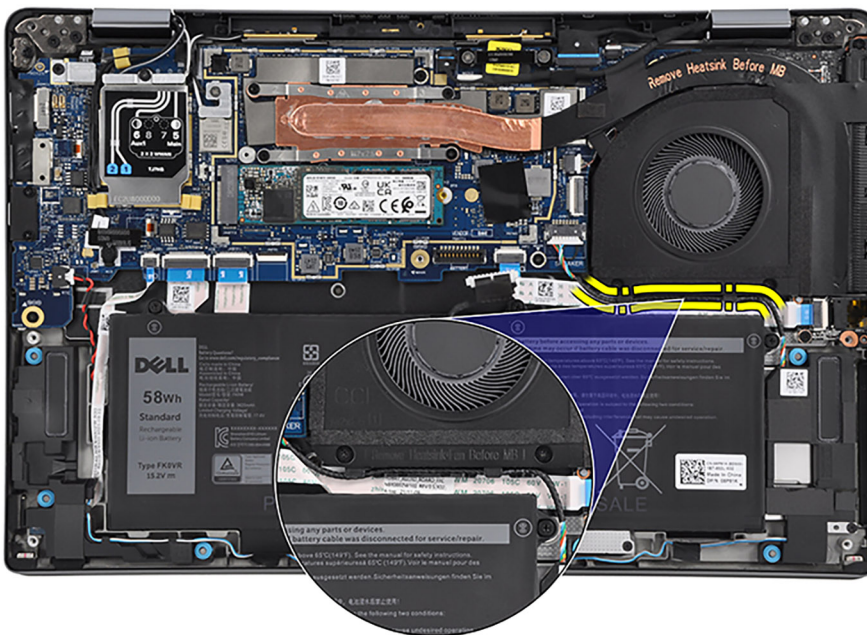

5. Remove the two screws (M2x2.5) that secure the thermal fan and four screws (M2x2.5) that secure the thermal heat-sink to the system board.
 - NOTE:** Remove the four screws (M2x2.5) in the reverse sequential order mentioned on the thermal heat-sink [4 > 3 > 2 > 1].
6. Lift and remove the heat-sink from the system board.

Installing the heat-sink

Prerequisites

If you are replacing a component, remove the existing component before performing the installation procedure.

About this task

NOTE: If either the system board or the heat-sink is replaced, use the thermal grease provided in the kit to ensure that thermal conductivity is achieved.

The following image indicates the location of the heat-sink and provides a visual representation of the installation procedure.

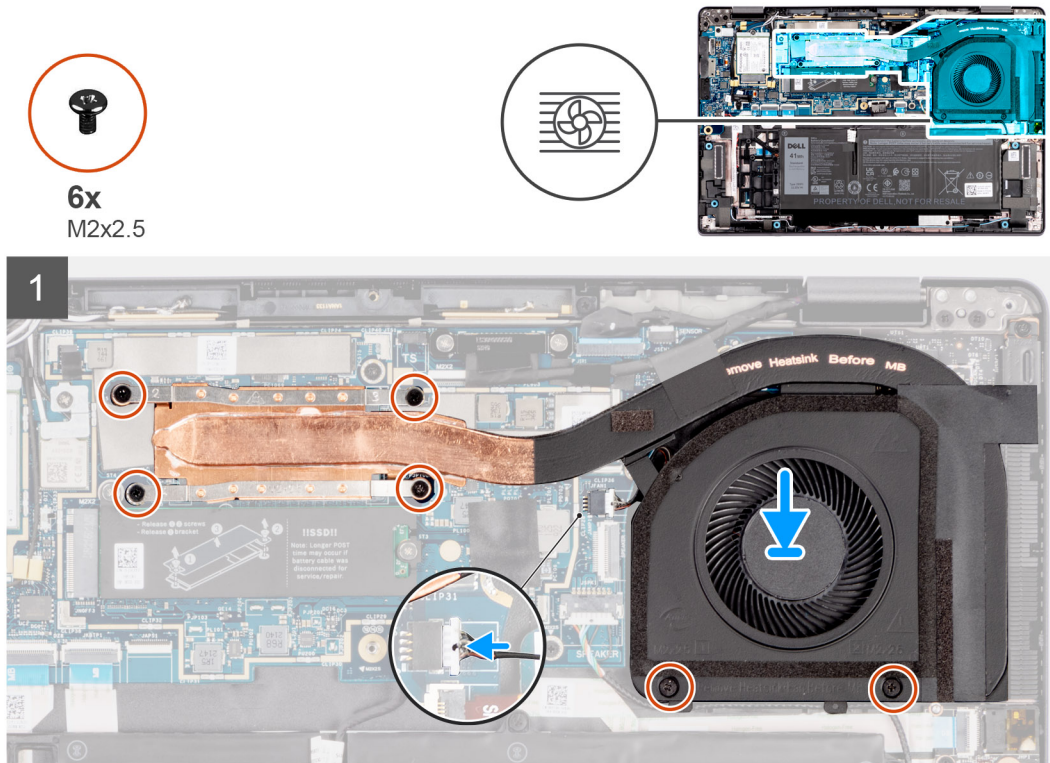

Steps

1. Place the heat-sink on the system board.
2. Align the screw holes on the heat-sink to the screw holes on the system board.
3. Replace the two screws (M2x2.5) to secure the thermal fan and four screws (M2x2.5) to secure the thermal heat-sink to the system board.

NOTE: Replace the four screws (M2x2.5) in the sequential order mentioned on the thermal heat-sink [1 > 2 > 3 > 4].

4. Route the speaker cable into its routing guides, along the bottom side of the thermal fan.

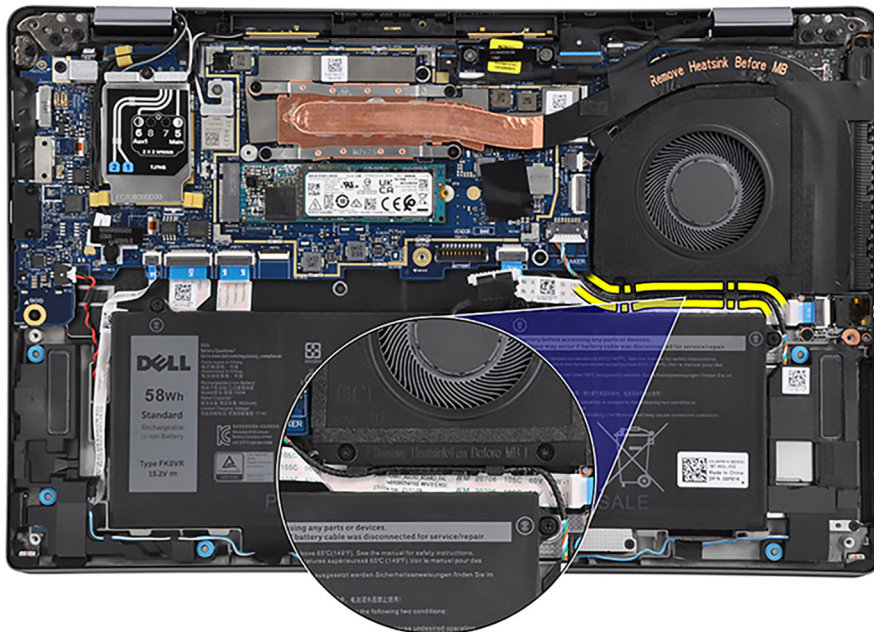

5. Connect the speaker cable to the connector on the system board.
6. Connect the thermal-fan cable to the connector on the system board.
7. Align and place the system-board shield and solid-state drive thermal plate over their slots on the system board.
8. For Latitude 7430 2-in-1 computers, start from the top-right side of the system-board shield and press the system-board shield onto the system board along with the solid-state drive thermal plate.

Next steps

1. Install the [base cover](#).
2. Follow the procedure in [After working inside your computer](#).

WLAN-antenna module

Removing the WLAN-antenna module

Prerequisites

1. Follow the procedure in [Before working inside your computer](#).
2. Remove the [base cover](#).

About this task

NOTE: This procedure applies only to computers shipped with a WLAN-antenna module installed on the palm-rest and keyboard assembly.

The following images indicate the location of the WLAN-antenna module and provide a visual representation of the removal procedure.

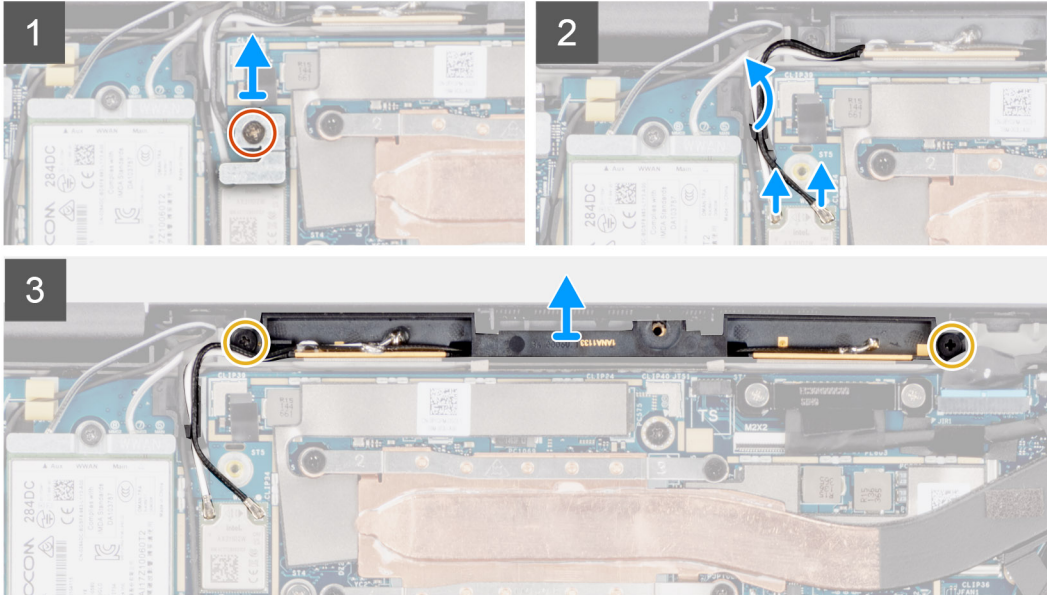
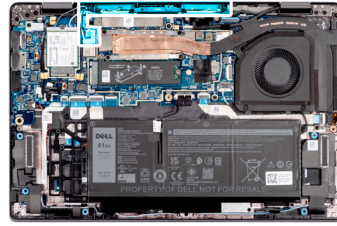

Steps

1. For computers shipped with 4G antennas, remove the screw (M2x2) that secures the WLAN-antenna module bracket to the system board.
2. For computers shipped with 5G antennas, remove the three screws (M2x2.5) that secure the WWAN shielding cover to the system board.
3. For computers shipped with 4G antennas, slide and remove the WLAN-antenna module bracket from the system board.
4. For computers shipped with 5G antennas, slide and remove the WWAN shielding cover from the system board.
5. Disconnect the WLAN-antenna cables from the connectors on the WLAN-antenna module.
6. Unroute the WLAN-antenna cables from the routing guides on the system board.
7. Remove the two screws (M2x2.5) that secure the WLAN-antenna module to the system board.
8. Slide and remove the WLAN-antenna module from the WLAN-antenna module slot on the system board.

Installing the WLAN-antenna module

Prerequisites

If you are replacing a component, remove the existing component before performing the installation procedure.

About this task

The following images indicate the location of the WLAN-antenna module and provide a visual representation of the installation procedure.

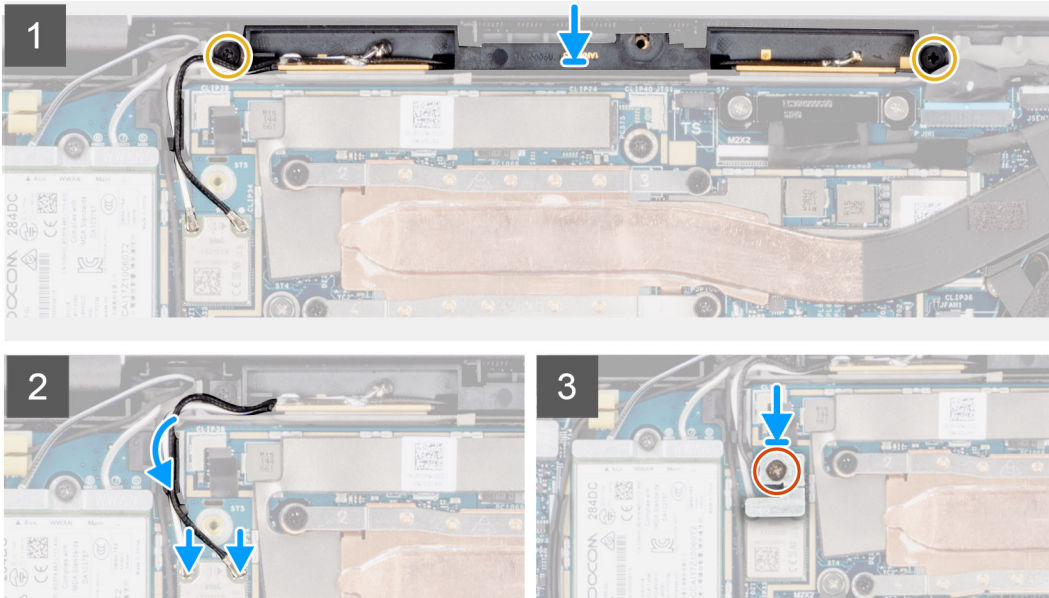
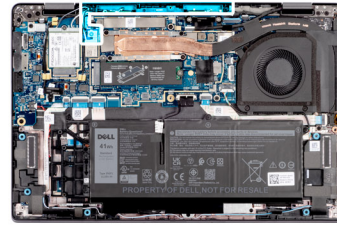

Steps

1. Slide and place the WLAN-antenna module into the WLAN-antenna module slot on the system board.
2. Replace the two screws (M2x2.5) to secure the WLAN-antenna module to the system board.
3. Route the WLAN-antenna cables into the routing guides on the system board.
4. Connect the WLAN-antenna cables to the WLAN-antenna module.

The following table provides the antenna-cable color scheme for the WLAN-antenna module supported by your system.

Table 4. WLAN-antenna cable color scheme

Connectors on the wireless card	Antenna cable color
Main (white triangle)	White
Auxiliary (black triangle)	Black

5. For computers shipped with 5G antennas, place the WWAN shielding cover in its slot on the system board.
6. For computers shipped with 4G antennas, place the WLAN-antenna module bracket in its slot on the system board.
7. For computers shipped with 5G antennas, align the screw holes on the WWAN shielding cover with the screw holes on the system board.
8. For computers shipped with 4G antennas, align the screw hole on the WLAN-antenna module bracket with the screw hole on the system board.
9. For computers shipped with 5G antennas, replace the three screws (M2x2.5) to secure the WWAN shielding cover to the system board.
10. For computers shipped with 4G antennas, replace the screw (M2x2) to secure the WLAN-antenna module bracket to the system board.

Next steps

1. Install the [base cover](#).
2. Follow the procedure in [After working inside your computer](#).

Coin-cell battery

Removing the coin-cell battery

Prerequisites

1. Follow the procedure in [Before working inside your computer](#).

CAUTION: Removing the coin-cell battery resets the BIOS setup program's settings to default. It is recommended that you note the BIOS setup program's settings before removing the coin-cell battery.

2. Remove the [base cover](#).
3. Remove the [3-cell battery](#) or the [4-cell battery](#), whichever applicable.

About this task

The following image indicates the location of the coin-cell battery and provides a visual representation of the removal procedure.

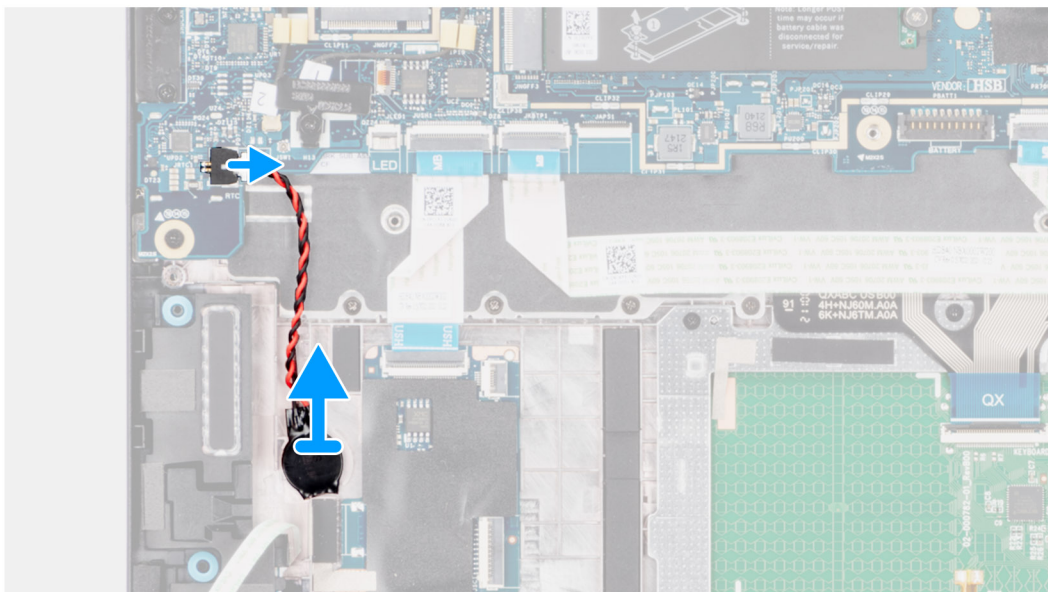
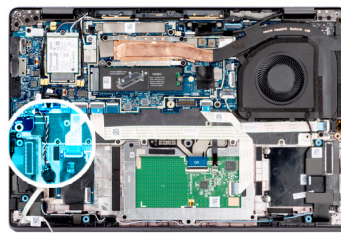

Steps

1. Disconnect the LED daughter-board flexible flat cable and coin-cell battery cable from the respective connectors on the system board.
2. Using a plastic scribe, pry the coin-cell battery off its slot on the palm-rest and keyboard assembly.

Installing the coin-cell battery

Prerequisites

If you are replacing a component, remove the existing component before performing the installation procedure.

About this task

The following image indicates the location of the coin-cell battery and provides a visual representation of the installation procedure.

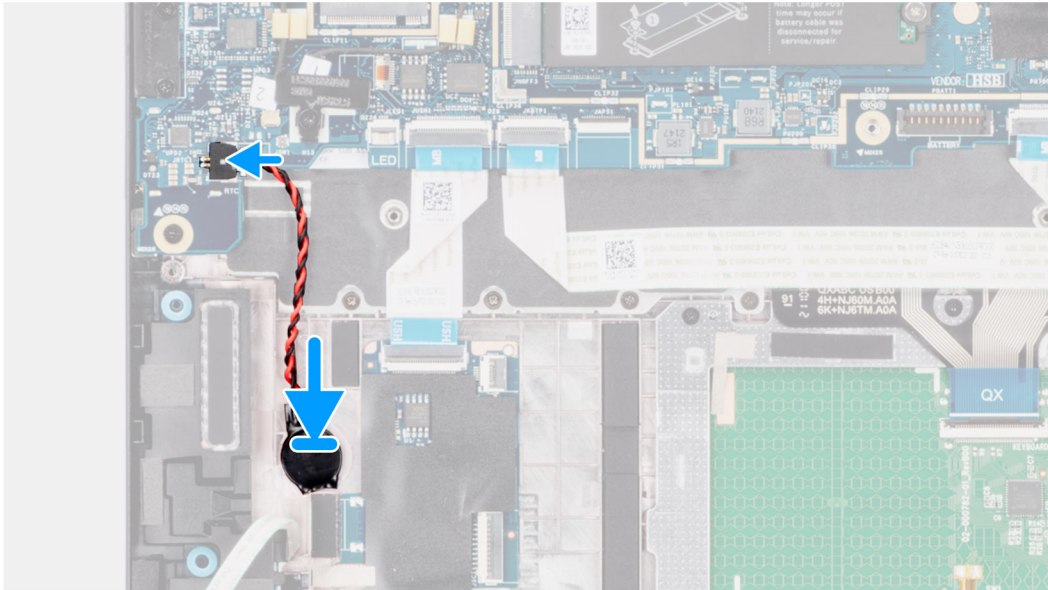
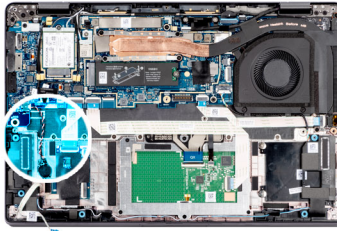

Steps

1. Place the coin-cell battery into its slot on the palm-rest and keyboard assembly.
2. Connect the coin-cell battery cable and LED daughter-board flexible flat cable to the respective connectors on the system board.

Next steps

1. Install the [3-cell battery](#) or the [4-cell battery](#), whichever applicable.
2. Install the [base cover](#).
3. Follow the procedure in [After working inside your computer](#).

Display assembly

Removing the display assembly

Prerequisites

1. Follow the procedure in [Before working inside your computer](#).
2. Remove the [base cover](#).
3. Remove the [4G WWAN card](#) or the [5G WWAN card](#), whichever applicable.

NOTE: This procedure applies only to computers shipped with a WWAN card installed.

About this task

The following images indicate the location of the display assembly and provide a visual representation of the removal procedure.

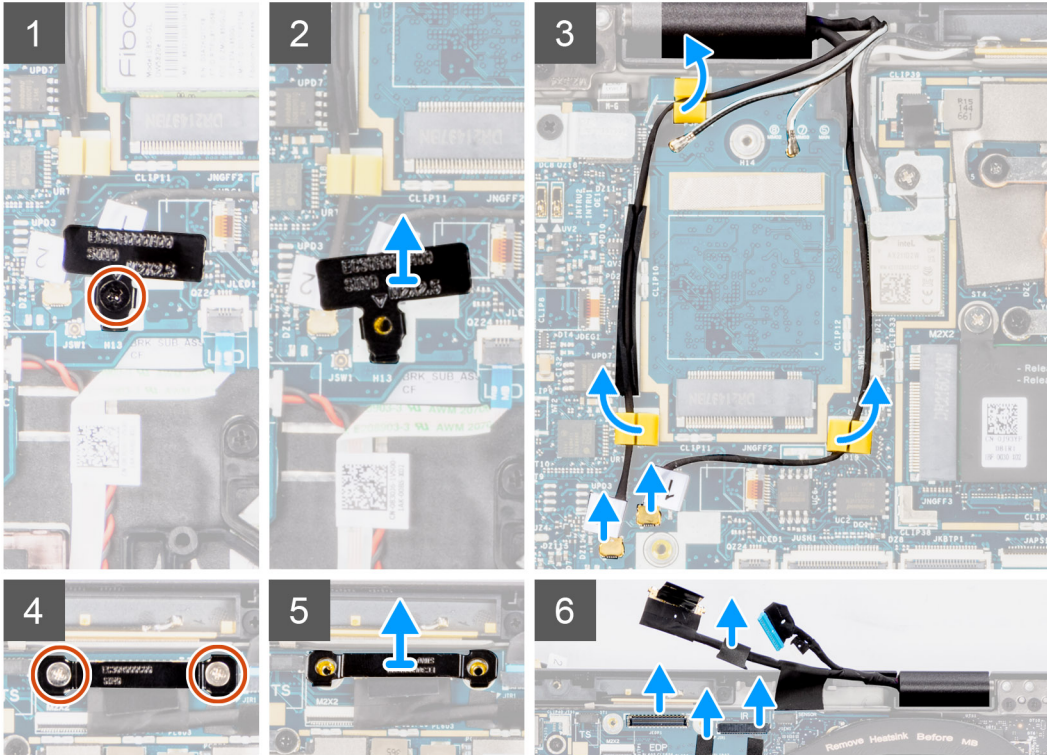
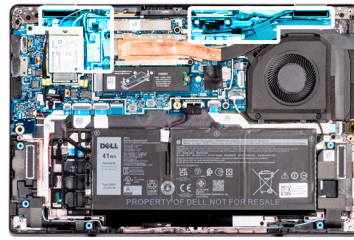

7

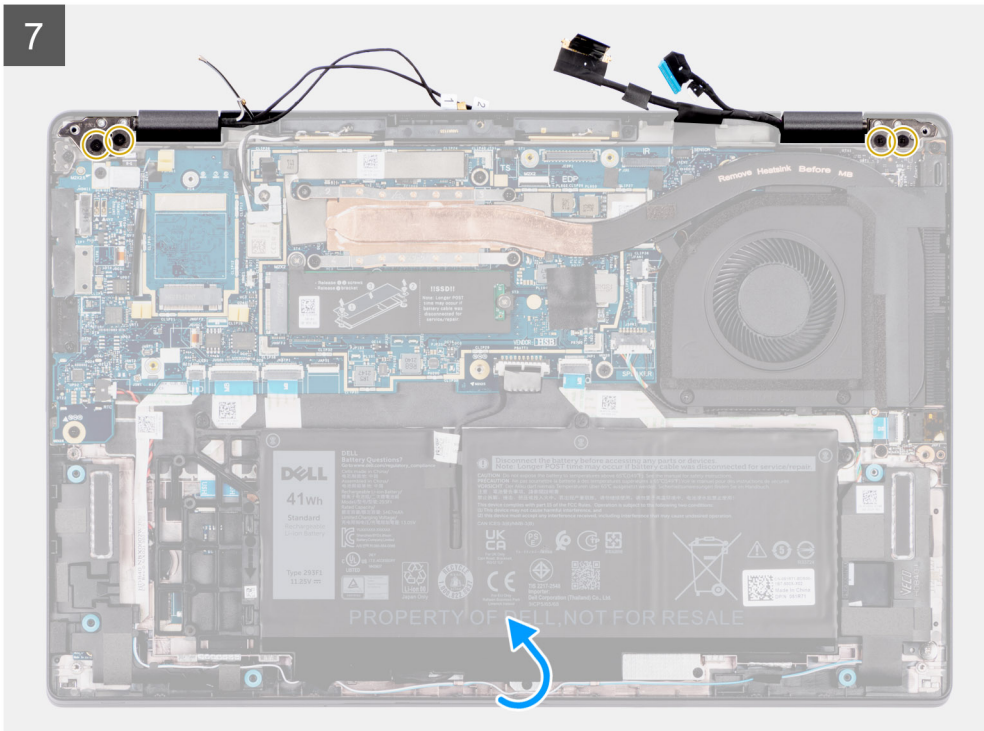

8

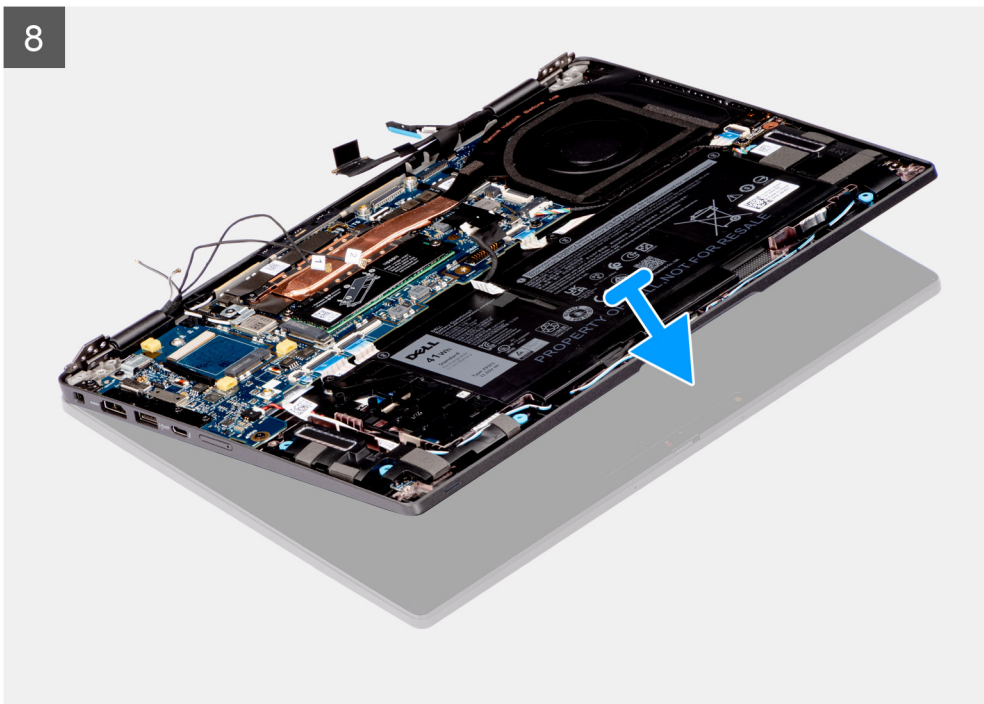

Steps

1. Remove the screw (M2x2) that secures the WLAN bracket to the system board.

NOTE: The steps from 1 to 4 apply only to computers shipped with a WLAN antenna installed in the display assembly.

2. Slide and remove the WLAN bracket from the system board.
3. Disconnect the WLAN-antenna cables from the connectors on the system board.
4. Unroute the WLAN-antenna cables from the routing guides on the system board.
5. For systems shipped with 4G antennas, remove the screw (M2x2.5) that secures the Darwin bracket to the system board.

NOTE: The steps from 5 to 8 apply only to computers shipped with a WWAN card installed.

6. For systems shipped with 4G antennas, remove the Darwin bracket from the system board.
7. Disconnect the #1 Darwin antenna cable and #2 Darwin antenna cable from the respective connectors on the system board.

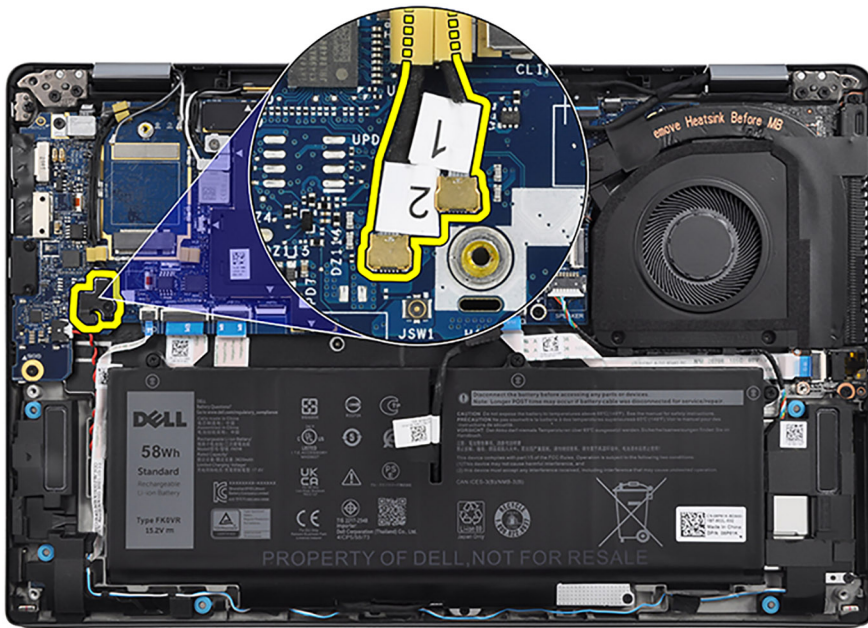

8. For systems shipped with 4G antennas, unroute the #1 Darwin antenna cable, #2 Darwin antenna cable, #6 black/gray WWAN Aux1 antenna cable and #5 white/gray WWAN Main antenna cable from the respective routing guides on the palm-rest and keyboard assembly.
9. For computers shipped with 5G antennas, unroute the #1 Darwin antenna cable, #2 Darwin antenna cable, #3 black/gray WWAN antenna cable, #2 blue WWAN antenna cable, #1 orange WWAN antenna cable and #0 white/gray WWAN antenna cable from the respective routing guides on the palm-rest and keyboard assembly.

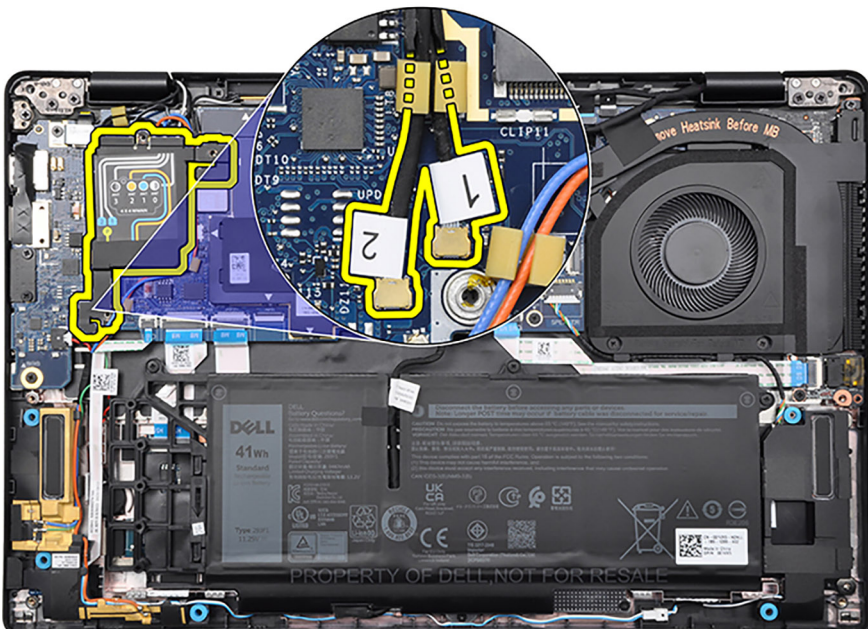

10. Remove the two screws (M2x2) that secure the display-cable bracket to the system board.
11. Remove the display-cable bracket from the system board.
12. Peel back the tape that secures the display cable to the heat sink. Also, peel back the tape that secures the display cable to the system board.

13. Disconnect the touch-screen cable (for computers shipped with a touch screen), display cable, IR-camera cable (for computers shipped with an IR camera), and sensor daughter-board cable (for computers shipped with a sensor board) from the system board.
14. For Latitude 7430 clamshell computers, open the display assembly at an angle of 90 degrees and place the computer on the edge of a flat surface such that the palm-rest and keyboard assembly lay flat on the surface and the display assembly is over the edge.
15. For Latitude 7430 2-in-1 computers, open the display assembly at an angle of 180 degrees and place the computer on a flat surface such that the display hinges face upwards.
16. Remove the four screws (M2.5x4) that secure the display hinges to the palm-rest and keyboard assembly.
17. Remove the display assembly from the computer.

NOTE: The display assembly is a Hinge-Up Design (HUD) assembly and cannot be further disassembled once it is removed from the bottom chassis. If any components in the display assembly are malfunctioning and is required to be replaced, replace the entire display assembly.



Figure 3. Display assembly with WWAN-antenna cables

Installing the display assembly

Prerequisites

If you are replacing a component, remove the existing component before performing the installation procedure.

About this task

NOTE: Ensure that the hinges are opened to the maximum before replacing the display assembly on the palm-rest and keyboard assembly.

The following images indicate the location of the display assembly and provide a visual representation of the installation procedure.



3x
M2x2

4x
M2.5x4

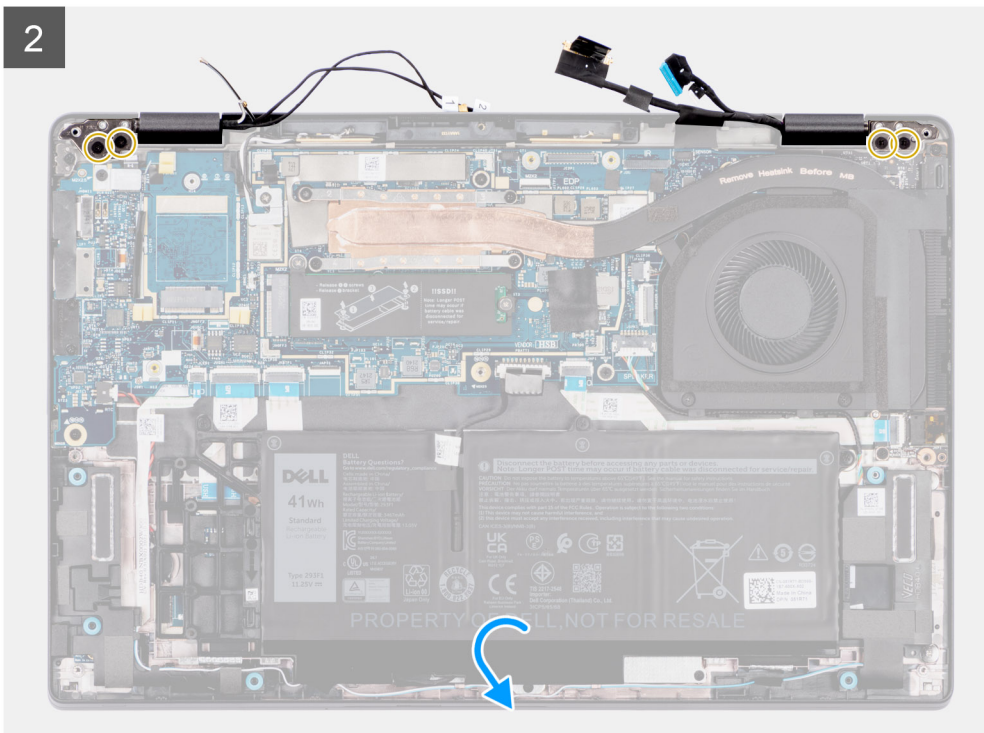
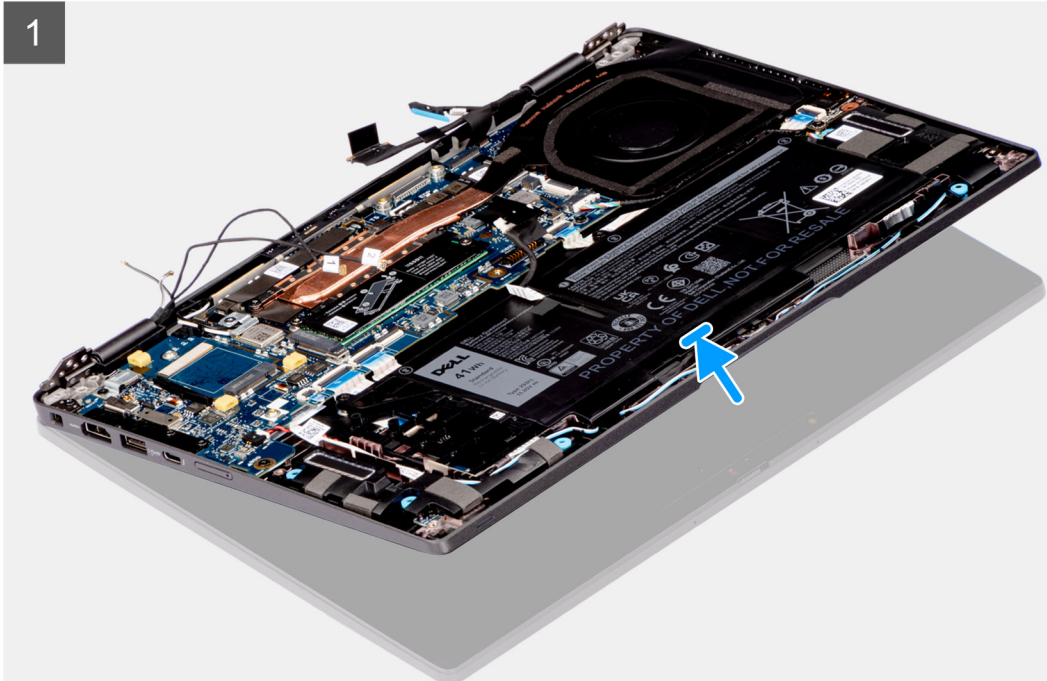
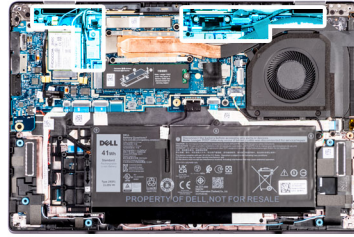

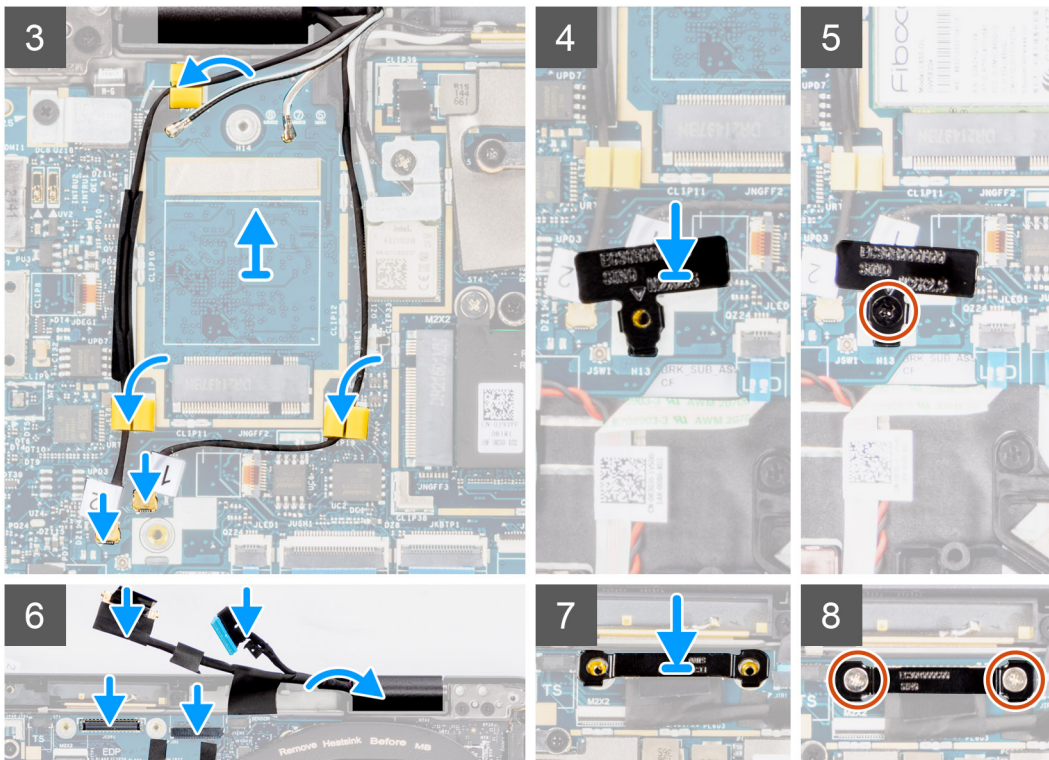

Steps

1. Place the palm-rest and keyboard assembly on a flat surface.
2. Slide the display assembly at an angle and place the display assembly on the palm-rest and keyboard assembly.
3. Gently press down on the display hinges to align the screw holes on the display hinges with the screw holes on the palm-rest and keyboard assembly.
4. Replace the four screws (M2.5x4) to secure the display hinges to the palm-rest and keyboard assembly.
5. Connect the touch-screen cable (for computers shipped with a touch screen), display cable, IR-camera cable (for computers shipped with an IR camera), and sensor daughter-board cable (for computers shipped with a sensor board) to the system board.
6. Adhere the tape to secure the display cable to the heat sink. Also, adhere the tape to secure the display cable to the system board.

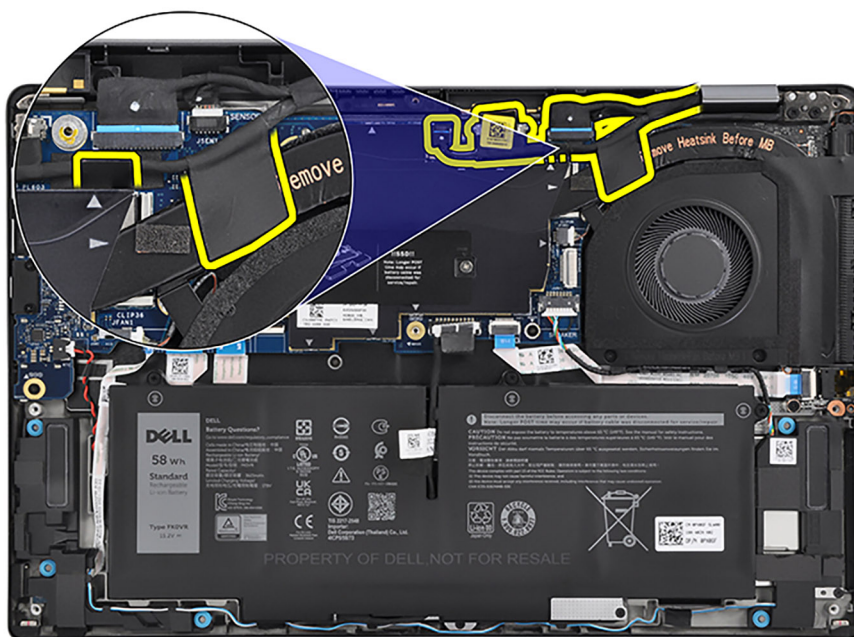

7. Align and place the display-cable bracket into its slot on the system board.
8. Replace the two screws (M2x2) to secure the display-cable bracket to the system board.
9. For computers shipped with 5G antennas, route the #1 Darwin antenna cable, #2 Darwin antenna cable, #3 black/gray WWAN antenna cable, #2 blue WWAN antenna cable, #1 orange WWAN antenna cable and #0 white/gray WWAN antenna cable through the respective routing guides on the palm-rest and keyboard assembly.

NOTE: When routing the WWAN-antenna cables, secure the Darwin cables and black/gray WWAN-antenna cable or blue and orange WWAN-antenna cables (for 5G WWAN configuration) in place with the sponges.



10. For computers shipped with 4G antennas, route the #1 Darwin antenna cable, #2 Darwin antenna cable, #6 black/gray WWAN Aux1 antenna cable and #5 white/gray WWAN Main antenna cable through the respective routing guides on the palm-rest and keyboard assembly.

NOTE: The steps from 11 to 14 apply only to computers shipped with a WWAN card installed.

NOTE: When routing the WWAN-antenna cables, secure the Darwin cables and black/gray WWAN-antenna cable (for 4G WWAN configuration) in place with the sponges.

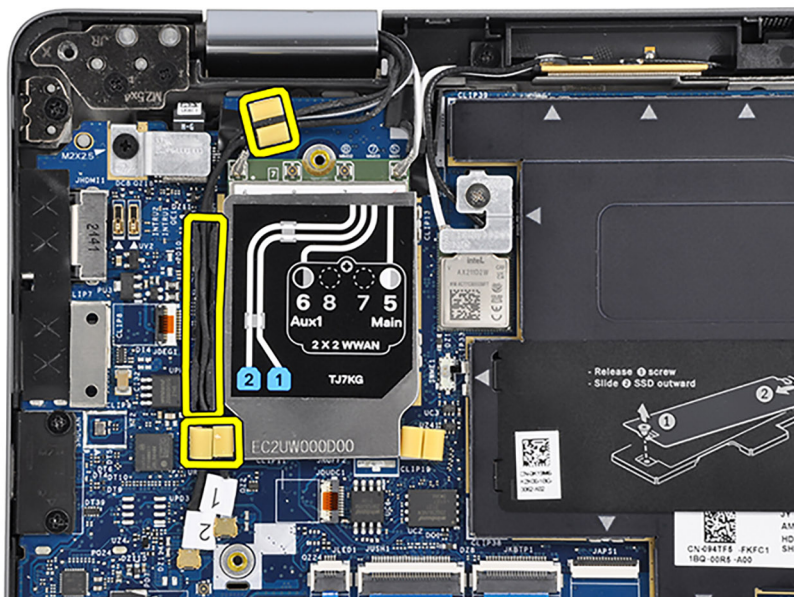

11. Connect the #1 Darwin antenna cable and #2 Darwin antenna cable to the respective connectors on the system board.

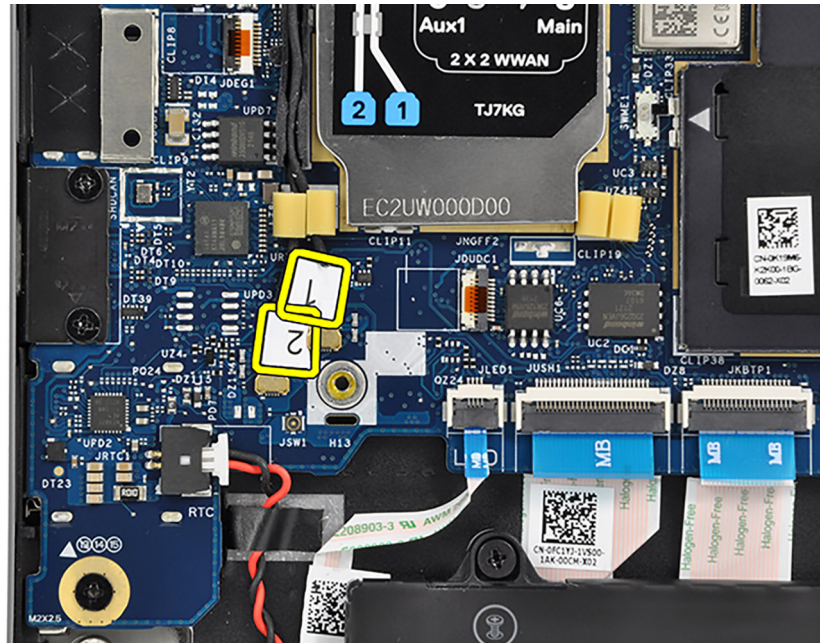

Figure 4. 4G WWAN configuration

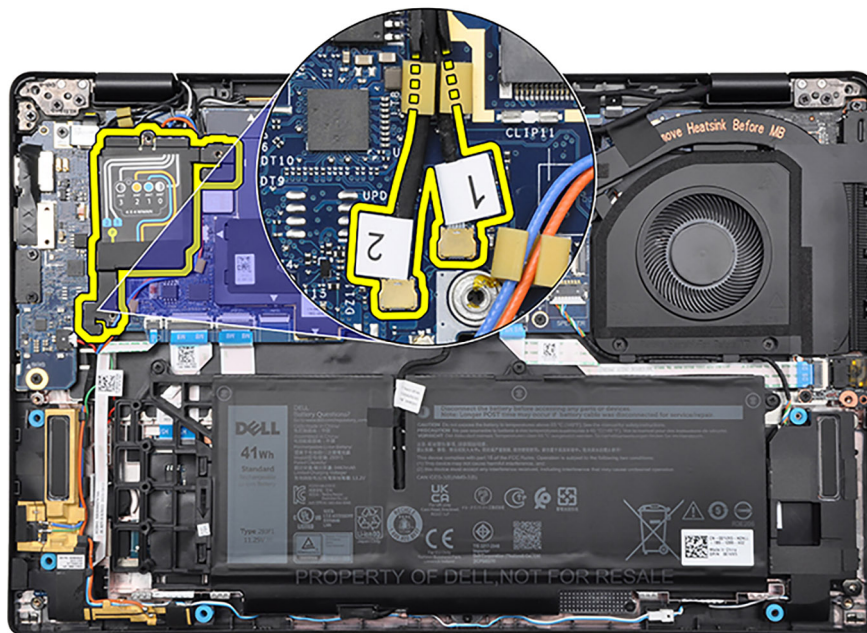

Figure 5. 5G WWAN configuration

- 12. For computers shipped with 4G antennas, align and place the Darwin bracket into its slot on the system board.
- 13. For computers shipped with 4G antennas, replace the screw (M2x2.5) to secure the Darwin bracket to the system board.
- 14. Route the WLAN-antenna cables through the routing guides on the system board.

NOTE: The steps from 15 to 18 apply only to computers shipped with a WLAN antenna installed in the display assembly.

- 15. Connect the WLAN-antenna cables to the connectors on the system board.
- 16. Align and place the WLAN bracket into its slot on the system board.
- 17. Replace the screw (M2x2) to secure the WLAN bracket to the system board.

Next steps

1. Install the [4G WWAN card](#) or the [5G WWAN card](#), whichever applicable.
i **NOTE:** This procedure applies only to computers shipped with a WWAN card installed.
2. Install the [base cover](#).
3. Follow the procedure in [After working inside your computer](#).

Audio daughter-board

Removing the audio daughter-board

Prerequisites

1. Follow the procedure in [Before working inside your computer](#).
2. Remove the [base cover](#).
3. Remove the [3-cell battery](#) or the [4-cell battery](#), whichever applicable.

About this task

The following image indicates the location of the audio daughter-board and provides a visual representation of the removal procedure.

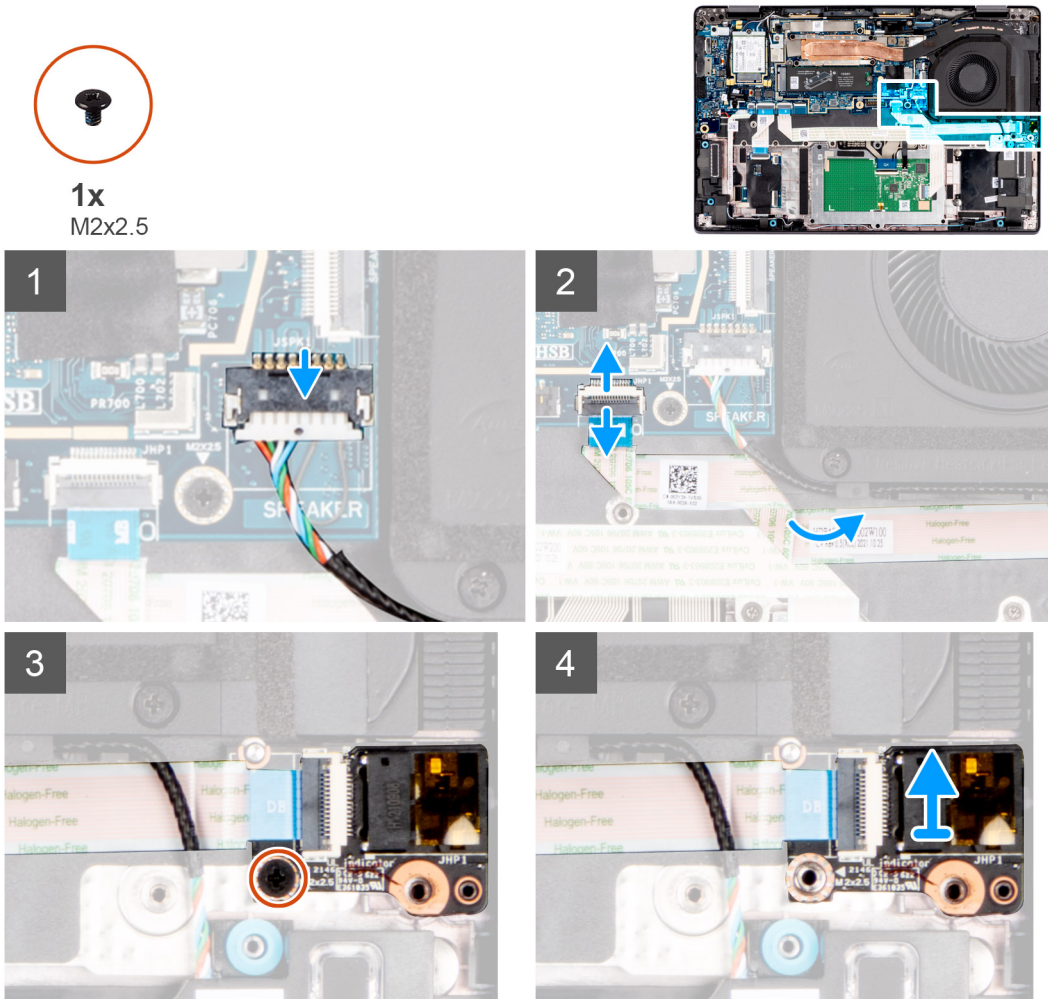

Steps

1. Disconnect the speaker cable and the audio daughter-board flexible flat cable from the respective connectors on the system board.
2. Peel back the audio daughter-board flexible flat cable from the palm-rest and keyboard assembly.
3. Remove the screw (M2x2.5) that secures the audio daughter-board to the system board.
4. Remove the audio daughter-board along with the audio daughter-board flexible flat cable from the system.
5. Disconnect and remove the audio daughter-board flexible flat cable from the connector on the audio daughter-board.

Installing the audio daughter-board

Prerequisites

If you are replacing a component, remove the existing component before performing the installation procedure.

About this task

The following image indicates the location of the audio daughter-board and provides a visual representation of the installation procedure.

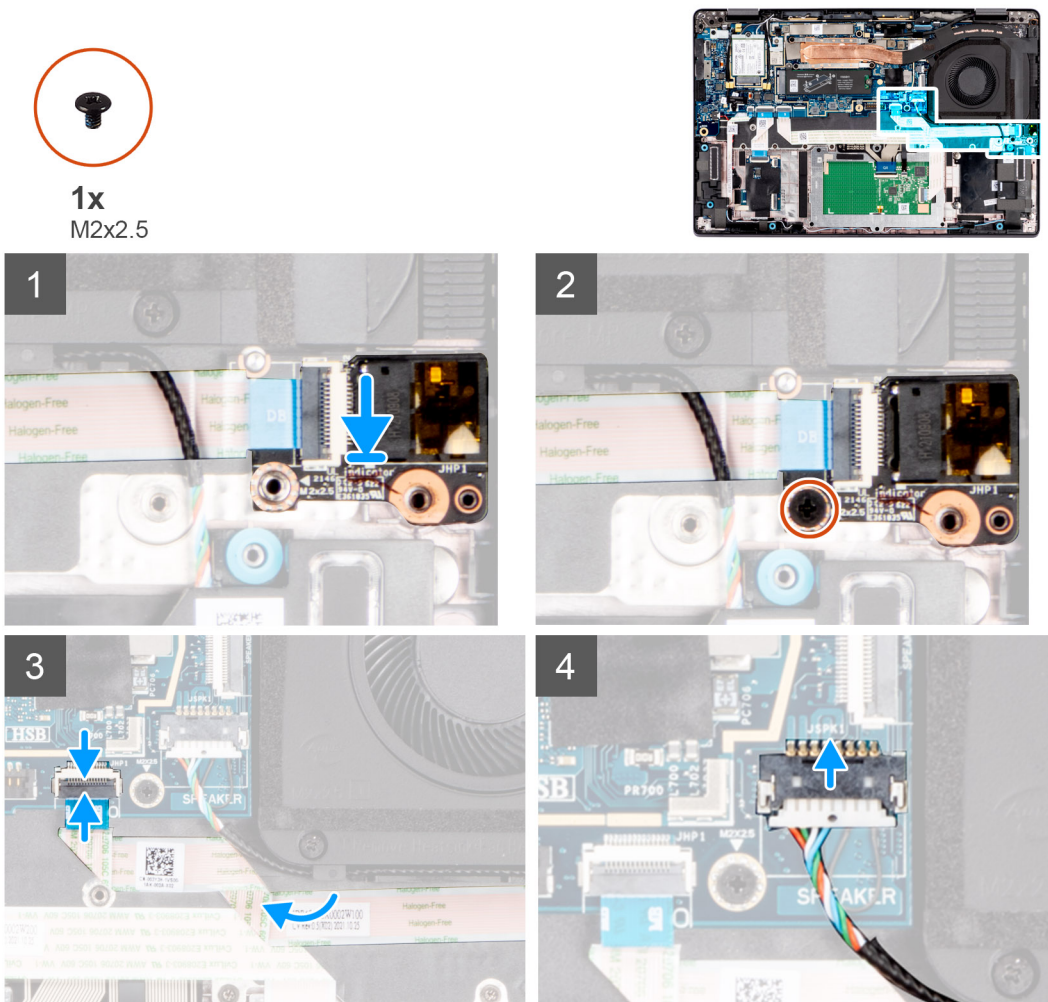

Steps

1. Connect the audio daughter-board flexible flat cable to the connector on the audio daughter-board.
2. Place the audio daughter-board along with the audio daughter-board flexible flat cable into its slot on the system.
3. Replace the screw (M2x2.5) to secure the audio daughter-board to the system board.
4. Adhere the audio daughter-board flexible flat cable on the palm-rest and keyboard assembly.

5. Connect the audio daughter-board flexible flat cable and the speaker cable to the respective connectors on the system board.

Next steps

1. Install the [3-cell battery](#) or the [4-cell battery](#), whichever applicable.
2. Install the [base cover](#).
3. Follow the procedure in [After working inside your computer](#).

Speakers

Removing the speakers

Prerequisites

1. Follow the procedure in [Before working inside your computer](#).
2. Remove the [base cover](#).
3. Remove the [3-cell battery](#) or the [4-cell battery](#), whichever applicable.

About this task

The following image indicates the location of the speakers and provides a visual representation of the removal procedure.

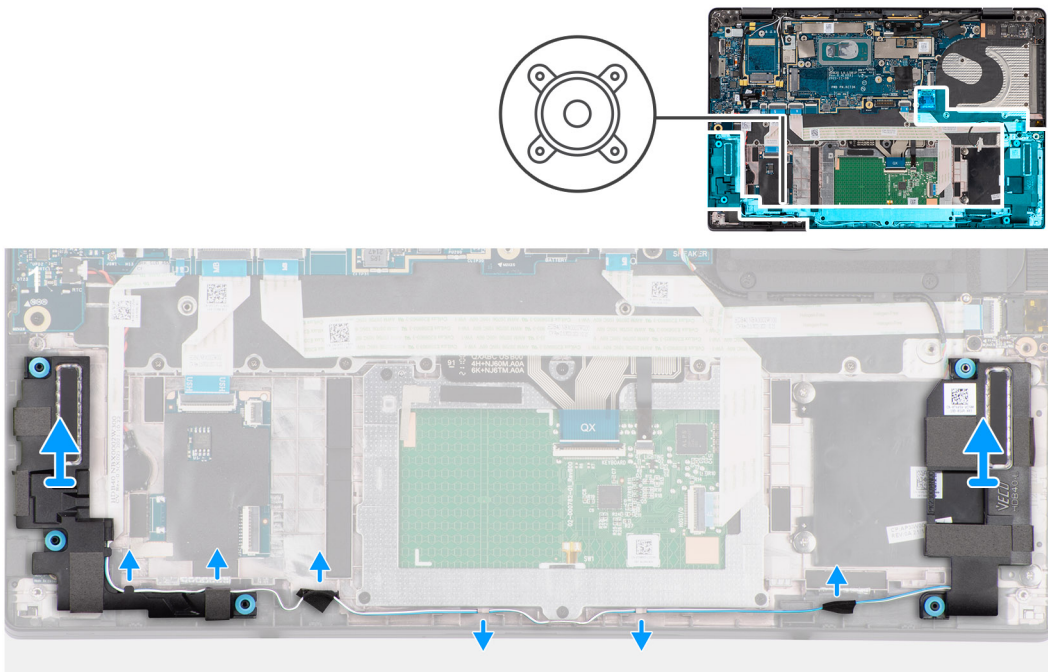

Steps

1. For systems shipped with 5G antennas, remove the three screws (M2x2.5) that secure the WWAN shielding cover to the system board.
2. For systems shipped with 5G antennas, slide and remove the WWAN shielding cover from the system board.
3. For systems shipped with 4G antennas, disconnect the speaker cable from the connector on the system board.
4. For systems shipped with 5G antennas, disconnect the P-sensor cable and the speaker cable from the respective connectors on the system board.

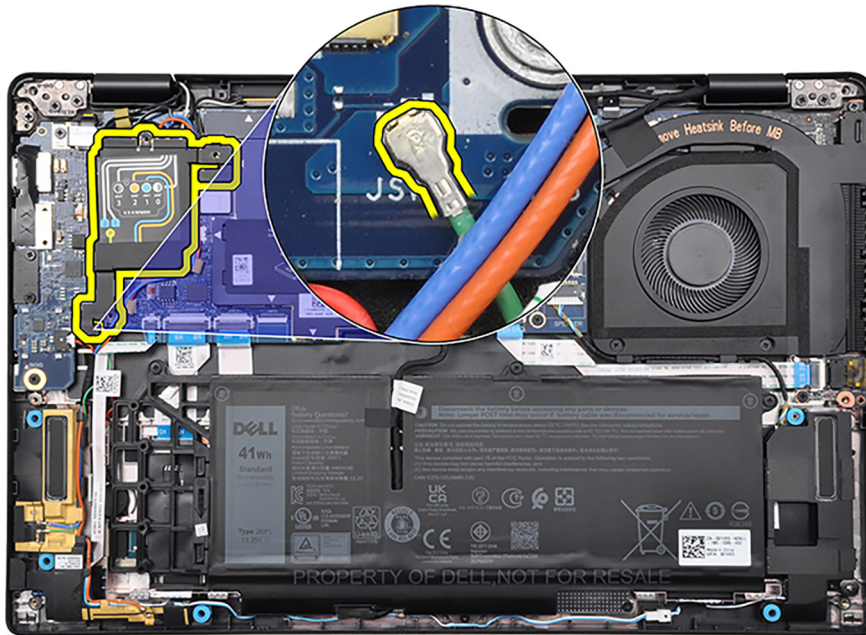

5. Peel back the tape that secures the speaker cable to the palm-rest and touchpad.
6. Unroute and remove the speaker cable from the routing guides along the bottom side of the thermal fan and on the palm-rest and keyboard assembly.
7. Using a plastic scribe, pry the speakers along with the cable off the palm-rest and keyboard assembly.

Installing the speakers

Prerequisites

If you are replacing a component, remove the existing component before performing the installation procedure.

About this task

i **NOTE:** If the rubber grommets are pushed out when removing the speakers, push them back in before replacing the speakers.

The following image indicates the location of the speakers and provides a visual representation of the installation procedure.

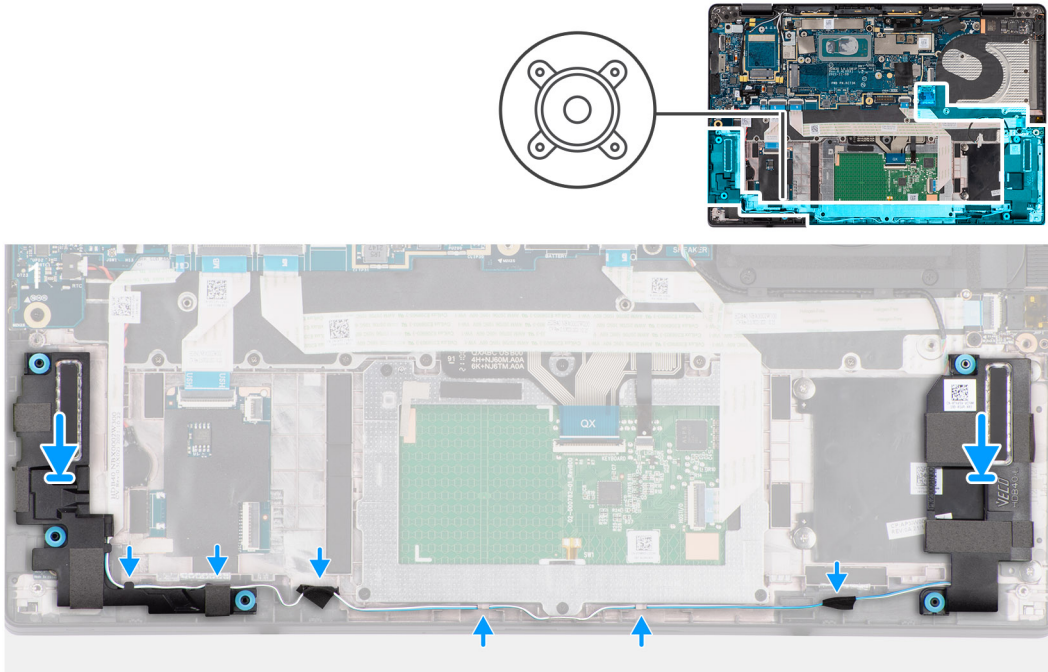

Steps

1. Using the alignment posts and rubber grommets, place the speakers into the slots on the palm-rest and keyboard assembly.
 - NOTE:** Ensure that the alignment posts are threaded through the rubber grommets on the speakers.
2. Route the speaker cable along the bottom side of the palm-rest and keyboard assembly and the thermal fan. Then secure the speaker cable into the routing guides on the palm-rest and keyboard assembly.
 - NOTE:** The speaker cable must be routed through the routing guides to avoid damaging the speaker cable when installing the base cover.
3. Adhere the tape to secure the speaker cable to the palm-rest and touchpad.

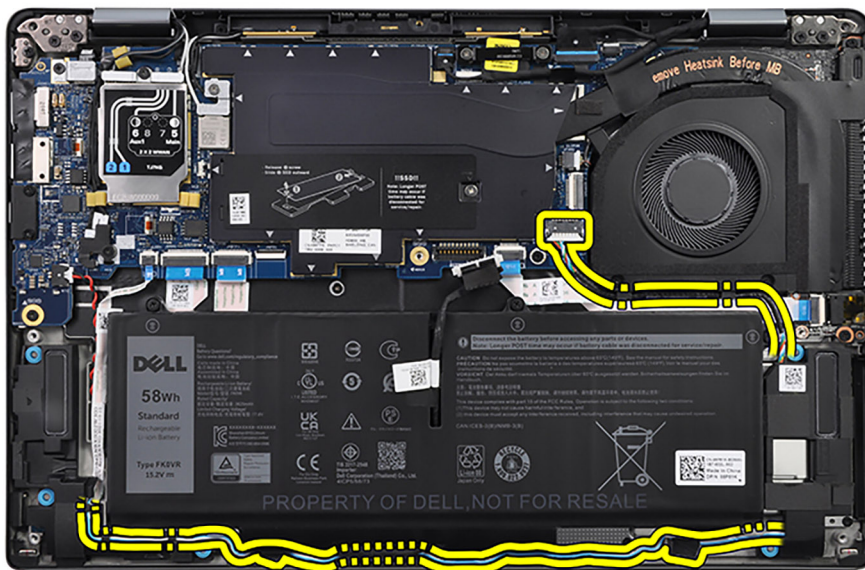

4. For systems shipped with 5G antennas, connect the P-sensor cable and the speaker cable to the respective connectors on the system board.

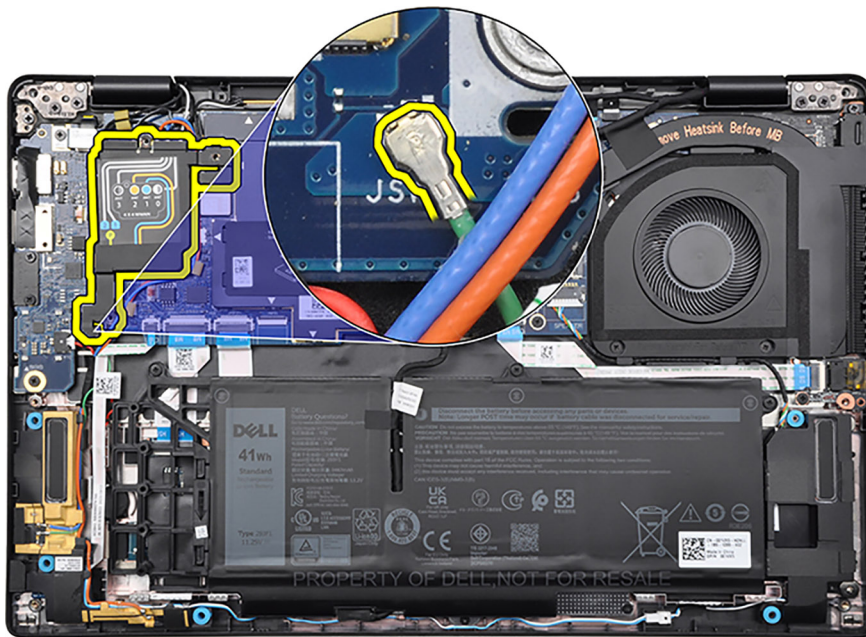

5. For systems shipped with 4G antennas, connect the speaker cable to the connector on the system board.
6. For systems shipped with 5G antennas, place the WWAN shielding cover in its slot on the system board.
7. For systems shipped with 5G antennas, align the screw holes on the WWAN shielding cover with the screw holes on the system board.
8. For systems shipped with 5G antennas, replace the three screws (M2x2.5) to secure the WWAN shielding cover to the system board.

Next steps

1. Install the [3-cell battery](#) or the [4-cell battery](#), whichever applicable.
2. Install the [base cover](#).
3. Follow the procedure in [After working inside your computer](#).

Smart card reader

Removing the smart card reader

Prerequisites

1. Follow the procedure in [Before working inside your computer](#).
2. Remove the [base cover](#).
3. Remove the [3-cell battery](#) or the [4-cell battery](#), whichever applicable.

About this task

NOTE: This procedure applies only to computers shipped with a smart card reader installed.

The following images indicate the location of the smart card reader and provide a visual representation of the removal procedure.



4x
M2x2.5

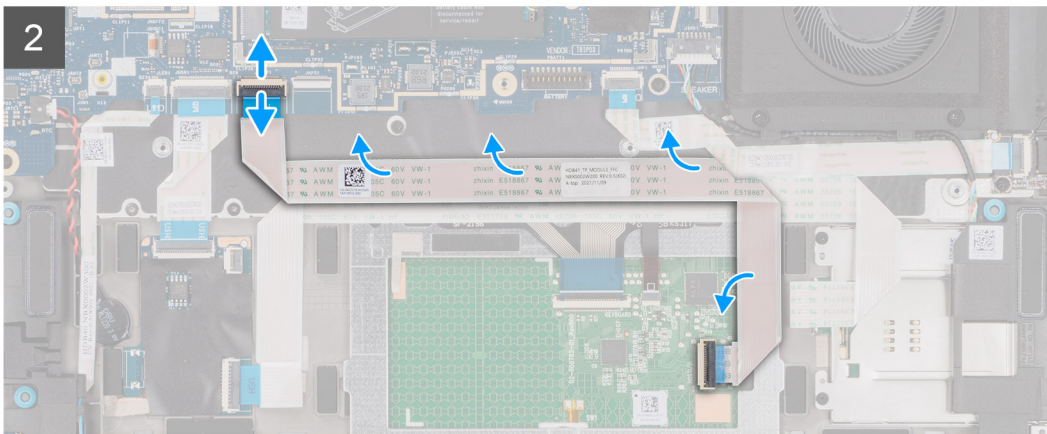
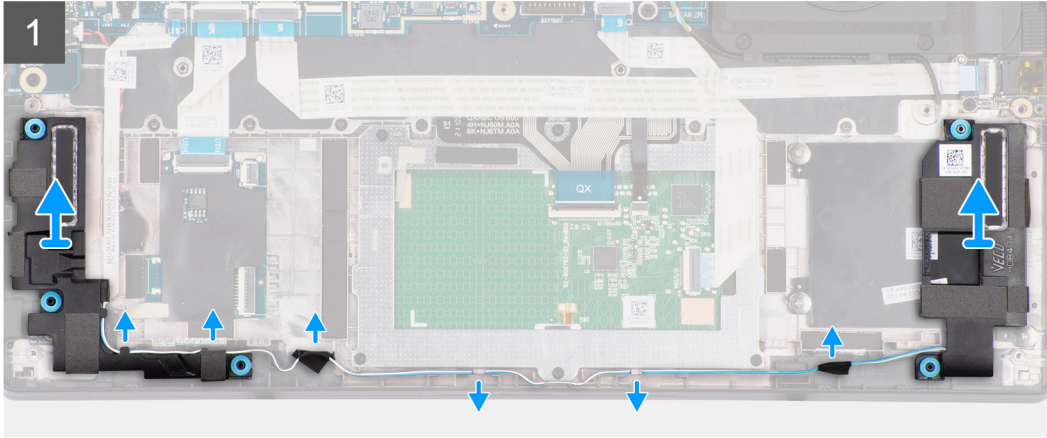
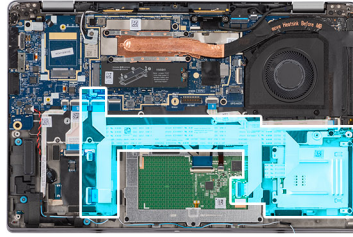

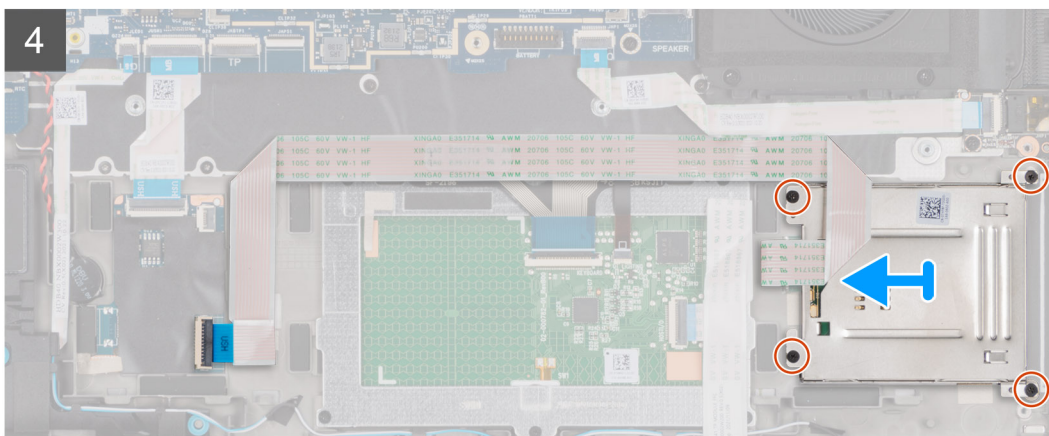
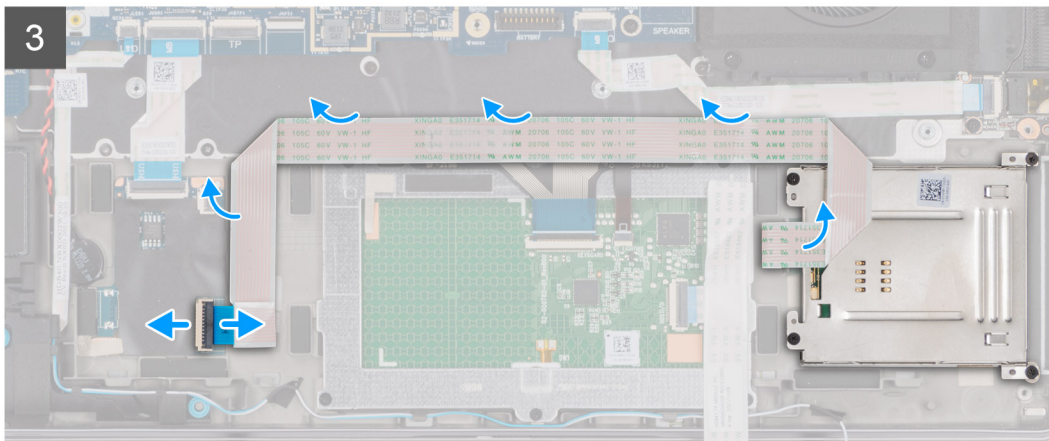

Steps

1. Disconnect the speaker cable from the connector on the system board.
2. Unroute and remove the speaker cable from the routing guides along the bottom side of the thermal fan.
3. Using a plastic scribe, pry the left speaker along with the cable off the palm-rest and keyboard assembly.
4. Disconnect the touchpad flexible flat cable from the connector on the system board.
5. Disconnect the NFC flexible printed circuits (for computers shipped with an NFC module) and smart card reader flexible flat cable from the respective connectors on the USH daughter-board.
6. Peel back the touchpad flexible flat cable from over the smart card reader flexible flat cable.
7. Peel back the NFC flexible printed circuits from over the smart card reader flexible flat cable.
 - NOTE:** This step applies only to computers shipped with an NFC module installed.
8. Peel back the smart card reader flexible flat cable from the palm-rest and keyboard assembly.
9. Remove the four screws (M2x2.5) that secure the smart card reader to the palm-rest and keyboard assembly.
10. Remove the smart card reader along with the smart card reader flexible flat cable from the computer.

Installing the smart card reader

Prerequisites

If you are replacing a component, remove the existing component before performing the installation procedure.

About this task

NOTE: If the rubber grommets are pushed out when removing the left speaker, push them back in before replacing the left speaker.

The following images indicate the location of the smart card reader and provide a visual representation of the installation procedure.



4x
M2x2.5

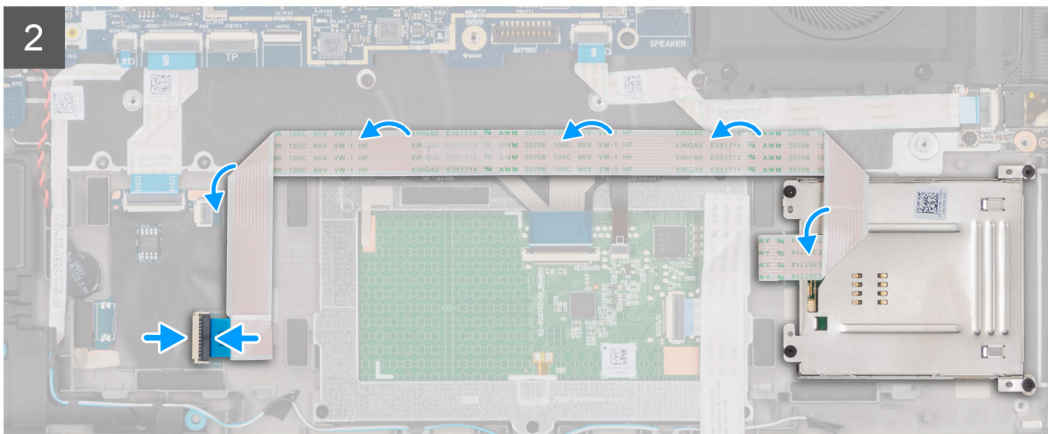
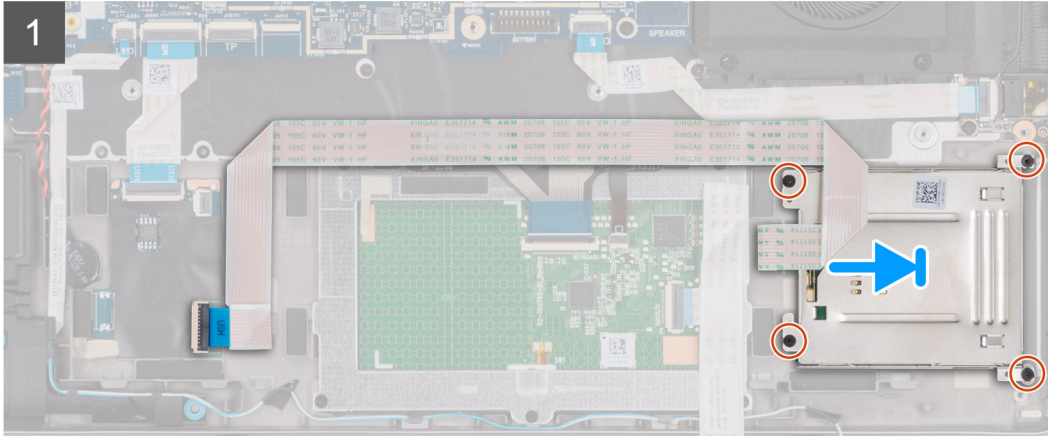
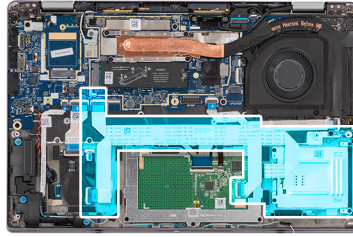

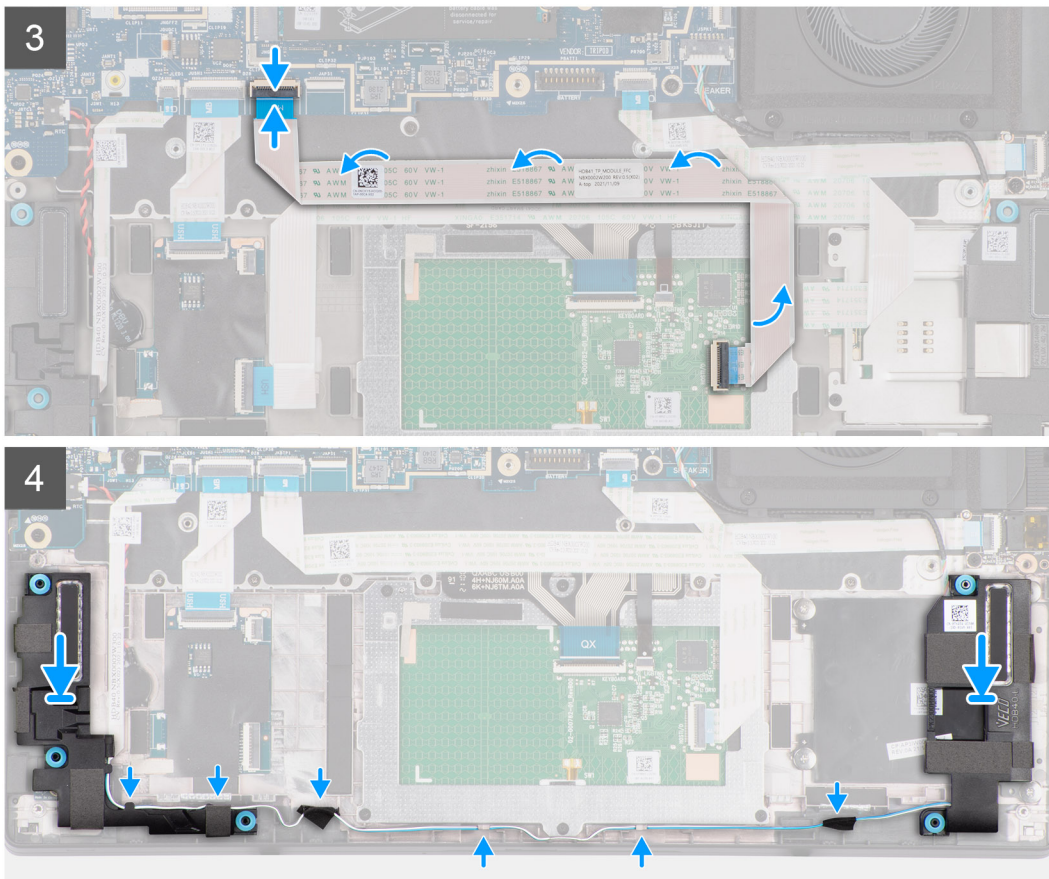

Steps

1. Place the smart card reader along with the smart card reader flexible flat cable into its slot on the computer.
2. Replace the four screws (M2x2.5) to secure the smart card reader to the palm-rest and keyboard assembly.
3. Adhere the smart card reader flexible flat cable to the palm-rest and keyboard assembly.
4. Adhere the NFC flexible printed circuits to the smart card reader flexible flat cable.
 - NOTE:** This step applies only to computers shipped with an NFC module installed.
5. Adhere the touchpad flexible flat cable to the smart card reader flexible flat cable.
6. Connect the to the connector on the USH daughter-board.
7. Connect the NFC flexible printed circuits (for computers shipped with an NFC module) and smart card reader flexible flat cable to the respective connectors on the USH daughter-board.
8. Connect the touchpad flexible flat cable to the connector on the system board.
9. Using the alignment posts and rubber grommets, place the left speaker into the slot on the palm-rest and keyboard assembly.
 - NOTE:** Ensure that the alignment posts are threaded through the rubber grommets on the left speaker.
10. Route the speaker cable along the bottom side of the thermal fan. Then secure the speaker cable into the routing guides on the palm-rest and keyboard assembly.
 - NOTE:** The speaker cable must be routed through the routing guides to avoid damaging the speaker cable when installing the base cover.
11. Connect the speaker cable to the connector on the system board.

Next steps

1. Install the [3-cell battery](#) or the [4-cell battery](#), whichever applicable.
2. Install the [base cover](#).

3. Follow the procedure in [After working inside your computer](#).

System board

Removing the system board

Prerequisites

1. Follow the procedure in [Before working inside your computer](#).
2. Remove the [microSIM-card tray](#).
3. Remove the [base cover](#).
4. Remove the [M.2 2230 solid-state drive](#) or the [M.2 2280 solid-state drive](#), whichever applicable.
5. Remove the [4G WWAN card](#) or the [5G WWAN card](#), whichever applicable.

NOTE: This procedure applies only to computers shipped with a WWAN card installed.

6. Remove the [3-cell battery](#) or the [4-cell battery](#), whichever applicable.
7. Remove the [heat-sink](#).

About this task

The following image indicates the connectors on your system board.

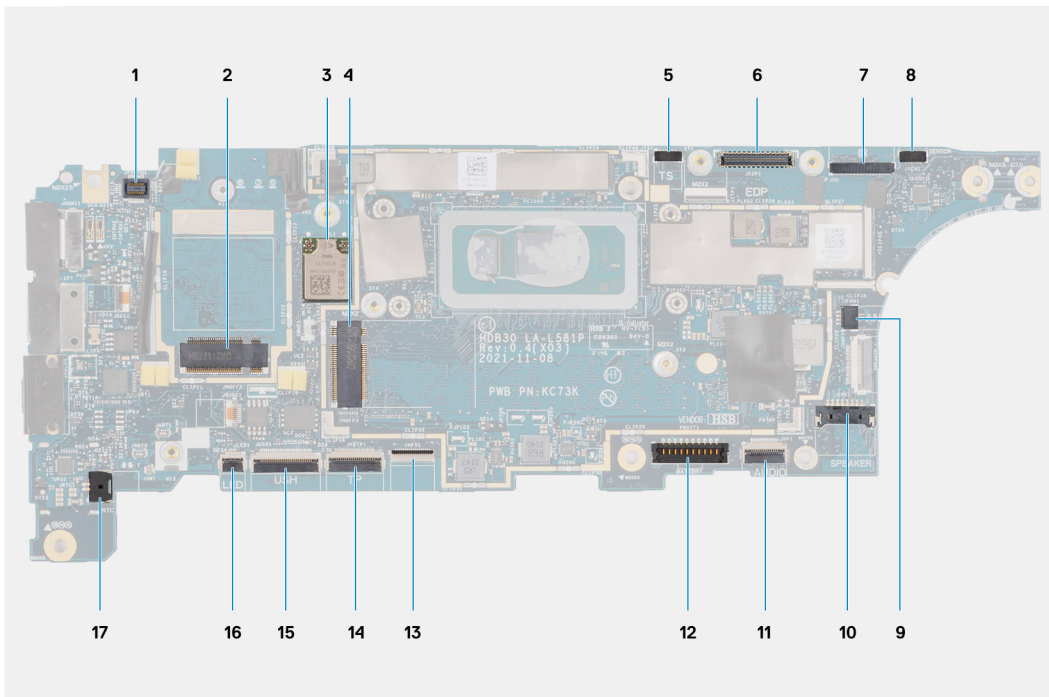

1. Fingerprint reader FPC connector
2. WWAN-card connector
3. WLAN-card connector
4. M.2 solid-state drive connector
5. Touch-screen cable connector
6. eDP cable connector
7. IR-camera cable connector
8. Sensor daughter-board cable connector
9. Thermal-fan cable connector
10. Speaker cable connector
11. Audio daughter-board FFC connector
12. Battery cable connector
13. Keyboard FFC connector

- 14. Touchpad FFC connector
- 15. UHS daughter-board FFC connector
- 16. LED daughter-board FFC connector
- 17. Coin-cell battery cable connector

NOTE: For computers shipped without a WWAN card, a 4G/5G WWAN shielding cover and WWAN bracket (for 4G WWAN card) is pre-installed to the computer. As a result, follow the steps in the WWAN card removal/installation section to remove the WWAN shielding cover and WWAN bracket before removing the system board.

CAUTION: Remove the heat-sink before removing the system board as there are two screws (M2x3) underneath the heat-sink that secure the system board to the computer.

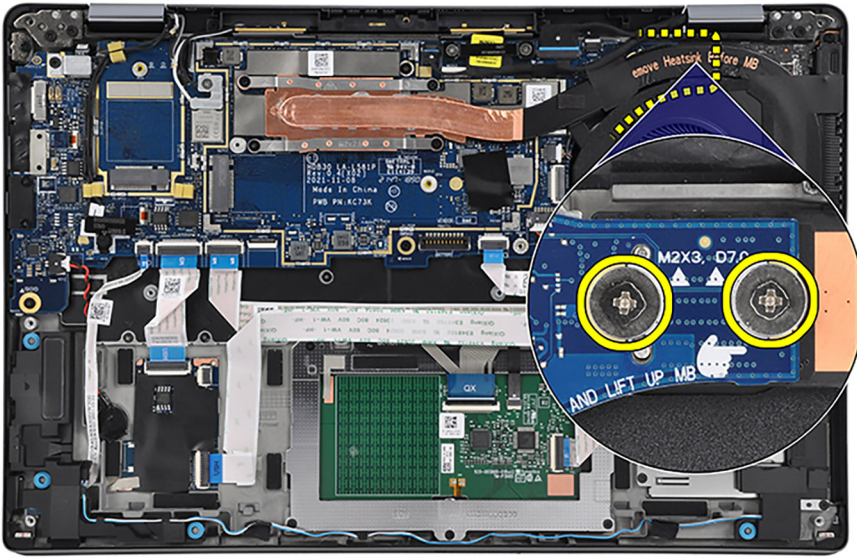

The following images indicate the location of the system board and provide a visual representation of the removal procedure.

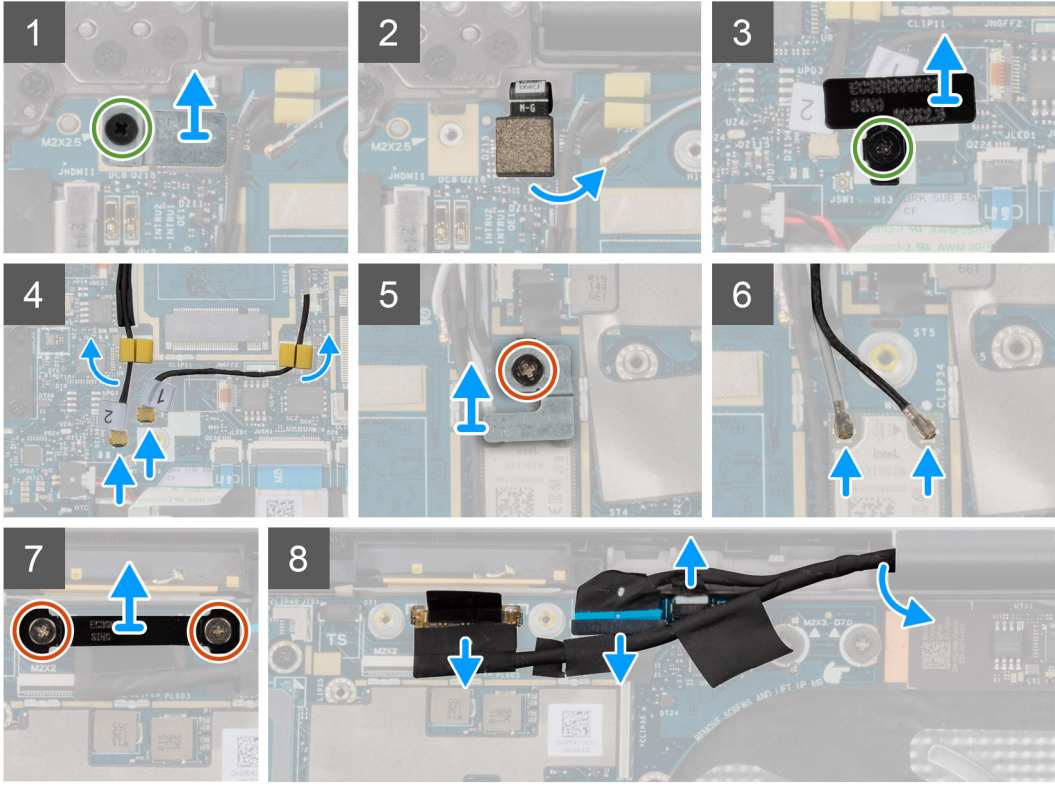
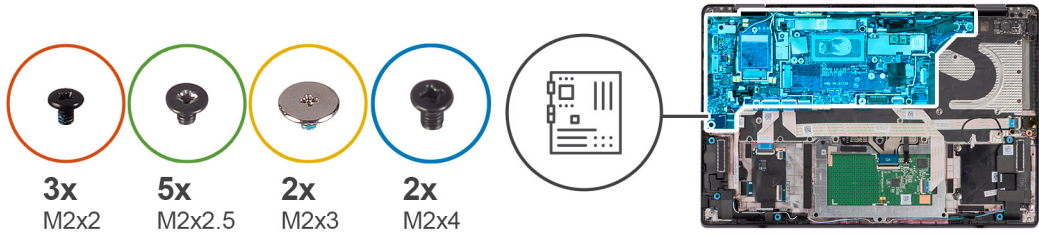

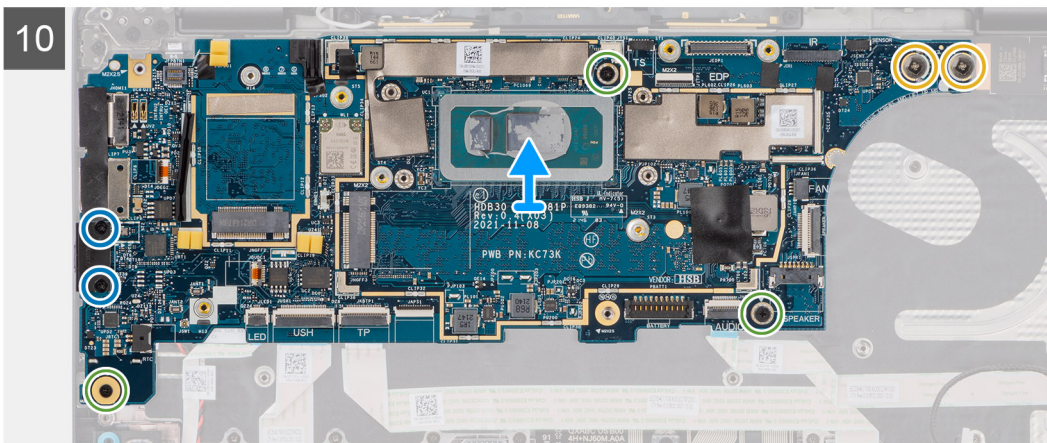
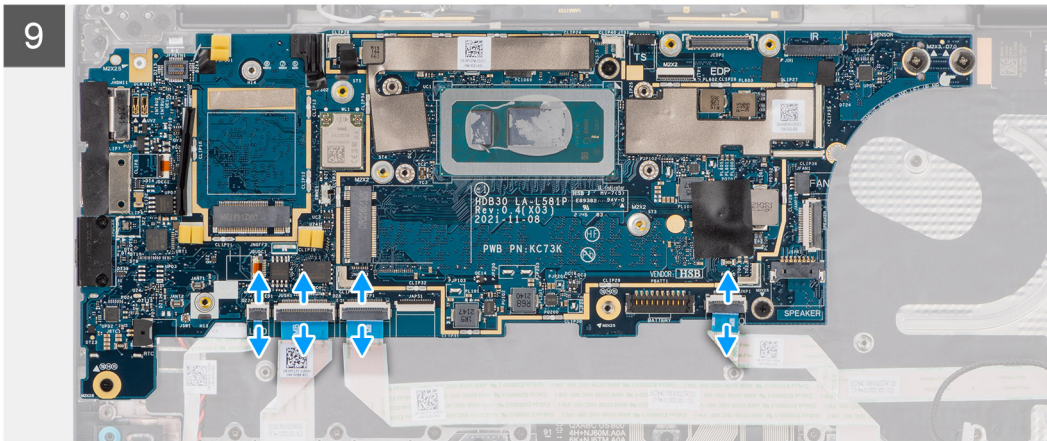

Steps

1. Remove the screw (M2x2.5) that secures the fingerprint reader bracket in place to the system board.

(i) NOTE: The steps from 1 to 3 apply only to computers shipped with a power button with fingerprint reader installed.

2. Remove the fingerprint reader bracket from the system board.
3. Disconnect the fingerprint reader flexible printed circuits from the connectors on the system board.

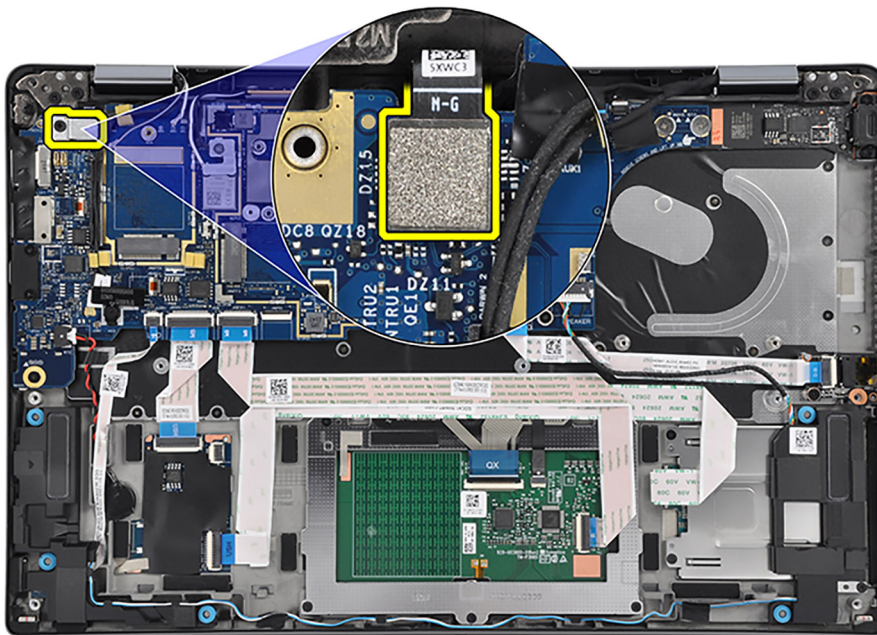

4. For computers shipped with 4G antennas, remove the screw (M2x2.5) that secures the Darwin bracket to the system board.
- i** **NOTE:** The steps from 4 to 7 apply only to computers shipped with a WWAN card installed.
5. For computers shipped with 4G antennas, remove the Darwin bracket from the system board.
 6. Disconnect the #1 Darwin antenna cable and #2 Darwin antenna cable from the respective connectors on the system board.

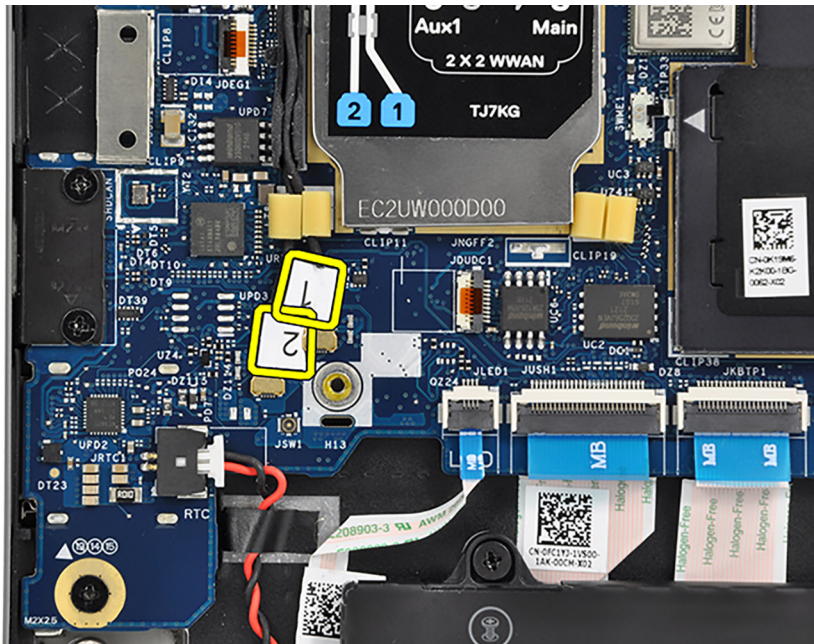

7. For systems shipped with 4G antennas, unroute the #1 Darwin antenna cable, #2 Darwin antenna cable, #6 black/gray WWAN Aux1 antenna cable and #5 white/gray WWAN Main antenna cable from the respective routing guides on the palm-rest and keyboard assembly.
8. For computers shipped with 5G antennas, unroute the #1 Darwin antenna cable, #2 Darwin antenna cable, #3 black/gray WWAN antenna cable, #2 blue WWAN antenna cable, #1 orange WWAN antenna cable and #0 white/gray WWAN antenna cable from the respective routing guides on the palm-rest and keyboard assembly.

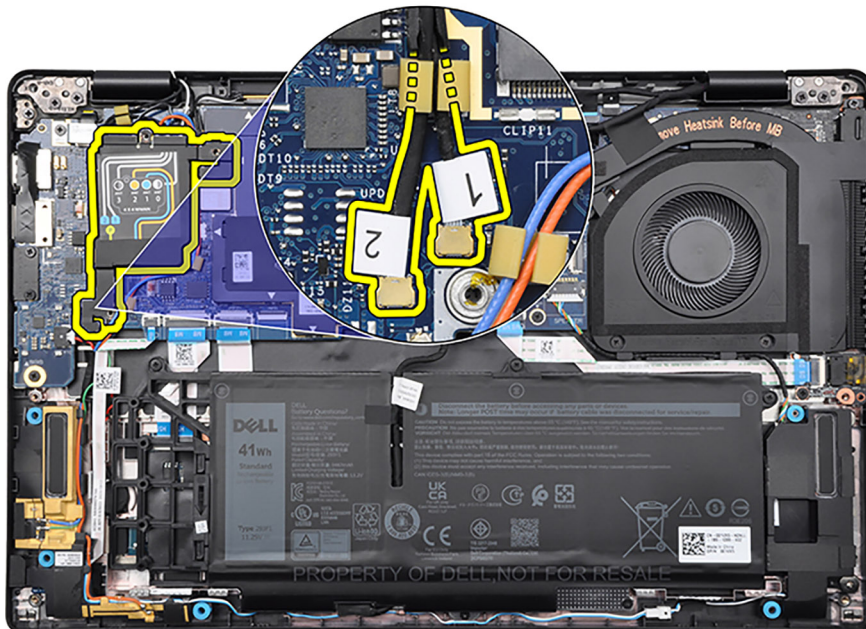

9. For computers shipped with 4G antennas, remove the screw (M2x2) that secures the WLAN bracket to the system board.
10. For computers shipped with 4G antennas, remove the WLAN bracket from the system board.
11. Disconnect and unroute the WLAN-antenna cables from the respective connectors on the system board.

12. Remove the two screws (M2x2) that secure the display-cable bracket to the system board.
13. Remove the display-cable bracket from the system board.
14. Peel back the tape that secures the display cable to the system board.
15. Disconnect the following cables from the respective connectors on the system board:
 - a. Touch-screen cable, if applicable

i **NOTE:** This step applies only to computers shipped with a touch screen installed.
 - b. Display cable
 - c. IR-camera cable, if applicable

i **NOTE:** This step applies only to computers shipped with an IR camera installed.
 - d. Sensor daughter-board cable, if applicable

i **NOTE:** This step applies only to computers shipped with a sensor daughter-board installed.
 - e. Speaker cable
 - f. Audio daughter-board FFC
 - g. Touchpad FFC
 - h. USH daughter-board FFC, if applicable

i **NOTE:** This step applies only to computers shipped with a USH daughter-board installed.
 - i. LED daughter-board FFC
 - j. P-sensor cable

i **NOTE:** This step applies only to computers shipped with 5G antennas installed.

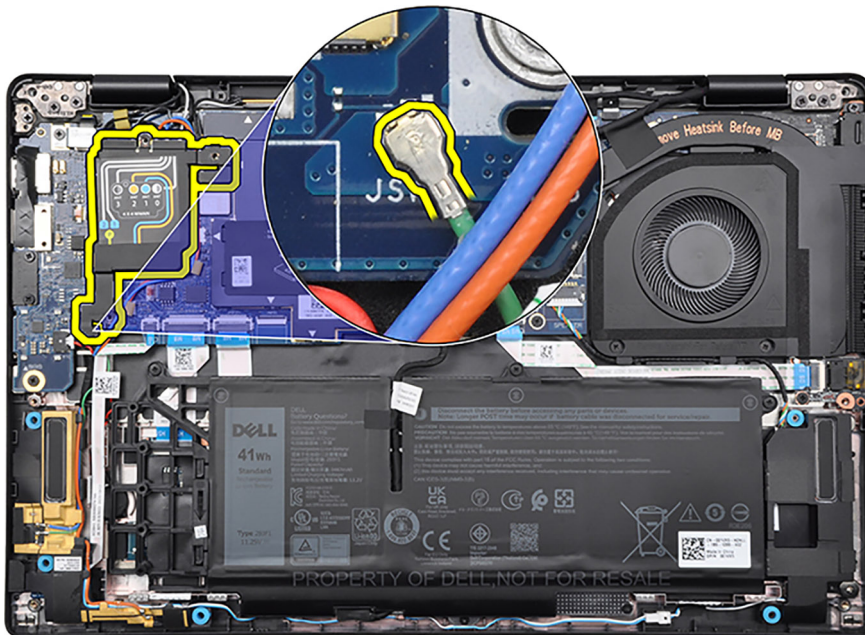

16. Remove the three screws (M2x2.5), the two screws (M2x4) and the two screws (M2x3) that secure the system board to the palm-rest and keyboard assembly.

i **NOTE:** This step applies only to computers shipped with a power button with fingerprint reader installed.

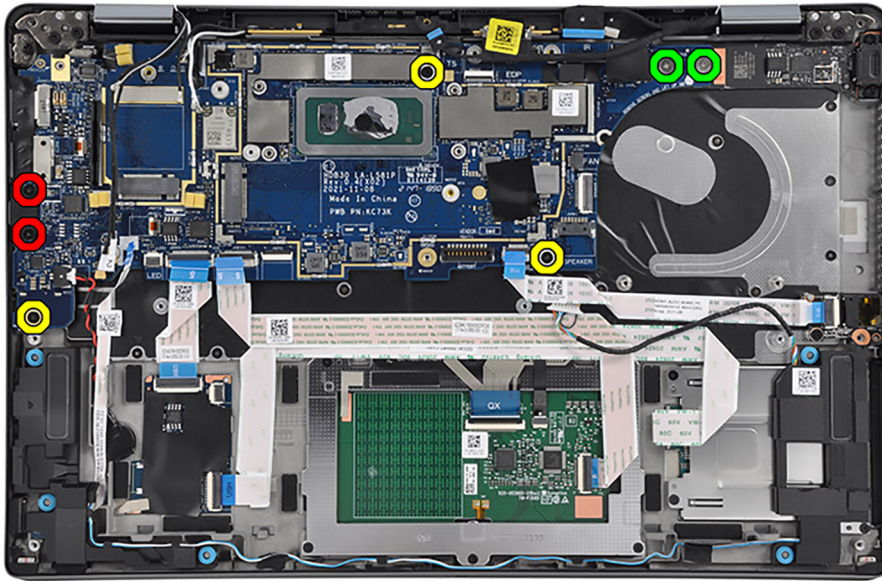

17. Remove the four screws (M2x2.5), the two screws (M2x4) and the two screws (M2x3) that secure the system board to the palm-rest and keyboard assembly.

i **NOTE:** This step applies only to computers shipped with a power button without fingerprint reader installed.

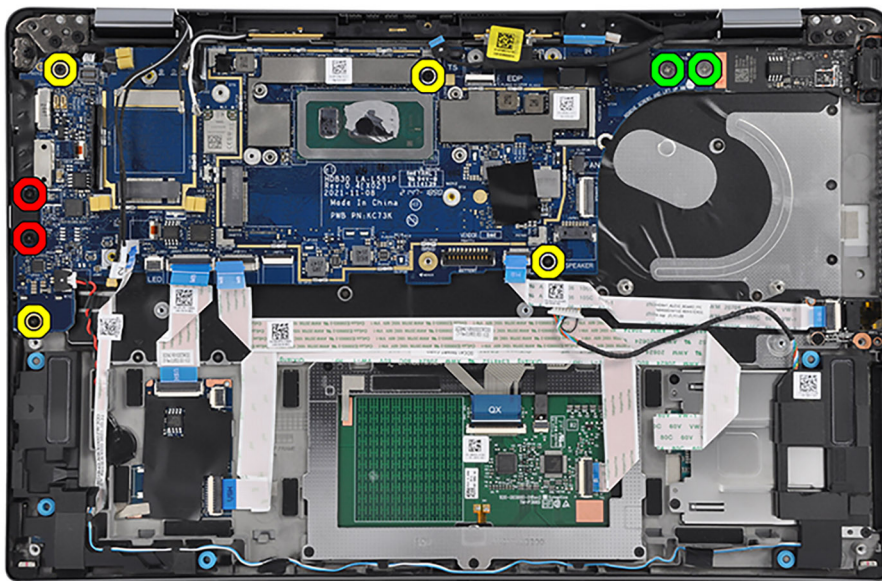

18. Using a plastic scribe, pry the coin-cell battery off the palm-rest and keyboard assembly.

19. Carefully lift and remove the system board, along with the coin-cell battery, away from the palm-rest and keyboard assembly.

20. For computers shipped with 5G antennas, peel off the 5G WWAN-card thermal pad sticker from the system board.

i **NOTE:** The 5G WWAN-card thermal pad sticker must be transferred to the new replacement system board.

21. Remove the shielding cover from the bottom of the system board.

i **NOTE:** This step applies only to computers shipped with a WLAN-antenna module installed on the palm-rest.

Installing the system board

Prerequisites

If you are replacing a component, remove the existing component before performing the installation procedure.

About this task

The following image indicates the connectors on your system board.

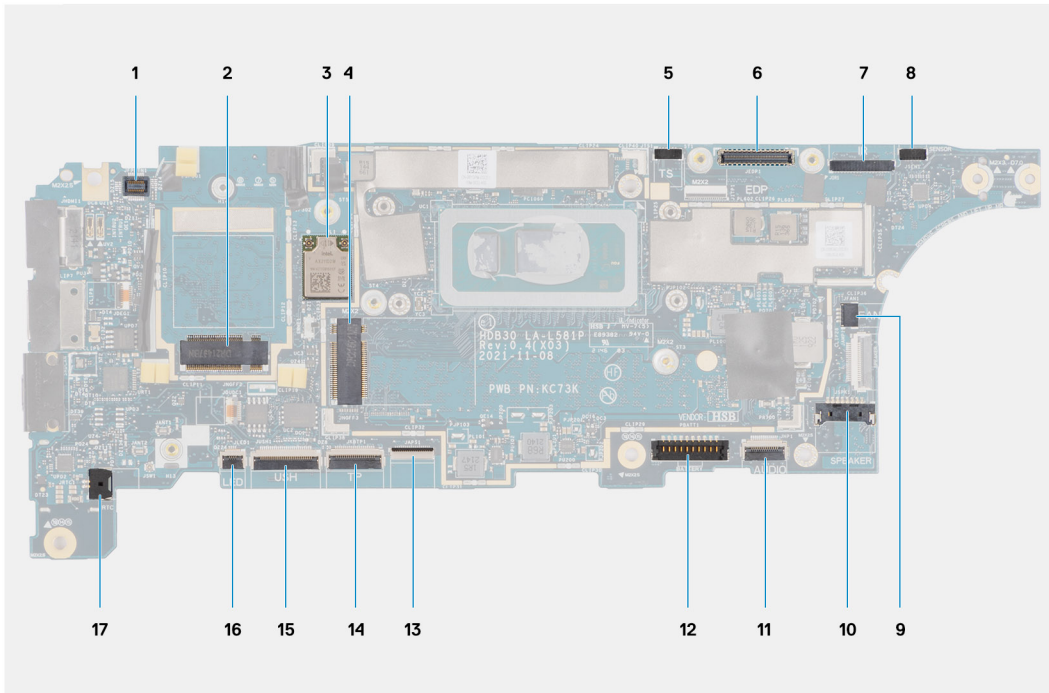

1. Fingerprint reader FPC connector
2. WWAN-card connector
3. WLAN-card connector
4. M.2 solid-state drive connector
5. Touch-screen cable connector
6. eDP cable connector
7. IR-camera cable connector
8. Sensor daughter-board cable connector
9. Thermal-fan cable connector
10. Speaker cable connector
11. Audio daughter-board FFC connector
12. Battery cable connector
13. Keyboard FFC connector
14. Touchpad FFC connector
15. USH daughter-board FFC connector
16. LED daughter-board FFC connector
17. Coin-cell battery cable connector

NOTE: For computers shipped without a WWAN card, a 4G/5G WWAN shielding cover and WWAN bracket (for 4G WWAN card) is pre-installed to the computer. As a result, follow the steps in the WWAN card removal/installation section to remove the WWAN shielding cover and WWAN bracket before removing the system board.

CAUTION: Install the heat-sink after installing the system board as there are two screws (M2x3) underneath the heat-sink, that secure the system board to the computer, that need to be installed first.

The following images indicate the location of the system board and provide a visual representation of the installation procedure.

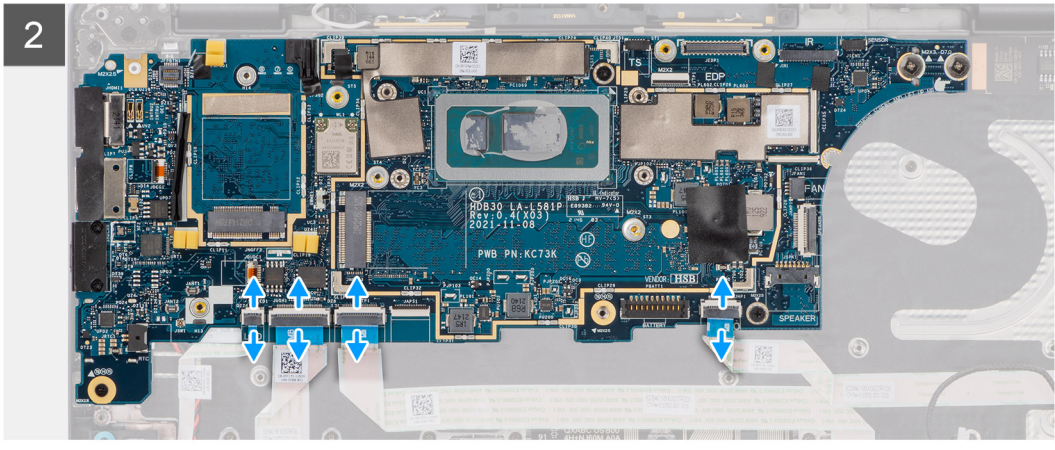
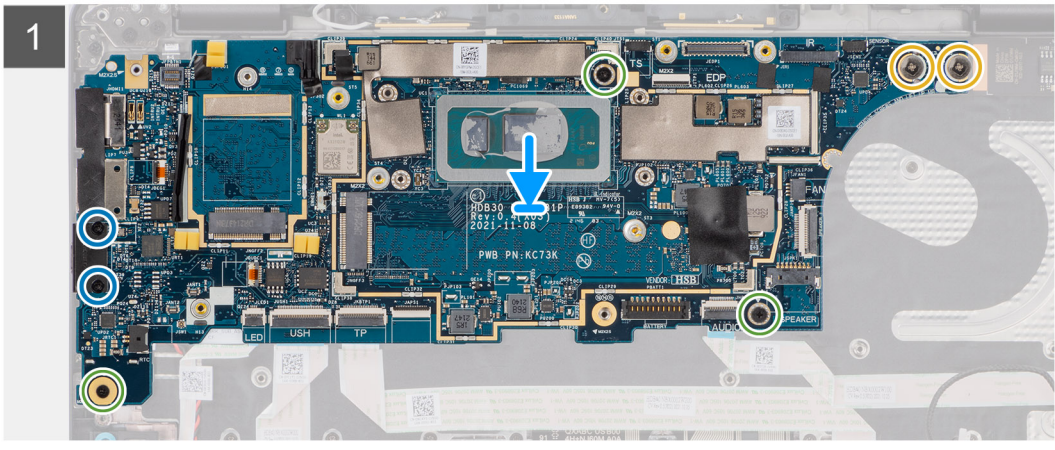
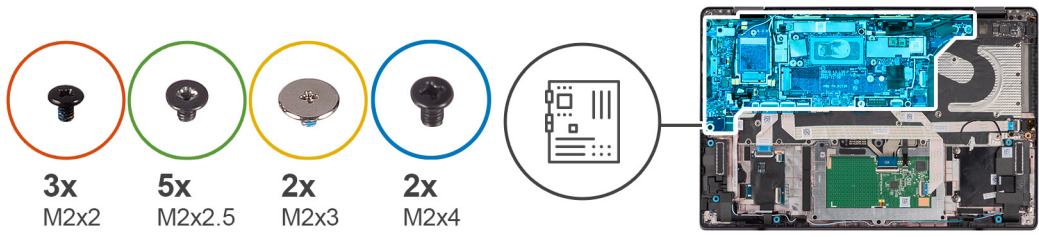

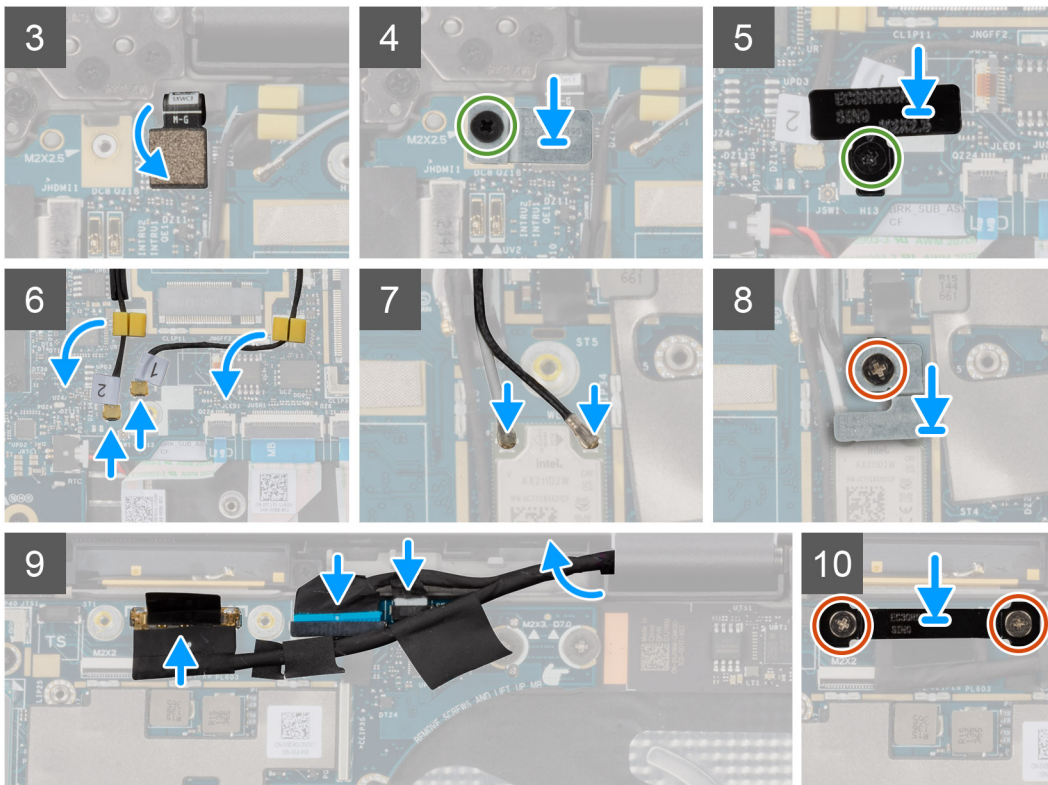

Steps

1. Place the system board, along with the coin-cell battery, into the respective slots on the palm-rest and keyboard assembly.
2. For computers shipped with 5G antennas, adhere the 5G WWAN-card thermal pad sticker to the system board.
 - (i) NOTE:** The 5G WWAN-card thermal pad sticker must be transferred to the new replacement system board.
3. Align and place the shielding cover to the bottom of the system board.
 - (i) NOTE:** This step applies only to computers shipped with a WLAN-antenna module installed on the palm-rest.
4. Align the screw holes on the system board with the screw holes on the palm-rest and keyboard assembly.
5. Replace the four screws (M2x2.5), the two screws (M2x4) and the two screws (M2x3) to secure the system board to the palm-rest and keyboard assembly.
 - (i) NOTE:** This step applies only to computers shipped with a power button without fingerprint reader installed.

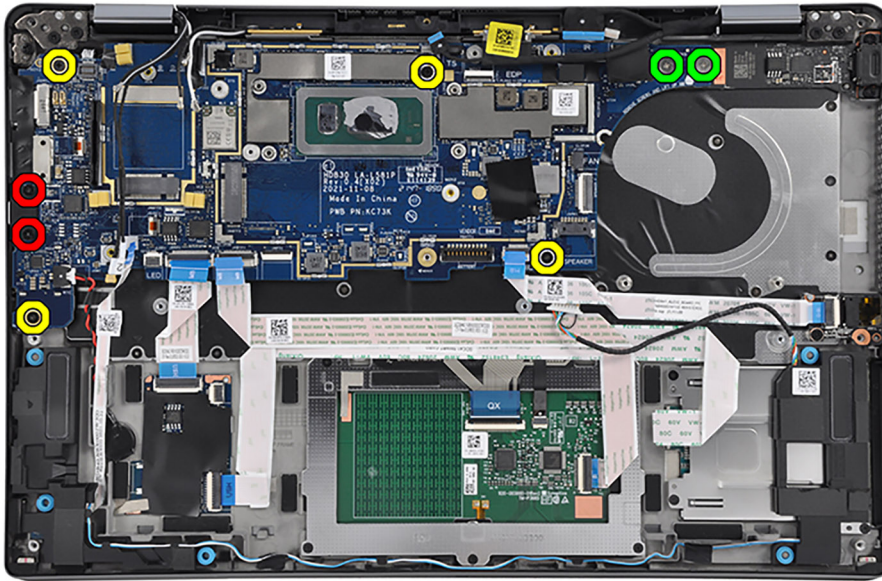

6. Replace the three screws (M2x2.5), the two screws (M2x4) and the two screws (M2x3) to secure the system board to the palm-rest and keyboard assembly.

i **NOTE:** This step applies only to computers shipped with a power button with fingerprint reader installed.

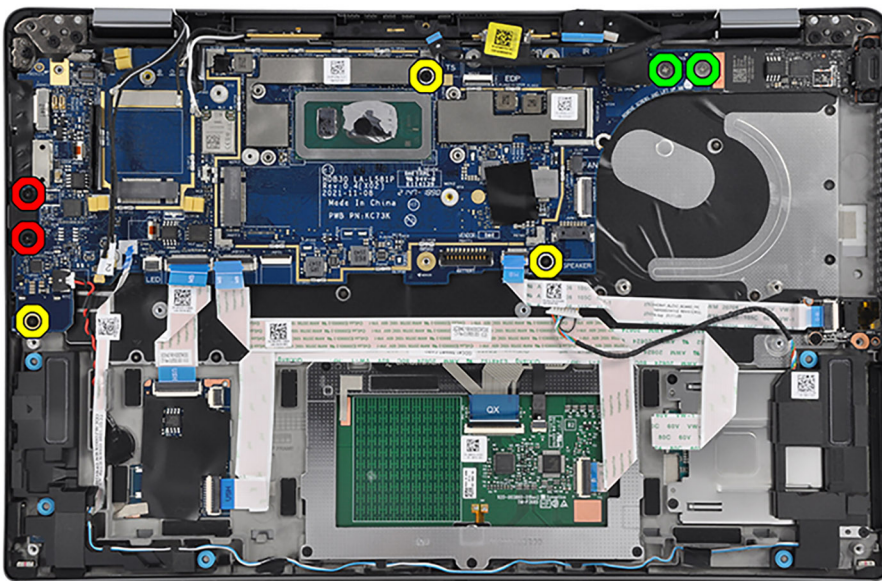

7. Connect the following cables to the respective connectors on the system board:

- a. Touch-screen cable, if applicable

i **NOTE:** This step applies only to computers shipped with a touch screen installed.

- b. Display cable
- c. IR-camera cable, if applicable

i **NOTE:** This step applies only to computers shipped with an IR camera installed.

- d. Sensor daughter-board cable, if applicable

i **NOTE:** This step applies only to computers shipped with a sensor daughter-board installed.

- e. Speaker cable
- f. Audio daughter-board FFC
- g. Touchpad FFC
- h. USH daughter-board FFC, if applicable

i **NOTE:** This step applies only to computers shipped with a USH daughter-board installed.

- i. LED daughter-board FFC
- j. P-sensor cable

i **NOTE:** This step applies only to computers shipped with 5G antennas installed.

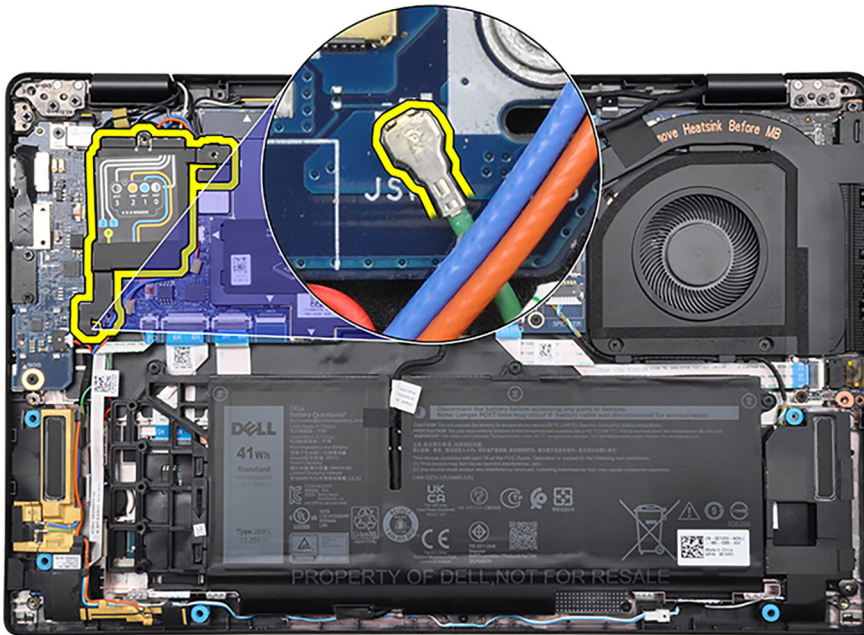

- 8. Adhere the tape to secure the display cable to the system board.
- 9. Align and place the display-cable bracket into its slot on the system board.
- 10. Replace the two screws (M2x2) to secure the display-cable bracket to the system board.
- 11. Route the WLAN-antenna cables through the routing guides and connect them to the respective connectors on the system board.
- 12. For computers shipped with 4G antennas, align and place the WLAN bracket into its slot on the system board.
- 13. For computers shipped with 4G antennas, replace the screw (M2x2) to secure the WLAN bracket to the system board.
- 14. For computers shipped with 5G antennas, route the #1 Darwin antenna cable, #2 Darwin antenna cable, #3 black/gray WWAN antenna cable, #2 blue WWAN antenna cable, #1 orange WWAN antenna cable and #0 white/gray WWAN antenna cable through the respective routing guides on the palm-rest and keyboard assembly.

i **NOTE:** When routing the WWAN-antenna cables, secure the Darwin cables and black/gray WWAN-antenna cable or blue and orange WWAN-antenna cables (for 5G WWAN configuration) in place with the sponges.



15. For computers shipped with 4G antennas, route the #1 Darwin antenna cable, #2 Darwin antenna cable, #6 black/gray WWAN Aux1 antenna cable and #5 white/gray WWAN Main antenna cable through the respective routing guides on the palm-rest and keyboard assembly.

i **NOTE:** The steps from 16 to 19 apply only to computers shipped with a WWAN card installed.

i **NOTE:** When routing the WWAN-antenna cables, secure the Darwin cables and black/gray WWAN-antenna cable (for 4G WWAN configuration) in place with the sponges.

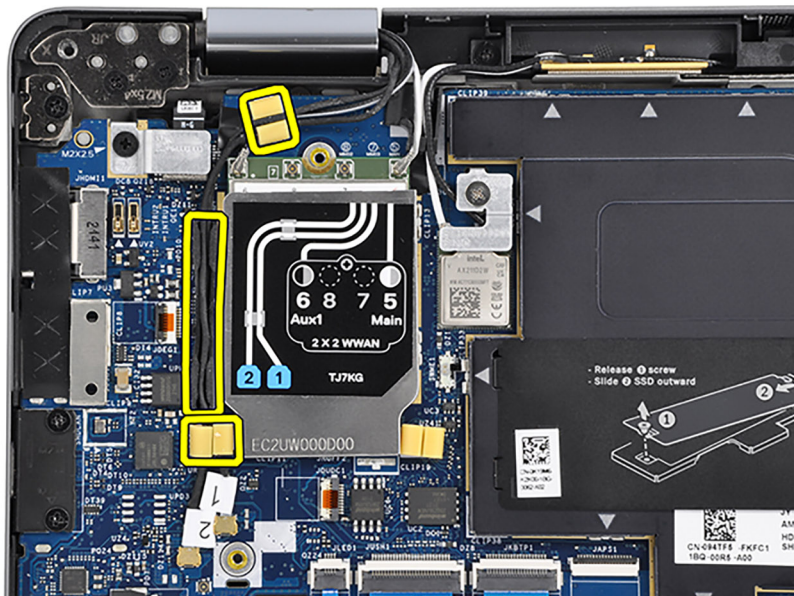

16. Connect the #1 Darwin antenna cable and #2 Darwin antenna cable to the respective connectors on the system board.

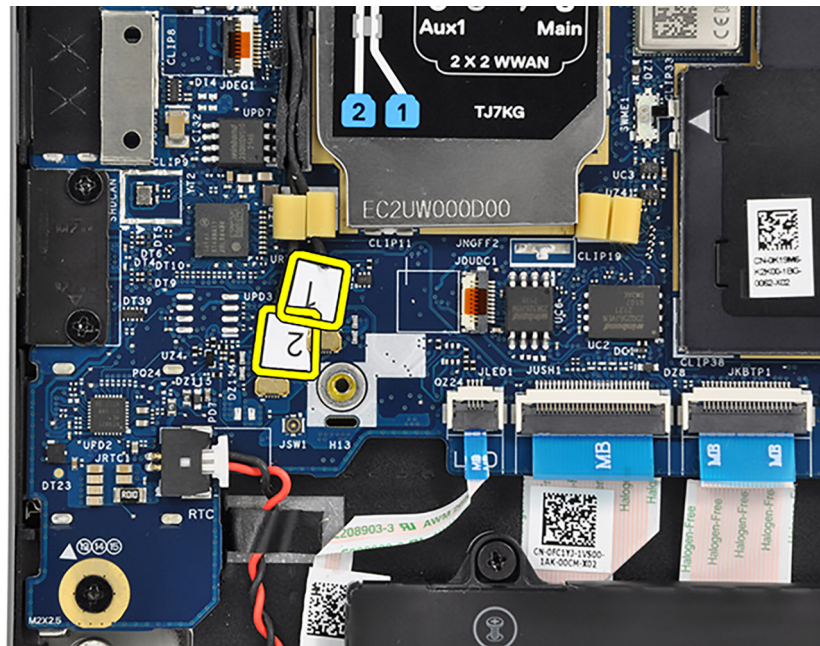

Figure 6. 4G WWAN configuration

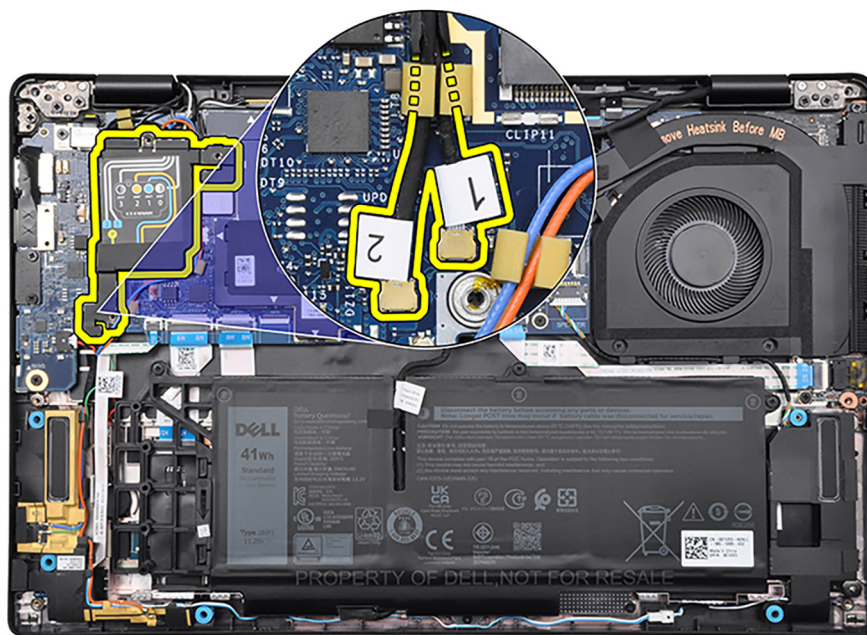

Figure 7. 5G WWAN configuration

17. For computers shipped with 4G antennas, align and place the Darwin bracket into its slot on the system board.
18. For computers shipped with 4G antennas, replace the screw (M2x2.5) to secure the Darwin bracket to the system board.
19. Connect the fingerprint reader flexible printed circuits to the connectors on the system board.
 - i** **NOTE:** The steps from 20 to 22 apply only to computers shipped with a power button with fingerprint reader installed.
20. Align and place the fingerprint reader bracket into its slot on the system board.
21. Replace the screw (M2x2.5) to secure the fingerprint reader bracket to the system board.

Next steps

1. Install the [heat-sink](#).

2. Install the [3-cell battery](#) or the [4-cell battery](#), whichever applicable.
3. Install the [4G WWAN card](#) or the [5G WWAN card](#), whichever applicable.
i **NOTE:** This procedure applies only to computers shipped with a WWAN card installed.
4. Install the [M.2 2230 solid-state drive](#) or the [M.2 2280 solid-state drive](#), whichever applicable.
5. Install the [base cover](#).
6. Install the [microSIM-card tray](#).
7. Follow the procedure in [After working inside your computer](#).

I/O daughter-board

Removing the I/O daughter-board

Prerequisites

1. Follow the procedure in [Before working inside your computer](#).
2. Remove the [microSIM-card tray](#).
3. Remove the [base cover](#).
4. Remove the [M.2 2230 solid-state drive](#) or the [M.2 2280 solid-state drive](#), whichever applicable.
5. Remove the [4G WWAN card](#) or the [5G WWAN card](#), whichever applicable.
i **NOTE:** This procedure applies only to computers shipped with a WWAN card installed.
6. Remove the [3-cell battery](#) or the [4-cell battery](#), whichever applicable.
7. Remove the [heat-sink](#).
8. Remove the [system board](#).

About this task

⚠ CAUTION: Remove the system board before removing the I/O daughter-board as a part of the I/O daughter-board is underneath the system board.

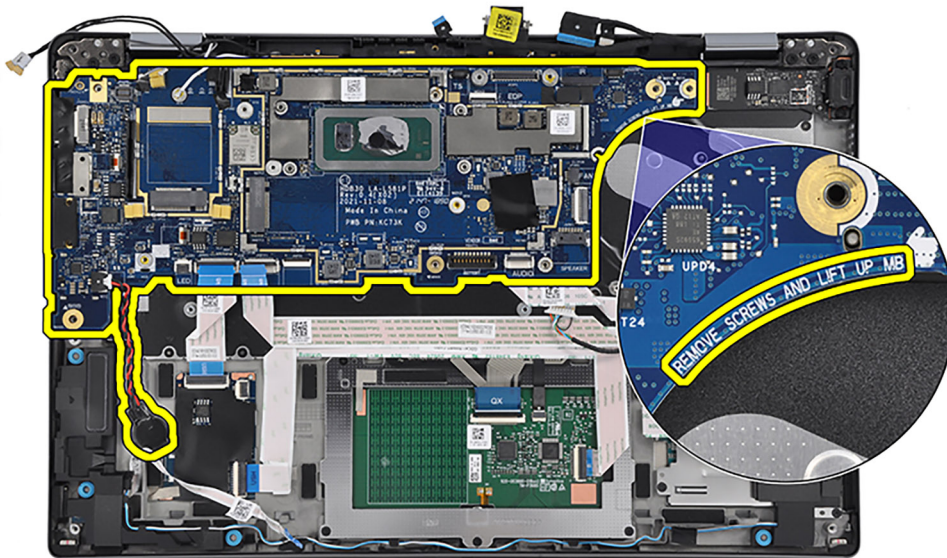

⚠ CAUTION: Do not try to remove the I/O daughter-board along with the system board.

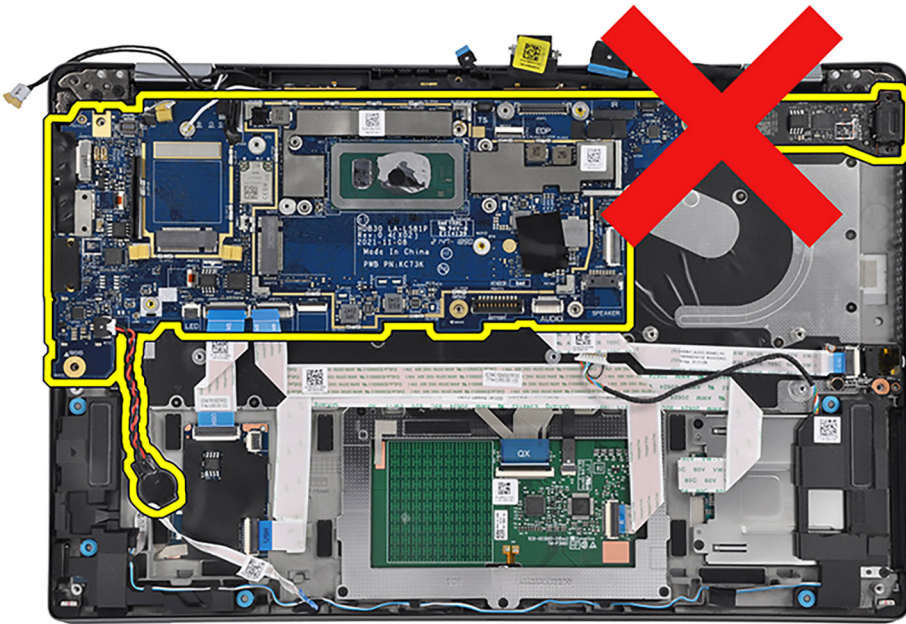

The following image indicates the location of the I/O daughter-board and provides a visual representation of the removal procedure.



2x
M2x4

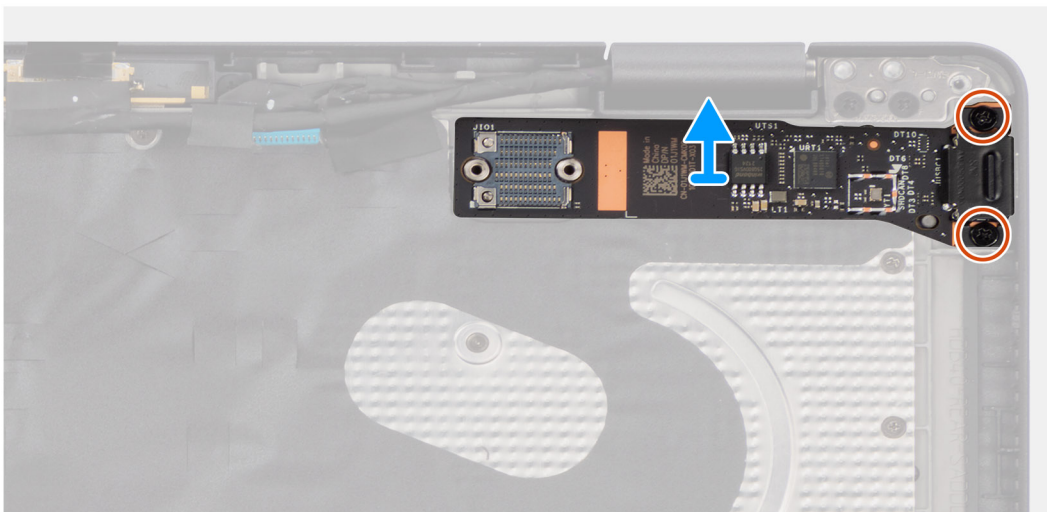
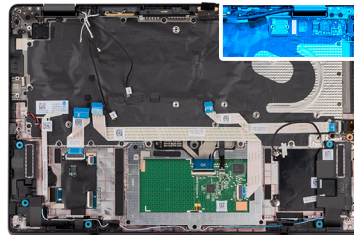

Steps

1. Remove the two screws (M2x4) that secure the I/O daughter-board to the palm-rest and keyboard assembly.
2. Using a plastic scribe, pry the I/O daughter-board starting from the bottom-right side.

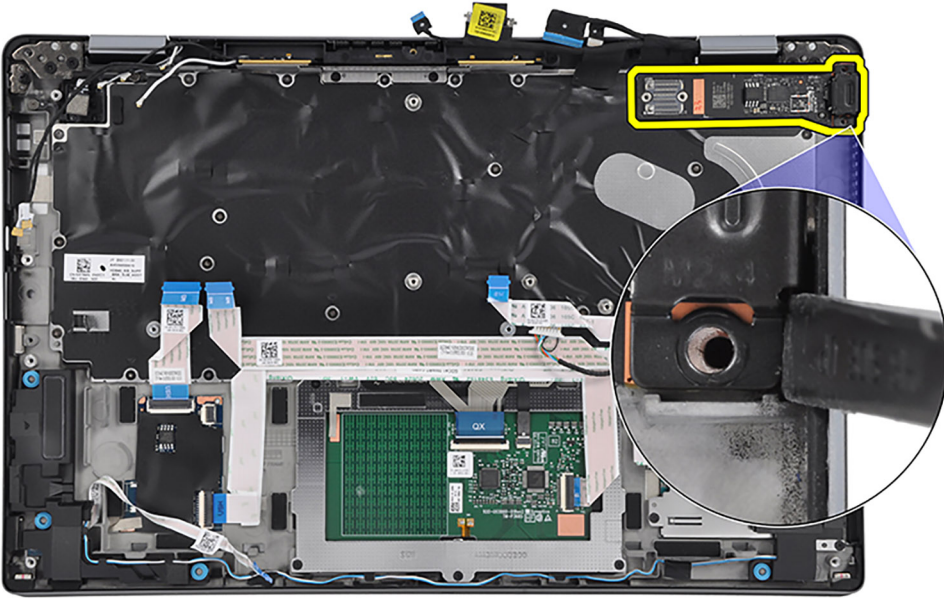

3. Lift and remove the I/O daughter-board from the palm-rest and keyboard assembly.

Installing the I/O daughter-board

Prerequisites

If you are replacing a component, remove the existing component before performing the installation procedure.

About this task

The following image indicates the location of the I/O daughter-board and provides a visual representation of the installation procedure.



2x
M2x4

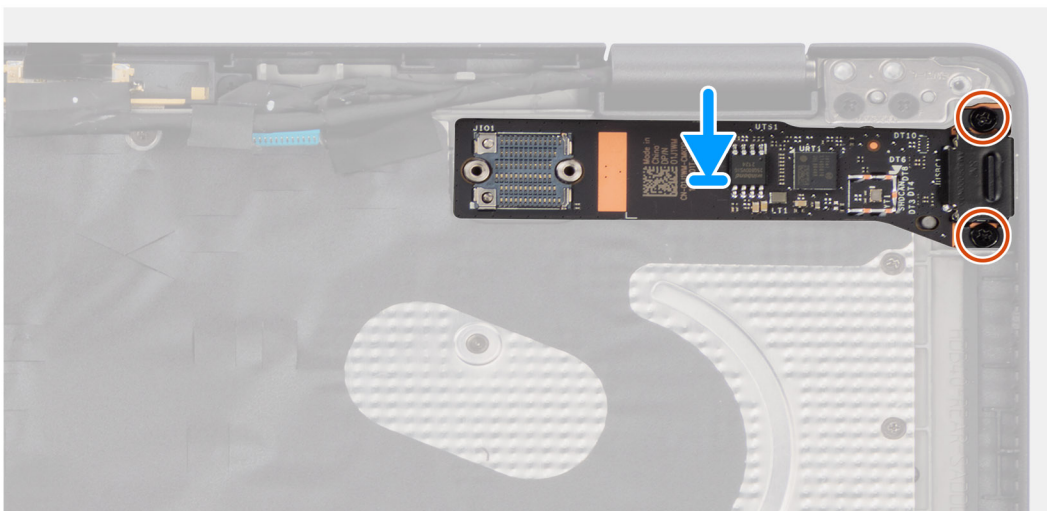
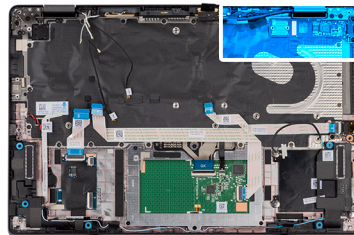

Steps

1. Place the I/O daughter-board into its slot on the palm-rest and keyboard assembly.
2. Align the screw holes on the I/O daughter-board to the screw holes on the palm-rest and keyboard assembly.
3. Replace the two screws (M2x4) to secure the I/O daughter-board to the palm-rest and keyboard assembly.

Next steps

1. Install the [system board](#).
2. Install the [heat-sink](#).
3. Install the [3-cell battery](#) or the [4-cell battery](#), whichever applicable.
4. Install the [4G WWAN card](#) or the [5G WWAN card](#), whichever applicable.
i **NOTE:** This procedure applies only to computers shipped with a WWAN card installed.
5. Install the [M.2 2230 solid-state drive](#) or the [M.2 2280 solid-state drive](#), whichever applicable.
6. Install the [base cover](#).
7. Install the [microSIM-card tray](#).
8. Follow the procedure in [After working inside your computer](#).

Power button with optional fingerprint reader

Removing the power button with optional fingerprint reader

Prerequisites

1. Follow the procedure in [Before working inside your computer](#).
2. Remove the [microSIM-card tray](#).
3. Remove the [base cover](#).
4. Remove the [M.2 2230 solid-state drive](#) or the [M.2 2280 solid-state drive](#), whichever applicable.
5. Remove the [4G WWAN card](#) or the [5G WWAN card](#), whichever applicable.
i **NOTE:** This procedure applies only to computers shipped with a WWAN card installed.
6. Remove the [3-cell battery](#) or the [4-cell battery](#), whichever applicable.
7. Remove the [heat-sink](#).
8. Remove the [system board](#).

About this task

i **NOTE:** For computers shipped with a fingerprint reader, the power button includes a fingerprint reader module.

The following images indicate the location of the power button with optional fingerprint reader and provide a visual representation of the removal procedure.



2x
M1.6x1.7

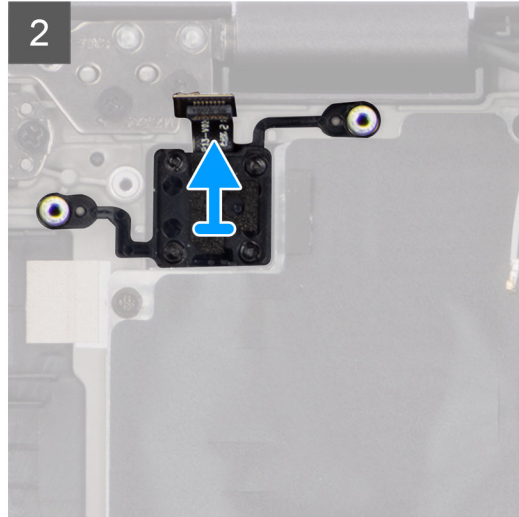
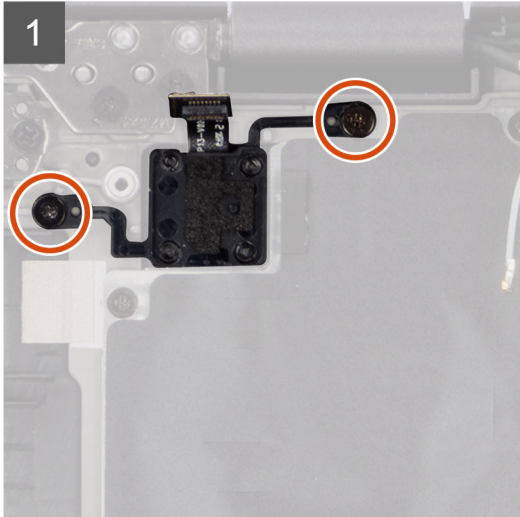
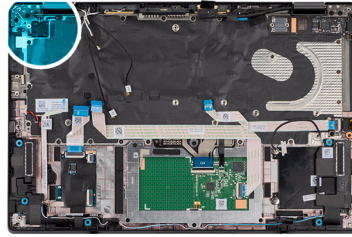

Steps

1. Remove the two screws (M1.6x1.7) that secure the power button with optional fingerprint reader to the palm-rest and keyboard assembly.
2. Peel off the fingerprint reader flexible printed circuits from the connector on the system.
i **NOTE:** This step applies only to computers shipped with a power button with fingerprint reader installed.
3. Lift the power button with optional fingerprint reader off the slot on the palm-rest and keyboard assembly.

Installing the power button with optional fingerprint reader

Prerequisites

If you are replacing a component, remove the existing component before performing the installation procedure.

About this task

The following images indicate the location of the power button with optional fingerprint reader and provide a visual representation of the installation procedure.



2x
M1.6x1.7

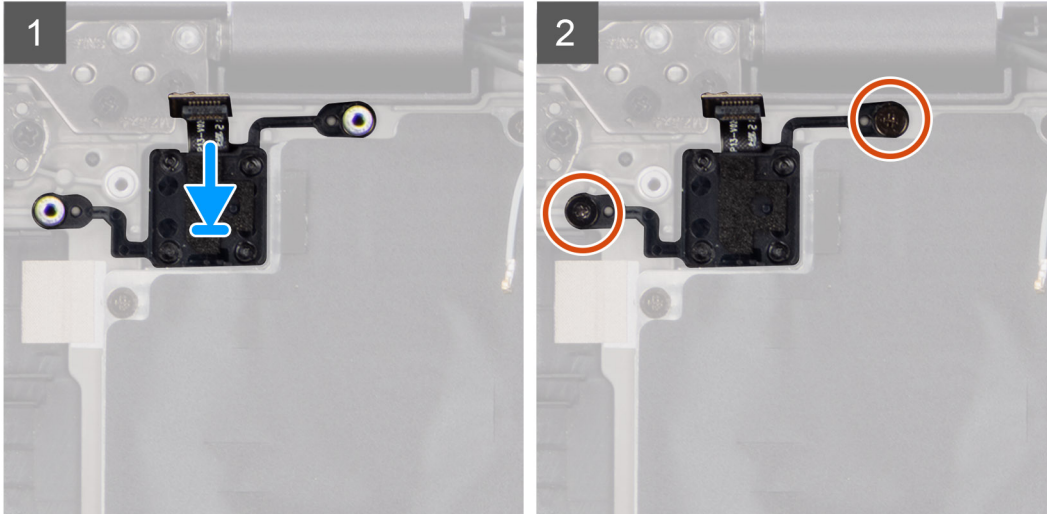
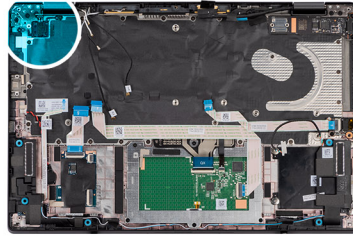

Steps

1. Place the power button with optional fingerprint reader into its slot on the palm-rest and keyboard assembly.
2. Adhere the fingerprint reader flexible printed circuits to the connector on the system.
i **NOTE:** This step applies only to computers shipped with a power button with fingerprint reader installed.
3. Align the screw hole on the power button with optional fingerprint reader to the screw hole on the palm-rest and keyboard assembly.
4. Replace the two screws (M1.6x1.7) to secure the power button with optional fingerprint reader to the palm-rest and keyboard assembly.

Next steps

1. Install the [system board](#).
2. Install the [heat-sink](#).
3. Install the [3-cell battery](#) or the [4-cell battery](#), whichever applicable.
4. Install the [4G WWAN card](#) or the [5G WWAN card](#), whichever applicable.
i **NOTE:** This procedure applies only to computers shipped with a WWAN card installed.
5. Install the [M.2 2230 solid-state drive](#) or the [M.2 2280 solid-state drive](#), whichever applicable.
6. Install the [base cover](#).
7. Install the [microSIM-card tray](#).
8. Follow the procedure in [After working inside your computer](#).

Keyboard

Removing the keyboard

Prerequisites

1. Follow the procedure in [Before working inside your computer](#).

2. Remove the [microSIM-card tray](#).
3. Remove the [base cover](#).
4. Remove the [M.2 2230 solid-state drive](#) or the [M.2 2280 solid-state drive](#), whichever applicable.
5. Remove the [4G WWAN card](#) or the [5G WWAN card](#), whichever applicable.

NOTE: This procedure applies only to computers shipped with a WWAN card installed.

6. Remove the [3-cell battery](#) or the [4-cell battery](#), whichever applicable.
7. Remove the [audio daughter-board](#).
8. Remove the [speakers](#).
9. Remove the [heat-sink](#).
10. Remove the [system board](#).
11. Remove the [I/O daughter-board](#).

About this task

The following images indicate the location of the keyboard and provide a visual representation of the removal procedure.



19x
M1.6x1.7

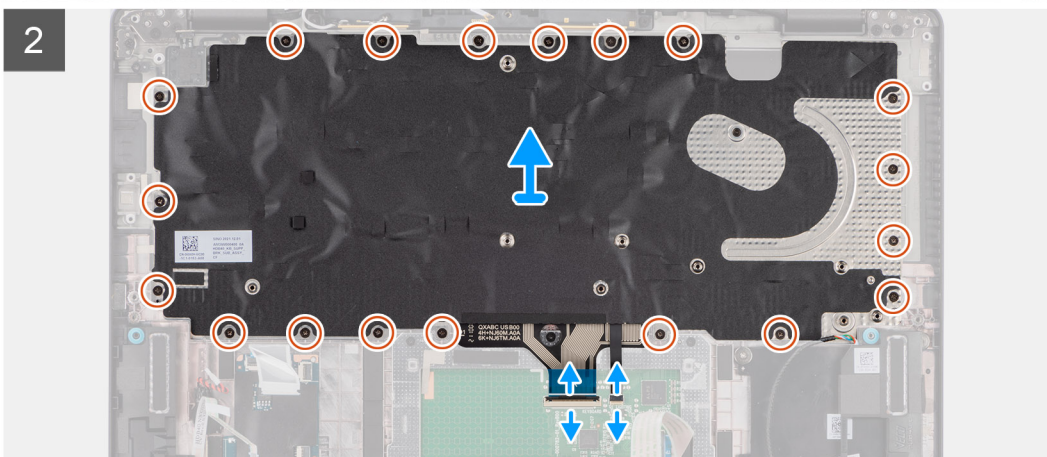
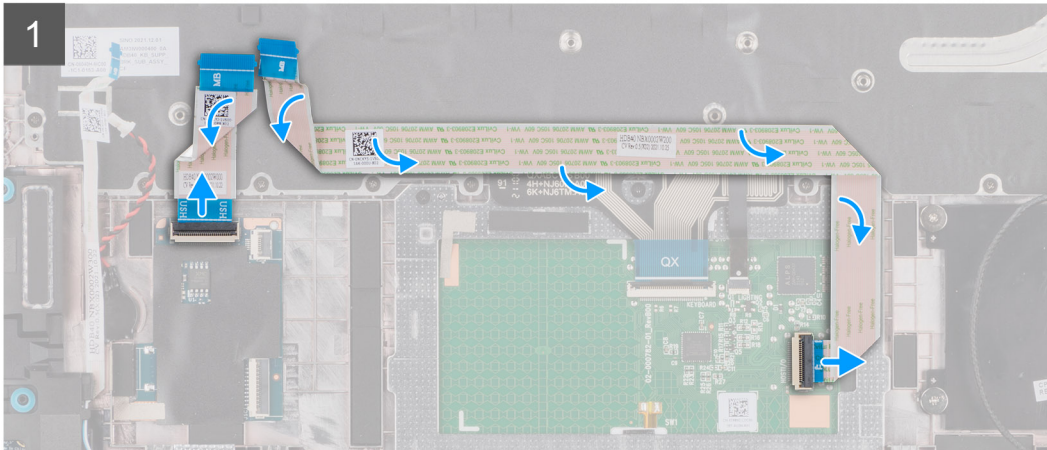
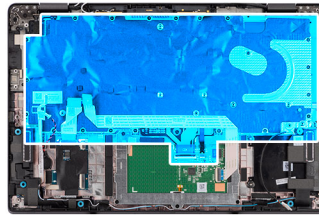



2x
M2x2



Steps

1. Peel the LED daughter-board flexible flat cable from the back of the keyboard.
2. Peel the USH daughter-board flexible flat cable from the back of the keyboard.
i **NOTE:** This step applies only to computers shipped with a USH daughter-board installed.
3. Peel the touchpad flexible flat cable from the back of the keyboard.
4. Peel the smart card reader flexible flat cable from the back of the keyboard.
i **NOTE:** This step applies only to computers shipped with a smart card reader installed.
5. Disconnect the keyboard flexible printed circuits from the connector on the touchpad module.
6. Disconnect the keyboard backlight flexible printed circuits from the connector on the touchpad module.
i **NOTE:** This step applies only to computers shipped with a keyboard backlight installed.
7. For computers shipped with an aluminum palm-rest, remove the 26 screws (M1.6x1.7) that secure the keyboard assembly to the computer.
8. For computers shipped with a carbon fiber palm-rest, remove the 19 screws (M1.6x1.7) that secure the keyboard assembly to the computer.
9. Carefully lift the keyboard assembly to remove it from the computer.
10. Remove the two screws (M2x2) that secure the keyboard to the keyboard support plate.
11. Separate the keyboard from the keyboard support plate.

Installing the keyboard

Prerequisites

If you are replacing a component, remove the existing component before performing the installation procedure.

About this task

The following images indicate the location of the keyboard and provide a visual representation of the installation procedure.



2x
M2x2





19x
M1.6x1.7

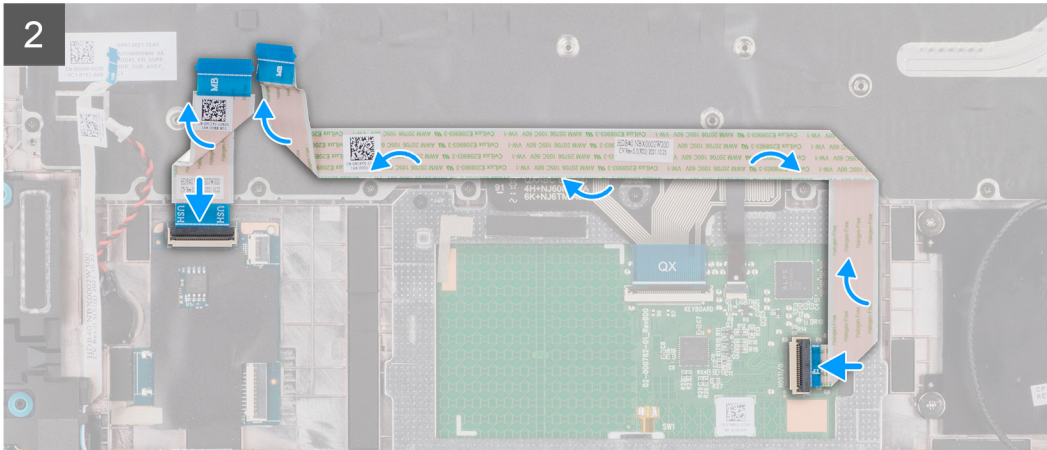
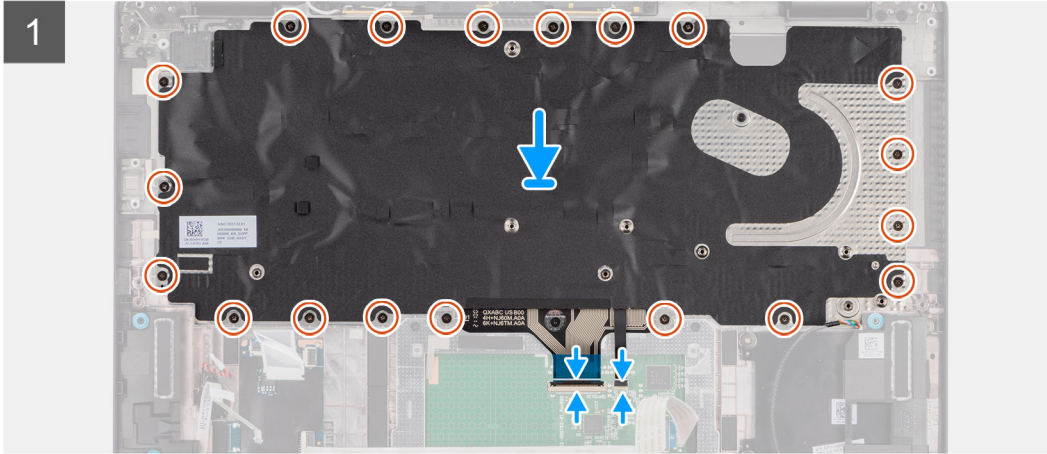
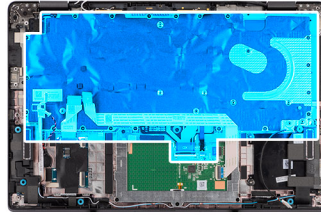

Steps

1. Align the screw holes on the keyboard to the screw holes on the keyboard support plate and place the keyboard on the keyboard support plate.
2. Replace the two screws (M2x2) to secure the keyboard to the keyboard support plate.
3. Align and place the keyboard assembly in to its slot in the computer.
4. For computers shipped with an aluminum palm-rest, replace the 26 screws (M1.6x1.7) to secure the keyboard assembly to the computer.
5. For computers shipped with a carbon fiber palm-rest, replace the 19 screws (M1.6x1.7) to secure the keyboard assembly to the computer.
6. Connect the keyboard backlight flexible printed circuit cable to the connector on the touchpad module.
NOTE: This step applies only to computers shipped with a keyboard backlight installed.
7. Connect the keyboard flexible printed circuit cable to the connector on the touchpad module.
8. Adhere the smart card reader flexible flat cable to the back of the keyboard.
NOTE: This step applies only to computers shipped with a smart card reader installed.
9. Adhere the touchpad flexible flat cable to the back of the keyboard.
10. Adhere the USH daughter-board flexible flat cable to the back of the keyboard.

NOTE: This step applies only to computers shipped with a USH daughter-board installed.

11. Adhere the LED daughter-board flexible flat cable to the back of the keyboard.

Next steps

1. Install the [I/O daughter-board](#).
2. Install the [system board](#).
3. Install the [heat-sink](#).
4. Install the [speakers](#).
5. Install the [audio daughter-board](#).
6. Install the [3-cell battery](#) or the [4-cell battery](#), whichever applicable.
7. Install the [4G WWAN card](#) or the [5G WWAN card](#), whichever applicable.
NOTE: This procedure applies only to computers shipped with a WWAN card installed.
8. Install the [M.2 2230 solid-state drive](#) or the [M.2 2280 solid-state drive](#), whichever applicable.
9. Install the [base cover](#).
10. Install the [microSIM-card tray](#).
11. Follow the procedure in [After working inside your computer](#).

Palm-rest assembly

Removing the palm-rest assembly

Prerequisites

1. Follow the procedure in [Before working inside your computer](#).
2. Remove the [microSIM-card tray](#).
3. Remove the [base cover](#).
4. Remove the [M.2 2230 solid-state drive](#) or the [M.2 2280 solid-state drive](#), whichever applicable.
5. Remove the [4G WWAN card](#) or the [5G WWAN card](#), whichever applicable.
NOTE: This procedure applies only to computers shipped with a WWAN card installed.
6. Remove the [3-cell battery](#) or the [4-cell battery](#), whichever applicable.
7. Remove the [heat-sink](#).
8. Remove the [WLAN-antenna module](#), if applicable.
NOTE: This procedure applies only to computers shipped with a WLAN-antenna module installed on the palm-rest and keyboard assembly.
9. Remove the [display assembly](#).
10. Remove the [audio daughter-board](#).
11. Remove the [speakers](#).
12. Remove the [system board](#).
13. Remove the [I/O daughter-board](#).
14. Remove the [power button with optional fingerprint reader](#).
15. Remove the [keyboard](#).

About this task

NOTE: The palm-rest assembly cannot be further disassembled once all the pre-removal parts procedures are completed. If the keyboard is malfunctioning and is required to be replaced, replace the entire palm-rest assembly.

The image below shows the palm-rest assembly after the pre-removal parts procedures have been performed for any palm-rest assembly replacement.

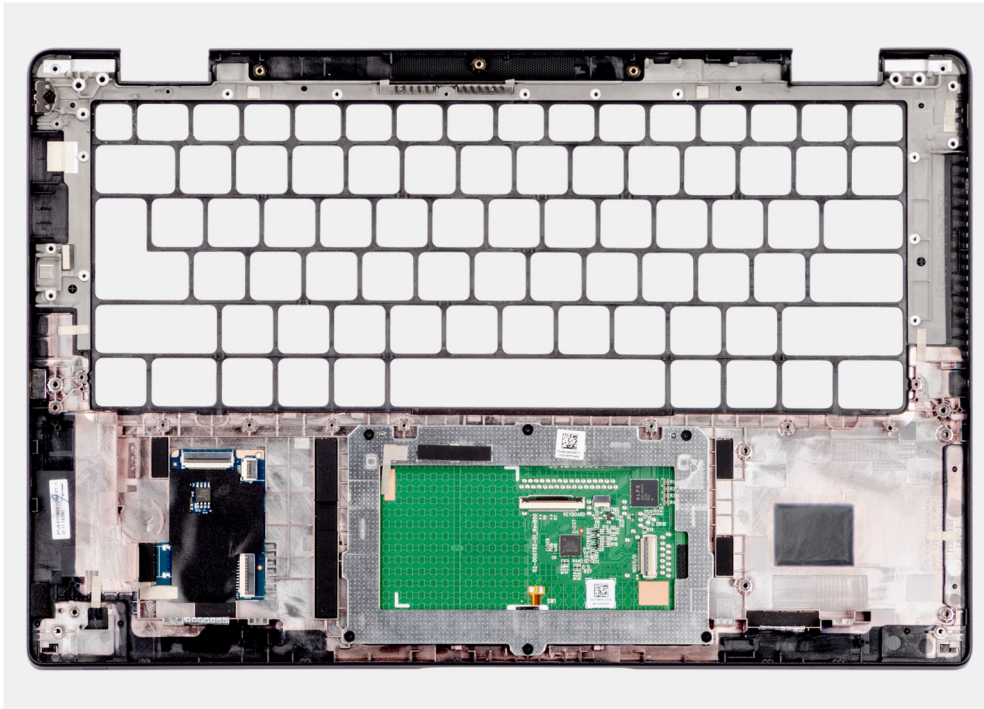

Steps

1. For computers shipped with a carbon fiber palm-rest, use a fine-tipped instrument to push the microSIM filler outwards to remove it from its slot on the palm-rest assembly.

i **NOTE:** The microSIM filler must be transferred to the new replacement palm-rest assembly.

2. After performing the pre-requisites, you are left with the palm-rest assembly.

Installing the palm-rest assembly

Prerequisites

If you are replacing a component, remove the existing component before performing the installation procedure.

About this task

The following image indicates the location of the palm-rest assembly and provides a visual representation of the installation procedure.

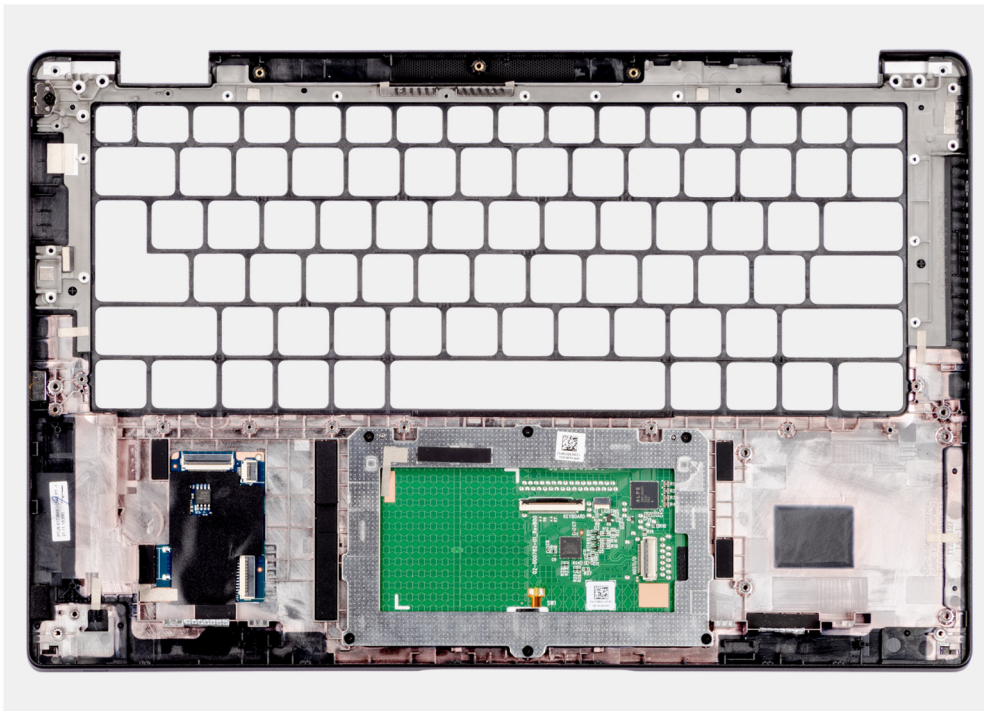

Steps

1. For computers shipped with a carbon fiber palm-rest, align and place the microSIM filler in its slot on the palm-rest assembly.
i **NOTE:** The microSIM filler must be transferred to the new replacement palm-rest assembly.
2. Place the palm-rest assembly on a flat surface and perform the post-requisites to install the palm-rest assembly.

Next steps

1. Install the [keyboard](#).
2. Install the [power button with optional fingerprint reader](#).
3. Install the [I/O daughter-board](#).
4. Install the [system board](#).
5. Install the [speakers](#).
6. Install the [audio daughter-board](#).
7. Install the [display assembly](#).
8. Install the [WLAN-antenna module](#), if applicable.
i **NOTE:** This procedure applies only to computers shipped with a WLAN-antenna module installed on the palm-rest and keyboard assembly.
9. Install the [heat-sink](#).
10. Install the [3-cell battery](#) or the [4-cell battery](#), whichever applicable.
11. Install the [4G WWAN card](#) or the [5G WWAN card](#), whichever applicable.
i **NOTE:** This procedure applies only to computers shipped with a WWAN card installed.
12. Install the [M.2 2230 solid-state drive](#) or the [M.2 2280 solid-state drive](#), whichever applicable.
13. Install the [base cover](#).
14. Install the [microSIM-card tray](#).
15. Follow the procedure in [After working inside your computer](#).

Drivers and downloads

When troubleshooting, downloading or installing drivers it is recommended that you read the Dell Knowledge Based article, Drivers and Downloads FAQ [000123347](#).

BIOS setup

CAUTION: Unless you are an expert computer user, do not change the settings in the BIOS Setup program. Certain changes can make your computer work incorrectly.

NOTE: Depending on the computer and its installed devices, the items listed in this section may or may not be displayed.

NOTE: Before you change BIOS Setup program, it is recommended that you write down the BIOS Setup program screen information for future reference.

Use the BIOS Setup program for the following purposes:

- Get information about the hardware installed in your computer, such as the amount of RAM and the size of the hard drive.
- Change the system configuration information.
- Set or change a user-selectable option, such as the user password, type of hard drive installed, and enabling or disabling base devices.

BIOS overview

The BIOS manages data flow between the computer's operating system and attached devices such as hard disk, video adapter, keyboard, mouse, and printer.

Entering BIOS setup program

Steps

1. Turn on your computer.
2. Press F2 immediately to enter the BIOS setup program.

NOTE: If you wait too long and the operating system logo appears, continue to wait until you see the desktop. Then, turn off your computer and try again.

Navigation keys

NOTE: For most of the System Setup options, changes that you make are recorded but do not take effect until you restart the system.

Table 5. Navigation keys

Keys	Navigation
Up arrow	Moves to the previous field.
Down arrow	Moves to the next field.
Enter	Selects a value in the selected field (if applicable) or follow the link in the field.
Spacebar	Expands or collapses a drop-down list, if applicable.
Tab	Moves to the next focus area. NOTE: For the standard graphics browser only.

Table 5. Navigation keys (continued)

Keys	Navigation
Esc	Moves to the previous page until you view the main screen. Pressing Esc in the main screen displays a message that prompts you to save any unsaved changes and restarts the system.

One time boot menu

To enter **one time boot menu**, turn on your computer, and then press F12 immediately.

i **NOTE:** It is recommended to shutdown the computer if it is on.

The one-time boot menu displays the devices that you can boot from including the diagnostic option. The boot menu options are:

- Removable Drive (if available)
- STXXXX Drive (if available)
 - i** **NOTE:** XXX denotes the SATA drive number.
- Optical Drive (if available)
- SATA Hard Drive (if available)
- Diagnostics

The boot sequence screen also displays the option to access the System Setup screen.

System setup options

i **NOTE:** Depending on your system and its installed devices, the items that are listed in this section may or may not appear.

Table 6. System setup options—System information menu

Overview	
Latitude 7430	
BIOS Version	Displays the BIOS version number.
Service Tag	Displays the Service Tag of the system.
Asset Tag	Displays the Asset Tag of the system.
Manufacture Date	Displays the manufacture date of the system.
Ownership Date	Displays the ownership date of the system.
Express Service Code	Displays the express service code of the system.
Ownership Tag	Displays the Ownership Tag of the system.
Signed Firmware Update	Displays whether the Signed Firmware Update is enabled on your system.
Battery Information	
Primary	Displays that battery is primary.
Battery Level	Displays the battery level of the system.
Battery State	Displays the battery state of the system.
Health	Displays the battery health of the system.
AC Adapter	Displays whether the AC adapter is connected or not.
Battery Type	Displays the type of battery.
Processor Information	

Table 6. System setup options—System information menu (continued)

Overview	
Processor Type	Displays the processor type.
Maximum Clock Speed	Displays the maximum processor clock speed.
Minimum Clock Speed	Displays the minimum processor clock speed.
Current Clock Speed	Displays the current processor clock speed.
Core Count	Displays the number of cores on the processor.
Processor ID	Displays the processor identification code.
Processor L2 Cache	Displays the processor L2 Cache size.
Processor L3 Cache	Displays the processor L3 Cache size.
Microcode Version	Displays the microcode version.
Intel Hyper-Threading Capable	Displays whether the processor is Hyper-Threading (HT) capable.
64-Bit Technology	Displays whether 64-bit technology is used.
Memory Information	
Memory Installed	Displays the total system memory installed.
Memory Available	Displays the total system memory available.
Memory Speed	Displays the memory speed.
Memory Channel Mode	Displays single or dual channel mode.
Memory Technology	Displays the technology that is used for the memory.
Devices Information	
Panel Type	Displays the Panel Type of the system.
Video Controller	Displays the video controller type of the system.
Video Memory	Displays the video memory information of the system.
Wi-Fi Device	Displays the wireless device information of the system.
Native Resolution	Displays the native resolution of the system.
Video BIOS Version	Displays the video BIOS version of the system.
Audio Controller	Displays the audio controller information of the system.
Bluetooth Device	Displays the Bluetooth device information of the system.
LOM MAC Address	Displays the LAN On Motherboard (LOM) MAC address of the system.
Pass Through MAC Address	Displays the pass through MAC address of the system.
Cellular Device	Displays the M.2 PCIe SSD information of the system.

Table 7. System setup options—Boot Configuration menu

Boot Configuration	
Boot Sequence	
Boot mode	Displays the boot mode.
Boot Sequence	Displays the boot sequence.
Secure Digital (SD) Card Boot	Enable or disable the SD card read-only boot. By default, the Secure Digital (SD) Card Boot option is not enabled.
Secure Boot	
Enable Secure Boot	Enable or disable the secure boot feature. By default, the Secure Boot is enabled.

Table 7. System setup options—Boot Configuration menu (continued)

Boot Configuration	
Secure Boot Mode	Enable or disable to change the secure boot mode options. By default, the Deployed Mode is enabled.
Expert Key Management	
Enable Custom Mode	Enable or disable custom mode. By default, the custom mode option is not enabled.
Custom Mode Key Management	Select the custom values for expert key management.

Table 8. System setup options—Integrated Devices menu

Integrated Devices	
Date/Time	Displays the current date in MM/DD/YYYY format and current time in HH:MM:SS AM/PM format.
Camera	Enables or disable the camera. By default, the Enable Camera option is selected
Audio	
Enable Audio	Enable or disable the integrated audio controller. By default, all the options are enabled.
USB/Thunderbolt Configuration	<ul style="list-style-type: none"> • Enable or disable booting from USB mass storage devices that are connected to external USB ports. By default, the Enable External USB Ports option is enabled. • Enable or disable booting from USB mass storage devices such as external hard drive, optical drive, and USB drive. By default, the Enable USB Boot Support option is enabled.
Enable Thunderbolt Technology Support	Enable or disable the associated ports and adapters. By default, the Enable Thunderbolt Technology Support option is selected.
Enable Thunderbolt Boot Support	Enable or disable the Thunderbolt adapter peripheral device and USB devices that are connected to the Thunderbolt adapter to be used during BIOS Pre-boot. By default, the Enable Thunderbolt Boot Support option is disabled.
Enable Thunderbolt (and PCIe behind TBT) pre-boot modules	Enable or disable the PCIe devices that are connected through a Thunderbolt adapter to execute the PCIe devices UEFI Option ROM (if present) during pre-boot. By default, the Enable Thunderbolt (and PCIe behind TBT) pre-boot modules option is disabled.
Disable USB4 PCIE Tunneling	Disable the USB4 PCIE Tunneling option. By default, the option is disabled.
Video/Power only on Type-C Ports	Enable or disable the Type-C port functionality to video or only power. By default, the Video/Power only on Type-C Ports option is disabled.
Type-C Dock Override	Enables to use connected Type-C Dell Dock to provide data stream with external USB ports disabled. When Type-C Dock override is enabled, the Video/Audio/Lan submenu is activated. By default, the Type-C Dock Override option is enabled.
Video	Enable or disable the usage of video on Dell Dock external ports.

Table 8. System setup options—Integrated Devices menu (continued)

Integrated Devices	
	By default, the Video option is disabled.
Audio	Enable or disable the usage of audio on Dell Dock external ports. By default, the Audio option is enabled.
Lan	Enable or disable the usage of LAN on Dell Dock external ports. By default, the Lan option is enabled.
Miscellaneous Devices	Enable or disable Fingerprint Reader device. By default, the Enable Fingerprint Reader Device option is enabled.
Unobtrusive Mode	
Enable Unobtrusive Mode	Enable or disable all the system light and sound. By default, the Enable Unobtrusive Mode option is disabled.

Table 9. System setup options—Storage menu

Storage	
SATA/NVMe Operation	
SATA/NVMe Operation	Set the operating mode of the integrated storage device controller. By default, the RAID On option is enabled.
Storage interface	
Port Enablement	This page allows you to enable the onboard drives. By default, the M.2 PCIe SSD option is enabled.
SMART Reporting	
Enable SMART Reporting	Enable or disable Self-Monitoring, Analysis, and Reporting Technology (SMART) during system startup. By default, the Enable SMART Reporting option is not enabled.
Drive Information	
M.2 PCIe SSD	
Type	Displays the M.2 PCIe SSD type information of the system.
Device	Displays the M.2 PCIe SSD device information of the system.
Enable MediaCard	
Secure Digital (SD) Card	Enable or disable the SD card. By default, the Secure Digital (SD) Card option is enabled.
Secure Digital (SD) Card Read-Only Mode	Enable or disable the SD card read-only mode. By default, the Secure Digital (SD) Card Read-Only Mode option is not enabled.

Table 10. System setup options—Display menu

Display	
Display Brightness	
Brightness on battery power	Enable to set screen brightness when the system is running on battery power.
Brightness on AC power	Enable to set screen brightness when the system is running on AC power.
Full Screen Logo	Enable or disable full screen logo.

Table 10. System setup options—Display menu (continued)

Display	
	By default, the option is not enabled.

Table 11. System setup options—Connection menu

Connection	
Wireless Device Enable	
WWAN/GPS	Enable or disable the internal WWAN/GPS device. By default, the option enabled.
WWAN Bus Mode	Set the interface type of the Wireless Wan (WWAN) card. By default, the Bus Mode PCIe option is enabled.
WLAN	Enable or disable the internal WLAN device. By default, the option enabled.
Bluetooth	Enable or disable the internal Bluetooth device. By default, the option enabled.
Contactless smart card/NFC	Enable or disable the internal Contactless smart card/NFC device. By default, the option enabled.
Enable UEFI Network Stack	
	Enable or disable UEFI Network Stack and controls the on-board LAN Controller. By default, the Enable UEFI Network Stack option is enabled.
Wireless Radio Control	
Control WLAN radio	Sense the connection of the system to a wired network and subsequently disable the selected wireless radios (WLAN). By default, the option is disabled.
Control WWAN radio	Sense the connection of the system to a wired network and subsequently disable the selected wireless radios (WWAN). By default, the option is disabled.
HTTPs Boot Feature	
HTTPs Boot	Enable or disable the HTTPs Boot feature. By default, the HTTPs Boot option is disabled.
HTTPs Boot Mode	With Auto Mode, the HTTPs Boot extracts Boot URL from the DHCP. With Manual Mode, the HTTPs Boot reads Boot URL from the user-provided data. By default, the Auto Mode option is enabled.

Table 12. System setup options—Power menu

Power	
Battery configuration	
	Enables the system to run on battery during peak power usage hours. Use the table Custom Charge Start and Custom Charge Stop , to prevent AC power usage between certain times of each day. By default, the Adaptive option is enabled.
Advanced Configuration	
Enable Advanced Battery Charge Configuration	Enable or disable the advanced battery charge configuration.

Table 12. System setup options—Power menu (continued)

Power	
	By default, the Enable Advanced Battery Charge Configuration option is disabled.
Peak Shift	Enables the system to run on battery during peak power usage hours.
Enable Peak Shift	By default, the Enable Peak Shift option is disabled.
USB PowerShare	
Enable USB PowerShare	Enable or disable the USB PowerShare. By default, the Enable USB PowerShare option is disabled
Thermal Management	Enables to cool the fan and processor heat management to adjust the system performance, noise, and temperature. By default, the Optimized option is enabled.
USB Wake Support	
Wake on Dell USB-C Dock	When enabled, connecting a Dell USB-C Dock will wake the system from Standby, Hibernate, and Power Off. By default, the Wake on Dell USB-C Dock option is enabled.
Block Sleep	Enables to block entering sleep (S3) mode in the operating system. By default, the Block Sleep option is disabled.
Lid Switch	
Enabled Lid Switch	Enable or disable the lid switch. By default, the Enable Lid Switch option is enabled.
Power On Lid Open	When enabled, allows the system to power up from the off state whenever the lid is opened. By default, the Power On Lid Open option is enabled.
Intel Speed Shift Technology	Enable or disable the Intel speed shift technology support. By default, the Intel Speed Shift Technology option is enabled.

Table 13. System setup options—Security menu

Security	
TPM 2.0 Security	
TPM 2.0 Security On	Allows you to enable or disable TPM visibility to operating system. By default, the TPM 2.0 Security On option is enabled.
Attestation Enable	Enables to control whether the Trusted Platform Module (TPM) Endorsement Hierarchy is available to the operating system. By default, the Attestation Enable option is enabled.
Key Storage Enable	Enables to control whether the Trusted Platform Module (TPM) Storage Hierarchy is available to the operating system. By default, the Key Storage Enable option is enabled.
SHA-256	When enabled, the BIOS and TPM will use the SHA-256 hash algorithm to extend measurements into the TPM PCRs during BIOS boot. By default, the SHA-256 option is enabled.
Clear	Enables to clear the TPM owner information and returns the TPM to the default state.

Table 13. System setup options—Security menu (continued)



Security	
PPI Bypass for Clear Commands	<p>By default, the Clear option is disabled.</p> <p>Controls the TPM Physical Presence Interface (PPI).</p> <p>By default, the PPI ByPass for clear Commands option is disabled.</p>
Intel Total Memory Encryption	
Total Memory Encryption	<p>Enable or disable you to protect memory from physical attacks including freeze spray, probing DDR to read the cycles, and others.</p> <p>By default, the Total Memory Encryption option is disabled.</p>
Chassis intrusion	
Clear Intrusion Warning	<p>Controls the chassis intrusion feature.</p> <p>By default, the On-Silent option is enabled.</p> <p>By default, the option is disabled.</p>
SMM Security Mitigation	
	<p>Enable or disable additional UEFI SMM Security Mitigation protections.</p> <p>By default, the option is enabled.</p>
Data Wipe on Next Boot	
Start Data Wipe	<p>Enable or disable the data wipe on next boot.</p> <p>By default, the Start Data Wipe option is disabled.</p>
Absolute	<p>Enable or disable or permanently disable the BIOS module interface of the optional Absolute Persistence Module service from Absolute software.</p> <p>By default, the option is enabled.</p> <p> WARNING: The 'Permanently Disabled' option can only be selected once. When 'Permanently Disabled' is selected, Absolute Persistence cannot be re-enabled. No further changes to the Enable/Disable states are allowed.</p> <p> NOTE: The Enable/Disable options will be unavailable while Computrace is in the activated state.</p>
UEFI Boot Path Security	<p>Controls whether the system will prompt the user to enter the admin password (if set) when booting to a UEFI boot path device from the F12 boot menu.</p> <p>By default, the Always Except Internal HDD option is enabled.</p>

Table 14. System setup options—Passwords menu

Passwords	
Admin Password	Set, change, or delete the administrator password.
System Password	Set, change, or delete the system password.
NVMe SSD0	Set, change, or delete the NVMe SSD0 password.
Password Configuration	
Upper Case Letter	<p>Reinforces password must have at least one upper case letter.</p> <p>By default, the option is disabled.</p>
Lower Case Letter	<p>Reinforces password must have at least one lower case letter.</p> <p>By default, the option is disabled.</p>
Digit	<p>Reinforces password must have at least one digit number.</p> <p>By default, the option is disabled.</p>

Table 14. System setup options—Passwords menu (continued)

Passwords	
Special Character	Reinforces password must have at least one special character. By default, the option is disabled.
Minimum Characters	Set the minimum characters allowed for password.
Password Bypass	When enabled, this always prompts for system and internal hard drive passwords when powered on from the off state. By default, the Disabled option is selected.
Password Changes	
Enable Non-Admin Password Changes	Enable or disable to change system and hard drive password without the need for admin password. By default, the option is enabled.
Admin Setup Lockout	
Enable Admin Setup Lockout	Enables administrators control over how their users can or cannot access BIOS setup. By default, the option is disabled.
Master Password Lockout	
Enable Master Password Lockout	When enabled, this disables the master password support. By default, the option is disabled.
Allow Non-Admin PSID Revert	
Enable Allow Non-Admin PSID Revert	Controls access to the Physical Security ID (PSID) revert of NVMe hard-drives from the Dell Security Manager prompt. By default, the option is disabled.

Table 15. System setup options—Update, Recovery menu

Update, Recovery	
UEFI Capsule Firmware Updates	Enable or disable BIOS updates through UEFI capsule update packages. i NOTE: Disabling this option will block BIOS updates from services such as Microsoft Windows Update and Linux Vendor Firmware Service (LVFS). By default, the option is enabled.
BIOS Recovery from Hard Drive	Enables the user to recover from certain corrupted BIOS conditions from a recovery file on the user primary hard drive or an external USB key. By default, the option is enabled. i NOTE: BIOS Recovery from Hard Drive is not available for self-encrypting drives (SED).
BIOS Downgrade	
Allow BIOS Downgrade	This field controls the flashing of the system firmware to previous revisions. By default, the option is enabled.
SupportAssist OS Recovery	Enable or disable the boot flow for SupportAssist OS Recovery tool in the event of certain system errors. By default, the option is enabled.
BIOSConnect	Enable or disable cloud Service operating system recovery if the main operating system fails to boot with the number of failures equal to or greater than the

Table 15. System setup options—Update, Recovery menu (continued)

Update, Recovery	
	value specified by the Auto operating system Recovery Threshold setup option and local Service operating system does not boot or is not installed. By default, the option is enabled.
Dell Auto operating system Recovery Threshold	Controls the automatic boot flow for SupportAssist System Resolution Console and for Dell operating system Recovery Tool. By default, the threshold value is set to 2.

Table 16. System setup options—System Management menu

System Management	
Service Tag	Displays the Service Tag of the system.
Asset Tag	Create a system Asset Tag.
AC Behavior	
Wake on AC	Enable or disable the wake on AC option. By default, the option is disabled.
Auto on Time	Enable to set the system to turn on automatically every day or on a preselected date and time. This option can be configured only if the Auto On Time is set to Everyday, Weekdays, or Selected Days. By default, the option is disabled.
Intel AMT Capability	
Enable Intel AMT Capability	By default Restrict MEBx Access option is enabled.
MEBx Hotkey	
Enable MEBx Hotkey	When enabled, this allows the use of Ctrl+P hotkey to access MEBx. By default OFF option is disabled.
USB Provision	
Enable USB Provision	Intel AMT can be provisioned using the local provisioning file using a USB storage device. By default OFF option is disabled.

Table 17. System setup options—Keyboard menu

Keyboard	
Numlock Enable	Allows you to enable or disable the Numlock function when the system boots. By default, the option Fn Lock Options is enabled.
Fn Lock Options	By default, the Fn lock option is enabled.
Lock Mode	By default, the Lock Mode Secondary option is enabled. With this option, the F1-F2 keys scan the code for their secondary functions.
Keyboard Illumination	Enables to change the keyboard illumination settings. By default, the Disabled option is enabled.
Keyboard Backlight Timeout on AC	Set the timeout value for the keyboard backlight when an AC adapter is connected to the system. By default, the 10 seconds option is enabled.
Keyboard Backlight Timeout on Battery	Set the timeout value for the keyboard backlight when the is running only on battery power.

Table 17. System setup options—Keyboard menu (continued)

Keyboard	
	By default, the 10 seconds option is enabled.
Device Configuration Hotkey Access	Manages whether you can access device configuration screens through hotkeys during system startup. By default, the option is enabled.

Table 18. System setup options—Pre-boot Behavior menu

Pre-boot Behavior	
Adapter Warnings	
Enable Adapter Warnings	Enable or disable the warning messages during boot when the adapters with less power capacity are detected. By default, the option is enabled.
Warning and Errors	
	Enable or disable the action to be done when a warning or error is encountered. By default, the Prompt on Warnings and Errors option is enabled.
USB-C Warnings	
Enable Dock Warning Messages	By default, the option is enabled.
Fastboot	
	Allows you to configure the speed of the UEFI boot process. By default, the Minimal option is enabled.
Extend BIOS POST Time	
	Set the BIOS POST load time. By default, the 0 seconds option is enabled.
MAC Address Pass-Through	
	Replaces the external NIC MAC address with the selected MAC address from the system. By default, the System Unique MAC Address option is enabled.
Mouse/Touchpad	
	By default, the Touchpad and PS/2 Mouse option is enabled.

Table 19. System setup options—Virtualization menu

Virtualization	
Intel Virtualization Technology	
Enable Intel Virtualization Technology (VT)	When enabled, the system will be able to run a Virtual Machine Monitor (VMM). By default, the option is enabled.
VT for Direct I/O	
	When enabled, the system will be able to perform Virtualization Technology for Direct I/O (VT-d). By default, the option is enabled.
Intel Trusted Execution Technology (TXT)	
Enable Intel Trusted Execution Technology (TXT)	Specifies whether a measured Virtual Machine Monitor (MVMM) can use the additional hardware capabilities that are provided by Intel Trusted Execution Technology. The following must be enabled in order to enable Intel TXT. <ul style="list-style-type: none"> • Trusted Platform Module (TPM) • Intel Hyper-Threading • All CPU cores (Multi-Core Support) • Intel Virtualization Technology • Intel VT for Direct I/O

Table 19. System setup options—Virtualization menu (continued)

Virtualization	
	By default, the option is disabled.

Table 20. System setup options—Performance menu

Performance	
Multi Core Support	
Active Cores	Enables to change the number of CPU cores available to the operating system. By default, the All Cores option is enabled.
Intel SpeedStep	
Enable Intel SpeedStep Technology	Enables the system to dynamically adjust processor voltage and core frequency, decreasing average power consumption and heat production. By default, the option is enabled.
C-States Control	
Enable C-State Control	Enable the ability of the CPU to enter and exit low power state. When disabled, it disabled all C-states. When enabled, it enabled all C-states that the chipset or platform allows. By default, the option is enabled.
Intel Turbo Boost Technology	
Enable Intel Turbo Boost Technology	Enable or disable the Intel TurboBoost mode of the processor. By default, the option is enabled.
Intel Hyper-Threading Technology	
Enable Intel Hyper-Threading Technology	Enable or disable Hyper-Threading in the processor. By default, the option is enabled.
Dynamic Tuning:Machine Learning	
Enable Dynamic Tuning:Machine Learning	Enables the operating system capability to enhance dynamic power tuning capabilities based on detected workloads. By default, the option is disabled.

Table 21. System setup options—System Logs menu

System Logs	
BIOS Event Log	
Clear Bios Event Log	Displays BIOS events. By default, the Keep Log option is enabled.
Thermal Event Log	
Clear Thermal Event Log	Displays Thermal events. By default, the Keep Log option is enabled.
Power Event Log	
Clear Power Event Log	Displays power events. By default, the Keep Log option is enabled.
License Information	Displays the license information of the system.

Updating the BIOS

Updating the BIOS in Windows

About this task

CAUTION: If BitLocker is not suspended before updating the BIOS, the next time you reboot the system it will not recognize the BitLocker key. You will then be prompted to enter the recovery key to progress and the system will ask for this on each reboot. If the recovery key is not known this can result in data loss or an unnecessary operating system re-install. For more information on this subject, search in the Knowledge Base Resource at www.dell.com/support.

Steps

1. Go to www.dell.com/support.
2. Click **Product support**. In the **Search support** box, enter the Service Tag of your computer, and then click **Search**.
NOTE: If you do not have the Service Tag, use the SupportAssist feature to automatically identify your computer. You can also use the product ID or manually browse for your computer model.
3. Click **Drivers & Downloads**. Expand **Find drivers**.
4. Select the operating system installed on your computer.
5. In the **Category** drop-down list, select **BIOS**.
6. Select the latest version of BIOS, and click **Download** to download the BIOS file for your computer.
7. After the download is complete, browse the folder where you saved the BIOS update file.
8. Double-click the BIOS update file icon and follow the on-screen instructions.
For more information, search in the Knowledge Base Resource at www.dell.com/support.

Updating the BIOS in Linux and Ubuntu

To update the system BIOS on a computer that is installed with Linux or Ubuntu, see the knowledge base article [000131486](https://www.dell.com/support/000131486) at www.dell.com/support.

Updating the BIOS using the USB drive in Windows

About this task

CAUTION: If BitLocker is not suspended before updating the BIOS, the next time you reboot the system it will not recognize the BitLocker key. You will then be prompted to enter the recovery key to progress and the system will ask for this on each reboot. If the recovery key is not known this can result in data loss or an unnecessary operating system re-install. For more information on this subject, search in the Knowledge Base Resource at www.dell.com/support.

Steps

1. Follow the procedure from step 1 to step 6 in [Updating the BIOS in Windows](#) to download the latest BIOS setup program file.
2. Create a bootable USB drive. For more information, search in the Knowledge Base Resource at www.dell.com/support.
3. Copy the BIOS setup program file to the bootable USB drive.
4. Connect the bootable USB drive to the computer that needs the BIOS update.
5. Restart the computer and press **F12**.
6. Select the USB drive from the **One Time Boot Menu**.
7. Type the BIOS setup program filename and press **Enter**.
The **BIOS Update Utility** appears.
8. Follow the on-screen instructions to complete the BIOS update.

Updating the BIOS from the F12 One-Time boot menu

Update your computer BIOS using the BIOS update.exe file that is copied to a FAT32 USB drive and booting from the F12 One-Time boot menu.

About this task

CAUTION: If BitLocker is not suspended before updating the BIOS, the next time you reboot the system it will not recognize the BitLocker key. You will then be prompted to enter the recovery key to progress and the system will ask for this on each reboot. If the recovery key is not known this can result in data loss or an unnecessary operating system re-install. For more information on this subject, search in the Knowledge Base Resource at www.dell.com/support.

BIOS Update

You can run the BIOS update file from Windows using a bootable USB drive or you can also update the BIOS from the F12 One-Time boot menu on the computer.

Most of the Dell computers built after 2012 have this capability, and you can confirm by booting your computer to the F12 One-Time Boot Menu to see if BIOS FLASH UPDATE is listed as a boot option for your computer. If the option is listed, then the BIOS supports this BIOS update option.

NOTE: Only computers with BIOS Flash Update option in the F12 One-Time boot menu can use this function.

Updating from the One-Time boot menu

To update your BIOS from the F12 One-Time boot menu, you need the following:

- USB drive formatted to the FAT32 file system (key does not have to be bootable)
- BIOS executable file that you downloaded from the Dell Support website and copied to the root of the USB drive
- AC power adapter that is connected to the computer
- Functional computer battery to flash the BIOS

Perform the following steps to perform the BIOS update flash process from the F12 menu:

CAUTION: Do not turn off the computer during the BIOS update process. The computer may not boot if you turn off your computer.

Steps

1. From a turn off state, insert the USB drive where you copied the flash into a USB port of the computer.
2. Turn on the computer and press F12 to access the One-Time Boot Menu, select BIOS Update using the mouse or arrow keys then press Enter.
The flash BIOS menu is displayed.
3. Click **Flash from file**.
4. Select external USB device.
5. Select the file and double-click the flash target file, and then click **Submit**.
6. Click **Update BIOS**. The computer restarts to flash the BIOS.
7. The computer will restart after the BIOS update is completed.

System and setup password

Table 22. System and setup password

Password type	Description
System password	Password that you must enter to log in to your system.
Setup password	Password that you must enter to access and make changes to the BIOS settings of your computer.

You can create a system password and a setup password to secure your computer.

 **CAUTION:** The password features provide a basic level of security for the data on your computer.

 **CAUTION:** Anyone can access the data that is stored on your computer if it is not locked and left unattended.

 **NOTE:** System and setup password feature is disabled.

Assigning a system setup password

Prerequisites

You can assign a new **System or Admin Password** only when the status is in **Not Set**.

About this task

To enter the system setup, press F12 immediately after a power-on or reboot.

Steps

1. In the **System BIOS** or **System Setup** screen, select **Security** and press Enter.
The **Security** screen is displayed.
2. Select **System/Admin Password** and create a password in the **Enter the new password** field.
Use the following guidelines to assign the system password:
 - A password can have up to 32 characters.
 - At least one special character: ! " # \$ % & ' () * + , - . / : ; < = > ? @ [\] ^ _ ` { | }
 - Numbers 0 through 9.
 - Upper case letters from A to Z.
 - Lower case letters from a to z.
3. Type the system password that you entered earlier in the **Confirm new password** field and click **OK**.
4. Press Esc and save the changes as prompted by the pop-up message.
5. Press Y to save the changes.
The computer restarts.

Deleting or changing an existing system setup password

Prerequisites

Ensure that the **Password Status** is Unlocked (in the System Setup) before attempting to delete or change the existing System and/or Setup password. You cannot delete or change an existing System or Setup password, if the **Password Status** is Locked.

About this task

To enter the System Setup, press F12 immediately after a power-on or reboot.

Steps

1. In the **System BIOS** or **System Setup** screen, select **System Security** and press Enter.
The **System Security** screen is displayed.
2. In the **System Security** screen, verify that **Password Status** is **Unlocked**.
3. Select **System Password**, update, or delete the existing system password, and press Enter or Tab.
4. Select **Setup Password**, update, or delete the existing setup password, and press Enter or Tab.
 **NOTE:** If you change the System and/or Setup password, reenter the new password when prompted. If you delete the System and/or Setup password, confirm the deletion when prompted.
5. Press Esc and a message prompts you to save the changes.
6. Press Y to save the changes and exit from System Setup.
The computer restarts.

Clearing BIOS (System Setup) and System passwords

About this task

To clear the system or BIOS passwords, contact Dell technical support as described at www.dell.com/contactdell.

NOTE: For information on how to reset Windows or application passwords, refer to the documentation accompanying Windows or your application.

Clearing chassis intrusion alert

The computer features a chassis intrusion switch which is able to detect any time the base cover has been removed from the system. Alerts to notify you of any intrusions can be enabled through the **Chassis Intrusion** option in the **Security** menu of the BIOS setup.

When the **Chassis Intrusion** option is enabled, the **Block Boot Until Cleared** option allows you to choose whether to prevent normal boot up of the computer until the intrusion alert is cleared.

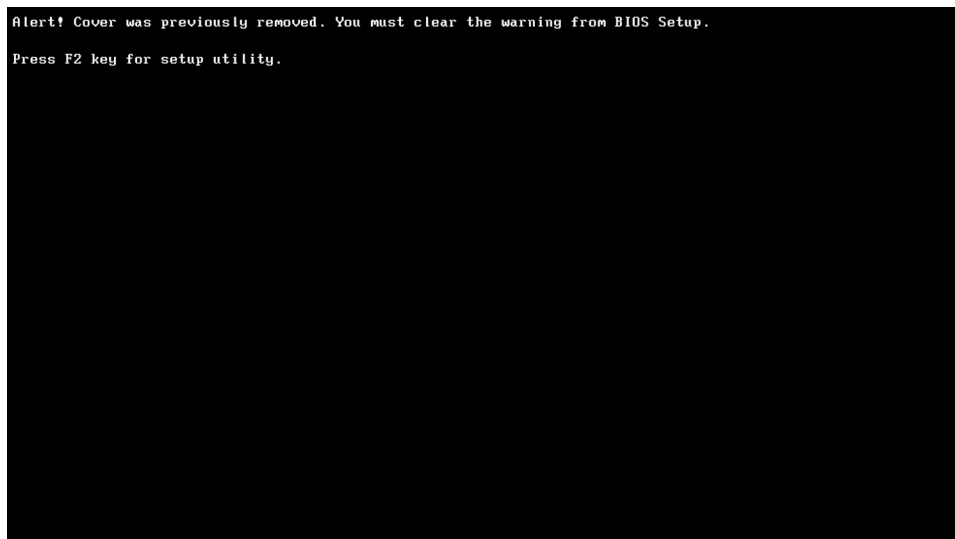
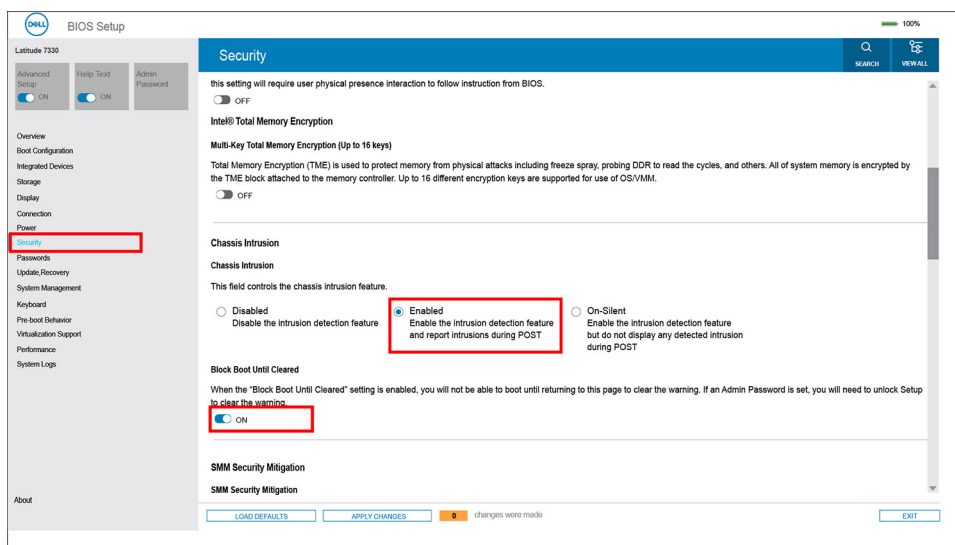

If **Block Boot Until Cleared** option is set to **OFF**, select **Continue** to boot up normally or **BIOS-Setup** to clear the alert.

NOTE: If the **Continue** option is selected, you will continue to see the alert each time the computer is powered on until the alert is cleared.

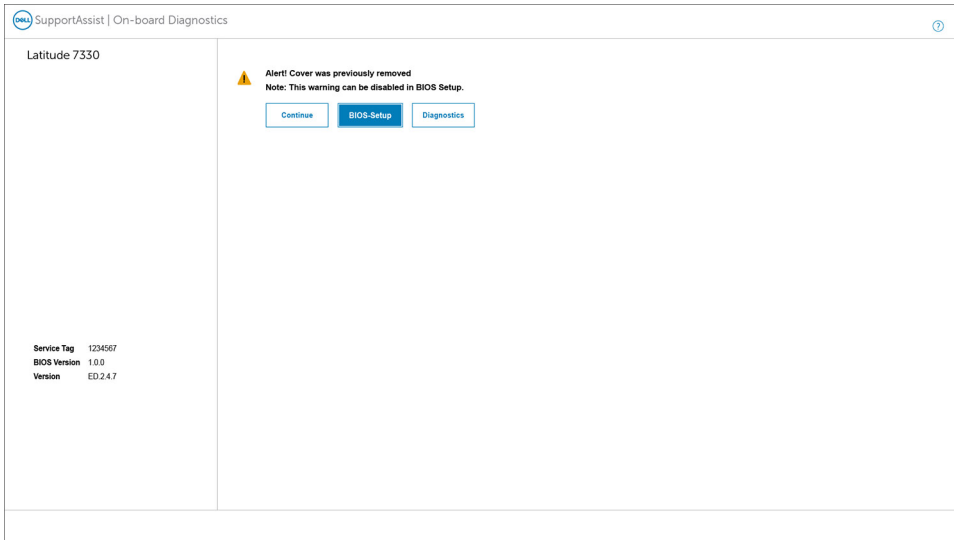

To clear the alert, set the **Clear Intrusion Warning** to **ON** in the **Security** menu of the BIOS setup.

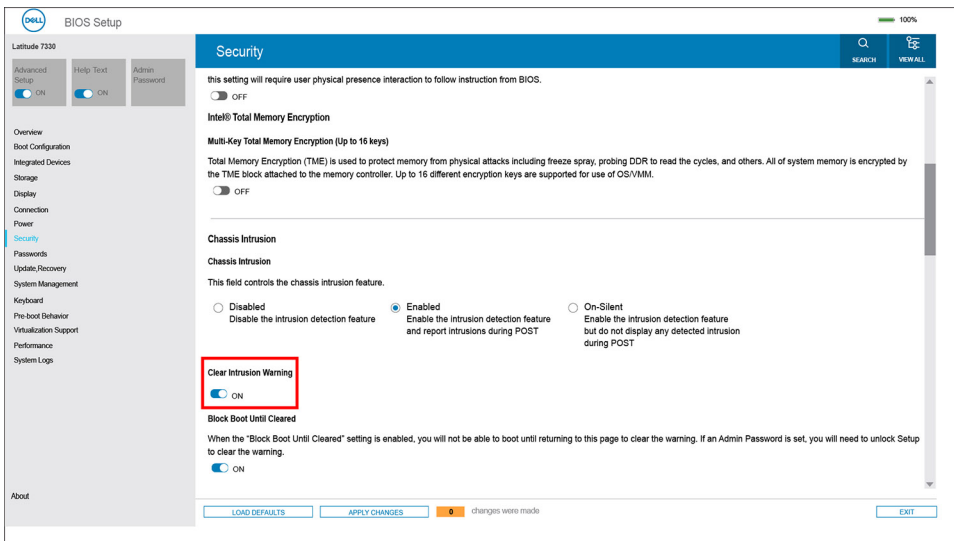

Troubleshooting

Handling swollen Lithium-ion batteries

Like most laptops, Dell laptops use lithium-ion batteries. One type of lithium-ion battery is the lithium-ion polymer battery. Lithium-ion polymer batteries have increased in popularity in recent years and have become standard in the electronics industry due to customer preferences for a slim form factor (especially with newer ultra-thin laptops) and long battery life. Inherent to lithium-ion polymer battery technology is the potential for swelling of the battery cells.

Swollen battery may impact the performance of the laptop. To prevent possible further damage to the device enclosure or internal components leading to malfunction, discontinue the use of the laptop and discharge it by disconnecting the AC adapter and letting the battery drain.

Swollen batteries should not be used and should be replaced and disposed of properly. We recommend contacting Dell product support for options to replace a swollen battery under the terms of the applicable warranty or service contract, including options for replacement by a Dell authorized service technician.

The guidelines for handling and replacing Lithium-ion batteries are as follows:

- Exercise caution when handling Lithium-ion batteries.
- Discharge the battery before removing it from the system. To discharge the battery, unplug the AC adapter from the system and operate the system only on battery power. When the system will no longer power on when the power button is pressed, the battery is fully discharged.
- Do not crush, drop, mutilate, or penetrate the battery with foreign objects.
- Do not expose the battery to high temperatures, or disassemble battery packs and cells.
- Do not apply pressure to the surface of the battery.
- Do not bend the battery.
- Do not use tools of any type to pry on or against the battery.
- If a battery gets stuck in a device as a result of swelling, do not try to free it as puncturing, bending, or crushing a battery can be dangerous.
- Do not attempt to reassemble a damaged or swollen battery into a laptop.
- Swollen batteries that are covered under warranty should be returned to Dell in an approved shipping container (provided by Dell)—this is to comply with transportation regulations. Swollen batteries that are not covered under warranty should be disposed of at an approved recycling center. Contact Dell product support at <https://www.dell.com/support> for assistance and further instructions.
- Using a non-Dell or incompatible battery may increase the risk of fire or explosion. Replace the battery only with a compatible battery purchased from Dell that is designed to work with your Dell computer. Do not use a battery from other computers with your computer. Always purchase genuine batteries from <https://www.dell.com> or otherwise directly from Dell.

Lithium-ion batteries can swell for various reasons such as age, number of charge cycles, or exposure to high heat. For more information on how to improve the performance and lifespan of the laptop battery and to minimize the possibility of occurrence of the issue, search Dell Laptop Battery in the Knowledge Base Resource at www.dell.com/support.

Dell SupportAssist Pre-boot System Performance Check diagnostics

About this task

SupportAssist diagnostics (also known as system diagnostics) performs a complete check of your hardware. The Dell SupportAssist Pre-boot System Performance Check diagnostics is embedded with the BIOS and is launched by the BIOS internally. The embedded system diagnostics provides a set of options for particular devices or device groups allowing you to:

- Run tests automatically or in an interactive mode
- Repeat tests
- Display or save test results

- Run thorough tests to introduce additional test options to provide extra information about the failed device(s)
- View status messages that inform you if tests are completed successfully
- View error messages that inform you of problems encountered during testing

NOTE: Some tests for specific devices require user interaction. Always ensure that you are present at the computer terminal when the diagnostic tests are performed.

For more information, see <https://www.dell.com/support/kbdoc/000180971>.

Running the SupportAssist Pre-Boot System Performance Check

Steps

1. Turn on your computer.
2. As the computer boots, press the F12 key as the Dell logo appears.
3. On the boot menu screen, select the **Diagnostics** option.
4. Click the arrow at the bottom left corner.
Diagnostics front page is displayed.
5. Click the arrow in the lower-right corner to go to the page listing.
The items detected are listed.
6. To run a diagnostic test on a specific device, press Esc and click **Yes** to stop the diagnostic test.
7. Select the device from the left pane and click **Run Tests**.
8. If there are any issues, error codes are displayed.
Note the error code and validation number and contact Dell.

Built-in self-test (BIST)

M-BIST

M-BIST (Built In Self-Test) is the system board's built-in self-test diagnostics tool that improves the diagnostics accuracy of system board embedded controller (EC) failures.

NOTE: M-BIST can be manually initiated before POST (Power On Self Test).

How to run M-BIST

NOTE: M-BIST must be initiated on the system from a power-off state either connected to AC power or with battery only.

1. Press and hold both the **M** key on the keyboard and the **power button** to initiate M-BIST.
2. With both the **M** key and the **power button** held down, the battery indicator LED may exhibit two states:
 - a. OFF: No fault detected with the system board
 - b. AMBER: Indicates a problem with the system board
3. If there is a failure with the system board, the battery status LED will flash one of the following error codes for 30 seconds:

Table 23. LED error codes

Blinking Pattern		Possible Problem
Amber	White	
2	1	CPU Failure
2	8	LCD Power Rail Failure
1	1	TPM Detection Failure
2	4	Unrecoverable SPI Failure

4. If there is no failure with the system board, the LCD will cycle through the solid color screens described in the LCD-BIST section for 30 seconds and then power off.

LCD Power rail test (L-BIST)

L-BIST is an enhancement to the single LED error code diagnostics and is automatically initiated during POST. L-BIST will check the LCD power rail. If there is no power being supplied to the LCD (i.e., the L-BIST circuit fails), the battery status LED will flash either an error code [2,8] or an error code [2,7].

NOTE: If L-BIST fails, LCD-BIST cannot function as no power will be supplied to the LCD.

How to invoke L-BIST Test:

1. Press the power button to start the system.
2. If the system does not start up normally, look at the battery status LED:
 - If the battery status LED flashes an error code [2,7], the display cable may not be connected properly.
 - If the battery status LED flashes an error code [2,8], there is a failure on the LCD power rail of the system board, hence there is no power supplied to the LCD.
3. For cases, when a [2,7] error code is shown, check to see if the display cable is properly connected.
4. For cases when a [2,8] error code is shown, replace the system board.

LCD Built-in Self Test (BIST)

Dell laptops have a built-in diagnostic tool that helps you determine if the screen abnormality you are experiencing is an inherent problem with the LCD (screen) of the Dell laptop or with the video card (GPU) and PC settings.

When you notice screen abnormalities like flickering, distortion, clarity issues, fuzzy or blurry image, horizontal or vertical lines, color fade etc., it is always a good practice to isolate the LCD (screen) by running the Built-In Self Test (BIST).

How to invoke LCD BIST Test

1. Power off the Dell laptop.
2. Disconnect any peripherals that are connected to the laptop. Connect only the AC adapter (charger) to the laptop.
3. Ensure that the LCD (screen) is clean (no dust particles on the surface of the screen).
4. Press and hold **D** key and **Power on** the laptop to enter LCD built-in self test (BIST) mode. Continue to hold the D key, until the system boots up.
5. The screen will display solid colors and change colors on the entire screen to white, black, red, green, and blue twice.
6. Then it will display the colors white, black and red.
7. Carefully inspect the screen for abnormalities (any lines, fuzzy color or distortion on the screen).
8. At the end of the last solid color (red), the system will shut down.

NOTE: Dell SupportAssist Pre-boot diagnostics upon launch, initiates an LCD BIST first, expecting a user intervention confirm functionality of the LCD.

System-diagnostic lights

This section lists the system-diagnostic lights of your Latitude 7430.

Table 24. System-diagnostic lights

Blinking pattern		Problem description	Suggested resolution
Amber	White		
1	1	TPM detection failure	Replace the system board.
1	2	Unrecoverable SPI Flash Failure	Replace the system board.
1	5	EC unable to program i-Fuse	Replace the system board.

Table 24. System-diagnostic lights (continued)

Blinking pattern		Problem description	Suggested resolution
Amber	White		
1	6	Generic catch-all for ungraceful EC code flow errors	Disconnect all power source (AC, battery, coin cell) and drain flea power by pressing and holding down power button for 3-5 seconds.
2	1	CPU failure	<ul style="list-style-type: none"> • Run the Dell Support Assist/Dell Diagnostics tool. • If problem persists, replace the system board.
2	2	System board failure (included BIOS corruption or ROM error)	<ul style="list-style-type: none"> • Flash latest BIOS version • If problem persists, replace the system board.
2	3	No memory/RAM detected	<ul style="list-style-type: none"> • Confirm that the memory module is installed properly. • If problem persists, replace the memory module.
2	4	Memory/RAM failure	<ul style="list-style-type: none"> • Reset and swap memory modules among the slots. • If problem persists, replace the memory module.
2	5	Invalid memory installed	<ul style="list-style-type: none"> • Reset and swap memory modules among the slots. • If problem persists, replace the memory module.
2	6	System board/Chipset Error	Replace the system board.
2	7	LCD failure (SBIOS message)	Replace the LCD module.
2	8	LCD failure (EC detection of power rail failure)	Replace the system board.
3	1	CMOS battery failure	<ul style="list-style-type: none"> • Reset the main battery connection. • If problem persists, replace the main battery.
3	2	PCI or Video card/chip failure	Replace the system board.
3	3	BIOS Recovery image not found	<ul style="list-style-type: none"> • Flash latest BIOS version • If problem persists, replace the system board.
3	4	BIOS Recovery image found but invalid	<ul style="list-style-type: none"> • Flash latest BIOS version • If problem persists, replace the system board.

Table 24. System-diagnostic lights (continued)

Blinking pattern		Problem description	Suggested resolution
Amber	White		
3	5	Power rail failure	Replace the system board.
3	6	Flash corruption detected by SBIOS.	<ul style="list-style-type: none"> Press power button for over 25 seconds to do RTC reset. If problem persists, replace the system board. Disconnect all power source (AC, battery, coin cell) and drain flea power by pressing and holding down power button 3-5 seconds to ensure all power are drained. Run "BIOS recovery from USB", and the instructions are in the website Dell support. If problem persists, replace the system board.
3	7	Timeout waiting on ME to reply to HECI message.	Replace the system board.

NOTE: Blinking 3-3-3 LEDs on Lock LED (Caps-Lock or Num-Lock), Power button LED (without Fingerprint reader), and Diagnostic LED indicates failure to provide input during LCD panel test on Dell SupportAssist Pre-boot System Performance Check diagnostics.

Recovering the operating system

When your computer is unable to boot to the operating system even after repeated attempts, it automatically starts Dell SupportAssist OS Recovery.

Dell SupportAssist OS Recovery is a standalone tool that is preinstalled in all Dell computers installed with Windows operating system. It consists of tools to diagnose and troubleshoot issues that may occur before your computer boots to the operating system. It enables you to diagnose hardware issues, repair your computer, back up your files, or restore your computer to its factory state.

You can also download it from the Dell Support website to troubleshoot and fix your computer when it fails to boot into their primary operating system due to software or hardware failures.

For more information about the Dell SupportAssist OS Recovery, see *Dell SupportAssist OS Recovery User's Guide* at www.dell.com/serviceabilitytools. Click **SupportAssist** and then, click **SupportAssist OS Recovery**.

Real-Time Clock (RTC Reset)

The Real Time Clock (RTC) reset function allows you or the service technician to recover Dell systems from No POST/No Power/No Boot situations. The legacy jumper enabled RTC reset has been retired on these models.

Start the RTC reset with the system powered off and connected to AC power. Press and hold the power button for thirty (30) seconds

. The system RTC Reset occurs after you release the power button.

Backup media and recovery options

It is recommended to create a recovery drive to troubleshoot and fix problems that may occur with Windows. Dell proposes multiple options for recovering Windows operating system on your Dell PC. For more information, see [Dell Windows Backup Media and Recovery Options](#).

WiFi power cycle

About this task

If your computer is unable to access the internet due to WiFi connectivity issues a WiFi power cycle procedure may be performed. The following procedure provides the instructions on how to conduct a WiFi power cycle:

 **NOTE:** Some ISPs (Internet Service Providers) provide a modem/router combo device.

Steps

1. Turn off your computer.
2. Turn off the modem.
3. Turn off the wireless router.
4. Wait for 30 seconds.
5. Turn on the wireless router.
6. Turn on the modem.
7. Turn on your computer.

Drain residual flea power (perform hard reset)

About this task

Flea power is the residual static electricity that remains in the computer even after it has been powered off and the battery is removed.

For your safety, and to protect the sensitive electronic components in your computer, you are requested to drain residual flea power before removing or replacing any components in your computer.

Draining residual flea power, also known as a performing a "hard reset", is also a common troubleshooting step if your computer does not power on or boot into the operating system.

To drain residual flea power (perform a hard reset)

Steps

1. Turn off your computer.
2. Disconnect the power adapter from your computer.
3. Remove the base cover.
4. Remove the battery.
5. Press and hold the power button for 20 seconds to drain the flea power.
6. Install the battery.
7. Install the base cover.
8. Connect the power adapter to your computer.
9. Turn on your computer.



 **NOTE:** For more information about performing a hard reset, search in the Knowledge Base Resource at www.dell.com/support.

Getting help and contacting Dell

Self-help resources

You can get information and help on Dell products and services using these self-help resources:

Table 25. Self-help resources

Self-help resources	Resource location
Information about Dell products and services	www.dell.com
My Dell app	
Tips	
Contact Support	In Windows search, type <code>Contact Support</code> , and press Enter.
Online help for operating system	www.dell.com/support/windows www.dell.com/support/linux
Access top solutions, diagnostics, drivers and downloads, and learn more about your computer through videos, manuals and documents.	Your Dell computer is uniquely identified by a Service Tag or Express Service Code. To view relevant support resources for your Dell computer, enter the Service Tag or Express Service Code at www.dell.com/support . For more information on how to find the Service Tag for your computer, see Locate the Service Tag on your computer .
Dell knowledge base articles for a variety of computer concerns	<ol style="list-style-type: none"> 1. Go to www.dell.com/support. 2. On the menu bar at the top of the Support page, select Support > Knowledge Base. 3. In the Search field on the Knowledge Base page, type the keyword, topic, or model number, and then click or tap the search icon to view the related articles.

Contacting Dell

To contact Dell for sales, technical support, or customer service issues, see www.dell.com/contactdell.

 **NOTE:** Availability varies by country/region and product, and some services may not be available in your country/region.

 **NOTE:** If you do not have an active Internet connection, you can find contact information about your purchase invoice, packing slip, bill, or Dell product catalog.