

# Dell Host Bus Adapter User's Guide

HBA 355 and 350 Series

## Notes, cautions, and warnings

 **NOTE:** A NOTE indicates important information that helps you make better use of your product.

 **CAUTION:** A CAUTION indicates either potential damage to hardware or loss of data and tells you how to avoid the problem.

 **WARNING:** A WARNING indicates a potential for property damage, personal injury, or death.

<b>Chapter 1: Dell HBA355i Adapter, Dell HBA355i Front, Dell HBA355e Adapter, Dell HBA350i MX, Dell HBA350i Adapter, and Dell HBA350i MM.....</b>	<b>6</b>
Dell HBA355i Adapter.....	7
Dell HBA355i Front.....	7
Dell HBA355e Adapter .....	8
Dell HBA350i MX.....	8
Dell HBA350i Adapter.....	9
Dell HBA350i MM.....	9
Dell HBA355i Adapter, Dell HBA355i Front, Dell HBA355e Adapter, Dell HBA350i MX, Dell HBA350i Adapter, and Dell HBA350i MM technical specifications.....	9
PowerEdge systems supported by Dell HBA355i Adapter.....	10
PowerEdge systems supported by Dell HBA355i Front.....	10
PowerEdge systems supported by Dell HBA355e Adapter.....	11
PowerEdge systems supported by Dell HBA350i MX.....	12
PowerEdge systems supported by Dell HBA350i Adapter.....	12
PowerEdge systems supported by Dell HBA350i MM.....	12
Operating systems supported by Dell HBA355i Adapter cards.....	13
MD1400 and MD1420 enclosure support for Dell HBA355e Adapter.....	13
Port support matrix for dual path on the MD1400 and MD1420 enclosures.....	13
ME484 enclosure support for Dell HBA355e Adapter.....	14
Port support matrix for dual path on the ME484 enclosure.....	14
<b>MD24xx enclosure supported by Dell HBA355e Adapter .....</b>	<b>14</b>
<b>Supported Cable Configurations .....</b>	<b>15</b>
External tape drive support for Dell HBA355e Adapter.....	15
Internal tape drive support for Dell HBA355i Adapter and Dell HBA350i Adapter.....	15
 <b>Chapter 2: Applications supported by Dell HBA355i Adapter, Dell HBA355i Front, Dell HBA355e Adapter, Dell HBA350i MX, Dell HBA350i Adapter, and Dell HBA350i MM.....</b>	 <b>16</b>
Human Interface Infrastructure Configuration Utility.....	16
Dell OpenManage Storage Management.....	16
The Integrated Dell Remote Access Controller and Lifecycle Controller.....	16
The Command Line Interface.....	16
 <b>Chapter 3: Multipath support on Dell HBA355e Adapter.....</b>	 <b>17</b>
Dell HBA multipathing using HII.....	17
Dell HBA multipathing using Windows.....	17
Dell HBA multipathing using iDRAC.....	18
Dell HBA multipathing using Linux.....	18
Dell HBA multipathing using VMware.....	18
 <b>Chapter 4: Features of Dell HBA355i Adapter, Dell HBA355i Front, Dell HBA355e Adapter, Dell HBA350i MX, Dell HBA350i Adapter, and Dell HBA350i MM.....</b>	 <b>19</b>
Hardware Root of Trust.....	19
No RAID support.....	19

Event management support for Dell HBA355i Adapter, Dell HBA355i Front, Dell HBA355e Adapter, Dell HBA350i MX, Dell HBA350i Adapter, and Dell HBA350i MM .....	19
LED activity.....	20

**Chapter 5: Installation and removal of cards ..... 21**

Safety instructions.....	21
Before working inside your system.....	22
Remove the Dell HBA355i Adapter .....	22
Install the Dell HBA355i Adapter.....	23
Remove the Dell HBA355i Front.....	24
Install the Dell HBA355i Front.....	25
Remove the Dell HBA355e Adapter.....	26
Install the Dell HBA355e Adapter.....	27
Connect the Dell HBA355e Adapter to the storage enclosure.....	28
Connect an HBA355e adapter to MD24xx enclosures.....	30
Remove the Dell HBA350i MX.....	31
Install the Dell HBA350i MX.....	32
Remove the Dell HBA350i Adapter .....	33
Install the Dell HBA350i Adapter.....	34
Remove Dell HBA350i MM .....	35
Install the HBA350i MM.....	37

**Chapter 6: Driver support for Dell HBA355i Adapter, Dell HBA355i Front, Dell HBA355e Adapter, Dell HBA350i MX, Dell HBA350i Adapter, and Dell HBA350i MM..... 39**

Creating the device driver media.....	39
Download and save Dell HBA355i Adapter, Dell HBA355i Front, Dell HBA355e Adapter, Dell HBA350i MX, Dell HBA350i Adapter, and Dell HBA350i MM drivers from the support site.....	39
Download and save Dell HBA355i Adapter, Dell HBA355i Front, Dell HBA355e Adapter, Dell HBA350i MX, Dell HBA350i Adapter, and Dell HBA350i MM drivers from the Dell Systems Service and Diagnostic Tools .....	40
Windows driver installation.....	40
Install Dell HBA355i Adapter, Dell HBA355i Front, Dell HBA355e Adapter, Dell HBA350i MX, Dell HBA350i Adapter, and Dell HBA350i MM drivers while newly installing the Windows Server 2016 or later.....	40
Install Dell HBA355i Adapter, Dell HBA355i Front, Dell HBA355e Adapter, Dell HBA350i MX, Dell HBA350i Adapter, and Dell HBA350i MM, driver on which the Windows Server 2016 or later is already installed .....	41
Update Dell HBA355i Adapter, Dell HBA355i Front, Dell HBA355e Adapter, Dell HBA350i MX, Dell HBA350i Adapter, and Dell HBA350i MM driver that runs on Windows Server 2016 or later.....	41
Linux driver installation.....	42
Install or update a RPM driver package using the KMOD support.....	42
Install or update a RPM driver package using the KMP support.....	42
Load the driver while installing an operating system.....	43

**Chapter 7: Manage Dell HBA355i Adapter, Dell HBA355i Front, Dell HBA355e Adapter, Dell HBA350i MX, Dell HBA350i Adapter, and Dell HBA350i MM using HII configuration utility..... 45**

Enter the HII configuration utility.....	45
Exit the HII configuration utility.....	46
Navigate to the configuration utility.....	46
Controller management .....	46
View the controller properties.....	46

Refresh the topology.....	47
Device Properties.....	47
<b>Chapter 8: Update the firmware of Dell HBA355i Adapter, Dell HBA355i Front, Dell HBA355e Adapter, Dell HBA350i MX, Dell HBA350i Adapter, and Dell HBA350i MM using DUP.....</b>	<b>49</b>
Upgrade firmware controller using Dell Update Package (DUP).....	49
<b>Chapter 9: Getting help.....</b>	<b>50</b>
Recycling or End-of-Life service information.....	50
Contacting Dell.....	50
Receiving automated support with SupportAssist .....	50
<b>Chapter 10: Troubleshooting.....</b>	<b>52</b>
Known issues.....	52
The Enclosure ID (EID) or Device ID (DID) may change after a restart .....	52
VendorID and ProductID for external tape drives.....	52
VendorID and ProductID for internal tape drives.....	52
System reserved partition after Windows installation.....	52
Device settings in HII shows PCIe slot information .....	53
Select drive for operating system installation in legacy mode.....	53
Adapter configuration change message.....	53
Firmware upgrade or downgrade from DUP is not supported on Ubuntu.....	53
<b>Chapter 11: Documentation resources.....</b>	<b>54</b>

# Dell HBA355i Adapter, Dell HBA355i Front, Dell HBA355e Adapter, Dell HBA350i MX, Dell HBA350i Adapter, and Dell HBA350i MM

Dell Host Bus Adapter 355i (Dell HBA355i Adapter), Dell Host Bus Adapter 355i Front (Dell HBA355i Front), Dell Host Bus Adapter 350i MX (Dell HBA350i MX), and Dell Host Bus Adapter 350i (Dell HBA350i Adapter), Dell Host Bus Adapter 350i Mini Monolithic (Dell HBA350i MM) are non-RAID solution cards that can be used as a boot controller and also as a data controller.

Dell Host Bus Adapter 355e (Dell HBA355e Adapter) is a non-RAID solution card that is used as a data controller by connecting to external JBODs and tape drives.

The features of the cards include:

- All are PCIe cards with Gen 4 PCIe x eight host interfaces.
- All provide dual SAS/SATA Gen 3 device interfaces.
- Each supports both SAS and SATA drives.
- HBA355i Adapter and HBA355i Front have x16 SAS lanes for a target device and can support up to 16 drives without expander.
- HBA350i Adapter has x8 SAS lanes for a target device and can support up to eight drives without expander.
- HBA350i MX has x8 lanes and supports up to only eight drives without expander.
- HBA355e has x16 lanes that can be connected to external target devices such as enclosures (ME484, MD1420, and MD1400) and tape drives (LTO 6/7/8/9).
- HBA350i MM has x8 SAS lanes for a target device and can support up to eight drives without expander.

**i NOTE:** For the safety, regulatory, and ergonomic information that is associated with these devices, and for more information about the Integrated Dell Remote Access Controller (iDRAC) or Lifecycle Controller (LC) remote management, see your platform documentation.

**i NOTE:** Dell HBA350i MM has form factor variations (Low Profile) for specific platforms, for further information refer to your platform manuals.  
information refer to your platform manuals.

## Topics:

- [Dell HBA355i Adapter](#)
- [Dell HBA355i Front](#)
- [Dell HBA355e Adapter](#)
- [Dell HBA350i MX](#)
- [Dell HBA350i Adapter](#)
- [Dell HBA350i MM](#)
- [Dell HBA355i Adapter, Dell HBA355i Front, Dell HBA355e Adapter, Dell HBA350i MX, Dell HBA350i Adapter, and Dell HBA350i MM technical specifications](#)
- [PowerEdge systems supported by Dell HBA355i Adapter](#)
- [PowerEdge systems supported by Dell HBA355i Front](#)
- [PowerEdge systems supported by Dell HBA355e Adapter](#)
- [PowerEdge systems supported by Dell HBA350i MX](#)
- [PowerEdge systems supported by Dell HBA350i Adapter](#)
- [PowerEdge systems supported by Dell HBA350i MM](#)
- [Operating systems supported by Dell HBA355i Adapter cards](#)
- [MD1400 and MD1420 enclosure support for Dell HBA355e Adapter](#)
- [Port support matrix for dual path on the MD1400 and MD1420 enclosures](#)
- [ME484 enclosure support for Dell HBA355e Adapter](#)
- [Port support matrix for dual path on the ME484 enclosure](#)

- MD24xx enclosure supported by Dell HBA355e Adapter
- Supported Cable Configurations
- External tape drive support for Dell HBA355e Adapter
- Internal tape drive support for Dell HBA355i Adapter and Dell HBA350i Adapter

## Dell HBA355i Adapter

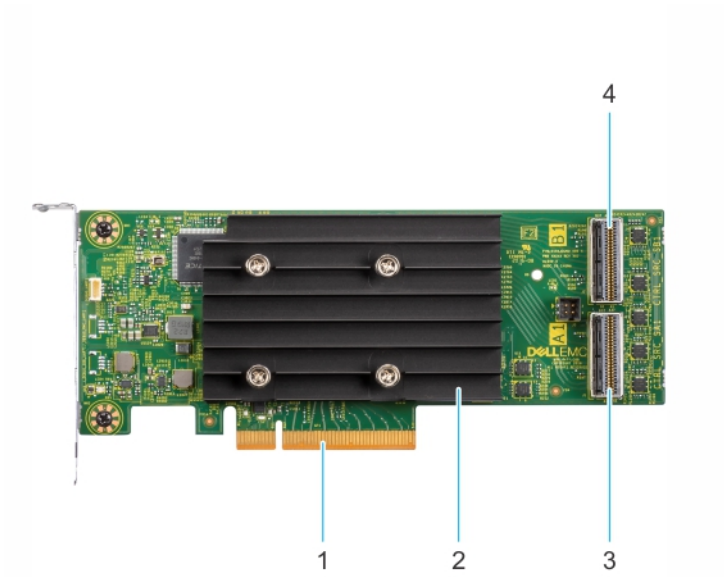

**Figure 1. HBA355i Adapter**

- |                                 |                                   |
|---------------------------------|-----------------------------------|
| 1. PCIe connector               | 2. Heatsink                       |
| 3. Primary SAS connector port A | 4. Secondary SAS connector port B |

## Dell HBA355i Front

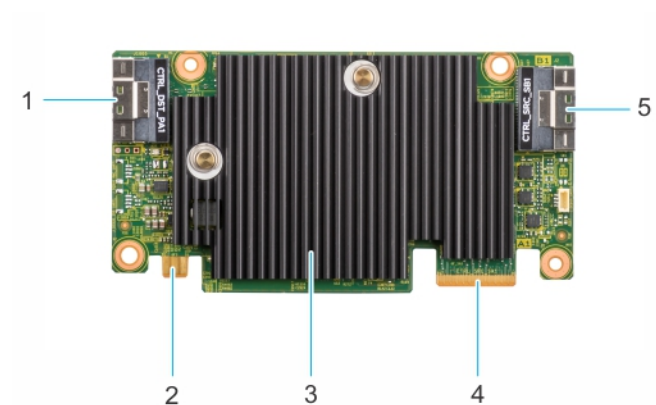

**Figure 2. Dell HBA355i Front**

- |                                   |                                 |
|-----------------------------------|---------------------------------|
| 1. PCIe connector                 | 2. Power connector              |
| 3. Heatsink                       | 4. Primary SAS connector port A |
| 5. Secondary SAS connector port B |                                 |

## Dell HBA355e Adapter

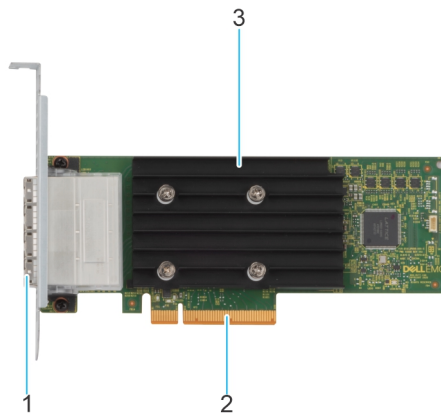

**Figure 3. Dell HBA355e Adapter**

1. External SAS ports (port 0, port 1, port 2, and port 3)
2. PCIe connector
3. Heatsink

## Dell HBA350i MX

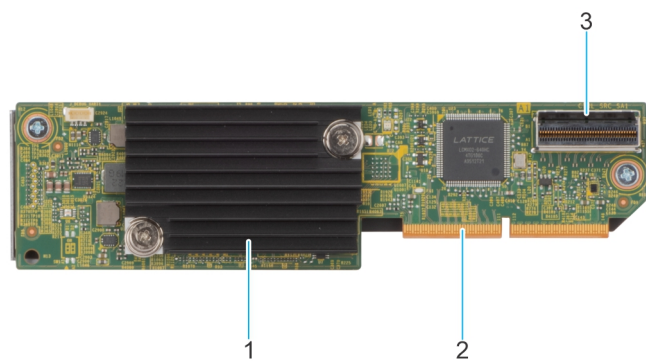
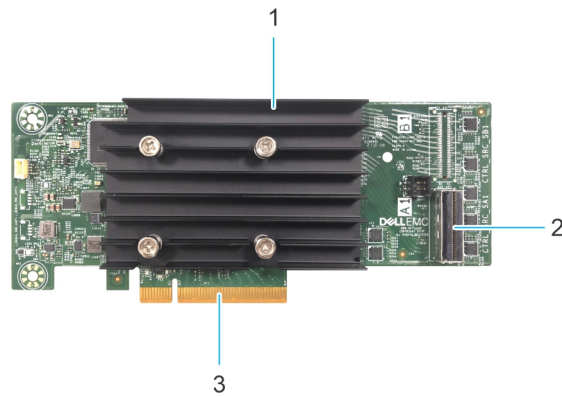

**Figure 4. Features of Dell HBA350i MX**

1. Heatsink
2. PCIe connector
3. SAS connector port A



# Dell HBA350i Adapter



**Figure 5. Dell HBA350i Adapter**

- 1. Heat Sink
- 2. SAS connector port
- 3. PCIe connector

# Dell HBA350i MM

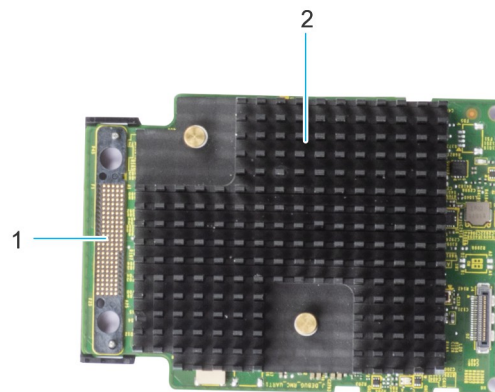

**Figure 6. Dell HBA350i MM**

- 1. SAS cable connection
- 2. Heat sink

# Dell HBA355i Adapter, Dell HBA355i Front, Dell HBA355e Adapter, Dell HBA350i MX, Dell

# HBA350i Adapter, and Dell HBA350i MM technical specifications

The following table describes the card specifications of HBA355i Adapter, HBA355i Front, HBA350i MX, HBA355e Adapter, HBA350i Adapter, and HBA350i MM:

**Table 1. Dell HBA355i Adapter, Dell HBA355i Front, Dell HBA355e Adapter, Dell HBA350i MX, Dell HBA350i Adapter, and Dell HBA350i MM specifications**

Feature	Dell HBA355i Adapter and Dell HBA355i Front	Dell HBA355e Adapter	Dell HBA350i MX	Dell HBA350i Adapter	Dell HBA350i MM
Processor	LSI Fusion-MPT 12 G SAS/PCle Secure SAS3816	LSI Fusion-MPT 12 G SAS/PCle Secure SAS3816	LSI Fusion-MPT 12 G SAS/PCle Secure SAS3808	LSI Fusion-MPT 12 G SAS/PCle Secure SAS3816	LSI Fusion-MPT 12 G SAS/PCle Secure SAS3816
Drive types	SAS, SATA, tape drives	SAS, tape drives	SAS, SATA	SAS, SATA, tape drives	SAS, SATA, tape drives
Non-RAID	Yes	Yes	Yes	Yes	Yes
Boot support	Yes	No	Yes	Yes	Yes
Queue depth	7552	7552	8320	7552	7552

**NOTE:** Thermal polling is enabled for SATA drives by default. For more information about configuration, see *iDRAC RACADM CLI Guide* available at [www.dell.com/idracmanuals](http://www.dell.com/idracmanuals).

## PowerEdge systems supported by Dell HBA355i Adapter

The following PowerEdge systems support the Dell HBA355i Adapter controller:

- PowerEdge R7525
- PowerEdge R750
- PowerEdge R750XS
- PowerEdge R250
- PowerEdge R350
- PowerEdge XR11
- PowerEdge XR12
- PowerEdge T150
- PowerEdge T350
- PowerEdge R760
- PowerEdge R760XS
- PowerEdge R7625
- PowerEdge R7615
- PowerEdge R760XD
- PowerEdge C6620
- PowerEdge R860

## PowerEdge systems supported by Dell HBA355i Front

The following PowerEdge systems support the HBA355i Front controller:

- PowerEdge R6525
- PowerEdge R7525
- PowerEdge R650
- PowerEdge R750XA
- PowerEdge R450
- PowerEdge R650XS
- PowerEdge R750XS
- PowerEdge T550
- PowerEdge R350
- PowerEdge R750
- PowerEdge R550
- PowerEdge R760
- PowerEdge R660
- PowerEdge R760XA
- PowerEdge R960
- PowerEdge R860
- PowerEdge R7625
- PowerEdge R6625
- PowerEdge R7615
- PowerEdge R6615
- PowerEdge R660XS
- PowerEdge R760XS
- PowerEdge T560

## PowerEdge systems supported by Dell HBA355e Adapter

The following PowerEdge systems support the Dell HBA355e Adapter controller:

- PowerEdge R6515
- PowerEdge R7515
- PowerEdge R6525
- PowerEdge R7525
- PowerEdge R640
- PowerEdge R740
- PowerEdge R740xd
- PowerEdge T640
- PowerEdge R440
- PowerEdge R540
- PowerEdge T440
- PowerEdge R6525
- PowerEdge R7525
- PowerEdge R750
- PowerEdge R650
- PowerEdge R750xa
- PowerEdge R450
- PowerEdge R550
- PowerEdge R650xs
- PowerEdge R750xs
- PowerEdge T550
- PowerEdge XR11
- PowerEdge XR12
- PowerEdge T150
- PowerEdge R350
- PowerEdge R250

- PowerEdge T350
- PowerEdge R940
- PowerEdge C6420
- PowerEdge R240
- PowerEdge T340
- PowerEdge R340
- PowerEdge R840
- PowerEdge R940xa
- PowerEdge T140
- PowerEdge R740xd2
- PowerEdge R760
- PowerEdge R660
- PowerEdge R760XA
- PowerEdge R760XD
- PowerEdge R960
- PowerEdge R860
- PowerEdge R7625
- PowerEdge R6625
- PowerEdge R7615
- PowerEdge R660XS
- PowerEdge R760XS
- PowerEdge T560

## PowerEdge systems supported by Dell HBA350i MX

The following PowerEdge system support the controller:

- PowerEdge MX750c
- PowerEdge MX760c

## PowerEdge systems supported by Dell HBA350i Adapter

The following PowerEdge systems support the controller:

- PowerEdge R640
- PowerEdge R740
- PowerEdge R740XD
- PowerEdge T640
- PowerEdge R440
- PowerEdge R540
- PowerEdge T440

## PowerEdge systems supported by Dell HBA350i MM

The following PowerEdge systems support the controller:

- PowerEdge R640
- PowerEdge R740XD
- PowerEdge R6515
- PowerEdge C6420
- PowerEdge R7515
- PowerEdge C6420
- PowerEdge R740XD2
- PowerEdge XR2

# Operating systems supported by Dell HBA355i Adapter cards

See [Dell Technologies Enterprise operating systems support](#) for a list of supported operating systems by a specific server for the Dell HBA355i Adapter cards.

**NOTE:** For the latest list of supported operating systems and driver installation instructions, see the operating system documentation at [www.dell.com/operatingsystemmanuals](http://www.dell.com/operatingsystemmanuals). For specific operating system service pack requirements, see the Drivers and Downloads section at [www.dell.com/manuals](http://www.dell.com/manuals).

## MD1400 and MD1420 enclosure support for Dell HBA355e Adapter

Dell HBA355e Adapter supports external enclosures MD1420 and MD1400. To connect to external enclosures, HBA355e Adapter uses the HD Mini-SAS SFF-8644 cables.

The MD enclosure topology rules for Dell HBA355e Adapter are:

- The maximum number of enclosures supported for single-path configuration is eight, and dual-path configuration is four.
- A maximum of two enclosures are supported per port when using a daisy chain topology.
- MD1400 and MD1420 can be connected to the same controller at the same time.
- Mixing of MD and ME enclosures or mixing tape drives and MD or ME enclosures on the same controller is not supported.
- Loopback connections of enclosures are not supported.
- Mixing of single-path and dual-path configurations on the same controller is not supported.
- Interleaving of port for multipath configuration is not supported.
- Using Port 1 and Port 2 in a dual-path configuration on the same enclosure is not supported. See [Port support matrix for dual path on the MD1400 and MD1420 enclosures](#)

## Port support matrix for dual path on the MD1400 and MD1420 enclosures

The following table lists the combination of the ports on the controller that do and do not support dual-path configurations:

**Table 2. Port support matrix for dual path on the MD1400 and MD1420 enclosures**

Serial number	Port 0 connected Yes/No	Port 1 connected Yes/No	Port 2 connected Yes/No	Port 3 connected Yes/No	Dual path support on the same MD14xx enclosure
1	Yes	No	Yes	No	No
2	Yes	No	No	Yes	No
3	No	Yes	Yes	No	No
4	No	Yes	No	Yes	No
5	Yes	Yes	No	No	Yes
6	No	No	Yes	Yes	Yes
7	Yes	Yes	Yes	Yes	Yes

# ME484 enclosure support for Dell HBA355e Adapter

Dell HBA355e Adapter supports external enclosure ME484. To connect to external enclosures, HBA355e Adapter uses the HD Mini-SAS SFF-8644 cables.

The ME484 enclosure topology rules for Dell HBA355e Adapter are:

- A maximum of two enclosures is supported in a single- or dual-path configurations.
- Both single-path and dual-path configurations on the same Dell HBA355e Adapter card is not supported.
- When using two enclosures together, the two must be either MD14xx or ME484. Mixing of these two types of enclosures is not supported. Also, mixing tape drives and MDxx or ME484 enclosures, on the same controller is not supported.
- Only one enclosure is supported per port.
- Loop back connections of enclosures are not supported.
- Interleaving of ports for multipath configuration is not supported.
- Using port 1 and port 2 for dual-path on the same enclosure is not supported. See [Port support matrix for dual path on the ME484 enclosure](#).

## Port support matrix for dual path on the ME484 enclosure

The following table lists the combination of the ports on controller that support dual path or not support dual path:

**Table 3. Port support matrix for dual path on the ME484 enclosure**

Serial number	Port 0 connected Yes/No	Port 1 connected Yes/No	Port 2 connected Yes/No	Port 3 connected Yes/No	Dual path support on same ME484 enclosure Yes/No
1	Yes	No	Yes	No	No
2	Yes	No	No	Yes	No
3	No	Yes	Yes	No	No
4	No	Yes	No	Yes	No
5	Yes	Yes	No	No	Yes
6	No	No	Yes	Yes	Yes
7	Yes	Yes	Yes	Yes	Yes

## MD24xx enclosure supported by Dell HBA355e Adapter

Dell HBA355e Adapter supports external enclosures MD2412, MD2424, and MD2460. To connect to external enclosures, HBA355e Adapter uses the SAS-4 EXTERNAL HD (SFF-8674) 36-PIN & SAS-3 HD Mini-SAS SFF-8644.

 **NOTE:** At the first level, either SAS3 or SAS4 can be used.

 **NOTE:** Cascading SAS4 Cables (JBOD to JBOD - 24G).

The MD24xx enclosure topology rules for Dell HBA355e Adapter are:

- Max number of enclosures supported in dual path configurations are MD2412 (8 enclosures), MD2424 (4 enclosures), and MD2460 (2 enclosure).
- Max number of enclosures supported per port are MD2412 (4 enclosures), MD2424 (2 enclosures), and MD2460 (1 enclosure).
- Mixing of MD2412 and MD2424, MD2412 and MD2460, or MD2424 and MD2460 on same port chain is not supported. Use similar enclosures.

- MD14XX, MD24XX, ME484, and tape drives on the same HBA card is unsupported.
- No loop back connections of enclosures are supported. For example, if there are two enclosures connected in daisy/multipath configuration, then connecting a port of second enclosure again back to one of the port on the first enclosure is not supported.
- Mixing of single path and dual path configurations on the same controller is not supported. For example, if Port 0 and Port 1 are connected to Enclosure 0, then you cannot connect Port 2 to Enclosure 1.
- Interleaving of port for dual path configuration is not supported. For example, if port 0 is used to connect the 1st EMM, then only port 1 should be used to connect multipath to other EMM for the same enclosure.
- Using Port 1 and Port 2 for dual path on the same enclosure is not supported.
- Any combinations conforming to the above rules will be supported.

## Supported Cable Configurations

- Connect to the JBOD EMM by using SAS4 cables only.
- Redundant cable configurations only:
  - Both EMMs must be cabled to the PERC or HBA in a server to properly manage the JBOD.
  - All elements cannot be monitored in single cable configuration. For example, fans, temperature, and probes.
  - Firmware of both EMMs cannot be upgraded in a single cable configuration. Peer update functionality is unavailable in JBOD.
  - DUP supports only dual cable configurations.
- Symmetrical cable configurations only:
  - Chain configurations do not support asymmetrical cabling. All cables will run top to bottom or bottom to top in a stack.
- Mixing of enclosures in chain configuration is not supported:
  - You must connect enclosures of same model only. For example, an MD2412 can be daisy-chained only to an MD2412 enclosure.

## External tape drive support for Dell HBA355e Adapter

Dell HBA355e Adapter supports external tape drives.

External tape drive topology rules for Dell HBA355e Adapter are:

- A maximum of four tape drives are supported if external LT06/7/8/9 are connected.
- Each port supports a maximum of one tape drive.
- Multipath configurations are not supported.
- Mixing of tape drives with ME (ME484) or MD (MD1420 or MD1400) enclosures on the same controller is not supported.
- Mixing of tape drives with ME484, MD14XX, and MD24XX on the same controller card is not supported.

## Internal tape drive support for Dell HBA355i Adapter and Dell HBA350i Adapter

HBA355i Adapter and HBA350i Adapter support one tape drive (LT06/7/8/9).

# Applications supported by Dell HBA355i Adapter, Dell HBA355i Front, Dell HBA355e Adapter, Dell HBA350i MX, Dell HBA350i Adapter, and Dell HBA350i MM

The Dell HBA355i Adapter, Dell HBA355i Front, Dell HBA355e Adapter, Dell HBA350i MX, Dell HBA350i Adapter, and Dell HBA350i MM management applications include the Human Interface Infrastructure Configuration Utility (HII), Dell OpenManage Storage Management, command-line interface, the Integrated Dell Remote Access Controller (iDRAC), and Lifecycle Controller (LC). They enable you to manage and configure the system, create and manage a disk group, and provide online maintenance.

## Topics:

- [Human Interface Infrastructure Configuration Utility](#)
- [Dell OpenManage Storage Management](#)
- [The Integrated Dell Remote Access Controller and Lifecycle Controller](#)
- [The Command Line Interface](#)

## Human Interface Infrastructure Configuration Utility

The Human Interface Infrastructure (HII) configuration utility is a storage management application integrated into the System BIOS <F2>. It is used to configure physical disks. This utility is independent of the operating system. For more information about HII, see [HII configuration utility](#).

## Dell OpenManage Storage Management

Dell OpenManage Storage Management enables you to perform controller and enclosure functions for all supported RAID or Non-RAID controllers and enclosures from a single graphical or command line interface. For more information, see the Dell OpenManage Storage Management User's Guide at [www.dell.com/openmanagemanuals](http://www.dell.com/openmanagemanuals).

## The Integrated Dell Remote Access Controller and Lifecycle Controller

The Integrated Dell Remote Access Controller (iDRAC) and Lifecycle Controller (LC) application enables you to effectively monitor the network controllers installed on the system using iDRAC and LC without an operating system installed on the system. For more information, see the Integrated Dell Remote Access Controller 9 User's Guide at [www.dell.com/idracmanuals](http://www.dell.com/idracmanuals).

## The Command Line Interface

The Command Line Interface (CLI) is a storage management application. This utility allows you to set up, configure, and manage your Dell Technologies Host Bus Adapter by using the Command Line Interface (CLI).

 **NOTE:** For more information, see *Dell PowerEdge RAID Controller CLI Reference Guide* at [www.dell.com/storagecontrollermanuals](http://www.dell.com/storagecontrollermanuals).



# Multipath support on Dell HBA355e Adapter

When set up for multipath systems, the HBA355e Adapter controllers may access physical drives through multiple paths to provide path redundancy and load balance to the drives. However, the controller does not manage these paths; this function is controlled by the multipath layer in the host operating system. As a result, in a multipath configuration, each separate path to a drive is treated as an independent drive and a single drive may be presented in the operating system as multiple drives. To avoid complications from having multiple paths to a drive, path management software is necessary to map these multiple paths to the same single drive. This chapter covers multipath management options for different operating systems and management interfaces.

## Topics:

- [Dell HBA multipathing using HII](#)
- [Dell HBA multipathing using Windows](#)
- [Dell HBA multipathing using iDRAC](#)
- [Dell HBA multipathing using Linux](#)
- [Dell HBA multipathing using VMware](#)

## Dell HBA multipathing using HII

The Dell HBA355e Adapter controller does not map multiple paths together in HII. Under **Device Configuration**, select the HBA controller. Under **Physical Disk Management** > **View Physical Disk Properties**, select the physical disk to determine whether it has multiple paths. For more information, see [Device properties](#).

## Dell HBA multipathing using Windows

### About this task

To enable Multipath I/O (MPIO) for Windows Server 2016 and Windows Server 2019:

### Steps

1. Open the **Server Manager**.
2. Under **Manage**, select **Add Roles and Features**.
3. Follow the steps in the **Add Roles and Features Wizard** until you reach the **Features** step. Then, select the **Multipath I/O** feature for installation.
4. Complete the steps in the **Add Roles and Features Wizard** to complete the installation.
5. In the **Server Manager**, select **Tools > MPIO**.
6. Under the **Discover Multipaths** tab, select the **Add support for SAS devices** option and select **OK**. Restart the system.
7. To check that MPIO is enabled and manage the HBA Drives, open **Device Manager** and select **Disk Drives**. Drives that are accessible are now listed as a **Multipath Disk Device**.
8. Right-click a multipath disk and select **Properties**.
9. Click **MPIO**. You can set MPIO policies and check whether both the paths to the drive are active. If configured properly, both the paths display **Active/Optimised** under the **This device has the following paths** section. If only one path is listed, check the system storage assignment and hardware configuration.

## Dell HBA multipathing using iDRAC

iDRAC 9 maps paths together for the drives managed by the controller. In iDRAC, each physical drive is presented once on the **Storage Configuration** page. To determine if your drive is in a multipath configuration, select **Storage > Enclosures**, expand the enclosure that is in a redundant path setup, and select **Advanced properties > Redundant path > Present**.

## Dell HBA multipathing using Linux

For information about configuring Dell HBA multipathing using Linux, see the Linux administration documentation. Use the **Multipath-l** commands to display path information.

## Dell HBA multipathing using VMware

ESXi by default provides the VMware Native Multipathing Plug-In (NMP), which automatically maps paths and manages drives in a multipath configuration. For more information, refer to VMware documentation on NMP.

# Features of Dell HBA355i Adapter, Dell HBA355i Front, Dell HBA355e Adapter, Dell HBA350i MX, Dell HBA350i Adapter, and Dell HBA350i MM

The Dell HBA355i Adapter, Dell HBA355i Front, Dell HBA355e Adapter, Dell HBA350i MX, Dell HBA350i Adapter, and Dell HBA350i MM cards support the following features. Dell HBA355e Adapter supports MD1400, MD1420, and ME484 enclosures, and external tape drives (LTO 6/7/8/9). Dell HBA350i Adapter supports internal tape drives (LTO 6/7/8/9).

## Topics:

- [Hardware Root of Trust](#)
- [No RAID support](#)
- [Event management support for Dell HBA355i Adapter, Dell HBA355i Front, Dell HBA355e Adapter, Dell HBA350i MX, Dell HBA350i Adapter, and Dell HBA350i MM](#)
- [LED activity](#)

## Hardware Root of Trust

Hardware Root of Trust (RoT) builds a chain of trust by authenticating all the firmware components before it runs, and permits only authenticated firmware to run and flash. Hardware RoT establishes a chain of trust by running the initial firmware code from immutable Internal Boot ROM (IBR) and this process authenticates and builds a chain of trust with succeeding software using this root of trust.

## No RAID support

Dell HBA355i Adapter, Dell HBA355i Front, Dell HBA355e Adapter, Dell HBA350i MX, and Dell HBA350i Adapter does not support RAID volumes. The drives that are connected to the controller are individual disks that cannot be combined into a RAID volume.

## Event management support for Dell HBA355i Adapter, Dell HBA355i Front, Dell HBA355e Adapter, Dell

# HBA350i MX, Dell HBA350i Adapter, and Dell HBA350i MM

Event management for HBA controllers is through iDRAC and OMSS. See the iDRAC and OMSS documentation for more information .

## LED activity

The Dell HBA355i Adapter, Dell HBA355i Front, Dell HBA355e Adapter, Dell HBA350i MX, and Dell HBA350i Adapter controllers are equipped with status LEDs.

**Table 4. LED behavior for drive**

LED state	LED status
Off	Indicates one of the following: <ul style="list-style-type: none"><li>• Power is off.</li><li>• All the links are disconnected.</li><li>• The cable is disconnected.</li></ul>
Green	Drive is connected and functional.
Flashing green	Active when you perform the locate operation.

**Table 5. LED behavior for HBA355e Adapter**

LED state	LED status
Off	None of the external devices are connected.
Green	When enclosures are connected and all the x4 lanes are linked up.
Amber	When a device is connected and not all the x4 lanes are linked up.  <b>NOTE:</b> Tape drives have only x1 lanes and the default LED color will be Amber when they are connected. This is an expected behavior.

# Installation and removal of cards

## Topics:

- Safety instructions
- Before working inside your system
- Remove the Dell HBA355i Adapter
- Install the Dell HBA355i Adapter
- Remove the Dell HBA355i Front
- Install the Dell HBA355i Front
- Remove the Dell HBA355e Adapter
- Install the Dell HBA355e Adapter
- Connect the Dell HBA355e Adapter to the storage enclosure
- Connect an HBA355e adapter to MD24xx enclosures
- Remove the Dell HBA350i MX
- Install the Dell HBA350i MX
- Remove the Dell HBA350i Adapter
- Install the Dell HBA350i Adapter
- Remove Dell HBA350i MM
- Install the HBA350i MM

## Safety instructions

 **NOTE:** To avoid injury, do not lift the system on your own. Get others to assist you.

 **WARNING:** Opening or removing the system cover while the system is turned on may expose you to a risk of electric shock..

 **CAUTION:** Many repairs may only be done by a certified service technician. You should only perform troubleshooting and simple repairs as authorized in your product documentation, or as directed by the online or telephone service and support team. Damage due to servicing that is not authorized by Dell is not covered by your warranty. Read and follow the safety instructions that are shipped with your product.

 **CAUTION:** To ensure proper operation and cooling, all system bays and fans must be always populated with a component or a blank.

 **NOTE:** It is recommended that you always use an antistatic mat and antistatic strap while working on components inside the system.

 **NOTE:** While replacing the hot swappable PSU, after next server boot; the new PSU automatically updates to the same firmware and configuration of the replaced one. For more information about the Part replacement configuration, see the *Lifecycle Controller User's Guide* at <https://www.dell.com/idracmanuals>

 **NOTE:** While replacing faulty storage controller/FC/NIC card with the same type of card, after you power on the system; the new card automatically updates to the same firmware and configuration of the faulty one. For more information about the Part replacement configuration, see the *Lifecycle Controller User's Guide* at <https://www.dell.com/idracmanuals>

 **NOTE:** For detailed information on cabling the cards, see the system-specific owner's manual at Installation and Service Manual available at <https://www.dell.com/poweredge manuals>

# Before working inside your system

## Steps

1. Power off the system and all attached peripherals.
2. Disconnect the system from the electrical outlet, and disconnect the peripherals.
3. If applicable, remove the system from the rack.

For more information, see the *Rail Installation Guide* relevant to your rail solutions at [www.dell.com/poweredgemanuals](http://www.dell.com/poweredgemanuals).

4. Remove the system cover.

# Remove the Dell HBA355i Adapter

## Prerequisites

 **CAUTION:** Many repairs may only be done by a certified service technician. You should only perform troubleshooting and simple repairs as authorized in your product documentation, or as directed by the online or telephone service and support team. Damage due to servicing that is not authorized by Dell is not covered by your warranty. Read and follow the safety instructions that are shipped with your product.

- You have read and complied with the safety guidelines listed in [Safety instructions](#).
- You have completed the procedures in [Before working inside your system](#).

## Steps

1. Turn off the system, including any attached peripherals, and disconnect the system from the electrical outlet and peripherals.
2. Remove the system cover.
3. Locate the HBA355i Adapter in the expansion riser on the system board.

 **CAUTION:** To prevent damage to the card, hold the card by its edges only.

4. Unfasten and lift the riser from the system board. Remove the Dell HBA355i card from the system.
5. Disconnect the SAS cables from the card:
  - a. Press down and hold the metal tab on the SAS cable connector.
  - b. Pull the SAS cable out of the connector.
6. Replace the storage controller and reconnect the SAS cable before inserting them into the riser.
7. Reinstall the riser on the system board and fasten the riser.
8. Install the system cover.
9. Reconnect the system to its electrical outlet and turn the system on, including any attached peripherals.

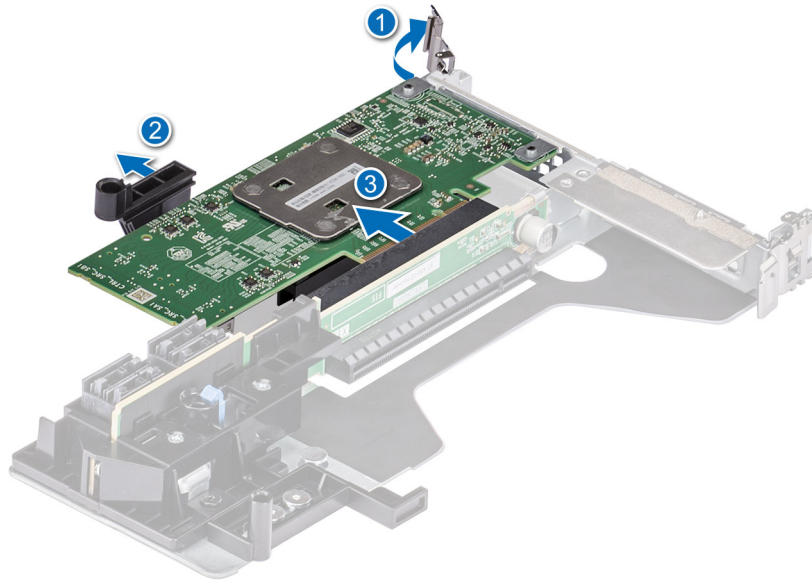

Figure 7. Remove the Dell HBA355i Adapter

## Install the Dell HBA355i Adapter

### Prerequisites

**CAUTION:** Many repairs may only be done by a certified service technician. You should only perform troubleshooting and simple repairs as authorized in your product documentation, or as directed by the online or telephone service and support team. Damage due to servicing that is not authorized by Dell is not covered by your warranty. Read and follow the safety instructions that are shipped with your product.

- You have read and complied with the safety guidelines listed in [Safety instructions](#).
- You have completed the procedures in [Before working inside your system](#).

### Steps

1. Turn off the system, including any attached peripherals, and disconnect the system from the electrical outlet.  
**NOTE:** It is recommended that you always use a static mat and static strap while working on components in the interior of the system.
2. Remove the system cover.
3. Connect the SAS data cable connectors to the card.  
**NOTE:** Ensure that you connect the cable according to the connector labels on the cable. The cable does not function properly if reversed.
4. Align the card-edge connector with the connector on the system board.  
**CAUTION:** To prevent damage to the card, hold the card by its edges only.
5. Press the card-edge down until the card is fully seated.
6. Route the SAS cable through the channel on the inner side of the chassis to the backplane.
7. Attach the connector labeled SAS A to connector SAS A on the backplane, and attach the connector labeled SAS B to connector SAS B on the backplane.
8. Install the system cover.
9. Reconnect the system to its electrical outlet and turn the system on, including any attached peripherals.

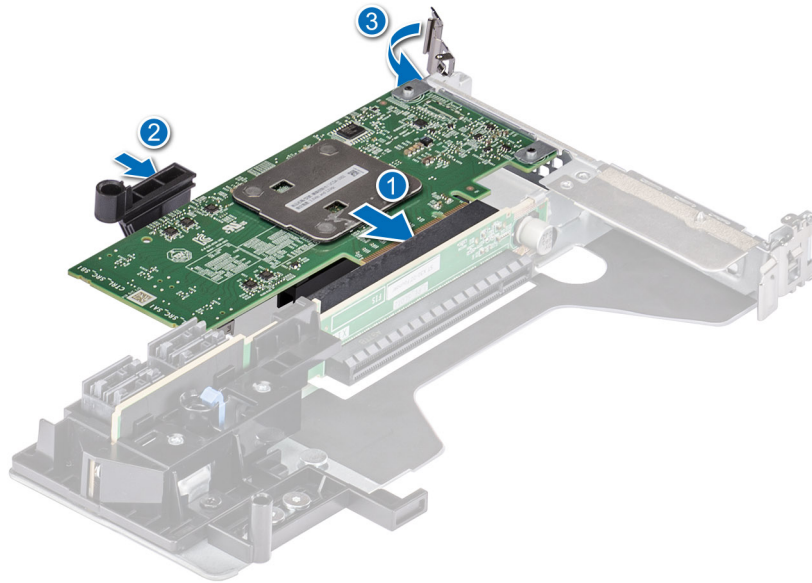

Figure 8. Install the Dell HBA355i Adapter

## Remove the Dell HBA355i Front

### Prerequisites

**CAUTION:** Many repairs may only be done by a certified service technician. You should only perform troubleshooting and simple repairs as authorized in your product documentation, or as directed by the online or telephone service and support team. Damage due to servicing that is not authorized by Dell is not covered by your warranty. Read and follow the safety instructions that are shipped with your product.

- You have read and complied with the safety guidelines listed in [Safety instructions](#).
- You have completed the procedures in [Before working inside your system](#).

### Steps

1. Turn off the system, including any attached peripherals, and disconnect the system from the electrical outlet and peripherals.
2. Remove the system cover.
3. Locate the HBA355i Front card in the controller carrier at the front of the system.

**CAUTION:** To prevent damage to the card, hold the card by its edges only.

4. Unscrew the fasteners on the controller carrier, and slide the carrier away from the backplane, disconnecting the controller from the backplane.

**NOTE:** For systems configured with HBA355i Front in an upside-down orientation, you must uninstall all the drives from the backplane before uninstalling the backplane along with the controller. There is not enough clearance to uninstall the controller otherwise.

5. Disconnect the SAS cables that are connected to the card:
  - a. Press down, and hold the metal tab on the SAS cable connector.
  - b. Pull the SAS cable out of the connector.

6. Remove HBA355i Front from the controller carrier.

**NOTE:** If the replacement storage controller is a front controller, then reinsert the controller into the carrier and secure it with the appropriate screws.

7. Reconnect the SAS cable to the replacement storage controller before reconnecting the controller to the backplane.



For systems configured with HBA355i Front in an upside-down orientation, reattach the HBA355i Front to the backplane before reinstalling the backplane into the system.

8. Install the system cover.
9. Reconnect the system to its electrical outlet, and turn the system on, including any attached peripherals.

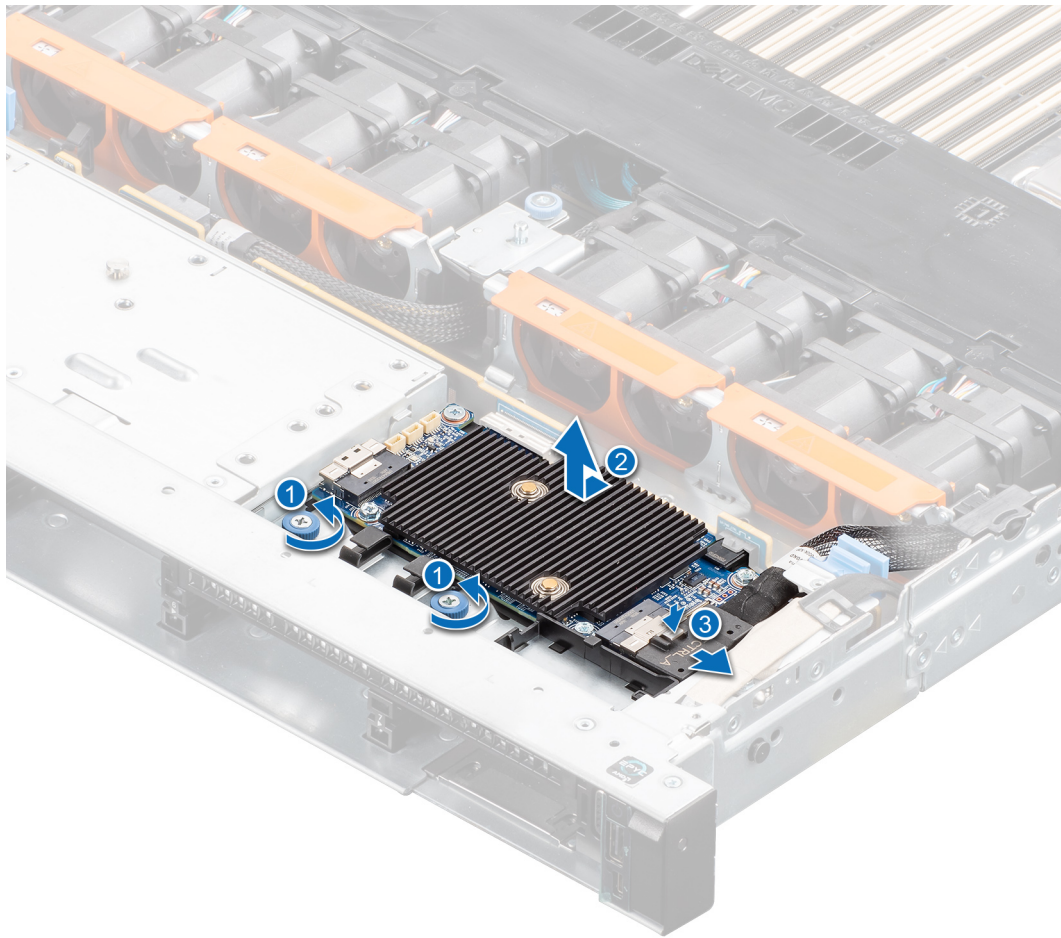

Figure 9. Remove HBA355i Front

## Install the Dell HBA355i Front

### Prerequisites

**CAUTION:** Many repairs may only be done by a certified service technician. You should only perform troubleshooting and simple repairs as authorized in your product documentation, or as directed by the online or telephone service and support team. Damage due to servicing that is not authorized by Dell is not covered by your warranty. Read and follow the safety instructions that are shipped with your product.

### Steps

1. Turn off the system, including any attached peripherals, and disconnect the system from the electrical outlet.
2. Remove the system cover.
3. Connect the SAS data cable connectors to the card.
  - NOTE:** Ensure that you connect the cable according to the connector labels on the cable. The cable does not function properly if reversed.
4. Align the card-edge connector with the connector on the system board.

**CAUTION:** To prevent damage to the card, hold the card by its edges only.

5. Press the card-edge down until the card is fully seated in the connector
6. Install the system cover.
7. Reconnect the system to its electrical outlet and turn the system on, including any attached peripherals.

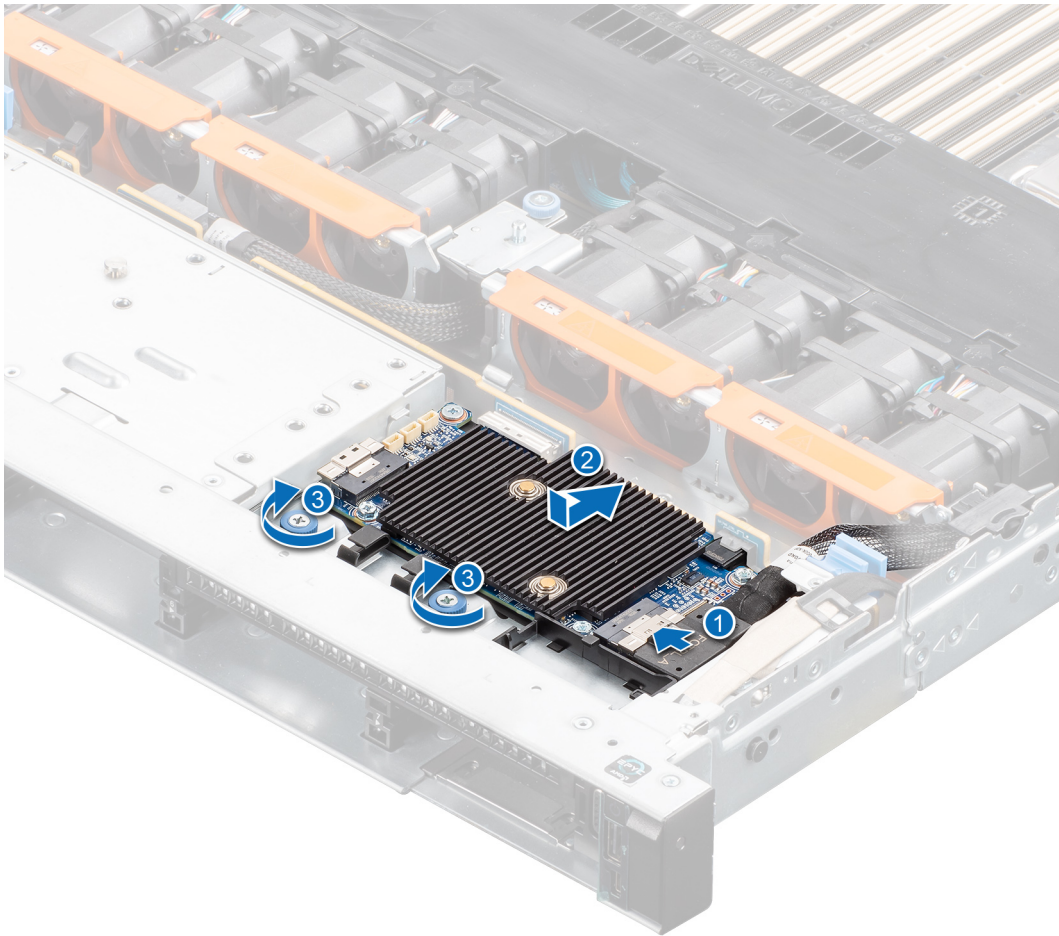

Figure 10. Install HBA355i Front

## Remove the Dell HBA355e Adapter

### Prerequisites

**CAUTION:** Many repairs may only be done by a certified service technician. You should only perform troubleshooting and simple repairs as authorized in your product documentation, or as directed by the online or telephone service and support team. Damage due to servicing that is not authorized by Dell is not covered by your warranty. Read and follow the safety instructions that are shipped with your product.

**NOTE:** It is recommended that you always use a static mat and static strap while working on components inside the system.

- You have read and complied with the safety guidelines listed in [Safety instructions](#).
- You have completed the procedures in [Before working inside your system](#).

### Steps

1. Turn off the system, including any attached peripherals, and disconnect the system from the electrical outlet and peripherals.

**NOTE:** For more information about power supply units (PSUs), see the owner's manual of your system [www.dell.com/poweredgemanuals](http://www.dell.com/poweredgemanuals).

2. Disconnect the system from the network.
3. Remove the cover of the system.
4. Locate the PCIe slot.

**NOTE:** To prevent damage to the controller card, hold the card by its edges only.

5. Remove the screws on the bracket, if any, or use the retention clips of the system to remove the controller on the system.
6. Remove the connector that attaches the HBA355e Adapter to the system board.
7. If applicable, replace the storage controller card and connect the cable.
8. Install the system cover.
9. Reconnect the power cables and network cables.

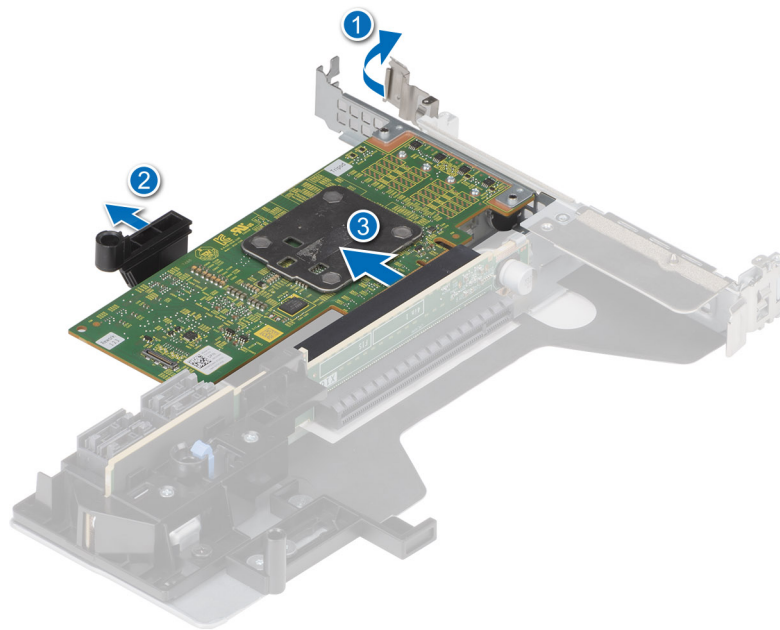

**Figure 11. Remove the HBA355e Adapter**

## Install the Dell HBA355e Adapter

### Prerequisites

**CAUTION:** Many repairs may only be done by a certified service technician. You should only perform troubleshooting and simple repairs as authorized in your product documentation, or as directed by the online or telephone service and support team. Damage due to servicing that is not authorized by Dell is not covered by your warranty. Read and follow the safety instructions that are shipped with your product.

- You have read and complied with the safety guidelines listed in [Safety instructions](#).
- You have completed the procedures in [Before working inside your system](#).

### Steps

1. Unpack your HBA355e Adapter.
2. Attach the bracket with the card using the screws provided.
3. Turn off the system, including any attached peripherals, and disconnect the system from the electrical outlet.

**NOTE:** For more information about power support units (PSUs), see the owner's manual of your system [Dell.com/poweredgemanuals](https://www.dell.com/poweredgemanuals).

4. Disconnect the system from the network.
5. Remove the cover of the system.
6. Select an appropriate PCIe slot.

**NOTE:** To avoid damage to the controller, hold the controller by its edges only.

7. Align the connector on the HBA355e Adapter with the PCIe slot on the system.
8. Press down the controller until the connectors are firmly engaged.
9. Tighten the screws on the bracket, if any, or use retention clips of the system to secure the controller on the system.
10. Use SAS cables to connect the external tape device or enclosure to the adapter.
11. Install the system cover.
12. Reconnect the power cables and network cables, and then turn on the system.

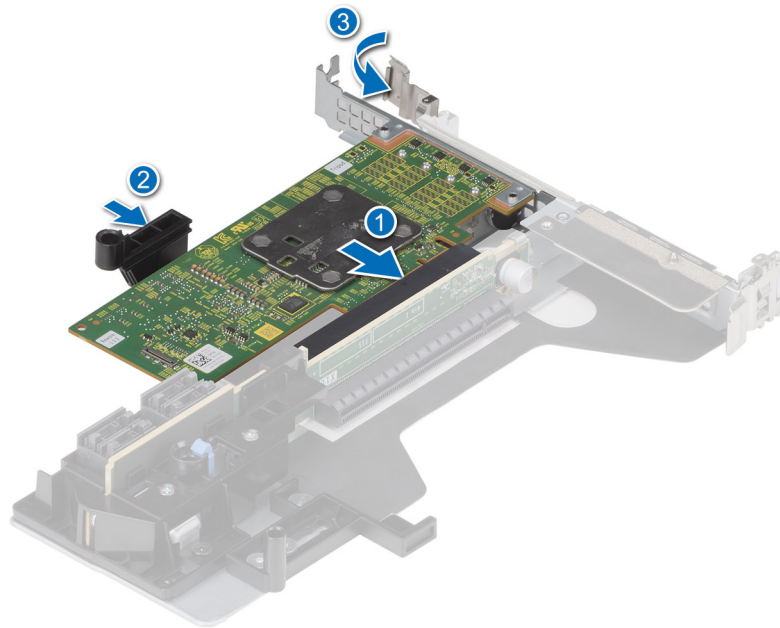

**Figure 12. Install the HBA355e Adapter**

## Connect the Dell HBA355e Adapter to the storage enclosure

### About this task

Perform the following steps to connect HBA355e Adapter to the hard drives in storage enclosures:

### Steps

1. Set up the HBA355e Adapter. See [Install the HBA355e card](#).
2. Connect the HD Mini-SAS SFF-8644 cables as shown in the following diagrams.

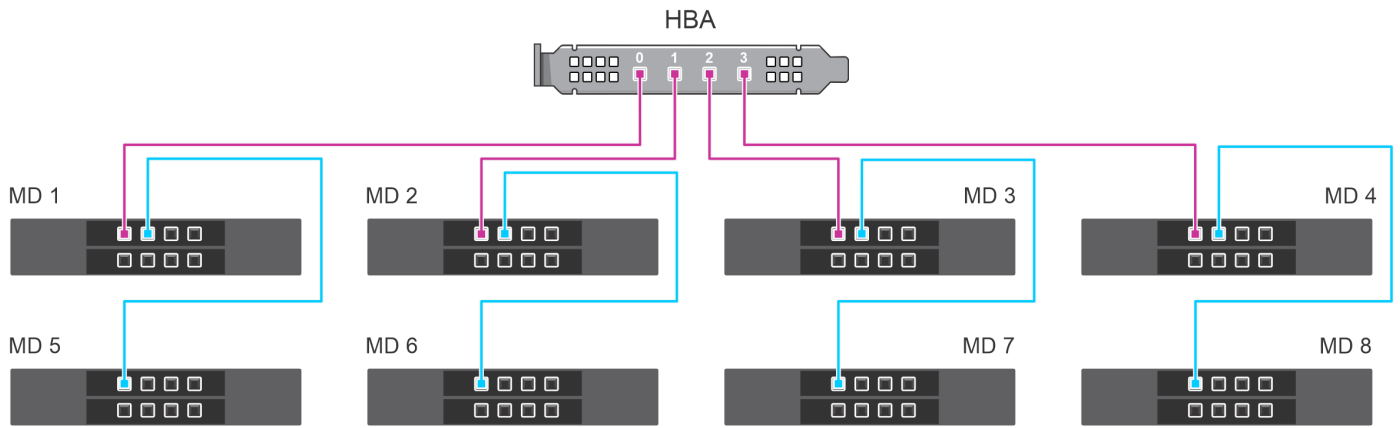

**Figure 13. Single Path Daisy Chain Configuration: Cabling HBA355e Adapter with MD1420 and MD1400 Enclosures**

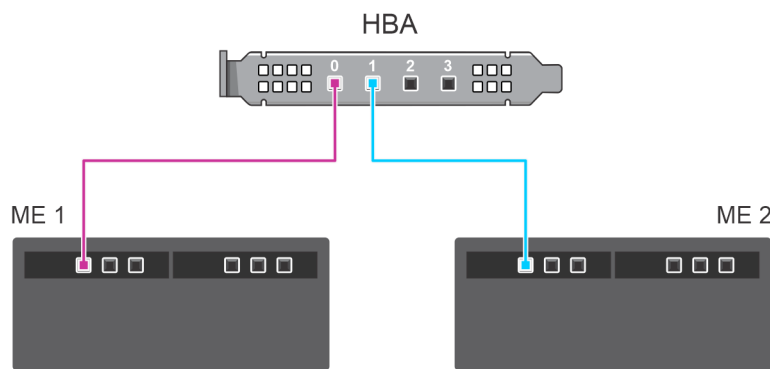

**Figure 14. Single Path Configuration: Cabling of HBA355e Adapter with ME484 Enclosures**

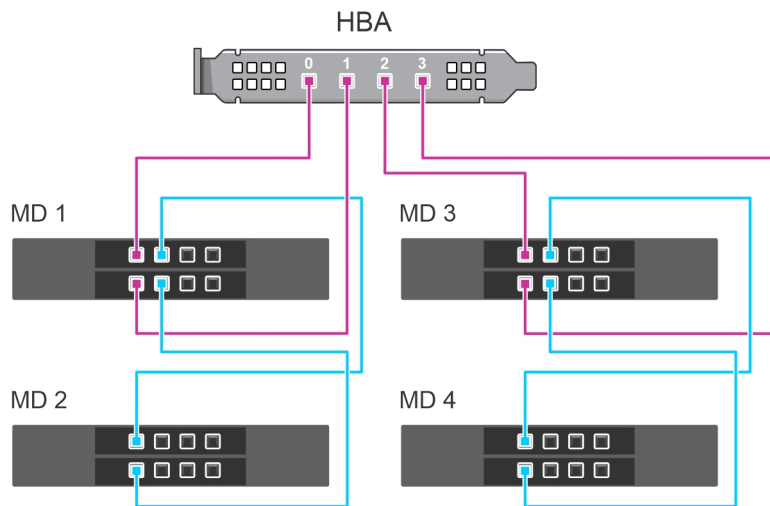

**Figure 15. Multipath Configuration: Cabling HBA355e Adapter with MD1420 and MD1400 Enclosures**

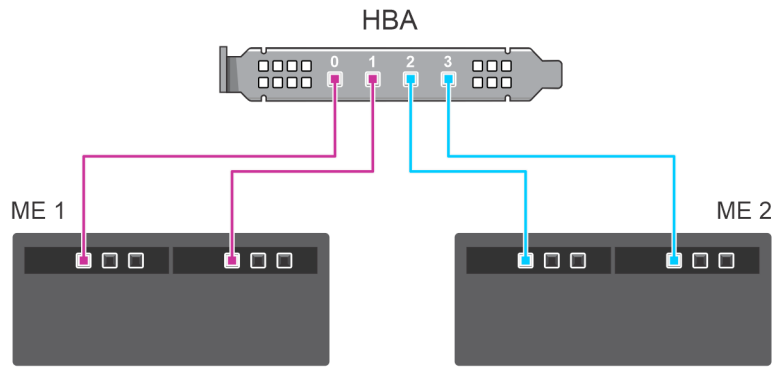

Figure 16. Multipath configuration: Cabling HBA355e Adapter with ME484 Enclosures

## Connect an HBA355e adapter to MD24xx enclosures

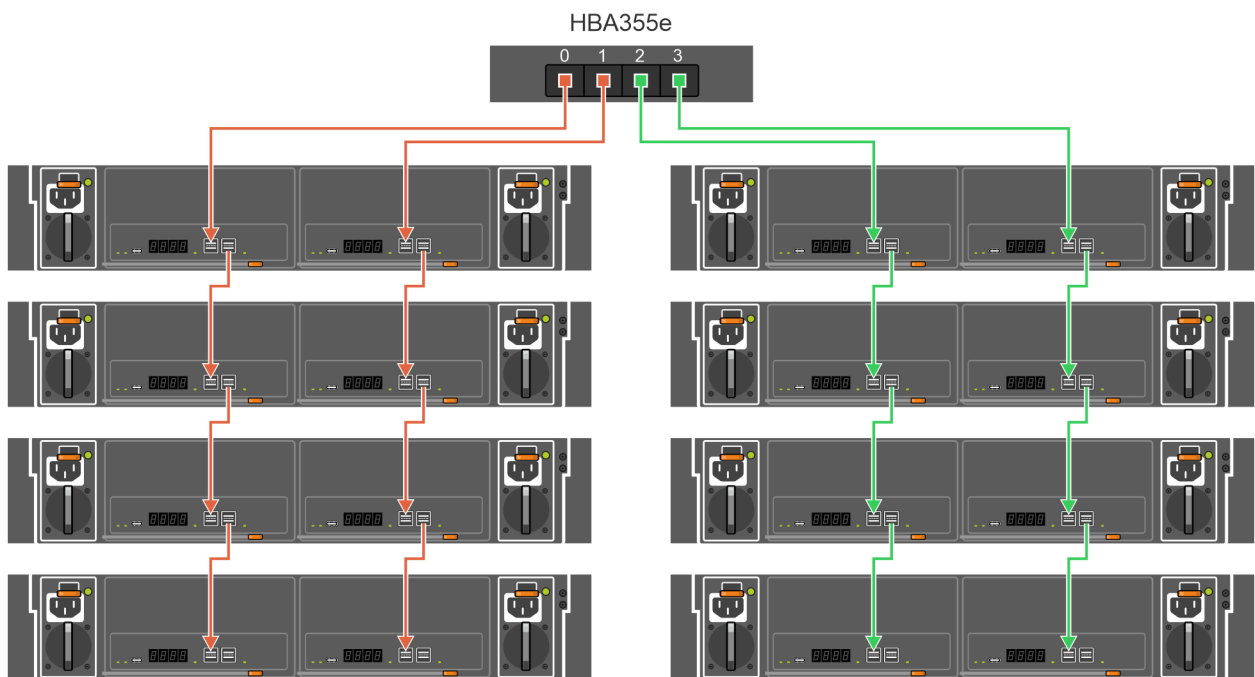

Figure 17. HBA355e adapter card ports—Eight enclosures with multipath configuration for the MD2412 series enclosures

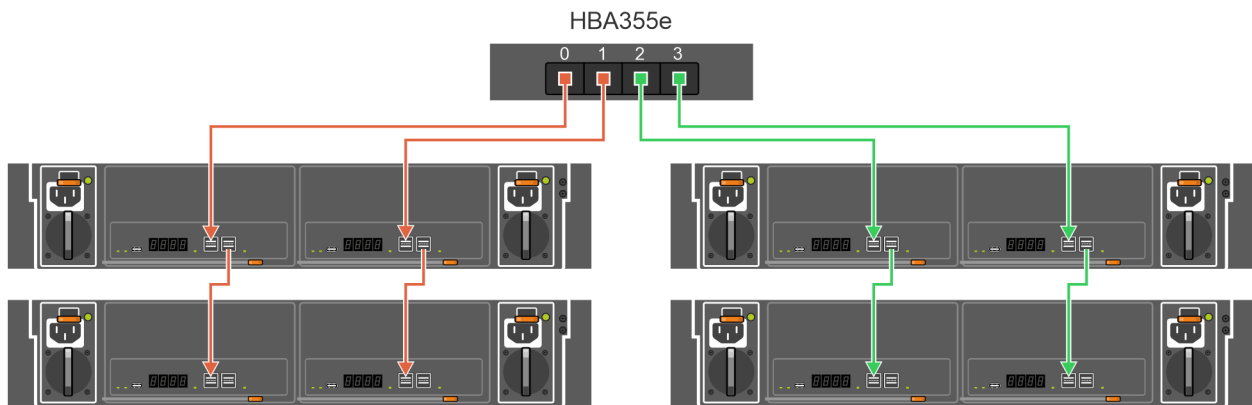

Figure 18. HBA355e adapter card ports—Four enclosures with multipath configuration for the MD2424 series enclosures

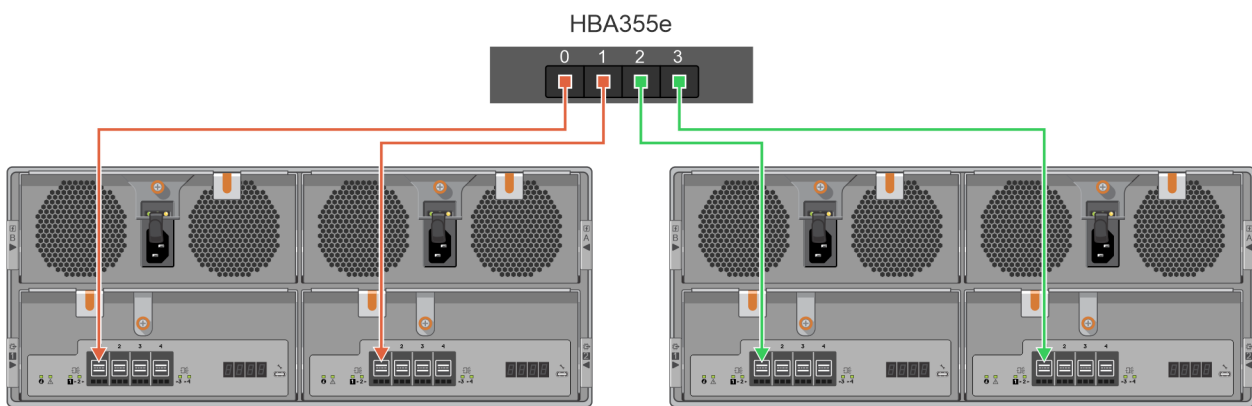

Figure 19. HBA355e adapter card ports—Two enclosures with multipath configuration for the MD2460 series enclosures

## Remove the Dell HBA350i MX

### Prerequisites

**CAUTION:** Many repairs may only be done by a certified service technician. You should only perform troubleshooting and simple repairs as authorized in your product documentation, or as directed by the online or telephone service and support team. Damage due to servicing that is not authorized by Dell is not covered by your warranty. Read and follow the safety instructions that are shipped with your product.

- You have read and complied with the safety guidelines listed in [Safety instructions](#).
- You have completed the procedures in [Before working inside your system](#).

### Steps

- Turn off the sled and any attached peripherals, and remove the sled from the MX chassis.
  - NOTE:** Perform a graceful shutdown of the sled to ensure that any data in the cache is flushed to the disk before the controller is removed.
  - NOTE:** It is recommended that you always use a static mat and static strap while working on components inside the system.
- Remove the system cover.
- Locate the HBA card on the system board.

4. Pull up the release lever on the controller and lift the card to remove it from the connector on the system board.
5. Disconnect the SAS cables that are connected to the card. To disconnect the cable:
  - a. Press down, and hold the metal tab on the SAS cable connector.
  - b. Pull the SAS cable out of the connector.
6. Lift one end of the card and angle it to disengage the card from the card connector on the system board.
7. Lift the card from the system board.

**NOTE:** To prevent damage to the card, you must hold the card by its edges only.

8. Place the storage controller card and connect the cable. For more information about installing the card, see [Install Dell HBA350i MX](#).
9. Install the system cover.
10. Insert the sled into the chassis and turn on the system and any attached MX chassis peripherals.

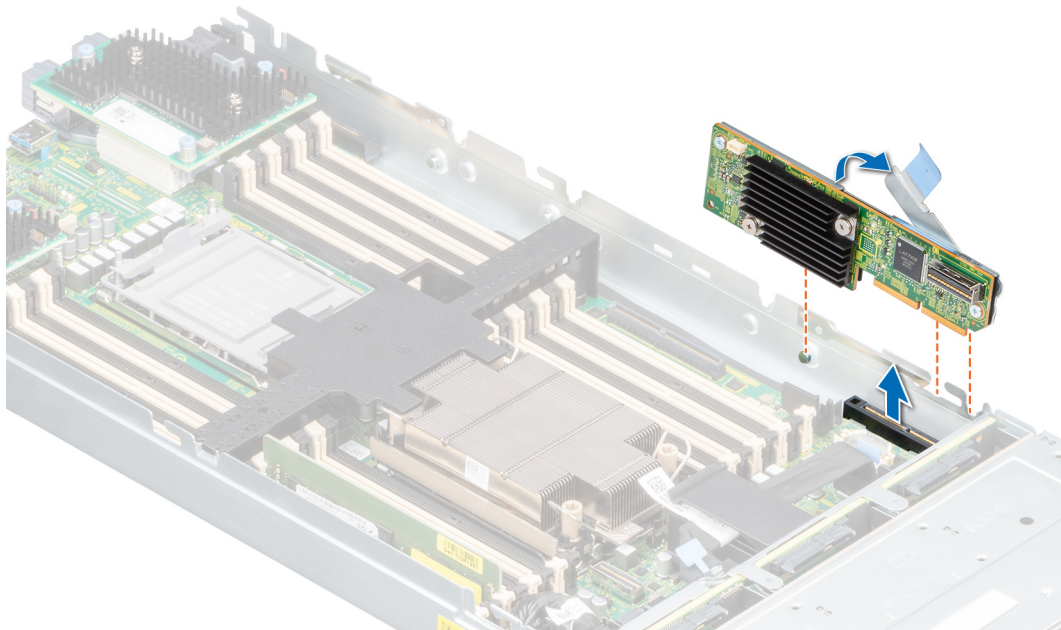

Figure 20. Remove Dell HBA350i MX

## Install the Dell HBA350i MX

### Prerequisites

**CAUTION:** Many repairs may only be done by a certified service technician. You should only perform troubleshooting and simple repairs as authorized in your product documentation, or as directed by the online or telephone service and support team. Damage due to servicing that is not authorized by Dell is not covered by your warranty. Read and follow the safety instructions that are shipped with your product.

### Steps

1. Turn off the sled and any attached peripherals, and remove the sled from the MX chassis.
2. Remove the system cover.
3. Align the bracket notches with the tabs on the sides of the system and align the HBA350i MX card connector with the connector on the system board.



**NOTE:** To prevent damage to the card, you must hold the card by its edges only.

4. Press the HBA card onto the connector until it is firmly seated.
5. Press the release latch to secure the card to the sled.
6. Connect the SAS cable connectors to the card.

**NOTE:** Ensure that you connect the cable according to the connector labels on the cable. If reversed, the cable does not function properly.

7. Route the SAS data cable through the clip on the card and through the channel on the inner side of the chassis.
8. Attach the connector that is labeled BP SAS to connector SAS A on the backplane, and attach the connector that is labeled CTRL SAS to SAS-cable on the controller card.
9. Install the system cover.
10. Insert the sled into the chassis and turn on the system and any attached MX chassis peripherals.

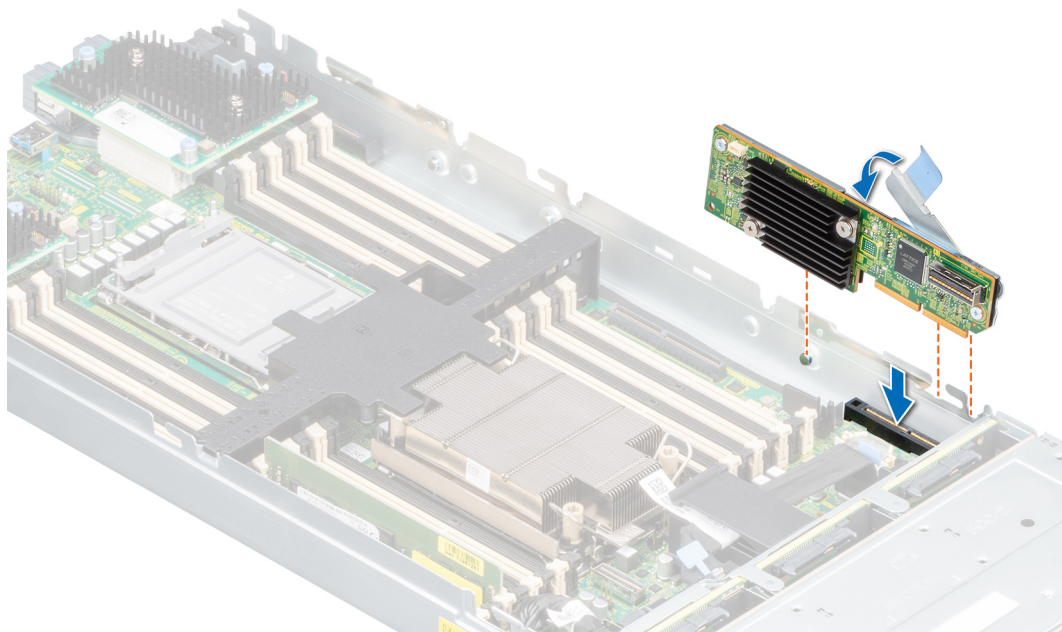

Figure 21. Install Dell HBA350i MX

## Remove the Dell HBA350i Adapter

### Prerequisites

**CAUTION:** Many repairs may only be done by a certified service technician. You should only perform troubleshooting and simple repairs as authorized in your product documentation, or as directed by the online or telephone service and support team. Damage due to servicing that is not authorized by Dell is not covered by your warranty. Read and follow the safety instructions that are shipped with your product.

- You have read and complied with the safety guidelines listed in [Safety instructions](#).
- You have completed the procedures in [Before working inside your system](#).

### Steps

1. Turn off the system, including any attached peripherals, and disconnect the system from the electrical outlet and peripherals.
2. Remove the system cover.

3. Locate the HBA350i Adapter in the expansion riser on the system board.

**CAUTION:** To prevent damage to the card, hold the card by its edges only.

4. Unfasten and lift the riser from the system board. Remove the HBA350i Adapter from the system.

5. Disconnect the SAS cables from the card:

- a. Press down and hold the metal tab on the SAS cable connector.
- b. Pull the SAS cable out of the connector.

6. Place the storage controller and reconnect the SAS cable before inserting them into the riser.

7. Reinstall the riser on the system board and fasten the riser.

8. Install the system cover.

9. Reconnect the system to its electrical outlet and turn the system on, including any attached peripherals.

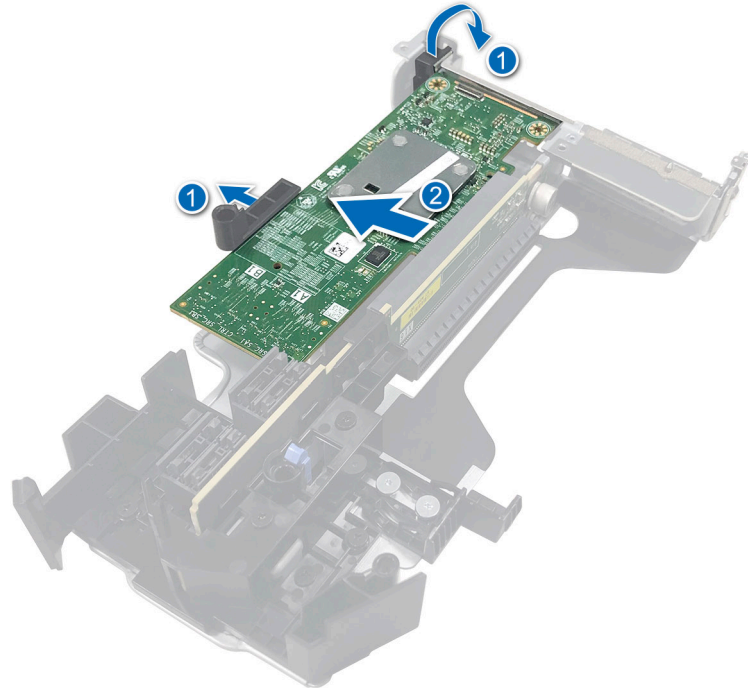

Figure 22. Remove the HBA350i Adapter

## Install the Dell HBA350i Adapter

### Prerequisites

**CAUTION:** Many repairs may only be done by a certified service technician. You should only perform troubleshooting and simple repairs as authorized in your product documentation, or as directed by the online or telephone service and support team. Damage due to servicing that is not authorized by Dell is not covered by your warranty. Read and follow the safety instructions that are shipped with your product.

- You have read and complied with the safety guidelines listed in [Safety instructions](#).
- You have completed the procedures in [Before working inside your system](#).

### Steps

1. Turn off the system, including any attached peripherals, and disconnect the system from the electrical outlet.

**NOTE:** It is recommended that you always use a static mat and static strap while working on components in the interior of the system.

2. Remove the system cover.

3. Connect the SAS data cable connectors to the card.

**NOTE:** Ensure that you connect the cable according to the connector labels on the cable. The cable does not function properly if reversed.

4. Align the card-edge connector with the connector on the system board.

**CAUTION:** To prevent damage to the card, hold the card by its edges only.

5. Press the card-edge down until the card is fully seated.

6. Route the SAS data cable through the channel on the inner side of the chassis to the backplane.

7. Attach the connector labeled SAS A to connector SAS A on the backplane.

8. Install the system cover.

9. Reconnect the system to its electrical outlet and turn the system on, including any attached peripherals.

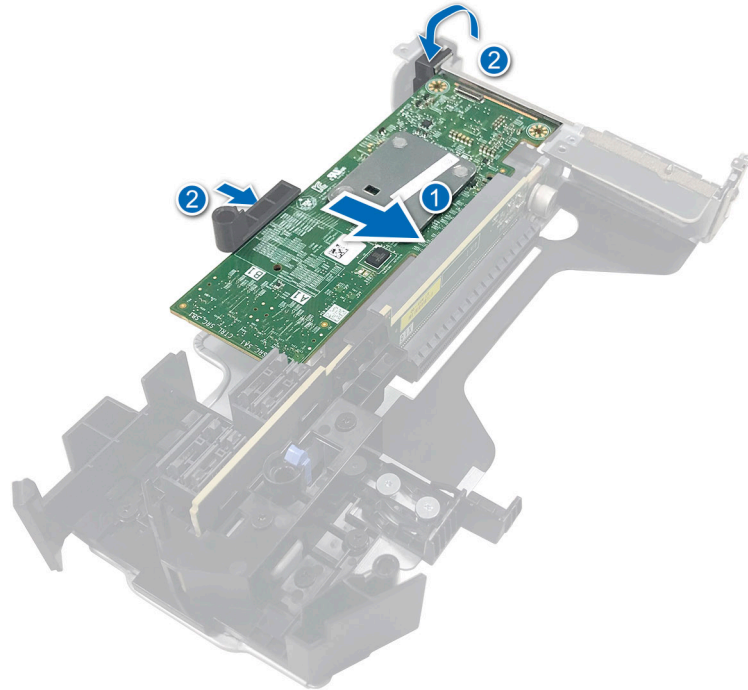

Figure 23. Install the Dell HBA350i Adapter

## Remove Dell HBA350i MM

### Prerequisites

**CAUTION:** Many repairs may only be done by a certified service technician. You should only perform troubleshooting and simple repairs as authorized in your product documentation, or as directed by the online or telephone service and support team. Damage due to servicing that is not authorized by Dell is not covered by your warranty. Read and follow the safety instructions that are shipped with your product.

### Steps

1. Using Phillips #2 screwdriver, loosen the screws that secure the storage controller cable to the connector on the system board.
2. Lift the storage controller cable to disconnect it from the connector on the system board.

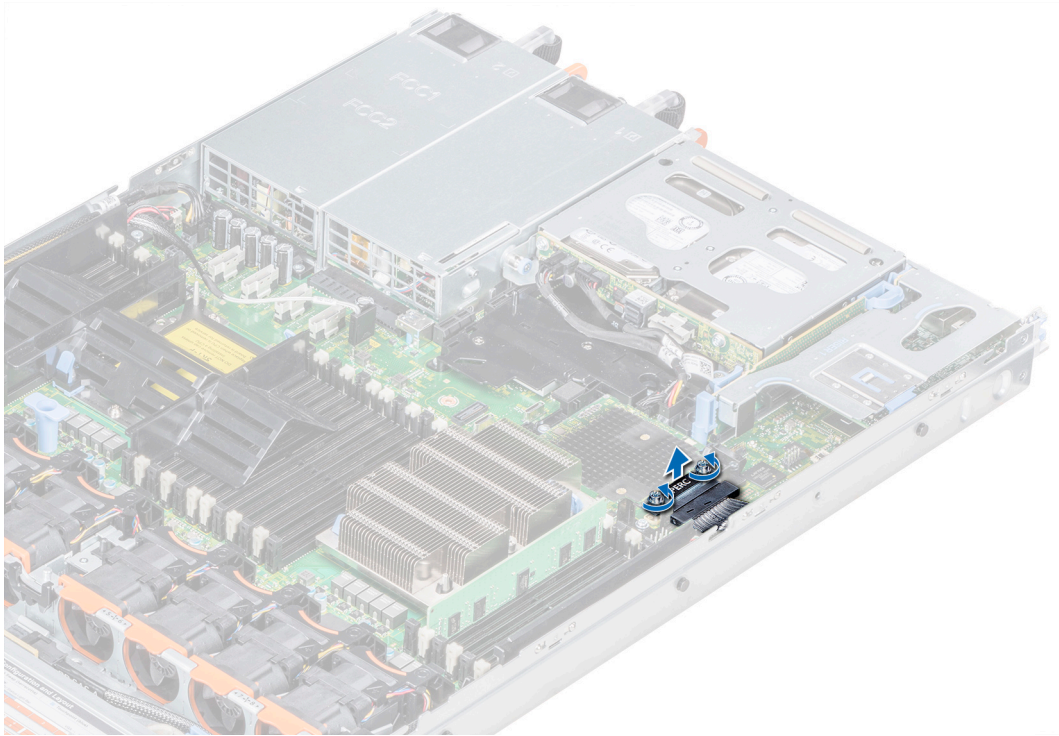

**Figure 24. Remove the cable**

3. Lift one end of the card and angle it to disengage the card from the card holder on the system board.
4. Lift the card out of the system.

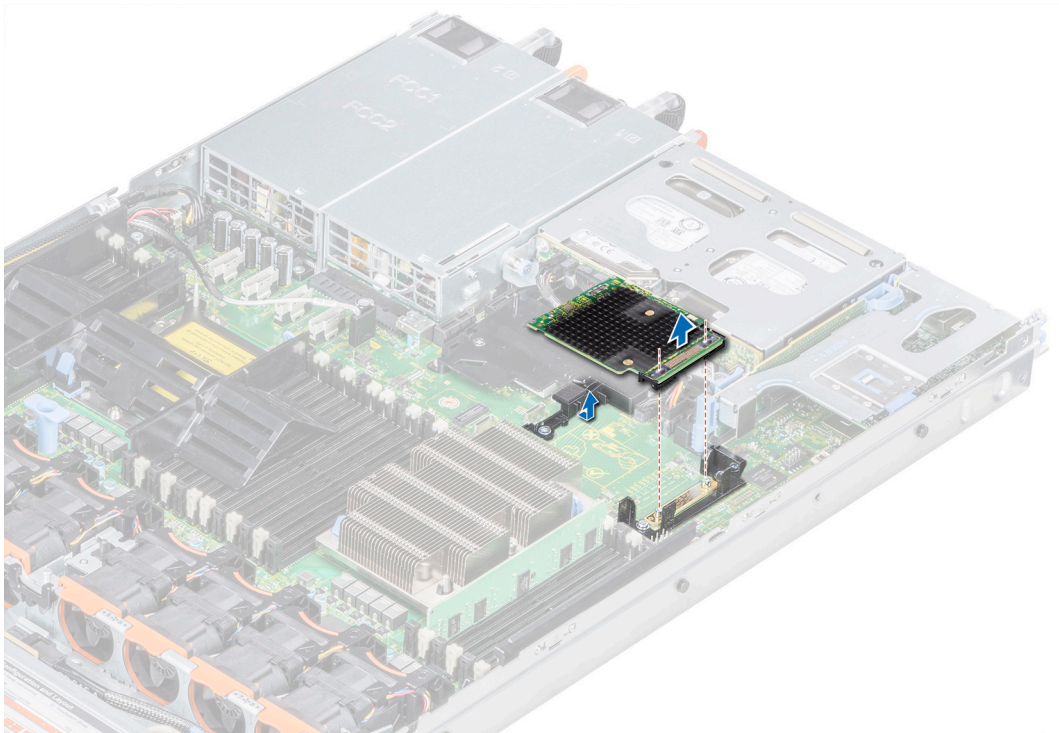

**Figure 25. Remove HBA350i MM**

# Install the HBA350i MM

## Prerequisites

**CAUTION:** Many repairs may only be done by a certified service technician. You should only perform troubleshooting and simple repairs as authorized in your product documentation, or as directed by the online or telephone service and support team. Damage due to servicing that is not authorized by Dell is not covered by your warranty. Read and follow the safety instructions that are shipped with your product.

## Steps

1. Angle the storage controller card and align the end of the card with the controller card connector on the system.
  2. Lower the connector side of the storage controller card into the storage controller card connector on the system board.
- NOTE:** Ensure that the slots on the system board align with the screw holes on the storage controller card connector.

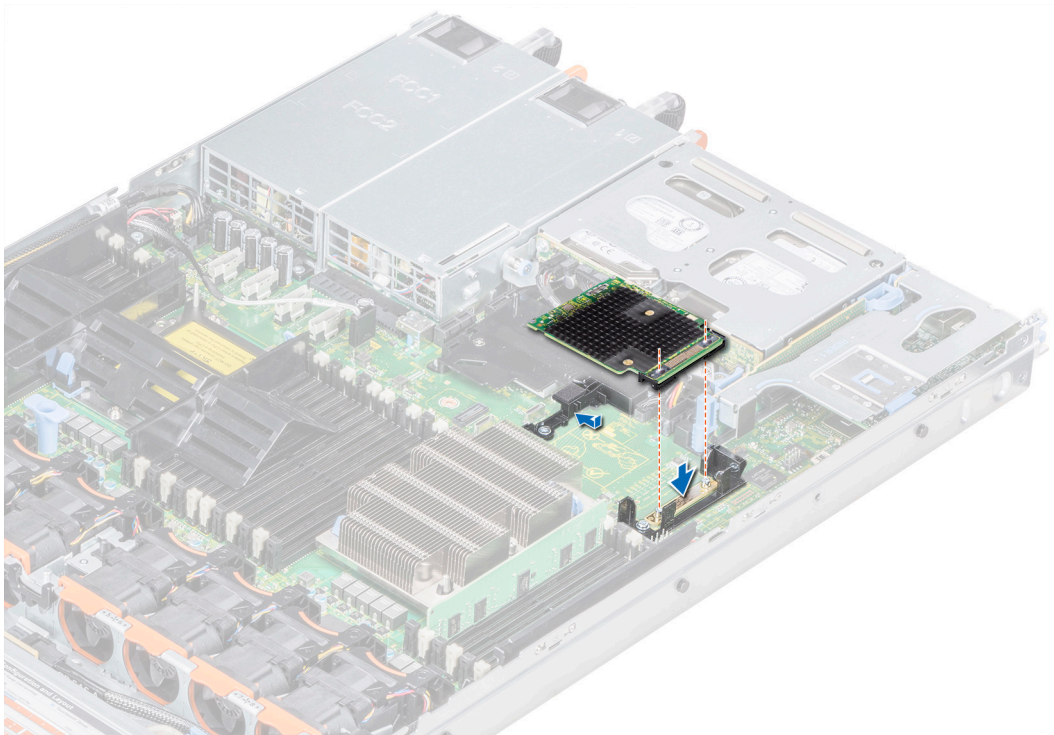

**Figure 26. Install Dell HBA350i MM**

3. Route the storage controller card cable along the wall of the system.
4. Align the screws on the storage controller card cable with the screw holes on the connector.
5. Using Phillips #2 screwdriver, tighten the screws to secure the storage controller card cable to the card connector on the system board.

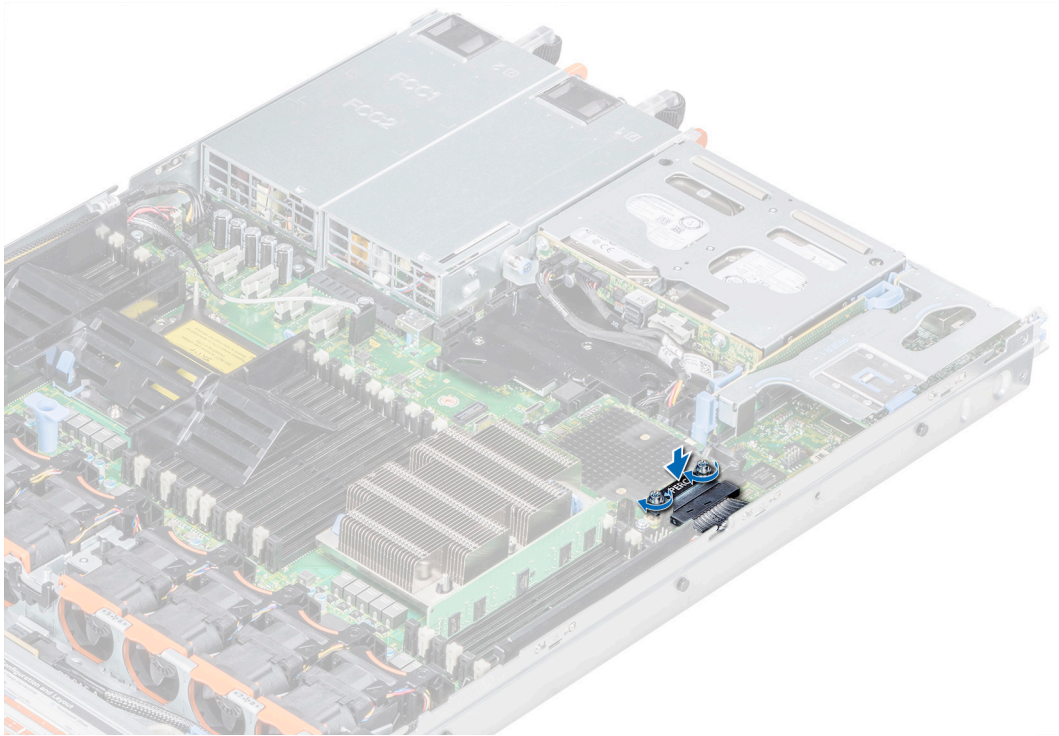

**Figure 27. Install the cable**

# Driver support for Dell HBA355i Adapter, Dell HBA355i Front, Dell HBA355e Adapter, Dell HBA350i MX, Dell HBA350i Adapter, and Dell HBA350i MM

The HBA350i Adapter, HBA355e Adapter, HBA355i Front, HBA350i MX, HBA350i Adapter, and Dell HBA350i MM cards require software drivers to operate with the supported operating systems.

This chapter contains the procedures for installing the drivers for the HBA355i Adapter, HBA355e Adapter, HBA355i Front, HBA350i MX, HBA350i Adapter, and HBA350i MM cards.

**NOTE:** The driver for HBA355i Adapter, HBA355i Front, HBA350i MX, HBA355e Adapter, and HBA350i Adapter for VMware ESXi is packaged within the VMware ESXi ISO image that is downloaded from Dell. For more information, see the VMware documentation at [www.dell.com/virtualizationsolutions](http://www.dell.com/virtualizationsolutions). It is not recommended to have drivers from controllers prior to HBA355e Adapter, HBA355i Adapter, HBA350i MX, HBA355i Front, HBA350i Adapter, and HBA350i MM on the same system.

The two methods for installing a driver that is discussed in this chapter are:

- **Installing a driver during operating system installation:** Use this method if you are performing a new installation of the operating system and want to include the drivers.
- **Updating existing drivers:** Use this method if the operating system and the HBA controllers are already installed and you want to update to the latest drivers.

## Topics:

- [Creating the device driver media](#)
- [Windows driver installation](#)
- [Linux driver installation](#)
- [Load the driver while installing an operating system](#)

## Creating the device driver media

Use one of the following two methods to create the device driver media:

- [Downloading Drivers From The Dell Support Website](#)
- [Downloading Drivers From The Dell Systems Service And Diagnostic Tools Media](#)

## Download and save Dell HBA355i Adapter, Dell HBA355i Front, Dell HBA355e Adapter, Dell HBA350i MX, Dell HBA350i Adapter, and Dell HBA350i MM drivers from the support site

### About this task

To download drivers from the Dell Support website:

### Steps

1. Go to [www.dell.com/support/home](http://www.dell.com/support/home).

2. Enter the service tag of your system in the **Choose by Service Tag to get started** field or select **Choose from a list of all Dell products**.
3. Select the **System Type, Operating System,** and **Category** from the drop-down list. The drivers that are applicable to your selection are displayed.
4. Download the drivers that you require to a USB drive, CD, or DVD.
5. During the operating system installation, use the media that you created to load the driver. For more information about reinstalling the operating system, see the relevant section for your operating system later in this guide.

## Download and save Dell HBA355i Adapter, Dell HBA355i Front, Dell HBA355e Adapter, Dell HBA350i MX, Dell HBA350i Adapter, and Dell HBA350i MM drivers from the Dell Systems Service and Diagnostic Tools

### About this task

To download drivers from the **Dell Systems Service and Diagnostic Tools** media:

### Steps

1. Insert the **Dell Systems Service and Diagnostics Tools** media in your system. The **Welcome to Dell Service and Diagnostic Utilities** screen is displayed.
2. Select your system model and operating system.
3. Click **Continue**.
4. From the list of drivers displayed, select the driver you require.
5. Select the self-extracting ZIP file and click **Run**.
6. Copy the driver to a CD, DVD, or USB drive.
7. Repeat steps 1 to 6 for all the drivers you require.

## Windows driver installation

Before you install the Windows driver for Dell HBA355i Adapter, Dell HBA355e Adapter, Dell HBA350i MX, Dell HBA350i Adapter, and Dell HBA350i MM you must first create a device driver media.

- Read the Microsoft **Getting Started** document that shipped with your operating system.
- Ensure that your system has the latest BIOS, firmware, and driver updates. If required, download the latest BIOS, firmware, and driver updates from [www.dell.com/support/home](http://www.dell.com/support/home).
- Create a device driver media using one of the methods listed below:
  - USB drive
  - CD
  - DVD

## Install Dell HBA355i Adapter, Dell HBA355i Front, Dell HBA355e Adapter, Dell HBA350i MX, Dell HBA350i Adapter, and Dell HBA350i MM drivers while newly installing the Windows Server 2016 or later

### About this task

To install the driver:

### Steps

1. Boot the system using the Windows Server 2016, or newer media.



2. Follow the on-screen instructions until you reach **Where do you want to install Windows Server 2016 or later** window, and then select **Load driver**.
3. As prompted, insert the installation media and browse to the appropriate location.
4. Select the driver files.
5. Click **Next** and continue installation.

## Install Dell HBA355i Adapter, Dell HBA355i Front, Dell HBA355e Adapter, Dell HBA350i MX, Dell HBA350i Adapter, and Dell HBA350i MM, driver on which the Windows Server 2016 or later is already installed

### About this task

Perform the following steps to configure the driver for the controller on which the Windows Server 2016 is already installed:

### Steps



1. Turn off the system.
2. Install the new SAS controller in the system.  
For detailed instructions on installing the controller in the system, see [Installation and removal of cards](#).
3. Turn on the system.  
The **Found New Hardware Wizard** screen displays the detected hardware device.
4. Click **Next**.
5. On the **Locate device driver** screen, select **Search for a suitable driver for my device** and click **Next**.
6. Browse and select the drivers from the **Locate Driver Files** screen.
7. Click **Next**.
8. Click **Finish** to complete the installation.
9. Reboot the system when prompted.

## Update Dell HBA355i Adapter, Dell HBA355i Front, Dell HBA355e Adapter, Dell HBA350i MX, Dell HBA350i Adapter, and Dell HBA350i MM driver that runs on Windows Server 2016 or later

### Prerequisites

 **NOTE:** Close all applications on your system before you update the driver.

### Steps

1. Insert the media containing the driver.
2. Select **Start > Settings > Control Panel > System**.  
The **System Properties** screen is displayed.  
 **NOTE:** The path to **System** might vary depending on the operating system family.
3. Click the **Hardware** tab.
4. Click **Device Manager**.  
The **Device Manager** screen is displayed.  
 **NOTE:** The path to **Device Manager** might vary depending on the operating system family.
5. Expand **Storage Controllers** by double-clicking the entry or by clicking on the plus (+) symbol next to **Storage Controllers**.
6. Double-click the controller for which you want to update the driver.
7. Click the **Driver** tab and click **Update Driver**.  
The screen to update the device driver wizard is displayed.

8. Select **Install from a list or specific location**.
9. Click **Next**.
10. Follow the steps in the wizard and browse to the location of the driver files.
11. Select the INF file from the drive media.
12. Click **Next** and continue the installation steps in the wizard.
13. Click **Finish** to exit the wizard and reboot the system for the changes to take place.

**NOTE:** Dell provides the Dell Update Package (DUP) to update drivers on systems running Windows Server 2016 and newer operating system. DUP is an executable application that updates drivers for specific devices. DUP supports command line interface and silent execution. For more information, see <https://www.dell.com/support>.

## Linux driver installation

The driver update disk (DUD) images are created only for those operating system releases in which the native (in-box) driver is insufficient for installation. In the event that an operating system is being installed with a corresponding DUD image, see, [Installing or updating the RPM driver package with KMOD support](#). If not, proceed with using the native device driver and then skip to the topic [Installing or Updating the RPM Driver Package With KMP Support](#).

**NOTE:** The driver update disk (DUD) images are created only for those operating system releases in which the native (in-box) driver is insufficient for installation. In the event that an operating system is being installed with a corresponding DUD image, follow the instructions below.

**NOTE:** To view the complete list of boot loader options, see the installation guide of your operating system.

**NOTE:** If using out-of-box drivers with RHEL 7 and higher, a tainted kernel message will be displayed in the log. RedHat does not provide a mechanism to sign external drivers for RHEL.

## Install or update a RPM driver package using the KMOD support

### Prerequisites

**NOTE:** This procedure is applicable for Red Hat Enterprise Linux 7.x and higher.

### About this task

Perform the following steps to install the RPM package with KMOD support:

### Steps

1. Uncompress the gzipped tarball driver release package.
2. Install the driver package using the command: `rpm -ihv kmodmegaraid_ sas-<version>.rpm`.

**NOTE:** Use `rpm -Uvh <package name>` when upgrading an existing package.

3. If the previous device driver is in use, you must reboot the system for the updated driver to take effect.
4. Verify the loaded driver version by running the following command: `modinfo megaraid_sas`.

## Install or update a RPM driver package using the KMP support

### Prerequisites

**NOTE:** This procedure is applicable for SUSE Enterprise Linux 15.x.

### About this task

Perform the following steps to install the RPM package with KMP support:

## Steps

1. Uncompress the gzipped tarball driver release package.
2. Install the driver package using the commands:
  - Use `rpm -Uvh kmod-mpt3sasxxxxx.rpm` to update an existing package.
  - Use `rpm -ivh kmod-mpt3sasxxxxx.rpm` to install the package.
3. If the previous device driver is in use, you must reboot the system for the updated driver to take effect.
4. Verify the loaded driver version by running the following command: `modinfo megaraid_sas`.

## Upgrading the Kernel

### About this task

When upgrading to a new kernel, you must reinstall the DKMS-enabled driver packages. Perform the following steps to update or install the driver for a new kernel:

## Steps

1. At a **terminal** window, type the following: `dkms build -m <module_name> - v <module version> - k <kernel version> dkms install -m <module_name> - v <module version> - k <kernel version>`.
2. To check if the driver is successfully installed in the new kernel, type: `dkms status`.  
A message similar to the following is displayed: `<driver name>, <driver version>, <new kernel version>: installed`.
3. If the previous device driver is in use, you must restart the system for the updated driver to take effect.

## Load the driver while installing an operating system

## Steps

1. Perform the following operation to install the driver media:
  - a. Download the HBA linux driver ISO, or install the LC driver pack.
  - b. Mount the ISO to the Server, burn the ISO to CD/DVD, or copy the ISO file to USB. The USB has to match with the ISO.
  - c. For LC driver pack, boot the life-cycle controller and go through the operating system deployment wizard.
2. Boot to the installer.
3. In the Installation screen, press E.
4. Perform the following operation:
  - If the operating system is Red Hat Enterprise Linux 7 or Red Hat Enterprise Linux 8, the CLI displays the syntax `vmlinux`. Enter **inst.dd**.

For example, when you are prompted with the command `vmlinux intrd=initrd.img inst.stage2=hd:LABEL=RHEL-7.0\x20x86_64 quiet inst.dd`.

- If the operating system is SLES 15, the CLI displays the syntax `linuxefi`. Enter **dud=1**.

For example, when you are prompted with the command `linuxefi/boot/x86_64/loader/linux splash=silent dud=1`.

 **NOTE:** Boot parameters may vary based on the operating system version. See operating system installation manuals for exact boot parameter syntax.

5. Attach the driver media (ISO, USB).
6. Press F10 to boot to the operating system.  
A screen is displayed prompting you to select the driver media (USB, CD, ISO, and so on).
7. When prompted, select the driver media.  
If applicable select the HBA driver `...mpt3sas...`

 **NOTE:** Ensure that the driver is selected with an X symbol.

8. Extract or load the driver.
9. Before proceeding or exiting the driver select menu, disconnect the driver media.

 **NOTE:** Ensure that you disconnect the driver media so that the drivers are loaded successfully. If the installation media is deleted, reattach it.

10. Press C or exit to go to the installation.

# Manage Dell HBA355i Adapter, Dell HBA355i Front, Dell HBA355e Adapter, Dell HBA350i MX, Dell HBA350i Adapter, and Dell HBA350i MM using HII configuration utility

The Human Interface Infrastructure (HII) configuration utility is a storage management application integrated into the System BIOS <F2>. It is used to manage physical disks. This utility is independent of the operating system. The HII configuration utility is a standardized way of viewing and setting device configuration. The HII configuration utility provides pre-operating system functionality and management for the following:

- Viewing physical device properties.
- Running physical device operations.
- Retrieving debug information.

## Topics:

- [Enter the HII configuration utility](#)
- [Exit the HII configuration utility](#)
- [Navigate to the configuration utility](#)
- [Controller management](#)

## Enter the HII configuration utility

### About this task

Perform the following steps to boot to the HII configuration utility:

### Steps

1. To view **System Setup**, power on the system, press F2, and click **System Setup Main Menu**. The System Setup Main Menu screen details are described as follows:

**Table 6. System setup menu**

Option	Description
System BIOS	Configure BIOS settings.
iDRAC Settings	The iDRAC settings utility is an interface that is used to set up and configure the iDRAC parameters by using Unified Extensible Firmware Interface (UEFI). You can enable or disable various iDRAC parameters by using the iDRAC settings utility. For more information about this utility, see the iDRAC user's guide at <a href="https://www.dell.com/poweredge/manuals">https://www.dell.com/poweredge/manuals</a>
Device Settings	Configure device settings for devices such as storage controllers and network cards.

2. Click **Device Settings**.

To access the management menu for the controller, use the arrow keys or the mouse.



**NOTE:** For more information these options, click **Help** on the upper-right corner of the browser screen.

# Exit the HII configuration utility

## About this task

To exit the HII configuration utility (Ctrl+C), perform the following steps:

### Steps

1. Press Esc on any menu screen.  
If there is only one controller, then a dialog box is displayed to confirm your choice.
2. Select **OK** to exit and press Enter.  
If multiple controllers are present, then the Esc key brings you to the **Controller Selection** screen.
3. Press Esc again to reach the exit screen.  
A dialog box is displayed to confirm your choice.
4. Select **OK** to exit and press Enter.

# Navigate to the configuration utility

## About this task

 **NOTE:** You can follow this procedure for all the cards to navigate to the configuration utility.

### Steps

1. Enter the HII configuration utility. See [Enter the HII configuration utility](#).  
The **Device Settings** screen displays a list of NIC ports and the Dell HBA355i Front configuration utility.
2. To access the HBA355i Front configuration utility, click **Dell HBA355i Front Configuration Utility**.  
The following list of configuration options is displayed:
  - Controller Properties
  - Refresh Topology
  - Device Properties

# Controller management

Controller management allows you to configure, manage, and view the controller properties.

 **NOTE:** Follow the procedure explained in this section for all the cards by selecting the respective card name.

## View the controller properties

The **View Controller Properties** screen allows you to view the controller properties.

In the **System Setup Main Menu**, click **Device Settings > Dell HBA355i Front Configuration Utility > Controller Management > View Controller Properties**

The table explains the **View Controller Properties** screen details:

**Table 7. View Controller Properties options**

Option	Description
Controller name	Controller name
Chip name	Controller chip name
PCI revision ID	Controller PCI revision ID
PCI Bus:Dev:Func	PCI Bus: Device: Controller function format

**Table 7. View Controller Properties options (continued)**

Option	Description
PCI Ven: Dev	Controller PCI Vendor ID and Device ID
PCI SSVen:SSDev	Controller PCI Sub Vendor ID and Sub Device ID
SAS address	Controller SAS Address
Package version	Controller package version
Number of SAS and SATA Devices*	Number of SAS and SATA devices supported
Number of enclosures*	Number of controller enclosures

\*This option is displayed only after you refresh the topology.

## Refresh the topology

Refresh topology allows you to rediscover the devices. It also helps you detect changes in the devices that are connected to the controller.

### Steps

1. In the **System Setup Main Menu**, click **Device Settings > Dell HBA355i Front Configuration Utility > Controller Management > Refresh Topology**.
2. Click **Ok** to refresh the topology.  
A screen is displayed **topology refresh process is completed successfully**.
3. Click **Ok** to continue.

## Device Properties

Device properties allows you to view the properties of the device.

### Steps

1. To view the **Device Properties** screen, power on the system, press F2, and click **System Setup Main Menu > Device Settings > Dell HBA355i Front Configuration Utility > Device Properties > Logical Enclosure (Bay ID=1, Enclosure Level=1)**.

**Table 8. Logical Enclosure (Bay ID=1, Enclosure Level=1) properties**

Option	Description
Enclosure logical ID	Logical ID of the enclosure
Enclosure level	Level of the enclosure
Bay ID	Bay ID of the enclosure
Vendor name	Vendor name of the enclosure
Product name	Product name of the enclosure
Product revision	Product revision of the enclosure
Number of slots	Number of slots that the enclosure supports

2. Click <Slot 0> SAS SSD drive model to view the properties on this device.  
If the physical disk ID has the letter **M** next to it, the disk has multiple paths that are connected to the system.

**Table 9. Device at Slot 0 Logical Enclosure 1 properties**

Option	Description
Device type	Type of the drive

**Table 9. Device at Slot 0 Logical Enclosure 1 properties (continued)**

<b>Option</b>	<b>Description</b>
Protocol	The drive protocol
Slot number	Drive slot number in the enclosure
Connector name	Name of the port as displayed in the utility
Vendor name	Vendor name of the drive
Product name	Product name of the drive
Revision name	Revision version of the drive
Serial number	Serial number of the drive
Capacity	Capacity of the drive
Logical/Physical sector size	Sector size of the selected drive
Multipath device	Drive supports multipath or not
SAS address	SAS address of the drive
Negotiated logical link rate	Negotiated logical link rate of the device
Negotiated physical link rate	Negotiated physical link rate of the device
Maximum drive rate	Maximum possible drive rate
Write cache	You can either enable or disable the Write Cache
Locate LED	You can either select On or Off the locate LED
Legacy OpROM boot device	You can either select Yes or No

3. Click **Apply Changes** to submit the changes selected.  
A confirmation screen is displayed. Click **Ok** to continue.
4. To choose another device click **Next Device in this Enclosure**.



# Update the firmware of Dell HBA355i Adapter, Dell HBA355i Front, Dell HBA355e Adapter, Dell HBA350i MX, Dell HBA350i Adapter, and Dell HBA350i MM using DUP

## Topics:

- [Upgrade firmware controller using Dell Update Package \(DUP\)](#)

## Upgrade firmware controller using Dell Update Package (DUP)

### Steps

1. Go to the Drivers and Downloads page on the support site.
2. Locate your controller.
3. Download the DUP file.
  - a. To upgrade by using Windows or iDRAC, download the Windows executable file.
  - b. To upgrade using Linux, download the **.bin** file.

 **NOTE:** For VMware, firmware must be upgraded by using iDRAC or the PERC CLI.
4. Install the DUP by doing one of the following:
  - a. For Windows, run the executable file in the Windows environment.
  - b. For Linux, run the **.bin** file in the Linux environment.
  - c. For iDRAC, click **System iDRAC > Maintenance > System Update**, upload Windows executable, and then install.

# Getting help

## Topics:

- [Recycling or End-of-Life service information](#)
- [Contacting Dell](#)
- [Receiving automated support with SupportAssist](#)

## Recycling or End-of-Life service information

Take back and recycling services are offered for this product in certain countries. If you want to dispose of system components, visit [www.dell.com/recyclingworldwide](http://www.dell.com/recyclingworldwide) and select the relevant country.

## Contacting Dell

Dell provides online and telephone based support and service options. If you do not have an active internet connection, you can find Dell contact information on your purchase invoice, packing slip, bill or Dell product catalog. The availability of services varies depending on the country and product, and some services may not be available in your area. To contact Dell for sales, technical assistance, or customer service issues:

### Steps

1. Go to [www.dell.com/support/home](http://www.dell.com/support/home).
2. Select your country from the drop-down menu on the lower right corner of the page.
3. For customized support:
  - a. Enter the system Service Tag in the **Enter a Service Tag, Serial Number, Service Request, Model, or Keyword** field.
  - b. Click **Submit**.  
The support page that lists the various support categories is displayed.
4. For general support:
  - a. Select your product category.
  - b. Select your product segment.
  - c. Select your product.  
The support page that lists the various support categories is displayed.
5. For contact details of Dell Global Technical Support:
  - a. Click [Contact Technical Support](#).
  - b. The **Contact Technical Support** page is displayed with details to call, chat, or e-mail the Dell Global Technical Support team.

## Receiving automated support with SupportAssist

Dell SupportAssist is an optional Dell Services offering that automates technical support for your Dell server, storage, and networking devices. By installing and setting up a SupportAssist application in your IT environment, you can receive the following benefits:

- Automated issue detection — SupportAssist monitors your Dell devices and automatically detects hardware issues, both proactively and predictively.
- Automated case creation — When an issue is detected, SupportAssist automatically opens a support case with Dell Technical Support.

- Automated diagnostic collection — SupportAssist automatically collects system state information from your devices and uploads it securely to Dell. This information is used by Dell Technical Support to troubleshoot the issue.
- Proactive contact — A Dell Technical Support agent contacts you about the support case and helps you resolve the issue.

The available benefits vary depending on the Dell Service entitlement purchased for your device. For more information about SupportAssist, go to [www.dell.com/supportassist](http://www.dell.com/supportassist).

# Troubleshooting

To get help with your Dell Host Bus Adapter series, you can contact your Dell Technical Service representative or see <https://www.dell.com/support>.

## Topics:

- [Known issues](#)

## Known issues

This section explains the known issues and expected behavior of the system when using the Host Bus Adapter.

### The Enclosure ID (EID) or Device ID (DID) may change after a restart

<b>Description</b>	When external storage enclosures are connected to a HBA355e adapter, the EID and DID may change either when the sever is restarted or when the SAS drive is hot-pushed or hot-pulled. The EID and DID fields are displayed in the PERC CLI output when using the UEFI or OSs (Linux and Microsoft Windows). This is a known issue and has no impact on the performance.
<b>Applies to</b>	HBA355e Adapter

### VendorID and ProductID for external tape drives

<b>Description</b>	When tape drive is connected to Dell HBA355e Adapter, the <b>VendorID</b> is displayed as De11 and <b>ProductID</b> is displayed as Non-vSES in all management interfaces.
<b>Applies to</b>	HBA355e Adapter

### VendorID and ProductID for internal tape drives

<b>Description</b>	When a tape drive is connected to Dell HBA355i Adapter or Dell HBA350i Adapter, the <b>VendorID</b> is displayed as DP and <b>ProductID</b> is displayed as BP15G in all management interfaces.
<b>Applies to</b>	HBA355i Adapter and HBA350i Adapter

### System reserved partition after Windows installation

<b>Description</b>	After the Windows operating system is installed, a system reserved partition may be created other than the drive you have selected.
<b>Applies to</b>	Dell HBA355i Adapter, Dell HBA355i Front, Dell HBA350i MX, Dell HBA350i Adapter, and Dell HBA350i MM

## Device settings in HII shows PCIe slot information

<b>Description</b>	In HII ( <b>System Setup &gt; Device Settings</b> ) show additional PCI slot information for Dell HBA355i Front form factor.
<b>Applies to</b>	HBA355i Front

## Select drive for operating system installation in legacy mode

<b>Description</b>	While installing an operating system in the Legacy BIOS mode, select one drive as the <b>Legacy OProm Boot Device</b> and use that device as the installation target to boot successfully.
<b>Applies to</b>	Dell HBA355i Adapter, Dell HBA355i Front, Dell HBA350i MX, Dell HBA350i Adapter, and Dell HBA350i MM

## Adapter configuration change message

<b>Description</b>	When you perform controller migration multiple times between systems, Legacy BIOS displays the message <i>Adapter configuration may have changed, reconfiguration is suggested.</i>
<b>Cause</b>	This error indicates that corresponding drives that are attached to the controller might not be enumerated properly.
<b>Solution</b>	Avoid controller migration multiple times between systems.
<b>Applies to</b>	Dell HBA355i Adapter, Dell HBA355e Adapter, Dell HBA355i Front, Dell HBA350i MX, Dell HBA350i Adapter, and Dell HBA350i MM

## Firmware upgrade or downgrade from DUP is not supported on Ubuntu

<b>Description</b>	DUP is not supported on Ubuntu.
<b>Solution</b>	Perform the firmware upgrade or downgrade using PERC CLI command <code>perccli /cx download file = <b>HBAxxxx.bin</b></code> , where x is controller number.
<b>Applies to</b>	Dell HBA355i Adapter, Dell HBA355e Adapter, Dell HBA350i Adapter, Dell HBA355i Front, Dell HBA350i MX, and Dell HBA350i MM, and Dell HBA350i MMLP.

## Documentation resources

This section provides information about the documentation resources for your system.

To view the document that is listed in the documentation resources table:

- From the Dell support site:
  1. Click the documentation link that is provided in the Location column in the table.
  2. Click the required product or product version.
-  **NOTE:** To locate the product name and model, see the front of your system.
- On the Product Support page, click **Manuals & documents**.
- Using search engines:
  - Type the name and version of the document in the search box.

**Table 10. Additional documentation resources for your system**

Task	Document	Location
Setting up your system	<p>For more information about installing and securing the system into a rack, see the Rail Installation Guide included with your rail solution.</p> <p>For information about setting up your system, see the <i>Getting Started Guide</i> document that is shipped with your system.</p>	<a href="http://www.dell.com/poweredgemanuals">www.dell.com/poweredgemanuals</a>
Configuring your system	<p>For information about the iDRAC features, configuring and logging in to iDRAC, and managing your system remotely, see the Integrated Dell Remote Access Controller User's Guide.</p> <p>For information about understanding Remote Access Controller Admin (RACADM) subcommands and supported RACADM interfaces, see the RACADM CLI Guide for iDRAC.</p> <p>For information about Redfish and its protocol, supported schema, and Redfish Eventing implemented in iDRAC, see the Redfish API Guide.</p> <p>For information about iDRAC property database group and object descriptions, see the Attribute Registry Guide.</p> <p>For information about Intel QuickAssist Technology, see the Integrated Dell Remote Access Controller User's Guide.</p>	<a href="http://www.dell.com/poweredgemanuals">www.dell.com/poweredgemanuals</a>
	<p>For information about earlier versions of the iDRAC documents.</p> <p>To identify the version of iDRAC available on your system, on the iDRAC web interface, click <b>? &gt; About</b>.</p>	<a href="http://www.dell.com/idracmanuals">www.dell.com/idracmanuals</a>

**Table 10. Additional documentation resources for your system (continued)**

Task	Document	Location
	For information about installing the operating system, see the operating system documentation.	<a href="http://www.dell.com/operatingsystemmanuals">www.dell.com/operatingsystemmanuals</a>
	For information about updating drivers and firmware, see the Methods to download firmware and drivers section in this document.	<a href="http://www.dell.com/support/drivers">www.dell.com/support/drivers</a>
Managing your system	For information about systems management software offered by Dell, see the Dell OpenManage Systems Management Overview Guide.	<a href="http://www.dell.com/poweredge manuals">www.dell.com/poweredge manuals</a>
	For information about setting up, using, and troubleshooting OpenManage, see the Dell OpenManage Server Administrator User's Guide.	<a href="http://www.dell.com/openmanagemanuals">www.dell.com/openmanagemanuals</a> > OpenManage Server Administrator
	For information about installing, using, and troubleshooting Dell OpenManage Enterprise, see the Dell OpenManage Enterprise User's Guide.	<a href="https://www.dell.com/openmanagemanuals">https://www.dell.com/openmanagemanuals</a>
	For information about installing and using Dell SupportAssist, see the Dell SupportAssist Enterprise User's Guide.	<a href="https://www.dell.com/serviceabilitytools">https://www.dell.com/serviceabilitytools</a>
	For information about partner programs enterprise systems management, see the OpenManage Connections Enterprise Systems Management documents.	<a href="http://www.dell.com/openmanagemanuals">www.dell.com/openmanagemanuals</a>
Understanding event and error messages	For information about the event and error messages generated by the system firmware and agents that monitor system components, go to <a href="http://qrl.dell.com">qrl.dell.com</a> > <b>Look Up</b> > <b>Error Code</b> , type the error code, and then click <b>Look it up</b> .	<a href="http://www.dell.com/qrl">www.dell.com/qrl</a>
Troubleshooting your system	For information about identifying and troubleshooting the PowerEdge server issues, see the Server Troubleshooting Guide.	<a href="http://www.dell.com/poweredge manuals">www.dell.com/poweredge manuals</a>