



19" Touchscreen with 5-Wire Resistive Touch Technology

The T1931SR-B1S is based on 5-wire resistive touch technology. The price / performance ratio is ideal for the budget conscious user while quality and performance are certainly not compromised. The display includes both analogue (VGA) and digital inputs (HDMI and DisplayPort) with touchscreen connectivity via USB offering great flexibility. The flexible stand can be positioned at several angles creating a comfortable and ergonomic user experience and the integrated cable management system hides all the cables and electrical wires giving a neat and cable-free workspace. The T1931SR-B1S can be used in a variety of environments, especially recommended for shops, restaurants and industrial purposes.



Touch technology - Resistive

5-wire resistive touchscreens are very durable and can be used in a variety of environments. They are especially recommended for shops, restaurants and industrial purposes.



IP54

The IP Code classifies how resistant a device is to foreign objects and moisture. IP54 means that the monitor will operate in dusty conditions, and will resist splashing water.

01 DISPLAY CHARACTERISTICS

Diagonal	19", 48cm
Panel	IPS
Native resolution	1280 x 1024 (1.3 megapixel)
Aspect ratio	5:4
Panel brightness	250 cd/m ²
Brightness	193 cd/m ² with touch
Light transmittance	77%
Static contrast	1000:1 with touch
Response time (BTB)	14ms
Viewing zone	horizontal/vertical: 178°/178°, right/left: 89°/89°, up/down: 89°/89°
Colour support	16.7mln
Horizontal Sync	31.5 - 80kHz
Viewable area W x H	374.8 x 299.8mm, 14.7 x 11.8"
Pixel pitch	0.293mm
Bezel colour and finish	black, matte

02 TOUCH

Touch technology	serial resistive
Touch points	1
Touch method	stylus, finger, glove
Touch interface	USB
Supported operating systems	All iiyama monitors are Plug & Play and compatible with Windows and Linux. For details regarding the supported OS for the touch models, please refer to the driver instruction file available in the downloads section.

03 INTERFACES / CONNECTORS / CONTROLS

Analog signal input	VGA x1
Digital signal input	HDMI x1 DisplayPort x1
Audio output	Speakers 2 x 1W
HDCP	yes

04 FEATURES

Water and dust protection	IP54 (front)
OSD key lock	yes

05 GENERAL

OSD languages	EN, DE, FR, ES, IT, CN, JP
Control buttons	Menu, Scroll up/ Brightness, Scroll down/ Mute, Select, Power
User controls	contrast, brightness, lock mode (power, OSD), auto adjust, OSD, H. position, V. position, H-size, fine, OSD H. position, OSD V. position, OSD timeout, reset, input select, OSD language, colour temperature, volume, mute
Convenience	Kensington-lock™ prepared
Plug&Play	DDC2B

06 MECHANICAL

Tilt angle	90° up; 5° down
VESA mounting	100 x 100mm
Cable management system	yes

07 ACCESSORIES INCLUDED

Cables	power, USB, HDMI, Audio, DP
Guides	quick start guide, safety guide
Cable cover	yes

08 POWER MANAGEMENT

Power supply unit	internal
Power supply	AC 100 - 240V, 50/60Hz
Power usage	20W typical, 1.5W stand by, 0.3W off mode

09 SUSTAINABILITY

Regulations	CE, EAC, RoHS support, ErP, WEEE, cULus, VCCI, REACH, UKCA
Energy efficiency class (Regulation (EU) 2017/1369)	E
REACH SVHC	above 0.1%: Lead

10 DIMENSIONS / WEIGHT

Product dimensions W x H x D	432 x 431.5 x 239.5mm
Box dimensions W x H x D	530 x 495 x 190mm
Weight (without box)	6kg
Weight (with box)	8kg
EAN code	4948570122172

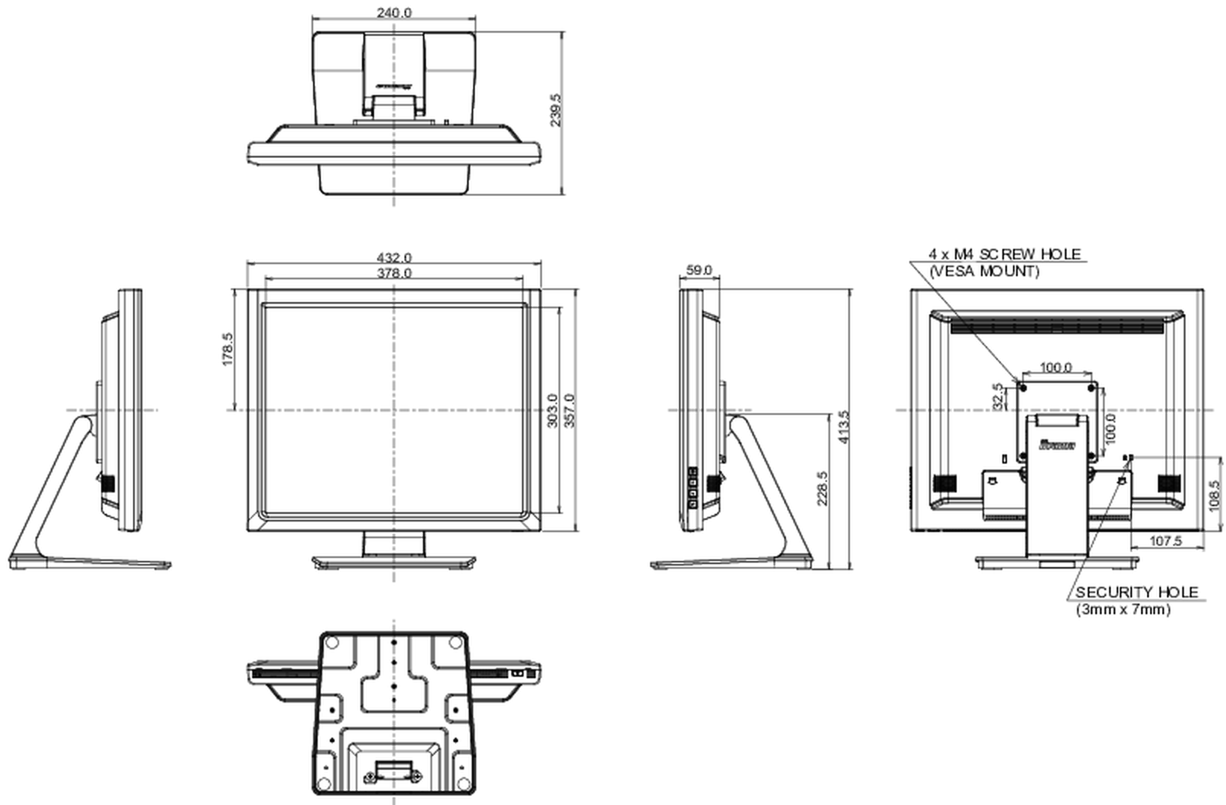

All trademarks and registered trademarks acknowledged. E & O E. Specification subject to change without notice. All LCD's comply with ISO-9241-307:2008 in connection with pixel defects.

© IYAMA CORPORATION. ALL RIGHTS RESERVED