

Dell PowerEdge R7515

Installation and Service Manual

Notes, cautions, and warnings

 **NOTE:** A NOTE indicates important information that helps you make better use of your product.

 **CAUTION:** A CAUTION indicates either potential damage to hardware or loss of data and tells you how to avoid the problem.

 **WARNING:** A WARNING indicates a potential for property damage, personal injury, or death.

Chapter 1: About this document	7
Chapter 2: System overview	8
Front view of the system.....	8
Left control panel view.....	11
Right control panel.....	12
Rear view of the system.....	13
Inside the system.....	16
Locating the Express Service Code and Service Tag.....	17
System Information label.....	18
Rail sizing and rack compatibility matrix.....	21
Chapter 3: Initial system setup and configuration	22
Setting up the system.....	22
iDRAC configuration.....	22
Options to set up iDRAC IP address.....	22
Options to log in to iDRAC.....	23
Resources to install operating system.....	24
Options to download firmware	24
Options to download and install OS drivers	24
Downloading drivers and firmware.....	25
Chapter 4: Installing and removing system components	26
Safety instructions.....	26
Before working inside your system.....	27
After working inside your system.....	27
Recommended tools.....	27
Optional front bezel.....	28
Removing the front bezel.....	28
Installing the front bezel.....	28
System cover.....	29
Removing the system cover.....	29
Installing the system cover.....	30
Drive backplane cover.....	31
Removing the drive backplane cover.....	31
Installing the drive backplane cover.....	32
Air shroud.....	34
Removing the air shroud.....	34
Installing the air shroud.....	35
Cooling fan.....	37
Removing a cooling fan.....	37
Installing a cooling fan.....	38
Intrusion switch module.....	40
Removing the intrusion switch.....	40

Installing the intrusion switch.....	40
Drives.....	41
Removing a drive blank.....	41
Installing the drive blank.....	42
Removing the drive carrier.....	42
Installing the drive carrier.....	43
Removing the drive from the drive carrier.....	44
Installing the drive into the drive carrier.....	45
Cable routing.....	46
Drive backplane.....	49
Drive backplane.....	49
Removing the drive backplane.....	51
Installing the drive backplane.....	52
Removing the rear drive backplane.....	53
Installing the rear drive backplane.....	53
Rear drive cage.....	54
Removing the rear drive cage.....	54
Installing the rear drive cage.....	55
System memory.....	56
System memory guidelines.....	56
General memory module installation guidelines.....	57
Removing a memory module.....	60
Installing a memory module.....	61
Processor and heat sink.....	62
Removing the heat sink.....	62
Removing the processor.....	63
Installing the processor.....	65
Installing the heat sink.....	67
Expansion cards and expansion card risers.....	69
Expansion card installation guidelines.....	69
Removing the expansion card riser.....	74
Installing the expansion card riser.....	76
Removing an expansion card.....	78
Installing an expansion card.....	80
Removing an expansion card from the expansion card riser.....	82
Installing an expansion card into the expansion card riser.....	85
Removing an accelerator card.....	88
Installing an accelerator card.....	90
M.2 SSD module on BOSS-S1 adapter card.....	92
Removing the M.2 SSD module.....	92
Installing the M.2 SSD module.....	93
Optional IDSDM module.....	94
Removing the IDSDM card.....	94
Installing IDSDM card.....	95
Micro SD card.....	96
Removing the MicroSD card.....	96
Installing the MicroSD card.....	97
LOM riser card.....	98
Removing the LOM riser card.....	98
Installing the LOM riser card.....	100

Storage controller card.....	102
Removing the mini PERC card air shroud.....	102
Installing the mini PERC card air shroud.....	103
Removing the internal mini PERC card.....	104
Installing the Internal mini PERC card.....	105
System battery	106
Replacing the system battery.....	106
Optional internal USB memory key.....	108
Replacing the optional internal USB memory key.....	108
Optional optical drive.....	109
Removing the optical drive.....	109
Installing the optional optical drive.....	111
Power supply unit.....	112
Hot spare feature.....	112
Removing a power supply unit blank.....	113
Removing a power supply unit.....	113
Installing a power supply unit.....	114
Installing a power supply unit blank.....	115
Power interposer board.....	116
Removing the power interposer board.....	116
Installing the power interposer board.....	117
System board.....	118
Removing the system board.....	118
Installing the system board.....	119
Restoring the system using Easy Restore.....	121
Manually update the Service Tag.....	121
Trusted Platform Module.....	122
Upgrading the Trusted Platform Module.....	122
Initializing TPM for users.....	123
Initializing the TPM 1.2 for users.....	123
Initializing the TPM 2.0 for users.....	123
Control panel.....	123
Removing the left control panel.....	123
Installing the left control panel.....	124
Removing the right control panel.....	125
Installing the right control panel.....	126

Chapter 5: Jumpers and connectors..... 128

System board connectors.....	129
System board jumper settings.....	130
Disabling a forgotten password.....	130

Chapter 6: System diagnostics and indicator codes..... 131

Status LED indicators.....	131
System health and system ID indicator codes.....	132
iDRAC Quick Sync 2 indicator codes.....	133
iDRAC Direct LED indicator codes.....	133
LCD panel.....	134
Viewing Home screen.....	134

Setup menu.....	135
View menu.....	135
NIC indicator codes.....	136
Power supply unit indicator codes.....	136
Drive indicator codes.....	137
Using system diagnostics.....	138
Dell Embedded System Diagnostics.....	138
Chapter 7: Known Issue.....	140
Chapter 8: Getting help.....	141
Recycling or End-of-Life service information.....	141
Contacting Dell.....	141
Accessing system information by using QRL.....	141
Quick Resource Locator for PowerEdge R7515 system.....	142
Receiving automated support with SupportAssist	142
Chapter 9: Documentation resources.....	143

About this document

This document provides an overview about the system, information about installing and replacing components, diagnostic tools, and guidelines to be followed while installing certain components.

System overview

The PowerEdge R7515 is a 2U rack server that supports:

- One AMD EPYC 7002 series processor
- One AMD EPYC 7003 series processor
- 16 DIMM slots
- Two redundant power supply units
- Up to 8 x 3.5-inch, 12 x 3.5-inch, 12 x 3.5-inch + 2 x 3.5-inch (rear), or 24 x 2.5-inch SAS/SATA or NVMe drives (up to 12 x 2.5-inch SAS/SATA + 12 x 2.5-inch SAS/SATA/ NVMe drives), 8 x 2.5-inch (SAS/SATA/ NVMe) + 16 NVMe drives or 24 x 2.5-inch NVMe drive.

NOTE: For more information about how to hot swap NVMe PCIe SSD U.2 device, see the *Dell Express Flash NVMe PCIe SSD User's Guide* at <https://www.dell.com/support> > **Browse all Products** > **Data Center Infrastructure** > **Storage Adapters & Controllers** > **Dell PowerEdge Express Flash NVMe PCIe SSD** > **Documentation** > **Manuals and Documents**.

NOTE: All instances of SAS and SATA drives are seen as drives in this document, unless specified otherwise.

WARNING: Consumer-Grade GPU should not be installed or used in the Enterprise Server products.

For more information, see the Dell EMC PowerEdge R7515 Technical Specifications on the product documentation page.

Topics:

- [Front view of the system](#)
- [Rear view of the system](#)
- [Inside the system](#)
- [Locating the Express Service Code and Service Tag](#)
- [System Information label](#)
- [Rail sizing and rack compatibility matrix](#)

Front view of the system

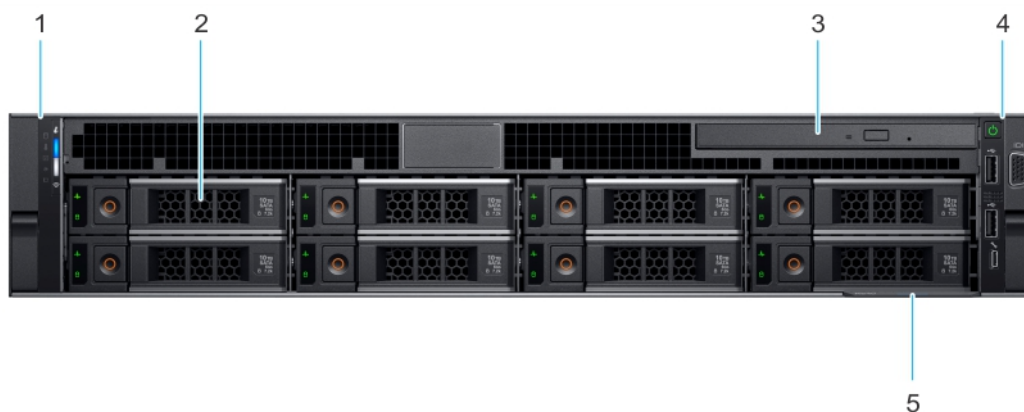

Figure 1. Front view of the 8 x 3.5-inch drive system

Table 1. Features available on the front of the system

Item	Ports, panels, and slots	Icon	Description
1	Left control panel	N/A	<p>Contains the system health, system ID, status LED, and the iDRAC Quick Sync 2 (wireless) indicator.</p> <p>NOTE: The iDRAC Quick Sync 2 indicator is available only on certain configurations.</p> <ul style="list-style-type: none"> • Status LED: Enables you to identify any failed hardware components. There are up to five status LEDs and an overall system health LED (Chassis health and system ID) bar. For more information, see the Status LED indicators section. • Quick Sync 2 (wireless): Indicates a Quick Sync enabled system. The Quick Sync feature is optional. This feature allows management of the system by using mobile devices called as OpenManage Mobile (OMM) feature. Using iDRAC Quick Sync 2 with OpenManage Mobile (OMM) aggregates hardware or firmware inventory and various system level diagnostic and error information that can be used in troubleshooting the system. For more information, see the <i>Integrated Dell Remote Access Controller User's Guide</i> available at https://www.dell.com/idracmanuals
2	Drive (8)	N/A	Enables you to install drives that are supported on your system.
3	Optical drive (optional)	N/A	One optional slim SATA DVD-ROM drive or DVD+/-RW drive.
4	Right control panel	N/A	Contains the power button, USB port, iDRAC Direct micro port, and the iDRAC Direct status LED.
5	Information tag		The Information tag is a slide-out label panel that contains system information such as Service Tag, NIC, MAC address, and so on. If you have opted for the secure default access to iDRAC, the Information tag also contains the iDRAC secure default password.



Figure 2. Front view of the 12 x 3.5-inch drive system

Table 2. Features available on the front of the system

Item	Ports, panels, and slots	Icon	Description
1	Left control panel	N/A	Contains the system health, system ID, status LED, and the iDRAC Quick Sync 2 (wireless) indicator.

Table 2. Features available on the front of the system (continued)

Item	Ports, panels, and slots	Icon	Description
			<p>NOTE: The iDRAC Quick Sync 2 indicator is available only on certain configurations.</p> <ul style="list-style-type: none"> Status LED: Enables you to identify any failed hardware components. There are up to five status LEDs and an overall system health LED (Chassis health and system ID) bar. For more information, see the Status LED indicators section. Quick Sync 2 (wireless): Indicates a Quick Sync enabled system. The Quick Sync feature is optional. This feature allows management of the system by using mobile devices called as OpenManage Mobile (OMM) feature. Using iDRAC Quick Sync 2 with OpenManage Mobile (OMM) aggregates hardware or firmware inventory and various system level diagnostic and error information that can be used in troubleshooting the system. For more information, see the <i>Integrated Dell Remote Access Controller User's Guide</i> available at https://www.dell.com/idracmanuals
2	Drive (12)	N/A	Enables you to install drives that are supported on your system.
3	Right control panel	N/A	Contains the power button, USB port, iDRAC Direct micro port, and the iDRAC Direct status LED.
4	Information tag		The Information tag is a slide-out label panel that contains system information such as Service Tag, NIC, MAC address, and so on. If you have opted for the secure default access to iDRAC, the Information tag also contains the iDRAC secure default password.



Figure 3. Front view of the 24 x 2.5-inch drive system

Table 3. Features available on the front of the system

Item	Ports, panels, and slots	Icon	Description
1	Left control panel	N/A	<p>Contains the system health, system ID, status LED, and the iDRAC Quick Sync 2 (wireless) indicator.</p> <p>NOTE: The iDRAC Quick Sync 2 indicator is available only on certain configurations.</p> <ul style="list-style-type: none"> Status LED: Enables you to identify any failed hardware components. There are up to five status LEDs and an overall system health LED (Chassis health and system ID) bar. For more information, see the Status LED indicators section.

Table 3. Features available on the front of the system (continued)

Item	Ports, panels, and slots	Icon	Description
			<ul style="list-style-type: none"> Quick Sync 2 (wireless): Indicates a Quick Sync enabled system. The Quick Sync feature is optional. This feature allows management of the system by using mobile devices called as OpenManage Mobile (OMM) feature. Using iDRAC Quick Sync 2 with OpenManage Mobile (OMM) aggregates hardware or firmware inventory and various system level diagnostic and error information that can be used in troubleshooting the system. For more information, see the <i>Integrated Dell Remote Access Controller User's Guide</i> available at https://www.dell.com/idracmanuals
2	Drive (24)	N/A	Enables you to install drives that are supported on your system.
3	Right control panel	N/A	Contains the power button, USB port, iDRAC Direct micro port, and the iDRAC Direct status LED.
4	Information tag		The Information tag is a slide-out label panel that contains system information such as Service Tag, NIC, MAC address, and so on. If you have opted for the secure default access to iDRAC, the Information tag also contains the iDRAC secure default password.

For more information, see the Dell EMC PowerEdge R7515 Technical Specifications on the product documentation page.

Left control panel view

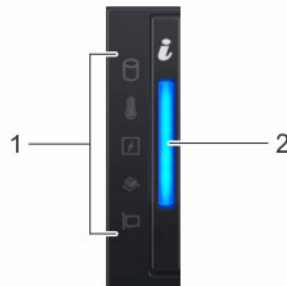

Figure 4. Left control panel without optional iDRAC Quick Sync 2.0 indicator

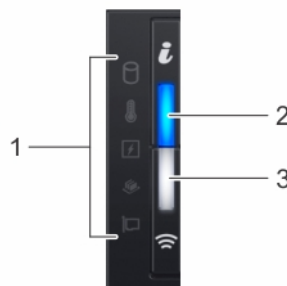





Figure 5. Left control panel with optional iDRAC Quick Sync 2.0 indicator

Table 4. Left control panel

Item	Indicator, button, or connector	Icon	Description
1	Status LED indicators	N/A	Indicates the status of the system. For more information, see the Status LED indicators section.
2	System health and system ID indicator		Indicates the system health. For more information, see the System health and system ID indicator codes section.
3	iDRAC Quick Sync 2 wireless indicator (optional)		Indicates if the iDRAC Quick Sync 2 wireless option is activated. The Quick Sync 2 feature allows management of the system using mobile devices. This feature aggregates hardware/firmware inventory and various system level diagnostic/error information that can be used in troubleshooting the system. You can access system inventory, Dell Lifecycle Controller logs or system logs, system health status, and also configure iDRAC, BIOS, and networking parameters. You can also launch the virtual Keyboard, Video, and Mouse (KVM) viewer and virtual Kernel-based Virtual Machine (KVM), on a supported mobile device. For more information, see the Integrated Dell Remote Access Controller User's Guide at www.dell.com/poweredge manuals

 **NOTE:** For more information about the indicator codes, see the [System diagnostics and indicator codes](#) section.

Right control panel

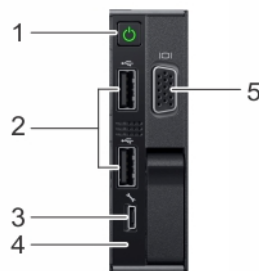

Figure 6. Right control panel view

Table 5. Right control panel







Item	Indicator or button	Icon	Description
1	Power button		Indicates if the system is powered on or off. Press the power button to manually power on or off the system.  NOTE: Press the power button to gracefully shut down an ACPI-compliant operating system.
2	USB 2.0-compliant port		The USB port is a 4-pin connector and 2.0-compliant. This port enables you to connect USB devices to the system.
3	iDRAC Direct port (Micro-AB USB)		The iDRAC direct Micro USB port enables you to access the iDRAC Direct Micro USB features. For more information, see the <i>Integrated Dell Remote Access Controller User's Guide</i> available at https://www.dell.com/idracmanuals  NOTE: You can configure iDRAC Direct by using a USB to micro USB (type AB) cable, which you can connect to your laptop or tablet. Cable length should not exceed 3 feet (0.91 meters). Performance could be affected by cable quality.

Table 5. Right control panel (continued)

Item	Indicator or button	Icon	Description
4	iDRAC Direct LED indicator	N/A	The iDRAC Direct LED indicator lights up to indicate that the iDRAC Direct port is actively connected to a device.
5	VGA port		Enables you to connect a display device to the system. For more information, see the Dell EMC PowerEdge R7515 Technical Specifications.

NOTE: For the system to power on successfully, ensure the right control panel is connected well to the system.

NOTE: For more information about the ports, see the Dell EMC PowerEdge R7515 Technical Specifications.

Rear view of the system

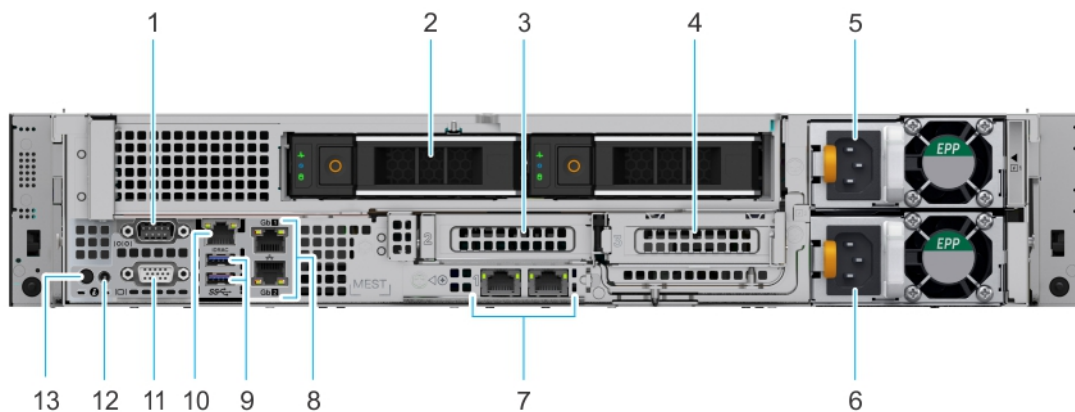

Figure 7. Rear view of the system with two rear drives

Table 6. Rear view of the system with two rear drives







Item	Ports, panels, or slots	Icon	Description
1	Serial port		Enables you to connect a serial device to the system.
2	Drive	N/A	Enables you to install drives that are supported on your system.
3	PCIe expansion card riser 1A (slot 2)	N/A	The expansion card riser enables you to connect PCI Express expansion cards.
4	PCIe expansion card riser 2 (slot 3)	N/A	The expansion card riser enables you to connect PCI Express expansion cards.
5	Power supply unit (PSU)	N/A	For information about the PSU configurations, see the Dell EMC PowerEdge R7515 Technical Specifications on the product documentation page.
6	Power supply unit (PSU)	N/A	For information about the PSU configurations, see the Dell EMC PowerEdge R7515 Technical Specifications on the product documentation page.
7	LOM Riser Ethernet port (2) (Optional) (slot 1)		The NIC ports that are integrated on the LAN on Motherboard (LOM) riser provide network connectivity.
8	Ethernet ports (2)		The Ethernet ports that are integrated on the system board provide network connectivity. These NIC ports can also be shared with iDRAC when iDRAC network settings is set to shared mode.
9	USB 3.0 port (2)		These USB ports support USB 3.0.

Table 6. Rear view of the system with two rear drives (continued)

Item	Ports, panels, or slots	Icon	Description
10	iDRAC dedicated port		Enables you to remotely access iDRAC. For more information, see the iDRAC User's Guide at www.dell.com/poweredgemanuals .
11	VGA port		Enables you to connect a display device to the system.
12	System status indicator cable port (CMA)	N/A	Enables you to connect the status indicator cable and view system status when the CMA is installed.
13	System identification button		<p>Press the system ID button:</p> <ul style="list-style-type: none"> To locate a particular system within a rack. To turn the system ID on or off. <p>To reset iDRAC, press and hold the button for 16 seconds.</p> <p>i NOTE:</p> <ul style="list-style-type: none"> To reset iDRAC using system ID, ensure that the system ID button is enabled in the iDRAC setup. If the system stops responding during POST, press and hold the system ID button (for more than five seconds) to enter the BIOS progress mode.

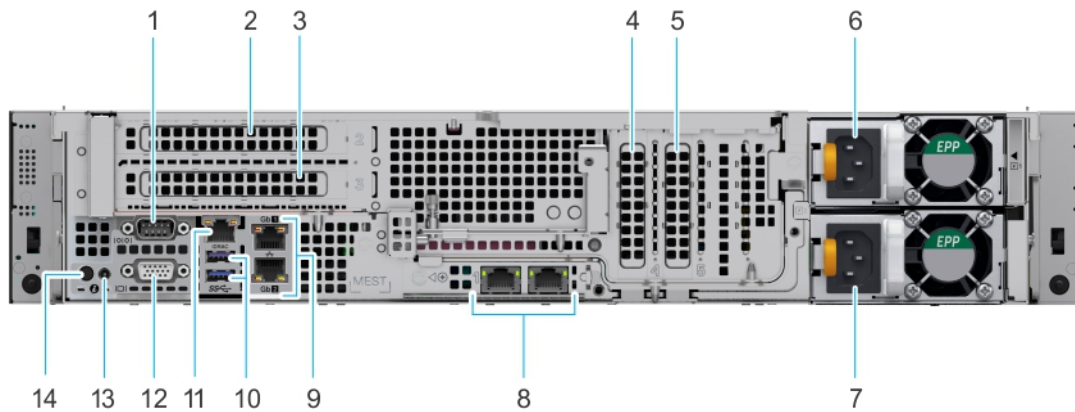

Figure 8. Rear view of the system with no rear drives

Table 7. Rear view of the system with no rear drives







Item	Ports, panels, or slots	Icon	Description
1	Serial port		Enables you to connect a serial device to the system.
2	PCIe expansion card riser 1B (slot 2)	N/A	The expansion card slot enables you to connect PCI Express expansion cards. F
3	PCIe expansion card riser 1B (slot 3)	N/A	The expansion card slot enables you to connect PCI Express expansion cards.
4	PCIe slot 4	N/A	The expansion card riser enables you to connect PCI Express expansion cards.
5	PCIe slot 5	N/A	The expansion card riser enables you to connect PCI Express expansion cards.
6	Power supply unit (PSU)	N/A	For information about the PSU configurations, see the Dell EMC PowerEdge R7515 Technical Specifications on the product documentation page.

Table 7. Rear view of the system with no rear drives (continued)

Item	Ports, panels, or slots	Icon	Description
7	Power supply unit (PSU)	N/A	For information about the PSU configurations, see the Dell EMC PowerEdge R7515 Technical Specifications on the product documentation page.
8	LOM Riser Ethernet port (2) (Optional) (slot 1)		The NIC ports that are integrated on the LAN on Motherboard (LOM) riser provide network connectivity.
9	Ethernet ports (2)		The Ethernet ports that are integrated on the system board provide network connectivity. These NIC ports can also be shared with iDRAC when iDRAC network settings is set to shared mode.
10	USB 3.0 port (2)		These USB ports support USB 3.0.
11	iDRAC dedicated port		Enables you to remotely access iDRAC. For more information, see the iDRAC User's Guide at www.dell.com/poweredgemanuals .
12	VGA port		Enables you to connect a display device to the system.
13	System status indicator cable port (CMA)	N/A	Enables you to connect the status indicator cable and view system status when the CMA is installed.
14	System identification button		<p>Press the system ID button:</p> <ul style="list-style-type: none"> • To locate a particular system within a rack. • To turn the system ID on or off. <p>To reset iDRAC, press and hold the button for 16 seconds.</p> <p>NOTE:</p> <ul style="list-style-type: none"> • To reset iDRAC using system ID, ensure that the system ID button is enabled in the iDRAC setup. • If the system stops responding during POST, press and hold the system ID button (for more than five seconds) to enter the BIOS progress mode.

For more information, see the Dell EMC PowerEdge R7515 Technical Specifications on the product documentation page.

Inside the system

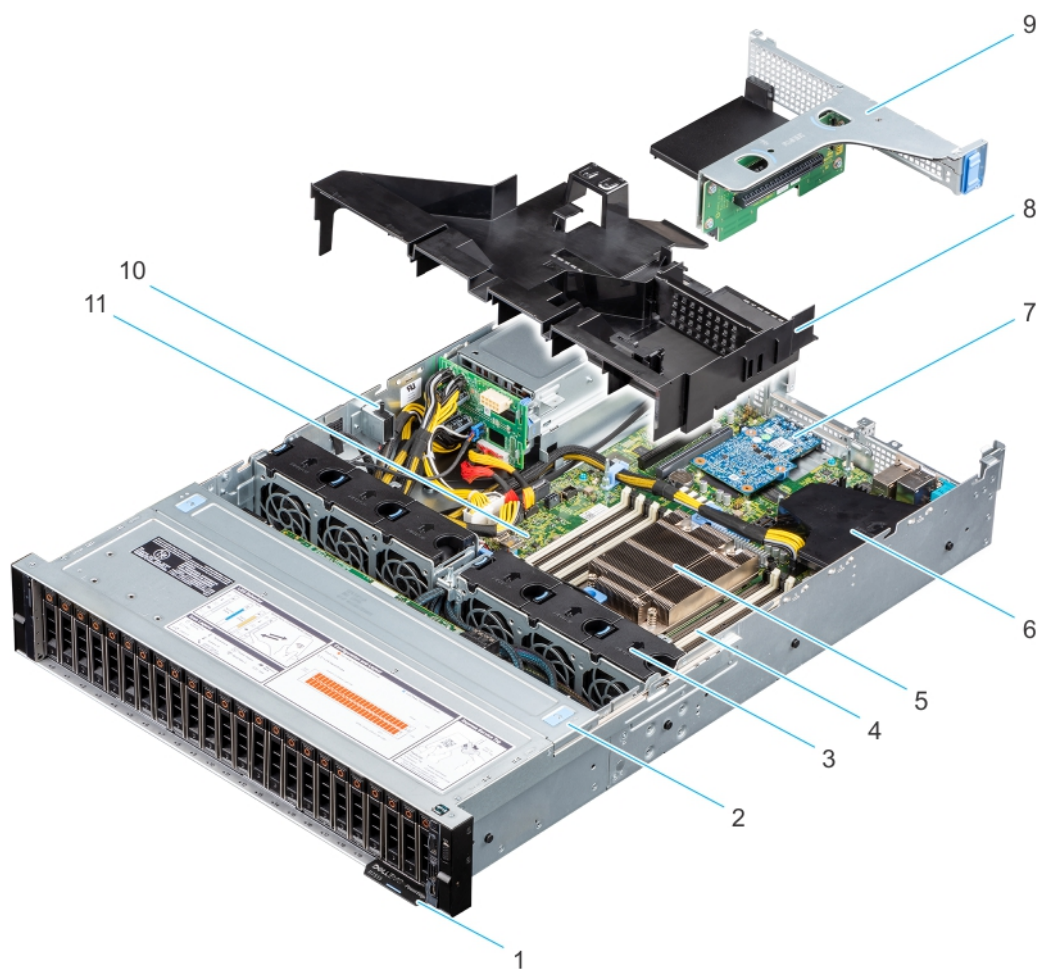

Figure 9. Inside the system

1. Information tag
2. Drive backplane cover
3. Fan (6)
4. Memory module sockets
5. Heat sink
6. Internal PERC mini card and air shroud
7. LOM riser card
8. Air shroud
9. Riser 1B
10. Intrusion switch
11. System board

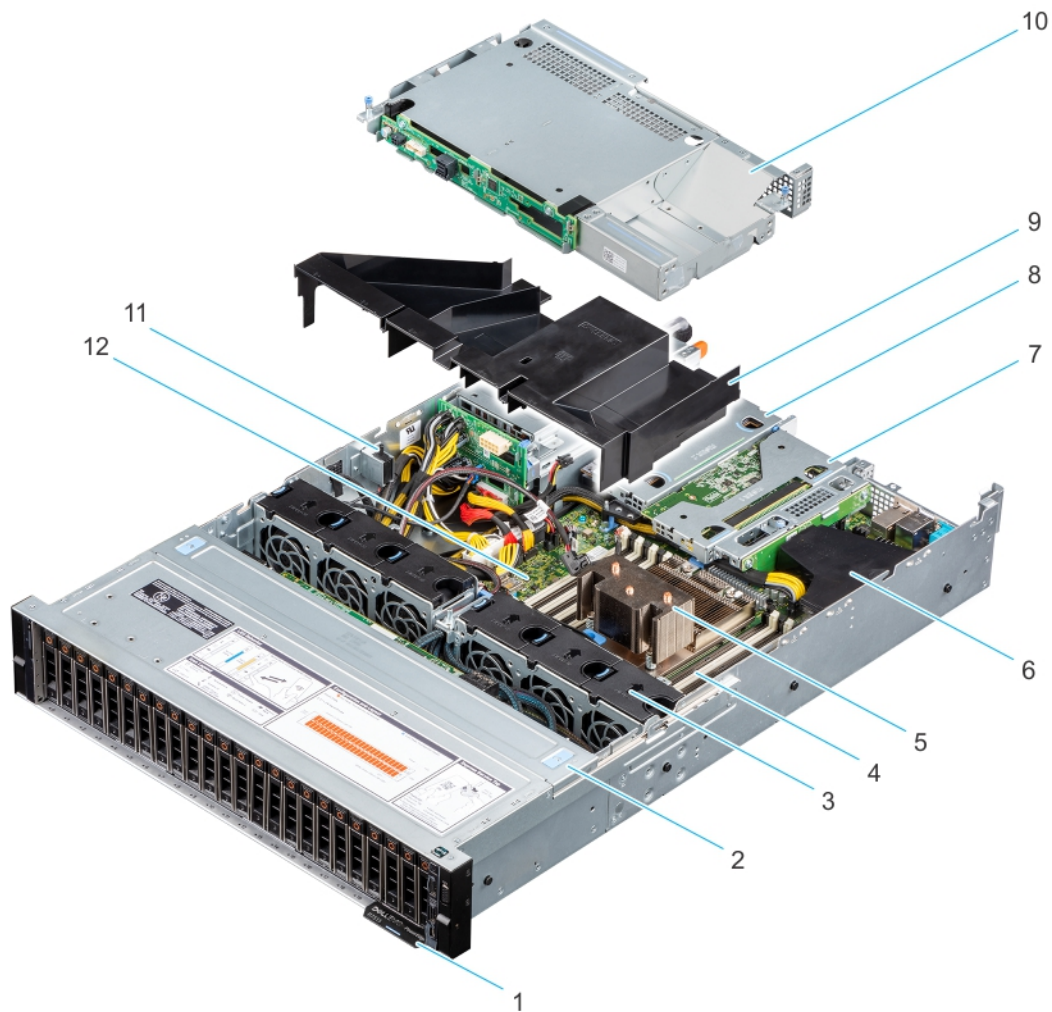

Figure 10. Inside the system with rear drive configuration

1. Information tag
2. Drive backplane cover
3. Fan (6)
4. Memory module sockets
5. Heat sink
6. Internal PERC mini card and air shroud
7. Riser 1A (Low profile right riser)
8. Riser 2 (Low profile left riser)
9. Air shroud
10. Rear drive cage
11. Intrusion switch
12. System board

Locating the Express Service Code and Service Tag

The unique Express Service Code and Service Tag are used to identify the system.

The information tag is located on the front of the system that includes system information such as Service Tag, Express Service Code, Manufacture date, NIC, MAC address, QRL label, and so on. If you have opted for the secure default access to iDRAC, the Information tag also contains the iDRAC secure default password. If you have opted for iDRAC Quick Sync 2, the Information tag also contains the OpenManage Mobile (OMM) label, where administrators can configure, monitor, and troubleshoot the PowerEdge servers.

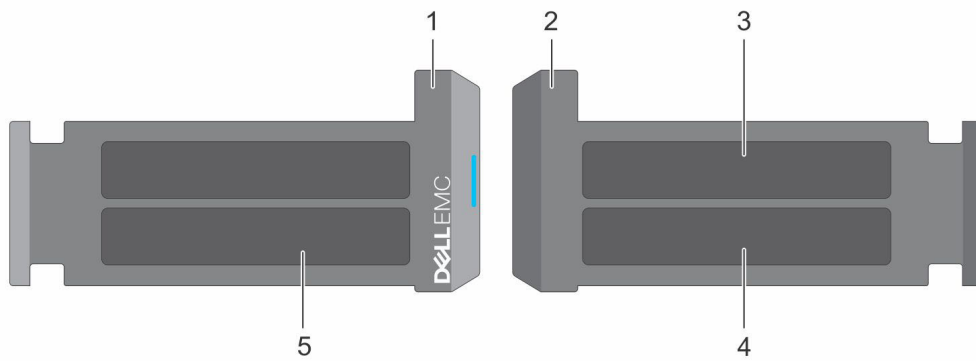

Figure 11. Locating the Express Service Code and Service tag

1. Information tag (front view)
2. Information tag (back view)
3. OpenManage Mobile (OMM) label
4. iDRAC MAC address and iDRAC secure password label
5. Service Tag, Express Service Code, QRL label

The Mini Enterprise Service Tag (MEST) label is located on the rear of the system that includes Service Tag (ST), Express Service Code (Exp Svc Code), and Manufacture Date (Mfg. Date). The Exp Svc Code is used by Dell EMC to route support calls to the appropriate personnel.

Alternatively, the Service Tag information is located on a label on left wall of the chassis.

System Information label

NOTE: The system information label is located on back side of the system cover.

Service Information

System Touchpoints

- Hot swap touchpoints: Components with terracotta touchpoints can be serviced while the system is running.
- Cold swap touchpoints: Components with blue touchpoints require a full system shutdown before servicing.

Mechanical Overview

Top View

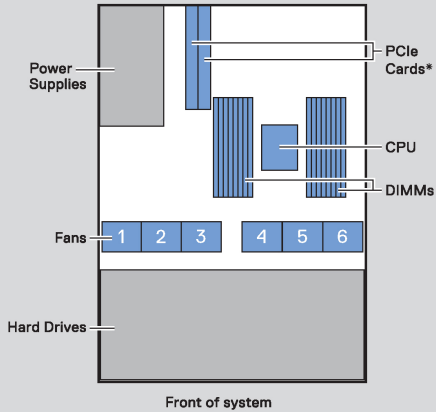

Rear View

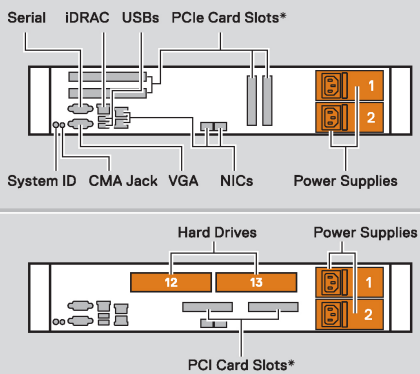

*Your system may be configured with Riser or non-Riser in PCIe Card Slots. Follow the corresponding instructions.

Electrical Overview

System Board Connections

- | | | |
|--------------------|-----------------------------|-----------------------------|
| 1 PCI Card Slot 5 | 14 Fan 4 | 23 System Power 1 |
| 2 PCI Card Slot 4 | 15 PCIE-B | 27 Internal USB 3.0 |
| 3 Jumpers | 16 SATA-B/PCIE-C | 23 System Power 2 |
| 4 LOM Riser Card | 17 PCIE-D | 23 PIB Signal 2 |
| 5 Riser Slot 1A/1B | 18 Fan 3 | 30 PIB Signal 1 |
| 6 System Power 3 | 19 PCIE-E | 31 iDSDM |
| 7 Mini PERC | 20 PCIE-F | 32 Rear Backplane/ODD Power |
| 8 DIMMs For CPU | 21 Fan 2 | 33 Front Backplane Signal 0 |
| 9 CPU | 22 Left Control Panel | 34 iDRAC |
| 10 DIMMs For CPU | 23 Front Backplane Signal 1 | 35 TPM |
| 11 Fan 6 | 24 Intrusion Switch | 36 Front Video |
| 12 Fan 5 | 25 Right Control Panel | |
| 13 SATA-A/PCIE-A | | |

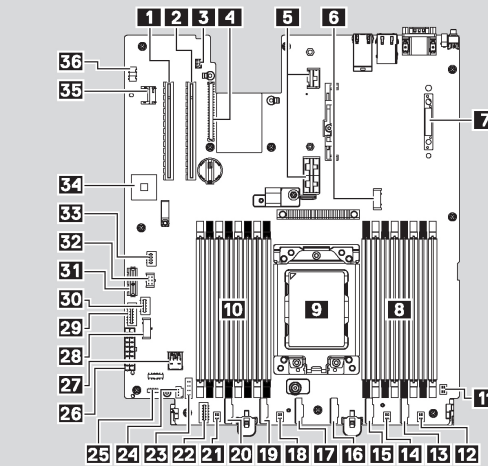

Jumper Settings

Jumper	Setting	Description
	(default)	BIOS password is enabled.
PWRD_EN		BIOS password is disabled. iDRAC local access is unlocked at next AC power cycle. iDRAC password reset is enabled in F2 iDRAC settings menu.
	(default)	BIOS configuration settings retained at system boot.
NVRAM_CLR		BIOS configuration settings cleared at system boot.

Figure 12. Service information

Memory Information

⚠ Caution: Memory (DIMMs) and CPUs may be hot during servicing

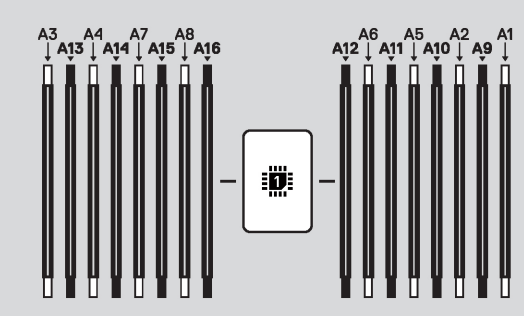

Memory Population

Configuration	Sequence
Memory-Optimized	1, 2, 3, 4, 5, 6, 7, 8, 9, 10, 11, 12, 13, 14, 15, 16

Latest population rules are documented in the *Installation and Service Manual*.

Scan to see hardware servicing and software setup videos, how-to's, and documentation.



Quick Resource Locator
www.Dell.com/QRL/Server/PER7515

Icon Legend

Express Service Tag	Hard Drive Activity
Memory Bank	Push
Power Supply	Fan
System ID	CPU
iDRAC Direct (Micro-AB USB)	

⚠ Caution: Many repairs may only be done by a certified service technician. You should only perform troubleshooting and simple repairs as authorized in your product documentation, or as directed by the online or telephone service and support team. Damage due to servicing that is not authorized by Dell is not covered by your warranty. Read and follow the safety instructions that came with the product.

To learn more about this Dell product or to order additional or replacement parts, go to Dell.com/support

Copyright © 2019 Dell Inc. or its subsidiaries. All Rights Reserved. Rev X30. Label Part No. WCD6C

Figure 13. Memory Information and icon legend

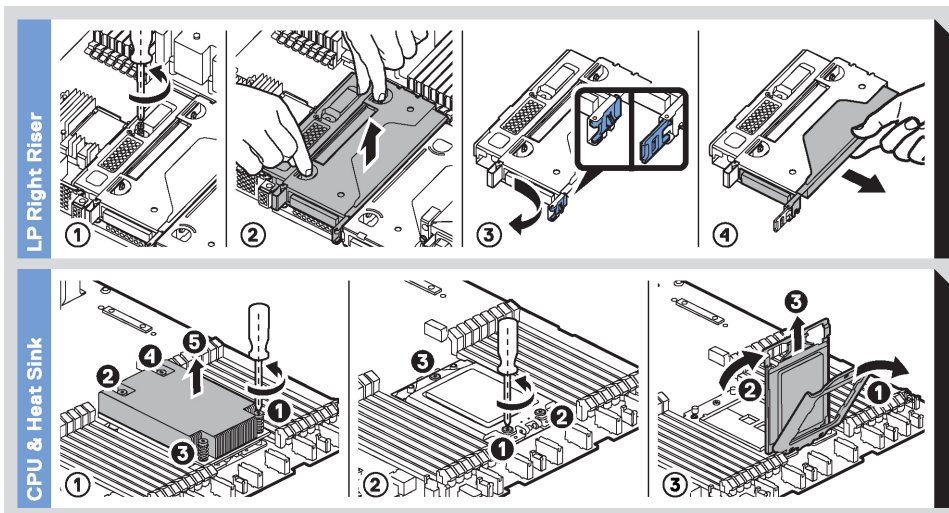

Figure 14. CPU and heat sink and LP right riser

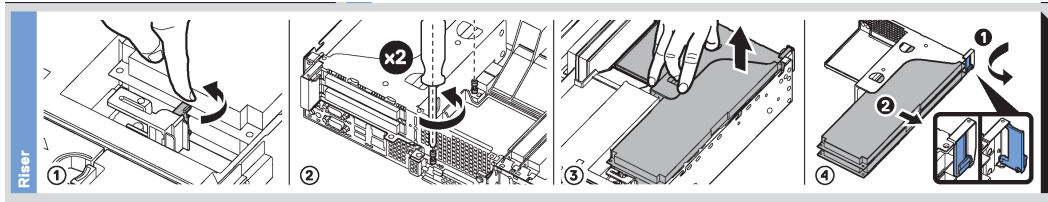

Figure 15. Riser

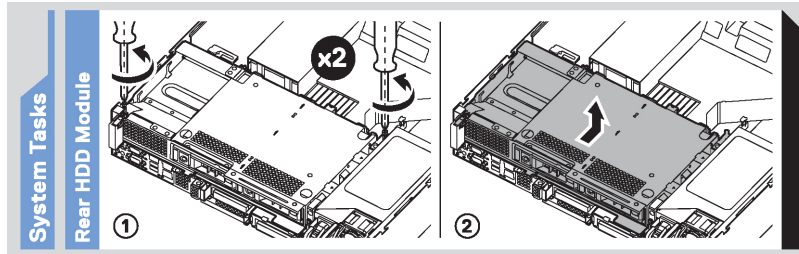

Figure 16. System tasks

Rail sizing and rack compatibility matrix

For specific information about the rail solutions compatible with your system, see the *Dell EMC Enterprise Systems Rail Sizing and Rack Compatibility Matrix* available at https://i.dell.com/sites/csdocuments/Business_solutions_engineering-Docs_Documents/en/rail-rack-matrix.pdf.

The document provides the information that is listed below:

- Specific details about rail types and their functionalities
- Rail adjustability ranges for various rack mounting flange types
- Rail depth with and without cable management accessories
- Rack types that are supported for various rack mounting flange types

Initial system setup and configuration

This section describes the tasks for initial setup and configuration of the Dell EMC system. The sections provide general steps that you must complete to set up the system and the reference guides for detailed information.

Topics:

- [Setting up the system](#)
- [iDRAC configuration](#)
- [Resources to install operating system](#)

Setting up the system

Perform the following steps to set up the system:

Steps

1. Unpack the system.
2. Install the system into the rack. For more information, see the rail installation and cable management accessory guides relevant to your rail and cable management solution at www.dell.com/poweredgemanuals.
3. Connect the peripherals to the system and the system to the electrical outlet.
4. Power on the system by pressing the power button.

For more information about setting up the system, see the *Getting Started Guide* that is shipped with your system.

For information on how to manage basic settings and features of the system, see the Dell EMC PowerEdge R7515 BIOS and UEFI Reference Guide on the product documentation page.

iDRAC configuration

The Integrated Dell Remote Access Controller (iDRAC) is designed to make you more productive as a system administrator and improve the overall availability of Dell EMC servers. iDRAC alerts you to system issues, helps you to perform remote management, and reduces the need for physical access to the system.

Options to set up iDRAC IP address

To enable communication between your system and iDRAC, you must first configure the network settings based on your network infrastructure. The network settings option is set to **DHCP**, by default.

 **NOTE:** For static IP configuration, you must request for the setting at the time of purchase.

You can set up the iDRAC IP address using one of the following interfaces. For information about how to set up iDRAC IP address, see the documentation links provided in the table.

Table 8. Interfaces to set up iDRAC IP address

Interface	Documentation links
iDRAC Settings utility	<p><i>Integrated Dell Remote Access Controller User's Guide</i> at https://www.dell.com/idracmanuals or for system specific <i>Integrated Dell Remote Access Controller User's Guide</i>, go to https://www.dell.com/poweredgemanuals > Product Support page of your system > Manuals & documents.</p> <p> NOTE: To determine the most recent iDRAC release for your platform and for latest documentation version,</p>

Table 8. Interfaces to set up iDRAC IP address (continued)

Interface	Documentation links
	see KB article https://www.dell.com/support/article/sln308699 .
OpenManage Deployment Toolkit	<i>Dell EMC OpenManage Deployment Toolkit User's Guide</i> available at https://www.dell.com/openmanagemanuals > Open Manage Deployment Toolkit.
Lifecycle Controller	<i>Lifecycle Controller User's Guide</i> at https://www.dell.com/idracmanuals or for system specific <i>Lifecycle Controller User's Guide</i> , go to https://www.dell.com/poweredgemanuals > Product Support page of your system > Manuals & documents . <i>NOTE:</i> To determine the most recent iDRAC release for your platform and for latest documentation version, see KB article https://www.dell.com/support/article/sln308699 .
Server LCD panel	LCD panel section.
iDRAC Direct and Quick Sync 2 (optional)	<i>Integrated Dell Remote Access Controller User's Guide</i> at https://www.dell.com/idracmanuals or for system specific <i>Integrated Dell Remote Access Controller User's Guide</i> , go to https://www.dell.com/poweredgemanuals > Product Support page of your system > Manuals & documents . <i>NOTE:</i> To determine the most recent iDRAC release for your platform and for latest documentation version, see KB article https://www.dell.com/support/article/sln308699 .

NOTE: To access iDRAC, ensure that you connect the ethernet cable to the iDRAC9 dedicated network port or use iDRAC Direct port by using the USB cable. You can also access iDRAC through the shared LOM mode, if you have opted for a system that has the shared LOM mode enabled.

Options to log in to iDRAC

To log in to the iDRAC Web User Interface, open a browser and enter the IP address.

You can log in to iDRAC as:

- iDRAC user
- Microsoft Active Directory user
- Lightweight Directory Access Protocol (LDAP) user

In the log in screen displayed, if you have opted for secure default access to iDRAC, enter the iDRAC secure default password available on back side of the Information Tag. If you have not opted for secure default access to iDRAC, enter the default user name and password – `root` and `calvin`. You can also log in by using your Single Sign-On or Smart Card.

NOTE: Ensure that you change the default username and password after setting up the iDRAC IP address.

For more information about logging in to the iDRAC and iDRAC licenses, see the latest *Integrated Dell Remote Access Controller User's Guide* at www.dell.com/idracmanuals.

NOTE: To determine the most recent iDRAC release for your platform and for latest documentation version, see KB article <https://www.dell.com/support/article/sln308699>.

You can also access iDRAC using command-line protocol - RACADM. For more information, see the *iDRAC with Lifecycle Controller RACADM CLI Guide* available at www.dell.com/idracmanuals.

You can also access iDRAC using automation tool - Redfish API. For more information, see the *iDRAC9 with Lifecycle Controller Redfish API Guide* available at <https://www.dell.com/idracmanuals>.

Resources to install operating system

If the system is shipped without an operating system, you can install a supported operating system by using one of the resources provided in the table. For information about how to install the operating system, see the documentation links provided in the table.

Table 9. Resources to install the operating system

Resource	Documentation links
iDRAC	<i>Integrated Dell Remote Access Controller User's Guide</i> at https://www.dell.com/idracmanuals or for system specific <i>Integrated Dell Remote Access Controller User's Guide</i> , go to https://www.dell.com/poweredgemanuals > Product Support page of your system > Manuals & documents . <i>NOTE:</i> To determine the most recent iDRAC release for your platform and for latest documentation version, see KB article at https://www.dell.com/support/article/sln308699 .
Lifecycle Controller	<i>Lifecycle Controller User's Guide</i> at https://www.dell.com/idracmanuals or for system specific <i>Lifecycle Controller User's Guide</i> , go to https://www.dell.com/poweredgemanuals > Product Support page of your system > Manuals & documents . Dell recommends using Lifecycle Controller to install the OS, since all required drivers are installed to the system. <i>NOTE:</i> To determine the most recent iDRAC release for your platform and for latest documentation version, see KB article at https://www.dell.com/support/article/sln308699 .
OpenManage Deployment Toolkit	www.dell.com/openmanagemanuals > OpenManage Deployment Toolkit
Dell certified VMware ESXi	www.dell.com/virtualizationsolutions

NOTE: For more information about Installation and How-to videos for supported operating systems on PowerEdge system see, [Supported Operating Systems for Dell EMC PowerEdge systems](#).

Options to download firmware

You can download firmware from the Dell support site. For information, see the [Downloading drivers and firmware](#) section.

You can also choose any one of the following options to download the firmware. For information about how to download the firmware, see the documentation links provided in the table.

Table 10. Options to download firmware

Option	Documentation link
Using Dell Remote Access Controller Lifecycle Controller (iDRAC with LC)	www.dell.com/idracmanuals
Using Dell Repository Manager (DRM)	www.dell.com/openmanagemanuals > Repository Manager
Using Dell Server Update Utility (SUU)	www.dell.com/openmanagemanuals > Server Update Utility
Using Dell OpenManage Deployment Toolkit (DTK)	www.dell.com/openmanagemanuals > OpenManage Deployment Toolkit
Using iDRAC virtual media	www.dell.com/idracmanuals

Options to download and install OS drivers

You can choose any one of the following options to download and install OS drivers. For information about how to download or install OS drivers, see the documentation links provided in the table.

Table 11. Options to download and install OS drivers

Option	Documentation
Dell EMC support site	Downloading drivers and firmware section.
iDRAC virtual media	<i>Integrated Dell Remote Access Controller User's Guide</i> at https://www.dell.com/idracmanuals or for system specific <i>Integrated Dell Remote Access Controller User's Guide</i> , go to https://www.dell.com/poweredgemanuals > Product Support page of your system > Manuals & documents .  NOTE: To determine the most recent iDRAC release for your platform and for latest documentation version, see https://www.dell.com/support/article/sln308699 .

Downloading drivers and firmware

It is recommended that you download and install the latest BIOS, drivers, and systems management firmware on the system.

Prerequisites

Ensure that you clear the web browser cache before downloading the drivers and firmware.

Steps

1. Go to www.dell.com/support/drivers.
2. Enter the Service Tag of the system in the **Enter a Dell Service Tag, Dell EMC Product ID or Model** field, and then press Enter.
 **NOTE:** If you do not have the Service Tag, select **Detect PC** to automatically detect the Service Tag, or click **Browse all products**, and navigate to your product.
3. On the displayed product page, click **Drivers & Downloads**.
On the **Drivers & Downloads** page, all drivers that are applicable to the system are displayed.
4. Download the drivers to a USB drive, CD, DVD or local machine.

Installing and removing system components

Topics:

- Safety instructions
- Before working inside your system
- After working inside your system
- Recommended tools
- Optional front bezel
- System cover
- Drive backplane cover
- Air shroud
- Cooling fan
- Intrusion switch module
- Drives
- Cable routing
- Drive backplane
- Rear drive cage
- System memory
- Processor and heat sink
- Expansion cards and expansion card risers
- M.2 SSD module on BOSS-S1 adapter card
- Optional IDSDM module
- Micro SD card
- LOM riser card
- Storage controller card
- System battery
- Optional internal USB memory key
- Optional optical drive
- Power supply unit
- Power interposer board
- System board
- Trusted Platform Module
- Control panel

Safety instructions

 **NOTE:** To avoid injury, do not lift the system on your own. Get others to assist you.

 **WARNING:** Opening or removing the system cover while the system is turned on may expose you to a risk of electric shock..

 **CAUTION:** Many repairs may only be done by a certified service technician. You should only perform troubleshooting and simple repairs as authorized in your product documentation, or as directed by the online or telephone service and support team. Damage due to servicing that is not authorized by Dell is not covered by your warranty. Read and follow the safety instructions that are shipped with your product.

 **CAUTION:** To ensure proper operation and cooling, all system bays and fans must be always populated with a component or a blank.

- NOTE:** It is recommended that you always use an antistatic mat and antistatic strap while working on components inside the system.
- NOTE:** While replacing the hot swappable PSU, after next server boot; the new PSU automatically updates to the same firmware and configuration of the replaced one. For more information about the Part replacement configuration, see the *Lifecycle Controller User's Guide* at <https://www.dell.com/idracmanuals>
- NOTE:** While replacing faulty storage controller/FC/NIC card with the same type of card, after you power on the system; the new card automatically updates to the same firmware and configuration of the faulty one. For more information about the Part replacement configuration, see the *Lifecycle Controller User's Guide* at <https://www.dell.com/idracmanuals>
- NOTE:** For detailed information on cabling the PERC 11 cards, see the system-specific owner's manual at Installation and Service Manual available at <https://www.dell.com/poweredgemanuals>

Before working inside your system

Prerequisites

Follow the safety guidelines listed in [Safety instructions](#).

Steps

1. Power off the system and all attached peripherals.
2. Disconnect the system from the electrical outlet, and disconnect the peripherals.
3. If applicable, remove the system from the rack.
For more information, see the *Rail Installation Guide* relevant to your rail solutions at www.dell.com/poweredgemanuals.
4. Remove the system cover.

After working inside your system

Prerequisites

Follow the safety guidelines listed in [Safety instructions](#).

Steps

1. Replace the system cover.
2. If applicable, install the system into the rack.
For more information, see the *Rail Installation Guide* relevant to your rail solutions at www.dell.com/poweredgemanuals.
3. Reconnect the peripherals and connect the system to the electrical outlet, and then power on the system.

Recommended tools

You need the following tools to perform the removal and installation procedures:

- Key to the bezel lock. The key is required only if your system includes a bezel.
- Phillips #1 screwdriver
- Phillips #2 screwdriver
- Torx #T20 screwdriver
- 5mm hex nut screwdriver
- Plastic scribe
- 1/4 inch flat blade screwdriver
- Wrist grounding strap connected to the ground
- ESD mat

You need the following tools to assemble the cables for a DC power supply unit:

- AMP 90871-1 hand-crimping tool or equivalent

- Tyco Electronics 58433-3 or equivalent
 - Wire-stripper pliers to remove insulation from size 10 AWG solid or stranded, insulated copper wire
- NOTE:** Use alpha wire part number 3080 or equivalent (65/30 stranding).

Optional front bezel

NOTE: LCD panel is optional on the front bezel. If the front bezel has an LCD panel, see [LCD panel](#) section.

Removing the front bezel

Prerequisites

1. Follow the safety guidelines listed in the [Safety instructions](#).

NOTE: The bezel key is part of the bezel package.

Steps

1. Unlock the bezel .
2. Press the release button, and remove the left end of the bezel.
3. Slide the tabs on the right end of the bezel out of the slots on the chassis and remove the bezel.

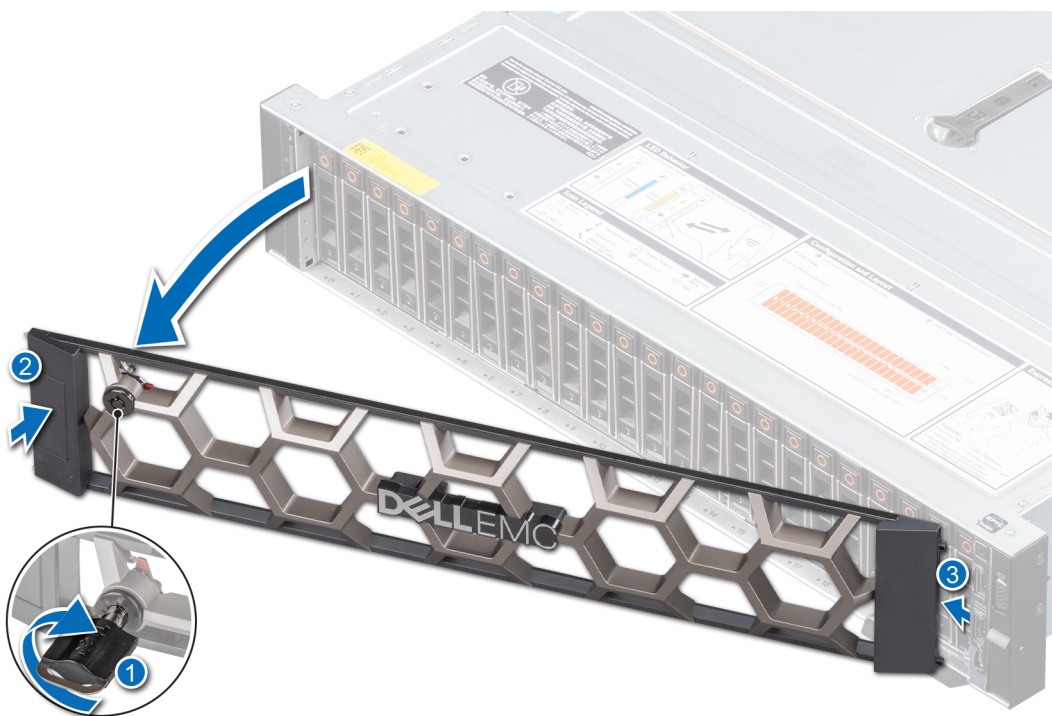

Figure 17. Removing the front bezel

Installing the front bezel

Prerequisites

1. Follow the safety guidelines listed in the [Safety instructions](#).

NOTE: The bezel key is part of the bezel package.

Steps

1. Align and insert the tabs on the bezel into the slots on the chassis.
2. Press the bezel until the release button clicks in place.
3. Lock the bezel.

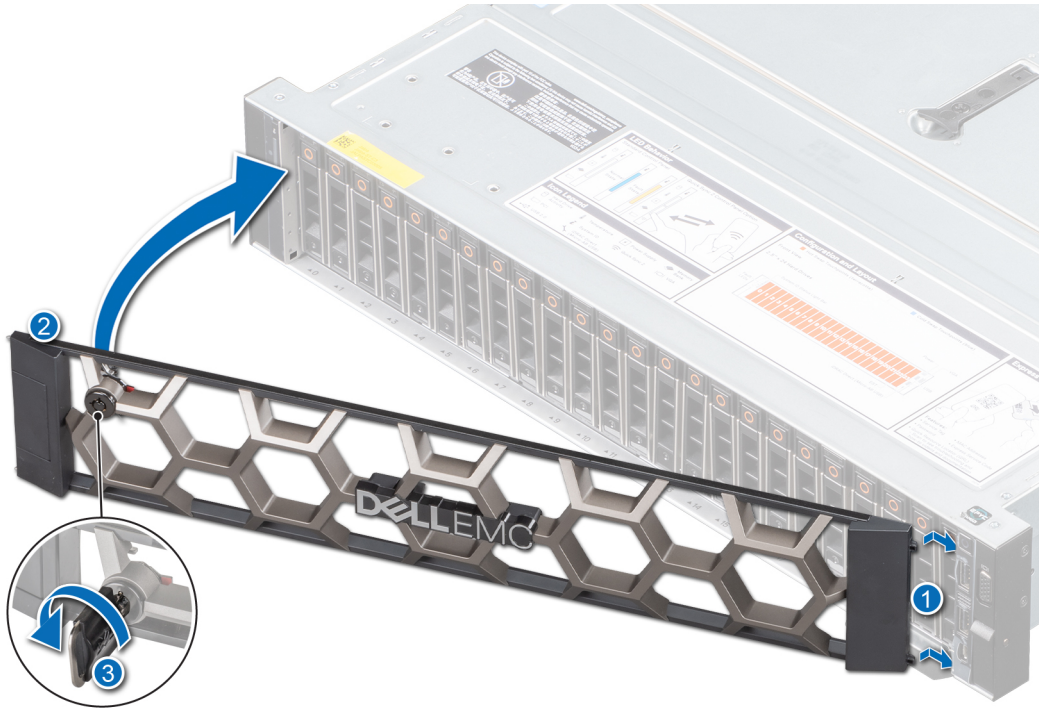

Figure 18. Installing the front bezel

System cover

Removing the system cover

Prerequisites

1. Follow the safety guidelines listed in the [Safety instructions](#).
2. Follow the procedure listed in the [Before working inside your system](#).
3. Power off the system, including any attached peripherals.
4. Disconnect the system from the electrical outlet and peripherals.

Steps

1. Use a 1/4 inch flat head or a Phillips #2 screwdriver to turn the lock counterclockwise to the unlock position.
2. Open the release latch until the system cover slides back.
3. Lift the cover from the system.



Figure 19. Removing the system cover

Next steps

1. [Replace the system cover.](#)

Installing the system cover

Prerequisites

1. Follow the safety guidelines listed in the [Safety instructions](#).
2. Follow the procedure listed in the [Before working inside your system](#).
3. Ensure that all internal cables are connected and placed out of the way, and no tools or extra parts are left inside the system.

Steps

1. Align the tabs on the system cover with the guide slots on the chassis.
2. Close the system cover release latch.
3. Using a 1/4 inch flat head or Phillips #2 screwdriver, turn the lock clockwise to the lock position.



Figure 20. Installing the system cover

Next steps

Follow the procedure listed in [After working inside your system](#).

Drive backplane cover

Removing the drive backplane cover

Prerequisites

1. Follow the safety guidelines listed in the [Safety instructions](#).
2. Follow the procedure listed in the [Before working inside your system](#).

i **NOTE:** Route the cables properly to prevent the cables from being pinched or crimped.

Steps

1. Press and push the blue touch points to disengage the drive backplane cover.
2. Remove the cover from the chassis.

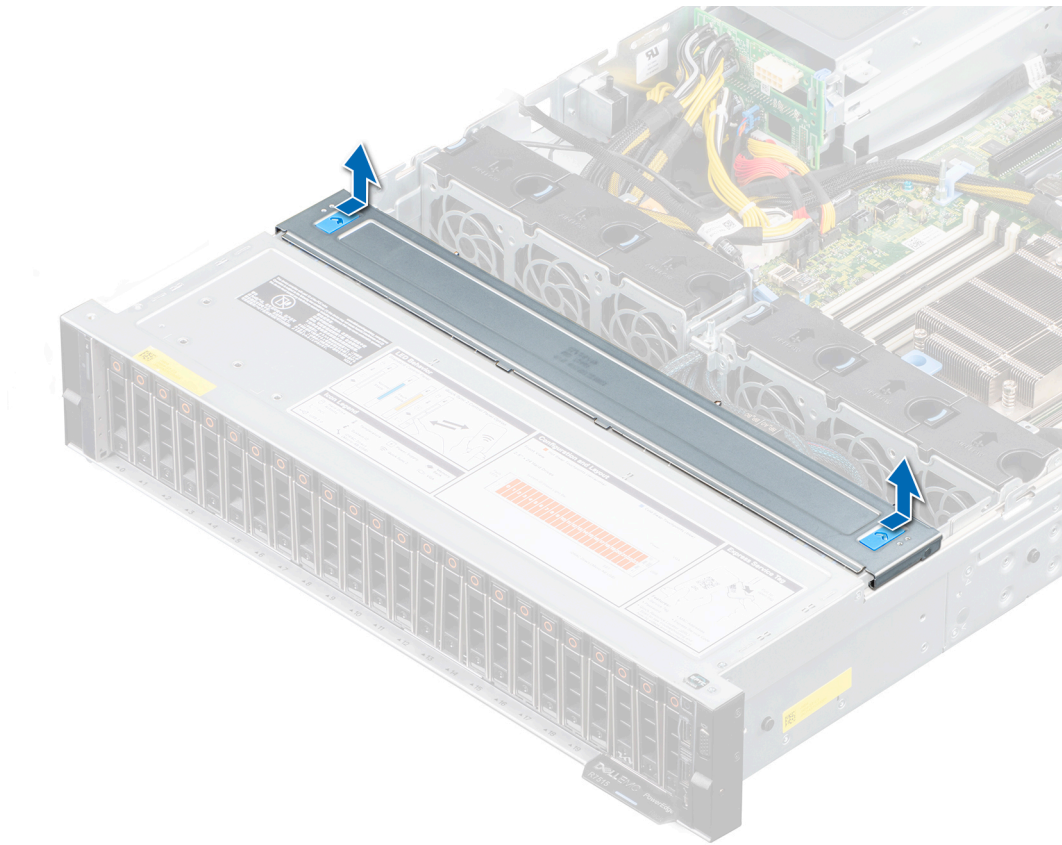

Figure 21. Removing the drive backplane cover

Next steps

1. [Install the drive backplane.](#)

Installing the drive backplane cover

Prerequisites

1. Follow the safety guidelines listed in the [Safety instructions](#).
2. Follow the procedure listed in the [Before working inside your system](#).

Steps

1. Align the tabs on the drive backplane cover with the guide slots on the system.
2. Slide the cover until it is securely seated.

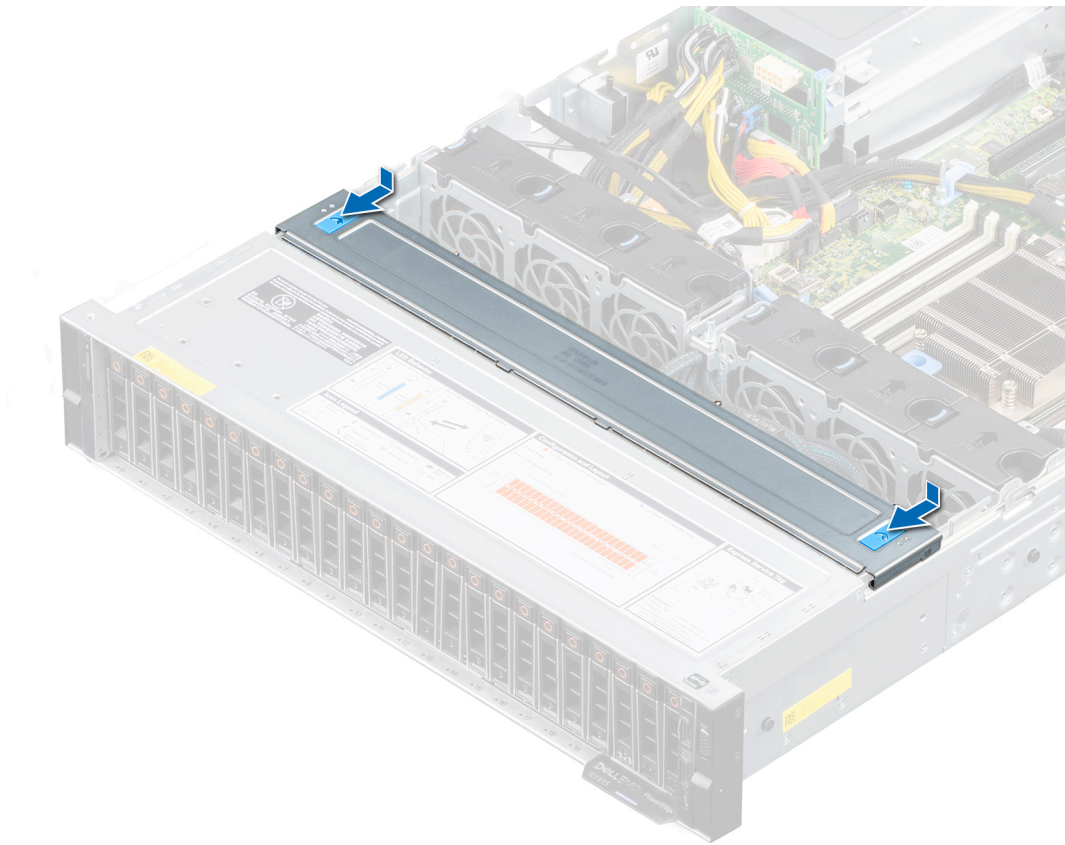

Figure 22. Installing the drive backplane cover

Next steps

1. Follow the procedure listed in [After working inside your system.](#)

Air shroud

Removing the air shroud

Prerequisites

1. Follow the safety guidelines listed in the [Safety instructions](#).
2. Follow the procedure listed in the [Before working inside your system](#).

 **CAUTION:** Never operate your system with the air shroud removed. The system may get overheated quickly, resulting in shutdown of the system and loss of data.

Steps

Hold the air shroud at both the ends, and lift it from the system.

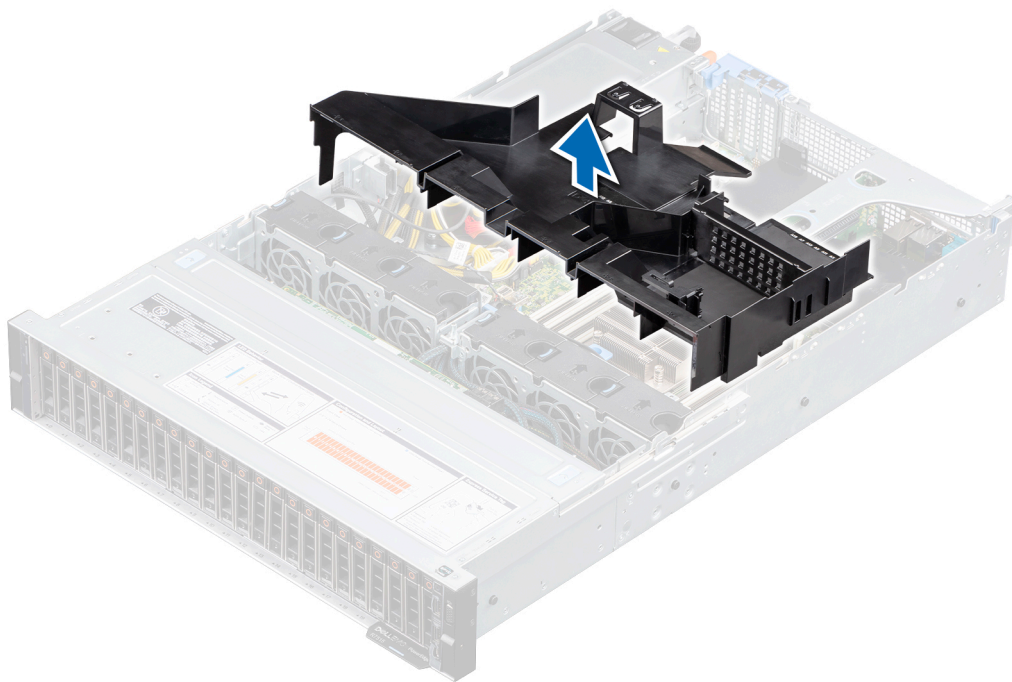

Figure 23. Removing the air shroud

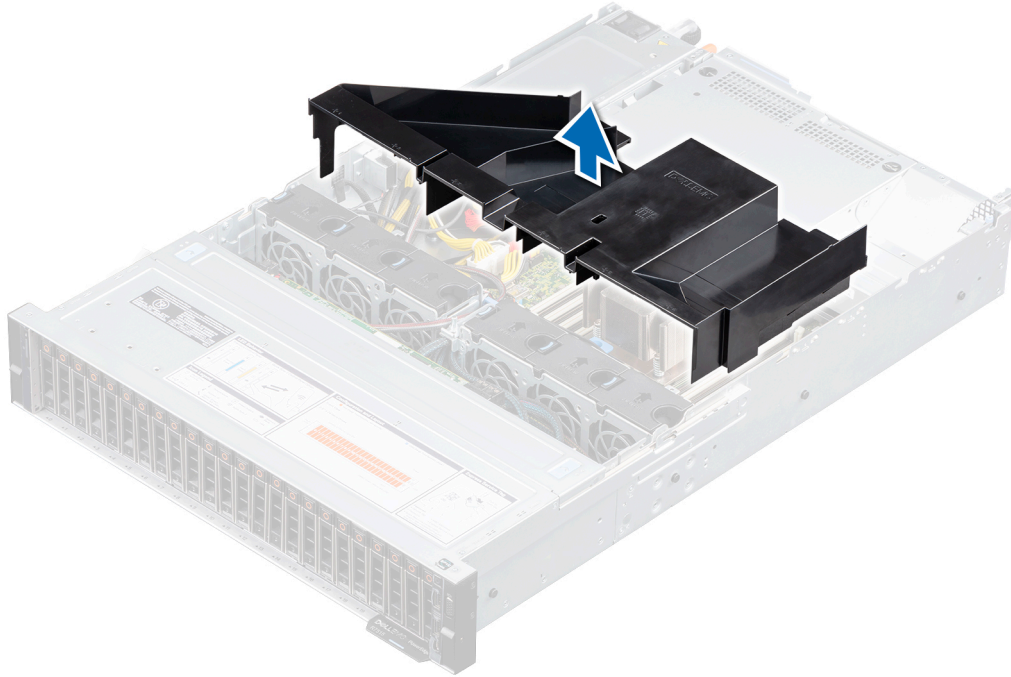

Figure 24. Removing the air shroud for system with rear drives

Next steps

1. [Replace the air shroud.](#)

Installing the air shroud

Prerequisites

1. Follow the safety guidelines listed in the [Safety instructions](#).
2. Follow the procedure listed in the [Before working inside your system](#).

Steps

1. Align the tabs on the air shroud with the slots on the chassis.
i **NOTE:** Route the cables properly to prevent the cables from being pinched or crimped.
2. Lower the air shroud into the system until it is firmly seated.

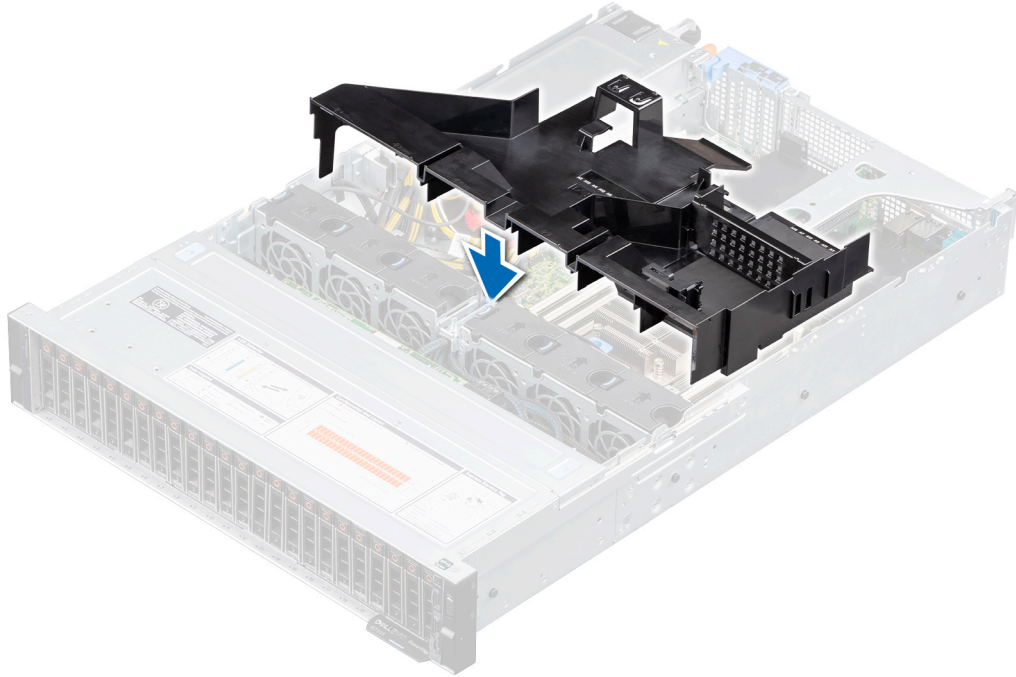

Figure 25. Installing the air shroud

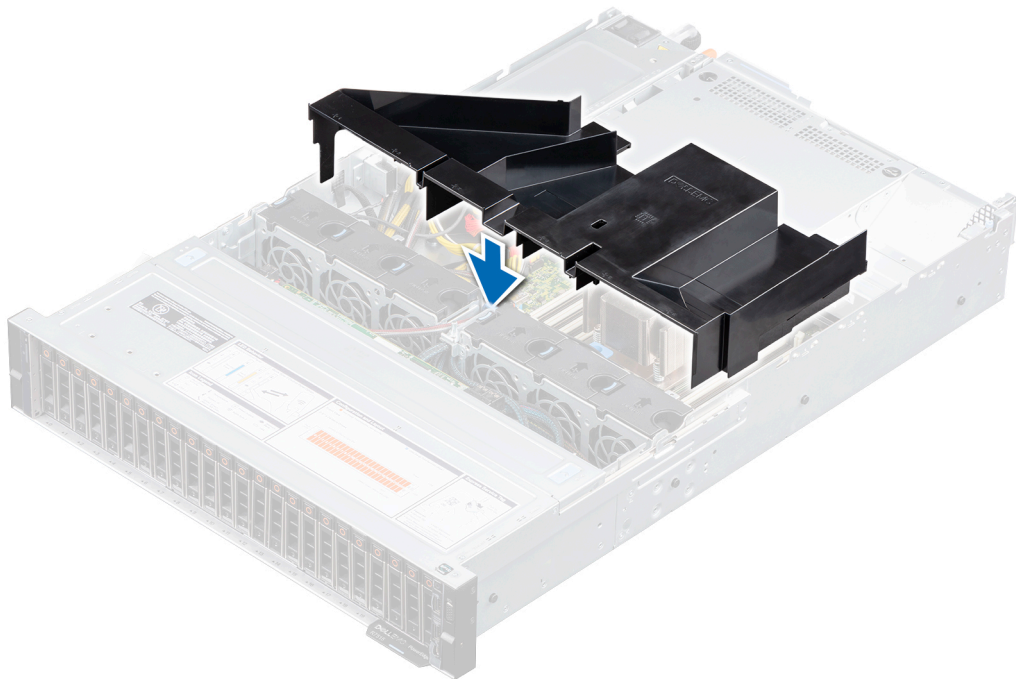

Figure 26. Installing the air shroud for system with rear drives

Next steps

1. Follow the procedure listed in [After working inside your system.](#)

Cooling fan

Removing a cooling fan

Prerequisites

1. Follow the safety guidelines listed in the [Safety instructions](#).
2. Follow the procedure listed in the [Before working inside your system](#).
3. [Remove the air shroud](#).

Steps

1. Disconnect the cooling fan cable from the system board connector.
2. Remove the cable from the cable retention tabs.

i **NOTE:** Observe the routing of the cable as you remove it from the system.

3. Press the release tab, and lift the cooling fan from the cooling fan cage.

i **NOTE:** The numbers on the image does not depict the exact steps. The numbers are just for representation of sequence.

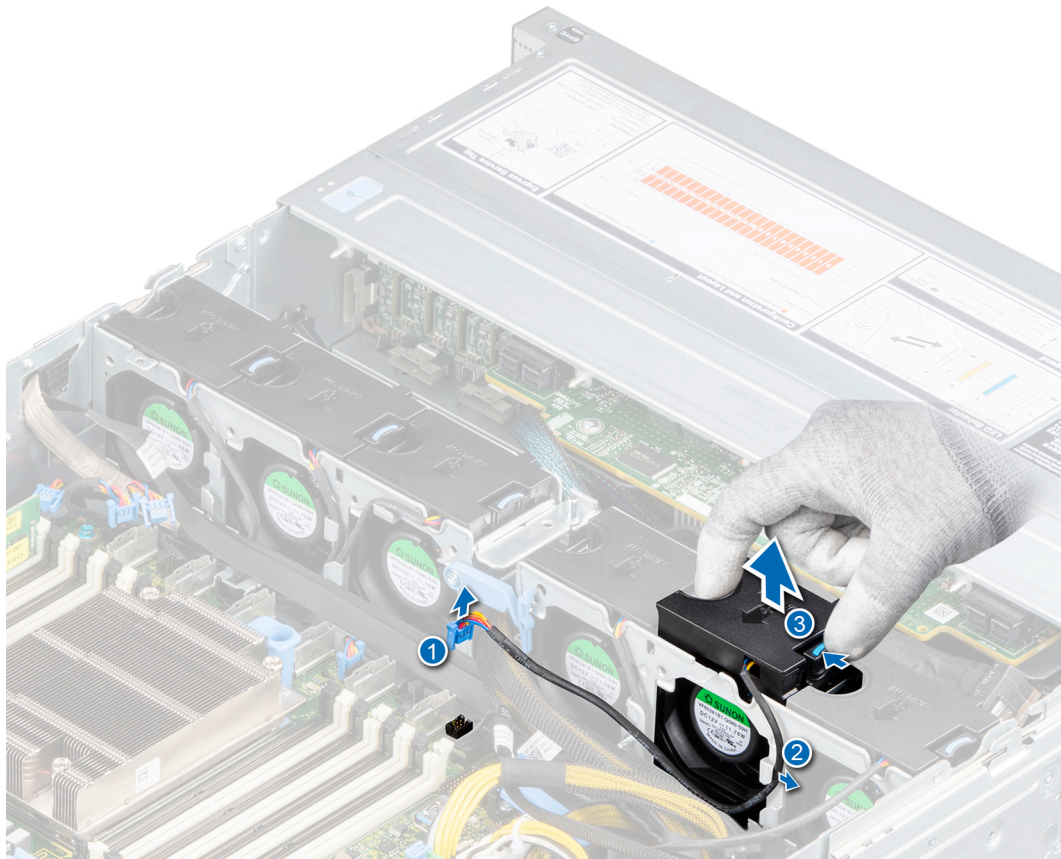

Figure 27. Removing a fan

i **NOTE:** Ensure to disconnect the cooling fan 1 cable from the connector on the power interposer board.

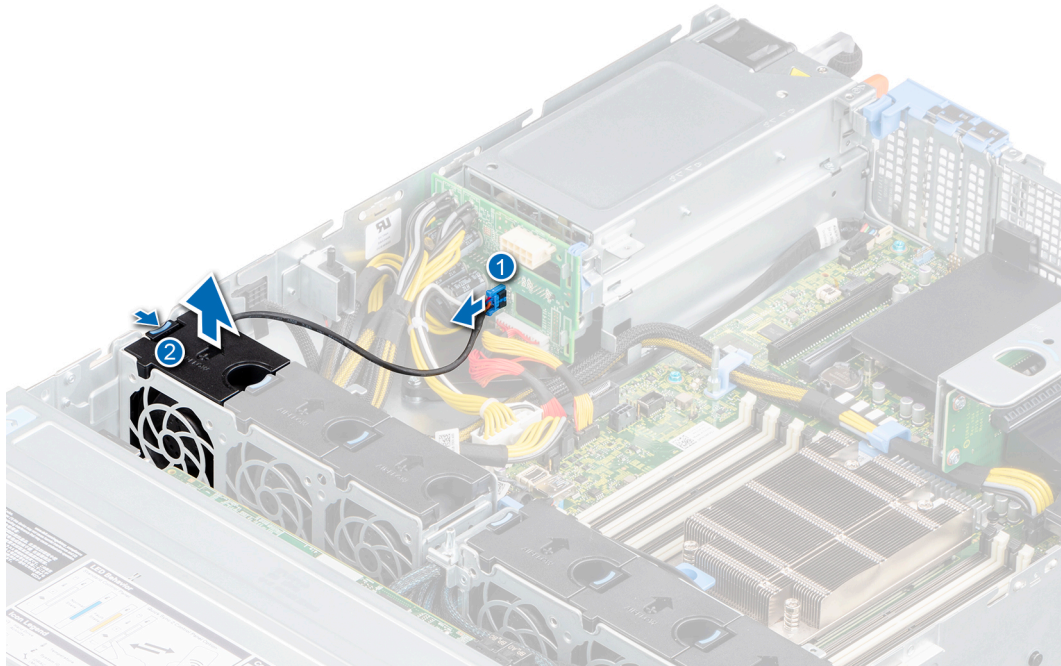

Figure 28. Disconnecting fan 1 cable from PIB

Next steps

1. [Replace the cooling fan.](#)

Installing a cooling fan

Prerequisites

1. Follow the safety guidelines listed in the [Safety instructions](#).
2. Follow the procedure listed in the [Before working inside your system](#).
3. [Remove the air shroud.](#)

Steps

1. Lower the cooling fan into the cooling fan cage, until the blue release tab clicks into place.
2. Route the cable through the cable retention tabs.

NOTE: The numbers on the image does not depict the exact steps. The numbers are just for representation of sequence.

NOTE: Route the cable properly to prevent the cable from being pinched or crimped.

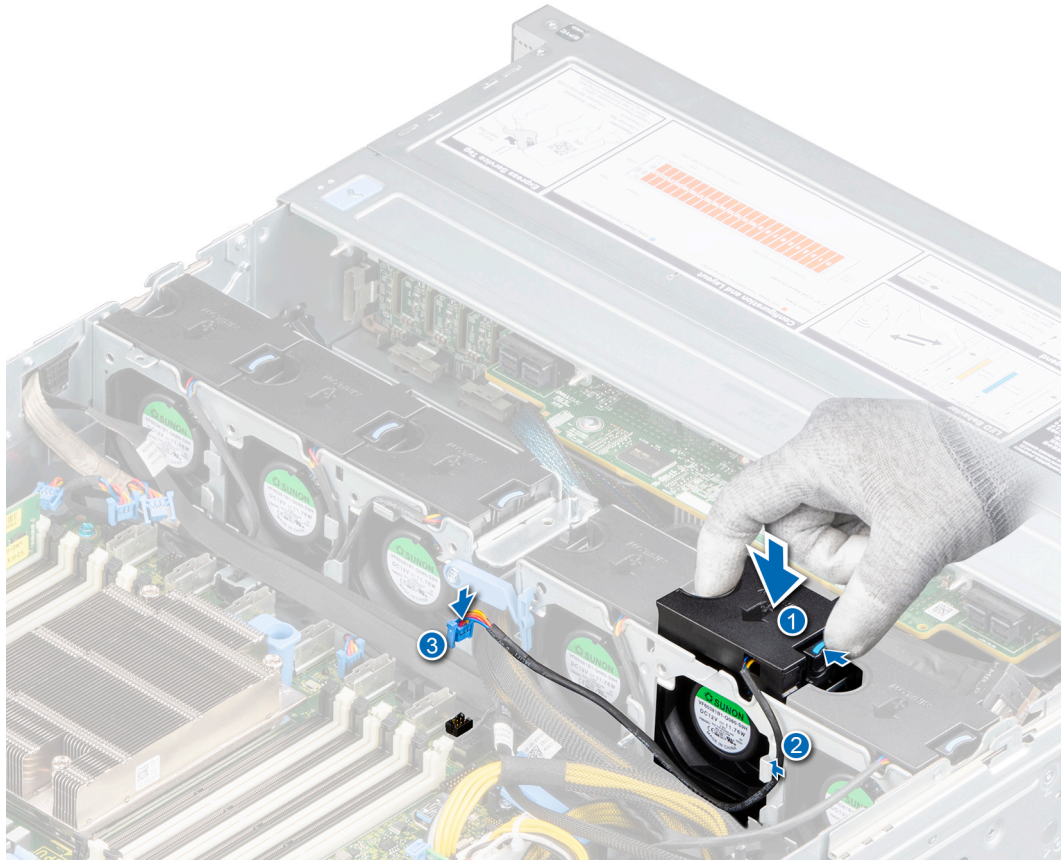

Figure 29. Installing a fan

3. Connect the cooling fan cable (2, 3, 4, 5, and 6) to the connector on system board.

NOTE: Ensure to connect the cooling fan 1 cable from the connector on the power interposer board.

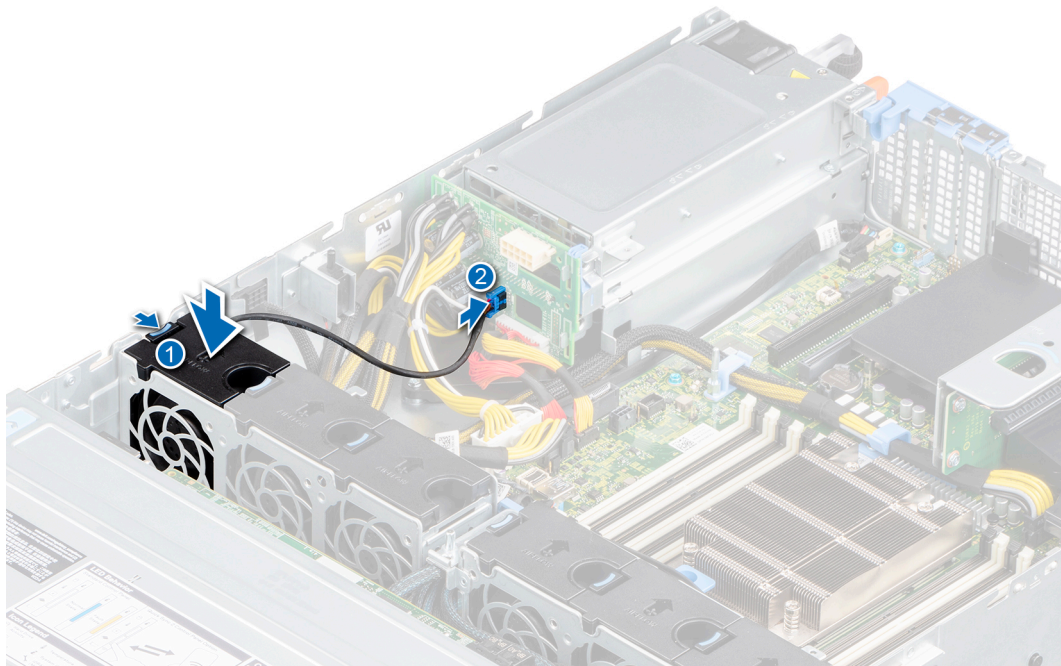

Figure 30. Connecting fan 1 cable to PIB

Next steps

1. [Install the air shroud.](#)
2. Follow the procedure listed in [After working inside your system.](#)

Intrusion switch module

Removing the intrusion switch

Prerequisites

1. Follow the safety guidelines listed in the [Safety instructions.](#)
2. Follow the procedure listed in the [Before working inside your system.](#)
3. [Remove the air shroud.](#)
4. Keep the plastic scribe ready.

Steps

1. Disconnect and remove the intrusion switch cable connector from connector on the system board.

NOTE: Observe the routing of the cable as you remove it from the system.

2. Using a plastic scribe, slide the intrusion switch out of the intrusion switch slot.

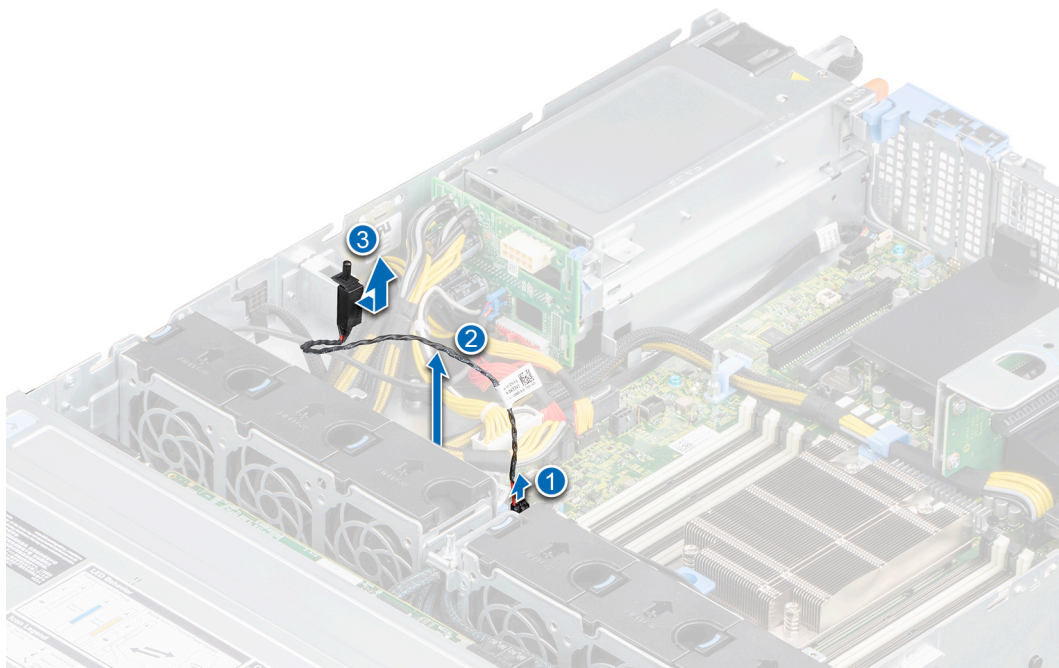

Figure 31. Removing the intrusion switch

Next steps

1. [Replace the intrusion switch.](#)

Installing the intrusion switch

Prerequisites

1. Follow the safety guidelines listed in the [Safety instructions.](#)
2. Follow the procedure listed in the [Before working inside your system.](#)

3. [Remove the air shroud.](#)

Steps

1. Align and insert the intrusion switch in the slot until it is firmly seated in the slot on the chassis.
i **NOTE:** Route the cable properly when you replace it to prevent the cable from being pinched or crimped.
2. Connect the intrusion switch cable to the connector on the system board.

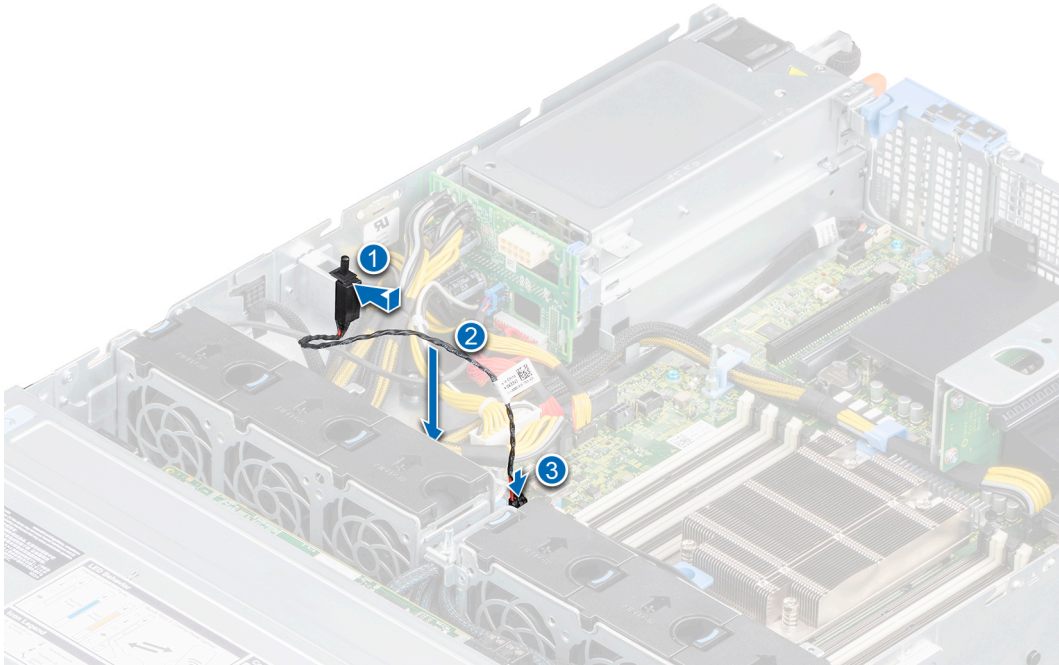

Figure 32. Installing the intrusion switch

Next steps

1. [Install the air shroud.](#)
2. Follow the procedure listed in [After working inside your system.](#)

Drives

Removing a drive blank

Prerequisites

1. Follow the safety guidelines listed in the [Safety instructions.](#)
2. If installed, [remove the front bezel.](#)

⚠ CAUTION: To maintain proper system cooling, drive blanks must be installed in all empty drive slots.

⚠ CAUTION: Mixing drive blanks from previous generations of PowerEdge servers is not supported.

Steps

Press the release button, and slide the drive blank out of the drive slot.

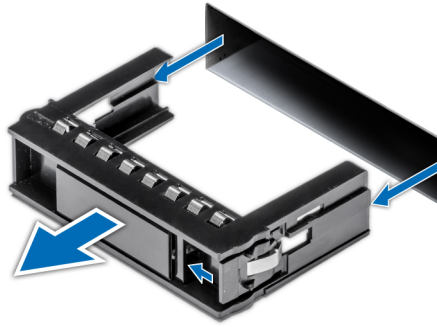

Figure 33. Removing a drive blank

Next steps

1. Install a drive or replace the drive blank.

Installing the drive blank

Prerequisites

1. Follow the safety guidelines listed in the [Safety instructions](#).
2. If installed, [remove the front bezel](#).

Steps

Insert the drive blank into the drive slot, and push the blank until the release button clicks into place.

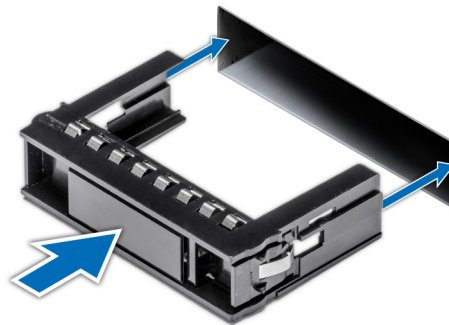

Figure 34. Installing the drive blank

Next steps

1. [Install the front bezel](#).

Removing the drive carrier

Prerequisites

1. Follow the safety guidelines listed in the [Safety instructions](#).
2. Using the management software, prepare the drive for removal.

If the drive is online, the green activity or fault indicator flashes while the drive is turning off. When the drive indicators are off, the drive is ready for removal. For more information, see the documentation for the storage controller.

CAUTION: Before attempting to remove or install a drive while the system is running, see the documentation for the storage controller card to ensure that the host adapter is configured correctly to support drive removal and insertion.

CAUTION: To prevent data loss, ensure that your operating system supports drive installation. See the documentation supplied with your operating system.

3. If installed, [remove the front bezel](#).

Steps

1. Press the release button to open the drive carrier release handle.
2. Holding the drive carrier release handle, slide the drive carrier out of the drive slot.



Figure 35. Removing the drive carrier

Next steps

1. [Install a drive carrier or a drive blank](#).

Installing the drive carrier

Prerequisites

CAUTION: Before removing or installing a drive while the system is running, see the documentation for the storage controller card to ensure that the host adapter is configured correctly to support drive removal and insertion.

CAUTION: Combining SAS and SATA drives in the same RAID volume is not supported.

CAUTION: When installing a drive, ensure that the adjacent drives are fully installed. Inserting a drive carrier and attempting to lock its handle next to a partially installed carrier can damage the partially installed carrier's shield spring and make it unusable.

CAUTION: To prevent data loss, ensure that your operating system supports hot-swap drive installation. See the documentation supplied with your operating system.

CAUTION: When a replacement hot swappable drive is installed and the system is powered on, the drive automatically begins to rebuild. Ensure that the replacement drive is blank or contains data that you wish to overwrite. Any data on the replacement drive is immediately lost after the drive is installed.

NOTE: Ensure that the drive carrier's release handle is in the open position before inserting the carrier into the slot.

1. Follow the safety guidelines listed in the [Safety instructions](#).
2. If installed, [remove the front bezel](#).
3. [Remove the drive carrier or drive blank](#) when you want to assemble the drives in to the system.

Steps

1. Slide the drive carrier into the drive slot.
2. Close the drive carrier release handle to lock the drive in place.



Figure 36. Installing the drive carrier

Next steps

1. If removed, [install the front bezel](#).

Removing the drive from the drive carrier

Prerequisites

1. Follow the safety guidelines listed in the [Safety instructions](#).
2. If installed, [remove the front bezel](#).
3. [Remove the drive](#).

Steps

1. Using a Phillips #1 screwdriver, remove the screws from the slide rails on the drive carrier.

NOTE: If the hard drive or SSD carrier has Torx screw, use Torx 6 (for 2.5-inch drive) or Torx 8 (for 3.5-inch drive) screwdriver to remove the drive. 

2. Lift the drive out of the drive carrier.



Figure 37. Removing the drive from the drive carrier

Next steps

1. [Install the drive into the drive carrier.](#)

Installing the drive into the drive carrier

Prerequisites

1. Follow the safety guidelines listed in the [Safety instructions](#).
2. If installed, [remove the front bezel](#).
3. [Remove the drive blank](#).

Steps

1. Insert the drive into the drive carrier with the drive connector facing towards the rear of the carrier.
2. Align the screw holes on the drive with the screws holes on the drive carrier.
3. Using a Phillips #1 screwdriver, replace the screws to secure the drive to the drive carrier.

i **NOTE:** If the hard drive or SSD carrier has Torx screw, use Torx 6 (for 2.5-inch drive) or Torx 8 (for 3.5-inch drive) screwdriver to install the drive. 

i **NOTE:** When installing a drive into the drive carrier, ensure that the screws are torqued to 4 in-pounds.

i **NOTE:** Use the screws shipped with the drive carrier to secure the drive to the drive carrier.



Figure 38. Installing a drive into the drive carrier

Next steps

1. Install the drive carrier.
2. If removed, install the front bezel.

Cable routing

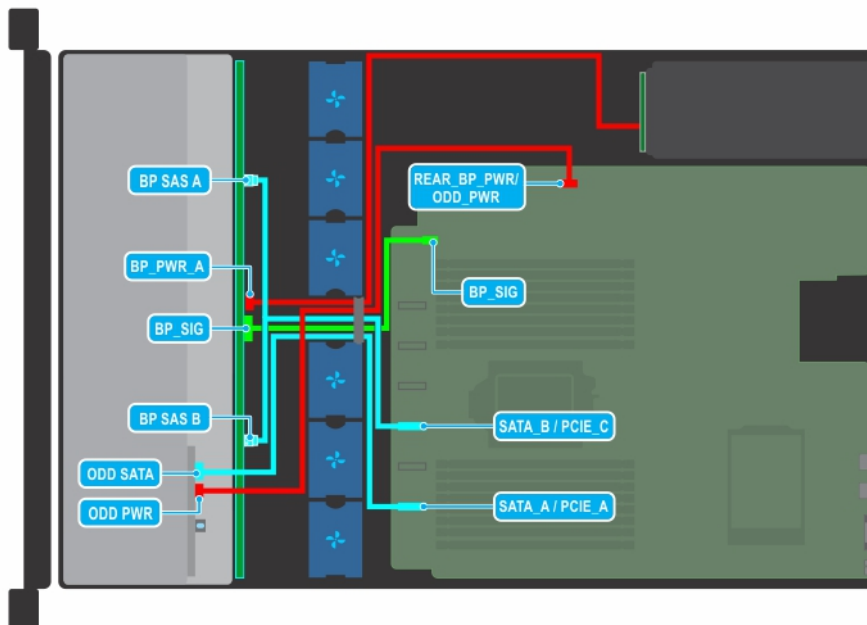

Figure 39. Cable routing - 8 x 3.5 inch drive backplane with ODD

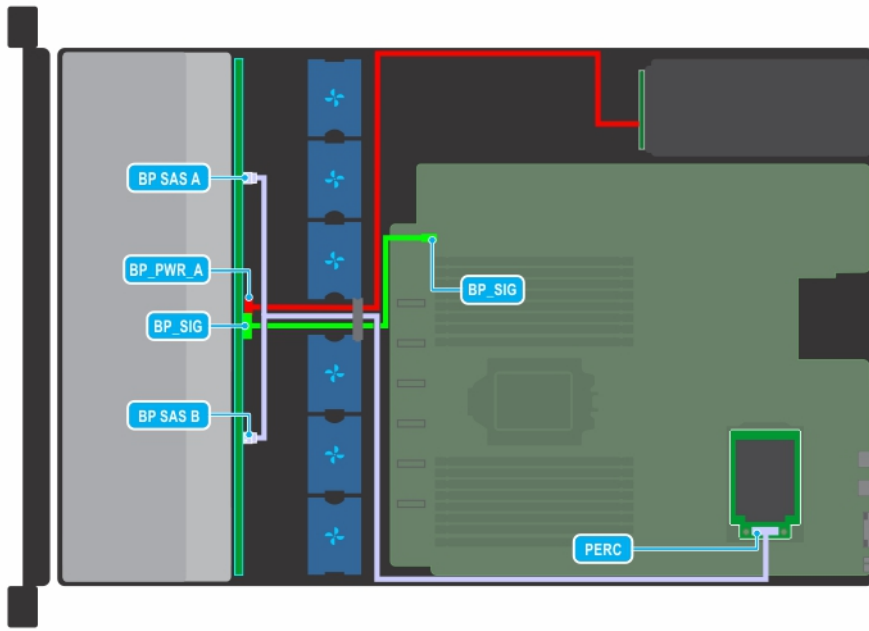

Figure 40. Cable routing - 8 x 3.5 inch drive backplane with mini PERC card

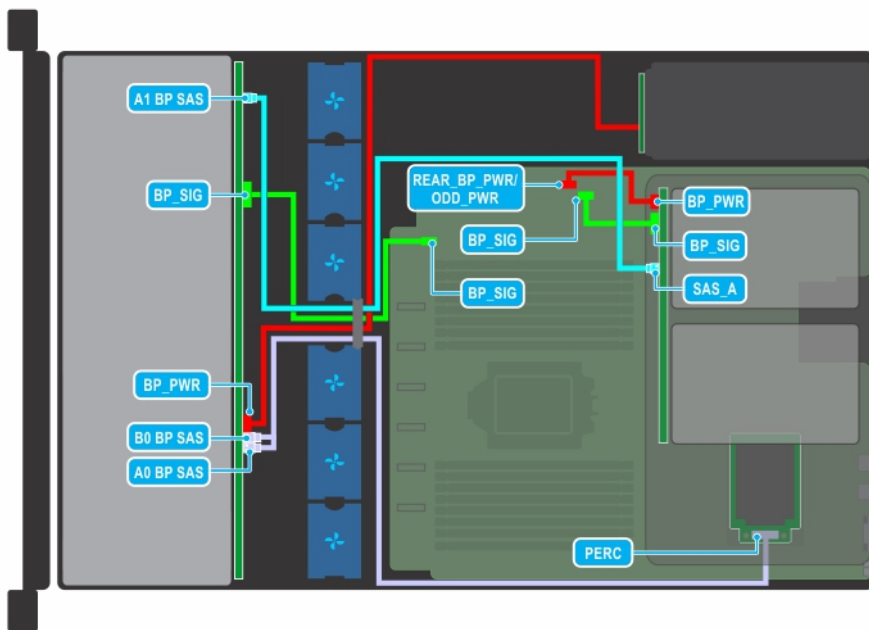

Figure 41. Cable routing - 12 x 3.5 inch drive backplane with 2 x 3.5 inch rear drive backplane

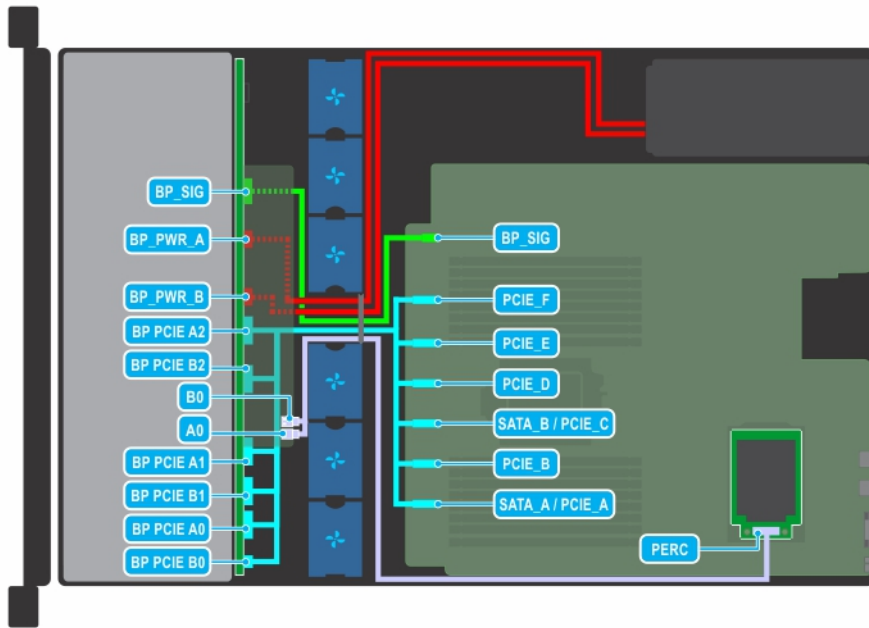

Figure 42. Cable routing - 12 x 2.5 inch SAS drive + 12 x 2.5 inch NVMe drive backplane

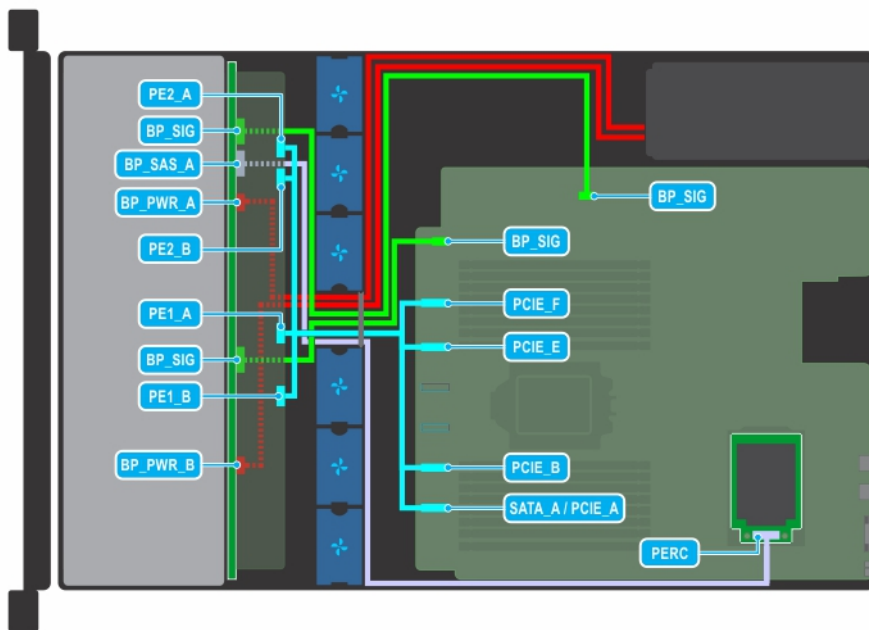

Figure 43. Cable routing - 24 x 2.5 inch NVMe drive backplane

Drive backplane

Drive backplane

Depending on your system configuration, the drive backplanes supported in PowerEdge R7515 are listed here:

- 3.5 inch (x8) SAS, SATA backplane
- 3.5 inch (x12) SAS or SATA backplane and 3.5 inch (x2) SAS or SATA backplane (rear)
- 2.5 inch (x12) SAS or SATA + 2.5 inch (x12) NVMe backplane
- 2.5 inch (x24) SAS or SATA backplane
- 2.5 inch (x24) NVMe backplane
- 2.5 inch (x8) SAS or SATA + 2.5 inch (x16) NVMe backplane

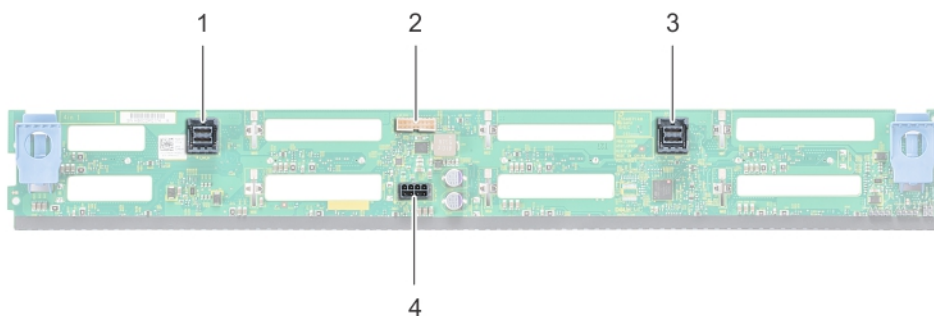

Figure 44. 8 X 3.5 inch drive backplane

- | | |
|-------------------------------|---------------------|
| 1. SAS/SATA B cable connector | 2. Signal connector |
| 3. SAS/SATA A cable connector | 4. Power connector |

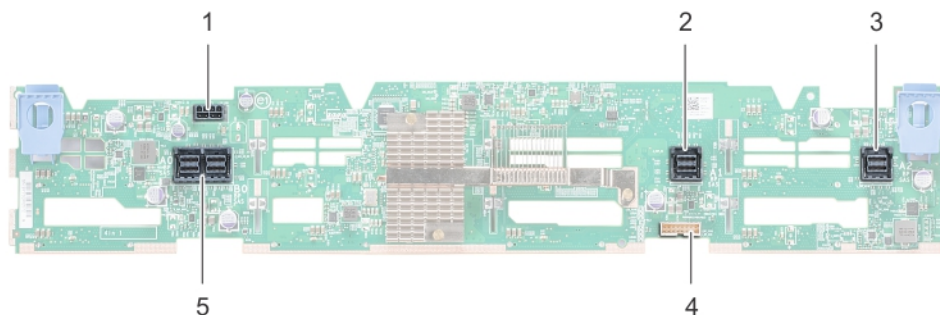

Figure 45. 12 X 3.5 inch drive backplane

- | | |
|-----------------------------|-------------------------------|
| 1. Power cable connector | 2. SAS/SATA cable connector |
| 3. SAS/SATA cable connector | 4. Backplane signal connector |
| 5. SAS cable connector | |

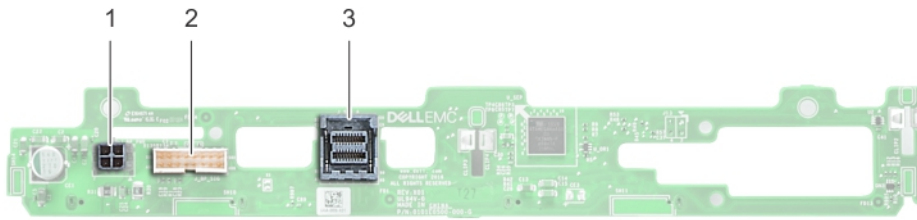

Figure 46. 2 x 3.5 inch drive backplane (rear)

1. Power connector
2. Signal connector
3. SAS cable connector

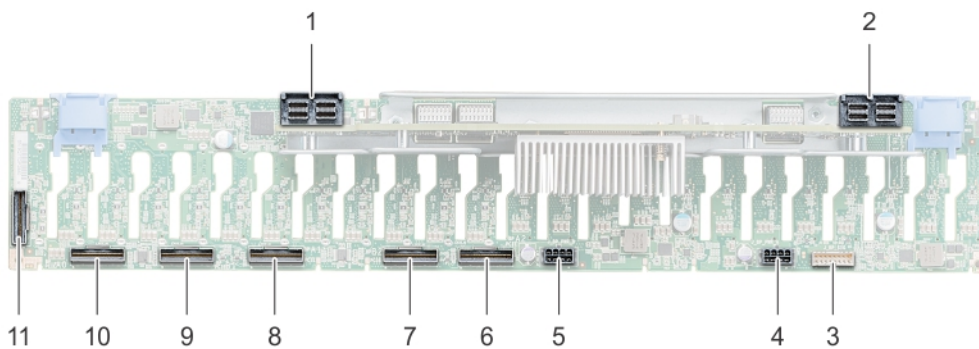

Figure 47. 24 X 2.5 inch drive backplane

- | | |
|---------------------------------|---------------------------------|
| 1. SAS cable connector | 2. SAS cable connector |
| 3. Signal cable connector | 4. Power cable connector |
| 5. Power cable connector | 6. Signal cable (A2)connector |
| 7. Signal cable (B2) connector | 8. Signal cable (A1) connector |
| 9. Signal cable (B1) connector | 10. Signal cable (A0) connector |
| 11. Signal cable (B0) connector | |

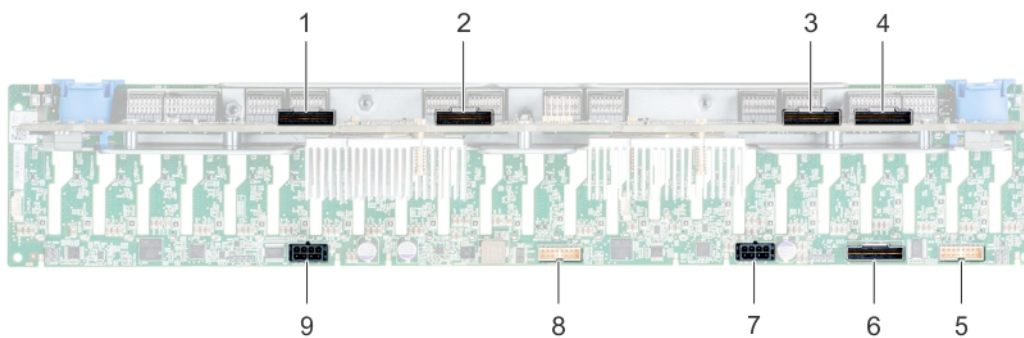

Figure 48. 24 x 2.5 inch NVMe drive backplane

- | | |
|--|--|
| 1. Expander board connector B1 (PE1_B) | 2. Expander board connector A1 (PE1_A) |
| 3. Expander board connector B2 (PE2_B) | 4. Expander board connector A2 (PE2_A) |
| 5. signal connector (J_SIG_A1) | 6. SAS connector (J_BP_SAS) |
| 7. power connector (J_BP_PWR_A1) | 8. signal connector (J_SIG_A2) |
| 9. power connector (J_BP_PWR_A2) | |

Removing the drive backplane

Prerequisites

CAUTION: To prevent damage to the drives and backplane, you must remove the drives from the system before removing the backplane.

CAUTION: Note the number of each drive and temporarily label them before removal so that you can replace them in the same drive slots.

1. Follow the safety guidelines listed in the [Safety instructions](#).
2. Follow the procedure listed in the [Before working inside your system](#).
3. [Remove all the drives](#) from the front.
4. If applicable, [remove the drive backplane cover](#).

NOTE: Observe the routing of the cable as you remove it from the system.

Steps

1. Press the blue release tabs to disengage the drive backplane from the hooks on the chassis.
2. Lift the drive backplane from the system.

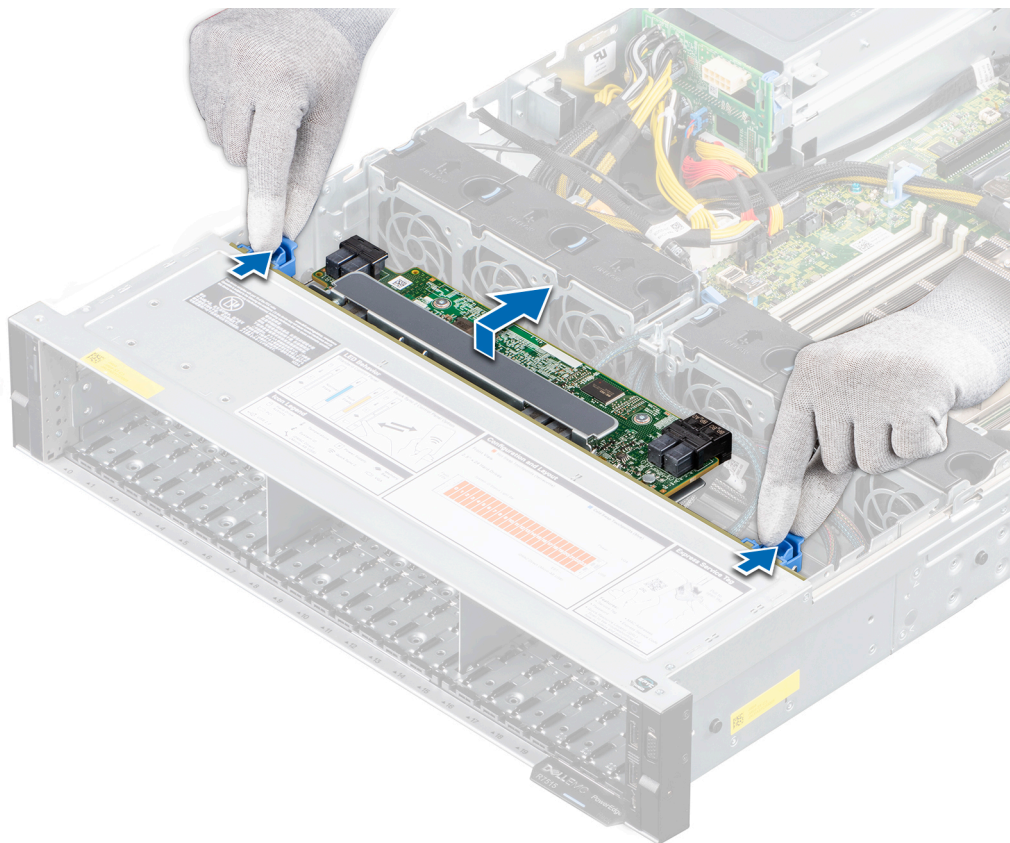

Figure 49. Removing the drive backplane

3. Disconnect the following cables from the backplane:
 - a. Backplane signal cable
 - b. Backplane power cable
 - c. If applicable, PERC cable

Next steps

1. [Replace the drive backplane](#).

Installing the drive backplane

Prerequisites

1. Follow the safety guidelines listed in the [Safety instructions](#).
2. Follow the procedure listed in the [Before working inside your system](#).
3. [Remove the drives](#).
4. If applicable, [remove the drive backplane cover](#).

i **NOTE:** Route the cable properly when you replace it to prevent the cable from being pinched or crimped.

Steps

1. Connect the following cables to the backplane:
 - a. Backplane signal cable
 - b. Backplane power cable
 - c. If applicable, PERC cable
2. Align the slots on the backplane with the hooks on the chassis.
3. Lower the backplane until the blue release tabs click into place.

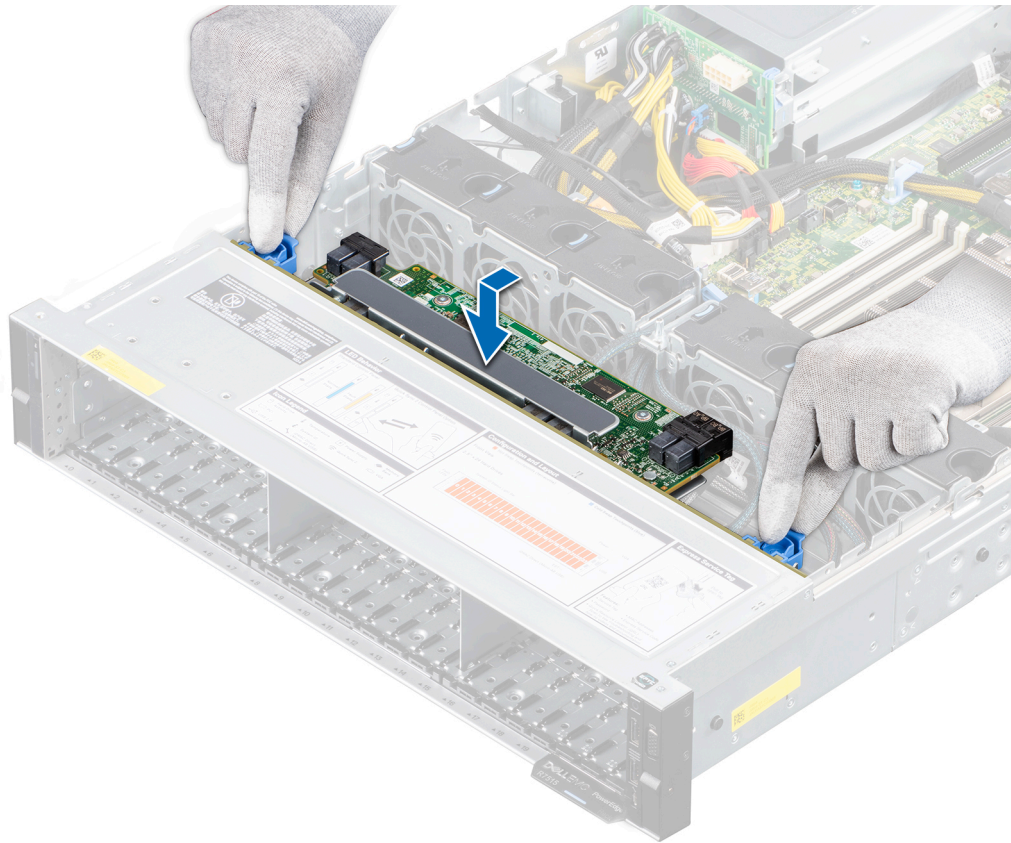

Figure 50. Installing the drive backplane

Next steps

1. [Install the drives](#) in their original locations.
2. [Install the drive backplane cover](#).
3. Follow the procedure listed in [After working inside your system](#).

Removing the rear drive backplane

Prerequisites

CAUTION: To prevent damage to the drives and backplane, you must remove the drives from the system before removing the backplane.

CAUTION: You must note the number of each hard drive and temporarily label them before removal so that you can replace them in the same locations.

1. Follow the safety guidelines listed in the [Safety instructions](#).
2. Follow the procedure listed in the [Before working inside your system](#).
3. [Remove all the drives](#) from the rear drive cage.
4. Disconnect all the cables from the backplane.
5. [Remove the rear drive cage](#).

Steps

1. Using a Phillips #2 screwdriver, remove the screws that secure the drive backplane to the rear drive cage.
2. Disengage the backplane from the hooks on the rear drive cage, and remove it from the rear drive cage.

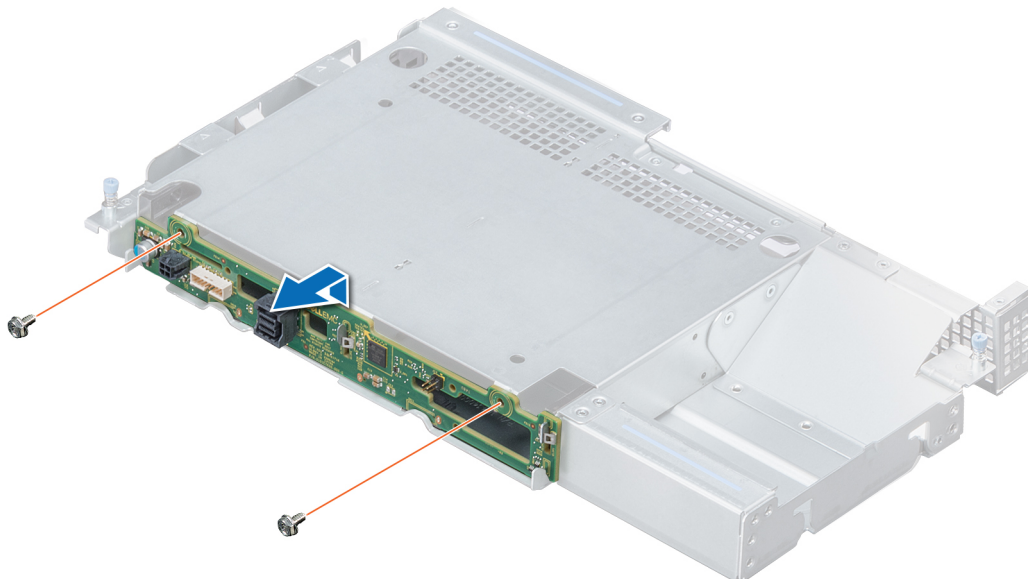

Figure 51. Removing the rear drive backplane

Next steps

[Install the rear drive backplane.](#)

Installing the rear drive backplane

Prerequisites

1. Follow the safety guidelines listed in the [Safety instructions](#).
2. Follow the procedure listed in the [Before working inside your system](#).
3. Remove all the drives from the rear drive cage.
4. Disconnect all the cables from the backplane.
5. [Remove the rear drive cage](#).

Steps

1. Align the slots on the backplane with the hooks on the rear drive cage.
2. Lower the backplane into the rear drive cage until it is firmly seated.
3. Using a Phillips #2 screwdriver, tighten the screws to secure the backplane to the rear drive cage.

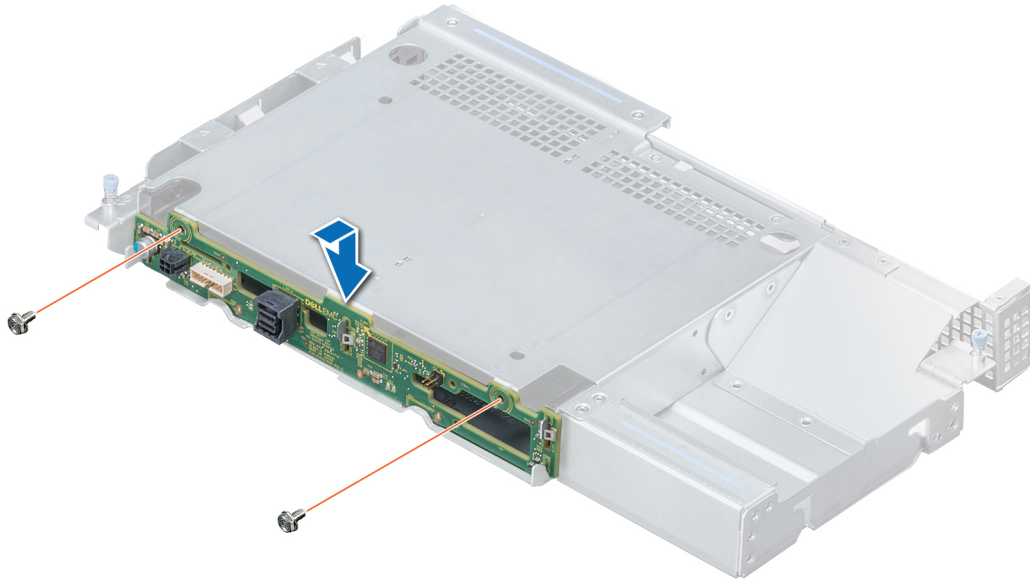

Figure 52. Installing the rear drive backplane

Next steps

1. [Install the rear drive cage.](#)
2. Connect all the cables to the backplane.
3. [Install the drives](#) in their original location.
4. Follow the procedure listed in [After working inside your system.](#)

Rear drive cage

Removing the rear drive cage

Prerequisites

1. Follow the safety guidelines listed in the [Safety instructions.](#)
2. Follow the procedure listed in the [Before working inside your system.](#)
3. [Remove the drives.](#)
4. [Remove the air shroud.](#)

Steps

1. Using a Phillips #2 screwdriver, loosen the captive screws that secure the rear drive cage to the system.
2. Slide the rear drive cage towards the front of the system to disengage it from the system.
3. Remove the rear drive cage from the system.

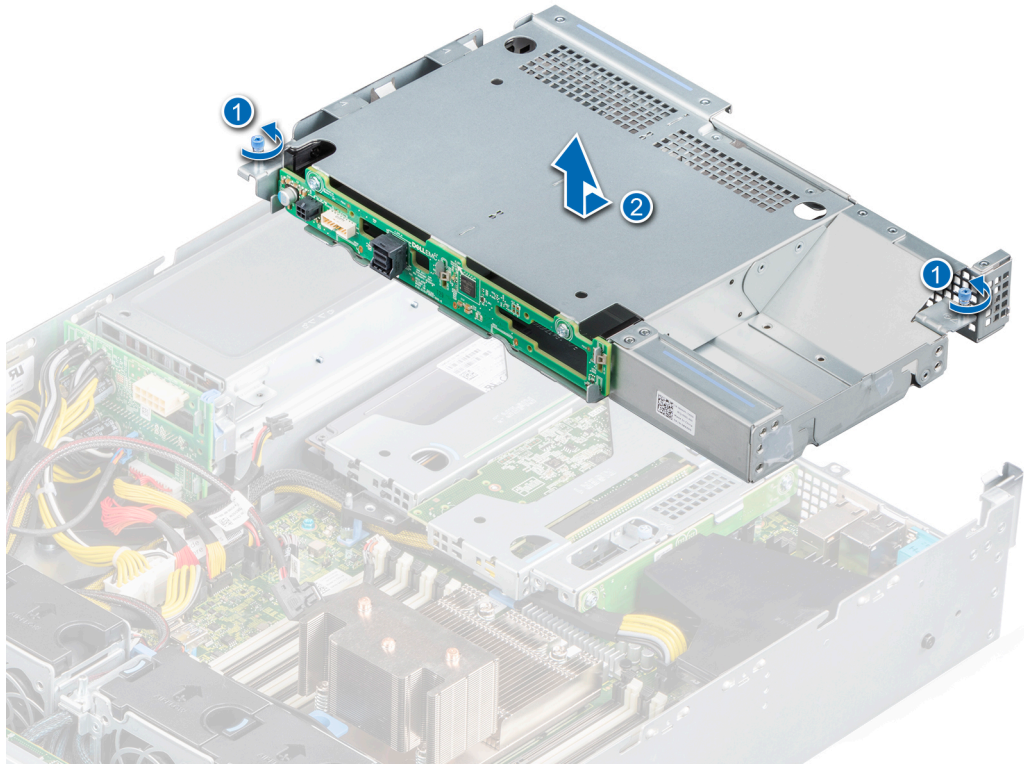

Figure 53. Removing the rear drive cage

Next steps

1. [Replace the rear drive cage.](#)

Installing the rear drive cage

Prerequisites

1. Follow the safety guidelines listed in the [Safety instructions](#).
2. Follow the procedure listed in the [Before working inside your system](#).
3. [Remove the drives.](#)

Steps

1. Align the rear drive cage with the guide pins on the PSU cage.
2. Lower the rear drive cage and slide it to the rear of the system until it is firmly seated.
3. Using a Phillips #2 screwdriver, tighten the captive screws to secure the rear drive cage to the system.

NOTE: Store the filler bracket for future use. Filler brackets must be installed in empty expansion card slots to maintain Federal Communications Commission (FCC) certification of the system. The brackets also keep dust and dirt out of the system and aid in proper cooling and airflow inside the system.

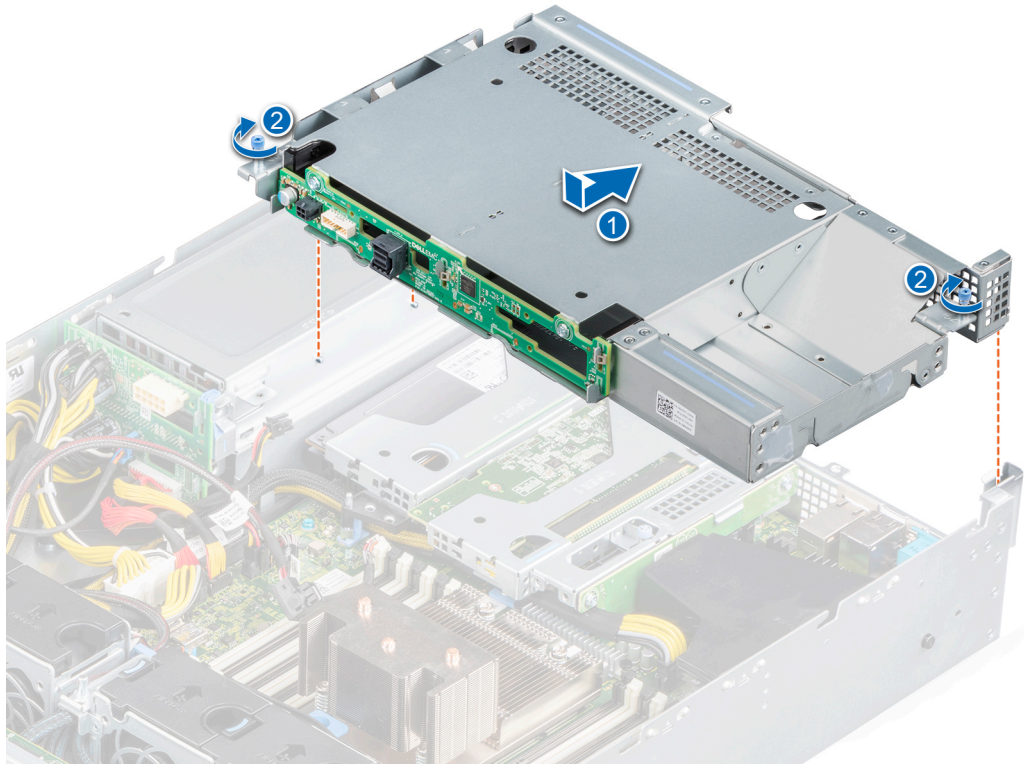

Figure 54. Installing the rear drive cage

Next steps

1. [Install the drives](#) in their original locations.
2. [Install the air shroud](#).
3. Follow the procedure listed in [After working inside your system](#).

System memory

System memory guidelines

The PowerEdge R7515 system supports DDR4 registered DIMMs (RDIMMs) and load reduced DIMMs (LRDIMMs). System memory holds the instructions that are executed by the processor.

Your system memory is organized into eight channels per processor (two memory sockets per channel) for a total of 16 memory sockets per processor. In each channel, the 1st socket is marked white and the 2nd socket black.

Memory channels are organized as follows:

Table 12. Memory channels

Processor	Channel A	Channel B	Channel C	Channel D	Channel E	Channel F	Channel G	Channel H
AMD Processor	Slots 6 and 12	Slots 5 and 11	Slots 2 and 10	Slots 1 and 9	Slots 8 and 16	Slots 7 and 15	Slots 4 and 14	Slots 3 and 13

Table 13. Supported memory matrix

DIMM type	Rank	Capacity	DIMM rated voltage and speed	Operating Speed	
				1 DIMM per Channel (DPC)	2 DIMMs per Channel (DPC)

Table 13. Supported memory matrix (continued)

DIMM type	Rank	Capacity	DIMM rated voltage and speed	Operating Speed	
RDIMM	1R	8 GB	DDR4 (1.2 V), 3200 MT/s	3200 MT/s	2933 MT/s
	2R	16 GB, 32 GB, 64 GB	DDR4 (1.2 V), 3200 MT/s	3200 MT/s	2933 MT/s
LRDIMM	8R	128 GB	DDR4 (1.2 V), 2666 MT/s	2666 MT/s	2666 MT/s
	8R	128 GB	DDR4 (1.2 V), 3200 MT/s	3200 MT/s	2933 MT/s

NOTE: The older 32 GB capacity RDIMM memory with x4 data width and 8Gb DRAM density cannot be mixed with the newer 32 GB capacity RDIMM memory with x8 data width and 16Gb DRAM density in the same AMD EPYC™ processor unit.

NOTE: The older 128 GB capacity LRDIMM memory at 2666 MT/s speed cannot be mixed with the new 128 GB capacity LRDIMM memory at 3200 MT/s speed.

General memory module installation guidelines

To ensure optimal performance of your system, observe the following general guidelines when configuring your system memory. If your system's memory configurations fail to observe these guidelines, your system might not boot, stop responding during memory configuration, or operate with reduced memory. This section provides information on the memory population rules and about the non-uniform memory access (NUMA) for single or dual processor system.

The memory bus may operate at speeds of 3200 MT/s, 2933 MT/s, or 2666 MT/s depending on the following factors:

- System profile selected (for example, Performance Optimized, or Custom [can be run at high speed or lower])
- Maximum supported DIMM speed of the processors
- Maximum supported speed of the DIMMs

NOTE: MT/s indicates DIMM speed in MegaTransfers per second.

The system supports Flexible Memory Configuration, enabling the system to be configured and run in any valid chipset architectural configuration. The following are the recommended guidelines for installing memory modules:

- All DIMMs must be DDR4.
- Mixing of memory module capacities in a system is not supported.
- If memory modules with different speeds are installed, they operate at the speed of the slowest installed memory module(s).
- Populate memory module sockets only if a processor is installed.
 - For single-processor systems, sockets A1 to A16 are available.
 - In Optimizer Mode, the DRAM controllers operate independently in the 64-bit mode and provide optimized memory performance.

Table 14. Memory population rules

Processor	Configuration	Memory population	Memory population information
Single processor	Optimizer (Independent channel) population order	A{1}, A{2}, A{3}, A{4}, A{5}, A{6}, A{7}, A{8}, A{9}, A{10}, A{11}, A{12}, A{13}, A{14}, A{15}, A{16}	Odd amount of DIMMs per processor allowed.

- Populate all the sockets with white release tabs first, followed by the black release tabs.
- Unbalanced or odd memory configuration results in a performance loss and system may not identify the memory modules being installed, so always populate memory channels identically with equal DIMMs for best performance.
- Minimum recommended configuration is to populate four equal memory modules per processor. AMD recommends limiting processors in that system to 32 cores or less.
- Populate eight equal memory modules per processor (one DIMM per channel) at a time to maximize performance.

NOTE: Equal memory modules refer to DIMMs with identical electrical specification and capacity that may be from different vendors.

Memory interleaving with Non-uniform memory access (NUMA)

Non-uniform memory access (NUMA) is a memory design used in multi-processing, where the memory access time depends on the memory location relative to the processor. In NUMA, a processor can access its own local memory faster than the non-local memory.

NUMA nodes per socket (NPS) is a new feature added that allows you to configure the memory NUMA domains per socket. The configuration can consist of one whole domain (NPS1), two domains (NPS2), or four domains (NPS4). In the case of a two-socket platform, an additional NPS profile is available to have whole system memory to be mapped as single NUMA domain (NPS0). For more information on the memory interleaving for NPSx, see the Memory interleaving population rules section in this topic.

BIOS implementation for NPSx

- The BIOS Setup menu presents the applicable NPSx options based on the underlying model number. A change to the current NPSx is communicated to pre-BIOS firmware to take effect on the next boot. The default NPS setting is 1.
- During boot, if the selected NPSx option is not allowed for the model number (for example, if the processor model number changes between reboot), system will halt at the end of POST with UEFI0388 message displayed. On the next reboot, the system will fall back to NPS1 default setting.
- During boot, if the preferred interleaving for the current NPSx is not possible due to memory configuration (for example, the memory population is inconsistent with the preferred interleaving), BIOS shows a warning message UEFI0391.

i **NOTE:** System is functional when UEFI0391 message is displayed. However, the system may not be configured for optimal performance.

NPS system optimization

Optimal system configuration is dependent on the processor model, memory configuration, and NPS settings. Match the memory configuration with the NPS settings available for the processor.

Table 15. Supported NPS modes by Processors

Model Number	NPS modes supported
7773X	4, 2, 1, 0
7573X	4, 2, 1, 0
75F3	4, 2, 1, 0
7713P	4, 2, 1
7663	4, 2, 1, 0
7513	4, 2, 1, 0
7543P	4, 2, 1
74F3	4, 2, 1, 0
7443	4, 2, 1, 0
7443P	4, 2, 1
7313P	4, 2, 1
7643	4, 2, 1, 0
72F3	4, 2, 1, 0
7742	4, 2, 1, 0
7702	4, 2, 1, 0
7702P	4, 2, 1
7662	4, 2, 1, 0
7642	4, 2, 1, 0
7552	2, 1, 0
7542	4, 2, 1, 0
7532	4, 2, 1, 0
7502	4, 2, 1, 0

Table 15. Supported NPS modes by Processors (continued)

Model Number	NPS modes supported
7502P	4, 2, 1
7452	4, 2, 1, 0
7402	4, 2, 1, 0
7402P	4, 2, 1
7352	4, 2, 1, 0
7302	4, 2, 1, 0
7302P	4, 2, 1
7282	1, 0
7272	1, 0
7262	4, 2, 1, 0
7252	1, 0
7232P	1
7F72	2, 1, 0
7F52	4, 2, 1, 0
7F32	4, 2, 1, 0
7H12	4, 2, 1, 0
7763	4, 2, 1, 0
7413	4, 2, 1, 0
75F3	4, 2, 1, 0
7713P	4, 2, 1
7513	4, 2, 1, 0
7543P	4, 2, 1
7443P	4, 2, 1
7313P	4, 2, 1

Table 16. Optimal NPS configuration

Number of DIMMs per processor	NPS			
	0	1	2	4
1				X
2				X
3				X
4		X		
5				X
6				X
7				X
8	X	X		
9				X
10				X

Table 16. Optimal NPS configuration (continued)

Number of DIMMs per processor	NPS			
	0	1	2	4
11				X
12			X	
13				X
14				X
15				X
16	X	X		

- Recommended NPS setting is marked by X that indicate optimal performance.
- NPS0 is only available for dual processor systems and is the preferred setting.
- The NPS setting that are blank are functional. However, indicate non-optimal performance.
- BIOS default NPS setting is 1.
- UEFI0391 message may be displayed during boot if DIMMs are configured in the blank spaces of the table.
- If the processor does not support the desired NPS setting for a given number of DIMMs, then use default setting (NPS1) and the UEFI0391 message is displayed.

Memory interleaving population rules

- NPS4: Two channel interleaving
 - This interleaves channel [A and B], [C and D], etc.
 - Each channel within the pair requires at least one equal memory modules populated.
 - Works with three memory modules per channel pair, non-symmetrical module is stacked on top (odd configurations).
 - Any memory channel where one of the two channels is not populated is not interleaved.
 - There is no alternate, as all configurations can be mapped into this mode.
 - NPS2: Four channel interleaving
 - This interleaves the four channels on the left or right half of a processor which are channels [A, B, C, D] and [E, F, G, H].
 - All four channels require equal memory modules populated.
 - Each half or interleave set may have different total memory capacity with respect to each other.
 - NPS1: Eight channel interleaving
 - This interleaves all channels in a processor [A, B, C, D, E, F, G, H].
 - All channels in a processor require equal memory modules populated.
 - Single processor system creates a single NUMA node for the system.
- NOTE:** An exception is allowed when system has 4-channels populated [C, D, G, H] with equal memory allowing the system to enter NPS1 mode even though all the 8 channels are not populated.

Removing a memory module

Prerequisites

1. Follow the safety guidelines listed in the [Safety instructions](#).
2. Follow the procedure listed in the [Before working inside your system](#).
3. [Remove the air shroud](#).

NOTE: The memory modules are hot to touch for some time after the system has been powered down. Allow the memory modules to cool before handling them. Handle the memory modules by the card edges and avoid touching the components or metallic contacts on the memory module.

Steps

1. Locate the appropriate memory module socket.

CAUTION: Handle each memory module only by the card edges, ensuring not to touch the middle of the memory module or metallic contacts.

2. To release the memory module from the socket, simultaneously press the ejectors on both ends of the memory module socket.
3. Lift the memory module away from the system.

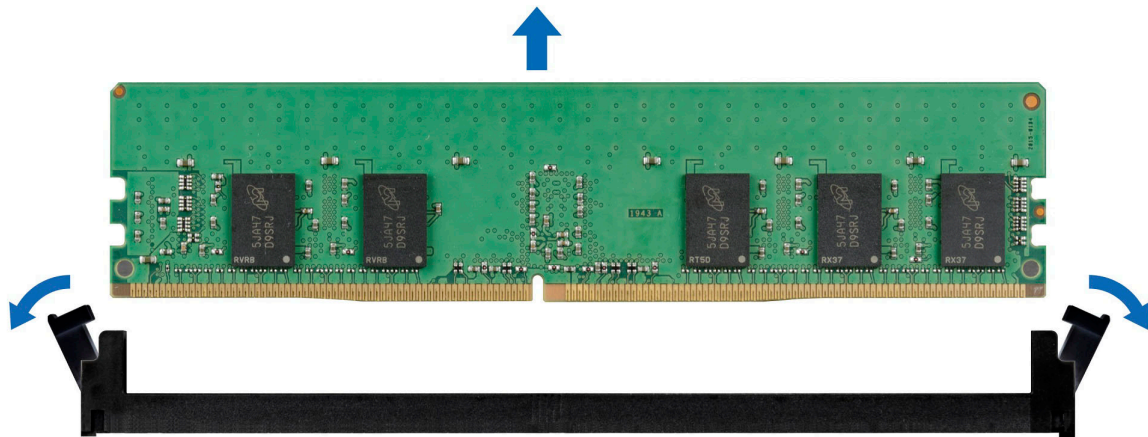

Figure 55. Removing a memory module

Next steps

1. [Replace the memory module.](#)

Installing a memory module

Prerequisites

1. Follow the safety guidelines listed in the [Safety instructions](#).
2. Follow the procedure listed in the [Before working inside your system](#).
3. [Remove the air shroud.](#)

Steps

1. Locate the appropriate memory module socket.

CAUTION: Handle each memory module only by the card edges, ensuring not to touch the middle of the memory module or metallic contacts.

2. If a memory module is installed in the socket, remove it.

NOTE: Ensure the socket ejector latches are fully open, before installing the memory module.

3. Align the edge connector of the memory module with the alignment key of the memory module socket, and insert the memory module in the socket.

CAUTION: To prevent damage to the memory module or the memory module socket during installation, do not bend or flex the memory module; insert both ends of the memory module simultaneously.

NOTE: The memory module socket has an alignment key that enables you to install the memory module in the socket in only one orientation.

CAUTION: Do not apply pressure at the center of the memory module; apply pressure at both ends of the memory module evenly.

4. Press the memory module with your thumbs until the ejectors firmly click into place.

When the memory module is properly seated in the socket, the levers on the memory module socket align with the levers on the other sockets that have memory modules installed.

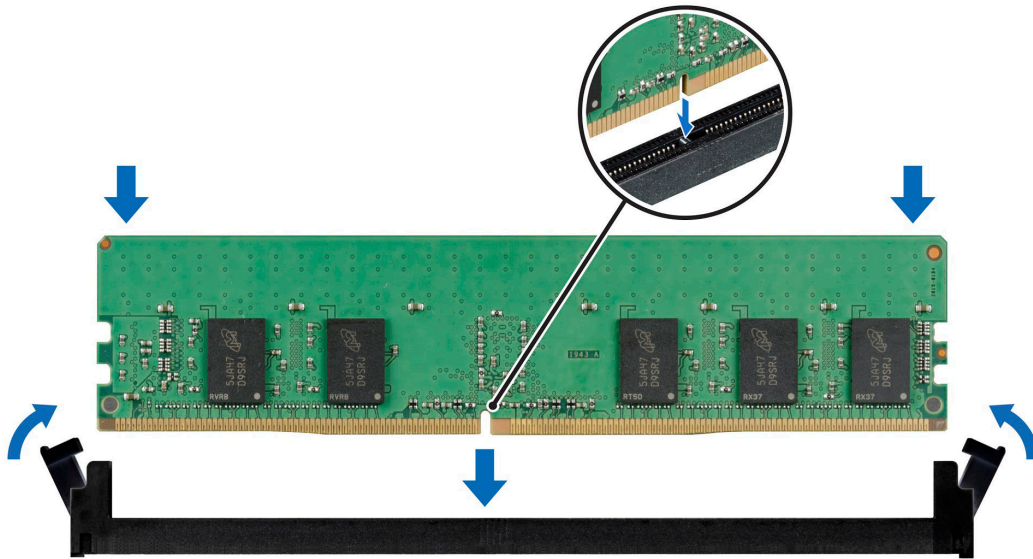

Figure 56. Installing a memory module

Next steps

1. [Install the air shroud.](#)
2. Follow the procedure listed in [After working inside your system.](#)
3. Press F2 to enter System Setup, and check the **System Memory** setting.

The **System Memory Size** indicates the installed memory.

4. If the **System Memory Size** is incorrect, one or more of the memory modules may not be installed properly. Ensure that the memory modules are firmly seated in their sockets.
5. Run the system memory test in the system diagnostics.

Processor and heat sink

Removing the heat sink

Prerequisites

1. Follow the safety guidelines listed in the [Safety instructions.](#)
2. Follow the procedure listed in the [Before working inside your system.](#)
3. [Remove the air shroud.](#)

NOTE: The heat sink and processor are too hot to touch for some time after the system has been powered down. Allow the heat sink and processor to cool down before handling them.

Steps

1. Using a Torx #T20 screwdriver, loosen the captive screws in the order mentioned on the heat sink:

NOTE: The captive screw numbers are marked on the heat sink.

- a. Partially loosen the captive screws 1 and 2 (approximately 3 turns).
 - b. Partially loosen the captive screws 3 and 4 (approximately 3 turns).
 - c. Loosen the captive screws 1 and 2 completely.
 - d. Loosen the captive screws 3 and 4 completely.
2. Lift the heat sink from the system.

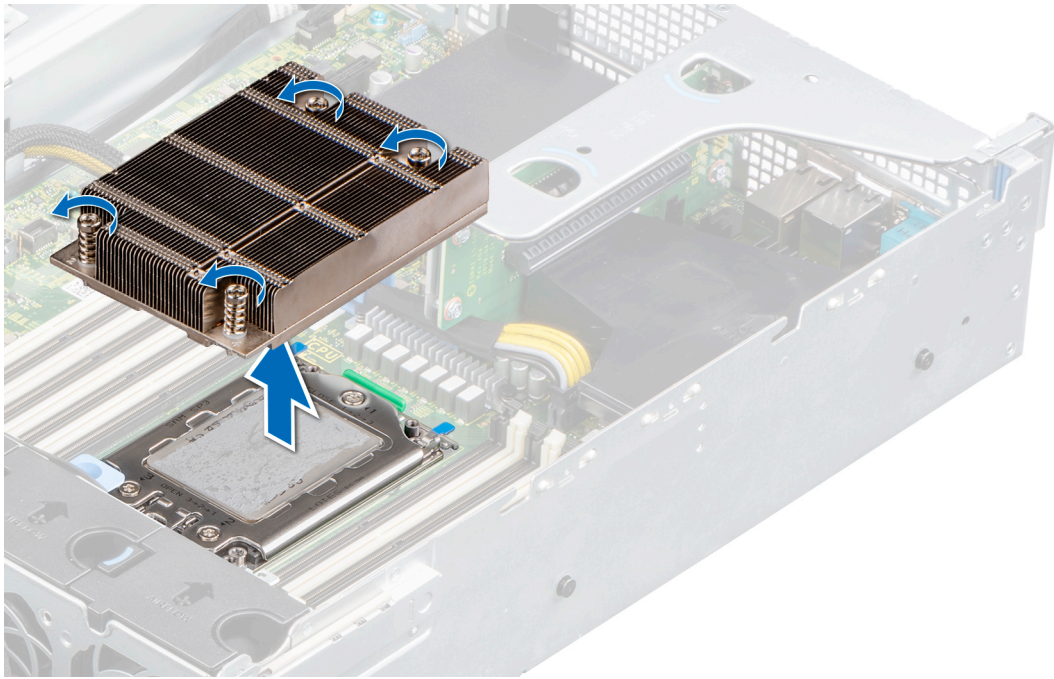

Figure 57. Removing the heat sink

Next steps

1. If you are removing a faulty heat sink, [replace the heat sink](#), if not, [remove the processor](#).

Removing the processor

Prerequisites

CAUTION: The heat sink may be hot to touch for some time after the system has been powered off. Allow the heat sink to cool before removing it.

1. Follow the safety guidelines listed in the [Safety instructions](#).
2. Follow the procedure listed in the [Before working inside your system](#).
3. [Remove the air shroud](#).
4. [Remove the heat sink](#).

CAUTION: You may find the CMOS battery loss or CMOS checksum error displayed during the first instance of powering on the system after the processor or system board replacement which is expected. To fix this, simply go to setup option to configure the system settings.

Steps

1. Using a Torx #T20 screwdriver, loosen the screws to release the force plate. The sequence to loosen the screws is 3, 2, and 1.

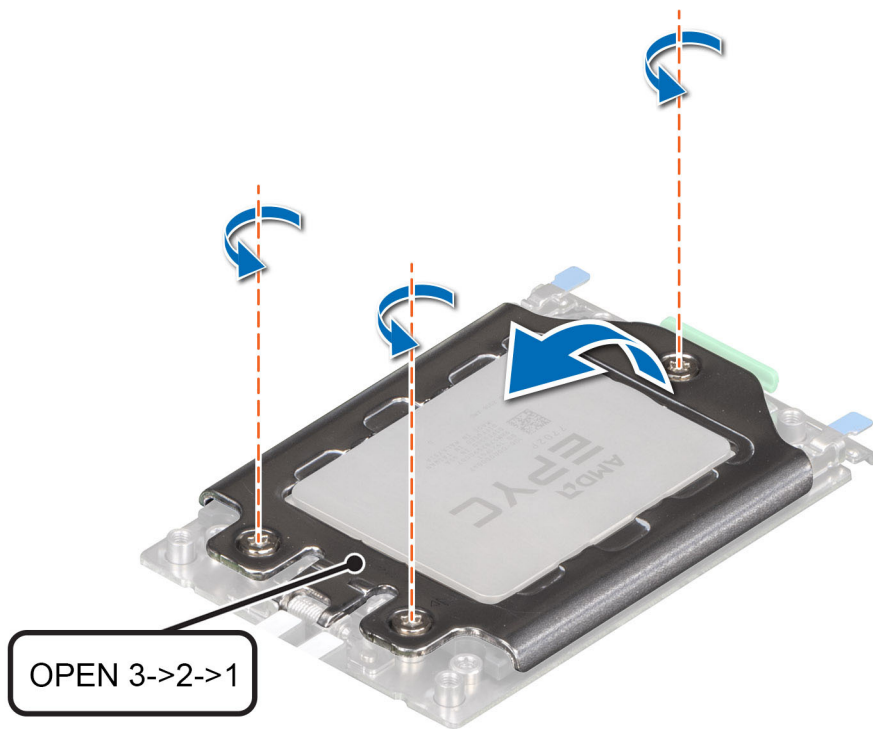

Figure 58. Removing screws on the force plate

2. Release the processor socket rail frame by lifting up the blue latches.

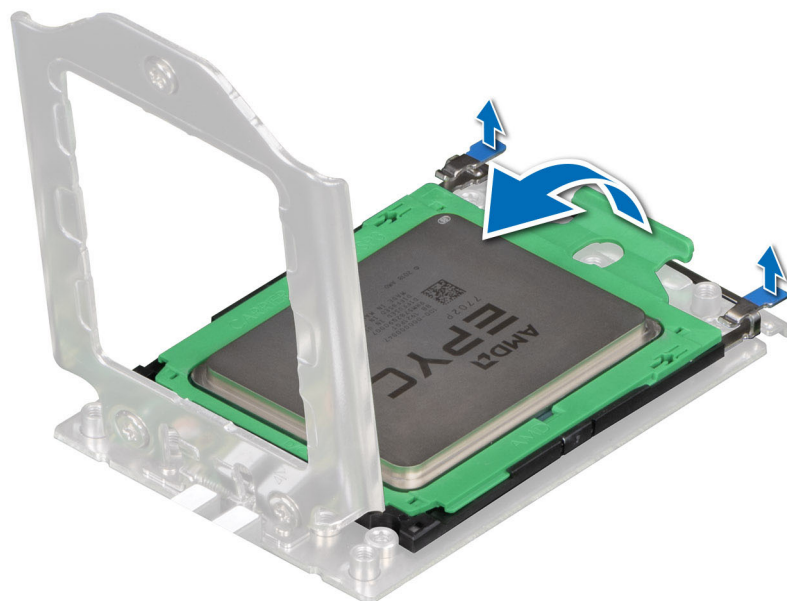

Figure 59. Lifting the rail frame

3. Holding the blue tab on the processor tray, slide the tray out of the rail frame.

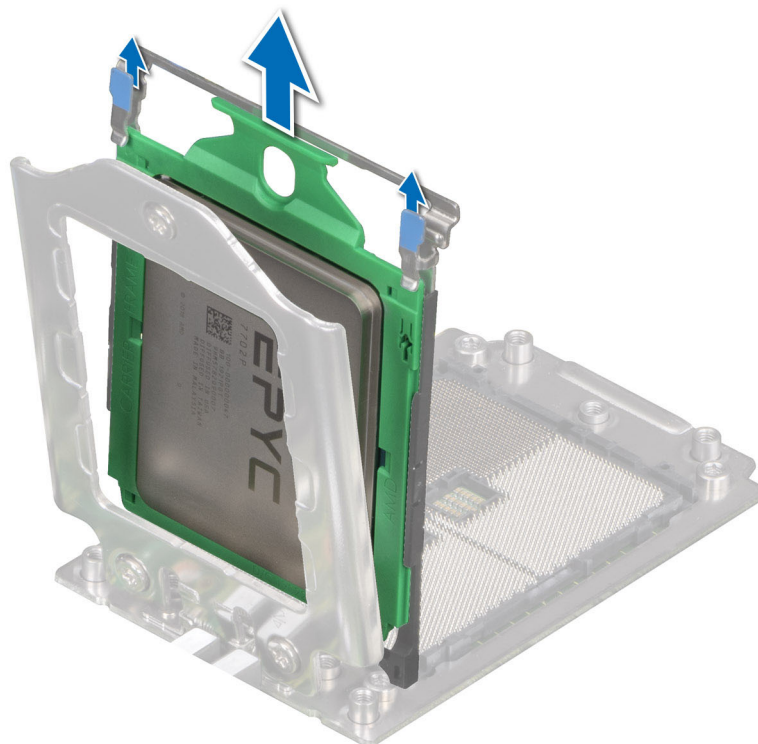

Figure 60. Removing the processor tray

Next steps

1. [Replace the processor.](#)

Installing the processor

Prerequisites

1. Follow the safety guidelines listed in the [Safety instructions](#).
2. Follow the procedure listed in [Before working inside your system](#).
3. [Remove the air shroud](#).
4. [Remove the heat sink](#).
5. If the processor has previously been used in a system, remove any remaining thermal grease from the processor by using a lint-free cloth.
6. Use the thermal grease syringe included with your processor kit to apply the grease in a quadrilateral design on the top of the processor.

CAUTION: Applying too much thermal grease can result in excess grease coming in contact with and contaminating the processor socket.

NOTE: The thermal grease syringe is intended for single use only. Dispose the syringe after you use it.

Steps

1. Holding the blue tab on the processor tray, slide the tray into the processor socket rail frame until firmly seated.

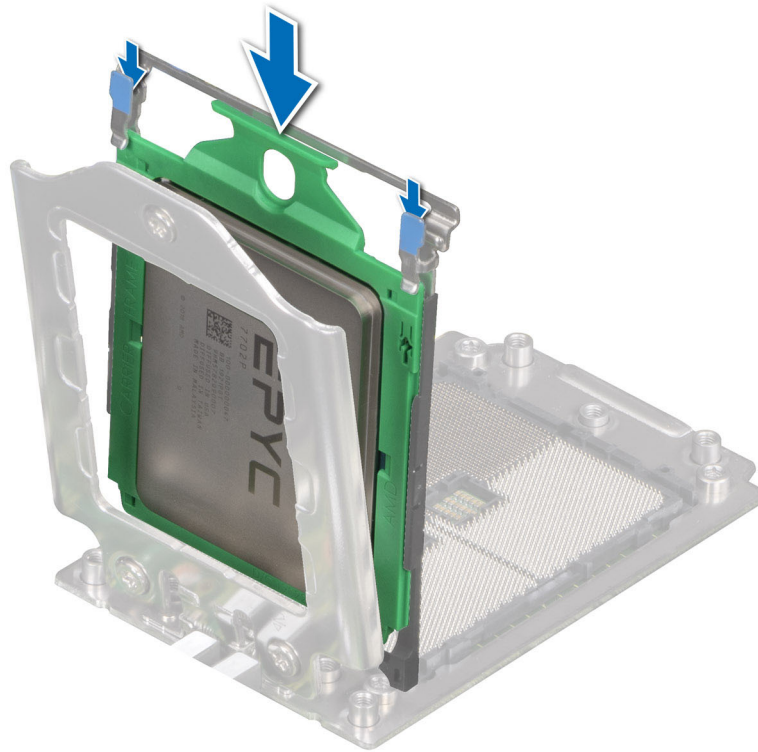

Figure 61. Placing the processor tray into the rail frame

2. Push the rail frame down until the blue latches lock into place.

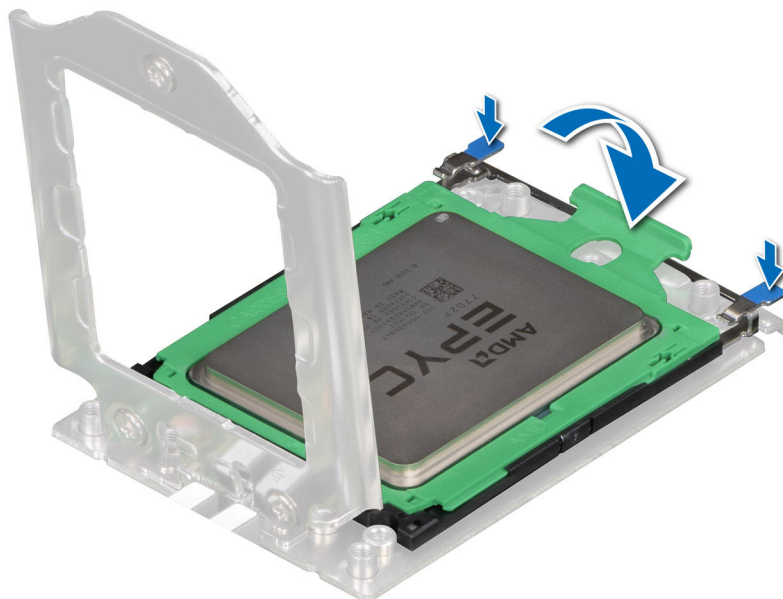

Figure 62. Closing the rail frame

3. Secure the force plate to the processor socket base by tightening the screws in the sequence 1, 2, and 3. When all three screws are fully threaded, the socket is then actuated. The three screws are tightened to a torque value of 12.0 ± 1.0 lbf-in.

NOTE: Press the force plate while tightening the screws to avoid tilting of the processor cover out of the processor socket.

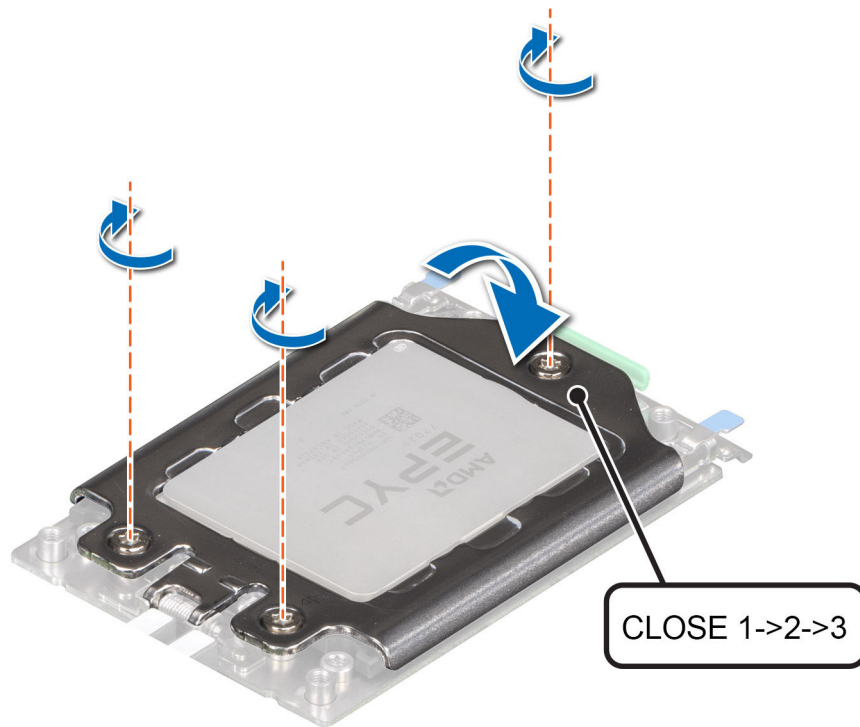

Figure 63. Securing the force plate

Next steps

1. Install the heat sink.
2. Install the air shroud.
3. Follow the procedure listed in [After working inside your system](#).

Installing the heat sink

Prerequisites

1. Follow the safety guidelines listed in the [Safety instructions](#).
2. Follow the procedure listed in the [Before working inside your system](#).
3. [Remove the air shroud](#).

Steps

1. If you are using an existing heat sink, remove the thermal grease from the heat sink using a clean lint-free cloth.
2. Use the thermal grease syringe included with your processor kit to apply the grease in a thin spiral on the top of the processor.

CAUTION: Applying too much thermal grease can result in excess grease coming in contact with and contaminating the processor socket.

NOTE: The thermal grease syringe is intended for one-time use only. Dispose the syringe after you use it.

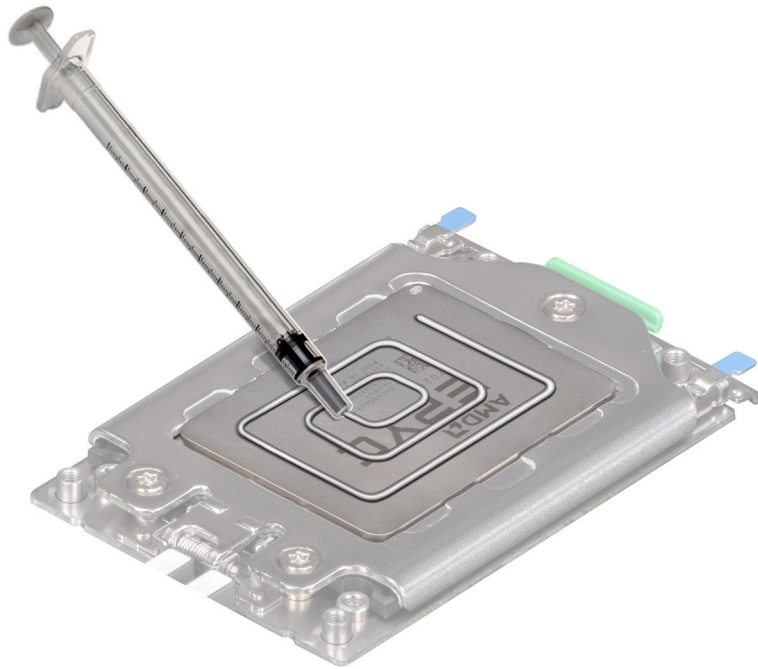

Figure 64. Applying thermal grease on the processor

3. Align the screws on the heat sink with the standoff screws on the system board.
4. Using a Torx #T20 screwdriver, tighten the captive screws in the order mentioned below:

i **NOTE:** The captive screw numbers are marked on the heat sink.

- a. Partially tighten the captive screws 1 and 2 (approximately 3 turns).
- b. Partially tighten the captive screws 3 and 4 (approximately 3 turns).
- c. Tighten the captive screws 1 and 2 completely.
- d. Tighten the captive screws 3 and 4 completely.

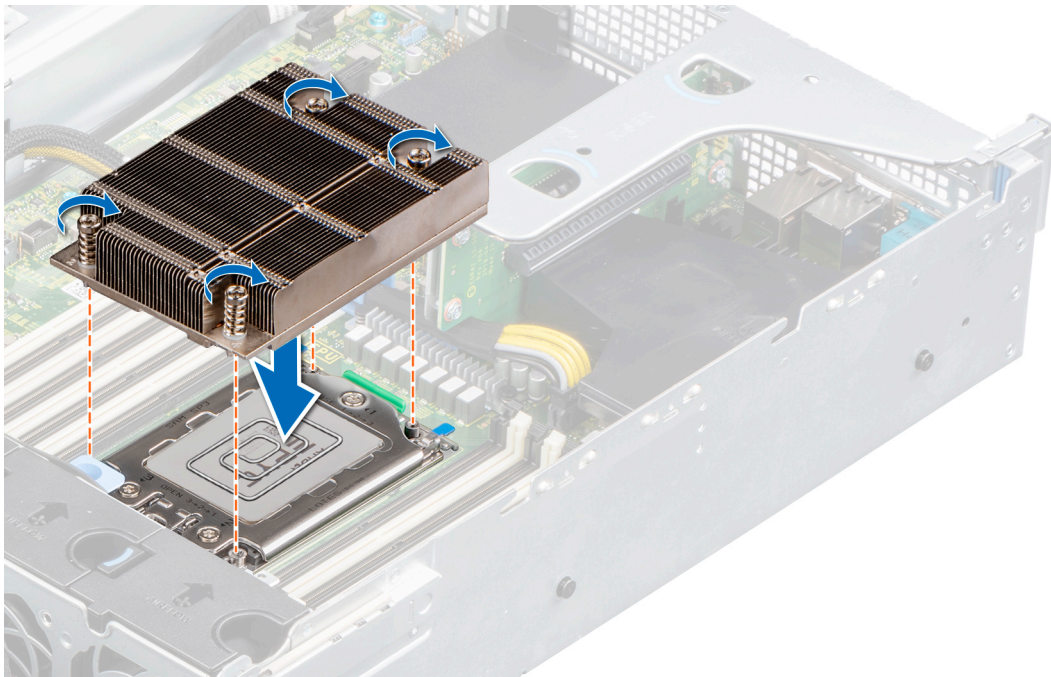

Figure 65. Installing the heat sink

5. Return to the first screw to tighten it.

Next steps

1. Install the air shroud.
2. Follow the procedure listed in [After working inside your system](#).

Expansion cards and expansion card risers

NOTE: A system event entry is logged in the iDRAC Lifecycle Controller if an expansion card riser is not supported or missing. It does not prevent your system from turning on. However, if a F1/F2 pause occurs with an error message, see *Troubleshooting expansion cards* section in the *Dell EMC PowerEdge Servers Troubleshooting Guide* at www.dell.com/poweredgemanuals.

Expansion card installation guidelines

The following table describes the supported expansion cards:

Table 17. Expansion card riser configurations

Expansion card riser	PCIe slots on the riser	Processor connection	Height	Length	Slot width
Riser-1B (2U riser)	Slot 2	Processor 1	Full Height	Full Length	x16
Riser-1B (2U riser)	Slot 3	Processor 1	Full Height	Full Length	x16
Riser-1A (low profile riser right)	Slot 2	Processor 1	Low Profile	Half Length	x16
Riser-2 (low profile riser left)	Slot 3	Processor 1	Low Profile	Half Length	x16

NOTE: The expansion-card slots are not hot-swappable.

The following table provides guidelines for installing expansion cards to ensure proper cooling and mechanical fit. The expansion cards with the highest priority should be installed first using the slot priority indicated. All the other expansion cards should be installed in the card priority and slot priority order.

Table 18. Riser configurations: No riser – CPU

Card Type	Slot Priority	Maximum number of cards
LOM riser ; 2x1G BCM5720L (FXN)	1	1
LOM riser ; 2x10G BCM57416 (BASeT/ SFP+) (FXN)	1	1
LOM riser ; 2x25G (Broadcom)	1	1
GPU: Nvidia A2 16GB (LP)	5	1
GPU: Nvidia T4 16GB	5, 4	2
NVMe PCIe SSD	5, 4	2
Mellanox 100G (CX5/CX6 H100)	4, 5	2
Mellanox 25G (CX4LX DP/CX5 DP)	5, 4	2
Emulex (FC32 SP/DP)	4, 5	2
Emulex (FC16 SP/DP)	5, 4	2
Emulex (HBA FC64 LP 2P S28)	4, 5	2
Emulex (HBA FC32 1P S28)	5, 4	2
Qlogic (HBA FC32 SP/DP)	4, 5	2

Table 18. Riser configurations: No riser – CPU (continued)

Card Type	Slot Priority	Maximum number of cards
Qlogic (HBA FC16 SP/DP)	5, 4	2
Qlogic 10G (SFP DP)	5, 4	2
Qlogic 25G (BaseT DP)	5, 4	2
Qlogic (HBA FC32 1P S28)	4, 5	2
Solarflare 25G (SFP DP)	5, 4	2
Intel 10G (BaseT DP)	5, 4	2
Intel 10G (SFP+ DP)	5, 4	2
Intel 1G (QP)	5, 4	2
Intel 25G SFP DP	5, 4	2
Intel 25G LP 2P S28	5, 4	2
Broadcom 1G (QP)	5, 4	2
Broadcom 10G (BaseT DP)	5, 4	2
Broadcom 25G (SFP DP)	5, 4	2
PERC 10: External adapter (Dell)	4, 5	1
HBA: External adapter (Dell)	4, 5	1
Internal storage (BOSS)	5, 4	1
PERC 9: Mini mono (H730P/H330)	Integrated slot	1
PERC 10 : Mini mono (H740P)	Integrated slot	1
PERC 11: Mini mono (H350)	Integrated slot	1
HBA :Mini mono (HBA330/HBA350i)	Integrated slot	1
PERC 10: External adapter (H840)	5, 4	2
PERC 10: External adapter (H840) (FH or LP)	5, 4	2
PERC 11: External adapter (HBA355E)	5, 4	2
HBA: External adapter	5, 4	2
LOM riser (2x1G)/(2x10G)/(2x25G)	1	1
Intel, NIC: 100Gb, CRD,NTWK,INTL,LP,100G,2P,Q28	4,5	2
Emulex, HBA: FC32, CRD,CTL,FC32,2P,LPE35002,EMX,L	4,5	2
Broadcom, NIC: 10Gb, CRD,NTWK,BCME,LP,10G,4P,BT	5,4	2
HBA: External Adapter, KIT,CRD,CTL,HBA,12GBPS-SAS	5,4	2

Table 19. Riser configurations: Riser 1A + Riser 2 – CPU

Card type	Slot priority	Maximum number of cards
LOM riser ; 2x1G BCM5720L	1	1
LOM riser ; 2x10G BCM57416 (BASeT/ SFP+)	1	1

Table 19. Riser configurations: Riser 1A + Riser 2 – CPU (continued)

Card type	Slot priority	Maximum number of cards
LOM riser ; 2x25G (Broadcom)	1	1
NVMe PCIe SSD	2, 3	2
Mellanox 100G (CX5/CX6 H100)	3, 2	2
Mellanox 25G (CX4LX DP/CX5 DP)	2, 3	2
Emulex (FC32 SP/DP)	3, 2	2
Emulex (FC16 SP/DP)	2, 3	2
Emulex (HBA FC64 LP 2P S28)	3, 2	2
Emulex (HBA FC32 FH 1P S28)	2, 3	2
Qlogic (HBA FC32 SP/DP)	3, 2	2
Qlogic (HBA FC16 SP/DP)	2, 3	2
Qlogic 10G (SFP DP)	2, 3	2
Qlogic 25G (BaseT DP)	2, 3	2
Qlogic (HBA FC32 FH 1P S28)	3, 2	2
Solarflare 25G (SFP DP)	2, 3	2
Intel 10G (BaseT DP)	2, 3	2
Intel 10G (SFP+ DP)	2, 3	2
Intel 1G (QP)	2, 3	2
Intel 25G SFP DP	2, 3	2
Broadcom 1G (QP)	2, 3	2
Broadcom 10G (BaseT DP)	2, 3	2
Broadcom 25G (SFP DP)	2, 3	2
PERC 10: External adapter (Dell)	2, 3	1
HBA: External adapter (Dell)	2, 3	1
Internal storage (BOSS)	2, 3	1
PERC 9: Mini mono (H730P/H330)	Integrated slot	1
PERC 10: Mini mono (H740P)	Integrated slot	1
PERC 11: Mini mono (H350)	Integrated slot	1
HBA :Mini mono (HBA330/HBA350i)	Integrated slot	1
PERC 10: External adapter (H840)	2, 3	2
PERC 10: External adapter (H840) (FH or LP)	2, 3	2
PERC 11: External adapter (HBA355E)	2, 3	2
HBA: External adapter	2, 3	2
Intel,NIC: 100Gb, CRD,NTWK,INTL,LP,100G,2P,Q28	3,2	2
Intel NIC: 25Gb,CRD,NTWK,INTL,FH,25G,2P,S28,F1	2, 3	2

Table 19. Riser configurations: Riser 1A + Riser 2 – CPU (continued)

Card type	Slot priority	Maximum number of cards
Emulex, HBA: FC32, CRD,CTL,FC32,2P,LPE35002,EMX,L	3,2	2
Broadcom, NIC: 10Gb, CRD,NTWK,BCME,LP,10G,4P,BT	3,2	2
HBA: External Adapter, KIT,CRD,CTL,HBA,12GBPS-SAS	3,2	2

Table 20. Riser configurations: Riser 1B – CPU

Card type	Slot priority	Maximum number of cards
LOM riser ; 2x1G BCM5720L	1	1
LOM riser ; 2x10G BCM57416 (BAsE/T/SFP+)	1	1
LOM riser ; 2x25G (Broadcom)	1	1
FPGA: XILINX FH	3	1
GPU: AMD MI210 64GB 300W (FH)	3	1
GPU: Nvidia A30 24GB V2 (FH)	3	1
GPU: Nvidia A2 16GB V2 (FH)	2, 3	2
GPU: Nvidia A2 16GB V2 (LP)	5	1
GPU: Nvidia A16 64GB V2 (FH)	3	1
GPU: Nvidia V100S 32GB (FH)	3	1
GPU: Nvidia T4 16GB 70W V2 (FH)	2, 3	2
GPU: Nvidia T4 16GB 70W (LP)	5, 4	2
Intel 10G (BaseT DP FH)	2, 3	2
Intel 10G (BaseT DP LP)	5, 4	2
Intel 10G (SFP+ DP FH)	2, 3	2
Intel 10G (SFP+ DP LP)	5, 4	2
Intel 1G (QP FH)	2, 3	2
Intel 1G (QP LP)	5, 4	2
Intel 25G (SFP DP FH)	2, 3	2
Intel 25G (SFP DP LP)	5, 4	2
Broadcom 1G (QP FH)	2, 3	2
Broadcom 1G (QP LP)	5, 4	2
Broadcom 10G (BaseT DP FH)	2, 3	2
Broadcom 10G (BaseT DP LP)	5, 4	2
Broadcom 25G (SFP DP FH)	2, 3	2
Broadcom 25G (SFP DP LP)	5, 4	2
Solarflare 25G (SFP DP FH)	2, 3	2
Solarflare 25G (SFP DP LP)	5, 4	2
Mellanox 25G (CX4LX DP/CX5 DP FH)	2, 3	2

Table 20. Riser configurations: Riser 1B – CPU (continued)

Card type	Slot priority	Maximum number of cards
Mellanox 25G (CX4LX DP/CX5 DP LP)	5, 4	2
Qlogic 10G (SFP DP FH)	2, 3	2
Qlogic 10G (SFP DP LP)	5, 4	2
Qlogic 25G (BaseT DP FH)	2, 3	2
Qlogic 25G (BaseT DP LP)	5, 4	2
Mellanox 100G (CX5/CX6 H100, FH)	3, 2	2
Mellanox 100G (CX5/CX6 H100, LP)	4, 5	2
Emulex (FC32 SP/DP, FH)	3, 2	2
Emulex (FC32 SP/DP, LP)	4, 5	2
Emulex (FC16 SP/DP, FH)	2, 3	2
Emulex (FC16 SP/DP, LP)	5, 4	2
Emulex (HBA FC64 FH 2P S28)	3, 2	2
Emulex (HBA FC64 LP 2P S28)	4, 5	2
Emulex (HBA FC32 1P S28, FH)	2, 3	2
Emulex (HBA FC32 1P S28, LP)	5, 4	2
Qlogic (HBA FC32 SP/DP, FH)	3, 2	2
Qlogic (HBA FC32 SP/DP, LP)	4, 5	2
Qlogic (HBA FC16 SP/DP, FH)	2, 3	2
Qlogic (HBA FC16 SP/DP, LP)	5, 4	2
Qlogic (HBA FC32 1P S28, FH)	3, 2	2
Qlogic (HBA FC32 1P S28, LP)	4, 5	2
PERC 10 : External adapter (H840, FH)	2, 3	2
PERC 11: External adapter (HBA355E)	2, 5, 3, 4	2
HBA : External adapter (FH)	2, 3	2
Internal storage (BOSS, FH)	2, 3	1
NVME PCIE SSD (FH)	2, 3	2
NVME PCIE SSD (LP)	5, 4	2
PERC 10 : External adapter (H840, LP)	5, 4	2
PERC 10: External adapter (H840) (FH or LP)	2, 5, 3, 4	4
HBA : External adapter (LP)	5, 4	2
Internal storage (BOSS, LP)	5, 4	1
PERC 9 : Mini mono (H730P/H330)	Integrated slot	1
PERC 10 : Mini mono (H740P)	Integrated slot	1
PERC 11: Mini mono (H350)	Integrated slot	1
HBA :Mini mono (HBA330/HBA350i)	Integrated slot	1
LOM riser (2x1G)/(2x10G)/(2x25G)	1	1

Table 20. Riser configurations: Riser 1B – CPU (continued)

Card type	Slot priority	Maximum number of cards
Intel, NIC: 100Gb, CRD,NTWK,INTL,FH,100G,2P,Q28	3,2	2
Intel, NIC: 100Gb, CRD,NTWK,INTL,LP,100G,2P,Q28	4,5	2
Intel, NIC: 25Gb, CRD,NTWK,INTL,FH,25G,4P,S28	3,2	2
Intel, NIC: 25Gb, CRD,NTWK,INTL,FH,25G,2P,S28	2, 3	2
Intel, NIC: 25Gb, CRD,NTWK,INTL,LP,25G,2P,S28	5, 4	2
NIC: 25Gb, Broadcom, CRD,NTWK,BCME,FH,25G,4P,S28	3,2	2
Emulex, HBA: FC32, CRD,CTL,FC32,2P,LPE35002,EMLX	3,2	2
Emulex, HBA: FC32, CRD,CTL,FC32,2P,LPE35002,EMX,L	4,5	2
Broadcom, NIC: 10Gb, CRD,NTWK,BCME,FH,10G,4P,BT	2,3	2
Broadcom, NIC: 10Gb, CRD,NTWK,BCME,LP,10G,4P,BT	5,4	2
HBA: External Adapter, KIT,CRD,CTL,HBA,12GBPS-SAS	2,5,3,4	4

Removing the expansion card riser

Prerequisites

1. Follow the safety guidelines listed in the [Safety instructions](#).
2. Follow the procedure listed in the [Before working inside your system](#).
3. [Remove the air shroud](#).
4. If installed, [remove the rear drive cage](#).
5. Disconnect any cables connected to the expansion card.
6. If installed, remove the PCIe filler bracket.

Steps

For riser 2, holding the blue touch points, lift the expansion card riser from the system.

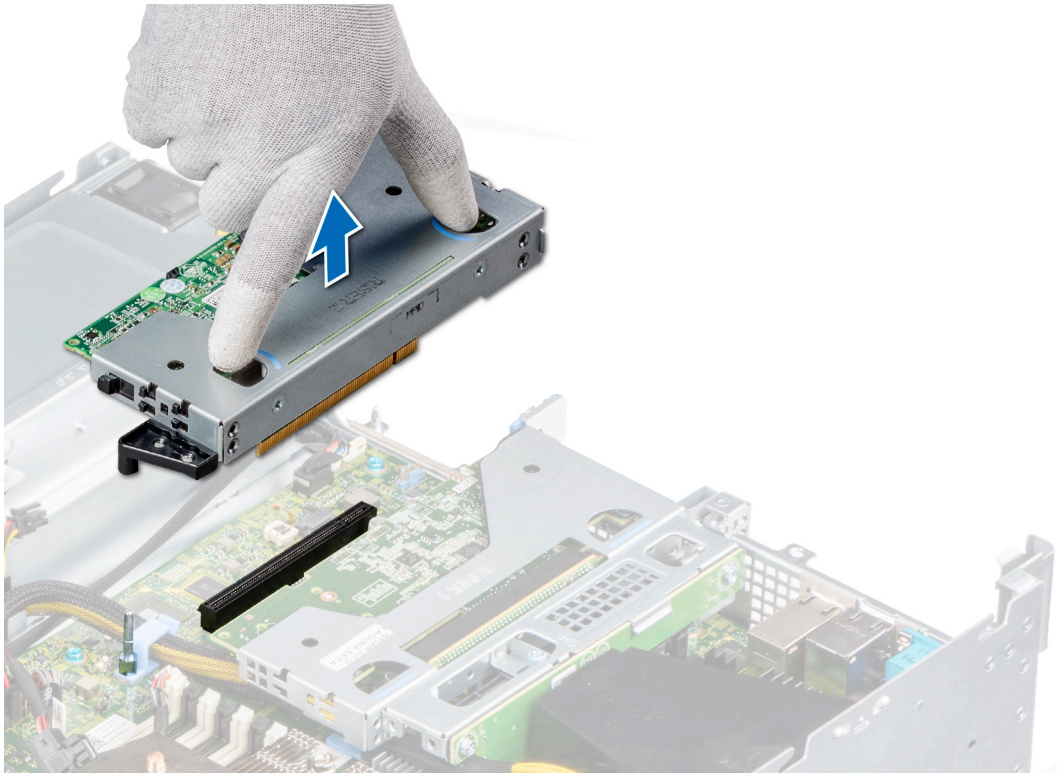

Figure 66. Removing the riser 2

- a. For the riser 1A, loosen the captive screw and then holding the blue touch points lift the riser from the system.



Figure 67. Removing the riser 1A

- b. For the riser 1B,
 - i. Using a Phillips #2 screwdriver, loosen the captive screws securing the riser to the system board and the chassis.

- ii. Holding the touch points, lift the riser from the system.

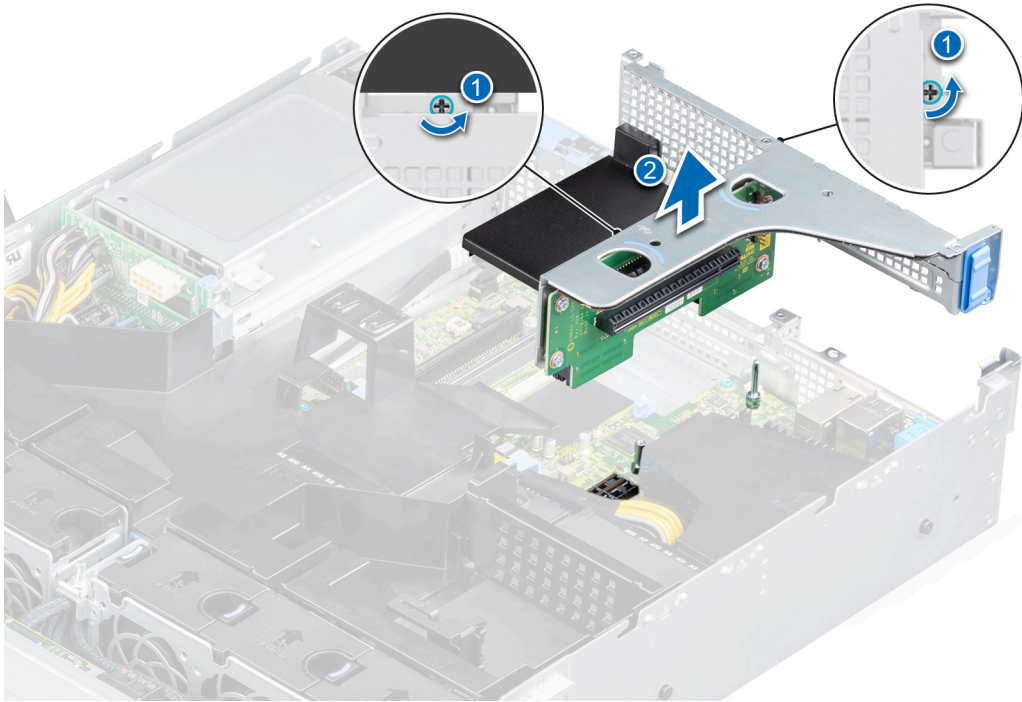

Figure 68. Removing the riser 1B

Next steps

1. [Replace the expansion card riser.](#)

Installing the expansion card riser

Prerequisites

1. Follow the safety guidelines listed in the [Safety instructions](#).
2. Follow the procedure listed in the [Before working inside your system](#).
3. [Remove the air shroud](#).
4. If installed, [remove the rear drive cage](#).
5. Disconnect any cables connected to the expansion card.
6. If installed, remove the PCIe filler bracket.
7. If applicable, [install the expansion card in the expansion card riser](#).

Steps

1. Align the guide on the expansion card riser with the guide pin on the chassis.
2. Lower the expansion card riser until the expansion card riser is firmly seated in the slot.

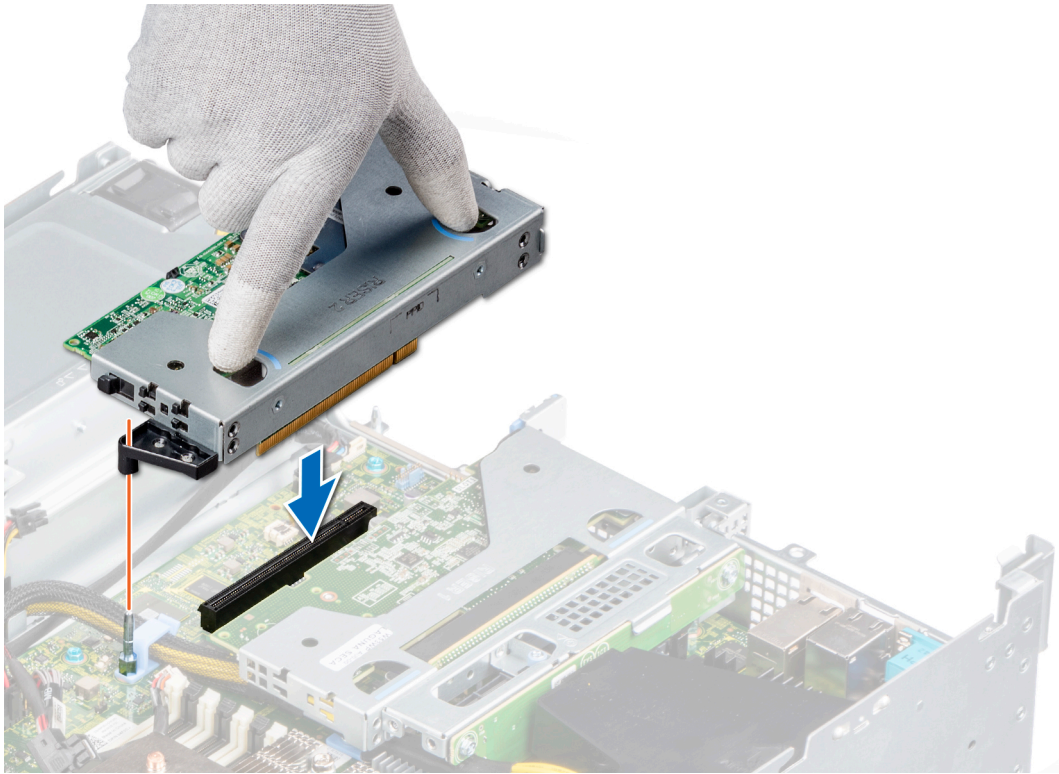

Figure 69. Installing the riser 2

- a. For the riser 1A, tighten the captive screw to secure the riser to the system board.

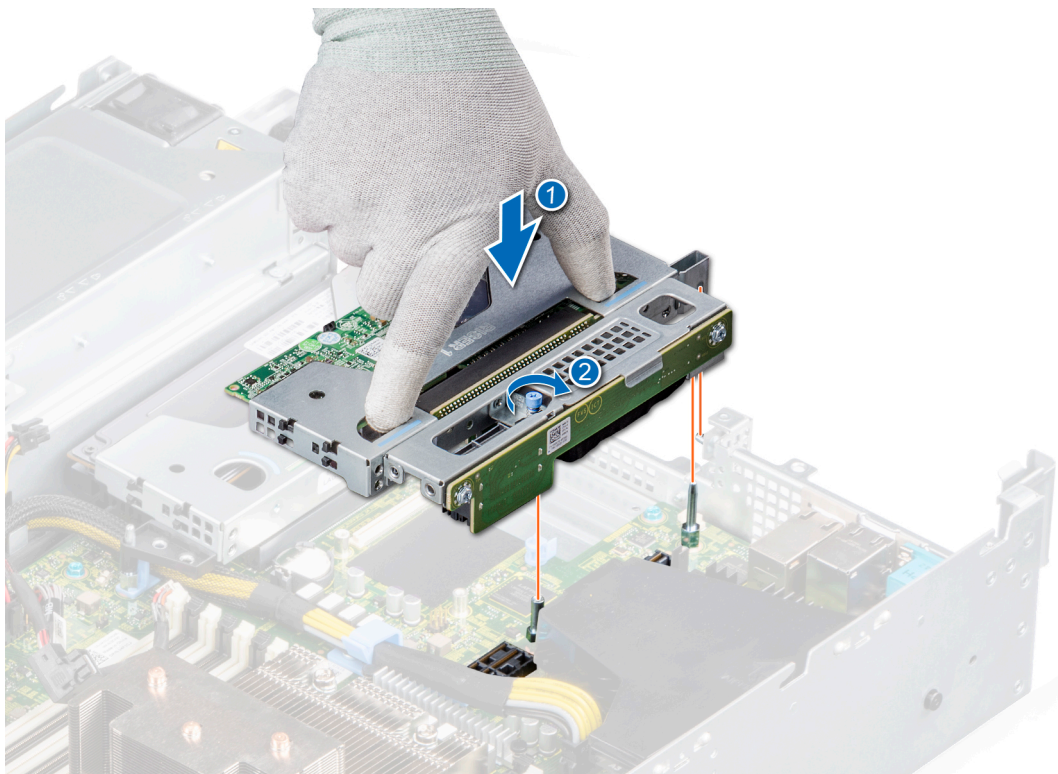

Figure 70. Installing the riser 1A

- b. For the riser 1B, tighten the captive screws of the riser to fit the riser firmly to the system board and the chassis.

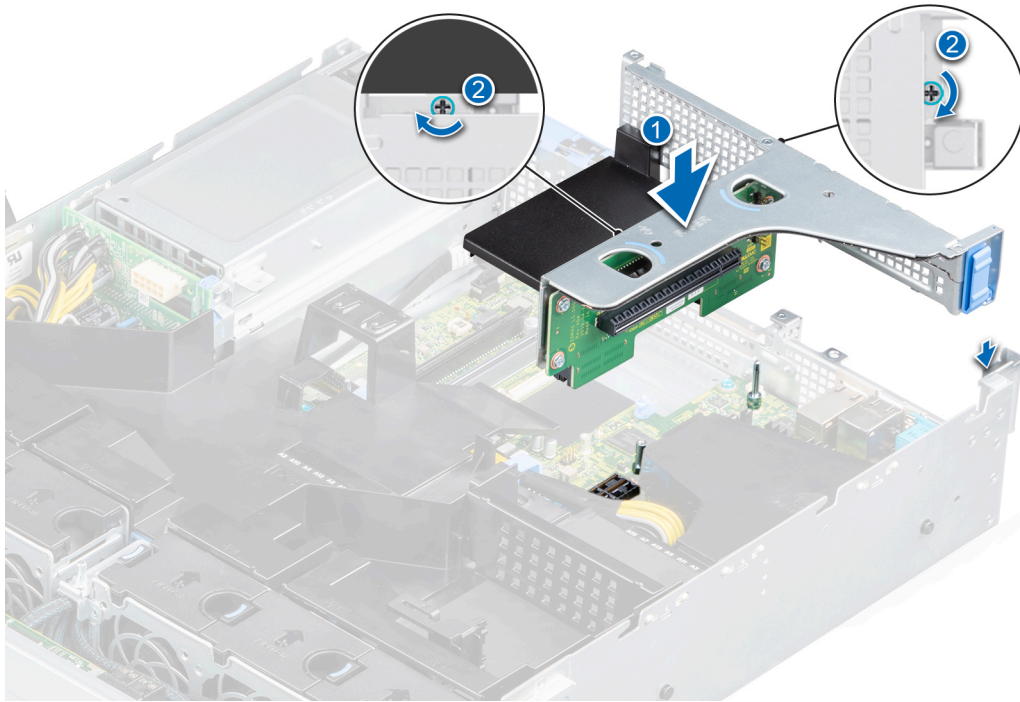

Figure 71. Installing the riser 1B

Next steps

1. [Install the rear drive cage.](#)
2. [Install the air shroud.](#)
3. Follow the procedure listed in [After working inside your system.](#)

Removing an expansion card

Prerequisites

1. Follow the safety guidelines listed in the [Safety instructions.](#)
2. Follow the procedure listed in the [Before working inside your system.](#)
3. [Remove the air shroud.](#)
4. Disconnect any cables connected to the expansion card.
5. If installed, [remove the rear drive cage.](#)

Steps

1. Pull and lift to open the expansion card retention latch lock.
2. Hold the expansion card by the edges and pull it to disconnect it from the connector on the system board..

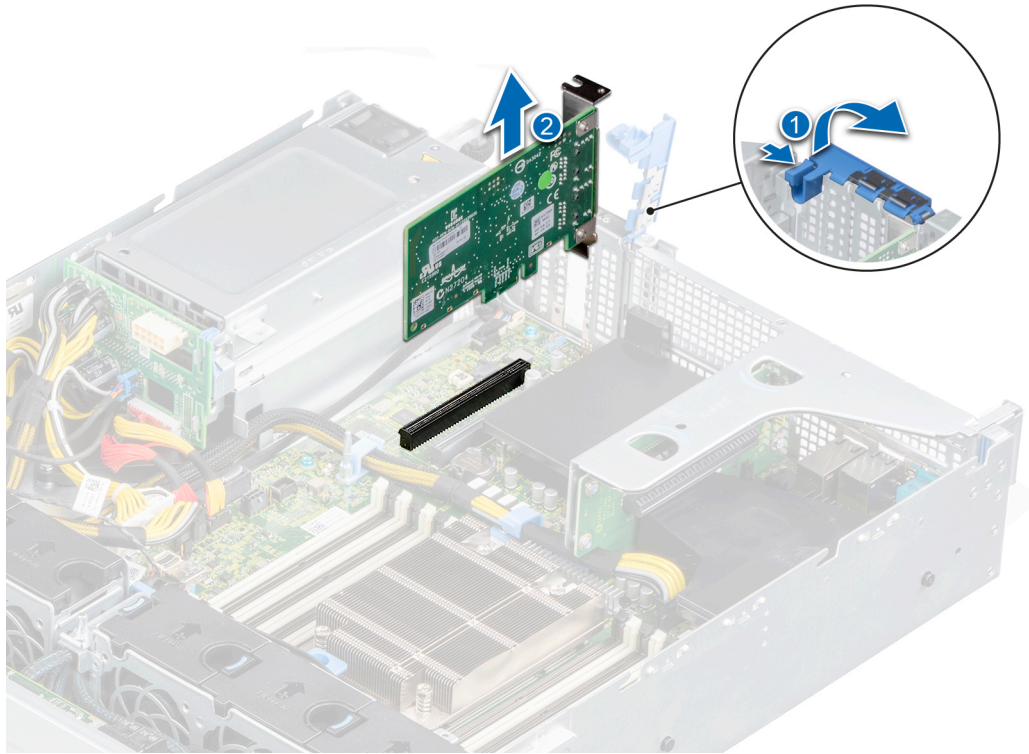

Figure 72. Removing an expansion card from the system board

3. If the expansion card is not going to be replaced, install a filler bracket by performing the following steps:
 - i** **NOTE:** If you are removing the card permanently, install a filler bracket in the empty expansion card slot.
 - a. Pull and lift to open the expansion card retention latch.
 - b. Install a filler bracket in the empty expansion card slot and close the retention latch.

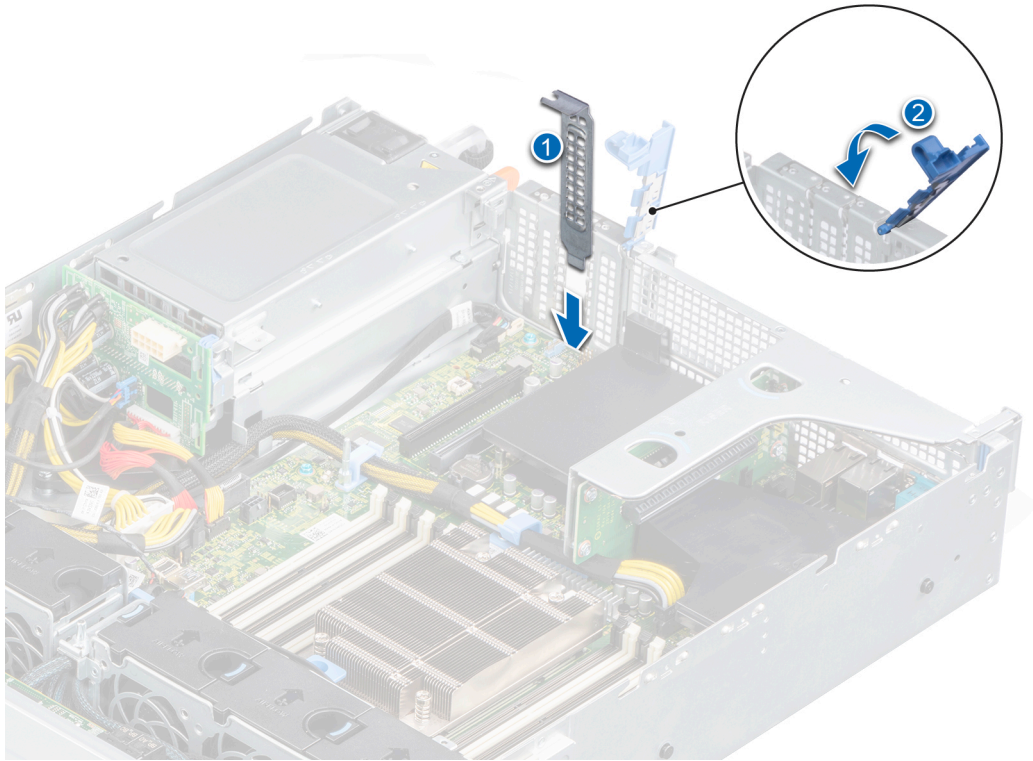

Figure 73. Installing the filler bracket

NOTE: Filler brackets must be installed over empty expansion card slots to maintain FCC certification of the system. The brackets also keep dust and dirt out of the system and aid in proper cooling and airflow inside the system.

Next steps

Install an expansion card.

Installing an expansion card

Prerequisites

1. Follow the safety guidelines listed in the [Safety instructions](#).
2. Follow the procedure listed in the [Before working inside your system](#).
3. [Remove the air shroud](#).
4. Disconnect any cables connected to the expansion card.
5. If installed, [remove the rear drive cage](#).

Steps

1. Unpack the expansion card and prepare it for installation.
For instructions, see the documentation accompanying the card.
2. If you are installing a new card, remove the filler bracket.
 - a. Pull and lift to open the expansion card retention latch.
 - b. Remove the filler bracket.

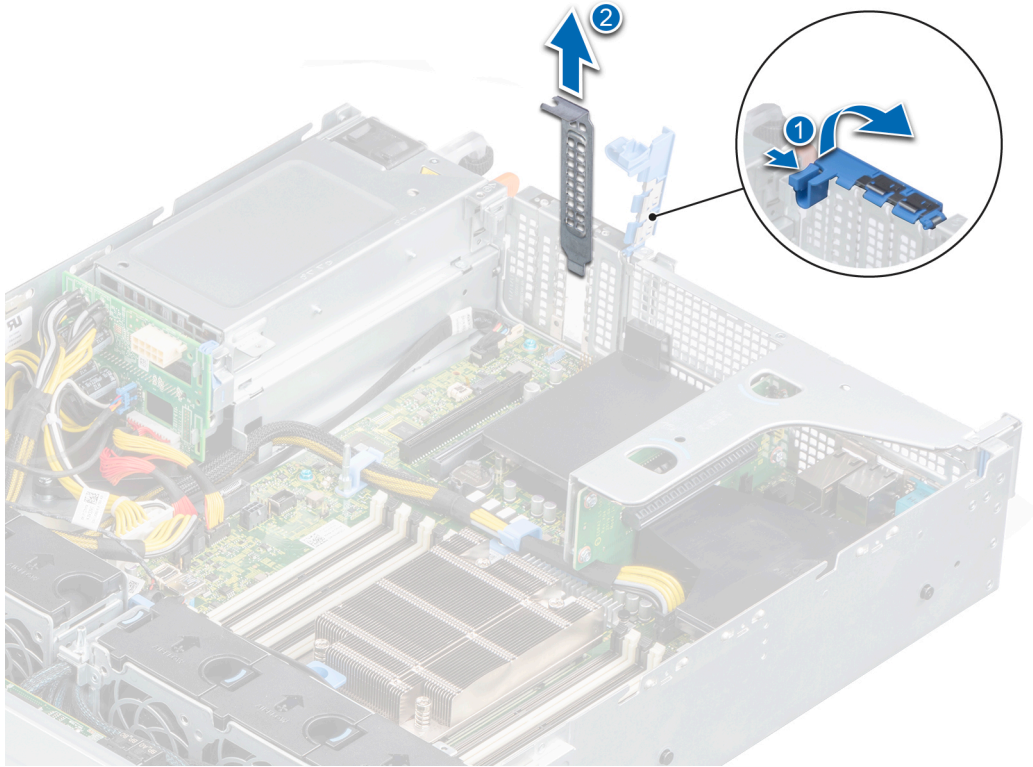

Figure 74. Removing the filler bracket

i NOTE: Store the filler bracket for future use. Filler brackets must be installed in empty expansion card slots to maintain FCC certification of the system. The brackets also keep dust and dirt out of the system and aid in proper cooling and airflow inside the system.

3. Holding the card on the edges, align the card with the expansion card connector on the system board.
4. Press the expansion card until it is firmly seated in the slot on the system board.
5. Close the expansion card retention latch.

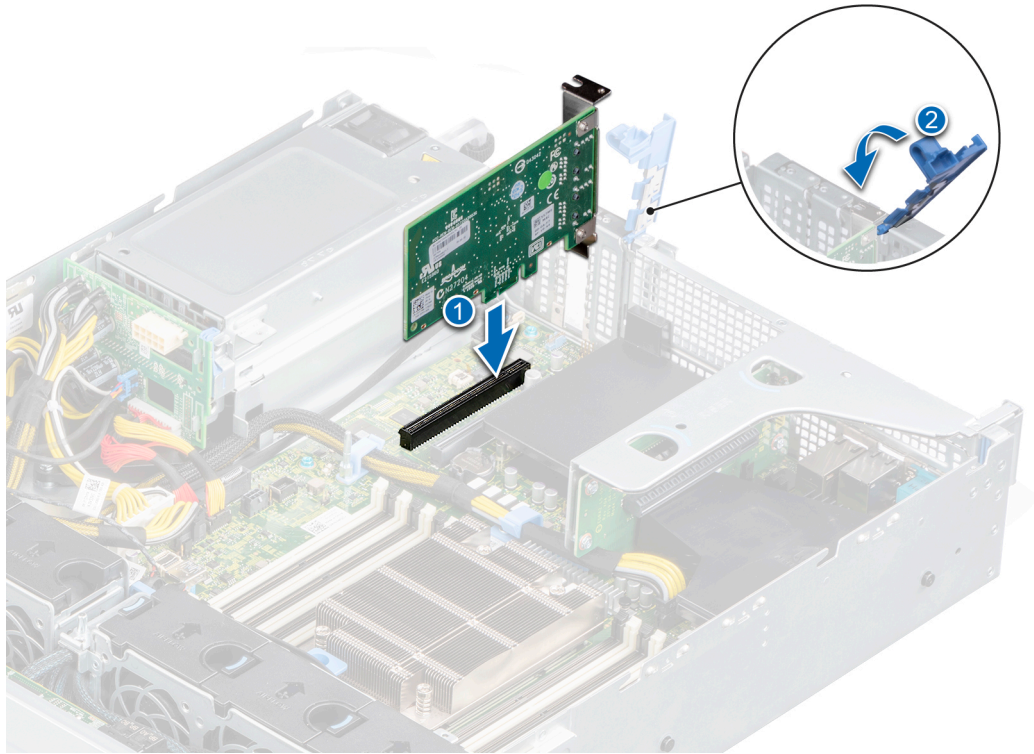

Figure 75. Installing an expansion card on the system board

Next steps

1. Connect the required cables to the expansion card.
2. If removed, [install the rear drive cage](#).
3. [Install the air shroud](#).
4. Follow the procedure listed in [After working inside your system](#).

Removing an expansion card from the expansion card riser

Prerequisites

1. Follow the safety guidelines listed in the [Safety instructions](#).
2. Follow the procedure listed in the [Before working inside your system](#).
3. Disconnect any cables that are connected to the expansion card or expansion card riser.
4. [Remove the air shroud](#).
5. [Remove the expansion card riser](#).

NOTE: The procedure to remove expansion card from riser 1A, riser 2, or riser 1B is identical.

Steps

1. Pull and lift to open the expansion card retention latch.
2. Hold the expansion card by its edges, and pull the card from the expansion card connector on the riser.

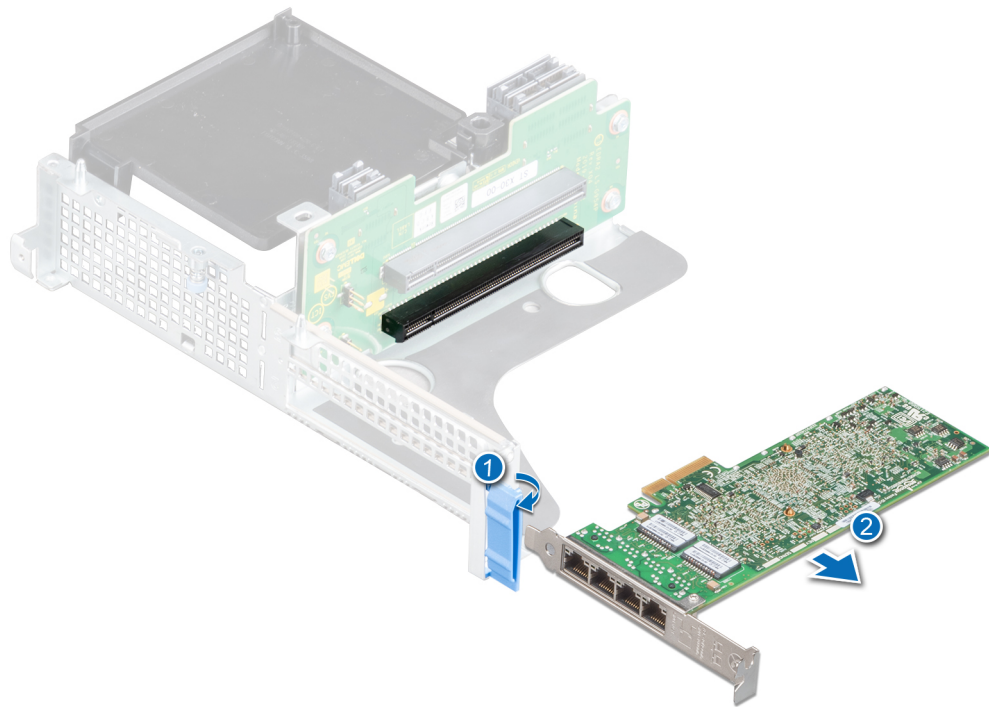

Figure 76. Removing the expansion card from riser 1B

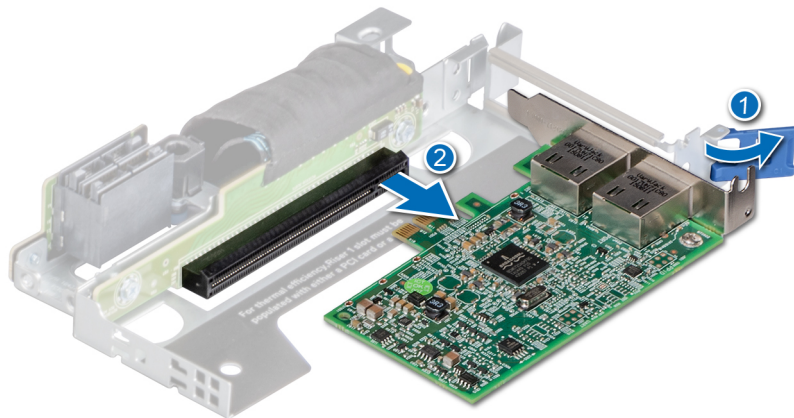

Figure 77. Removing the expansion card from riser 1A

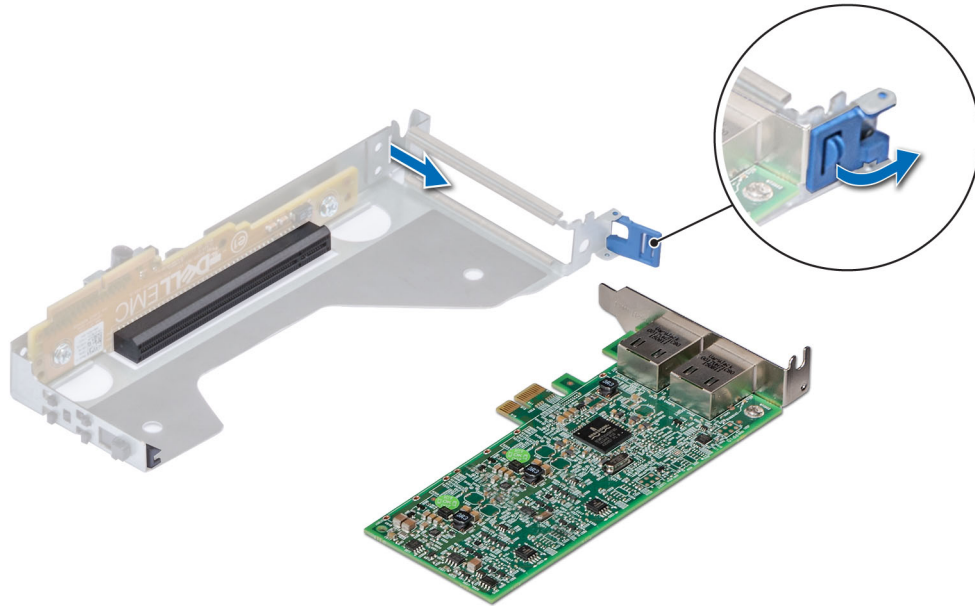

Figure 78. Removing the expansion card from riser 2

3. Install a filler bracket if you are not replacing the expansion card.

i **NOTE:** You must install a filler bracket over an empty expansion card slot to maintain Federal Communications Commission (FCC) certification of the system. The brackets also keep dust and dirt out of the system and aid in proper cooling and airflow inside the system.

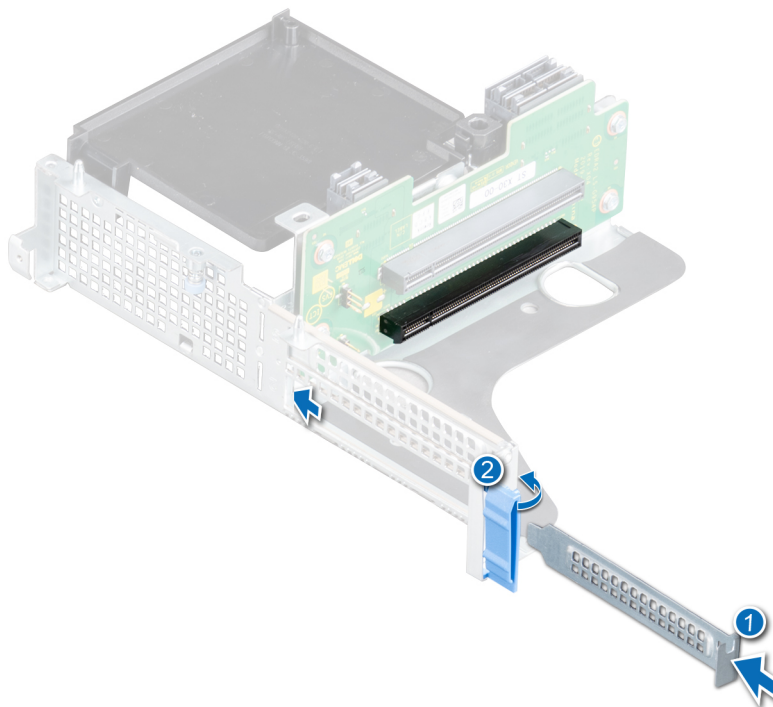

Figure 79. Installing a filler bracket for riser 1B

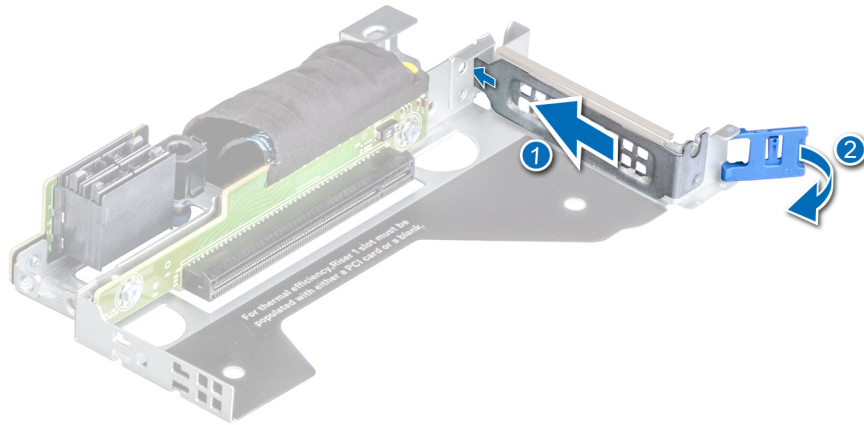

Figure 80. Installing a filler bracket for riser 1A

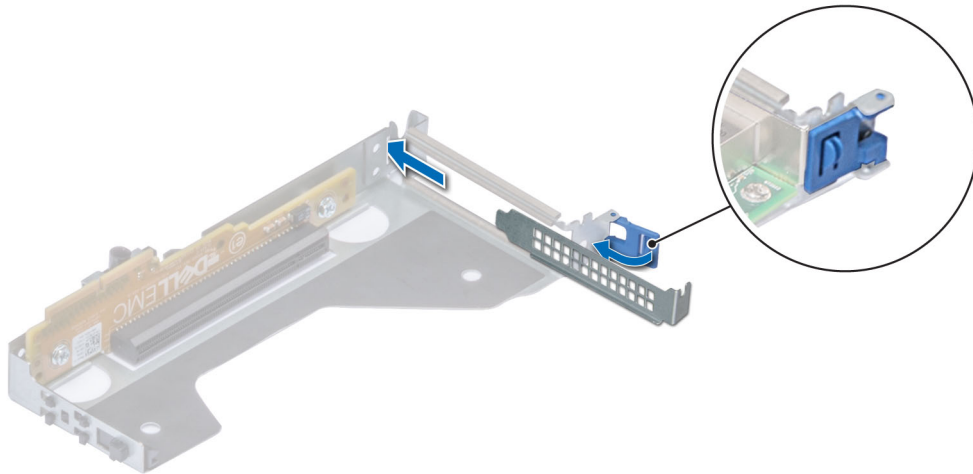

Figure 81. Installing a filler bracket for riser 2

Next steps

1. Install the expansion card into the expansion card riser.

Installing an expansion card into the expansion card riser

Prerequisites

1. Follow the safety guidelines listed in the [Safety instructions](#).
2. Follow the procedure listed in the [Before working inside your system](#).
3. If installing a new expansion card, unpack it and prepare the card for installation.

NOTE: For instructions, see the documentation accompanying the card.

4. [Remove the expansion card riser](#).
5. If installed, remove the filler bracket.

NOTE: The procedure to install expansion card into the riser 1A, riser 2, or riser 1B is identical.

Steps

1. Pull and lift to open the expansion card retention latch lock.
2. If installed, remove the filler bracket.

NOTE: Store the filler bracket for future use. Filler brackets must be installed in empty expansion card slots to maintain Federal Communications Commission (FCC) certification of the system. The brackets also keep dust and dirt out of the system and aid in proper cooling and airflow inside the system.

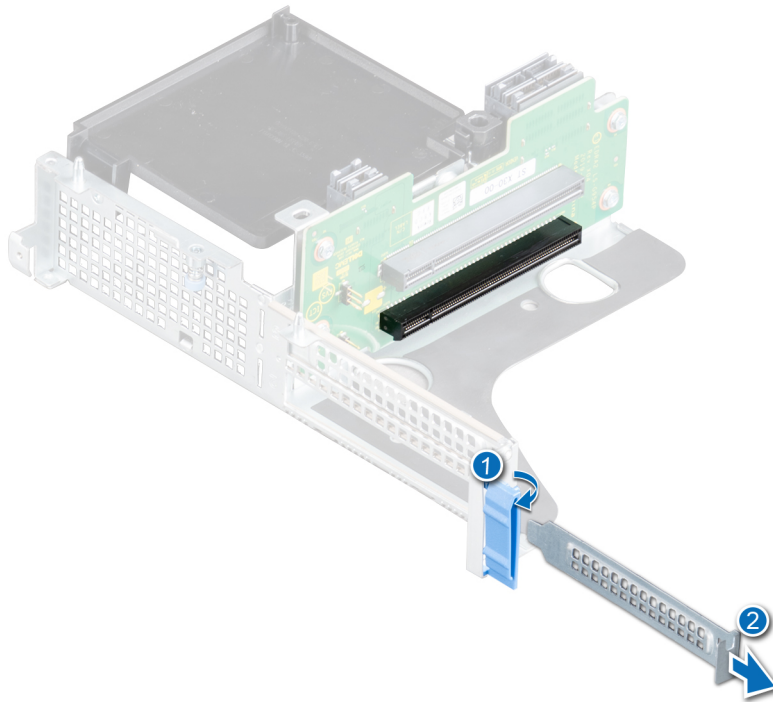

Figure 82. Removing a filler bracket for a riser 1B

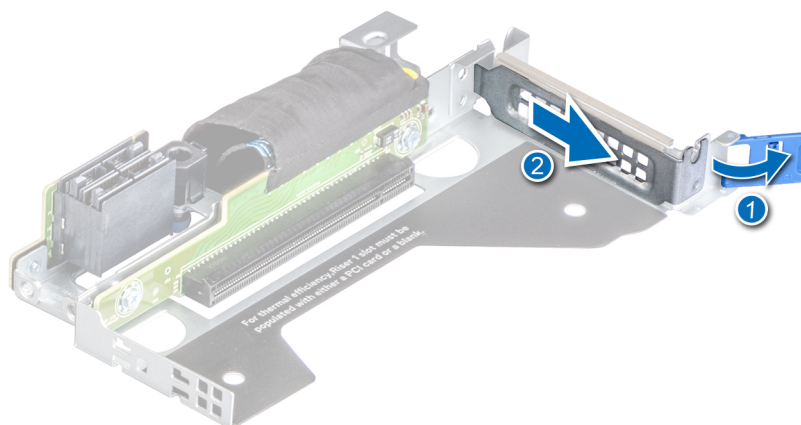

Figure 83. Removing a filler bracket for a riser 1A

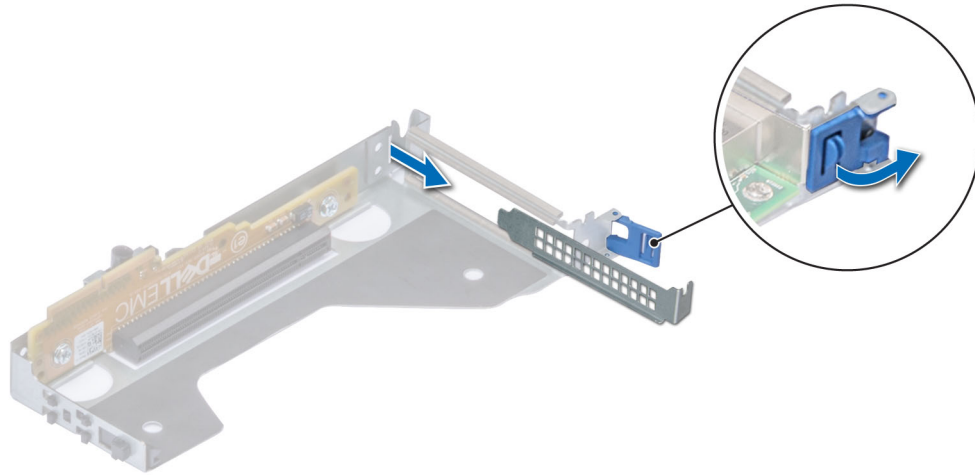

Figure 84. Removing a filler bracket for a riser 2

3. Holding the card by its edges, align the card and insert the expansion card in the connector on the expansion card riser.
4. Close the expansion card retention latch.

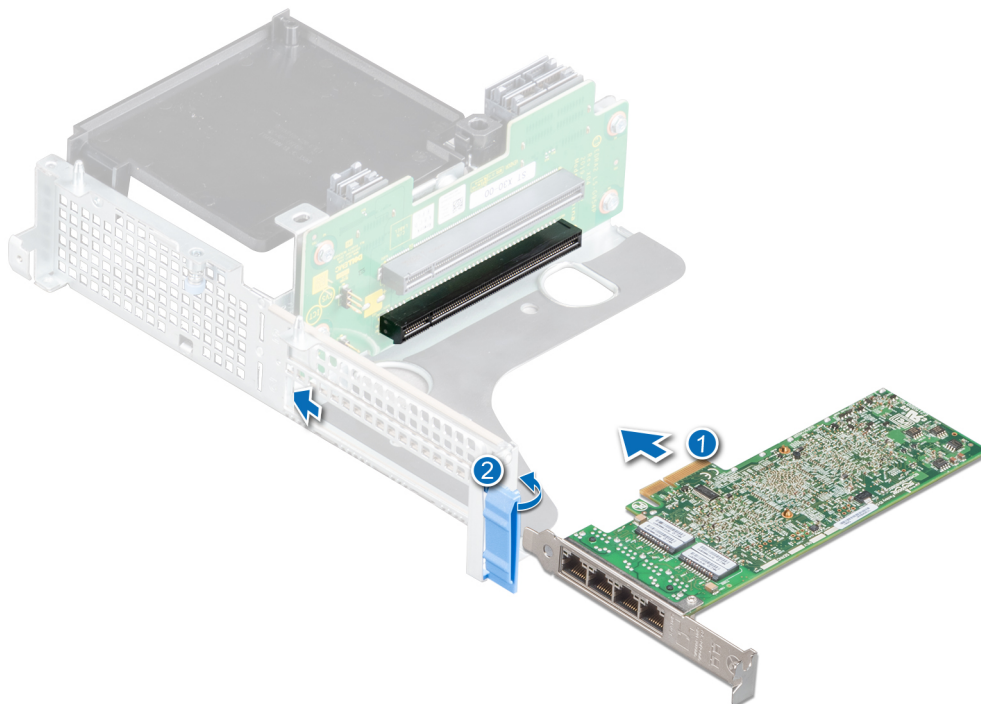

Figure 85. Installing the expansion card into a riser 1B

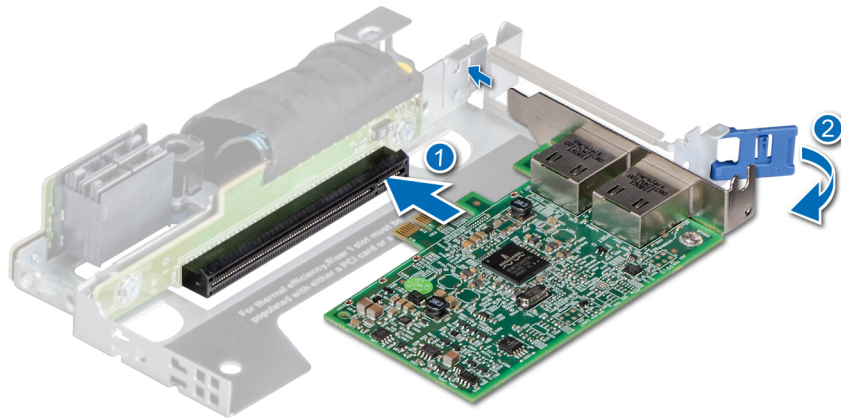

Figure 86. Installing the expansion card into a riser 1A

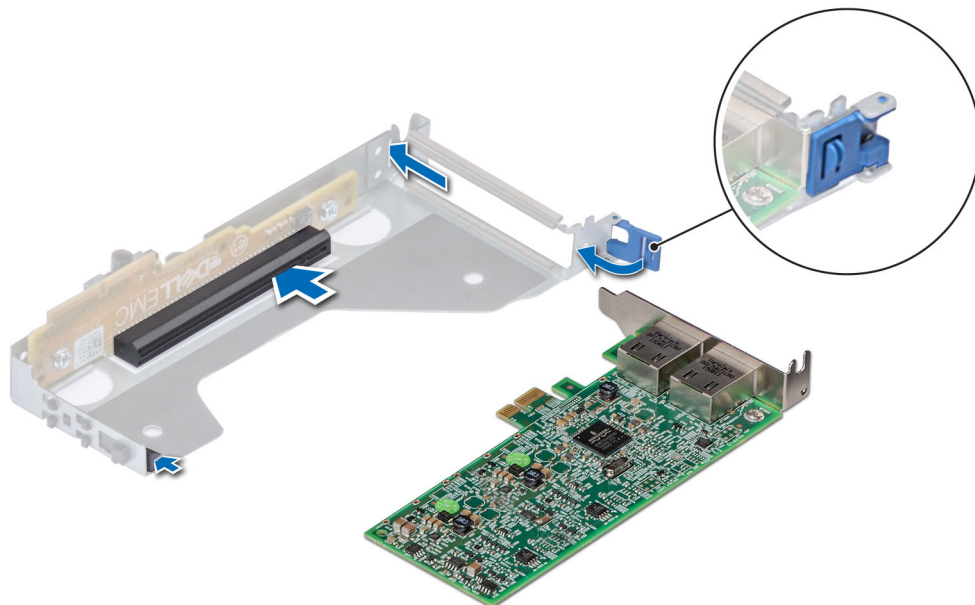

Figure 87. Installing the expansion card into a riser 2

Next steps

1. [Install the expansion card riser.](#)
2. [Install the air shroud.](#)
3. Follow the procedure listed in [After working inside your system.](#)

Removing an accelerator card

Prerequisites

1. Follow the safety guidelines listed in the [Safety instructions.](#)
2. Follow the procedure listed in the [Before working inside your system.](#)
3. Disconnect any cables that are connected to the expansion card or expansion card riser.
4. [Remove the air shroud.](#)

NOTE: The procedure to remove expansion card from riser 1A, riser 2, or riser 1B is identical.

Steps

1. Disconnect the FPGA cable from the Power Interposer Board (PIB) and expansion card riser.

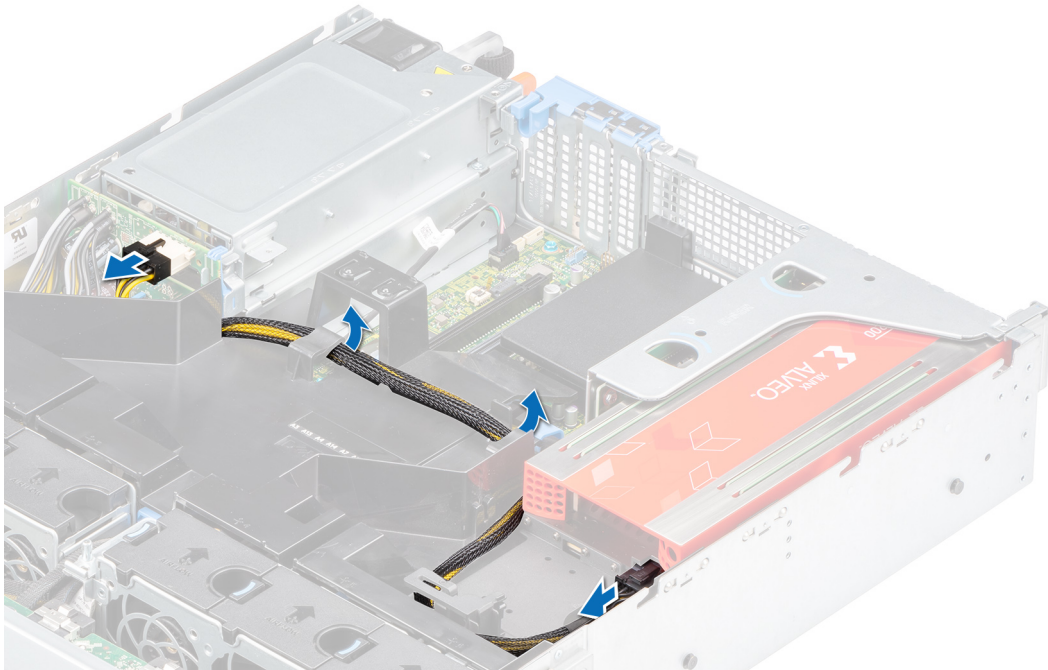

Figure 88. Disconnecting the FPGA cable from the PIB and the expansion card riser

2. Ensure to release the latch to remove the expansion card riser.

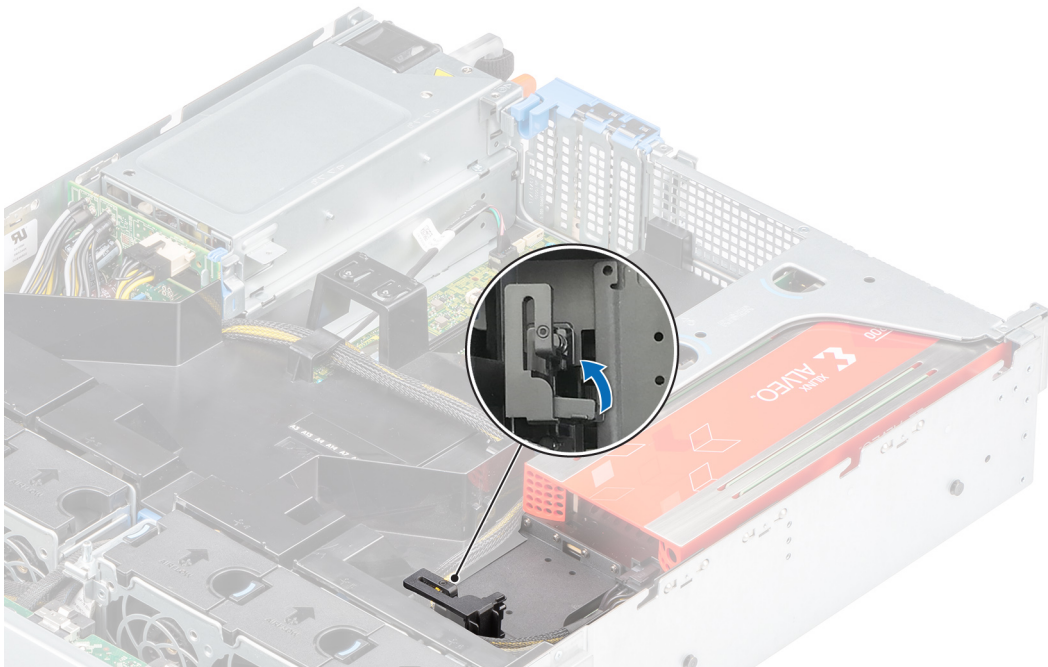

Figure 89. Opening the latch on the expansion card riser

3. Hold the accelerator card by the edges and pull to disconnect from the expansion card connector on the expansion card riser.

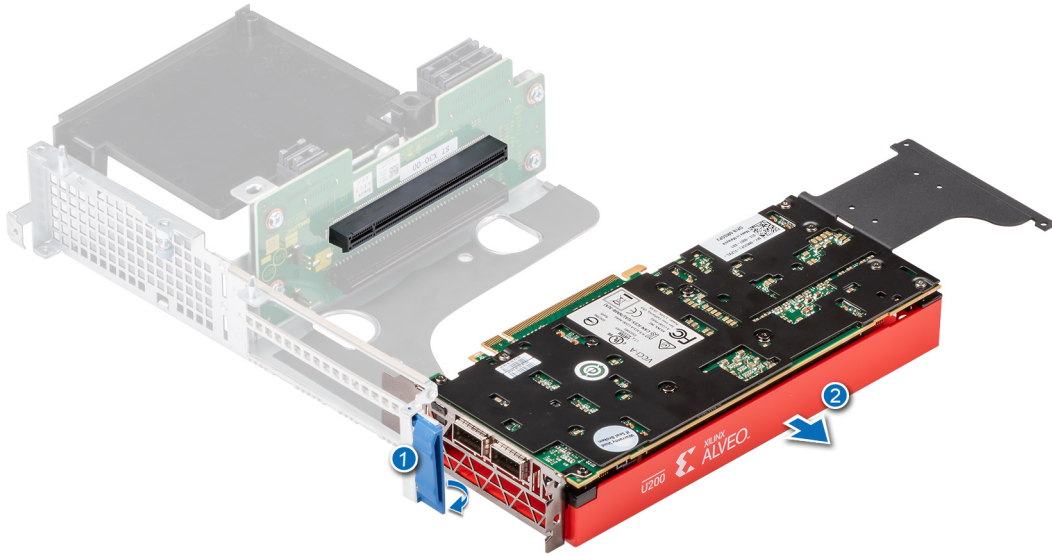

Figure 90. Removing the accelerator card from riser 1B

4. Install a filler bracket if you are not replacing the expansion card. For information about how to install a filler bracket, see installing a filler bracket section in the [Removing the expansion card](#) topic.

Next steps

1. [Install an accelerator card.](#)

Installing an accelerator card

Prerequisites

1. Follow the safety guidelines listed in the [Safety instructions](#).
2. Follow the procedure listed in the [Before working inside your system](#).
3. If installing a new expansion card, unpack it and prepare the card for installation.
i **NOTE:** For instructions, see the documentation accompanying the card.
4. [Install the air shroud.](#)

Steps

1. Pull and lift to open the expansion card retention latch lock.
2. If installed, remove the filler bracket. For information about how to remove filler bracket, see the removing a filler bracket section in the [Installing an expansion card](#) topic.
3. Hold the card by the edges, align with the connector on the expansion card riser and press until the card is seated in place.

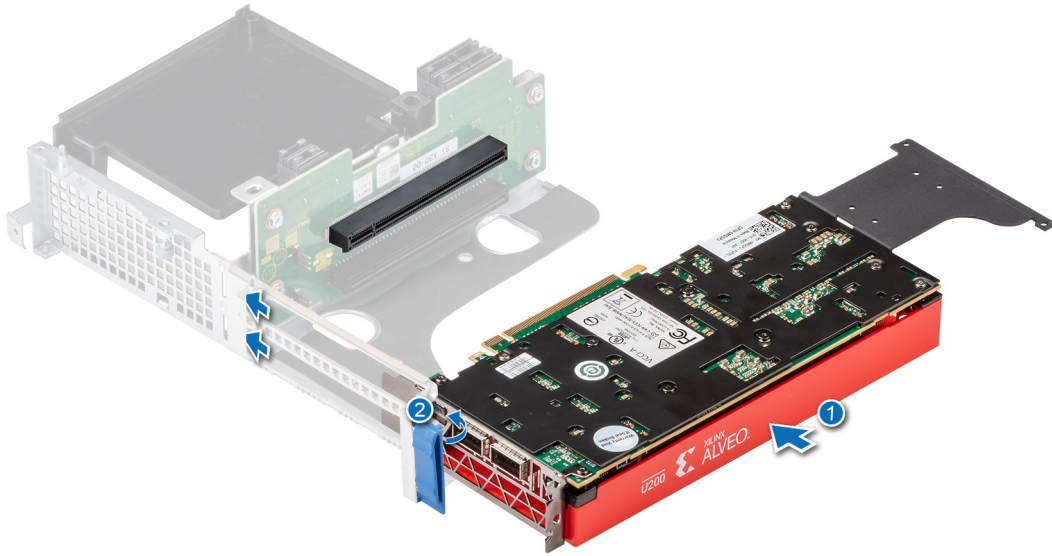

Figure 91. Installing the accelerator card into riser 1B

4. Ensure to close the latch for the accelerator card.

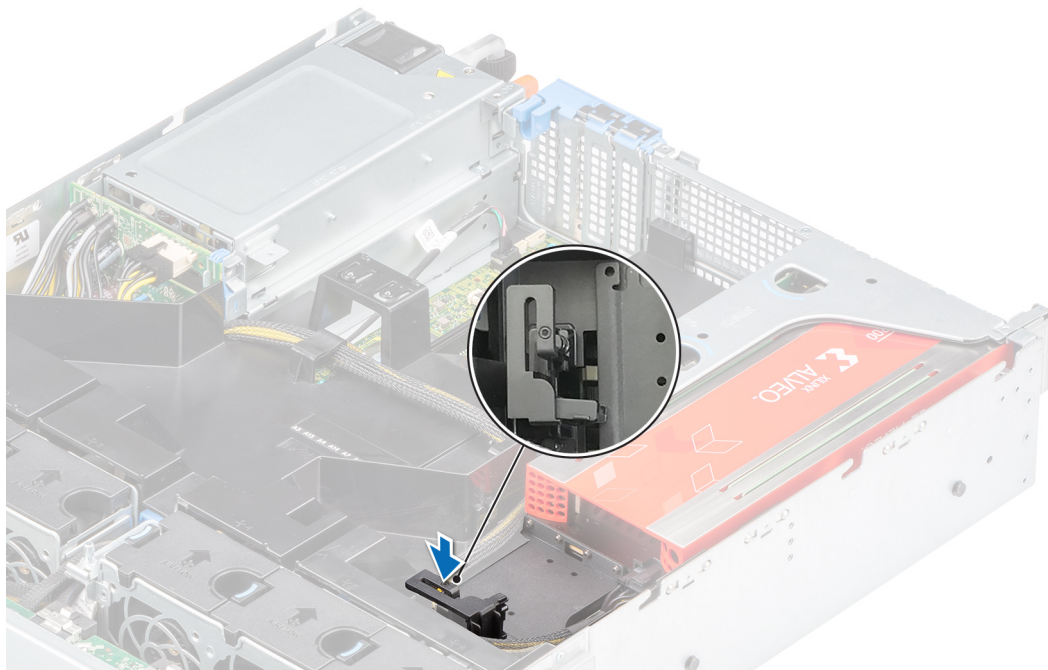

Figure 92. Closing the latch on the expansion card riser

5. Connect the FPGA cable to the PIB and the expansion card riser.

NOTE: The A16 GPU and the V100S GPU power cables are different from the FPGA cable. For A16 or V100S GPU card, use the cable with part number 23V9W in order to avoid power failure.

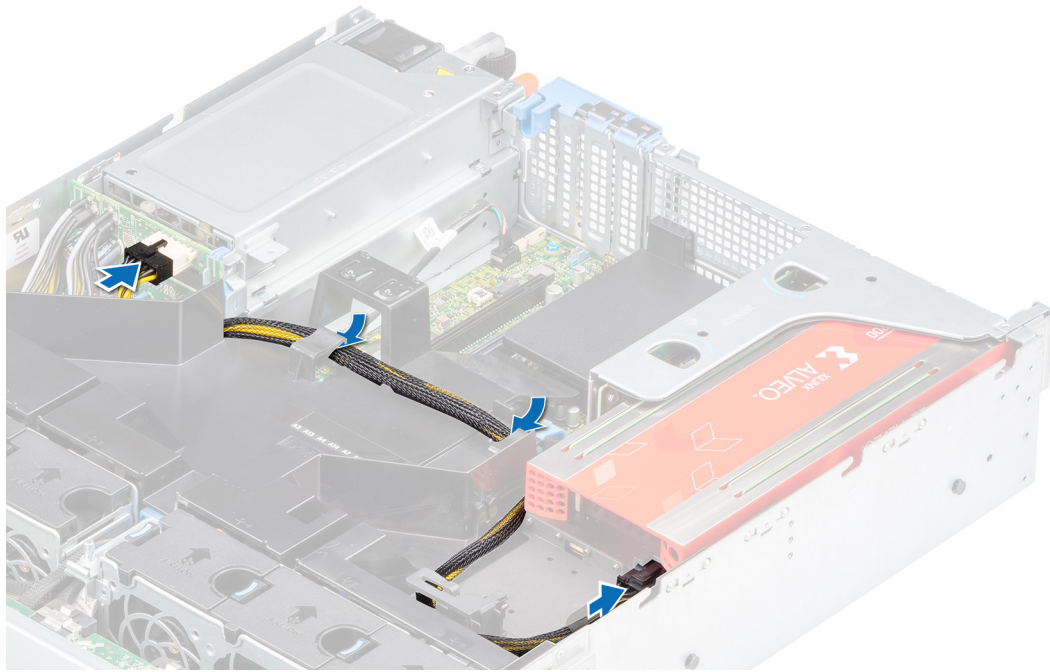

Figure 93. Connecting the FPGA cable for the accelerator card

Next steps

1. [Install the air shroud.](#)
2. Follow the procedure listed in [After working inside your system.](#)

M.2 SSD module on BOSS-S1 adapter card

Removing the M.2 SSD module

Prerequisites

1. Follow the safety guidelines listed in the [Safety instructions.](#)
2. Follow the procedure listed in the [Before working inside your system.](#)
3. [Remove the air shroud.](#)
4. [Remove the BOSS card](#) from the riser.

NOTE: The procedure to remove the BOSS card is similar to removing an expansion card.

Steps

1. Using the Phillips #1 screwdriver, remove the screws that secure the M.2 SSD module to the BOSS card.
2. Pull the M.2 SSD module to remove it from the BOSS card.

NOTE: The numbers on the image does not depict the exact steps. The numbers are just for representation of sequence.

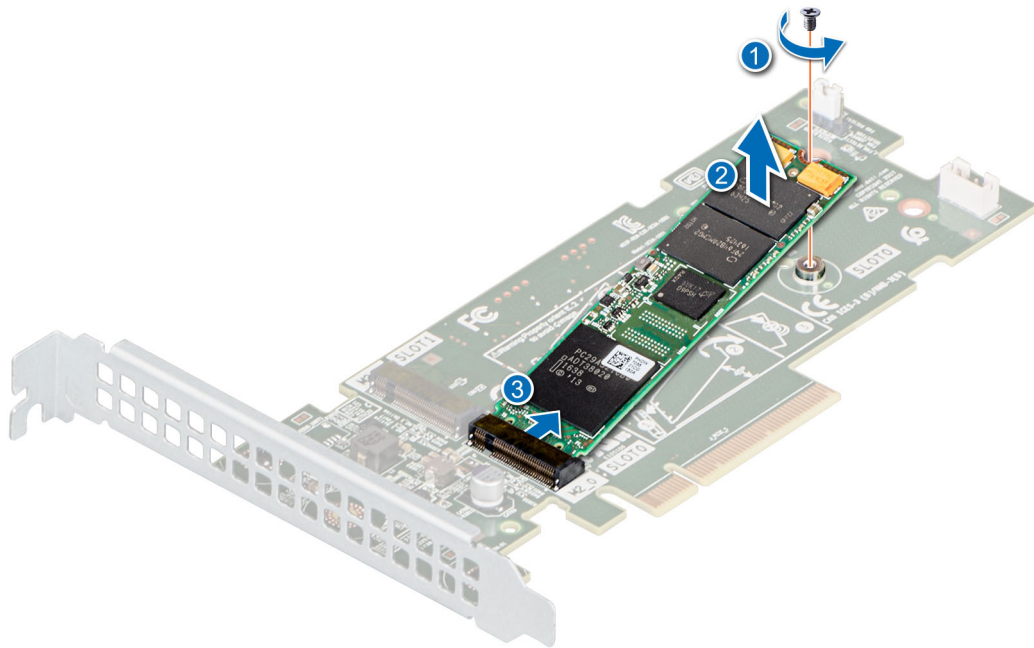

Figure 94. Removing the M.2 SSD module

Next steps

Replace the M.2 SSD module.

Installing the M.2 SSD module

Prerequisites

1. Follow the safety guidelines listed in the [Safety instructions](#).
2. Follow the procedure listed in the [Before working inside your system](#).
3. [Remove the air shroud](#).
4. [Remove the BOSS card](#) from the riser.

NOTE: The procedure to remove the BOSS card is similar to removing an expansion card.

Steps

1. Align the M.2 SSD module at an angle with the BOSS card connector.
2. Insert the M.2 SSD module until it is firmly seated in the BOSS card connector.
3. Using the Phillips #1 screwdriver, secure the M.2 SSD module on the BOSS card.

NOTE: The numbers on the image does not depict the exact steps. The numbers are just for representation of sequence.

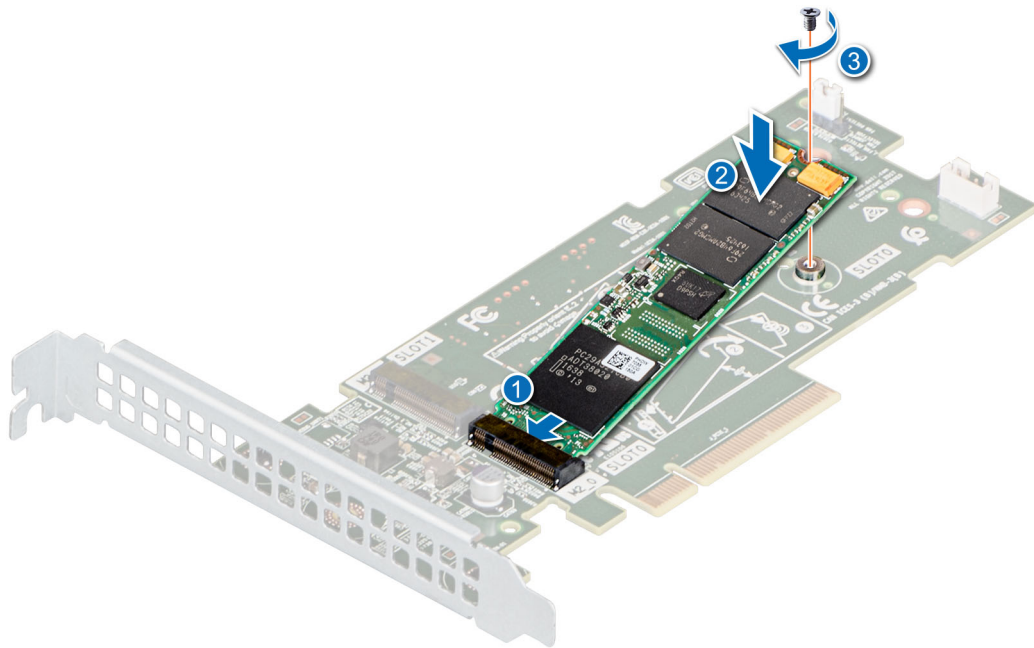

Figure 95. Installing the M.2 SSD module

Next steps

1. Install the BOSS card into the riser.
i **NOTE:** The procedure to install the BOSS card is similar to removing an expansion card.
2. Install expansion card riser
3. Install the air shroud.
4. Follow the procedure listed in [After working inside your system](#).

Optional IDSDM module

Removing the IDSDM card

Prerequisites

1. Follow the safety guidelines listed in the [Safety instructions](#).
2. Follow the procedure listed in the [Before working inside your system](#).
3. [Remove the air shroud](#).
4. If you are replacing the IDSDM card, [remove the MicroSD cards](#).
i **NOTE:** Temporarily label each SD card with its corresponding slot number before removal. Reinstall the SD cards into the corresponding slots.

Steps

Holding the pull tab, lift the IDSDM card out of the system.

- i** **NOTE:** There are two dip switches on the IDSDM card for write-protection.

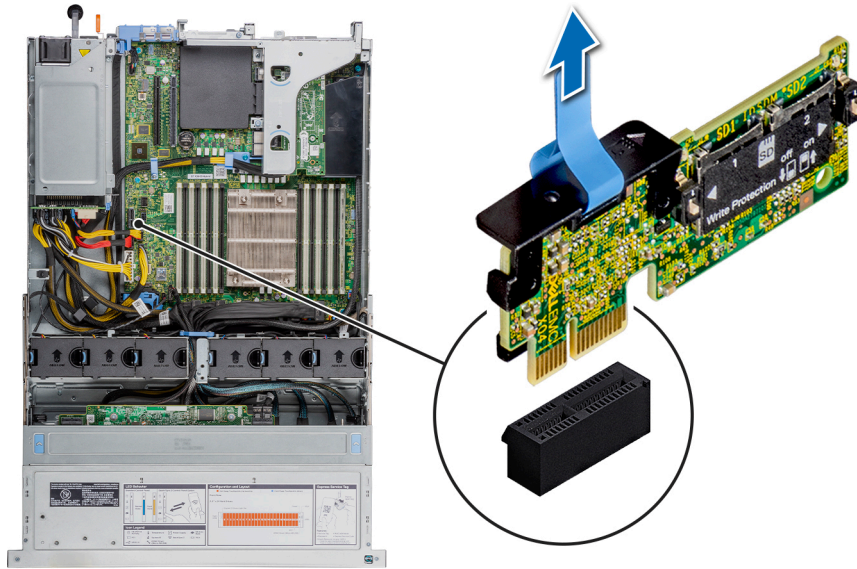

Figure 96. Removing the IDSDM card

Next steps

i **NOTE:** If you are replacing the IDSDM module, remove the MicroSD cards.

1. [Replace the IDSDM module.](#)

Installing IDSDM card

Prerequisites

1. Follow the safety guidelines listed in the [Safety instructions](#).
2. Follow the procedure listed in the [Before working inside your system](#).
3. [Remove the air shroud](#).
4. If you are replacing the IDSDM card, [remove the MicroSD cards](#).

i **NOTE:** Temporarily label each SD card with its corresponding slot number before removal. Reinstall the SD cards into the corresponding slots.

Steps

1. Locate the IDSDM connector on the system board. To locate IDSDM connector, see [System board jumpers and connectors](#) section.
2. Align the IDSDM card with the connector on the system board.
3. Push the IDSDM card until it is firmly seated on the system board.

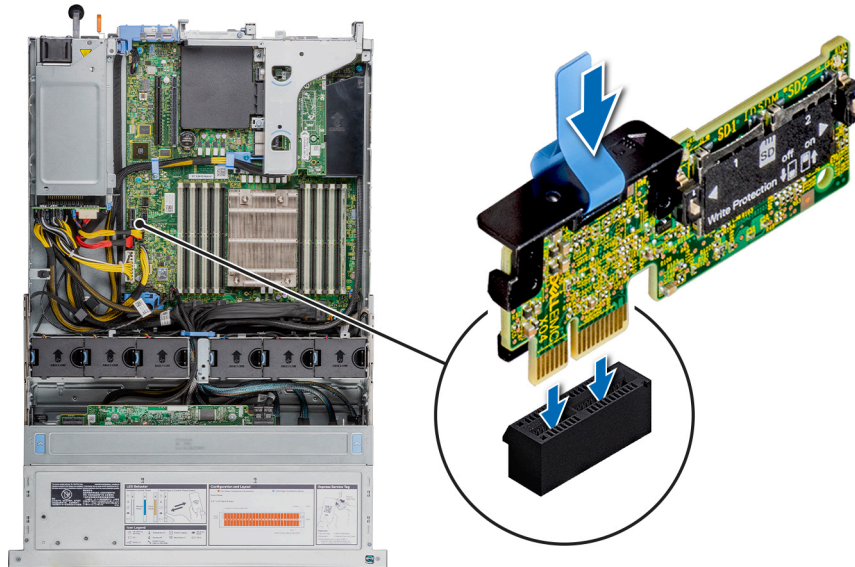

Figure 97. Installing IDSDM card

Next steps

1. [Install the MicroSD cards.](#)
i **NOTE:** Reinstall the MicroSD cards into the same slots that are based on the labels you had marked on the cards during removal.
2. [Install the air shroud.](#)
3. Follow the procedure listed in [After working inside your system.](#)

Micro SD card

Removing the MicroSD card

Prerequisites

1. Follow the safety guidelines listed in the [Safety instructions.](#)
2. Follow the procedure listed in the [Before working inside your system.](#)
3. [Remove the air shroud.](#)
4. [Remove the IDSDM module.](#)

Steps

1. Locate the MicroSD card slot on the IDSDM module, and press the card to partially release it from the slot. To locate IDSDM module, see the [System board jumpers and connectors](#) section.
2. Hold the MicroSD card and remove it from the slot.

i **NOTE:** Temporarily label each MicroSD card with its corresponding slot number after removal.

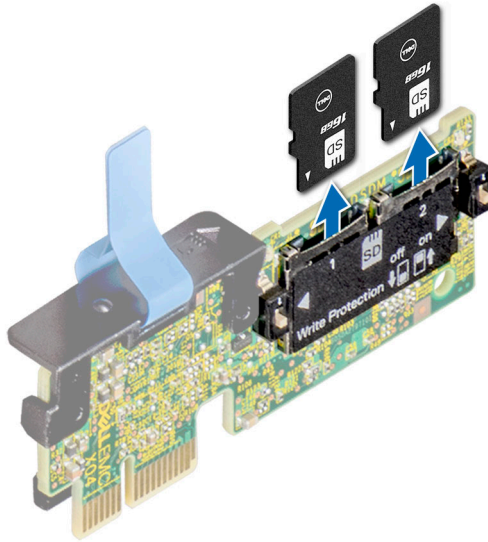

Figure 98. Removing the MicroSD card

Next steps

1. [Replace the MicroSD cards.](#)

Installing the MicroSD card

Prerequisites

1. Follow the safety guidelines listed in the [Safety instructions](#).
2. Follow the procedure listed in the [Before working inside your system](#).
3. [Remove the air shroud.](#)
4. [Remove the IDSDM module.](#)

NOTE: To use a MicroSD card with your system, ensure that the **Internal SD Card Port** is enabled in System Setup.

NOTE: If reinstalling, ensure that you install the MicroSD cards into the same slots based on the labels you had marked on the cards during removal.

Steps

1. Locate the MicroSD card connector on the IDSDM module. Orient the MicroSD card appropriately and insert the contact-pin end of the card into the slot. To locate IDSDM/vFlash, see the [System board jumpers and connectors](#) section.

NOTE: The slot is keyed to ensure correct insertion of the card.

2. Press the card into the card slot to lock it into place.

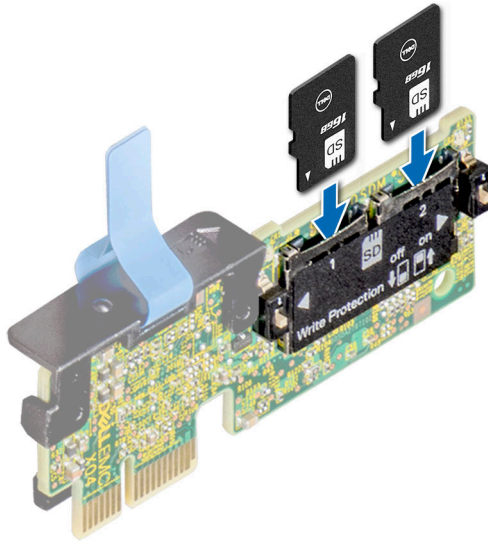

Figure 99. Installing the MicroSD card

Next steps

1. [Install the IDSDM module.](#)
2. Follow the procedure listed in [After working inside your system.](#)

LOM riser card

Removing the LOM riser card

Prerequisites

1. Follow the safety guidelines listed in the [Safety instructions.](#)
2. Follow the procedure listed in the [Before working inside your system.](#)
3. [Remove the air shroud.](#)
4. If applicable, [remove the rear drive cage.](#)
5. [Remove the expansion card riser.](#)

Steps

1. Using a Phillips #2 screwdriver, remove the screws that secure the LOM riser card to the system board.
2. Push the retention clips to release the LOM riser card.
3. Hold the LOM riser card by the edges and lift to disconnect the card from the connector on the system board.
4. Slide the LOM riser card towards the front of the system to disengage the ports from the slot.

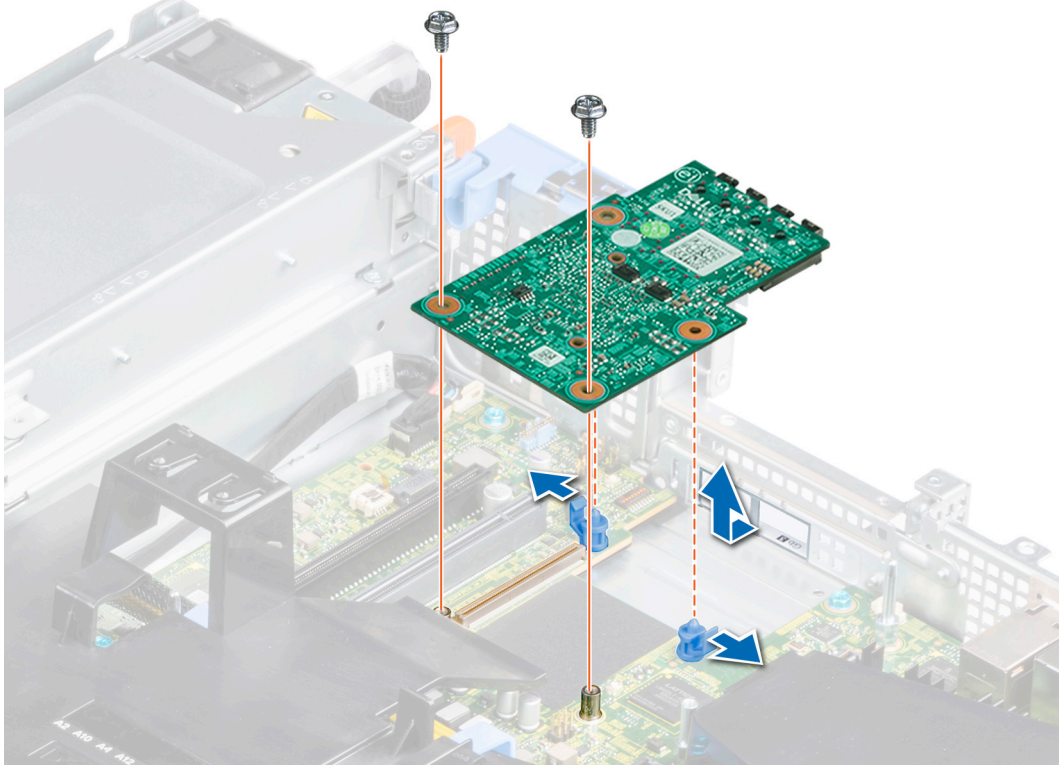

Figure 100. Removing the LOM riser card

5. Lift the LOM riser card out of the system.
6. Remove the LOM riser bracket.
 - a. Using a Phillips #2 screwdriver, remove the screw that secures the bracket to the chassis.
 - b. Slide the bracket out of the slot on the chassis.

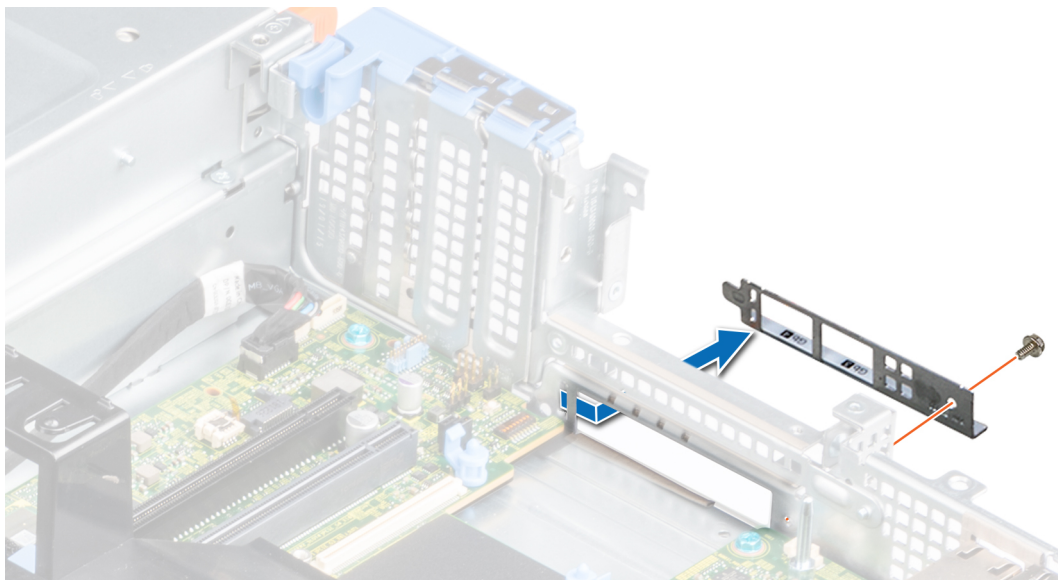

Figure 101. Removing the LOM riser bracket

7. If the LOM riser card is not being replaced immediately, install the LOM filler bracket.
 - a. Insert and slide the LOM filler bracket into the slot on the chassis.

- b. Using a Phillips #2 screwdriver, secure the LOM filler bracket to the chassis with a screw

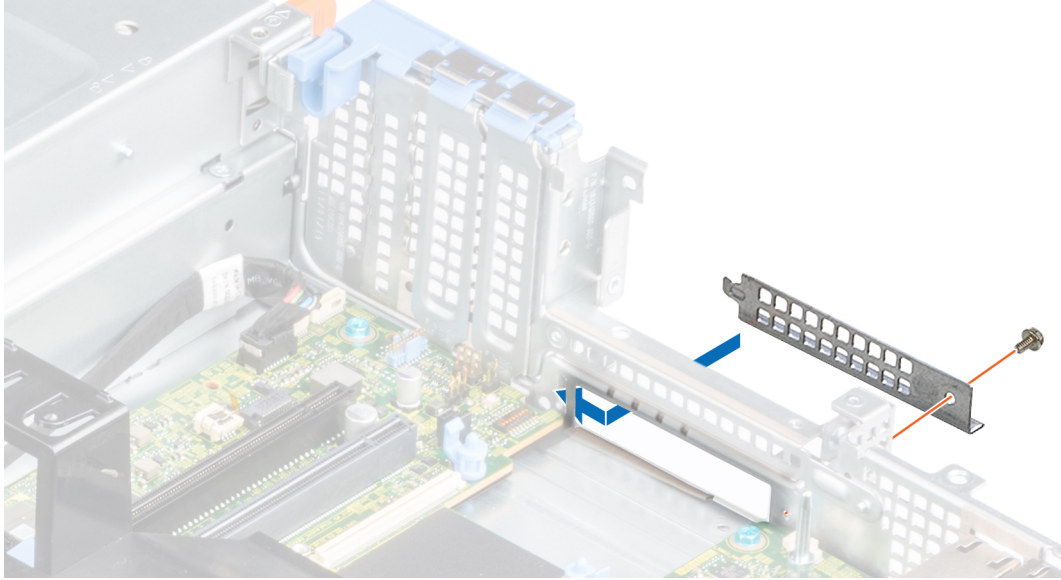

Figure 102. Installing the LOM filler bracket

Next steps

1. [Replace the LOM riser card.](#)

Installing the LOM riser card

Prerequisites

1. Follow the safety guidelines listed in the [Safety instructions](#).
2. Follow the procedure listed in the [Before working inside your system](#).
3. [Remove the air shroud](#).
4. If applicable, [remove the rear drive cage](#).
5. [Remove the expansion card riser](#).

Steps

1. Remove the LOM filler bracket.
 - a. Using a Phillips #2 screwdriver, remove the screw that secures the bracket to the chassis.
 - b. Slide the LOM filler bracket out of the slot on the chassis.

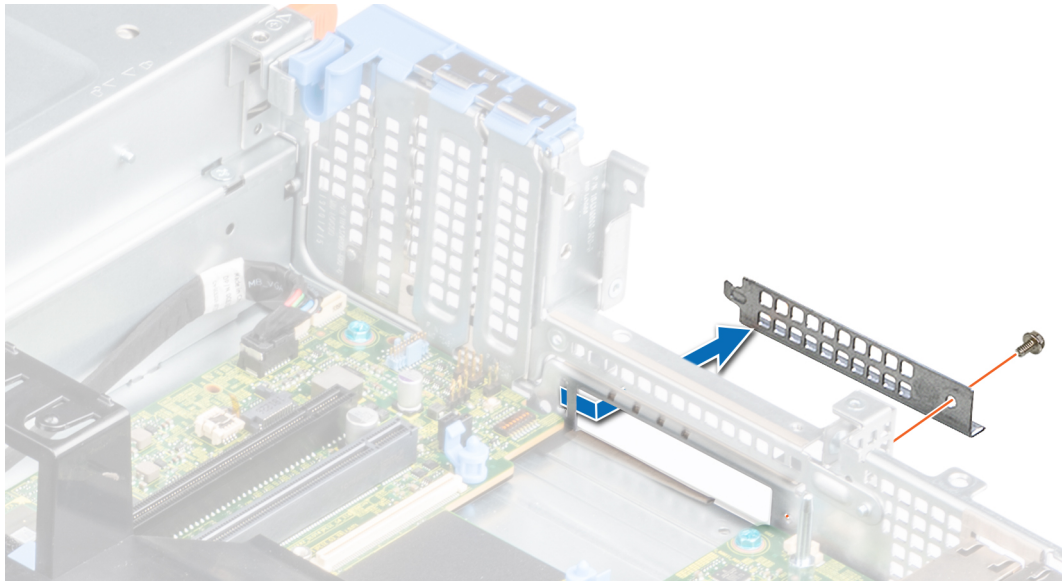

Figure 103. Removing the LOM filler bracket

2. Install the LOM riser bracket.
 - a. Insert and slide the LOM riser bracket into the slot on the chassis.
 - b. Using a Phillips #2 screwdriver, secure the bracket to the chassis with a screw.

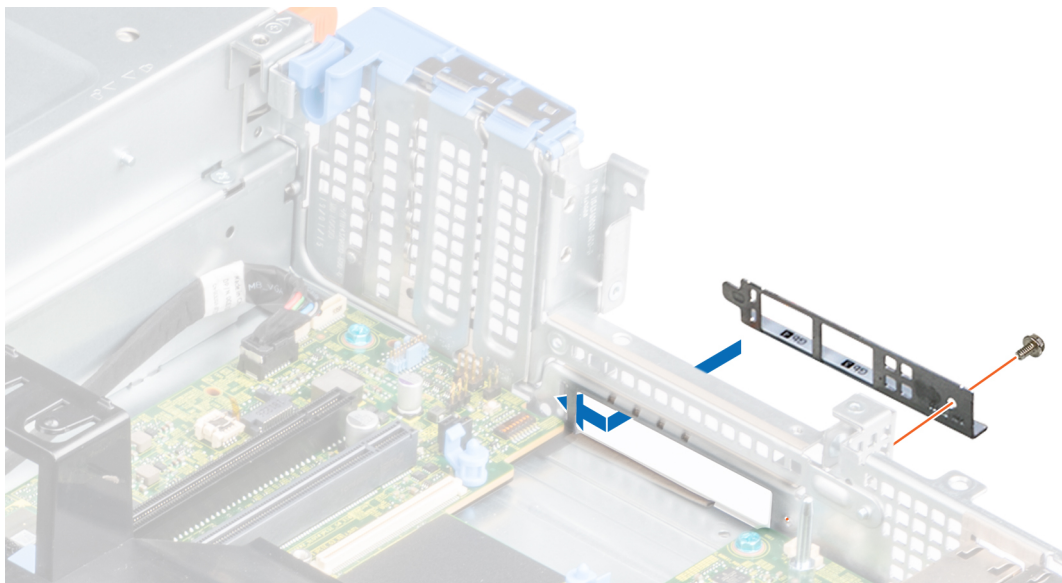

Figure 104. Installing the LOM riser bracket

3. Slide the LOM riser card towards the rear of the system to engage the ports from the slot on the chassis.
4. Connect the LOM riser card to the connector on the system board and push the card until the blue retention clip locks in place.
5. Using a Phillips #2 screwdriver, tighten the screws to secure the LOM card riser to the system..

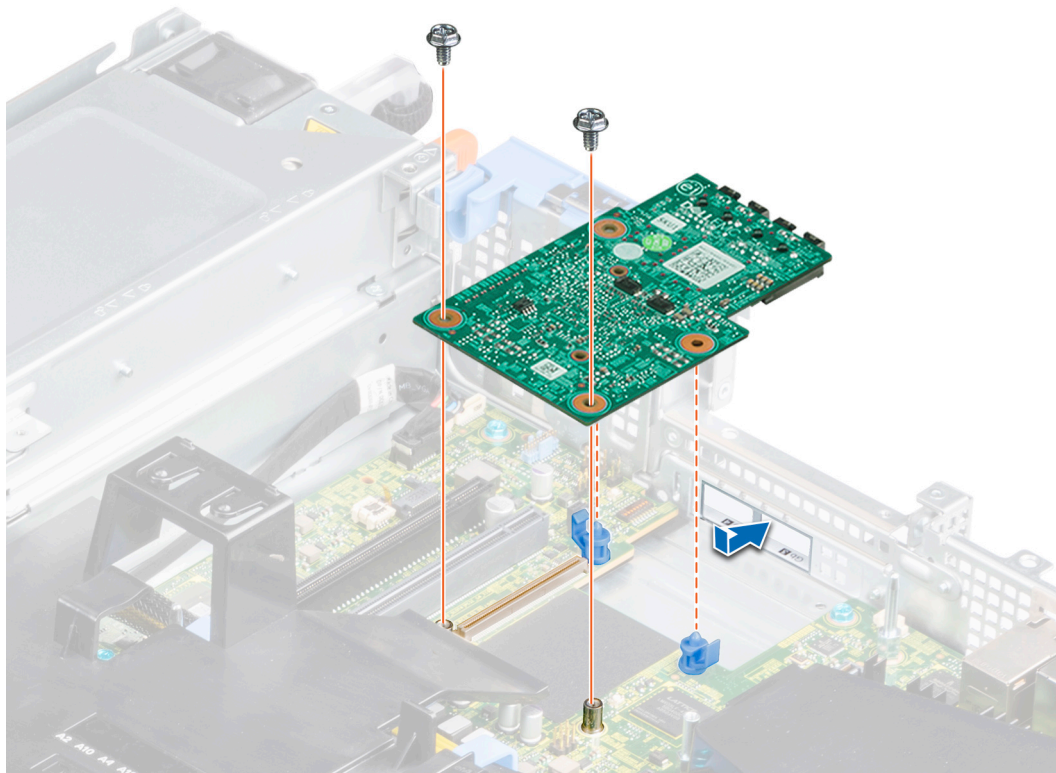

Figure 105. Installing the LOM riser card

Next steps

1. Replace the expansion card riser.
2. If removed, replace the rear drive cage.
3. Install the air shroud.
4. Follow the procedure listed in [After working inside your system](#).

Storage controller card

Removing the mini PERC card air shroud

Prerequisites

CAUTION: Never operate your system with the air shroud removed. The system may get overheated, resulting in shutdown of the system and loss of data.

1. Follow the safety guidelines listed in the [Safety instructions](#).
2. Follow the procedure listed in the [Before working inside your system](#).
3. [Remove the air shroud](#).
4. If applicable, [remove the rear drive cage](#).
5. If applicable, [remove the expansion card riser](#).

NOTE: Never operate the system with the air shroud removed. The system may get overheated quickly, resulting in shutdown of the system and loss of data.

Steps

1. Remove the screw securing the mini PERC card air shroud to the system board.

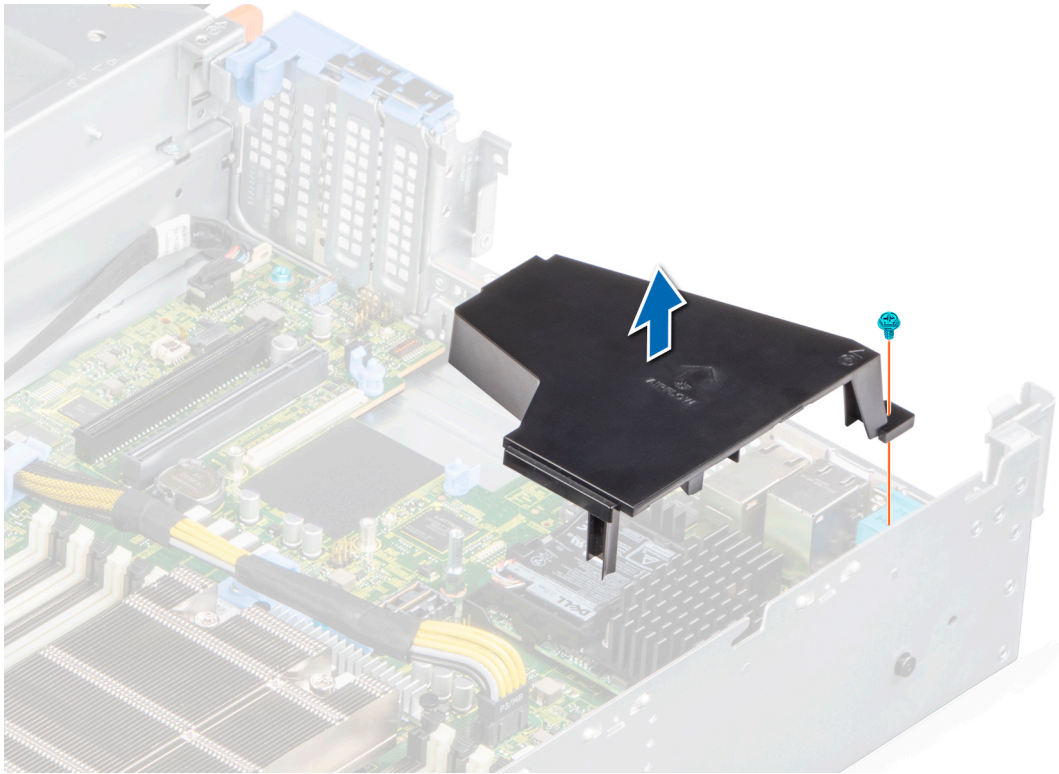

Figure 106. Removing the mini PERC card air shroud

2. Remove the air shroud from the system.

Next steps

1. [Replace the PERC card air shroud.](#)

Installing the mini PERC card air shroud

Prerequisites

1. Follow the safety guidelines listed in the [Safety instructions](#).
2. Follow the procedure listed in the [Before working inside your system](#).
3. [Remove the air shroud.](#)
4. If applicable, [remove the rear drive cage](#).
5. If applicable, [remove the expansion card riser](#).

Steps

1. Align the mini PERC card air shroud with the screw hole on the system board.

NOTE: Route the cable properly to prevent the cable from being pinched or crimped.

2. Lower the air shroud until it is firmly seated.
3. Tighten the screw to secure the mini PERC card air shroud to the system board.

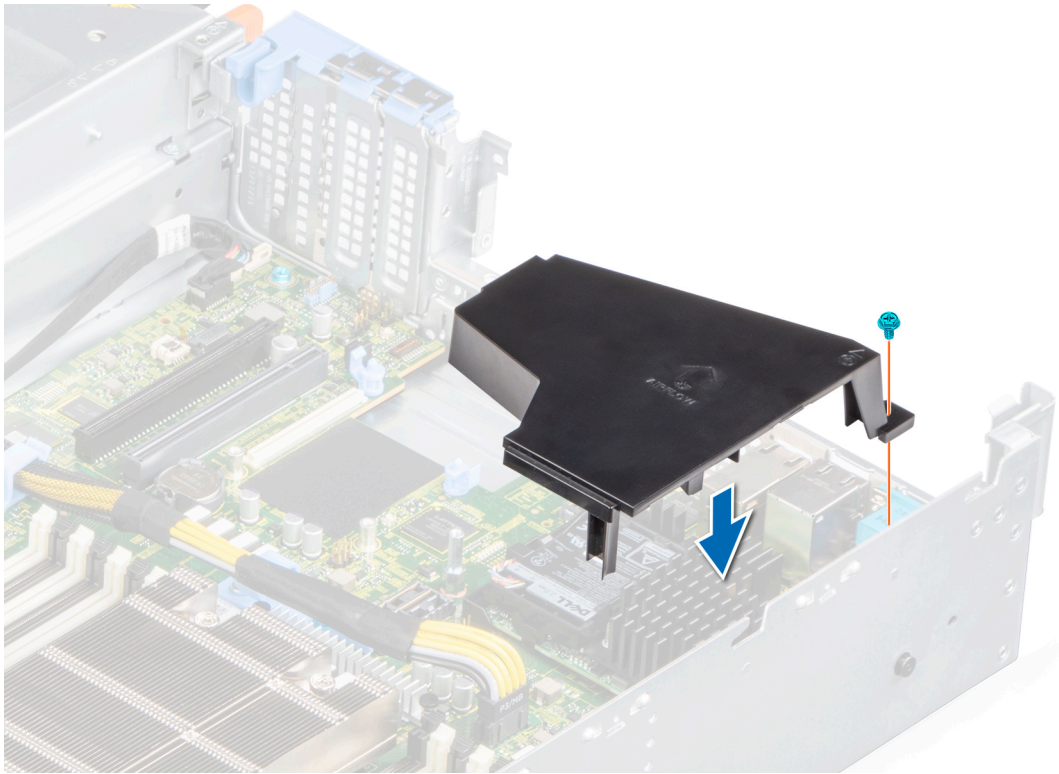

Figure 107. Installing the mini PERC card air shroud

Next steps

1. If removed, [replace the expansion card riser](#).
2. If removed, [replace the rear drive cage](#).
3. [Install the air shroud](#).
4. Follow the procedure listed in [After working inside your system](#).

Removing the internal mini PERC card

Prerequisites

1. Follow the safety guidelines listed in the [Safety instructions](#).
2. Follow the procedure listed in the [Before working inside your system](#).
3. [Remove the air shroud](#).
4. If applicable, [remove the rear drive cage](#).
5. If applicable, [remove the expansion card riser](#).
6. [Remove the PERC card air shroud](#).

Steps

1. Disconnect the SAS connector from the backplane.
2. Using a Phillips #1 screwdriver, remove the screws securing the internal mini PERC card.
3. Lift the internal mini PERC card at an angle to disengage it from the PERC slot and remove it from the system.

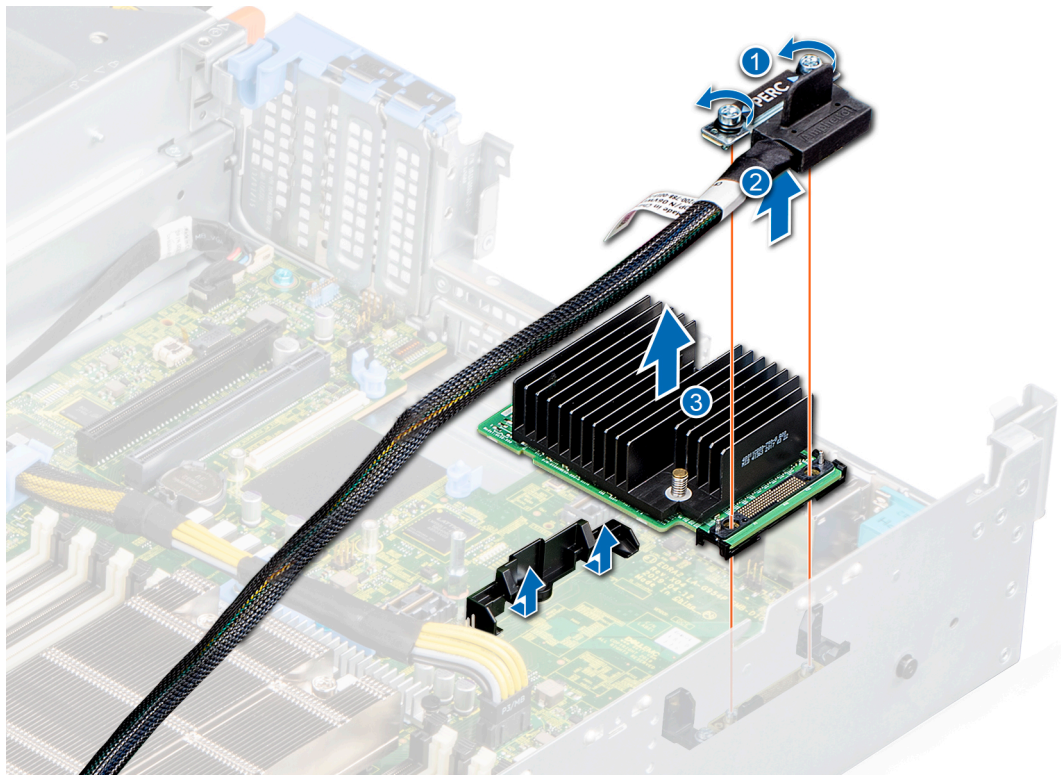

Figure 108. Removing the Internal mini PERC card

Next steps

1. [Replace the internal mini PERC card.](#)

Installing the Internal mini PERC card

Prerequisites

1. Follow the safety guidelines listed in the [Safety instructions](#).
2. Follow the procedure listed in the [Before working inside your system](#).
3. [Remove the air shroud.](#)
4. If applicable, [remove the rear drive cage.](#)
5. If applicable, [remove the expansion card riser.](#)
6. [Remove the PERC card air shroud.](#)

Steps

1. Align and insert the internal mini PERC card at an angle into the PERC card slot.
2. Tighten the screws to secure the internal mini PERC card to the system.
3. Connect the SAS cable to the backplane.

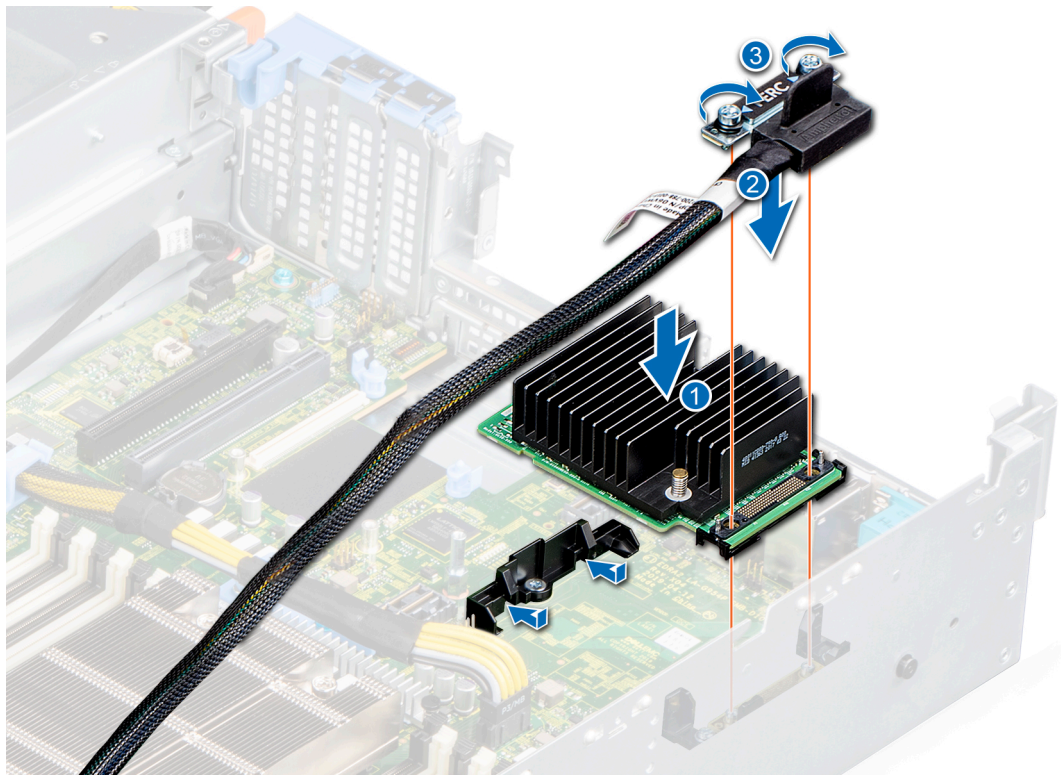

Figure 109. Installing the PERC card

Next steps

1. Install the air shroud.
2. If removed, replace the expansion card riser.
3. If removed, replace the rear drive cage.
4. Install the PERC card air shroud.
5. Follow the procedure listed in [After working inside your system](#).

System battery

Replacing the system battery

Prerequisites

NOTE: There is a danger of a new battery exploding if it is incorrectly installed. Replace the battery only with the same or equivalent type that is recommended by the manufacturer. Discard used batteries according to the manufacturer's instructions. See the [Safety instructions](#) that came with your system for more information.

1. Follow the safety guidelines listed in the [Safety instructions](#).
2. Follow the procedure listed in the [Before working inside your system](#).
3. [Remove the air shroud](#).
4. Locate the battery socket. For more information, see the System board jumpers and connectors section.

Steps

1. Use a plastic scribe and Press the release latch until the battery pops out.

NOTE: Ensure that the + side of the battery is facing upwards.

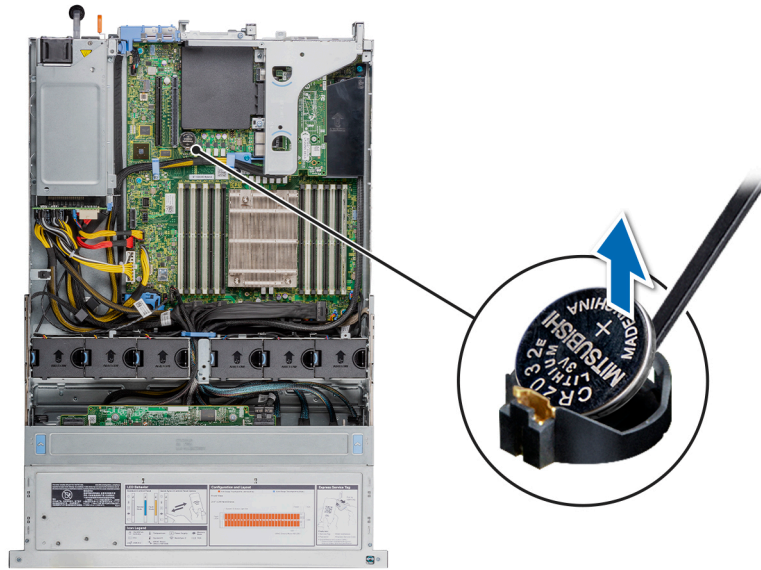

Figure 110. Removing the system battery

2. To install a system battery, press the battery into the connector until it snaps into place.
3. Insert the battery in the battery holder until the battery holder clip snaps into place.

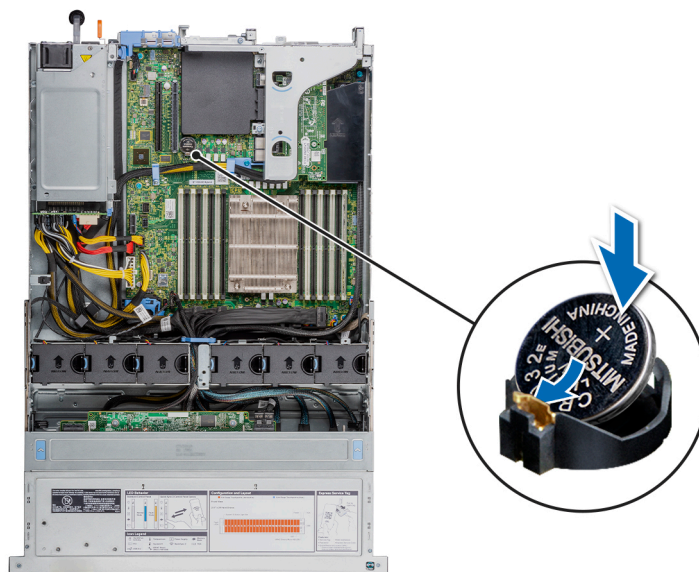

Figure 111. Installing the system battery

Next steps

1. [Install the air shroud.](#)
2. Follow the procedure listed in [After working inside your system.](#)
3. Confirm that the battery is operating properly, by performing the following steps:
 - a. Enter the System Setup, while booting, by pressing **F2**.
 - b. Enter the correct time and date in the System Setup **Time** and **Date** fields.
 - c. **Exit** the System Setup.
 - d. To test the newly installed battery, remove the system from the enclosure for at least an hour.
 - e. Reinstall the system into the enclosure after an hour.

- f. Enter the System Setup and if the time and date are still incorrect, see [Getting help](#) section.

Optional internal USB memory key

NOTE: To locate the internal USB port on the system board, see the [System board jumpers and connectors](#) section.

Replacing the optional internal USB memory key

Prerequisites

CAUTION: To avoid interference with other components in the server, the maximum permissible dimensions of the USB memory key: 15.9 mm width x 57.15 mm length x 7.9 mm height.

1. Follow the safety guidelines listed in the [Safety instructions](#).
2. Follow the procedure listed in the [Before working inside your system](#).
3. [Remove the air shroud](#).

Steps

1. Locate the USB port or USB memory key on the system board.
To locate the USB port, see the [System board jumpers and connectors](#) section.
2. If installed, remove the USB memory key from the USB port.

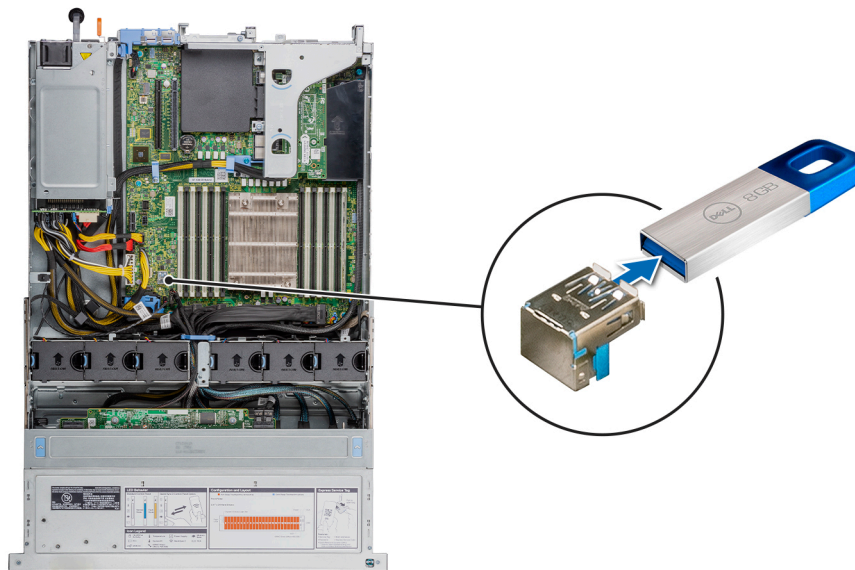

Figure 112. Removing the internal USB memory key

- a. USB memory key
 - b. USB port
3. Insert the replacement USB memory key into the USB port.

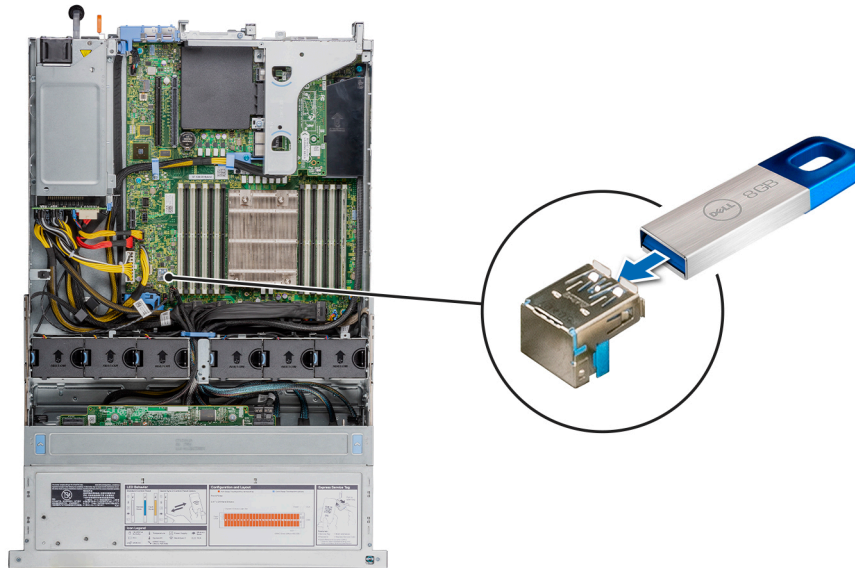

Figure 113. Installing the internal USB memory key

- a. USB memory key
- b. USB port

Next steps

1. [Install the air shroud.](#)
2. Follow the procedure listed in [After working inside your system.](#)
3. While booting, press F2 to enter System Setup and verify that the system detects the USB memory key.

Optional optical drive

Removing the optical drive

The procedure for removing an optical drive and optical drive blank is the same.

Prerequisites

1. Follow the safety guidelines listed in the [Safety instructions.](#)
2. Follow the procedure listed in the [Before working inside your system.](#)
3. If installed, [remove the front bezel.](#)
4. If applicable, [remove the backplane cover.](#)
5. Disconnect the power and data cables from the connectors on the optical drive.
 - i** **NOTE:** Ensure that you note the routing of the power and data cable on the side of the system as you remove them from the system board and drive. Route these cables properly when you replace them to prevent them from being pinched or crimped.

Steps

1. Press the release tab to release the optical drive.
2. Slide the optical drive out of the optical drive slot.

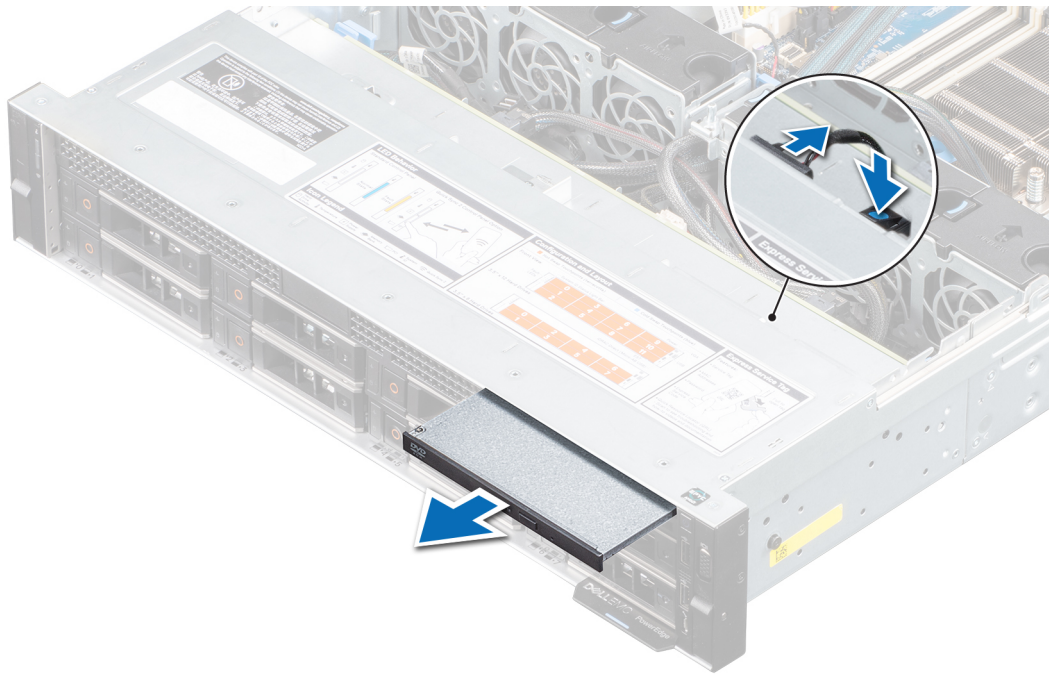

Figure 114. Removing optical drive

3. If you are not installing a new optical drive, install the optical drive blank. The procedure to install the optical drive blank is the same as the optical drive.

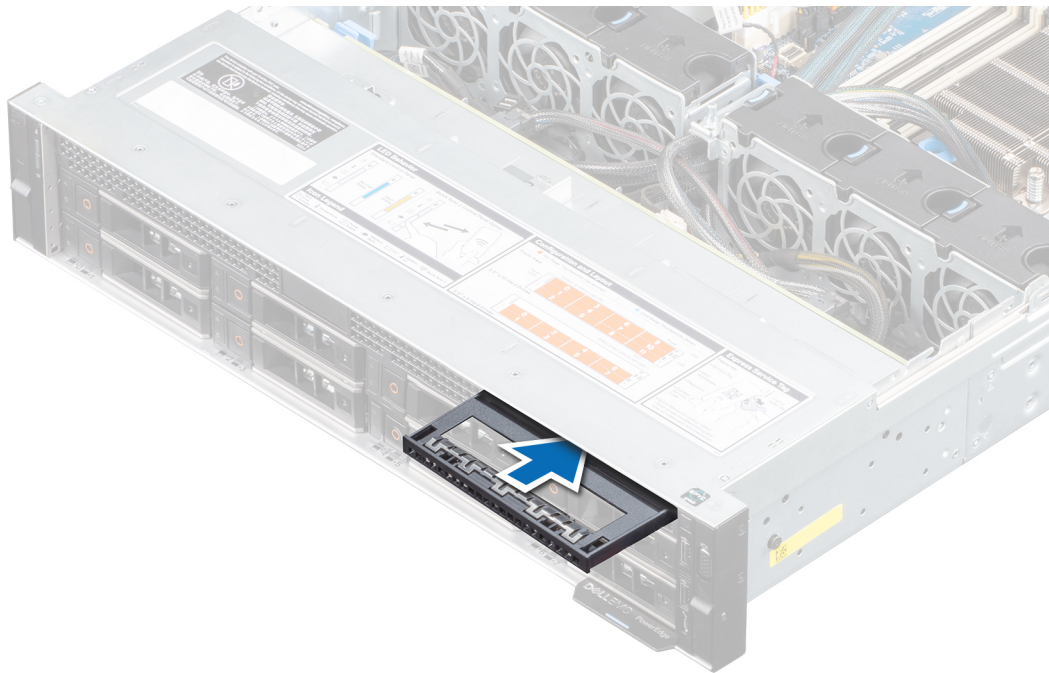

Figure 115. Installing optical drive blank

Next steps

1. [Replace the optical drive.](#)

NOTE: Blanks must be installed on empty optical drive slot to maintain FCC certification of the system. The blank also keep dust and dirt out of the system and aid in proper cooling and airflow inside the system.

Installing the optional optical drive

The procedure for installing an optical drive and optical drive blank.

Prerequisites

1. Follow the safety guidelines listed in the [Safety instructions](#).
 2. Follow the procedure listed in the [Before working inside your system](#).
 3. If installed, [remove the front bezel](#).
 4. If applicable, [remove the backplane cover](#).
 5. Disconnect the power and data cables from the connectors on the optical drive.
- NOTE:** Ensure that you note the routing of the power and data cable on the side of the system as you remove them from the system board and drive. Route these cables properly when you replace them to prevent them from being pinched or crimped.

Steps

1. If installed, remove the optical drive blank. The procedure to remove an optical blank is similar to the optical drive.

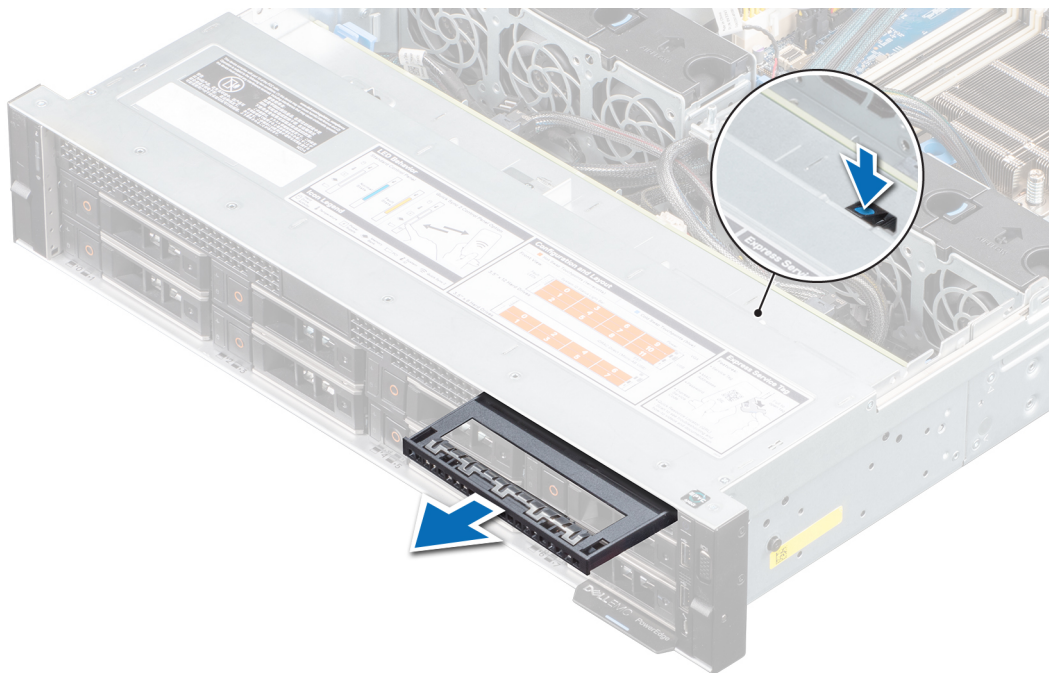

Figure 116. Removing optical blank

2. Align the optical drive with the optical drive slot on the front of the system.
3. Slide in the optical drive until the release tab snaps into place.

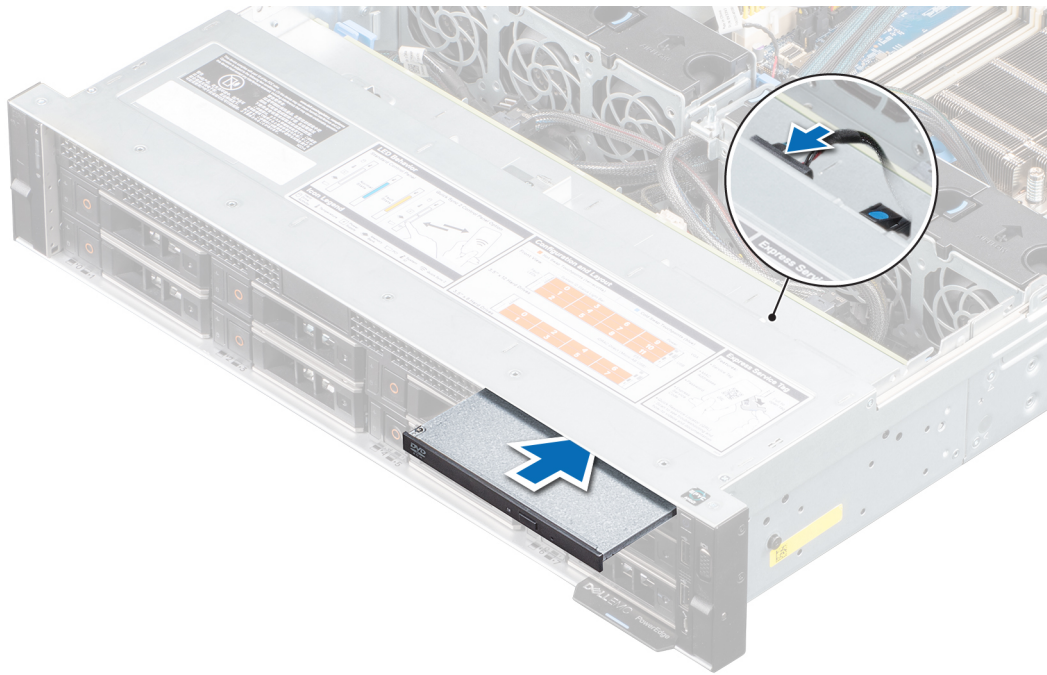

Figure 117. Installing optical drive

Next steps

1. Connect the power and data cables to the connector on the optical drive and the connector on the system board.
i **NOTE:** Route the cable properly on the side of the system to prevent it from being pinched or crimped.
2. If removed, [install the front bezel](#).
3. If applicable, [install the backplane cover](#).
4. Follow the procedure listed in [After working inside your system](#).

Power supply unit

i **NOTE:** While replacing the hot swappable PSU, after next server boot; the new PSU automatically updates to the same firmware and configuration of the replaced one. For more information about the Part replacement configuration, see the *Lifecycle Controller User's Guide* at <https://www.dell.com/idracmanuals>

Hot spare feature

Your system supports the hot spare feature that significantly reduces the power overhead associated with power supply unit (PSU) redundancy.

When the hot spare feature is enabled, one of the redundant PSUs is switched to the sleep state. The active PSU supports 100 percent of the system load, thus operating at higher efficiency. The PSU in the sleep state monitors output voltage of the active PSU. If the output voltage of the active PSU drops, the PSU in the sleep state returns to an active output state.

If having both PSUs active is more efficient than having one PSU in the sleep state, the active PSU can also activate the sleeping PSU.

The default PSU settings are as follows:

- If the load on the active PSU is more than 50 percent of PSU rated power wattage, then the redundant PSU is switched to the active state.
- If the load on the active PSU falls below 20 percent of PSU rated power wattage, then the redundant PSU is switched to the sleep state.

You can configure the hot spare feature by using the iDRAC settings. For more information, see the *iDRAC User's Guide* available at www.dell.com/poweredgemanuals.

Removing a power supply unit blank

Prerequisites

1. Follow the safety guidelines listed in the [Safety instructions](#).

Steps

Pull the blank out of the system.

CAUTION: To ensure proper system cooling, the power supply unit blank must be installed in the second power supply unit bay in a non-redundant configuration. Remove the power supply unit blank only if you are installing a second power supply unit.

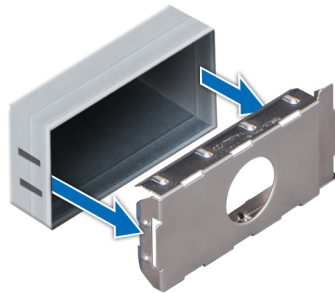

Figure 118. Removing a power supply unit blank

Next steps

1. [Replace the power supply blank](#) or [install the power supply unit](#).

Removing a power supply unit

Prerequisites

CAUTION: The system requires one power supply unit (PSU) for normal operation. On power-redundant systems, remove and replace only one PSU at a time in a system that is powered on.

1. Follow the safety guidelines listed in the [Safety instructions](#).
2. Disconnect the power cable from the power outlet and from the PSU you intend to remove.
3. Remove the cable from the strap on the PSU handle.
4. Unlatch and lift the optional cable management arm if it interferes with the PSU removal.

For information about the cable management arm, see the system's rack documentation at www.dell.com/poweredgemanuals.

Steps

Press the release latch, and holding the PSU handle slide the PSU out of the PSU bay.

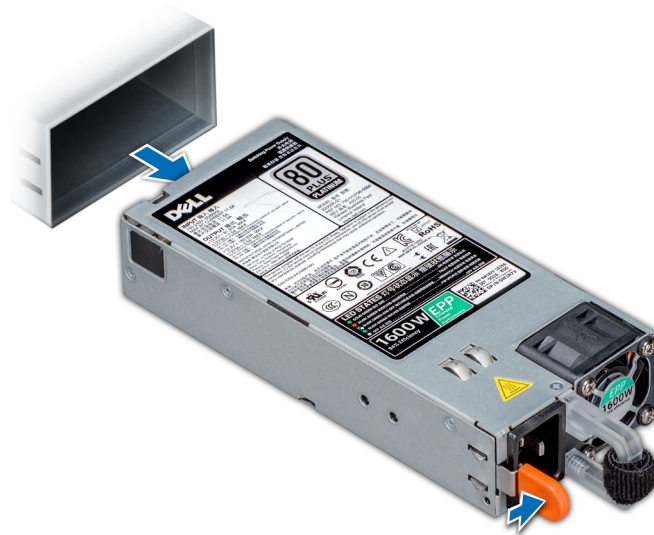

Figure 119. Removing a power supply unit

Next steps

1. [Replace the power supply units](#) or [Install the PSU blank](#).

Installing a power supply unit

Prerequisites

1. Follow the safety guidelines listed in the [Safety instructions](#).
2. For systems that support redundant PSU, ensure that both the PSUs are of the same type and have the same maximum output power.

NOTE: The maximum output power (shown in watts) is listed on the PSU label.

3. [Remove the PSU blank](#).

Steps

Slide the PSU into the PSU bay until the release latch snaps into place.

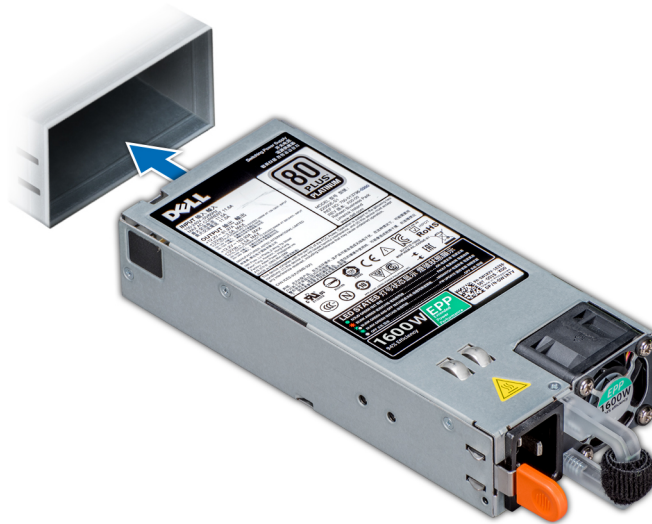

Figure 120. Installing a power supply unit

Next steps

1. If you have unlatched the cable management arm, relatch it. For information about the cable management arm, see the system's rack documentation at www.dell.com/poweredgemanuals.
2. Connect the power cable to the PSU, and plug the cable into a power outlet.
 - i NOTE:** When connecting the power cable to the PSU, secure the cable to the PSU with the strap.
 - i NOTE:** When installing, hot swapping, or hot adding a new PSU, wait for 15 seconds for the system to recognize the PSU and determine its status. The PSU redundancy may not occur until discovery is complete. The PSU status indicator turns green to indicate that the PSU is functioning properly.
 - i NOTE:** While replacing the hot swappable PSU, after next server boot; the new PSU automatically updates to the same firmware and configuration of the replaced one. For more information about the Part replacement configuration, see the *Lifecycle Controller User's Guide* at <https://www.dell.com/idracmanuals>

Installing a power supply unit blank

Prerequisites

1. Follow the safety guidelines listed in the [Safety instructions](#).
2. [Remove the power supply unit](#).

Steps

Align the PSU blank with the PSU bay and push it into the PSU bay until it clicks into place.

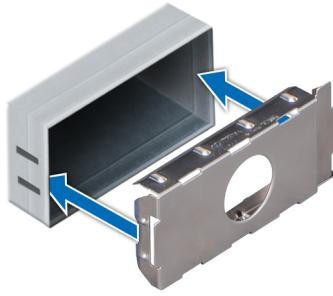

Figure 121. Installing a power supply unit blank

Power interposer board

Removing the power interposer board

Prerequisites

1. Follow the safety guidelines listed in the [Safety instructions](#).
2. Follow the procedure listed in the [Before working inside your system](#).
3. [Remove the power supply units](#).
4. [Remove the air shroud](#).

Steps

1. Disconnect all the cables from the system board and the backplane.

i **NOTE:** Observe the routing of the cable as you remove it from the system.

2. Using a Phillips #2 screwdriver, remove the screws securing the power interposer board (PIB) to the chassis.
3. Press the blue retention tab and lift the PIB at an angle to disengage it from the hooks on the PSU cage.
4. Remove the PIB from the system.

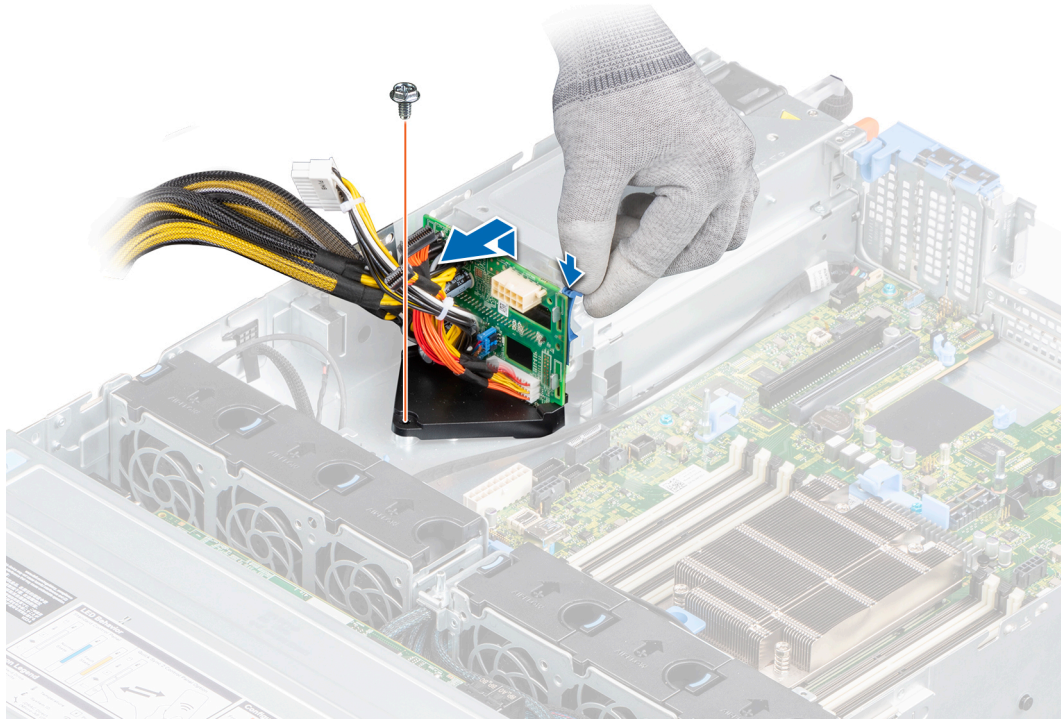

Figure 122. Removing the power interposer board

Next steps

1. [Replace the power interposer board.](#)

Installing the power interposer board

Prerequisites

1. Follow the safety guidelines listed in the [Safety instructions](#).
2. Follow the procedure listed in the [Before working inside your system](#).
3. [Remove the power supply units.](#)
4. [Remove the air shroud.](#)

Steps

1. Align the slots on the power interposer board (PIB) with the hooks on the PSU cage and press the PIB until the blue retention tab clicks into place.
2. Using a Phillips #2 screwdriver, replace the screw that secures the PIB to the chassis.
3. Connect the cables to the system board and the drive backplane.

(i) NOTE: Route the cables properly when you replace the PIB to prevent the cable from being pinched or crimped.

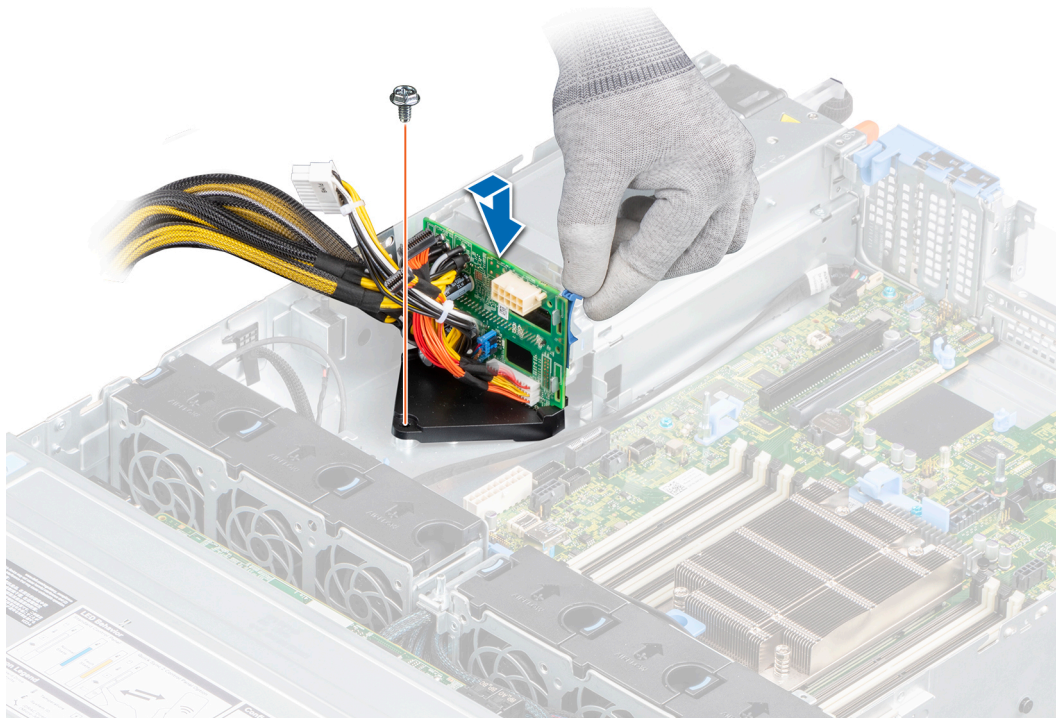

Figure 123. Installing the power interposer board

Next steps

1. Install the air shroud.
2. Install the power supply units.
3. Follow the procedure listed in [After working inside your system](#).

System board

Removing the system board

Prerequisites

CAUTION: If you are using the Trusted Platform Module (TPM) with an encryption key, you may be prompted to create a recovery key during program or System Setup. Be sure to create and safely store this recovery key. If you replace this system board, you must supply the recovery key when you restart your system or program before you can access the encrypted data on your drives.

1. Follow the safety guidelines listed in the [Safety instructions](#).
2. Follow the procedure listed in the [Before working inside your system](#).
3. Remove the following components:
 - a. [Air shroud](#)
 - b. [Expansion cards](#)
 - c. [Expansion card riser](#)
 - d. [Internal mini PERC card](#)
 - e. If applicable, [IDSDM module](#)
 - f. If applicable, [internal USB](#)
 - g. [Memory modules](#)
 - h. [Processor](#)
 - i. [Heat sink](#)
 - j. [LOM riser card](#)

- k. If applicable, [rear drive cage](#)
- l. [Trusted Platform Module](#)
- m. Disconnect the fan cables
- n.  **CAUTION:** To prevent damage to the processor socket when replacing a faulty system board, ensure that you cover the processor socket with the processor dust cover.
- o. Disconnect all the cables from the system board.

 **CAUTION:** Take care not to damage the system identification button while removing the system board from the system.

Steps

1. Using a Phillips #2 screwdriver, remove the screws securing the system board to the chassis.
2. Holding the system board holder, slightly lift the system board and slide it towards the front of the chassis.
3. Lift the system board out of the chassis.

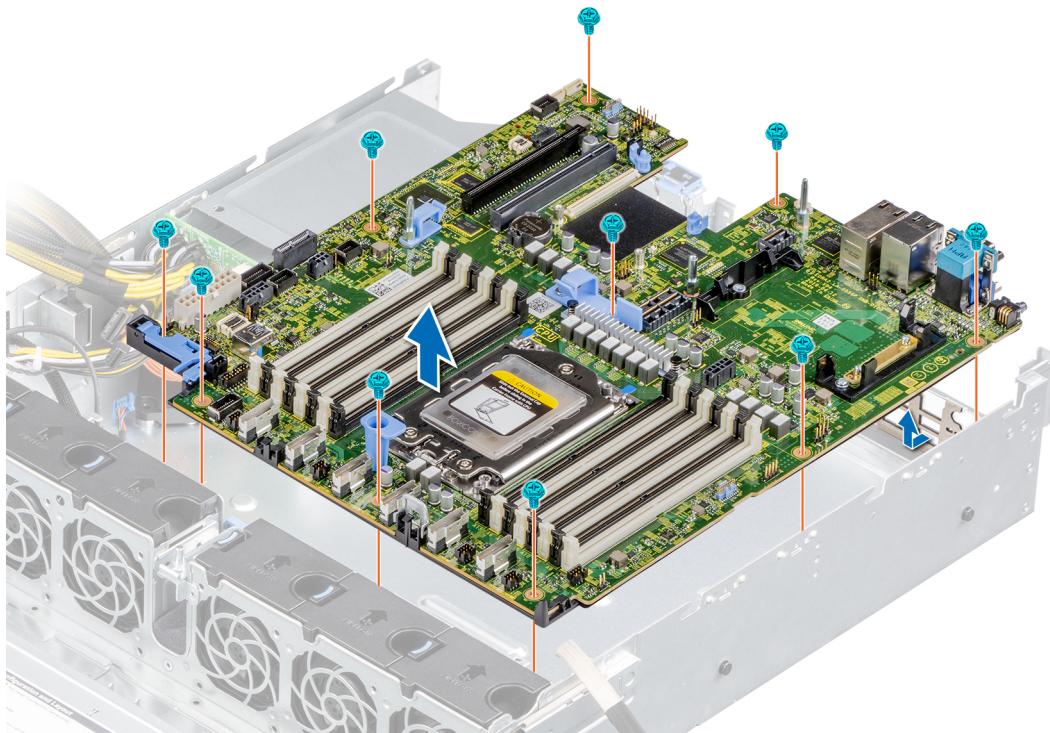



Figure 124. Removing the system board

Next steps

1. [Replace the system board.](#)

Installing the system board

Prerequisites

 **NOTE:** Before replacing the system board, replace the old iDRAC MAC address label in the Information tag with the iDRAC MAC address label of the replacement system board.

1. Follow the safety guidelines listed in the [Safety instructions](#).
2. Follow the procedure listed in the [Before working inside your system](#).
3. If you are replacing the system board, remove all the components that are listed in the [removing the system board](#) section.

Steps

1. Unpack the new system board assembly.

i **NOTE:** Do not lift the system board by holding a memory module, processor, or other components.

⚠ **CAUTION:** Take care not to damage the system identification button while placing the system board into the chassis.

2. Holding the system board holder, lower the system board into the system.
3. Incline the system board at an angle and align the connectors with the slots on the rear of the chassis.
4. Slide the system board towards the rear of the chassis until the connectors are firmly seated in the slots.

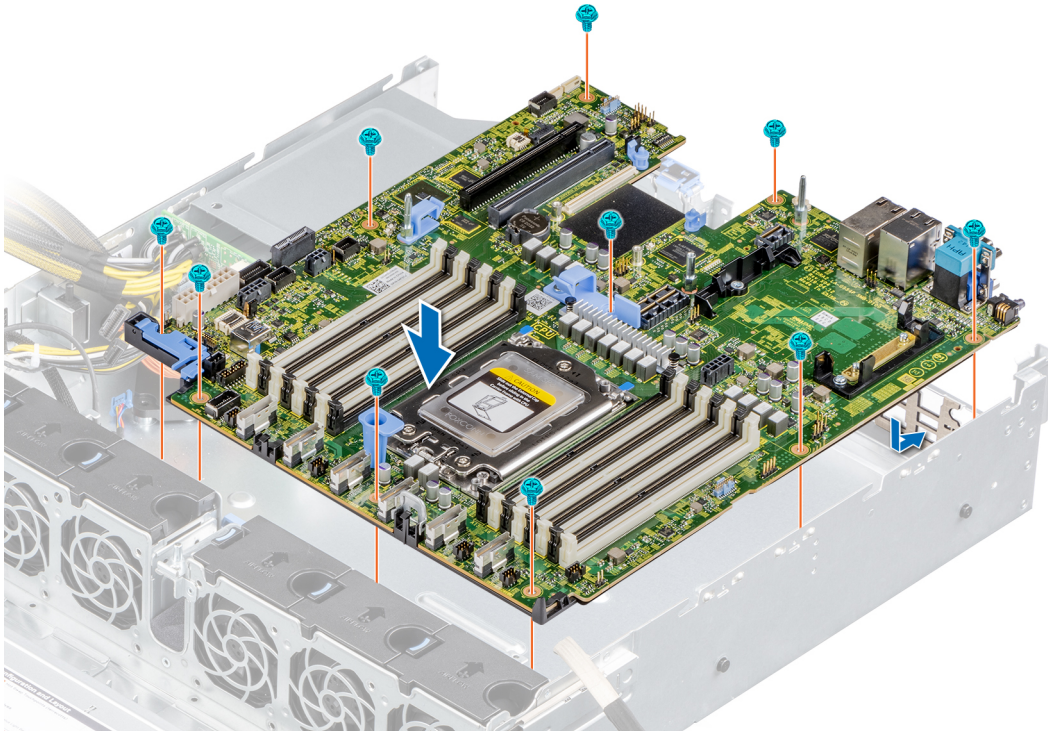

Figure 125. Installing the system board

5. Using a Phillips #2 screwdriver, fasten the screws that secure the system board to the chassis.

Next steps

1. Replace the following:

- a. [Trusted platform module](#)

i **NOTE:** The TPM Module must be replaced only while installing new system board.

- b. [Internal mini PERC card](#)
- c. If applicable, [IDSDM module](#)
- d. [Heat sink](#)
- e. [Processor](#)
- f. [Expansion cards](#)
- g. [Expansion card riser](#)
- h. If applicable, [internal USB](#)
- i. Connect the fan cables
- j. [LOM riser card](#)
- k. [Memory modules](#)
- l. [Air shroud](#)
- m. If applicable, [rear drive cage](#)
- n. Reconnect the cables to the system board.

 **NOTE:** Ensure that the cables inside the system are routed along the chassis wall and secured using the cable securing bracket.



2. Follow the procedure listed in [After working inside your system](#).
3. Power on the system.
4. Ensure that you perform the following steps:
 - a. Use the Easy Restore feature to restore the Service Tag. For more information, see the Easy restore section.
 - b. If the Service Tag is not backed up in the backup flash device, enter the Service Tag manually. For more information, see the [Restoring the Service Tag by using Easy Restore](#) section.
 - c. Update the BIOS and iDRAC versions.
 - d. Re-enable the Trusted Platform Module (TPM). See the [Reenabling the TPM for users](#) section.
5. If you are not using Easy restore, import your new or existing iDRAC Enterprise license. For more information, see the *Integrated Dell Remote Access Controller User's Guide*, at www.dell.com/idracmanuals.

Restoring the system using Easy Restore

The easy restore feature enables you to restore your service tag, license, UEFI configuration, and the system configuration data after replacing the system board. All data is backed up in a backup flash device automatically. If BIOS detects a new system board, and the service tag in the backup flash device, BIOS prompts the user to restore the backup information.

About this task

Below is a list of options available:

- Restore the service tag, license, and diagnostics information, press **Y**
 - Navigate to the Lifecycle Controller based restore options, press **N**.
 - Restore data from a previously created **Hardware Server Profile**, press **F10**
-  **NOTE:** When the restore process is complete, BIOS prompts to restore the system configuration data.
- To restore the system configuration data, press **Y**
 - To use the default configuration settings, press **N**
-  **NOTE:** After the restore process is complete, system reboots.

Manually update the Service Tag

After replacing a system board, if Easy Restore fails, follow this process to manually enter the Service Tag, using **System Setup**.

About this task

If you know the system service tag, use the **System Setup** menu to enter the service tag.

Steps

1. Power on the system.
 2. To enter the **System Setup**, press **F2**.
 3. Click **Service Tag Settings**.
 4. Enter the service tag.
-  **NOTE:** You can enter the service tag only when the **Service Tag** field is empty. Ensure that you enter the correct service tag. Once the service tag is entered, it cannot be updated or changed.
5. Click **OK**.

Trusted Platform Module

Upgrading the Trusted Platform Module

Prerequisites

NOTE:

- Ensure that your operating system supports the version of the TPM module being installed.
- Ensure that you download and install the latest BIOS firmware on your system.
- Ensure that the BIOS is configured to enable UEFI boot mode.

About this task

 **CAUTION:** Once the TPM plug-in module is installed, it is cryptographically bound to that specific system board. Any attempt to remove an installed TPM plug-in module breaks the cryptographic binding, the removed TPM cannot be reinstalled or installed on another system board.

Removing the TPM

Steps

1. Locate the TPM connector on the system board.
2. Press to hold the module down and remove the screw using the security Torx 8-bit shipped with the TPM module.
3. Slide the TPM module out from its connector.
4. Push the plastic rivet away from the TPM connector and rotate it 90° counterclockwise to release it from the system board.
5. Pull the plastic rivet out of its slot on the system board.

Installing the TPM

Steps

1. To install the TPM, align the edge connectors on the TPM with the slot on the TPM connector.
2. Insert the TPM into the TPM connector such that the plastic rivet aligns with the slot on the system board.
3. Press the plastic rivet until the rivet snaps into place.
4. Replace the screw that secures the TPM to the system board.

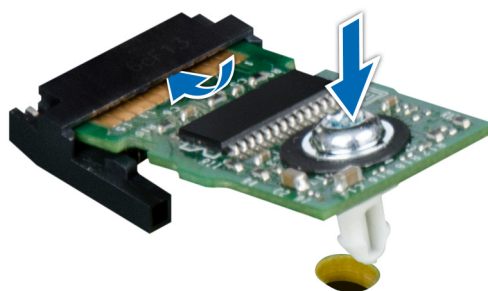

Figure 126. Installing the TPM

Initializing TPM for users

Steps

1. Initialize the TPM.
For more information, see [Initializing the TPM for users](#).
2. The **TPM Status** changes to **Enabled, Activated**.

Initializing the TPM 1.2 for users

Steps

1. While booting your system, press F2 to enter System Setup.
2. On the **System Setup Main Menu** screen, click **System BIOS > System Security Settings**.
3. From the **TPM Security** option, select **On with Preboot Measurements**.
4. From the **TPM Command** option, select **Activate**.
5. Save the settings.
6. Restart your system.

Initializing the TPM 2.0 for users

Steps

1. While booting your system, press F2 to enter System Setup.
2. On the **System Setup Main Menu** screen, click **System BIOS > System Security Settings**.
3. From the **TPM Security** option, select **On**.
4. Save the settings.
5. Restart your system.

Control panel

Removing the left control panel

Prerequisites

1. Follow the safety guidelines listed in the [Safety instructions](#).
2. Follow the procedure listed in the [Before working inside your system](#).
3. [Remove the air shroud](#).
 **NOTE:** Ensure that you note the routing of the cables as you remove them from the system board. You must route the cables properly when you replace them to prevent the cables from being pinched or crimped.

Steps

1. Disconnect the left control panel cable from the system board connector.
2. Using a Phillips #1 screwdriver, remove the screws that secure the left control panel assembly to the chassis.
3. Hold the left control panel assembly and remove it from the system.

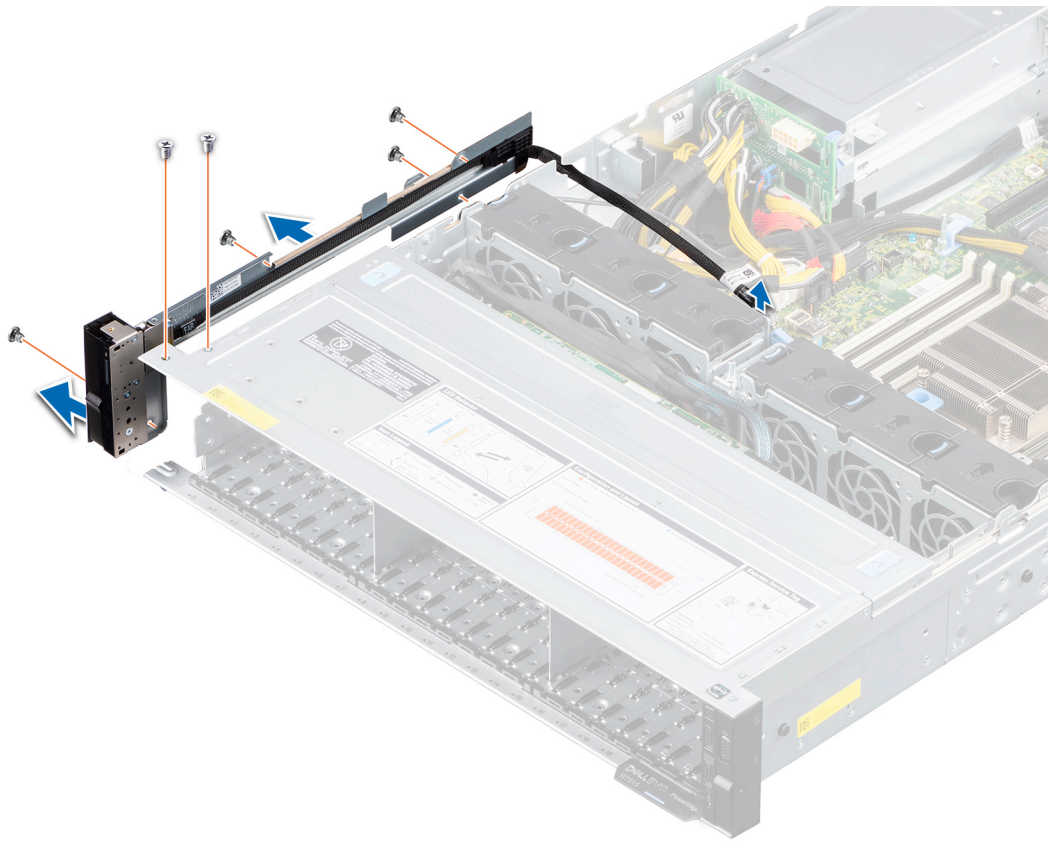

Figure 127. Removing the left control panel

Next steps

1. [Replace the left control panel.](#)

Installing the left control panel

Prerequisites

1. Follow the safety guidelines listed in the [Safety instructions](#).
2. Follow the procedure listed in the [Before working inside your system](#).
3. [Remove the air shroud.](#)

Steps

1. Route the left control panel cable through the chassis sidewall.

NOTE: Route the cable properly to prevent the cable from being pinched or crimped.

2. Align and insert the tabs on the left control panel assembly into the slots on the chassis.
3. Using a Phillips #1 screwdriver, replace the screws to secure the left control panel assembly to the chassis.
4. Connect the left control panel cable to the connector on the system board.

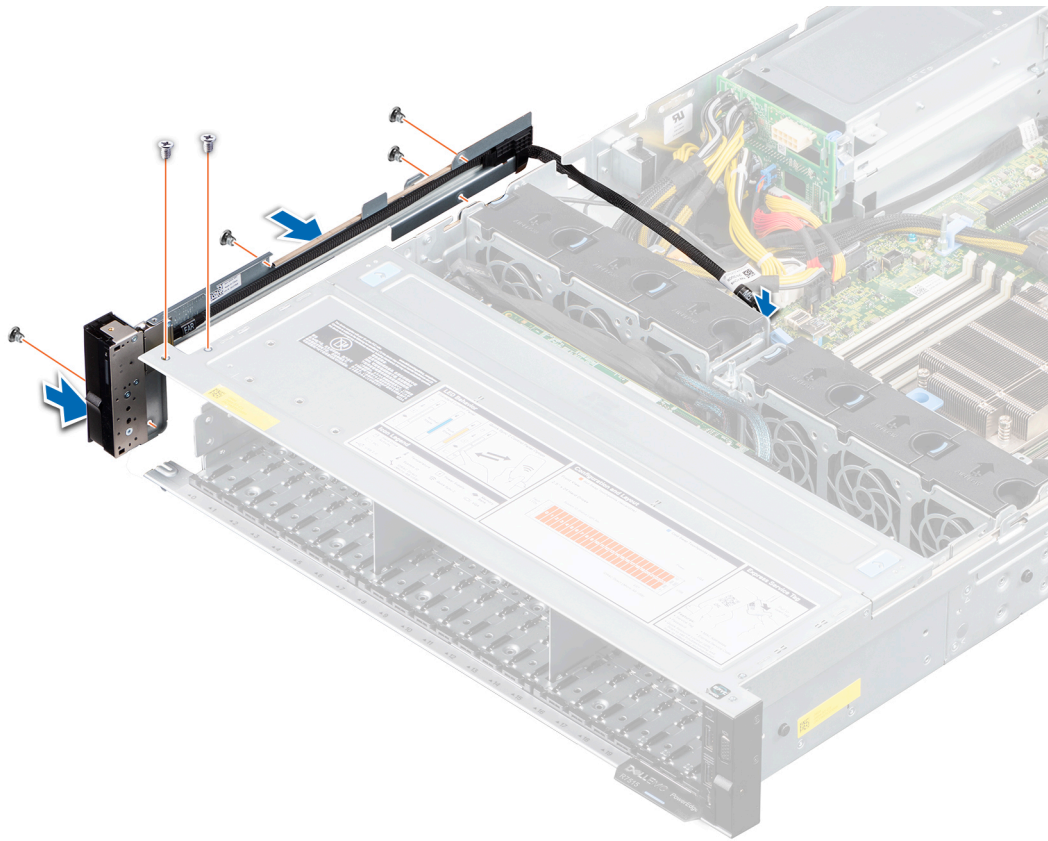

Figure 128. Installing the left control panel

Next steps

1. [Install the air shroud.](#)
2. Follow the procedure listed in [After working inside your system.](#)

Removing the right control panel

Prerequisites

1. Follow the safety guidelines listed in the [Safety instructions.](#)
2. Follow the procedure listed in the [Before working inside your system.](#)
 - NOTE:** Ensure that you note the routing of the cables as you remove them from the system board. You must route the cables properly when you replace them to prevent the cables from being pinched or crimped.
3. [Remove the air shroud.](#)

Steps

1. Disconnect the right control panel cable from the connector on the system board.
2. Open the blue cable retention latch and disconnect the VGA cable from the connector on the system board.
3. Using a Phillips #1 screwdriver, remove the screws that secure the right control panel assembly.
4. Hold the right control panel assembly and remove it from the system.

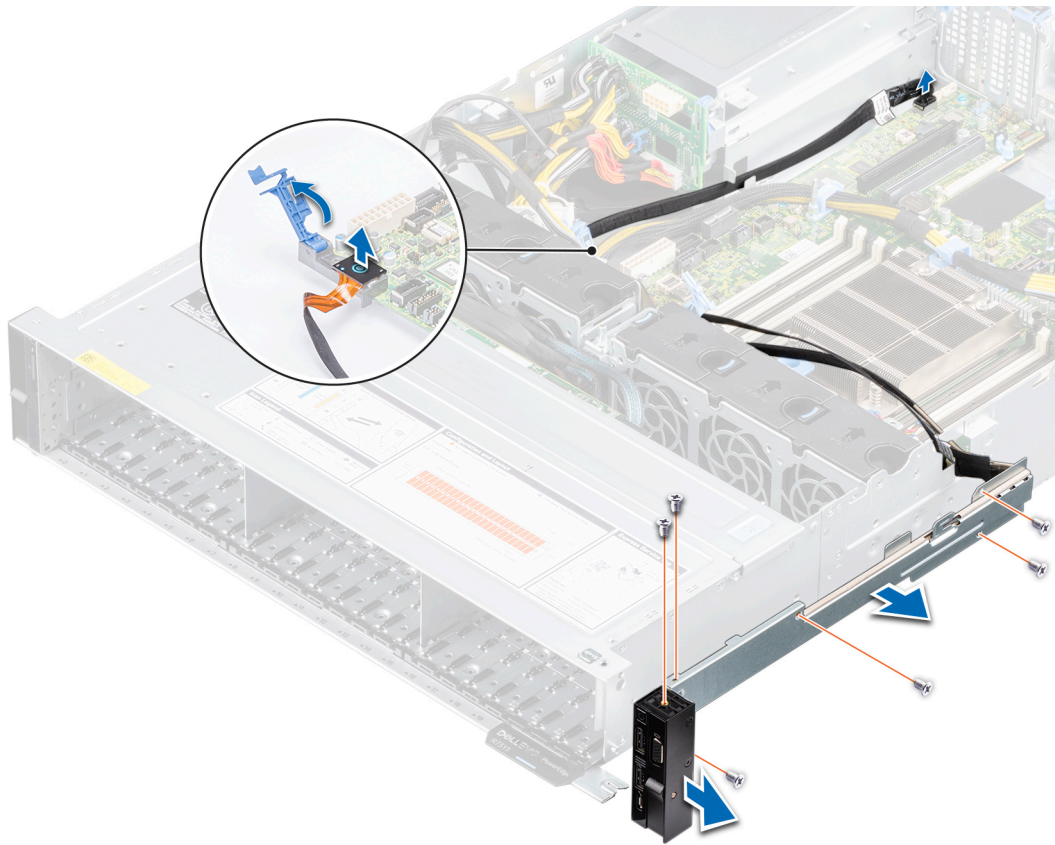

Figure 129. Removing the right control panel

Next steps

1. [Replace the right control panel.](#)

Installing the right control panel

Prerequisites

1. Follow the safety guidelines listed in the [Safety instructions](#).
2. Follow the procedure listed in the [Before working inside your system](#).
3. [Remove the air shroud.](#)

Steps

1. Route the right control panel cable and the VGA cable through the chassis sidewall.

NOTE: Route the cable properly to prevent the cable from being pinched or crimped.

2. Align and insert the tabs on the right control panel assembly into the slots on the chassis.
3. Using a Phillips #1 screwdriver, replace the screws to secure the right control panel assembly to the chassis.
4. Connect the right control panel cable to the connector on the system board.

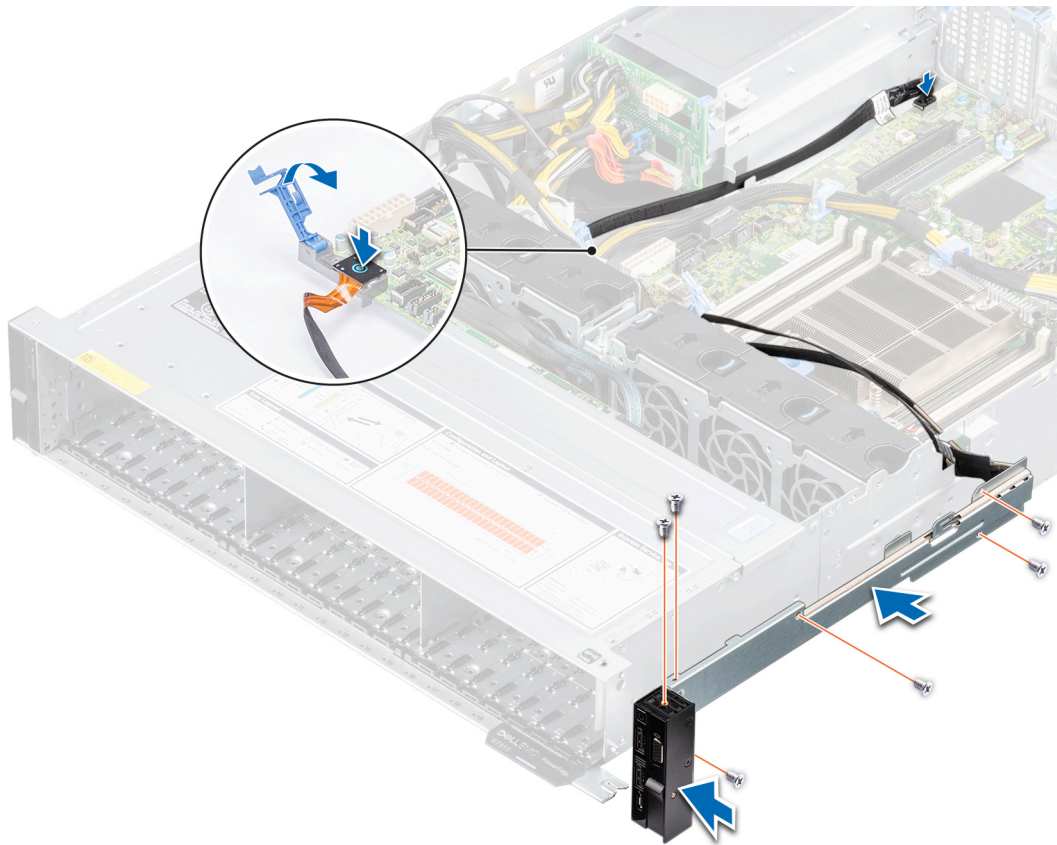

Figure 130. Installing the right control panel

5. Connect the VGA cable to the connector on the system board and close the blue cable retention latch.

Next steps

1. [Replace the air shroud.](#)
2. Follow the procedure listed in [After working inside your system.](#)

Jumpers and connectors

This section provides essential and specific information about jumpers and switches. It also describes the connectors on the various boards in the system. Jumpers on the system board help to disable the system and reset the passwords. To install components and cables correctly, you must be able to identify the connectors on the system board.

Topics:

- [System board connectors](#)
- [System board jumper settings](#)
- [Disabling a forgotten password](#)

System board connectors

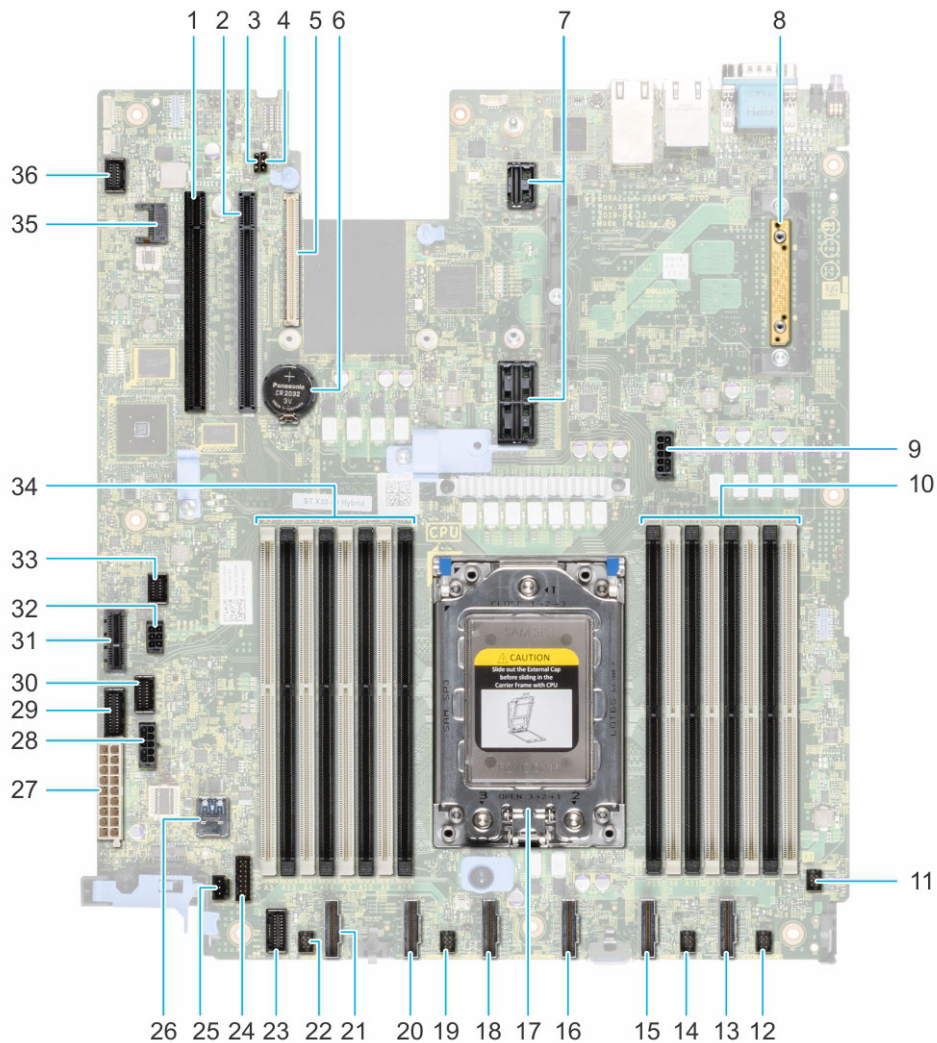

Figure 131. System board connectors

- | | |
|--------------------------------|-------------------------------|
| 1. PCI card Slot 5 | 2. PCI card Slot 4 |
| 3. PWRD_EN (Jumpers) | 4. NVRAM_CLR (Jumpers) |
| 5. LOM riser card | 6. Battery |
| 7. Riser slot 1A/Riser slot 1B | 8. Mini PERC |
| 9. System power 3 | 10. DIMMS for processor |
| 11. Fan 6 | 12. Fan 5 |
| 13. SATA_A/PCIE_A | 14. Fan 4 |
| 15. PCIE-B | 16. SATA_B/PCIE_C |
| 17. Processor | 18. PCIE-D |
| 19. Fan 3 | 20. PCIE-E |
| 21. PCIE-F | 22. Fan 2 |
| 23. Left control panel | 24. Front backplane signal 1 |
| 25. Intrusion switch | 26. Internal USB 3.0 |
| 27. System power 1 | 28. System power 2 |
| 29. PIB signal 2 | 30. PIB signal 1 |
| 31. IDSDM | 32. Rear backplane/ ODD power |





33. Front backplane signal 0
35. TPM

34. DIMMS for processor
36. Front video

System board jumper settings

For information about resetting the password jumper to disable a password, see the [Disabling a forgotten password](#) section.

Table 21. System board jumper settings

Jumper	Setting	Description
PWRD_EN	 (default)	The BIOS password feature is enabled.
		The BIOS password feature is disabled. The BIOS password is now disabled and you are not allowed to set a new password.
NVRAM_CLR	 (default)	The BIOS configuration settings are retained at system boot.
		The BIOS configuration settings are cleared at system boot.

CAUTION: Be careful when changing the BIOS settings. The BIOS interface is designed for advanced users. Any change in the setting could prevent your system from starting correctly and you might have potential loss of data.

Disabling a forgotten password

The software security features of the system include a system password and a setup password. The password jumper enables or disables password features and clears any password(s) currently in use.

Prerequisites

CAUTION: Many repairs may only be done by a certified service technician. You should only perform troubleshooting and simple repairs as authorized in your product documentation, or as directed by the online or telephone service and support team. Damage due to servicing that is not authorized by Dell is not covered by your warranty. Read and follow the safety instructions that are shipped with your product.

Steps

1. Power off the system, and all the attached peripherals, and disconnect the system from the electrical outlet.
2. Remove the system cover.
3. Move the jumper on the system board from pins 2 and 4 to pins 4 and 6.
4. Replace the system cover.
 - NOTE:** The existing passwords are not disabled (erased) until the system boots with the jumper on pins 4 and 6. However, before you assign a new system and/or setup password, you must move the jumper back to pins 2 and 4.
 - NOTE:** If you assign a new system and/or setup password with the jumper on pins 4 and 6, the system disables the new password(s) the next time it boots.
5. Reconnect the system and all the attached peripherals.
6. Power off the system.
7. Remove the system cover.
8. Move the jumper on the system board from pins 4 and 6 to pins 2 and 4.
9. Replace the system cover.
10. Reconnect the system to the electrical outlet and power on the system, and all the attached peripherals.
11. Assign a new system and/or setup password.

System diagnostics and indicator codes

This section describes the diagnostic indicators on the system front panel that displays the system status during system startup.

Topics:

- Status LED indicators
- System health and system ID indicator codes
- iDRAC Quick Sync 2 indicator codes
- iDRAC Direct LED indicator codes
- LCD panel
- NIC indicator codes
- Power supply unit indicator codes
- Drive indicator codes
- Using system diagnostics

Status LED indicators

 **NOTE:** The indicators display solid amber if any error occurs.

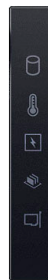

Figure 132. Status LED indicators

Table 22. Status LED indicators and descriptions





Icon	Description	Condition	Corrective action
	Drive indicator	The indicator turns solid amber if there is a drive error.	<ul style="list-style-type: none"> • Check the System Event Log to determine if the drive has an error. • Run the appropriate Online Diagnostics test. Restart the system and run embedded diagnostics (ePSA). • If the drives are configured in a RAID array, restart the system, and enter the host adapter configuration utility program.
	Temperature indicator	The indicator turns solid amber if the system experiences a thermal error (for example, the ambient temperature is out of range or there is a fan failure).	<p>Ensure that none of the following conditions exist:</p> <ul style="list-style-type: none"> • A cooling fan has been removed or has failed. • System cover, air shroud, or back filler bracket is removed. • Ambient temperature is too high. • External airflow is obstructed. <p>If the problem persists, see the Getting help section.</p>

Table 22. Status LED indicators and descriptions (continued)

Icon	Description	Condition	Corrective action
	Electrical indicator	The indicator turns solid amber if the system experiences an electrical error (for example, voltage out of range, or a failed power supply unit (PSU) or voltage regulator).	Check the System Event Log or system messages for the specific issue. If it is due to a problem with the PSU, check the LED on the PSU. Reseat the PSU. If the problem persists, see the Getting help section.
	Memory indicator	The indicator turns solid amber if a memory error occurs.	Check the System Event Log or system messages for the location of the failed memory. Reseat the memory module. If the problem persists, see the Getting help section.
	PCIe indicator	The indicator turns solid amber if a PCIe card experiences an error.	Restart the system. Update any required drivers for the PCIe card. Reinstall the card. If the problem persists, see the Getting help section. NOTE: For more information about the supported PCIe cards, see the Expansion card installation guidelines section.

System health and system ID indicator codes

The system health and system ID indicator is located on the left control panel of the system.



Figure 133. System health and system ID indicator

Table 23. System health and system ID indicator codes

System health and system ID indicator code	Condition
Solid blue	Indicates that the system is powered on, is healthy, and system ID mode is not active. Press the system health and system ID button to switch to system ID mode.
Blinking blue	Indicates that the system ID mode is active. Press the system health and system ID button to switch to system health mode.
Solid amber	Indicates that the system is in fail-safe mode. If the problem persists, see the Getting help section.
Blinking amber	Indicates that the system is experiencing a fault. Check the System Event Log for specific error messages. For information about the event and error messages generated by the system firmware and agents that monitor system components, go to qrl.dell.com > Look Up > Error Code , type the error code, and then click Look it up .

iDRAC Quick Sync 2 indicator codes

iDRAC Quick Sync 2 module (optional) is located on the left control panel of the system.



Table 24. iDRAC Quick Sync 2 indicators and descriptions

iDRAC Quick Sync 2 indicator code	Condition	Corrective action
Off (default state)	Indicates that the iDRAC Quick Sync 2 feature is powered off. Press the iDRAC Quick Sync 2 button to power on the iDRAC Quick Sync 2 feature.	If the LED fails to power on, reseal the left control panel flex cable and check. If the problem persists, see the Getting help section.
Solid white	Indicates that iDRAC Quick Sync 2 is ready to communicate. Press the iDRAC Quick Sync 2 button to power off.	If the LED fails to power off, restart the system. If the problem persists, see the Getting help section.
Blinks white rapidly	Indicates data transfer activity.	If the indicator continues to blink indefinitely, see the Getting help section.
Blinks white slowly	Indicates that firmware update is in progress.	If the indicator continues to blink indefinitely, see the Getting help section.
Blinks white five times rapidly and then powers off	Indicates that the iDRAC Quick Sync 2 feature is disabled.	Check if iDRAC Quick Sync 2 feature is configured to be disabled by iDRAC. If the problem persists, see the Getting help section. www.dell.com/poweredgemanuals or <i>Dell OpenManage Server Administrator User's Guide</i> at https://www.dell.com/openmanagemanuals .
Solid amber	Indicates that the system is in fail-safe mode.	Restart the system. If the problem persists, see the Getting help section.
Blinking amber	Indicates that the iDRAC Quick Sync 2 hardware is not responding properly.	Restart the system. If the problem persists, see the Getting help section.

iDRAC Direct LED indicator codes

The iDRAC Direct LED indicator lights up to indicate that the port is connected and is being used as a part of the iDRAC subsystem.

You can configure iDRAC Direct by using a USB to micro USB (type AB) cable, which you can connect to your laptop or tablet. Cable length should not exceed 3 feet (0.91 meters). Performance could be affected by cable quality. The following table describes iDRAC Direct activity when the iDRAC Direct port is active:

Table 25. iDRAC Direct LED indicator codes

iDRAC Direct LED indicator code	Condition
Solid green for two seconds	Indicates that the laptop or tablet is connected.
Blinking green (on for two seconds and off for two seconds)	Indicates that the laptop or tablet connected is recognized.
Powers off	Indicates that the laptop or tablet is unplugged.

LCD panel

The LCD panel provides system information, status, and error messages to indicate if the system is functioning correctly or requires attention. The LCD panel is used to configure or view the iDRAC IP address of the system. For information about the event and error messages generated by the system firmware and agents that monitor system components, go to qrl.dell.com > **Look Up** > **Error Code**, type the error code, and then click **Look it up**.

The LCD panel is available only on the optional front bezel. The optional front bezel is hot pluggable.

The status and conditions of the LCD panel are outlined here:

- The LCD backlight is white during normal operating conditions.
- If there is an issue, the LCD backlight turns amber and displays an error code followed by descriptive text.
 - ⓘ **NOTE:** If the system is connected to a power source and an error is detected, the LCD turns amber regardless of whether the system is powered on or off.
- When the system powers off and there are no errors, the LCD enters the standby mode after five minutes of inactivity. Press any button on the LCD to power it on.
- If the LCD panel stops responding, remove the bezel and reinstall it.
 - If the problem persists, see [Getting help](#).
- The LCD backlight remains off if LCD messaging is powered off using the iDRAC utility, the LCD panel, or other tools.

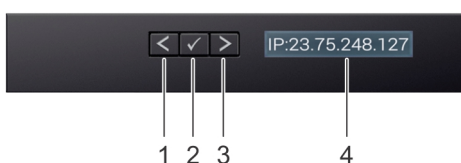

Figure 134. LCD panel features



Table 26. LCD panel features

Item	Button or display	Description
1	Left	Moves the cursor back in one-step increments.
2	Select	Selects the menu item highlighted by the cursor.
3	Right	Moves the cursor forward in one-step increments. During message scrolling: <ul style="list-style-type: none"> • Press and hold the right button to increase scrolling speed. • Release the button to stop. ⓘ NOTE: The display stops scrolling when the button is released. After 45 seconds of inactivity, the display starts scrolling.
4	LCD display	Displays the system information, status, and error messages or iDRAC IP address.

Viewing Home screen

The **Home** screen displays user-configurable information about the system. This screen is displayed during normal system operation when there are no status messages or errors. When the system turns off and there are no errors, LCD enters the standby mode after five minutes of inactivity. Press any button on the LCD to turn it on.

Steps

1. To view the **Home** screen, press one of the three navigation buttons (Select, Left, or Right).
2. To navigate to the **Home** screen from another menu, complete the following steps:
 - a. Press and hold the navigation button till the up arrow  is displayed.
 - b. Navigate to the **Home** icon  using the up arrow .

- c. Select the **Home** icon.
- d. On the **Home** screen, press the **Select** button to enter the main menu.

Setup menu

NOTE: When you select an option in the Setup menu, you must confirm the option before proceeding to the next action.

Table 27. Setup menu

Option	Description
iDRAC	Select DHCP or Static IP to configure the network mode. If Static IP is selected, the available fields are IP , Subnet (Sub) , and Gateway (Gtw) . Select Setup DNS to enable DNS and to view domain addresses. Two separate DNS entries are available.
Set error	Select SEL to view LCD error messages in a format that matches the IPMI description in the SEL. This enables you to match an LCD message with an SEL entry. Select Simple to view LCD error messages in a simplified user-friendly description. For information about the event and error messages generated by the system firmware and agents that monitor system components, go to qrl.dell.com > Look Up > Error Code , type the error code, and then click Look it up..
Set home	Select the default information to be displayed on the Home screen. See View menu section for the options and option items that can be set as the default on the Home screen.

View menu

NOTE: When you select an option in the View menu, you must confirm the option before proceeding to the next action.

Table 28. View menu

Option	Description
iDRAC IP	Displays the IPv4 or IPv6 addresses for iDRAC9. Addresses include DNS (Primary and Secondary) , Gateway , IP , and Subnet (IPv6 does not have Subnet).
MAC	Displays the MAC addresses for iDRAC , iSCSI , or Network devices.
Name	Displays the name of the Host , Model , or User String for the system.
Number	Displays the Asset tag or the Service tag for the system.
Power	Displays the power output of the system in BTU/hr or Watts. The display format can be configured in the Set home submenu of the Setup menu.
Temperature	Displays the temperature of the system in Celsius or Fahrenheit. The display format can be configured in the Set home submenu of the Setup menu.

NIC indicator codes

Each NIC on the back of the system has indicators that provide information about the activity and link status. The activity LED indicator indicates if data is flowing through the NIC, and the link LED indicator indicates the speed of the connected network.

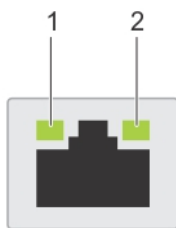

Figure 135. NIC indicator codes

1. Link LED indicator
2. Activity LED indicator

Table 29. NIC indicator codes

NIC indicator codes	Condition
Link and activity indicators are off.	Indicates that the NIC is not connected to the network.
Link indicator is green, and activity indicator is blinking green.	Indicates that the NIC is connected to a valid network at its maximum port speed, and data is being sent or received.
Link indicator is amber, and activity indicator is blinking green.	Indicates that the NIC is connected to a valid network at less than its maximum port speed, and data is being sent or received.
Link indicator is green, and activity indicator is off.	Indicates that the NIC is connected to a valid network at its maximum port speed, and data is not being sent or received.
Link indicator is amber, and activity indicator is off.	Indicates that the NIC is connected to a valid network at less than its maximum port speed, and data is not being sent or received.
Link indicator is blinking green, and activity is off.	Indicates that the NIC identify is enabled through the NIC configuration utility.

Power supply unit indicator codes

AC power supply units (PSUs) have an illuminated translucent handle that serves as an indicator. The indicator shows if power is present or if a power fault has occurred.

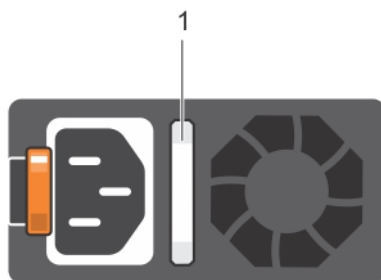

Figure 136. AC PSU status indicator

1. AC PSU status indicator/handle

Table 30. AC PSU status indicator codes

Power indicator codes	Condition
Green	Indicates that a valid power source is connected to the PSU and the PSU is operational.
Blinking amber	Indicates an issue with the PSU.

Table 30. AC PSU status indicator codes (continued)

Power indicator codes	Condition
Not powered on	Indicates that the power is not connected to the PSU.
Blinking green	Indicates that the firmware of the PSU is being updated. ⚠ CAUTION: Do not disconnect the power cord or unplug the PSU when updating firmware. If firmware update is interrupted, the PSUs do not function.
Blinking green and powers off	When hot-plugging a PSU, it blinks green five times at a rate of 4 Hz and powers off. This indicates a PSU mismatch due to efficiency, feature set, health status, or supported voltage. ⚠ CAUTION: If two PSUs are installed, both the PSUs must have the same type of label; for example, Extended Power Performance (EPP) label. Mixing PSUs from previous generations of PowerEdge servers is not supported, even if the PSUs have the same power rating. This results in a PSU mismatch condition or failure to power on the system. ⚠ CAUTION: If two PSUs are used, they must be of the same type and have the same maximum output power. ⚠ CAUTION: When correcting a PSU mismatch, replace the PSU with the blinking indicator. Swapping the PSU to make a matched pair can result in an error condition and an unexpected system shutdown. To change from a high output configuration to a low output configuration or vice versa, you must power off the system. ⚠ CAUTION: AC PSUs support both 240 V and 120 V input voltages with the exception of Titanium PSUs, which support only 240 V. When two identical PSUs receive different input voltages, they can output different wattages, and trigger a mismatch.

Drive indicator codes

The LEDs on the drive carrier indicates the state of each drive. Each drive carrier has two LEDs: an activity LED (green) and a status LED (bicolor, green/amber). The activity LED blinks whenever the drive is accessed.



Figure 137. Drive indicators on the drive and the mid drive tray backplane

1. Drive activity LED indicator
2. Drive status LED indicator
3. Drive capacity label

ⓘ NOTE: If the drive is in the Advanced Host Controller Interface (AHCI) mode, the status LED indicator does not power on.

ⓘ NOTE: Drive status indicator behavior is managed by Storage Spaces Direct. Not all drive status indicators may be used.

Table 31. Drive indicator codes

Drive status indicator code	Condition
Blinks green twice per second	Indicates that the drive is being identified or preparing for removal.
Off	Indicates that the drive is ready for removal. i NOTE: The drive status indicator remains off until all drives are initialized after the system is powered on. Drives are not ready for removal during this time.
Blinks green, amber, and then powers off	Indicates that there is an expected drive failure.
Blinks amber four times per second	Indicates that the drive has failed.
Blinks green slowly	Indicates that the drive is rebuilding.
Solid green	Indicates that the drive is online.
Blinks green for three seconds, amber for three seconds, and then powers off after six seconds	Indicates that the rebuild has stopped.

Using system diagnostics

If you experience an issue with the system, run the system diagnostics before contacting Dell for technical assistance. The purpose of running system diagnostics is to test the system hardware without using additional equipment or risking data loss. If you are unable to fix the issue yourself, service and support personnel can use the diagnostics results to help you solve the issue.

Dell Embedded System Diagnostics

i **NOTE:** The Dell Embedded System Diagnostics is also known as Enhanced Pre-boot System Assessment (ePSA) diagnostics.

The Embedded System Diagnostics provide a set of options for particular device groups or devices allowing you to:

- Run tests automatically or in an interactive mode
- Repeat tests
- Display or save test results
- Run thorough tests to introduce additional test options to provide extra information about the failed device(s)
- View status messages that inform you if tests are completed successfully
- View error messages that inform you of issues encountered during testing

Running the Embedded System Diagnostics from the Dell Lifecycle Controller

Steps

1. As the system boots, press F10.
2. Select **Hardware Diagnostics** → **Run Hardware Diagnostics**.
The **ePSA Pre-boot System Assessment** window is displayed, listing all devices detected in the system. The diagnostics starts executing the tests on all the detected devices.

Running the Embedded System Diagnostics from Boot Manager

Run the Embedded System Diagnostics (ePSA) if your system does not boot.

Steps

1. When the system is booting, press F11.
2. Use the up arrow and down arrow keys to select **System Utilities** > **Launch Diagnostics**.

- Alternatively, when the system is booting, press F10, select **Hardware Diagnostics > Run Hardware Diagnostics**. The **ePSA Pre-boot System Assessment** window is displayed, listing all devices detected in the system. The diagnostics starts executing the tests on all the detected devices.

Results

System diagnostic controls

Table 32. System diagnostic controls

Menu	Description
Configuration	Displays the configuration and status information of all detected devices.
Results	Displays the results of all tests that are run.
System health	Provides the current overview of the system performance.
Event log	Displays a time-stamped log of the results of all tests run on the system. This is displayed if at least one event description is recorded.

Known Issue

AMD ROME Erratum 1474

Issue:

- A core may hang after about 1044 days due to failure of exiting CC6 after about 1044 days after the last system reset. The time of failure may vary depending on the spread spectrum and REFCLK frequency.

Workaround:

- Option 1: Disable CC6 by writing 0x80808 to CSTATE_CONFIG (MSR 0xC001_0296) to all cores or by setting '0' for PcdAMDCStateMode before the projected time of failure.
- Option 2: Reboot the system before the projected time of failure.

Fix planned:

- No fix planned.

Getting help

Topics:

- [Recycling or End-of-Life service information](#)
- [Contacting Dell](#)
- [Accessing system information by using QRL](#)
- [Receiving automated support with SupportAssist](#)

Recycling or End-of-Life service information

Take back and recycling services are offered for this product in certain countries. If you want to dispose of system components, visit www.dell.com/recyclingworldwide and select the relevant country.

Contacting Dell

Dell provides online and telephone based support and service options. If you do not have an active internet connection, you can find Dell contact information on your purchase invoice, packing slip, bill or Dell product catalog. The availability of services varies depending on the country and product, and some services may not be available in your area. To contact Dell for sales, technical assistance, or customer service issues:

Steps

1. Go to www.dell.com/support/home.
2. Select your country from the drop-down menu on the lower right corner of the page.
3. For customized support:
 - a. Enter the system Service Tag in the **Enter a Service Tag, Serial Number, Service Request, Model, or Keyword** field.
 - b. Click **Submit**.
The support page that lists the various support categories is displayed.
4. For general support:
 - a. Select your product category.
 - b. Select your product segment.
 - c. Select your product.
The support page that lists the various support categories is displayed.
5. For contact details of Dell Global Technical Support:
 - a. Click [Contact Technical Support](#).
 - b. The **Contact Technical Support** page is displayed with details to call, chat, or e-mail the Dell Global Technical Support team.

Accessing system information by using QRL

You can use the Quick Resource Locator (QRL) located on the information tag in the front of the R7515 system, to access information about Dell EMC PowerEdge R7515. There is also another QRL for accessing product information located on the top of the system cover.

Prerequisites

Ensure that your smartphone or tablet has the QR code scanner installed.

The QRL includes the following information about your system:

- How-to videos
- Reference materials, including the Installation and Service Manual, LCD diagnostics, and mechanical overview
- The system service tag to quickly access the specific hardware configuration and warranty information
- A direct link to Dell to contact technical assistance and sales teams

Steps

1. Go to www.dell.com/qrl, and navigate to your specific product or
2. Use your smart phone or tablet to scan the model-specific Quick Resource (QR) code on your system or in the Quick Resource Locator section.

Quick Resource Locator for PowerEdge R7515 system



Figure 138. Quick Resource Locator for PowerEdge R7515 system

Receiving automated support with SupportAssist

Dell EMC SupportAssist is an optional Dell EMC Services offering that automates technical support for your Dell EMC server, storage, and networking devices. By installing and setting up a SupportAssist application in your IT environment, you can receive the following benefits:

- Automated issue detection — SupportAssist monitors your Dell EMC devices and automatically detects hardware issues, both proactively and predictively.
- Automated case creation — When an issue is detected, SupportAssist automatically opens a support case with Dell EMC Technical Support.
- Automated diagnostic collection — SupportAssist automatically collects system state information from your devices and uploads it securely to Dell EMC. This information is used by Dell EMC Technical Support to troubleshoot the issue.
- Proactive contact — A Dell EMC Technical Support agent contacts you about the support case and helps you resolve the issue.

The available benefits vary depending on the Dell EMC Service entitlement purchased for your device. For more information about SupportAssist, go to www.dell.com/supportassist.

Documentation resources

This section provides information about the documentation resources for your system.

To view the document that is listed in the documentation resources table:

- From the Dell EMC support site:
 1. Click the documentation link that is provided in the Location column in the table.
 2. Click the required product or product version.
-  **NOTE:** To locate the product name and model, see the front of your system.
- On the Product Support page, click **Manuals & documents**.
- Using search engines:
 - Type the name and version of the document in the search box.

Table 33. Additional documentation resources for your system

Task	Document	Location
Setting up your system	<p>For more information about installing and securing the system into a rack, see the Rail Installation Guide included with your rail solution.</p> <p>For information about setting up your system, see the <i>Getting Started Guide</i> document that is shipped with your system.</p>	www.dell.com/poweredgemanuals
Configuring your system	<p>For information about the iDRAC features, configuring and logging in to iDRAC, and managing your system remotely, see the Integrated Dell Remote Access Controller User's Guide.</p> <p>For information about understanding Remote Access Controller Admin (RACADM) subcommands and supported RACADM interfaces, see the RACADM CLI Guide for iDRAC.</p> <p>For information about Redfish and its protocol, supported schema, and Redfish Eventing implemented in iDRAC, see the Redfish API Guide.</p> <p>For information about iDRAC property database group and object descriptions, see the Attribute Registry Guide.</p> <p>For information about Intel QuickAssist Technology, see the Integrated Dell Remote Access Controller User's Guide.</p>	www.dell.com/poweredgemanuals

Table 33. Additional documentation resources for your system (continued)

Task	Document	Location
	<p>For information about earlier versions of the iDRAC documents.</p> <p>To identify the version of iDRAC available on your system, on the iDRAC web interface, click ? > About.</p>	<p>www.dell.com/idracmanuals</p>
	<p>For information about installing the operating system, see the operating system documentation.</p>	<p>www.dell.com/operatingsystemmanuals</p>
	<p>For information about updating drivers and firmware, see the Methods to download firmware and drivers section in this document.</p>	<p>www.dell.com/support/drivers</p>
<p>Managing your system</p>	<p>For information about systems management software offered by Dell, see the Dell OpenManage Systems Management Overview Guide.</p>	<p>www.dell.com/poweredgemanuals</p>
	<p>For information about setting up, using, and troubleshooting OpenManage, see the Dell OpenManage Server Administrator User's Guide.</p>	<p>www.dell.com/openmanagemanuals > OpenManage Server Administrator</p>
	<p>For information about installing and using Dell SupportAssist, see the Dell EMC SupportAssist Enterprise User's Guide.</p>	<p>https://www.dell.com/serviceabilitytools</p>
	<p>For information about partner programs enterprise systems management, see the OpenManage Connections Enterprise Systems Management documents.</p>	<p>www.dell.com/openmanagemanuals</p>
	<p>Understanding event and error messages</p>	<p>For information about the event and error messages generated by the system firmware and agents that monitor system components, go to qrl.dell.com > Look Up > Error Code, type the error code, and then click Look it up.</p>
<p>Troubleshooting your system</p>	<p>For information about identifying and troubleshooting the PowerEdge server issues, see the Server Troubleshooting Guide.</p>	<p>www.dell.com/poweredgemanuals</p>

www.dell.com/qrl