

# Dell Display Manager for Windows

Version 2.2

User's Guide





**NOTE:** A NOTE indicates important information that helps you make better use of your computer.

**© 2022-2023 Dell Inc. or its subsidiaries. All rights reserved.** Dell Technologies, Dell, and other trademarks are trademarks of Dell Inc. or its subsidiaries. Other trademarks may be trademarks of their respective owners.

2023 - 09

Rev. A02

# Contents

<b>Overview</b> . . . . .	<b>6</b>
System requirements . . . . .	6
<b>Downloading and setting up the DDM 2.2</b> . . . . .	<b>7</b>
Downloading the DDM 2.2 . . . . .	7
Connecting the monitor to your computer . . . . .	7
<b>Before launching the DDM 2.2</b> . . . . .	<b>8</b>
<b>Launching DDM 2.2</b> . . . . .	<b>9</b>
Menu Launcher . . . . .	9
<b>Main menu</b> . . . . .	<b>16</b>
<b>Adjusting the brightness and contrast</b> . . . . .	<b>18</b>
Setting the schedule for brightness and contrast . . . . .	19
Setting the Auto function for brightness and contrast . . . . .	20
Assigning shortcut keys . . . . .	22
<b>Managing multiple video inputs</b> . . . . .	<b>23</b>
Configuring the PIP/PBP mode . . . . .	24
Assigning shortcut keys . . . . .	26
<b>Setting the monitor color preset mode</b> . . . . .	<b>28</b>
Auto change color preset when using specific application . . . . .	29
<b>Color management</b> . . . . .	<b>31</b>
Automatically adjust the ICC color profile based on color preset . . . . .	32



Automatically adjust the color based on ICC profile . . . .	32
Changing the ICC/ICM profile in Windows . . . . .	32
<b>Adjusting monitor display settings. . . . .</b>	<b>33</b>
<b>Organizing windows with Easy Arrange . . . . .</b>	<b>34</b>
Layout. . . . .	34
Customized layout . . . . .	35
Easy Memory . . . . .	39
Settings . . . . .	41
<b>Using the Application Window Snap . . . . .</b>	<b>43</b>
<b>Configuring the gaming settings . . . . .</b>	<b>46</b>
<b>Setting up the KVM . . . . .</b>	<b>48</b>
Changing KVM configuration . . . . .	51
<b>Personalize settings. . . . .</b>	<b>54</b>
Changing Menu Launcher configuration . . . . .	54
Changing Launch DDM Hotkey configuration . . . . .	55
<b>Applying energy conservation features . . . . .</b>	<b>56</b>
<b>Resetting monitor settings. . . . .</b>	<b>57</b>
<b>Import/Export application settings . . . . .</b>	<b>58</b>
<b>Additional settings . . . . .</b>	<b>62</b>
<b>Help . . . . .</b>	<b>64</b>
<b>Troubleshooting . . . . .</b>	<b>65</b>
Understand the different states of DDM 2.2 . . . . .	65
Dell monitors not supported by DDM 2.2 . . . . .	66
Unable to detect supported Dell monitor. . . . .	66
Compatibility between DDM 1.x and DDM 2.2 . . . . .	66
Getting more information on troubleshooting . . . . .	67



**Improve DDM 2.2 . . . . . 68**  
**Updating DDM 2.2 software and monitor  
firmware . . . . . 69**  
    **Updating the monitor firmware . . . . . 70**



# Overview

Dell Display Manager 2.2 (DDM 2.2) is a Windows application used to manage a monitor or a group of monitors.

DDM 2.2 allows you to configure the monitor settings, control power settings, organize applications in different screen layouts, and other functions on supported Dell monitors.

After installing DDM 2.2, it runs each time you restart your computer. A quick access icon is available in the system taskbar, with information about connected monitors available when you hover your cursor over the DDM icon.

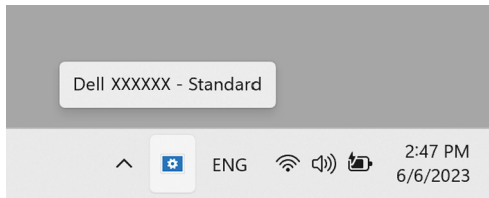

## System requirements

DDM 2.2 supports the following x86-based Windows:

- Windows 10 build 17763 and above
- Windows 11

 **NOTE:** Certain functions are hardware dependent. Refer to your monitor user guide for information about the functions that are available.

 **NOTE:** Screenshots in this document are for illustrative purposes only. Some functions may not be supported by your monitor.



# Downloading and setting up the DDM 2.2

## Downloading the DDM 2.2

1. Browse for your monitor model name, or type it in at <https://www.dell.com/support>.
2. Download the DDM 2.2 for Windows from the list of downloads, and install it on your computer.  
You can also visit <https://www.dell.com/support/ddm> and download the software from the site. The Dell support website detects the OS of the computer, and Dell Display Manager 2.2 download link will appear if you are browsing from a Windows OS computer. Alternatively, Windows OS can be selected from the Operating System drop-down list.

## Connecting the monitor to your computer

1. Connect the monitor to your computer by following the steps that are specified in the monitor user guide.

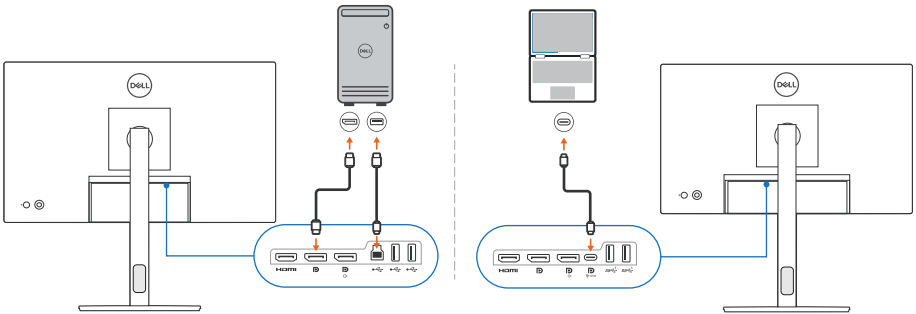



**NOTE:** The connectivity diagrams are for illustrative purposes only. Refer to your monitor user guide for the complete information.

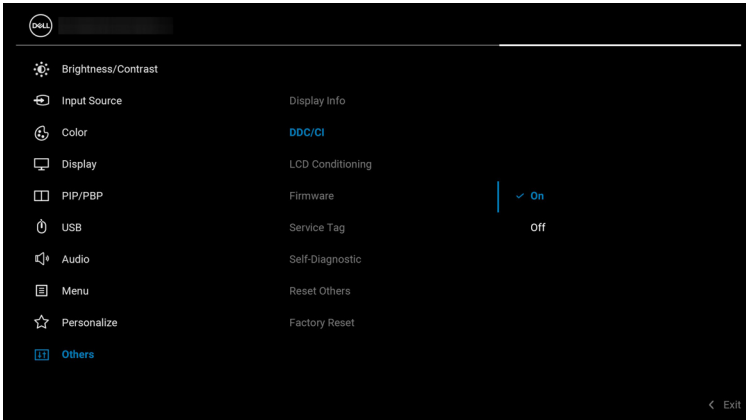

# Before launching the DDM 2.2

Before launching the DDM 2.2, select **Others** on the monitor's On-screen Display (OSD), and ensure that the **DDC/CI** function is set as **On**.



 **NOTE:** Only **Easy Arrange** is enabled if **DDC/CI** function is set as **Off**.





# Launching DDM 2.2

## Menu Launcher

Click the DDM 2.2 icon on the system taskbar to open the **Menu Launcher** box. When multiple Dell monitors are connected to the computer, you can select any monitor from the drop-down list to control the settings of the monitor. Alternatively, you can open the menu launcher from the program menu.

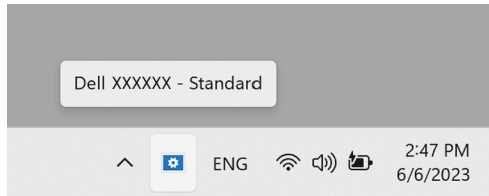

The **Menu Launcher** box provides quick access to the following commonly used functions:

- ◆ **Brightness/Contrast**
- ◆ **Color**
- ◆ **Display**
- ◆ **Easy Arrange**
- ◆ **KVM (optional)**
- ◆ **Gaming (optional)**



## Brightness/Contrast

Allows you to adjust the brightness and contrast (or luminance) level of the selected model. If you have multiple monitors, select the monitor from the drop-down list or move the dialog to the monitor you want to adjust.

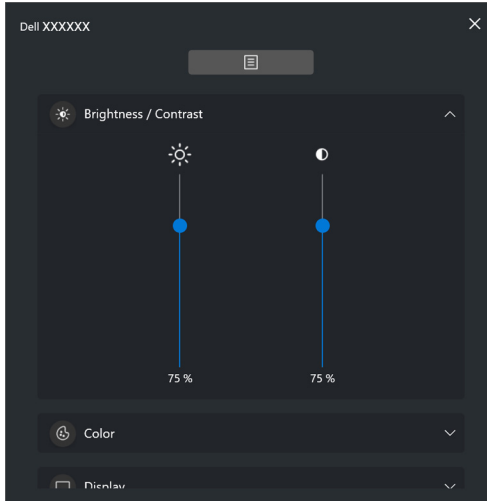

**NOTE:** The minimum value of contrast setting is set to 25% to maintain the visibility on the screen.

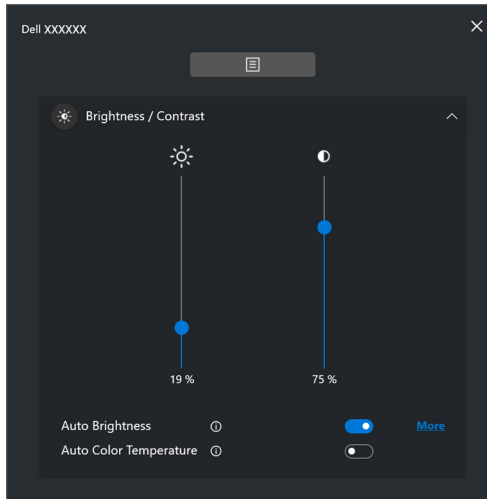



**NOTE:** The Auto function is available on monitors equipped with an ambient light sensor.

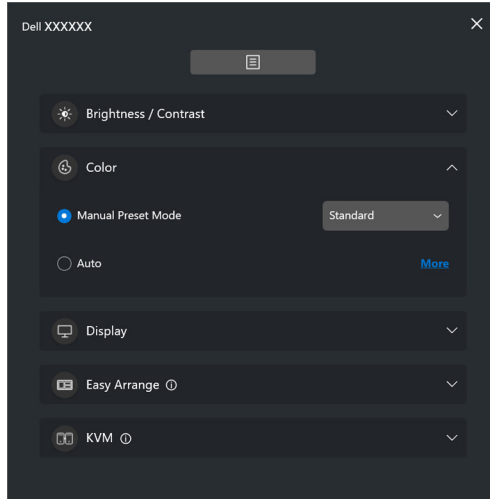

## Color

Change color preset to suit user preferences on the screen. For additional settings, click **More**.



 **NOTE:** For more information, refer to [Auto change color preset when using specific application.](#)



## Display

Allows you to adjust resolution and refresh rate of the selected monitor. For additional settings, click **More**.

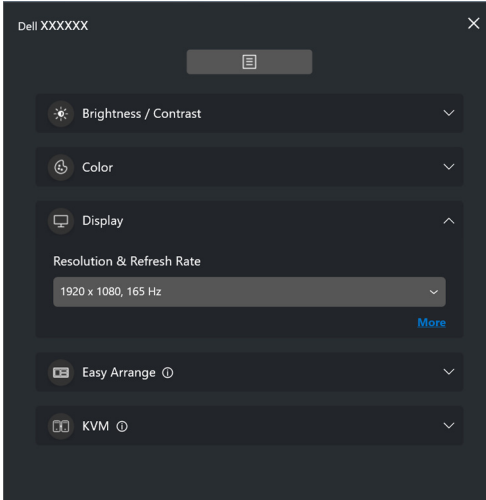

## Easy Arrange

A list of the recommended or recently used layouts and easy memory profiles are displayed for quick selection, as shown in the following image. The **Custom Layout** function allows you to save the current window arrangement on screen as a custom layout.

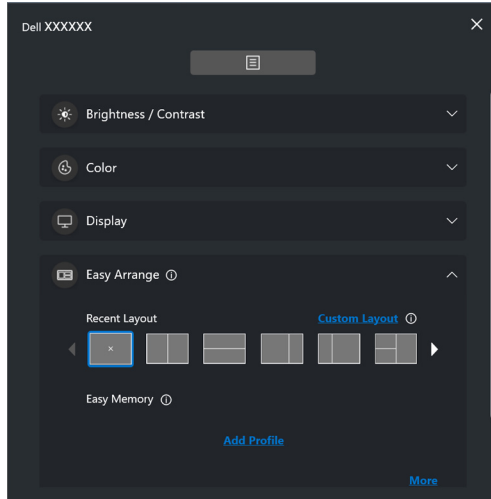

## KVM

After setting up the KVM, you can switch keyboard and mouse between computers. Refer to the section [Setting up the KVM](#) to use the **Setup wizard**.

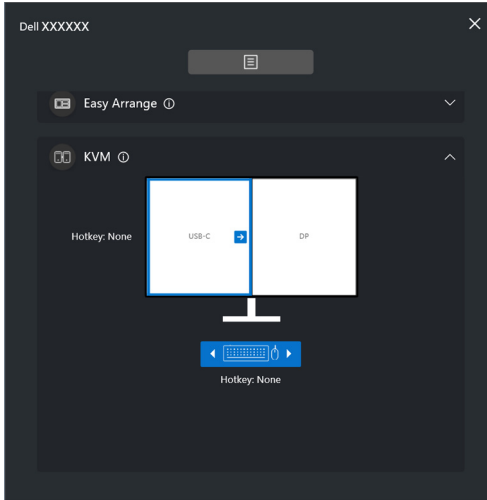

## Gaming

For the monitors that support vision engine, you can select and switch the Vision Engine modes from the **Gaming** function.

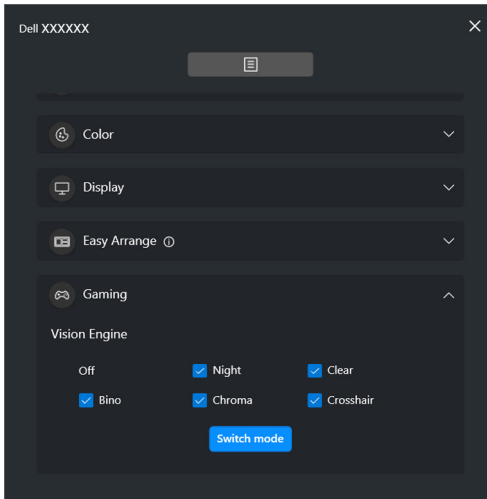

Feature	Function	Description
Quick access to DDM	Shortcut key to launch the Menu Launcher box	<ul style="list-style-type: none"> <li>• Configure your preferred hotkey (for example, <b>Alt+M</b>) to launch the <b>Menu Launcher</b>.</li> <li>• To customize your preferred hotkey, select <b>Personalize</b>.</li> </ul>
	Select the monitor when multiple monitors are connected or drag the UI to the monitor you want to control	<ul style="list-style-type: none"> <li>• If you have more than one monitor connected, you can select the monitor from the drop-down list or simply drag the UI to the monitor you want to control.</li> <li>• When the monitor is selected, the monitor icon with the model name appears on the respective monitor screen to indicate the selected monitor.</li> <li>• Press <b>Alt+M</b> to bring up the <b>Menu Launcher</b> of the monitor where the mouse pointer is placed.</li> <li>• If you have more than one monitor connected, press the configured hotkey for a selected monitor where the mouse pointer is positioned.</li> </ul>



# Main menu

Launch DDM 2.2 by one of the following methods:

- On the system taskbar, right-click the **DDM** icon, and select **Open Dell Display Manager**.

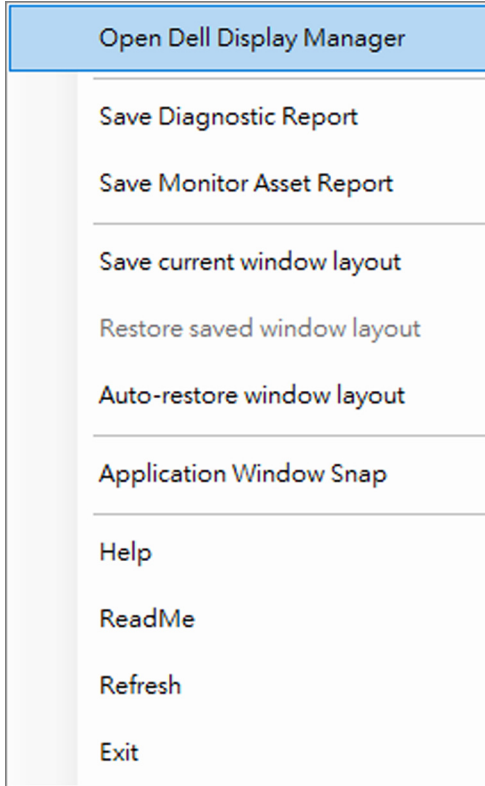



- Click the **DDM** icon from the **Menu Launcher** box.

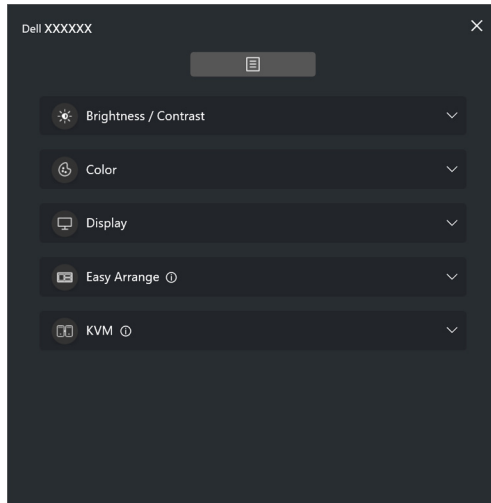

The menu system provides a set of menu and submenu to adjust the DDM 2.2 functions.

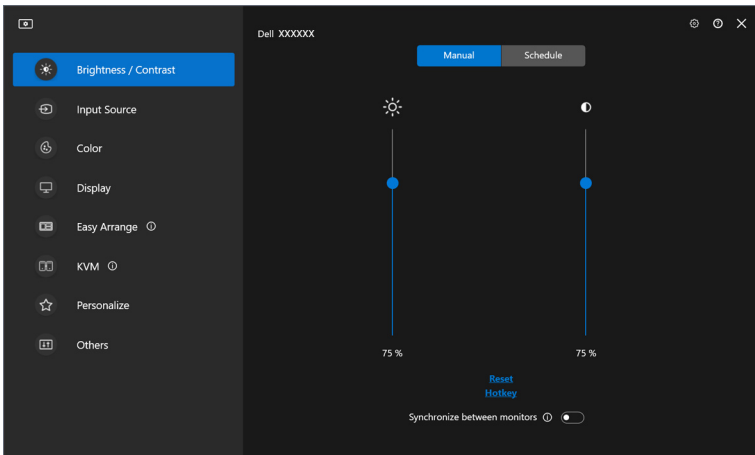

# Adjusting the brightness and contrast

On the DDM 2.2 menu, select **Brightness/Contrast** to change the brightness and contrast levels.

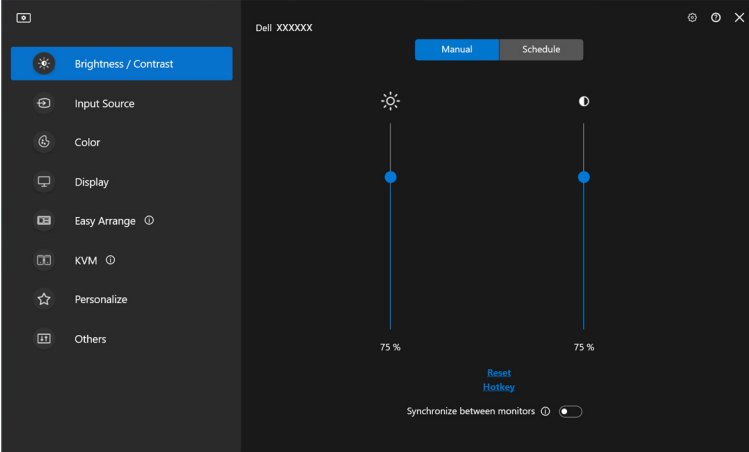

Feature	Function	Description
Brightness/ Contrast	Manual	Adjust the brightness and contrast of the monitor manually.
	Schedule	Adjust the brightness and contrast gradually according to day/night profile that you have configured.
	Auto	<ul style="list-style-type: none"><li>Automatically adjust the brightness or color temperature by monitor ambient light sensor when corresponding option is enabled.</li><li>You can specify one primary monitor to sync brightness and/or color temperature to other monitors.</li></ul>
	Hotkey	Assign shortcut key to adjust brightness and contrast.
	Synchronize between monitors	Enable this function to apply the brightness, contrast, and color preset control to the connected monitors.



 **NOTE:** The synchronization of monitor control is available only when two or more monitors with the same brightness/contrast unit are connected.

 **NOTE:** The minimum value of contrast setting is set to 25% to maintain the visibility on the screen.

## Setting the schedule for brightness and contrast

Select the **Schedule** tab to set the brightness and contrast schedule according to day/night profile that you have configured.

1. Select the **Schedule** tab in the **Brightness/Contrast** menu. Adjust the brightness and contrast level by moving the sliders up or down. The default profile values follows the monitor current settings. Click **Settings** button to configure the profile timing or preview the profile transition effect.

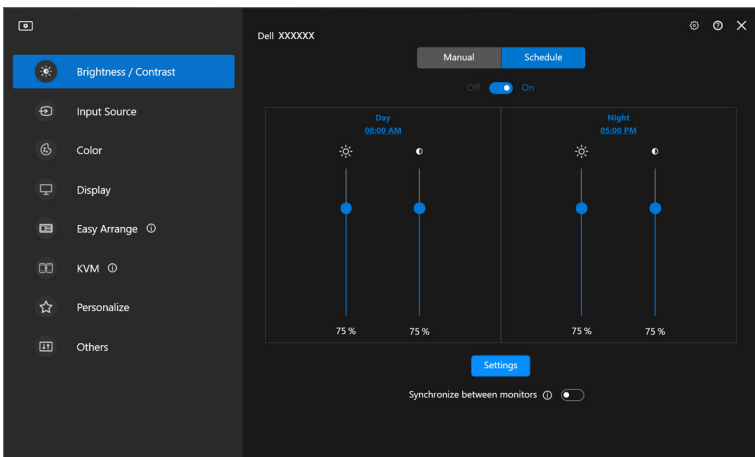

- Adjust the starting time and duration for **Day** and **Night** time. Click **Close** to save and exit the menu.

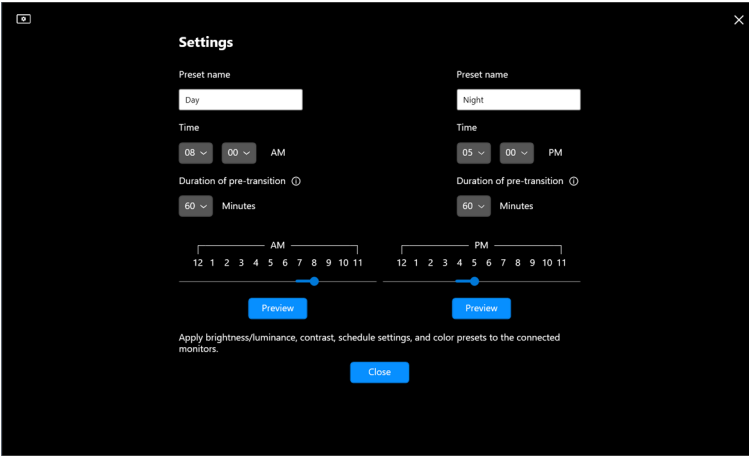

 **NOTE:** The schedule function is available on monitors that are not equipped with an ambient light sensor.

## Setting the Auto function for brightness and contrast

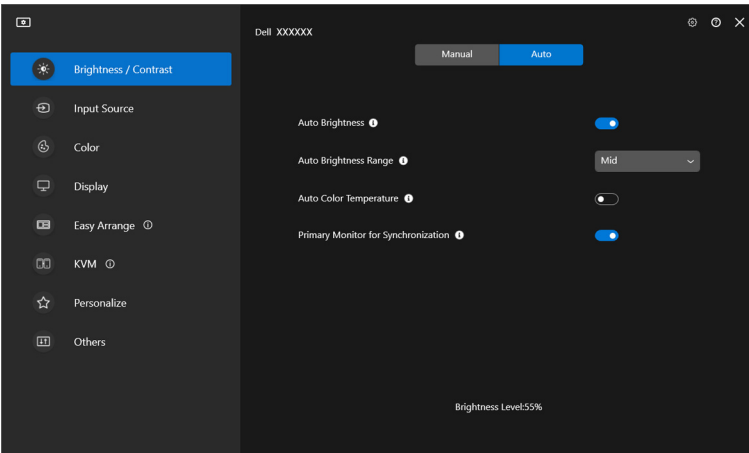

Feature	Function	Description
Auto	Auto Brightness	Turns on the <b>Auto Brightness</b> and the monitor Brightness setting automatically adjust according to the ambient light.
	Auto Brightness Range Level	When <b>Auto Brightness</b> is turned on, adjust the <b>Auto Brightness Range Level</b> of the <b>Auto Brightness</b> . <b>NOTE:</b> When <b>Auto Brightness</b> is turned off, this function is not available.
	Auto Color Temperature	Turns on <b>Auto Color Temperature</b> and the monitor RGB color settings automatically adjust according to the ambient light.
	Primary Monitor for Synchronization	Turns on <b>Primary Monitor for Synchronization</b> if you have multiple Dell monitors that support this function connected, and you want the other monitors to adjust their Brightness or RGB settings according to the ambient light condition detected by the primary monitor. <b>NOTE:</b> When <b>Auto Brightness</b> and <b>Auto Color Temperature</b> are both turned off, <b>Primary Monitor for Synchronization</b> is not available.

 **NOTE:** The Auto function is available on monitors equipped with an ambient light sensor.



## Assigning shortcut keys

Click **Hotkey** in the **Brightness/Contrast** menu, assign shortcut key to adjust brightness and contrast.

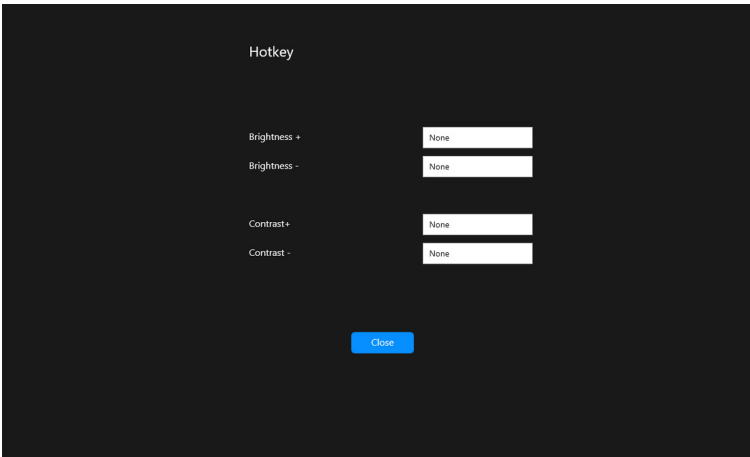

If multiple monitors are connected, the configured hotkeys will be synchronized across the monitors. To trigger the brightness/contrast or luminance adjustments, move the mouse over the desired monitor.



# Managing multiple video inputs

The **Input Source** menu allows you to manage multiple video inputs that are connected to your Dell monitor. This makes it easy to switch between inputs while you work on multiple computers.

Under **General**, all of the video input ports available on your monitor are displayed. You can assign each input a name and an USB upstream port.

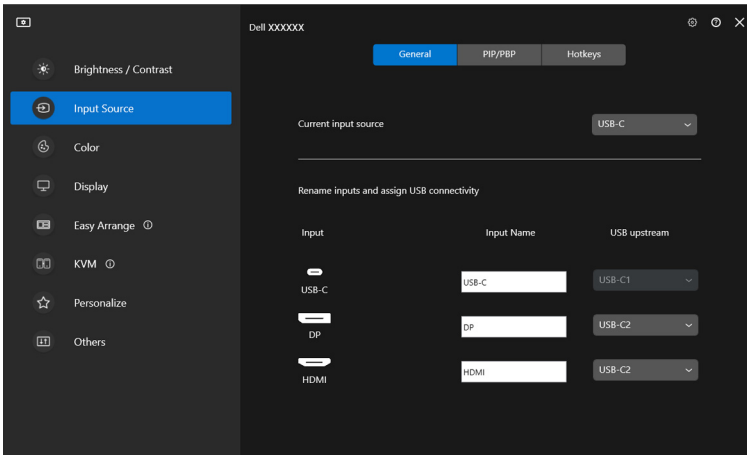

 **NOTE:** For more information, refer to your monitor user guide for the available inputs.



## Configuring the PIP/PBP mode

1. Click the **PIP/PBP** mode to enable the split screen function on the supported models.
2. Click **Toggle between positions** to change the PIP position.
3. From the **Input 1** drop-down list, select the main input, followed by selecting the sub-input from the **Input 2** drop-down list to change the main or sub inputs.
4. Click **USB Switch** to switch the USB upstream port that is associated with active input sources.

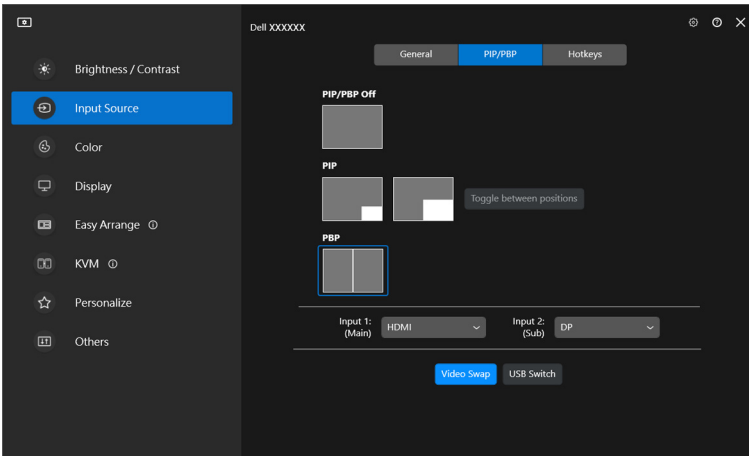



5. Click **Video Swap** to swap input sources.

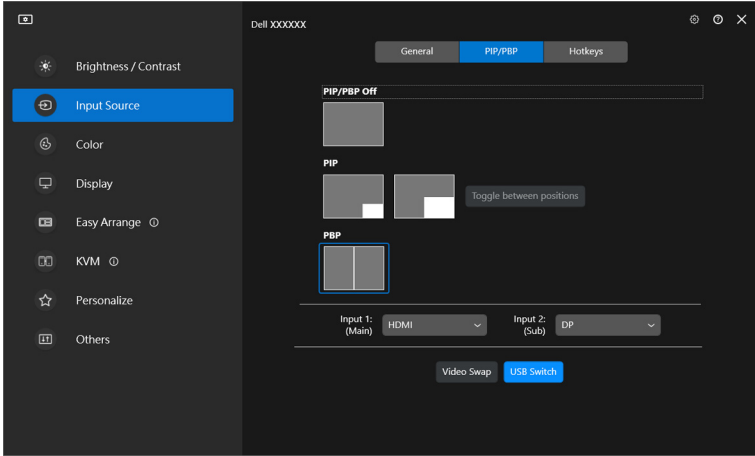

 **NOTE:** For more information, refer to your monitor user guide for the available PIP/PBP functions.



# Assigning shortcut keys

You can assign shortcut keys for quick access to the **Input Source** functions.

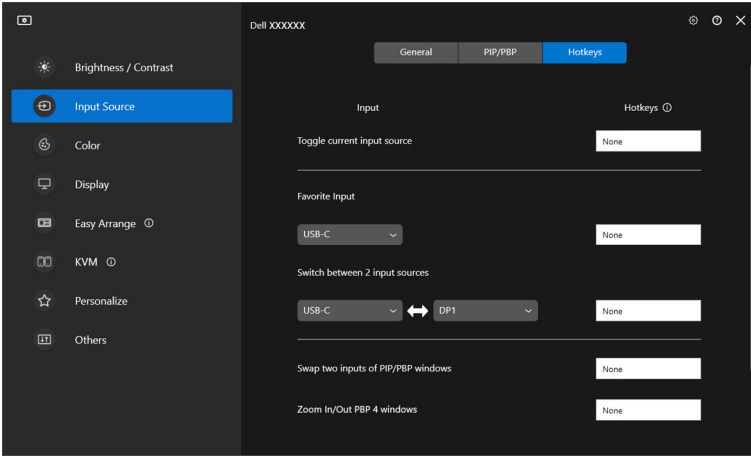

Alternatively, switch the input source from the **Current input source** drop-down list.

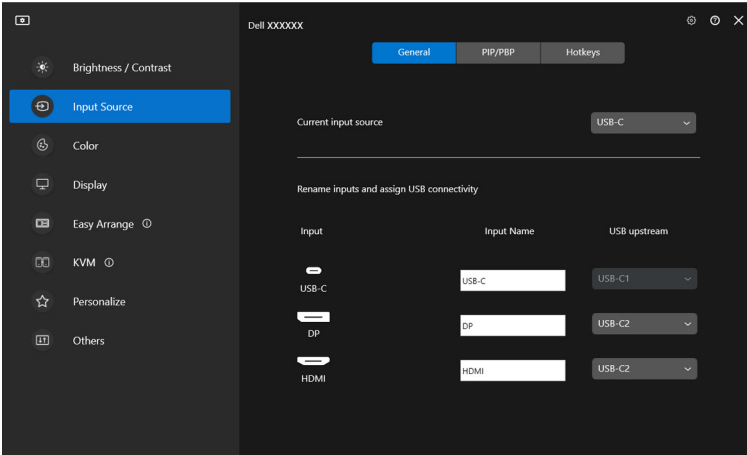

<b>Feature</b>	<b>Function</b>	<b>Description</b>
Hotkeys	Toggle current input source	Configure your preferred hotkey (for example, <b>Alt+C</b> ) to toggle the input sources.
	Favorite input	Configure your preferred hotkey to toggle to your favorite input source.
	Switch between 2 input sources	Configure your preferred hotkey (for example, <b>Alt+I</b> ) to toggle between the two frequently used input sources.
	Swap two inputs of PIP/PBP windows	Configure your preferred hotkey (for example, <b>Alt+W</b> ) to swap the PIP/PBP main and sub-input.
	Zoom In/Out PBP 4 windows	Configure your preferred hotkey (for example, <b>Alt+Z</b> ) to zoom in/out the PBP window.
	Change PIP position	Configure your preferred hotkey (for example, <b>Alt+Q</b> ) to change the position of PIP.
	UnderScan	Configure your preferred hotkey (for example, <b>Alt+A</b> ) to enable or disable underscan. <b>NOTE:</b> The underscan function is supported only on the following models: <ul style="list-style-type: none"> <li>◆ <b>Dell U4320Q</b></li> <li>◆ <b>Dell U4323QE</b></li> </ul>

 **NOTE:** For more information, refer to your monitor user guide for the available PIP/PBP functions.

 **NOTE:** If there are multiple monitors connected, the configured hotkeys will be synchronized across the monitors for ease of use. To trigger the function for the selected monitor, move the mouse to the monitor and press the hotkey.



# Setting the monitor color preset mode

The **Color** menu allows you to associate color preset mode with an application. When you select the **Auto Mode**, the DDM 2.2 automatically switches to the corresponding color preset mode whenever the associated application is activated. The color preset mode assigned to a particular application may be the same on each connected monitor, or it can vary from one monitor to another.

To add a new application to the assignment list, click **Add application** to select applications or drag it from the **Windows Programs/Desktop** and drop to the current list. Select the color preset mode from the drop-down list for each application to associate preset to the applications.

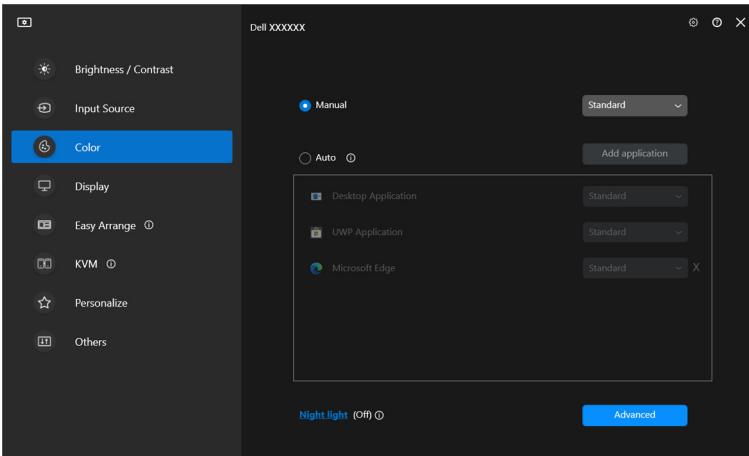

Feature	Function	Description
Color	Manual	Select the color preset mode manually from the user interface.
	Auto	<ul style="list-style-type: none"><li>• Enable this function to activate the color preset mode automatically when the associated application is selected as the active window.</li><li>• Click the drop-down list to assign a preset mode to an application.</li></ul>
	Night light	Change the night light setting.



# Auto change color preset when using specific application

1. Select **Auto**.
2. Click **Add application**.

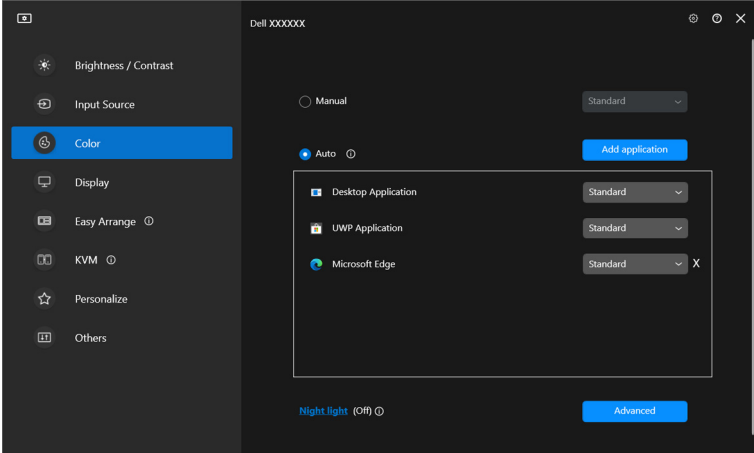

3. Select desired applications and click **OK**.

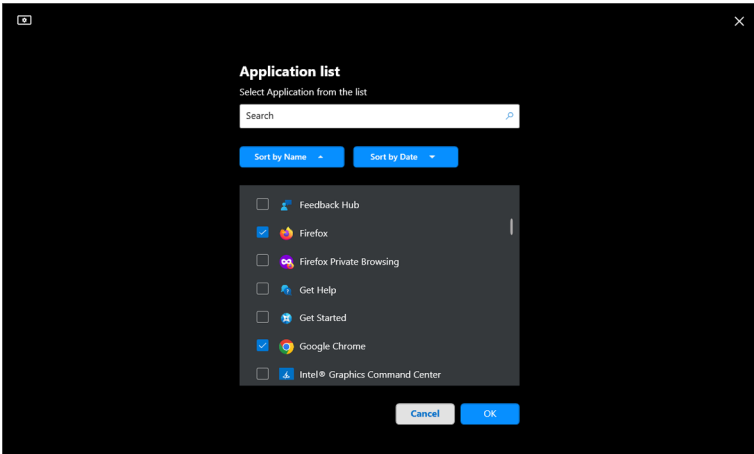

4. Select desired color preset when using the application.

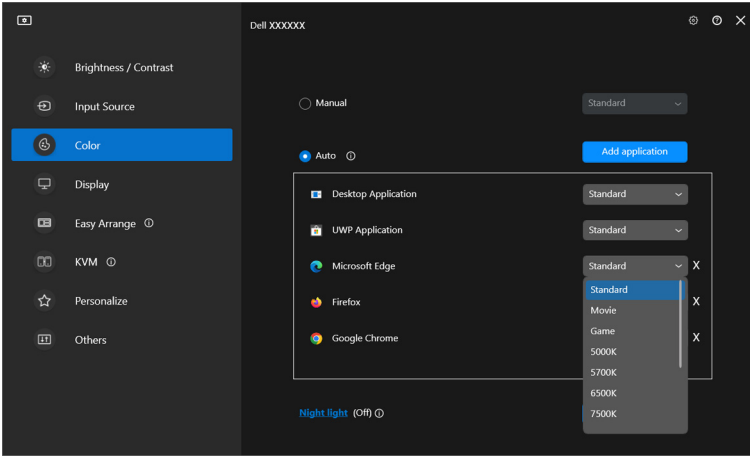

**NOTE:** The color preset mode assignments for batch files, scripts, shortcuts, and non-executable files, such as zip archives or packed files, are not supported.



# Color management

This feature provides the optimum color experience by matching the color space of the monitor with the International Color Consortium (ICC) profile.

On the supported Dell models, **Color management** options are available by pressing **Advanced** button in the **Color** menu. You can choose **Automatically adjust the ICC color profile based on color preset** or **Automatically adjust the color based on ICC profile**.

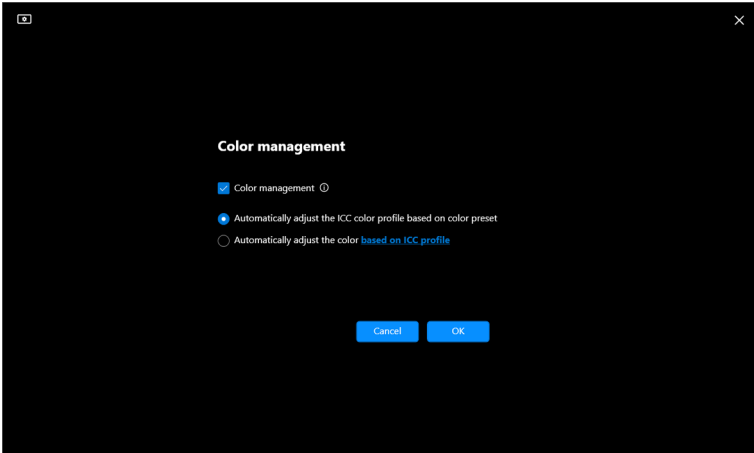
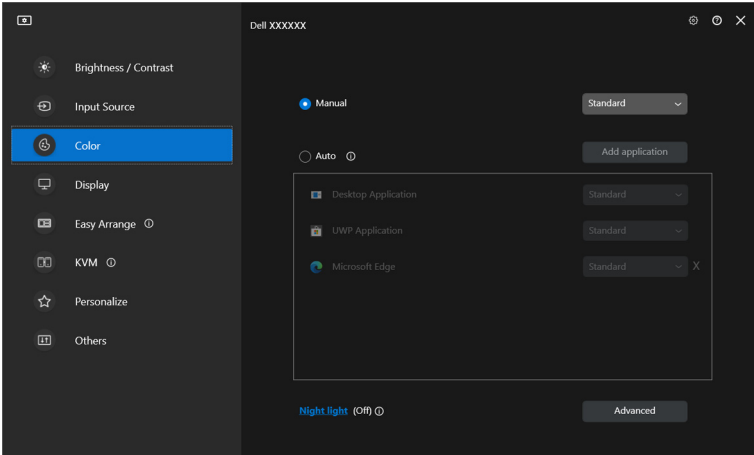

## Automatically adjust the ICC color profile based on color preset

The corresponding ICC profile in Windows is changed when you change the color preset from the monitor OSD menu.

## Automatically adjust the color based on ICC profile

The corresponding color preset is set in the monitor when you change the ICC profile in Windows. You can click on the ICC profile link to add the color profile installed for the monitor.

 **NOTE:** Currently, this function is not supported when display is set to **show only on external monitor**.

## Changing the ICC/ICM profile in Windows

Select a color profile from the **Color Profile** drop-down list in **Display** settings.

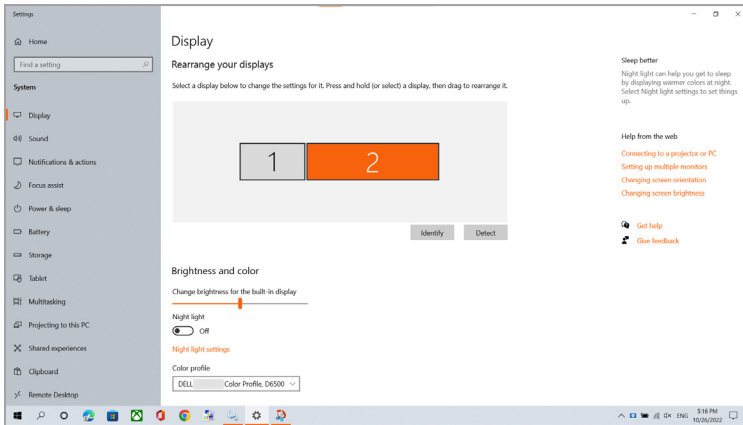



# Adjusting monitor display settings

On the DDM 2.2 menu, select **Display** to change common monitor settings.

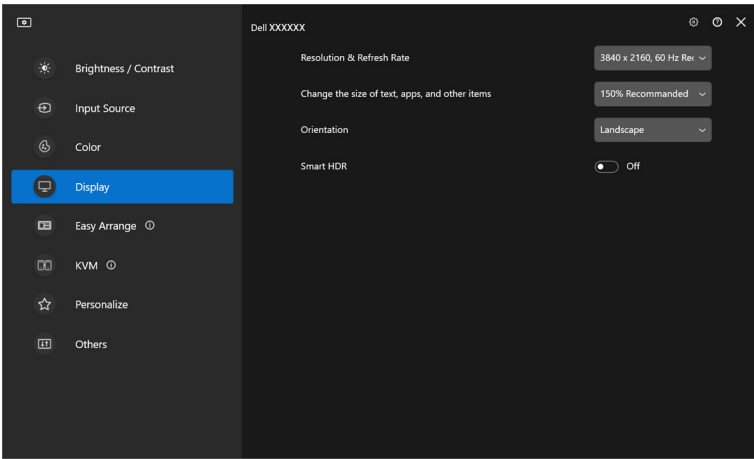

Feature	Function	Description
Display	Resolution & Refresh Rate	Adjust the resolution and refresh rate of the display setting.
	Change the size of text, apps, and other items	Scale the user interface component up or down.
	Orientation	Change the orientation of the monitor operating system display. <b>NOTE:</b> For monitors that support changing orientation from DDM, the monitor OSD orientation setting will change accordingly.
	Smart HDR	Turn on/off HDR of the monitor and the display settings.

 **NOTE:** The Smart HDR function is only available for monitors that support this function.



# Organizing windows with Easy Arrange

The **Easy Arrange** menu simplifies the way applications are displayed on windows on your monitor.

## Layout

Perform the following steps to organize the windows:

1. Select any of the predefined layouts to virtually divide the screen into multiple zones.
2. Drag the application to your selected zone to position it in the zone. The application snaps to the selected zone.

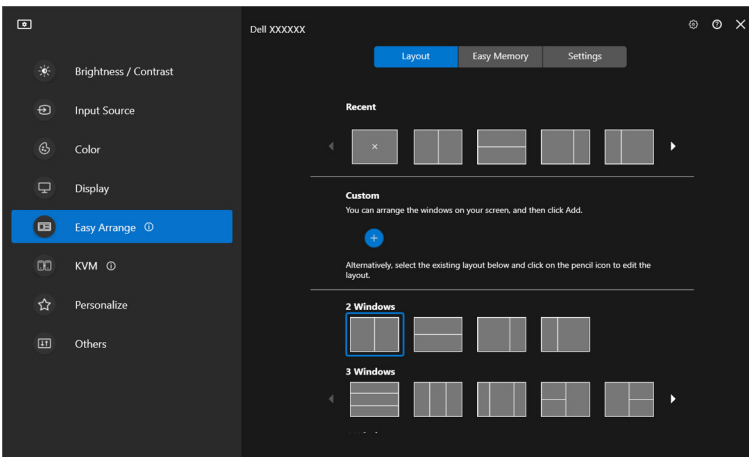

Landscape mode of the **Easy Arrange** layouts



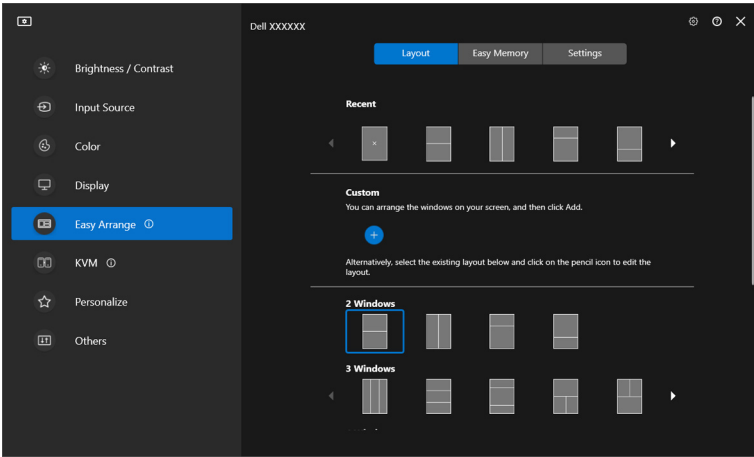

Portrait mode of the **Easy Arrange** layouts are displayed when you rotate the monitor

## Customized layout

You can add a new customize layout to your preference. Perform the following steps to add an new customize layout:

1. Arrange the windows on your screen, then click on the **+** icon. The layout will be set according to your windows arrangement.

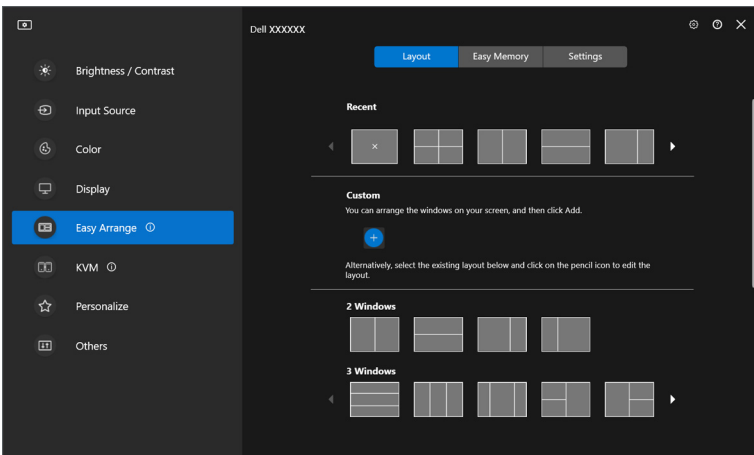

2. On the save dialog, choose an layout name for the new layout.

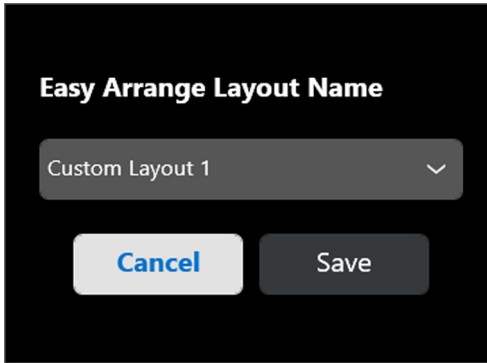

3. Click **Save** to complete customization.

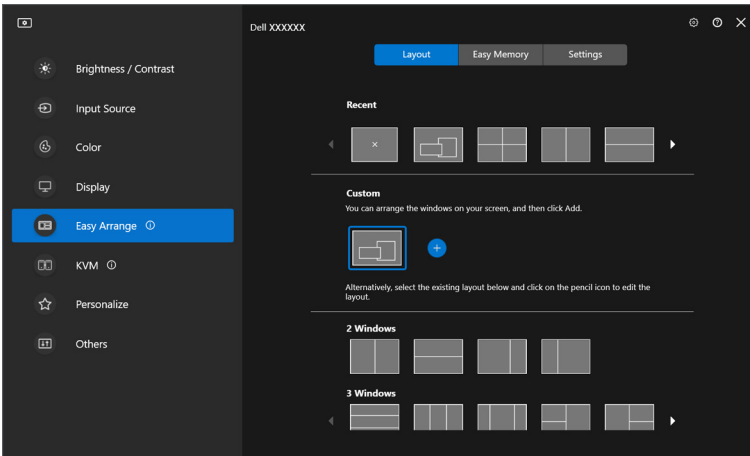

You can also edit any existing layout to your preference. Perform the following steps to customize an existing layout:

1. Hover the mouse pointer over the layout to be customized, and click the pen icon.

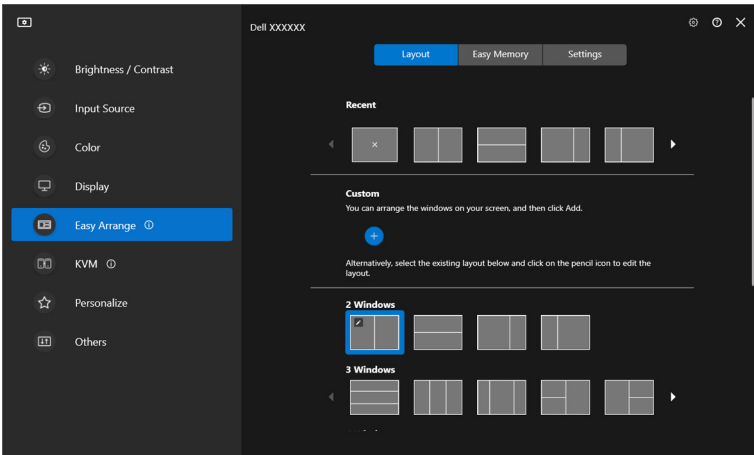

2. The layout with RED grid lines appear on screen. Press on the RED grid line to adjust the layout.

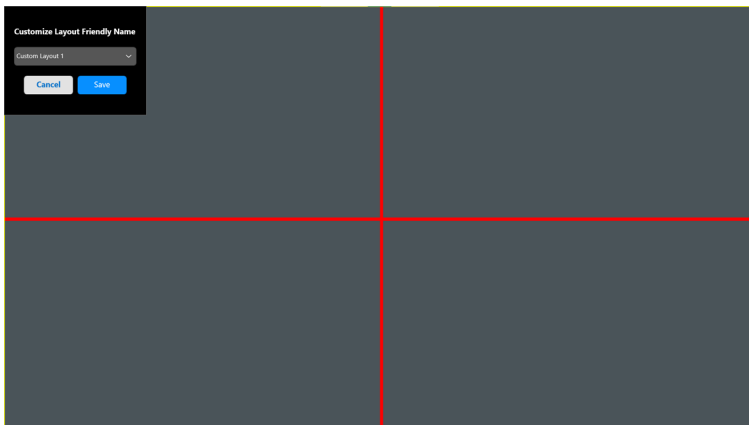

3. The RED grid line changes to GREEN line as you drag the line to adjust the layout size. Release the line when done.

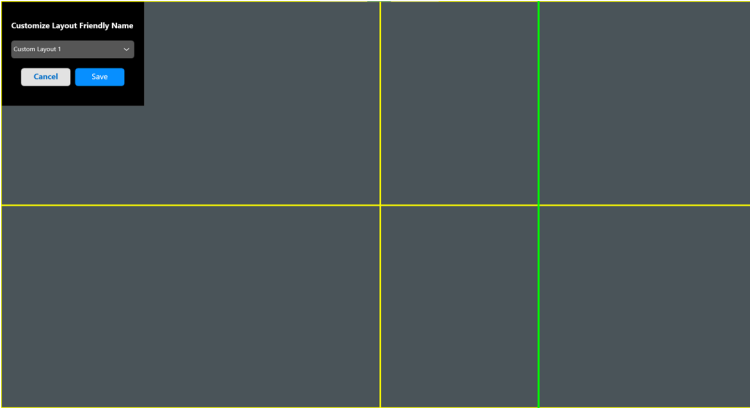

4. On the save dialog, choose an layout name for the new layout.

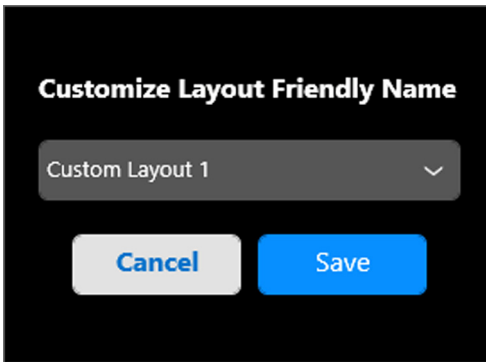

5. Click **Save** to complete customization.



# Easy Memory

**Easy Memory** allows user to save application or files in their respective partition into different profiles and restore them manually, by scheduled time or at system start-up. Perform the following steps to create profile and launch it:

1. Click **+** to create a new profile.

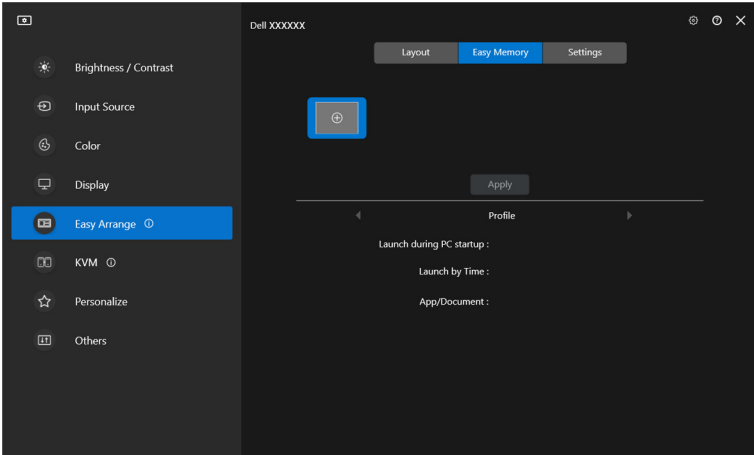

2. Input the profile name and select a layout. Click **Next**.

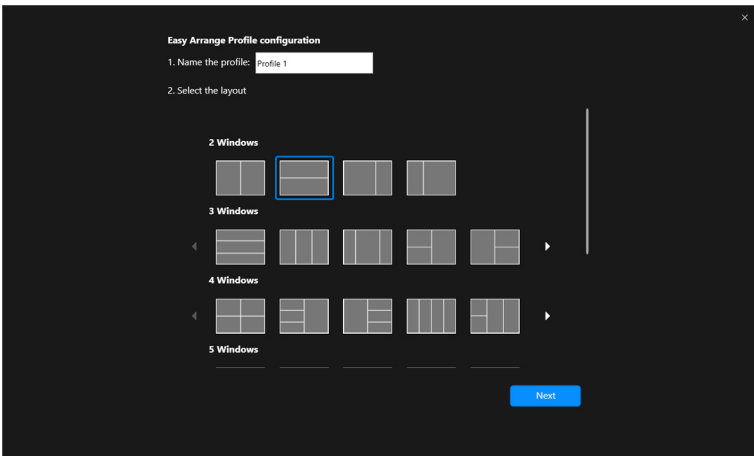

3. Assign application or file to be shown in each partition by clicking **+** or by dragging the file into partition. Click **Next**.

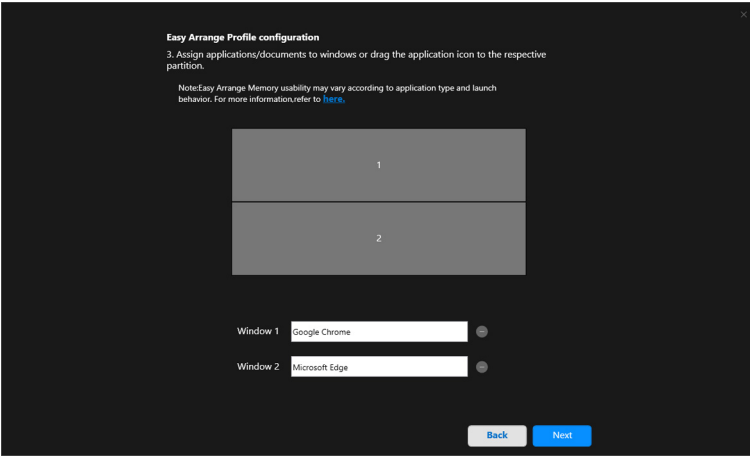

4. Configure the time to launch the profile and click **Finish**.

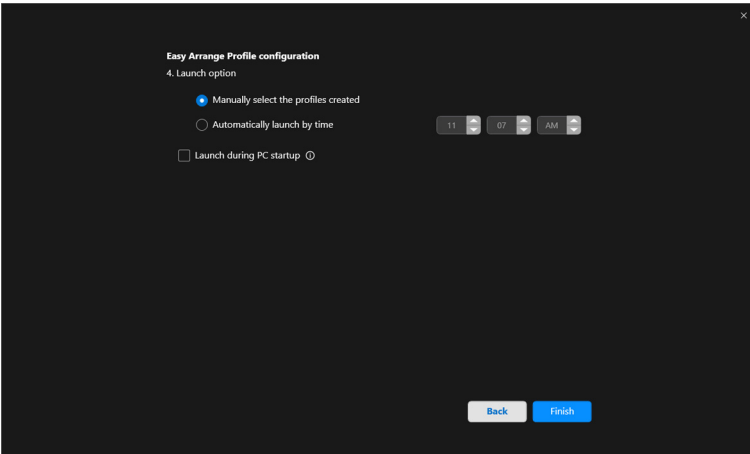



**Easy Arrange** Memory usability may vary according to application type and launch behavior. **Easy Memory** works with general productivity apps such as Microsoft Office, Adobe, Web browsers and more.

**Easy Memory** might not be able to perform a window partition at launch if any of the following takes place:

- App displays a pop-up dialog box upon launch (i.e., login screen, error dialog, or unsaved files)
- App is launched in full screen mode
- Files are opened as individual tabs within the app
- Overlapping Easy Arrange layouts

## Settings

Configure the personal preferences.

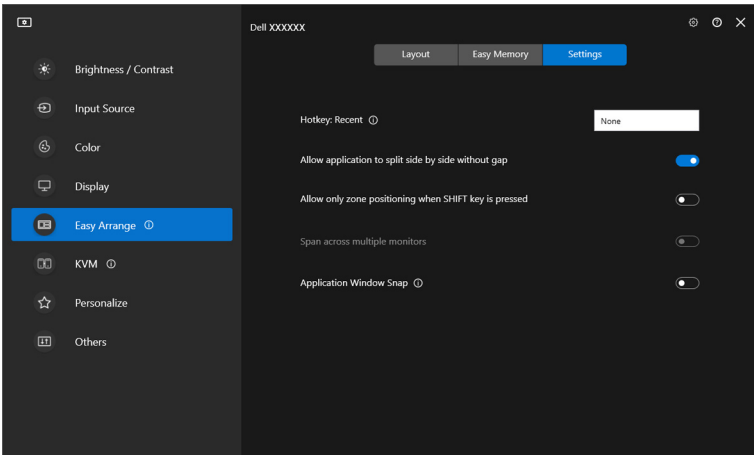

Feature	Function	Description
Easy Arrange	Hotkey: Recent	Configure a hotkey (for example, <b>Alt+R</b> ) to select recently used layouts. You can also change to your preferred hotkey here.
	Allow application to split side by side without gap	Enable this function to allow application snap side-by-side without gap.
	Allow only zone positioning when SHIFT key is pressed	Enables the <b>Easy Arrange</b> menu by pressing the Shift key.
	Span across multiple monitors	If you are using multiple monitors in an array or matrix, the <b>Easy Arrange</b> layout can be applied across all the monitors as one desktop. You need to align your monitors properly to make it effective.
	Application Window Snap	Snap any application into a split screen layout easily by dragging into the partition.

 **NOTE:** If an application window cannot fit in the zone defined by Easy Arrange, the application may not display properly.

 **NOTE:** The Span across multiple monitors can be enabled only for all connected monitors that have the same physical size, resolution, scaling settings, and are placed side-by-side.



# Using the Application Window Snap

The **Application Window Snap** is designed to enable application placement on any screen quickly. When this function is enabled in DDM, dragging the application triggers a floating menu that contains recently-used **Easy Arrange** layouts. Drop the application to any one of the listed layouts to perform window placement.

When this function is turned on, it replaces the **Easy Arrange** option such that the user can snap their application conveniently to the respective monitor and zone in the four most recently used **Easy Arrange** layouts.

You can enable this feature by one of the following methods:

- Launch DDM, go to **Easy Arrange** menu, and enable the **Application Window Snap** function.

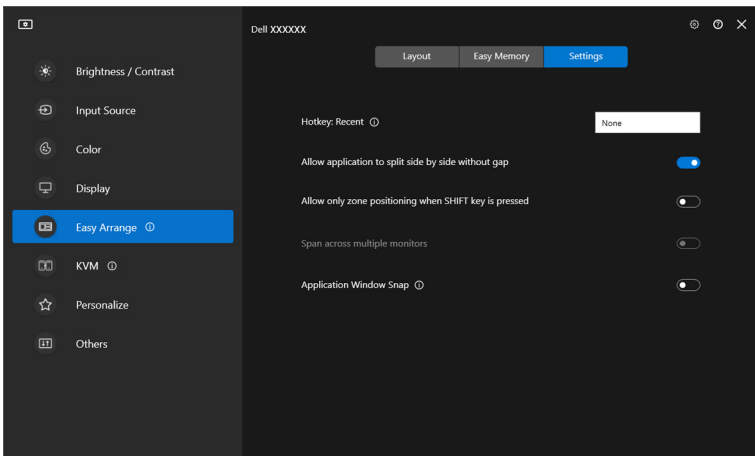

- Right-click on the DDM icon on the status bar, and select **Application Window Snap** to enable the function.

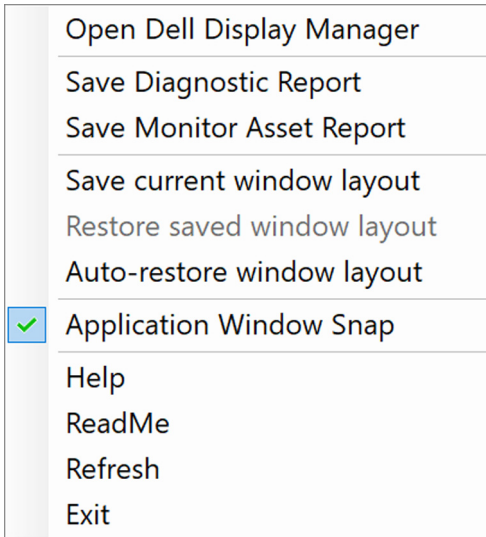

- Drag the application window and drop it into one of the zone on the floating menu.

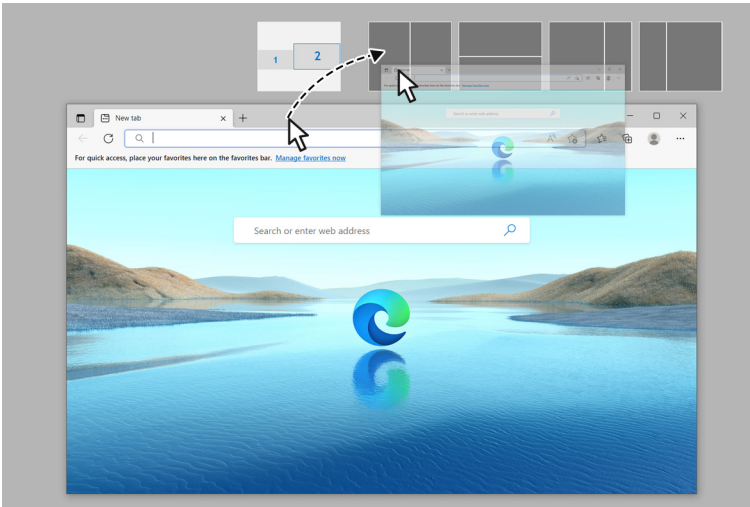

- The application will be snapped into the select zone.

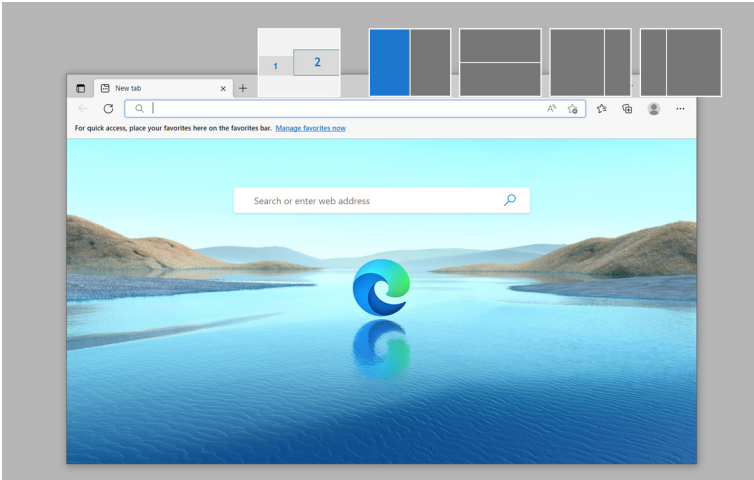

You may turn this function off from the **Easy Arrange** menu when you want to use **Span across multiple monitors**.



# Configuring the gaming settings

You can configure the **Gaming** menu that is available only on Alienware and Dell Gaming monitors.

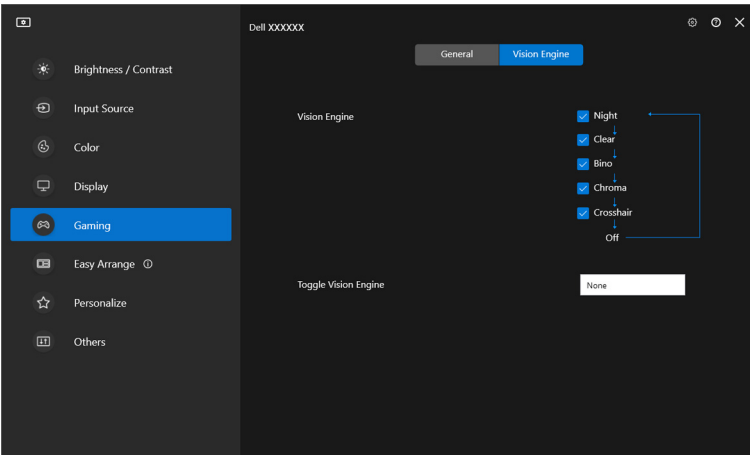
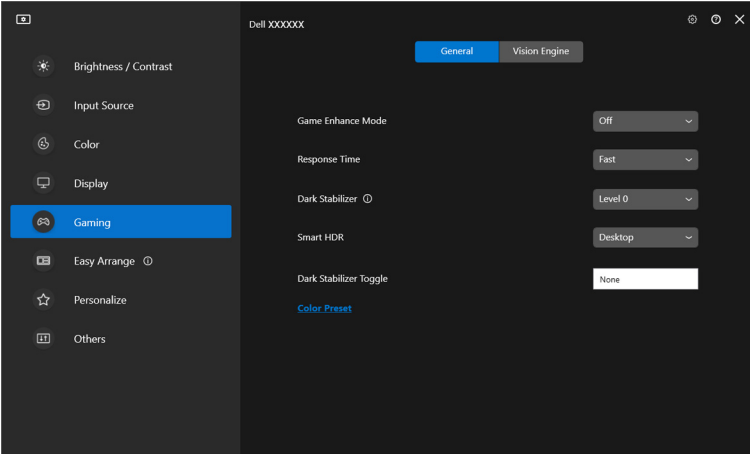

Feature	Function	Description
General	Game Enhance Mode	Select the game enhance mode from the drop-down list.
	Response Time	Select the response time from the drop-down list.
	Dark Stabilizer	Select the dark stabilizer from the drop-down list.
	Smart HDR	Select the smart HDR from the drop-down list.
	Dark Stabilizer Toggle	Configure your preferred hotkey (for example, <b>Alt+S</b> ) to toggle the dark stabilizer levels. You can also change to your preferred hotkey.
	Color Preset	Click <b>Color Preset</b> for more color options.
Vision Engine	Vision Engine	Select one or more vision engines that you can use when playing games.
	Toggle Vision Engine	Configure your preferred hotkey (for example, <b>Alt+T</b> ) to toggle the <b>Vision Engine</b> . You can also change to your preferred hotkey.

 **NOTE:** The Gaming menu functions and available options vary depending on the model of the monitor.



# Setting up the KVM

For monitors that support the KVM function, follow the on-screen instructions to set up the computers that are connected to the monitor.

To setup, select **USB KVM**, click **Next**, and follow the on-screen instructions to set up the computers that are connected to the monitor.

1. Select the number of sources your monitor is connected to.

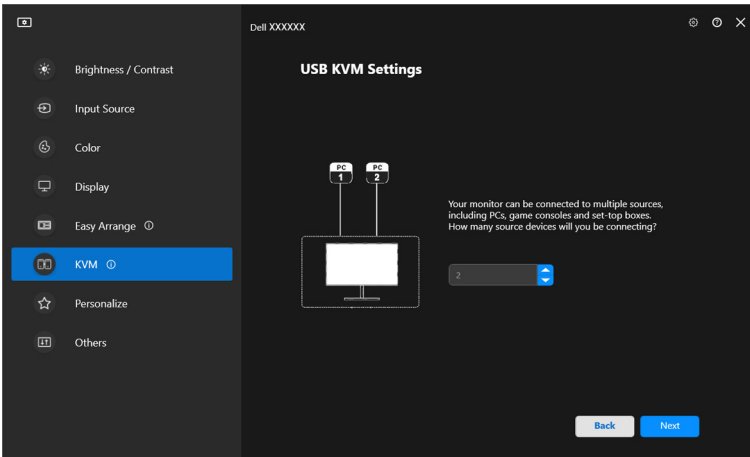

2. Pair the input sources with their connectors and assign preferred names.

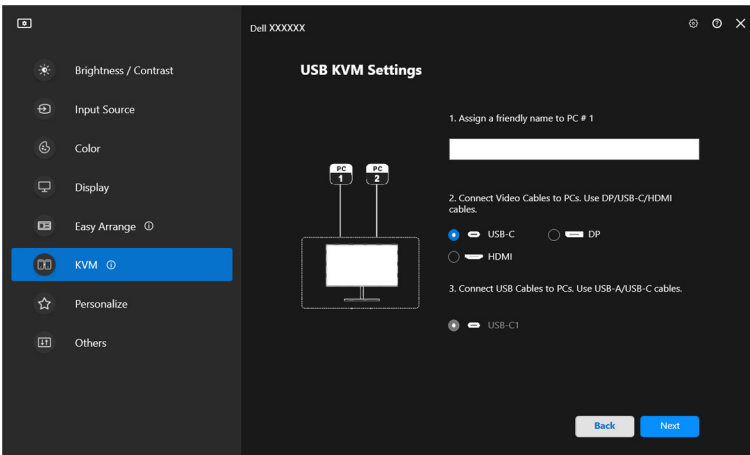



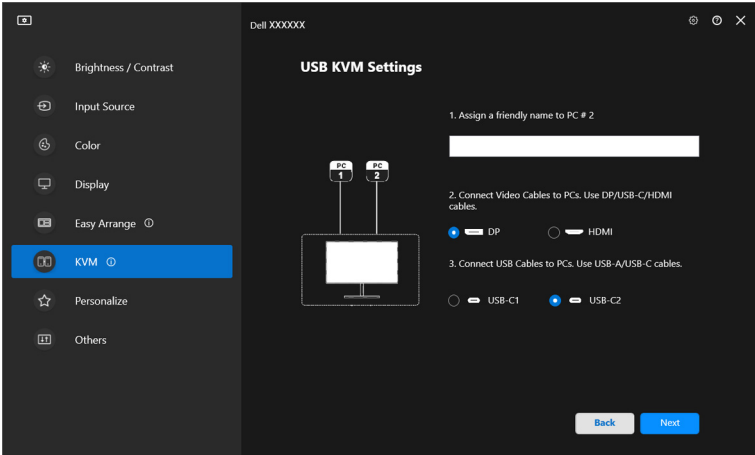

### 3. Connect keyboard and mouse to the monitor.

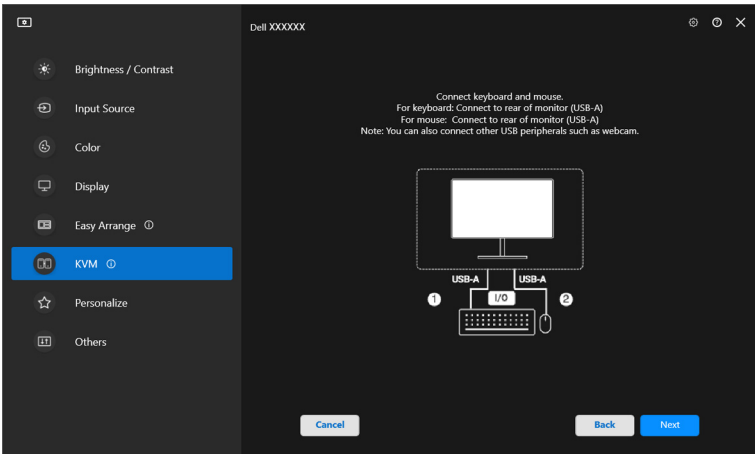

4. Select a preferred layout.

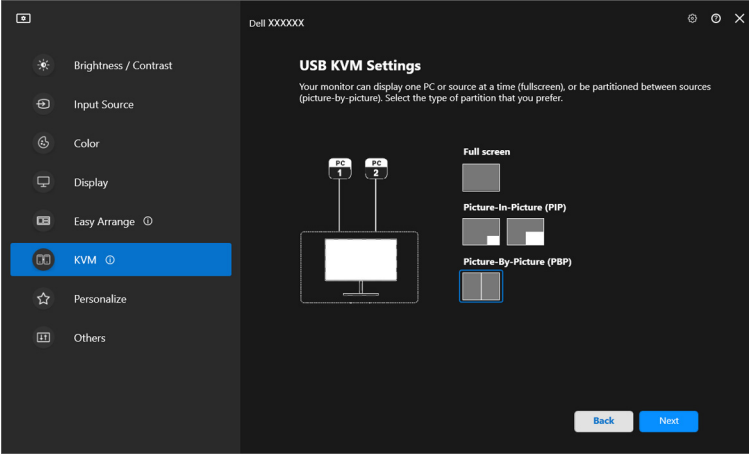

5. Click **Download** to download **Dell Display Manager (Windows)** or **Dell Display and Peripheral Manager (Mac)** for other computers you wish to connect. Finally, click **Finish** to save and exit KVM setup.

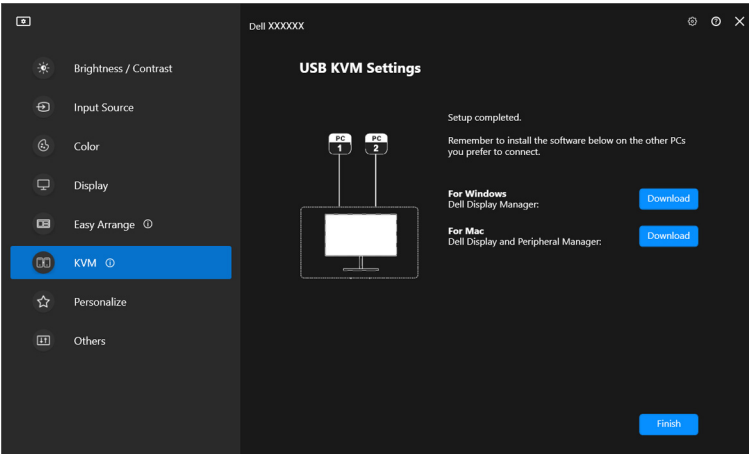

 **NOTE:** DDM 2.2 communicates with your monitor even when the monitor is displaying video from another computer. You can install Dell Display Manager (Windows) or Dell Display and Peripheral Manager (Mac) on the computer you frequently use, and control input switch from it. You can also install Dell Display Manager (Windows) or Dell Display and Peripheral Manager (Mac) on other computers connected to the monitor.



# Changing KVM configuration

You can change the **KVM** configuration after completing the KVM setup either by running the setup instructions again or changing the screen configuration by clicking **Configure screen**.

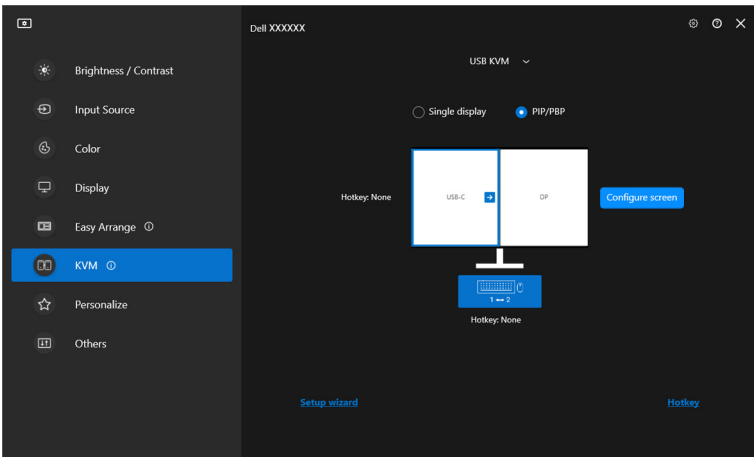
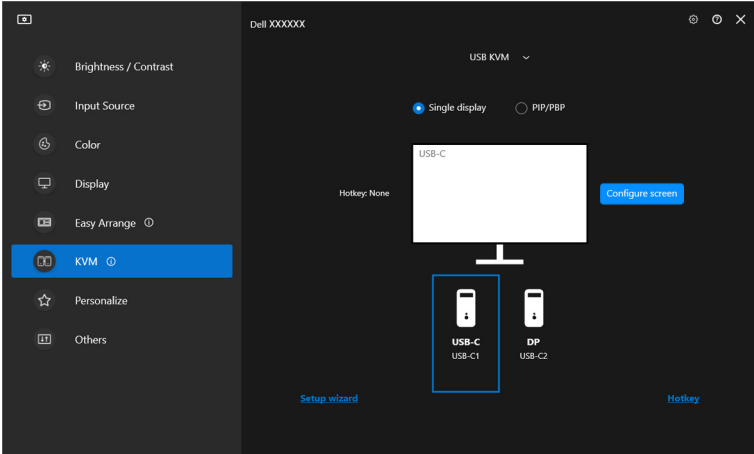

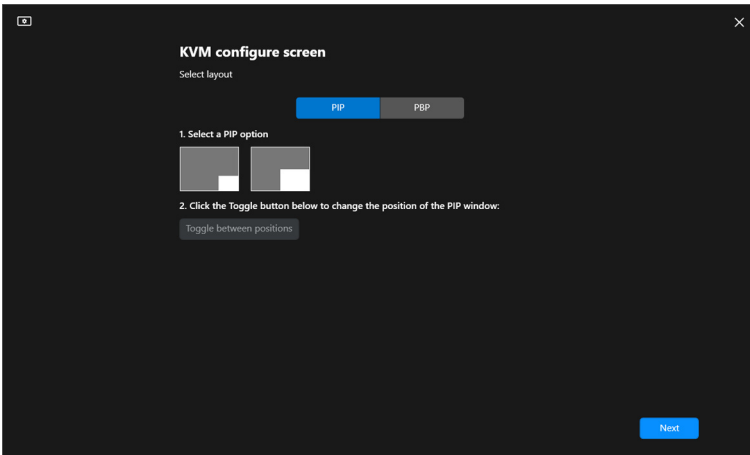

Feature	Function	Description
Single display	Change video input	Change current video input by clicking the desktop computer icon or press <b>hotkey</b> .
PIP/PBP	Video swap	Swap video input of main/sub by clicking arrow or press <b>hotkey</b> (only available in PIP or PBP side by side layout).
	USB switch	Click button or press <b>hotkey</b> to toggle USB upstream port of active input sources.

1. Click **KVM Configure Screen** to change the screen layout.

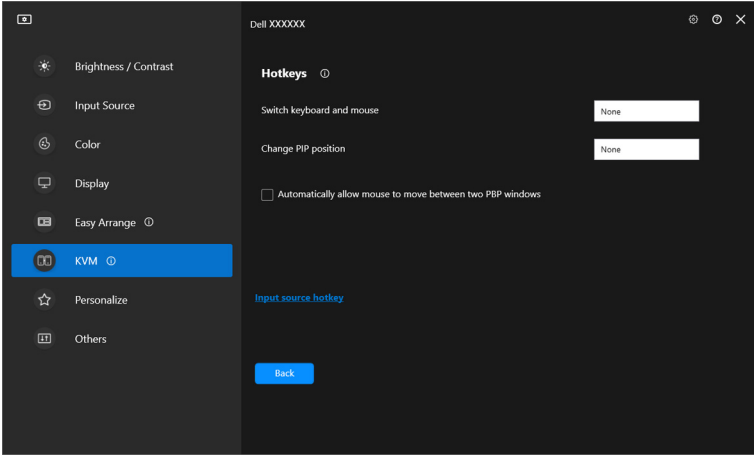

2. Click **Hotkeys** to configure KVM hotkeys.



 **NOTE:** Only relevant hotkeys in accordance with your screen configuration will be displayed.

Feature	Function	Description
Hotkeys	Switch between computers	Configure your preferred hotkey (for example, <b>ALT+P</b> ) to switch between the computers in single display mode.
	Switch keyboard and mouse	Configure your preferred hotkey (for example, <b>ALT+U</b> ) to switch keyboard and mouse between computers in PBP or PIP mode.
	Change PIP position	Configure your preferred hotkey (for example, <b>ALT+Q</b> ) to change the PIP position.
	Automatically allow mouse to move between two PBP windows	Check to enable the keyboard and mouse switching from one computer to another computer by sliding across the edge when PBP mode is turned on
	Input source hotkey	Click <b>Input source hotkey</b> for more hotkey configuration.



# Personalize settings

## Changing Menu Launcher configuration

1. Click **Configure** to change the quick access function on **Menu Launcher**.

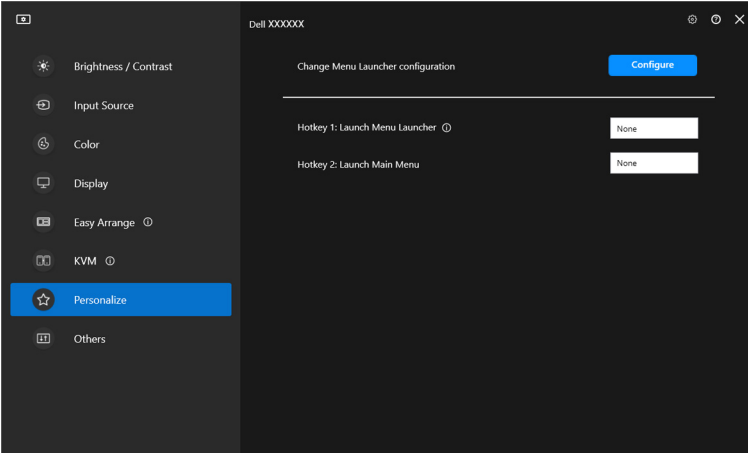

2. Select function from the drop-down list. Click **Add function** to add more functions to the **Menu Launcher**.

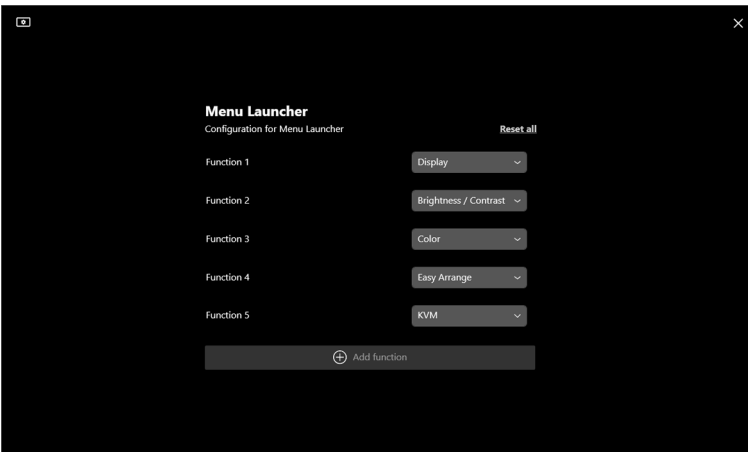

3. Click **Reset all** to reset the functions of **Menu Launcher**.

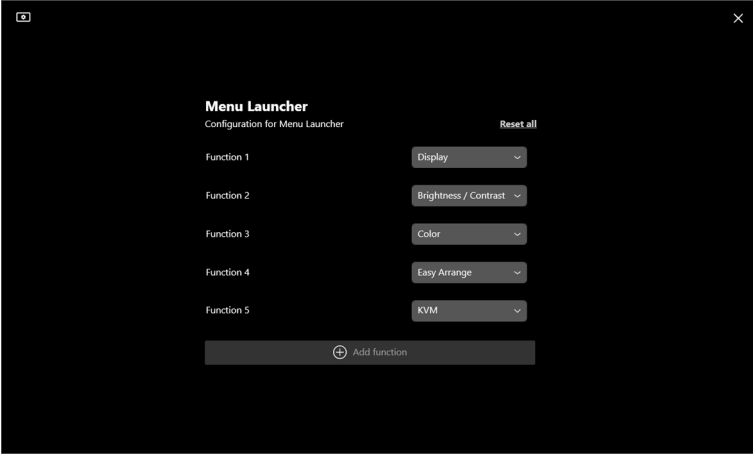

 **NOTE:** The available functions may differ depending on the configuration of your monitor.

## Changing Launch DDM Hotkey configuration

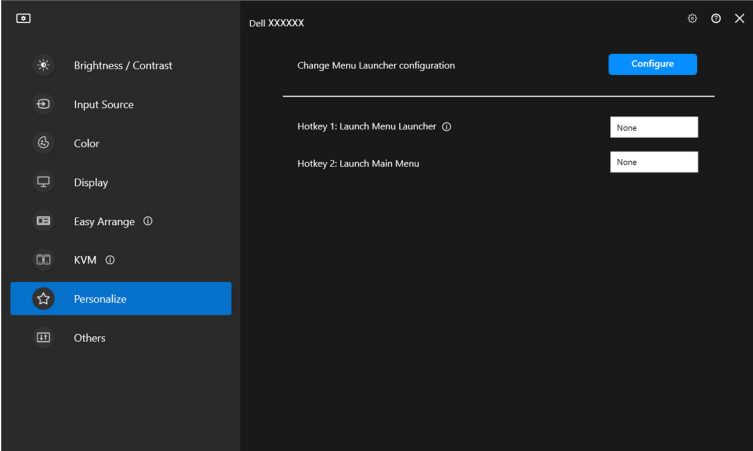

Feature	Function	Description
Personalize	Launch Menu Launcher	Configure a hotkey (for example, <b>ALT+M</b> ) to bring up the <b>Menu Launcher</b> box of the monitor where the mouse pointer is currently located.
	Launch Main Menu	Configure a hotkey (for example, <b>ALT+D</b> ) to bring up the <b>Main Menu</b> of the monitor where the mouse pointer is currently located.

## Applying energy conservation features

On the supported Dell models, **PowerNap** energy conservation options are available under **Others** menu. You can choose to set the brightness of the monitor to the minimum level, or to put the monitor to sleep when the screen saver is activated.

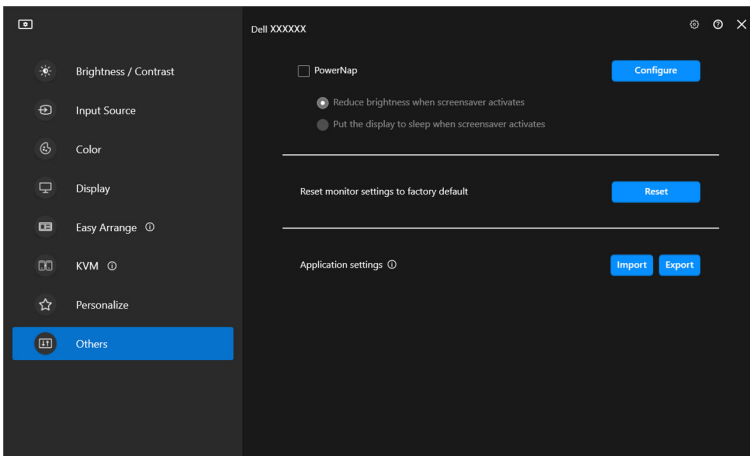

 **NOTE:** PowerNap option is disabled in PBP or PIP to prevent disruption of the normal activities.





# Resetting monitor settings

Click **Reset** to reset all monitor settings under **Others** menu.

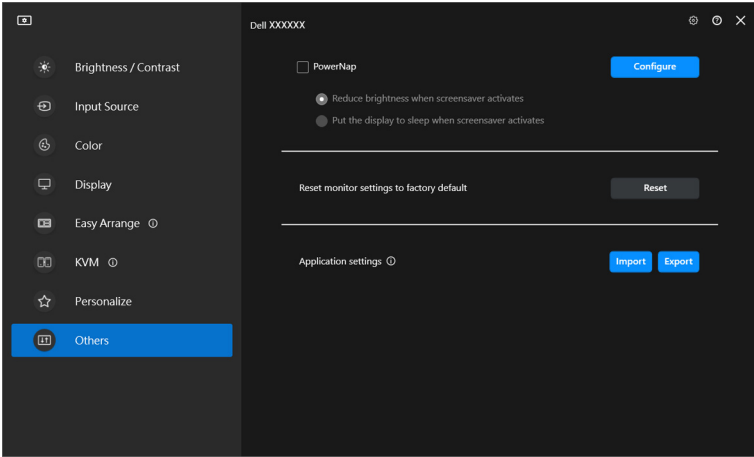

# Import/Export application settings

You can use this function to export the monitor settings from one monitor and import into another monitor of the same model.

1. Click **Export** to store a copy of the application and monitor settings of selected monitor to a file, and click **OK** when export is successful.

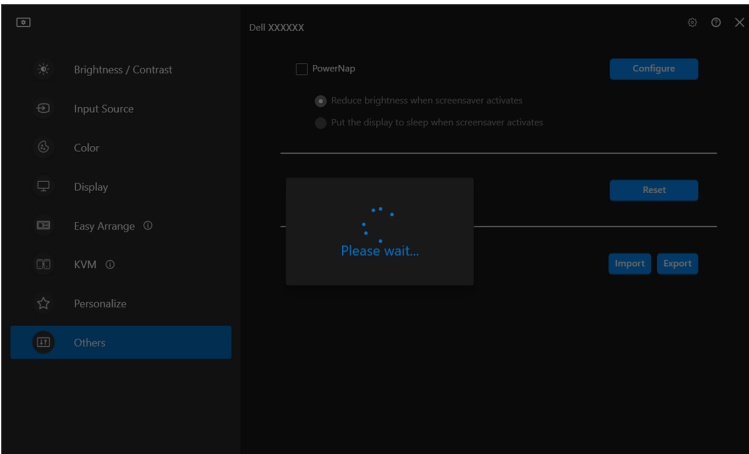
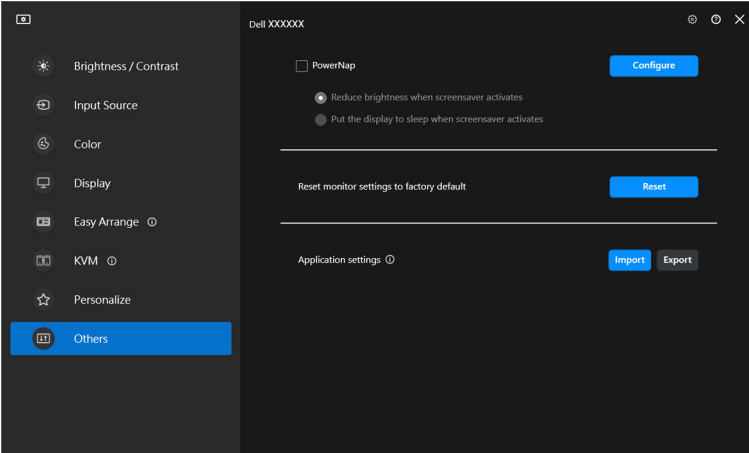

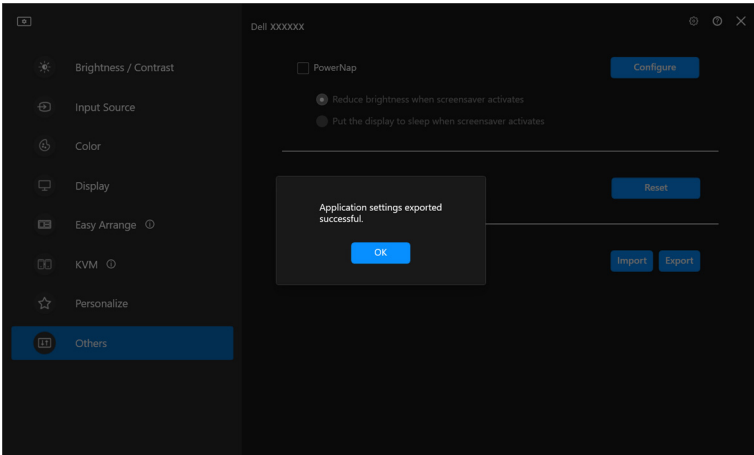

2. To import the settings from a previously exported file, click **Import** and select the file. The monitor settings will be applied to all of the connected displays of the same model.

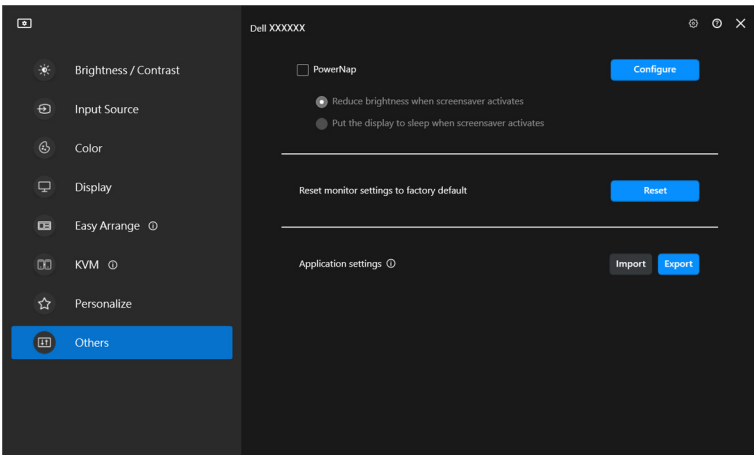

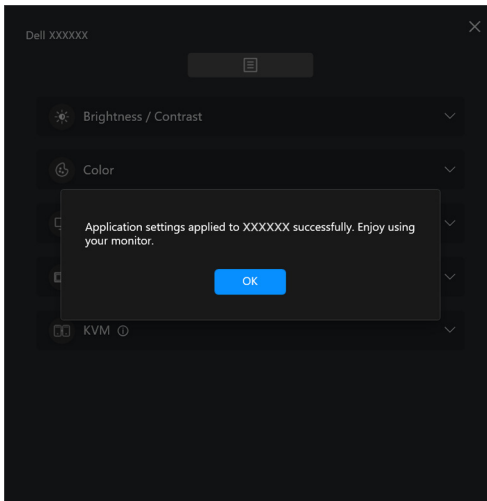
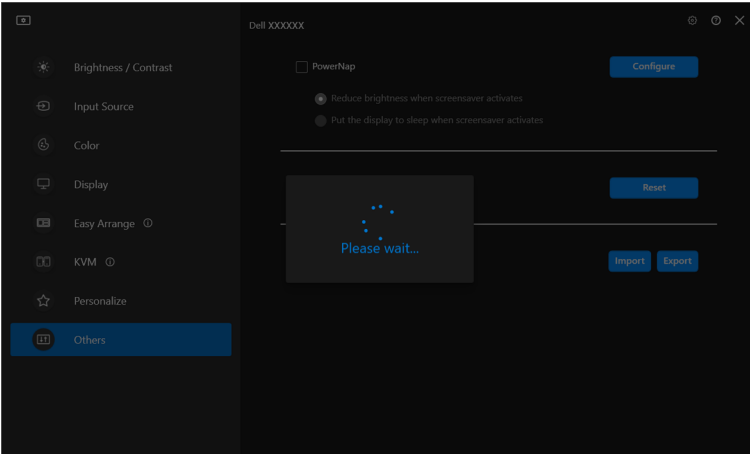

3. DDM 2.2 will restart after the file is imported.

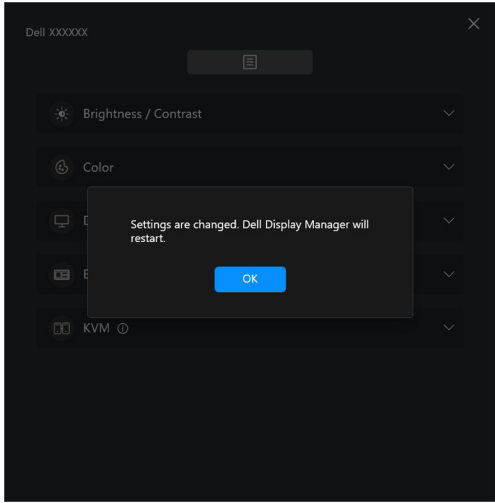

# Additional settings

There are additional DDM 2.2 settings available under **Settings**. Click **Settings** icon to make setting adjustments.

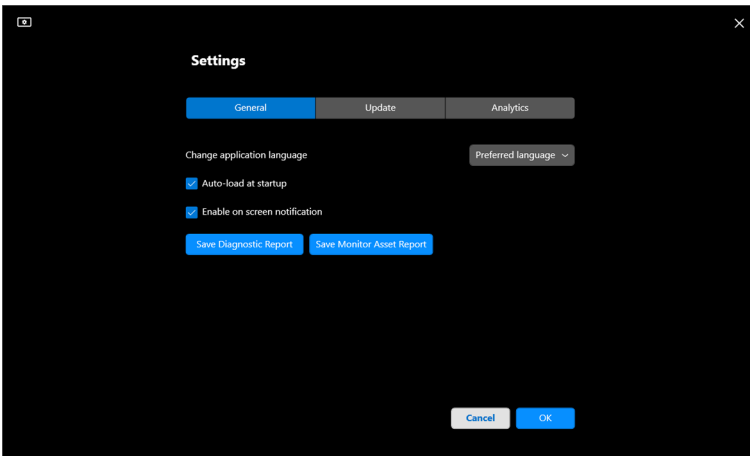
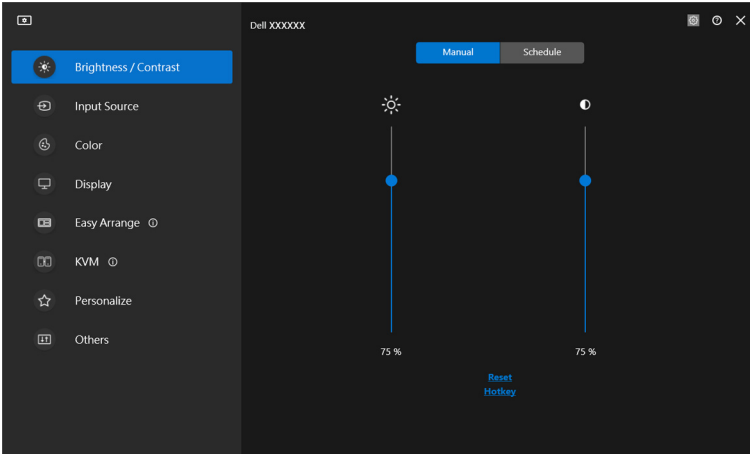

<b>Feature</b>	<b>Function</b>	<b>Description</b>
General	Change application language	Apply <b>preferred language</b> to DDM 2.2. The default <b>preferred language</b> is the first language on the <b>preferred language</b> list, which follows the Windows language configuration.
	Auto-load at startup	Launch DDM 2.2 when the computer starts up.
	Enable on screen notification	Allow DDM 2.2 to show notification message.



# Help

There are additional software and monitor information available in **Help**. Click the “?” icon to access the **Help** screen.

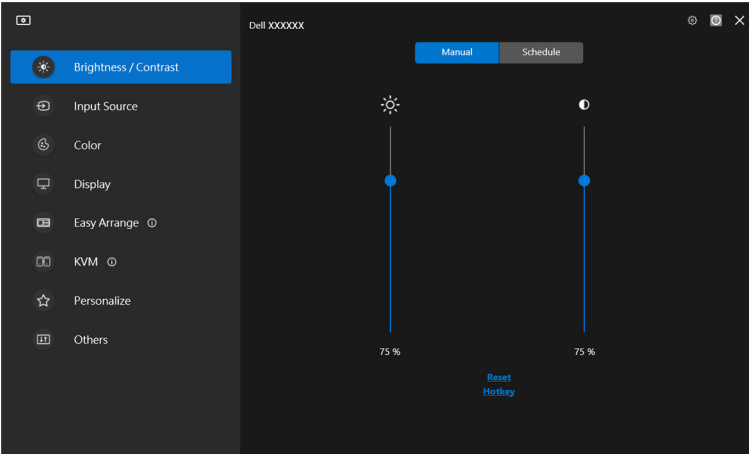

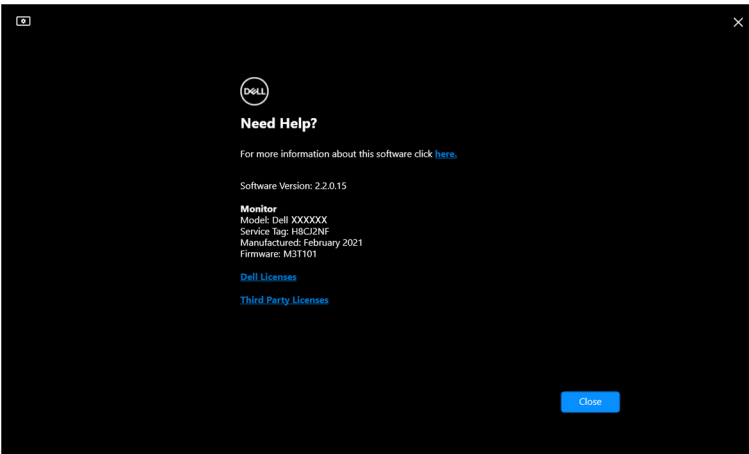

You can obtain software information by clicking **here**. You can also obtain model name, service tag, manufactured date, and firmware information of the monitor. Click **Close** to exit the **Help** screen.







# Troubleshooting

## Understand the different states of DDM 2.2

Feature	Function	Description
DDM icon	Searching 	Searching for the supported monitors.
	Connected 	The supported monitors are connected. <b>NOTE:</b> You can right click to refresh if your supported monitor is not listed in the DDM 2.2 drop-down menu.
	Unable to connect 	Either there are no supported monitors connected or there is communication error in connecting your monitor. See reasons for unable to detect monitor in the section below.

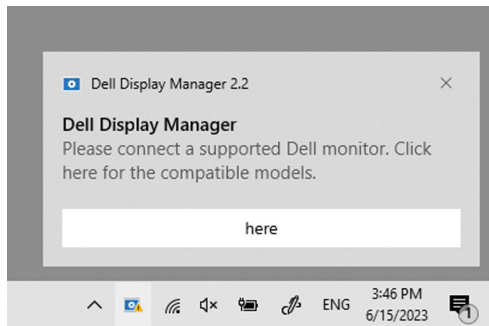
If DDM 2.2 does not work on your monitor, you will see the following icon and message in the status menu.



 **NOTE:** DDM 2.2 works only on selected Dell-branded monitors and is not supported on the monitors from other manufacturers.



## Dell monitors not supported by DDM 2.2

DDM 2.2 may not work with the following monitors:

- Dell monitor models not included in DDM 2.2 for Windows supported list. For more information, see <https://www.dell.com/support/ddm>
- Monitors not listed in DDM 2.2 for Windows support list. Virtual and wireless monitors do not support DDC/CI

## Unable to detect supported Dell monitor

In the following scenarios, Dell Display Manager might not be able to communicate with the monitor.

1. The primary monitor has turned on Multi-Monitor Sync (MMS).
2. The monitor is busy with color calibration.
3. The monitor has **Screen Partition** turned on.
4. DDC/CI is turned off.

If DDM 2.2 is unable to detect and/or communicate with a supported Dell monitor, take the following actions to troubleshoot:

1. Make sure the video cable or USB upstream cable is properly connected to your monitor and your computer. Ensure all the connectors are correctly connected to the ports.
2. Check the monitor OSD to ensure **DDC/CI** is enabled.

## Compatibility between DDM 1.x and DDM 2.2

Both software can be installed on a computer if you have older monitors that are not supported by DDM 2.2. It is highly recommended to uninstall DDM 1.x if all your monitors are supported by DDM 2.2.



## Getting more information on troubleshooting

You can **Save Diagnostic Report** or **Save Monitor Asset Report** to provide more information to Dell service center for troubleshooting.

### Save Diagnostic Report

Right click on DDM 2.2 icon and select **Save Diagnostic Report** or click the **Save Diagnostic Report** button from **Settings**. The report contains system and monitor related information along with DDM 2.2 runtime logs.

### Save Monitor Asset Report

Right click on DDM 2.2 icon and select **Save Monitor Asset Report** or click the **Save Monitor Asset Report** button from **Settings**. The report contains monitor Extended Display Identification Data (EDID) information for all connected monitors.

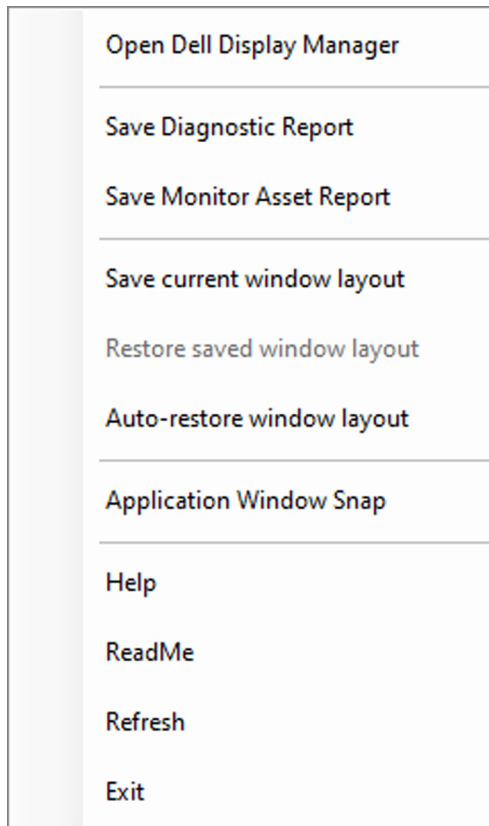

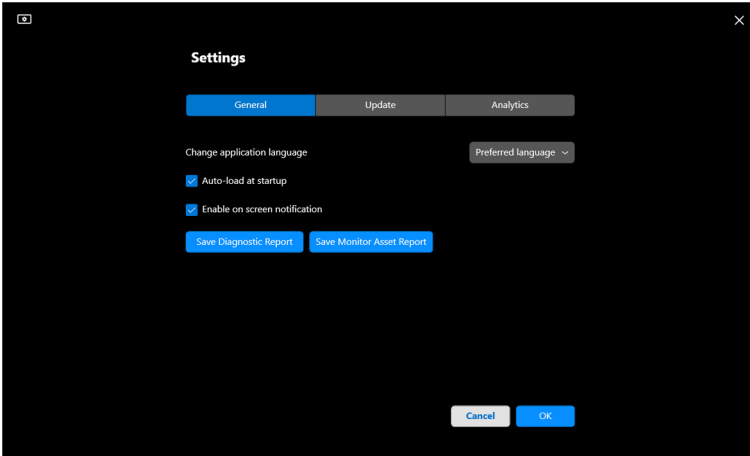

## Improve DDM 2.2

Check the **Help Dell improve its product and services automatically** if you consent to provide diagnostic and usage data to Dell server automatically. This data will help to improve Dell products and services.

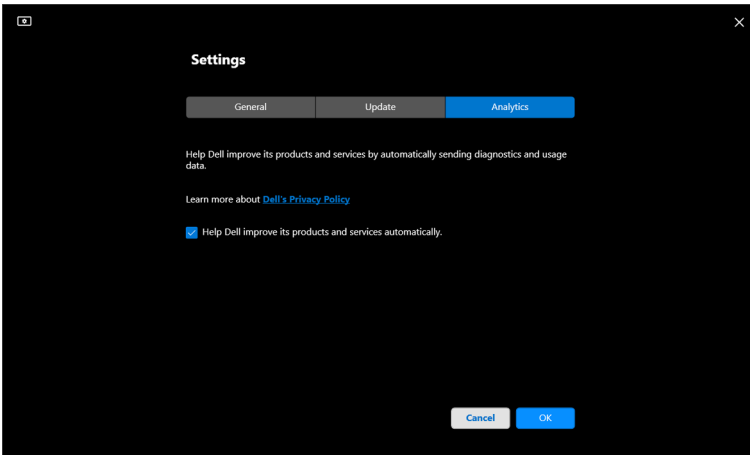

# Updating DDM 2.2 software and monitor firmware

If your computer is connected to the Internet, you will be prompted to upgrade to a newer version of DDM 2.2 or monitor firmware when the updated version is available. It is recommended to download and install the latest DDM 2.2 application and monitor firmware.

Click **Update** in **Settings** to update the DDM 2.2 software or monitor firmware. You can also check for new version by clicking on **Check For Updates** in **Settings**.

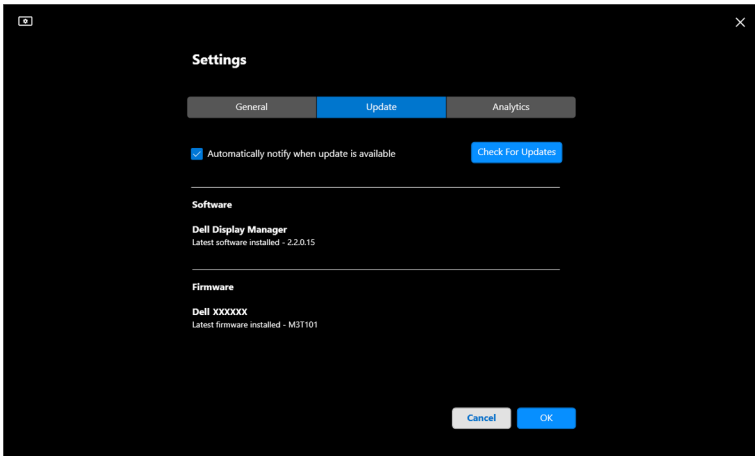

## Updating the monitor firmware

1. Click **Update** to update monitor firmware. The download progress bar will appear once the process begins.

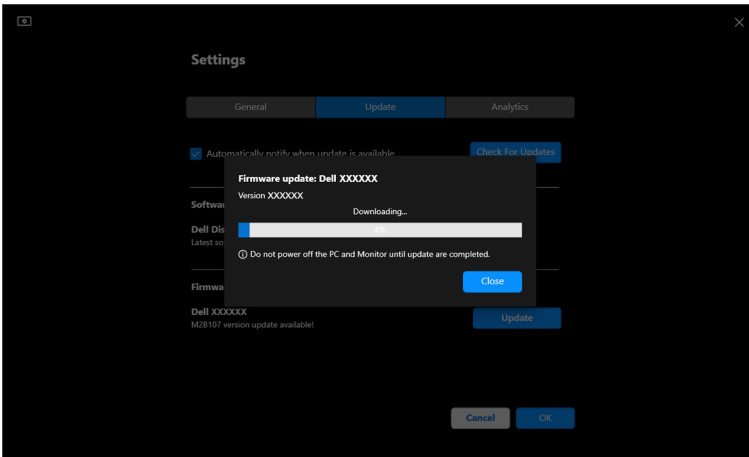

2. After download is complete, a dialog box appears to prompt for confirmation. Follow the on-screen instruction to disconnect all other monitors before clicking **Yes**.

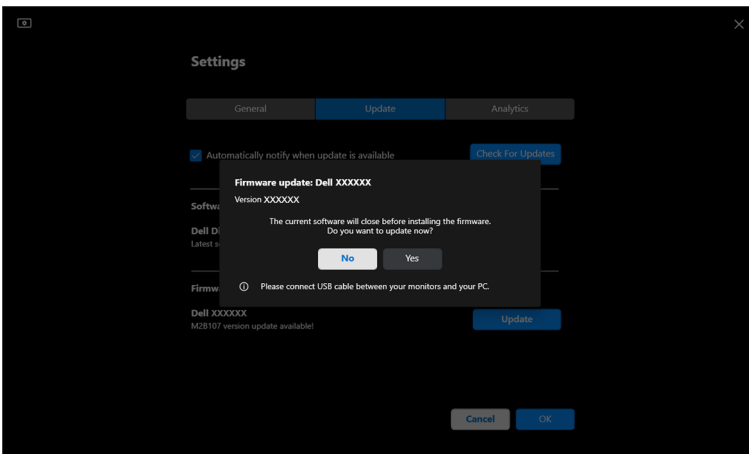

3. The **DDM 2.2** will be temporarily unavailable, and **Monitor Firmware Update Utility** will appear and start to update automatically.

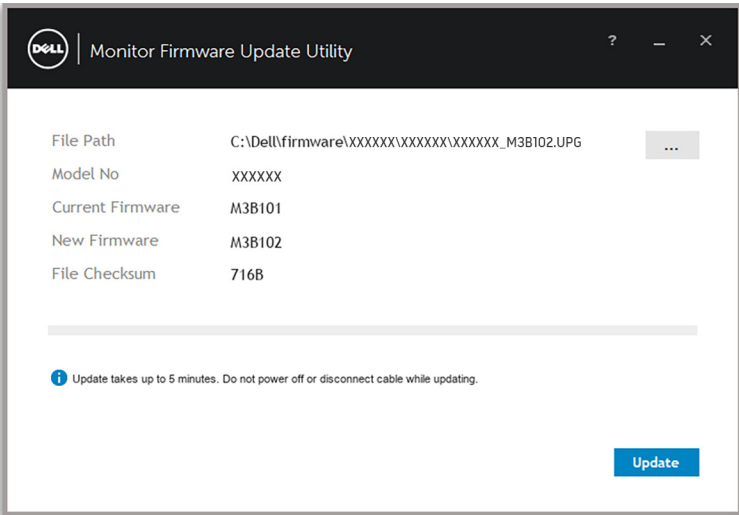

4. After update is complete, the **Monitor Firmware Update Utility** will close automatically.

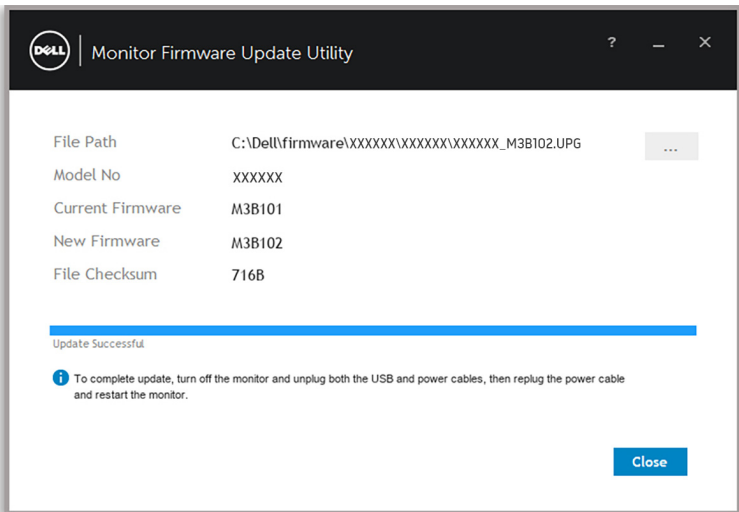

 **NOTE:** The **Monitor Firmware Update Utility** will update all monitors with the same model in order.





**NOTE: DDM 2.2** will launch automatically after monitor firmware update is complete.

