

# KYOCERA Net Direct Print User Guide

2022.9  
DirectPrintKDEN4

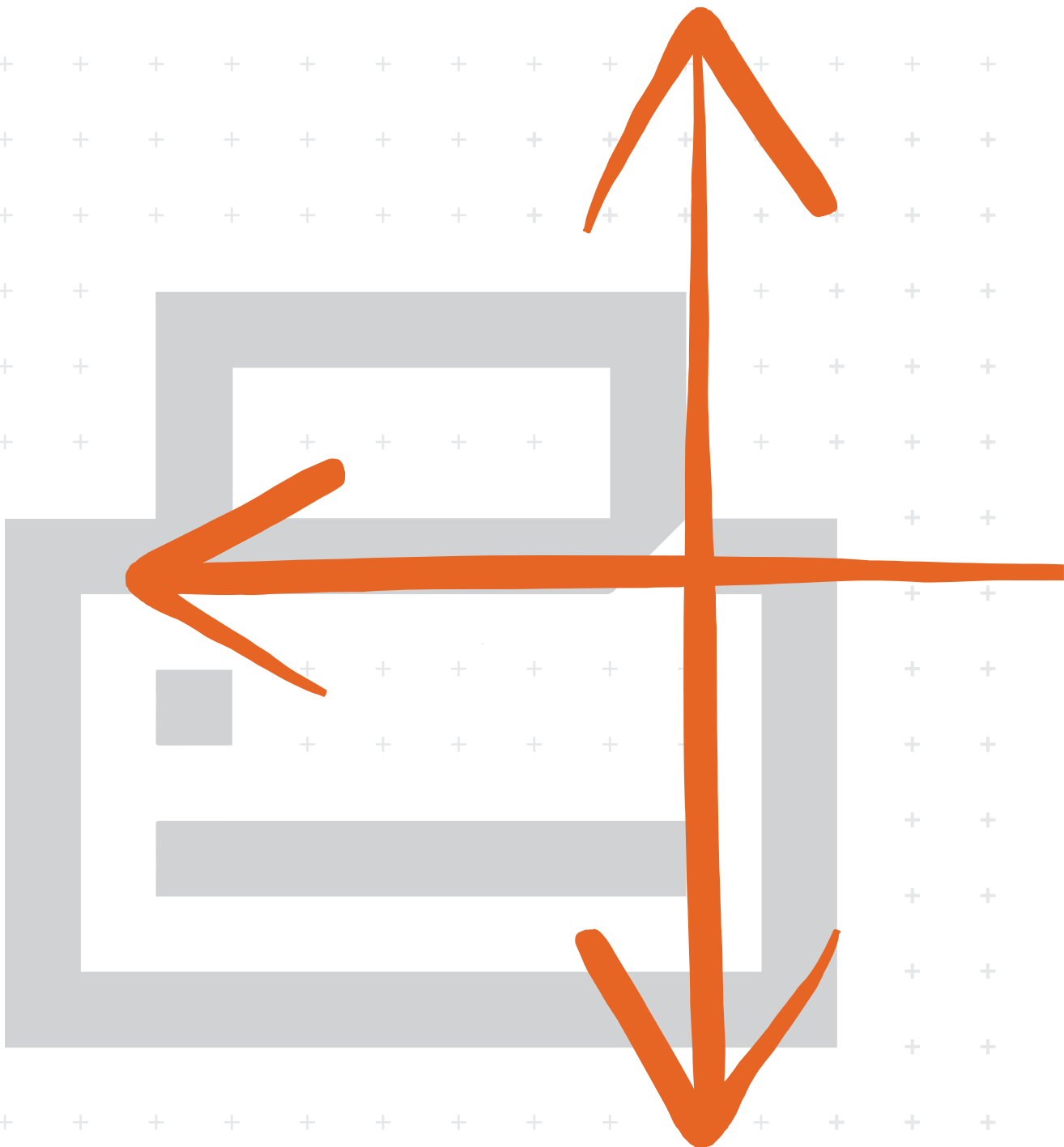

---

## Legal and General Information

### Notice

Unauthorized reproduction of all or part of this guide is prohibited. The information in this guide is subject to change without notice.

We cannot be held liable for any problems arising from the use of this product, regardless of the information herein.

When using this utility, the items that can be configured will differ depending on the model of your printing system or multifunctional printer (hereinafter referred to as "printing system").

Examples in this document are described in terms of the Windows 10 operating system environment.

### Regarding Trademarks

KYOCERA is a registered trademark of Kyocera Corporation.

KIR (Kyocera Image Refinement) is a trademark of Kyocera Corporation.

Microsoft, Windows and Internet Explorer are registered trademarks of Microsoft Corporation in the U.S.A. and/or other countries.

Adobe Acrobat and Adobe Reader are trademarks of Adobe Systems, Incorporated.

Pentium is a registered trademark of Intel Corporation.

Other brand and product names contained in this document are registered trademarks or trademarks of their respective companies.

---

---

# Table of Contents

<b>1. Features</b> .....	<b>1</b>
1.1. What is KYOCERA Net Direct Print? .....	1
1.2. System Requirements.....	1
1.3. Support Language .....	1
<b>2. Installation and Startup</b> .....	<b>2</b>
2.1. Download and install from website .....	2
2.2. Install from DVD .....	3
2.3. Startup .....	4
<b>3. Printing PDF</b> .....	<b>5</b>
<b>4. Names and Functions</b> .....	<b>7</b>
<b>5. Printing System Settings</b> .....	<b>8</b>
<b>6. Detailed Settings</b> .....	<b>12</b>



---

# 1. Features

## 1.1. What is KYOCERA Net Direct Print?

**KYOCERA Net Direct Print** is a utility that allows you to print PDF files downloaded from Internet such as catalog and documents without starting Adobe Acrobat/Reader.

## 1.2. System Requirements

The KYOCERA Net Direct Print operates in the following environment. Verify your environment before installation.

Item	Description
OS (Depending on the model)	Microsoft Windows Server 2012 R2/2016/2019† Microsoft Windows 8.1† Microsoft Windows 10† Microsoft Windows 11†
Web Browser	Microsoft Internet Explorer 5.5 or later Microsoft Edge
Hardware	A processor equivalent to a Pentium 200 MHz or greater At least 32 MB of free memory At least 4 MB of free hard disk space SVGA (800 × 600, 256 color) or greater

† Administrator rights are required for installation.

## 1.3. Support Language

**KYOCERA Net Direct Print** supports the following languages: Arabic, Brazilian Portuguese, Czech, Danish, Dutch, English, Finnish, Farsi, French, German, Hebrew, Hungarian, Italian, Japanese, Lithuanian, Korean, Norwegian, Polish, Portuguese, Russian, Simplified Chinese, Spanish, Swedish, Traditional Chinese and Turkish.

## 2. Installation and Startup

There are two ways to install KYOCERA Net Direct Print.

- Download and install the installer from the website
- Install from DVD

### 2.1. Download and install from website

- 1 Launch a web browser.
- 2 Enter “https://kyocera.info/” to the browser's address bar or location bar.

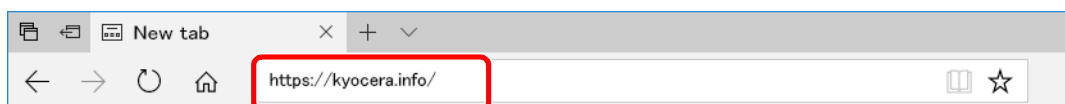

- 3 Enter and search the product name, and select this product from the candidate list.

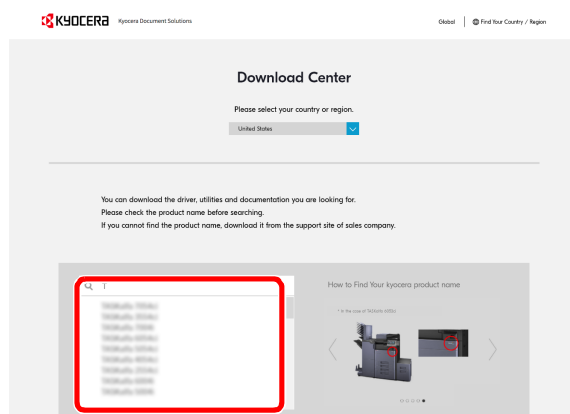

- 4 Change the selected operating system and its language setting as needed.

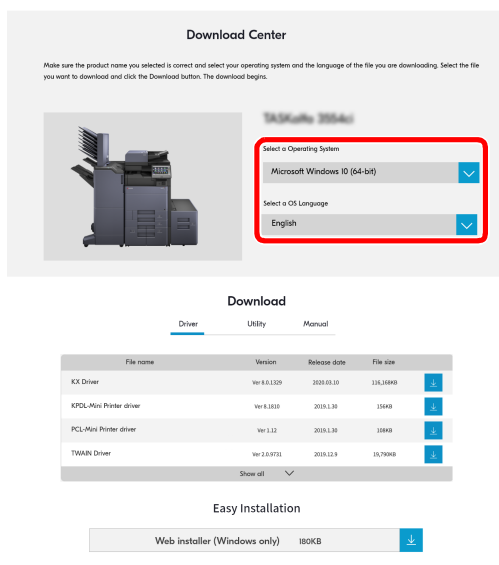

## 5 Select Utility tab > of the **KYOCERA Net Direct Print**.

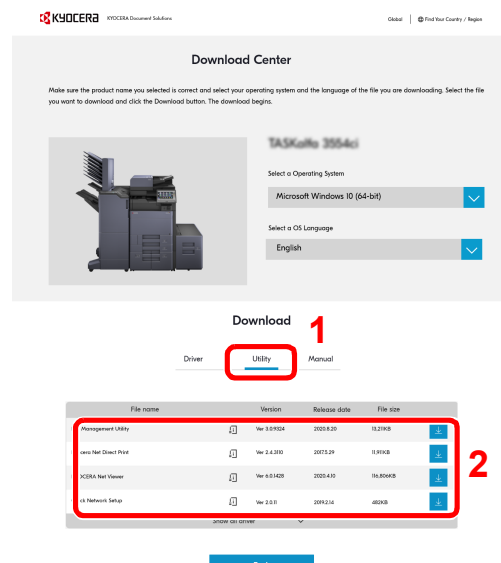

An installer of the selected software will be downloaded.

## 6 Double-click the downloaded installer to launch.

Follow the guidance on the screen to install the software.

### Note

- Installation on Windows must be done by a user logged on with administrator privileges.
- If the user account management window appears, click **[Yes]** (**[Allow]**).

## 2.2. Install from DVD

Install KYOCERA Net Direct Print in your computer.

### 1 Insert the DVD.

### Note

- Installation on Windows must be done by a user logged on with administrator privileges.
- If the “Welcome to the Found New Hardware Wizard” dialog box displays, select **[Cancel]**.
- If the autorun screen is displayed, click **[Run setup.exe]**.
- If the user account management window appears, click **[Yes]** (**[Allow]**).

### 2 Click **[View License Agreement]**, read the License Agreement, and then Click **[Accept]**.

### 3 Select **[Custom Install]**.

### 4 Select the device to be installed.

### 5 Click **[Utility]** tab and select the **KYOCERA Net Direct Print**.

### 6 Click **[Install]**.

When you click [**Install**], a screen asking for your cooperation with data collection will be displayed. Select one of the answer choices and click [**OK**].

- 7** When “Your software is ready to use” appears, Click [**Finish**] to exit the wizard.  
If a system restart message appears, restart the computer by following the screen prompts.

### 2.3. Startup

When the installation is completed, you can start the **KYOCERA Net Direct Print** by proceeding from the start menu > **All Programs** > **Kyocera** > **KYOCERA Net Direct Print**.

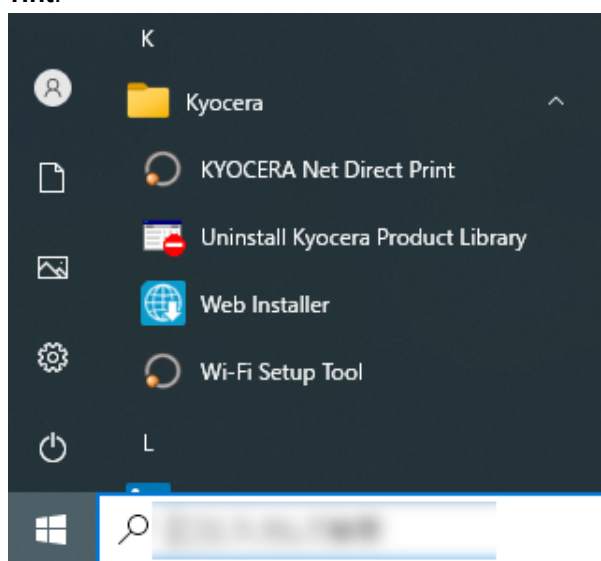



## 3. Printing PDF

Perform the following procedures below to print PDF file using **KYOCERA Net Direct Print**.

### 1 Start **KYOCERA Net Direct Print**.

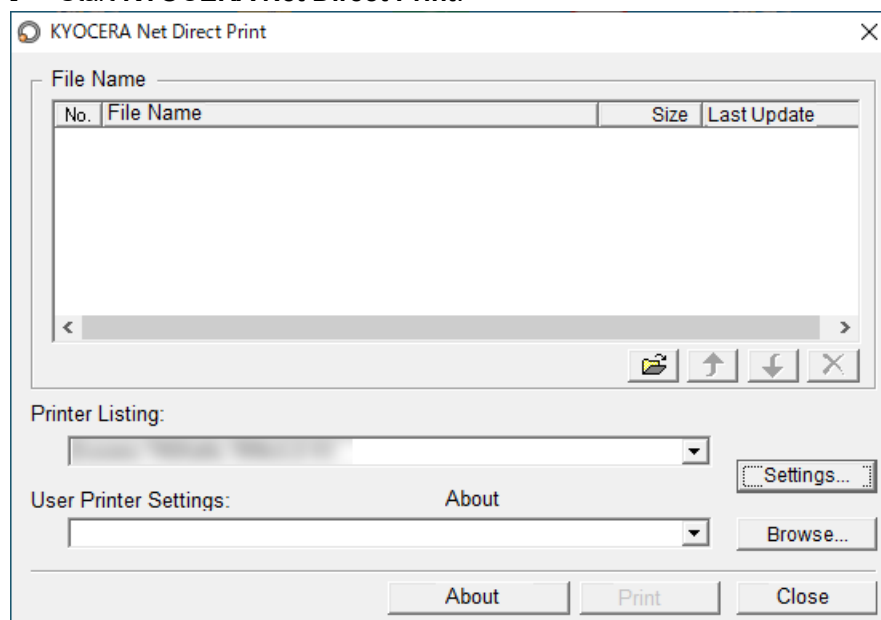

### 2 Add the desired PDF files to the **File Name** list by the following methods.

- Click the **Add** button to select files from the **Open File** dialog box.
- Select the file in Windows explorer and then drag and drop it to the icon for this application (including shortcut).
- Select the file in Windows explorer and then select **KYOCERA Net Direct Print** in the context menu.
- Select the file and then drag and drop it to this window.

### 3 Select the printing system to print PDF files from the **Printer Listing** pull-down menu.

### 4 Click the **Settings** button and make settings for printing. For details, refer to *Printing System Settings* on page 8.

#### Note

When you want to load the previously saved setting, select the setting file from the **User Printer Settings** pull-down menu or click the **Browse** button.

### 5 Click the **Detailed Settings** button and make the detailed settings such as page range for printing and media type. For details, refer to *Detailed Settings* on page 12.

**6** Click the **Print** button. The **Confirmation** dialog box appears.

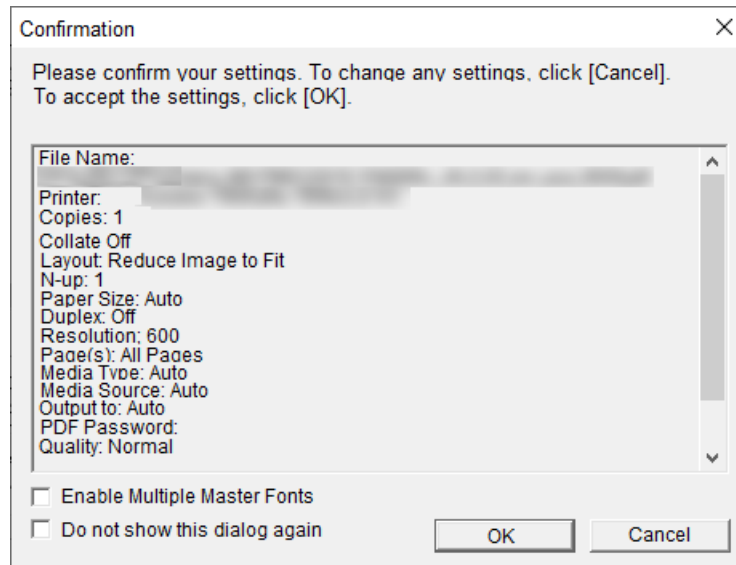

**Notes**





- Checking **Enable Multiple Master Font** and then clicking **OK** enable to generate a version of a character that is optically correct for the size at which it will be viewed on PDF file.
- Checking **Do not show this dialog again** and then clicking **OK** can not be displayed the **Confirmation** dialog box.

**7** When you want to continue printing, click **OK**.

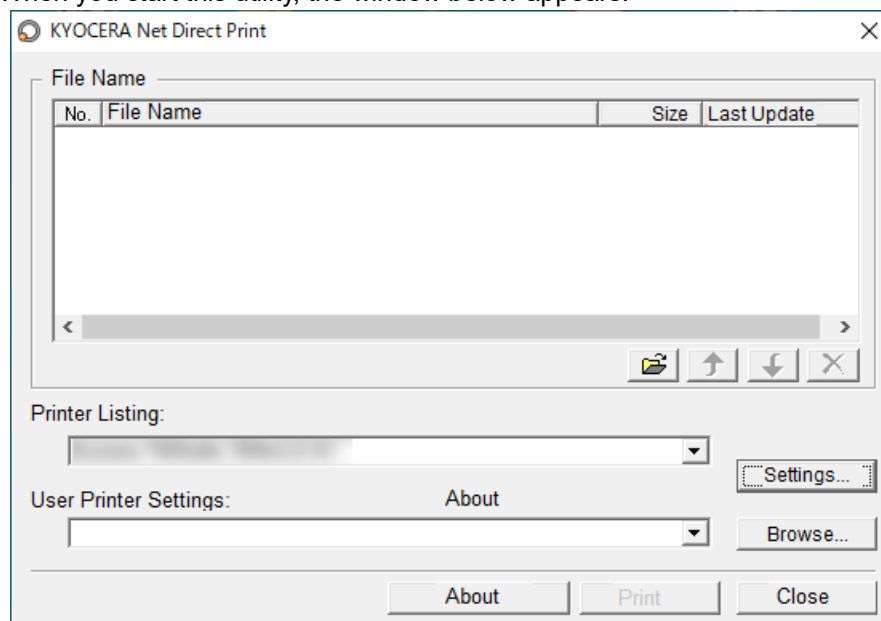
## 4. Names and Functions

When you start this utility, the window below appears.



Name and Icon	Description
<b>Add button</b> 	Displays the <b>Open File</b> dialog box. When you select a valid file, file name, file size and last update are displayed in the <b>File Name</b> list.
<b>Up button</b> 	Moves order of selected files up one or down one.
<b>Down button</b> 	<b>Note</b> You can also change the order by selecting a file and then dragging it to the order you want to change.
<b>Delete button</b> 	Deletes the selected file from the list. <b>Note</b> You can also delete a file by selecting a file and then pressing the <b>Del</b> key on the keyboard.
<b>Printer Listing</b>	Displays the printing systems installed in the system. Select the output target printing system here.
<b>Settings button</b>	Displays the printing system setting dialog box.
<b>User Printer Settings</b>	Displays the names of setting files saved previously.
<b>Browse button</b>	Displays the <b>Open File</b> dialog box to load previously saved setting files.
<b>About button</b>	Displays the version and copyright of this utility.
<b>Print button</b>	Starts the printing process of the file displayed in the <b>File Name</b> list.
<b>Close button</b>	Exits this utility.

## 5. Printing System Settings

You can make frequently used settings as default.

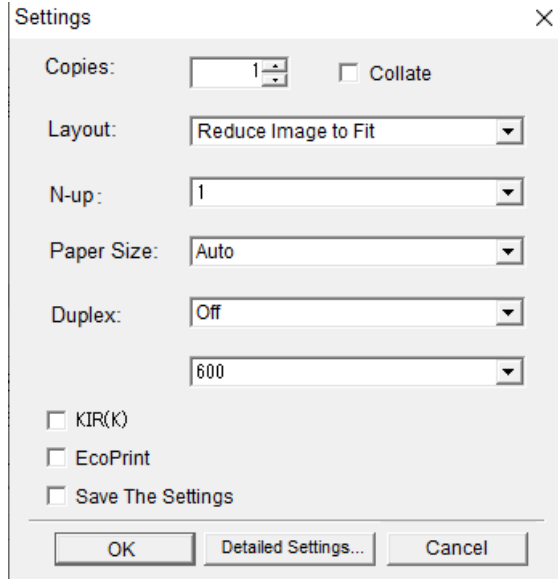

- Copies** Specifies the number of copies. The default setting is 1.
- Collate** Produces the specified number of copies as complete sets of documents. The default setting is disabled (not checked).
- Layout** Specifies the layout of the output. The following layouts are available: **Reduce Image to Fit**, **Through**, **Catalog (Left to Right)**, **Catalog (Right to Left)**, **Booklet (Left Edge Binding)** and **Booklet (Right Edge Binding)**. The default setting is **Reduce Image to Fit**.  
 When you select **Reduce Image to Fit**, the image is enlarged or reduced to fit the printing area of the paper specified in **Paper Size**.  
 When you select **Through**, the image is printed in the same size as the original page regardless of paper size.  
 When you select **Catalog (Left to Right)**, **Catalog (Right to Left)**, **Booklet (Left Edge Binding)** or **Booklet (Right Edge Binding)**, the printing order is as follows.

• **Catalog (Left to Right)**

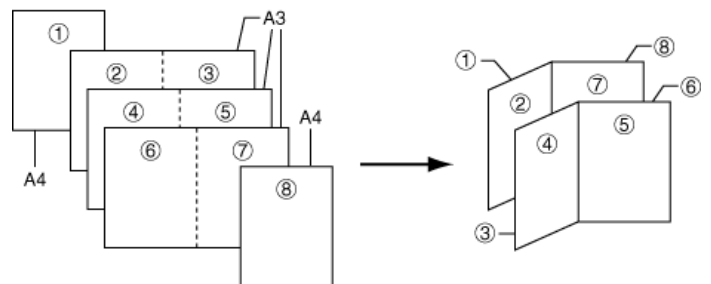

• **Catalog (Right to Left)**

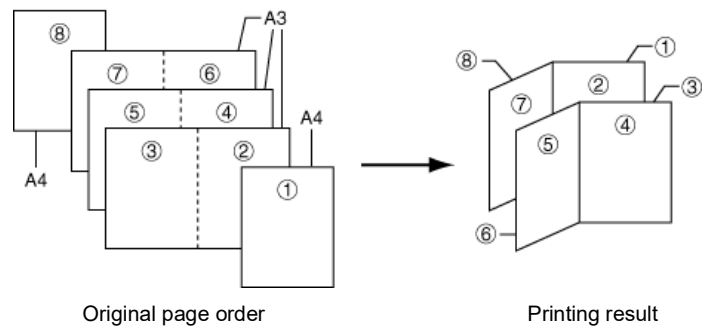

**Note**

If the page order is not in the same order as shown above, the printing results will vary.

• **Booklet (Left Edge Binding)**

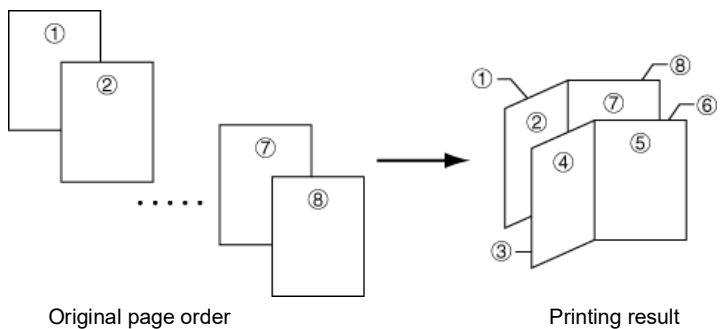

• **Booklet (Right Edge Binding)**

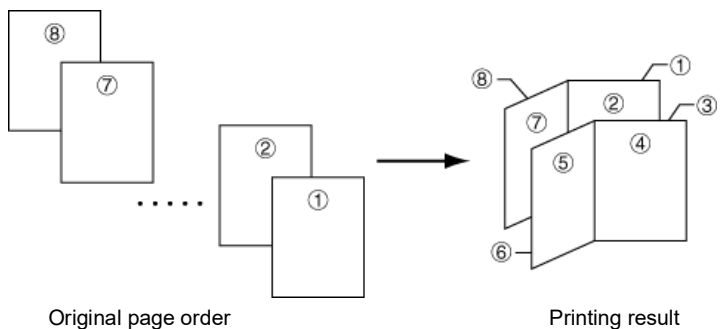

**Note**

Confirm the paper size and load the paper into the cassette before printing. For example, to change the booklet configured in A4 portrait into the double spread page in A3 size, load the A3 size paper. If you load the A4 paper in landscape, a single side is reduced in A5 size, and the double spread pages in A4 are printed.

**N-up**

Specifies the number of pages per sheet. The following value is available: **1**, **2** and **4**. The default setting is **1**.

When N-up settings 2 or 4 are used, the page layouts are as follows.

2-up

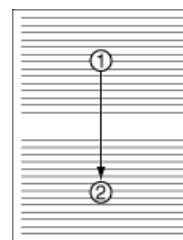
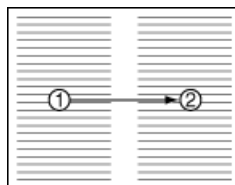

4-up

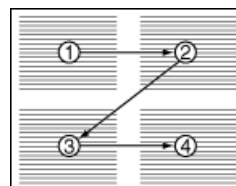
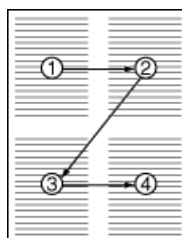

**Note**

If you select **Through** in **Layout**, the value of **N-up** is fixed at 1 and cannot be changed. Furthermore, if you select **Catalog** or **Booklet**, the value is fixed at 2 and cannot be changed.

**Paper Size**

Specifies the paper size applied to the output. The following paper sizes are available:  
**16K, 8K, A3, A4, A5, A6, Auto, B4, B5, B6, C4, Envelope #10, Envelope #6, Envelope #9, Envelope C5, Envelope DL, Executive, Folio, Hagaki, ISO B5, Ledger, Legal, Letter, Monarch, Oficio II, OufukuHagaki, Statement, Youkei 2 and Youkei 4.** The default setting is **Auto**.

**Duplex**

Sets 2-sided printing. The following modes are available: **Off, Flip on Long Edge** and **Flip on Short Edge**. The default setting is **Off**.

**Notes**

If you select **Catalog** or **Booklet** in **Layout**, the value of **Duplex** is fixed at the **Flip on Short Edge** and cannot be changed.

This utility does not automatically recognize whether or not a duplex printing unit is present in a printing system. Therefore, there is a possibility that the duplex printing settings set here may be invalid.

**Resolution**

Specifies the printing resolution. The following resolutions are available: **300, 600, Fast 1200** and **Fine 1200**. The default setting is **600**.

**KIR**

KIR (Kyocera Image Refinement) is a smoothing function that enhances resolution, resulting in high-quality printing. The default setting is disabled (not checked).

**EcoPrint**

Enables the printing system to reduce the amount of toner consumption to save printing costs. The default setting is disabled (not checked).

- Save The Settings** Saves settings in a file.  
When checked, click **OK** to save the settings. You can select the saved file by **Load Setting File** in the main window. The default setting is disabled (not checked)
- Detailed Settings** Displays another dialog box to perform more detailed settings. Information on using the **Detailed Settings** dialog box can be found on the following page

## 6. Detailed Settings

You can make select media type, media source and other detailed settings in this dialog box.

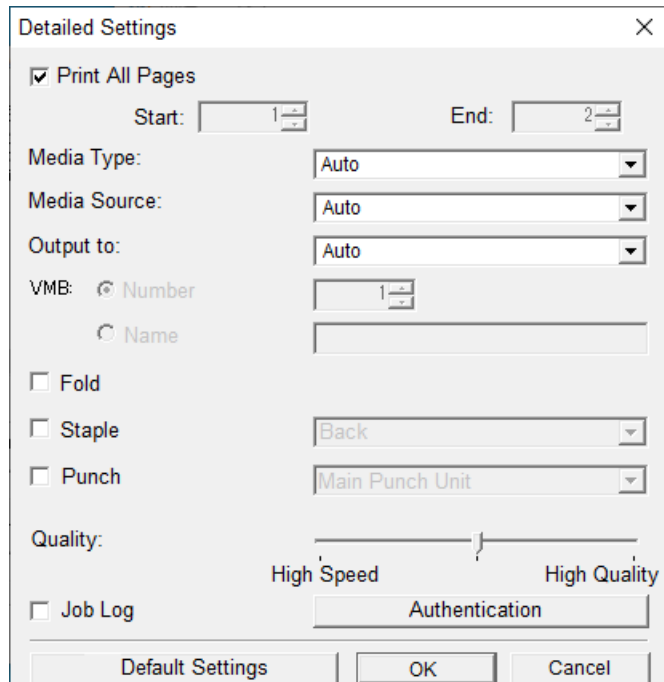

**Print All Pages**

Check to print all pages.

If you remove this check, the range entry boxes are active. Specify the page range for printing.

**Note**

If you select **Catalog** in **Layout** of the **Settings** dialog box, **Print All Pages** is automatically checked and cannot be changed.

**Media Type**

Selects the media type used for printing. The following media types are available: **Auto, Plain, Transparency, Preprinted, Labels, Bond, Recycled, Vellum, Rough, Letterhead, Color, Prepunched, Envelope, Cardstock, Coated, 2nd Side, Thick, High Quality** and **Custom 1** (to 8). The default setting is **Auto**.

**Media Source**

Specifies the paper supply cassette. The following media sources are available: **Auto, Multi Purpose Tray, Cassette1, Cassette2, Cassette3, Cassette4, Cassette5, Cassette6** and **Envelope Feeder**. The default setting is **Auto**.

**Note**

The setting may be ignored depending on the configuration of the printing system.



<b>Output to</b>	<p>Specifies the paper output destination. The following destinations are available: <b>Auto</b>, <b>Face Up Tray</b>, <b>Face Down Tray</b>, <b>Finisher Tray (Face Down)</b> and <b>VMB</b>. The default setting is <b>Auto</b>.</p> <p><b>Note</b> The setting may be ignored depending on the configuration of the printing system.</p>
<b>VMB</b> (Virtual MailBox)	<p>This is active when <b>VMB</b> is specified as the <b>Output to</b> destination above. <b>Virtual Mailbox</b> feature, mailboxes created on the hard disk are assigned to multiple users. Jobs posted to a virtual mailbox can be printed later from the operation panel of the printing system.</p> <p><b>Number:</b> specifies the mailbox by the number. the number should be 1 to 255.</p> <p><b>Name:</b> specifies the mailbox by the name.</p> <p><b>Note</b> The setting may be ignored depending on the configuration of the printing system.</p>
<b>Fold</b>	<p>Folds copies for booklet format. The default setting is disabled (not checked).</p>
<b>Staple</b>	<p>Staples each copy set. The default setting is disabled (not checked).</p> <p>When this item is enabled, the combo box is active allowing you to select that result. The following staple positions are available: <b>Back</b>, <b>Booklet</b> and <b>Front</b>.</p>
<b>Punch</b>	<p>Makes copies hole punched. The default setting is disabled (not checked).</p> <p>When this item is enabled, the combo box is active allowing you to select that result. The following value are available: <b>Main Punch Unit</b> and <b>Sub Punch Unit</b>.</p> <p><b>Note</b> The setting may be ignored depending on the configuration of the printing system.</p>
<b>PDF Password</b>	<p>Enter the password required to print encrypted PDF files. The password should be 32 characters maximum.</p>
<b>Quality</b>	<p>You can choose the printing quality, from <b>High Quality</b> to <b>High Speed</b>. Move the slider to the left to select a <b>High Speed</b> or to the right to select a <b>High Quality</b>. The default setting is center.</p> <p><b>Note</b> The setting is enabled only when the PDF file to print is PDF version 1.4 or later file and using Transparency Flattening function. Otherwise the setting is ignored.</p> <p>PDF version can be confirmed on the window displayed by which selecting from File menu &gt; Document Properties &gt; Summary.</p> <p>Transparency Flattening function can be confirmed on the Advanced Print Setup dialog box.</p>

### Job Log

Maintains a log in the system that indicates printed PDF files and the date/time of printing. Entering a check mark for this item enables the Job Log.

For details on the Job Log, refer to the Operation Guide of the printing system.

### Authentication

Displays **Authentication** dialog box.

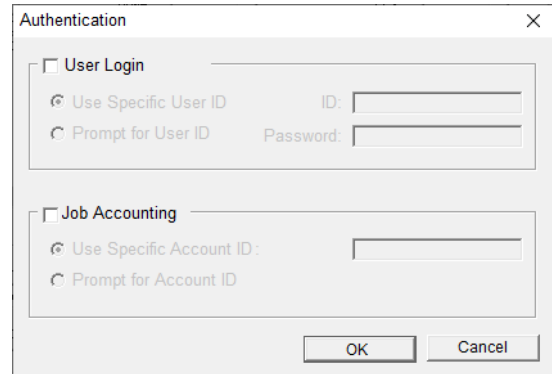

#### User Login

To use user login function, click **User Login** to check. For details on user login function, refer to *Operation Guide* of the printing system. Select **Use Specific User ID** when always printing with same ID. Select **Prompt for User ID** when printing with several different IDs. This prompt you to enter the **User ID** and **Password** at each time you print on the printing system.

#### Job Accounting

To use job accounting function, click Job Accounting to check. For details on job accounting, refer to *Operation Guide* of the printing system. Select **Use Specific Account ID** when always printing with same ID. Select **Prompt for Account ID** when printing with several different IDs. This prompt you to enter the **Account ID** at each time you print on the printing system.

### Default Settings

Returns all settings to their initial state.



