

SAMSUNG

User Manual

S49CG95*

The color and the appearance may differ depending on the product, and the specifications are subject to change without prior notice to improve the performance.

The contents of this manual are subject to change without notice to improve quality.

© Samsung

Samsung owns the copyright for this manual.

Use or reproduction of this manual in parts or entirety without the authorization of Samsung is prohibited.

Trademarks other than that of Samsung are owned by their respective owners.

Contents

Before Using the Product

Safety Precautions

- 3 Electricity and Safety
- 4 Installation
- 4 Operation

Cleaning

Correct posture to use the product

Preparations

Installation

- 7 Attaching the Stand
- 8 Precautions for moving the product
- 9 Checking the space around the product
- 9 Adjusting the Product Tilt and Height
- 10 Attaching the BRACKET WALL

Control Panel

Connections

Ports

- 13 Connecting the Product to a PC as a USB HUB

Tidying Up the Connected Cables

Precautions and Notes

Read After Installing the product

- 15 Picture sizes and input signals

Read Before Connecting a Computer (Supported Resolutions)

- 16 VESA DMT
- 17 VESA CVT
- 17 CVT Custom

Supported Resolutions for Video Signals

- 18 CTA-861
- 18 List of graphic cards supporting HDR10

Specifications

General

Appendix

Responsibility for the Pay Service (Cost to Customers)

- 21 Not a product defect
- 21 A Product damage caused by customer's fault
- 21 Others

FreeSync Premium pro (for AMD graphics card)

- 23 The models in the Graphics Cards list supports FreeSync Premium pro

Supported Resolutions for FreeSync Premium pro (VRR)

- 24 HDMI
- 24 DP

Before Using the Product







Safety Precautions

Warning

A serious or fatal injury may result if instructions are not followed.

Caution

Personal injury or damage to properties may result if instructions are not followed.

CAUTION			
RISK OF ELECTRIC SHOCK. DO NOT OPEN.			
CAUTION: TO REDUCE THE RISK OF ELECTRIC SHOCK, DO NOT REMOVE COVER (OR BACK). THERE ARE NO USER SERVICEABLE PARTS INSIDE. REFER ALL SERVICING TO QUALIFIED PERSONNEL.			
	This symbol indicates that high voltage is present inside. It is dangerous to make any kind of contact with any internal part of this product.		AC voltage: Rated voltage marked with this symbol is AC voltage.
	This symbol indicates that this product has included important literature concerning operation and maintenance.		DC voltage: Rated voltage marked with this symbol is DC voltage.
	Class II product: This symbol indicates that a safety connection to electrical earth (ground) is not required. If this symbol is not present on a product with a mains lead, the product MUST have a reliable connection to protective earth (ground).		Caution. Consult instructions for use: This symbol instructs the user to consult the user manual for further safety related information.

Electricity and Safety

Warning

- Do not use a damaged power cord or plug, or a loose power socket.
- Do not use multiple products with a single power socket.
- Do not touch the power plug with wet hands.
- Insert the power plug all the way in so it is not loose.
- Connect the power plug to a grounded power socket (type 1 insulated devices only).
- Do not bend or pull the power cord with force. Be careful not to leave the power cord under a heavy object.
- Do not place the power cord or product near heat sources.
- Clean any dust around the pins of the power plug or the power socket with a dry cloth.

Caution

- Do not disconnect the power cord while the product is being used.
- Only use the power cord provided with your product by Samsung. Do not use the power cord with other products.
- Keep the power socket where the power cord is connected unobstructed.
 - The power cord must be disconnected to cut off power to the product when an issue occurs.
- Hold the plug when disconnecting the power cord from the power socket.

Installation

Warning

- DO NOT PLACE CANDLES, INSECT REPELLANTS OR CIGARETTES ON TOP OF THE PRODUCT. DO NOT INSTALL THE PRODUCT NEAR HEAT SOURCES.
- Keep the plastic packaging out of the reach of children.
 - Children may suffocate.
- Do not install the product on an unstable or vibrating surface (insecure shelf, sloped surface, etc.)
 - The product may fall and become damaged and/or cause an injury.
 - Using the product in an area with excess vibration may damage the product or cause a fire.
- Do not install the product in a vehicle or a place exposed to dust, moisture (water drips, etc.), oil, or smoke.
- Do not expose the product to direct sunlight, heat, or a hot object such as a stove.
 - The product lifespan may be reduced or a fire may result.
- Do not install the product within the reach of young children.
 - The product may fall and injure children.
- Edible oil (such as soybean oil) may damage or distort the product. Keep the product away from oil pollution. And do not install or use the product in the kitchen or near the kitchen stove.

Caution

- Do not drop the product while moving.
- Do not set down the product on its front.
- When installing the product on a cabinet or shelf, make sure that the bottom edge of the front of the product is not protruding.
 - The product may fall and become damaged and/or cause an injury.
 - Install the product only on cabinets or shelves of the right size.
- Set down the product gently.
 - Product failure or personal injury may result.
- Installing the product in an unusual place (a place exposed to a lot of fine dust, chemical substances, extreme temperatures or a significant presence of moisture, or a place where the product will operate continuously for an extended period of time) may seriously affect its performance.
 - Be sure to consult Samsung Customer Service Center if you want to install the product at such a place.
- Before assembling the product, place the product down on a flat and stable surface so that the screen is facing downwards.
 - The product is curved. Placing pressure on the product when on a flat surface may damage the product. When the product is on the ground facing up or down, do not put pressure on it.

Operation

Warning

- There is a high voltage inside the product. Never disassemble, repair or modify the product yourself.
 - Contact Samsung Customer Service Center for repairs.
- To move the product, first disconnect all the cables from it, including the power cord.
- If the product generates abnormal sounds, a burning smell or smoke, disconnect the power cord immediately and contact Samsung Customer Service Center.
- Do not let children hang from the product or climb on top of it.
 - Children may become injured or seriously harmed.
- If the product is dropped or the outer case is damaged, turn off the power and disconnect the power cord. Then contact Samsung Customer Service Center.
 - Continued use can result in a fire or electric shock.

- Do not leave heavy objects or items that children like (toys, sweets, etc.) on top of the product.
 - The product or heavy objects may fall as children try to reach for the toys or sweets resulting in a serious injury.
- During a lightning or thunderstorm, power off the product and remove the power cord.
- Do not drop objects on the product or apply impact.
- Do not move the product by pulling the power cord or any cable.
- If a gas leakage is found, do not touch the product or power plug. Also, ventilate the area immediately.
- Do not lift or move the product by pulling the power cord or any cable.
- Do not use or keep combustible spray or an inflammable substance near the product.
- Ensure the vents are not blocked by tablecloths or curtains.
 - An increased internal temperature may cause a fire.
- Do not insert metallic objects (chopsticks, coins, hairpins, etc) or objects that burn easily (paper, matches, etc) into the product (via the vent or input/output ports, etc).
 - Be sure to power off the product and disconnect the power cord when water or other foreign substances have entered the product. Then contact Samsung Customer Service Center.
- Do not place objects containing liquid (vases, pots, bottles, etc) or metallic objects on top of the product.
 - Be sure to power off the product and disconnect the power cord when water or other foreign substances have entered the product. Then contact Samsung Customer Service Center.

Caution

- Leaving the screen fixed on a stationary image for an extended period of time may cause afterimage burn-in or defective pixels.
 - Set the screen to power-saving mode or moving-picture screen saver when not using the product for an extended period of time.
- Disconnect the power cord from the power socket if you do not plan on using the product for an extended period of time (vacation, etc).
 - Dust accumulation combined with heat can cause a fire, electric shock or electric leakage.
- Use the product at the recommended resolution and frequency.
 - Your eyesight may deteriorate.
- Do not hold the product upside-down or move it by holding the stand.
 - The product may fall and become damaged or cause an injury.
- Looking at the screen too close for an extended period of time can deteriorate your eyesight.
- Do not use humidifiers or stoves around the product.
- Rest your eyes for more than 5 minutes or look at distance objects for every 1 hour of product use.
- Do not touch the screen when the product has been turned on for an extended period of time as it will become hot.
- Store small accessories out of the reach of children.
- Exercise caution when adjusting the product angle or stand height.
 - Your hand or finger may get stuck and injured.
 - Tilting the product at an excessive angle may cause the product to fall and an injury may result.
- Do not place heavy objects on the product.
 - Product failure or personal injury may result.

Cleaning

High-glossy models can develop white stains on the surface if an ultrasonic wave humidifier is used nearby.

- ✎ Contact your nearest Samsung Customer Service Center if you want to clean the inside of the product (Service fee will be charged.)

Do not press the product screen with hands or other objects. There is a risk of damaging the screen.

- ✎ Exercise care when cleaning as the panel and exterior of advanced LCDs are easily scratched.

Take the following steps when cleaning.

1. Power off the product and PC.
2. Disconnect the power cord from the product.
- ✎ Hold the power cord by the plug and do not touch the cable with wet hands. Otherwise, an electric shock may result.
3. Wipe the product with a clean, soft and dry cloth.
Wet a soft cloth in water, wring it out well, and then use the cloth to wipe the exterior of the product clean.
 - Do not apply a cleaning agent that contains alcohol, solvent, or surfactant to the product.
 - Do not spray water or detergent directly on the product.
4. Connect the power cord to the product when cleaning is finished.
5. Power on the product and PC.

Correct posture to use the product





Use the product in the correct posture as follows:

- Straighten your back.
- Allow a distance of 45 to 50cm between your eye and the screen, and look slightly downward at the screen.
- Keep your eyes directly in front of the screen.
- Adjust the angle so light does not reflect on the screen.
- Keep your forearms perpendicular to your upper arms and level with the back of your hands.
- Keep your elbows at about a right angle.
- Adjust the height of the product so you can keep your knees bent at 90 degrees or more, your heels attached to the floor, and your arms lower than your heart.
- Do the Eye exercises or blink frequently, then eye fatigue will be relieved.

Preparations

Installation

Attaching the Stand

-  Before assembling the product, place the product down on a flat and stable surface so that the screen is facing downwards.
-  Disassembly is the reverse order of assembly.

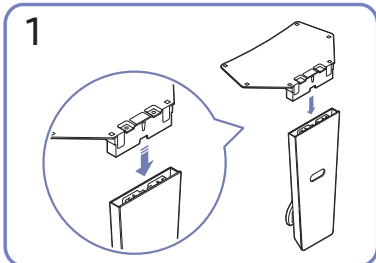
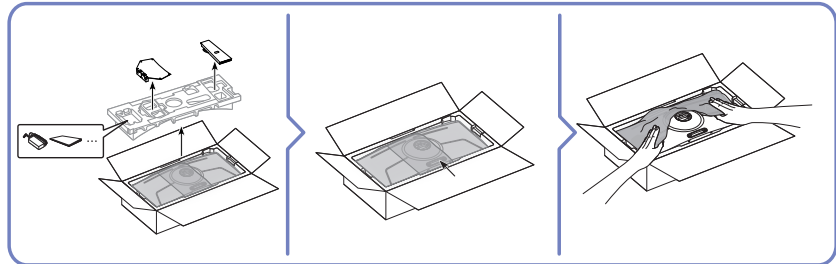
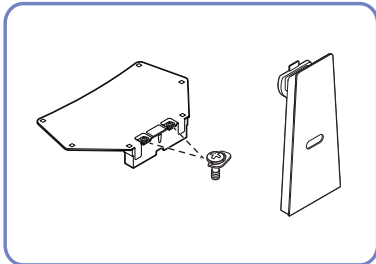

Put the stand base onto the stand neck as the direction shown in the figure. Check that the stand neck is firmly connected.

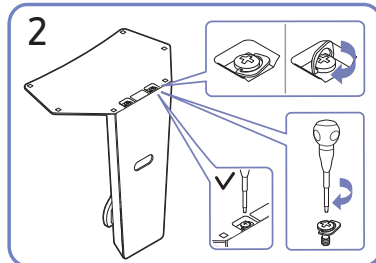

Tightly fasten the connecting screw at the bottom of the stand base.

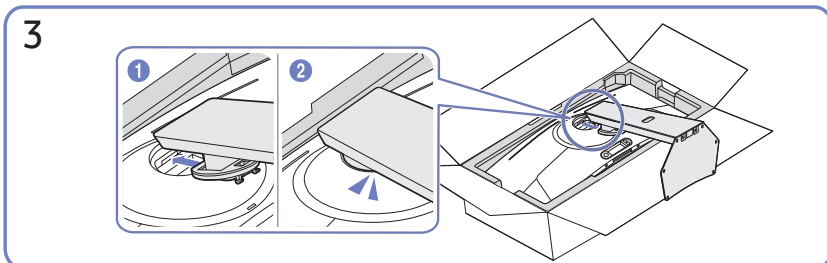

Push the assembled stand into the main body in the direction of the arrow as shown in the figure.

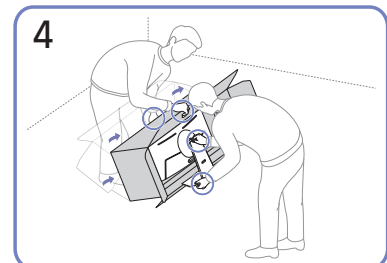

Stand up the monitor as shown in the figure.

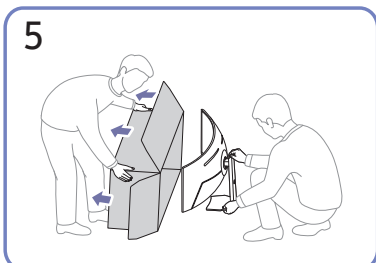

Separate the box from the product.

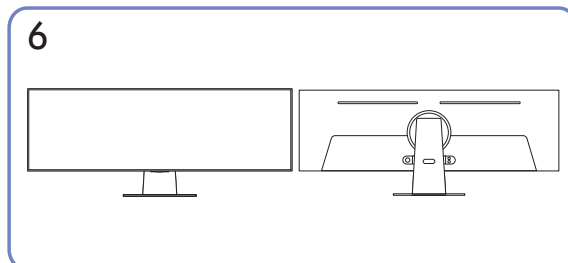

Stand assembly is complete.

Precautions for moving the product

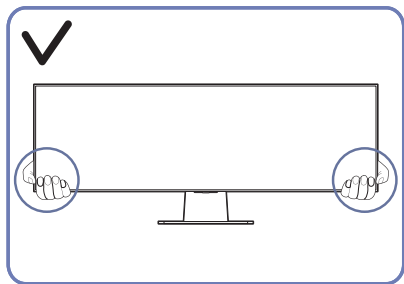

Hold the lower corners or edges of the product when moving it.

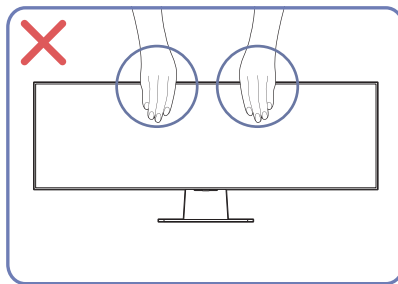

Do not directly apply pressure on the screen.
Do not hold the screen when moving the product.

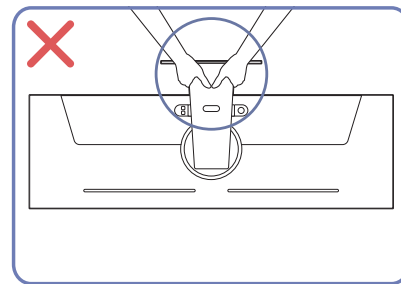

Do not hold the product upside down only by the stand.

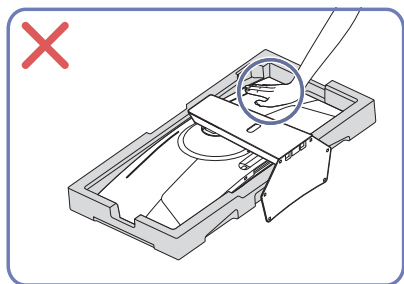

Do not press down on the product.
There is a risk of damaging the product.

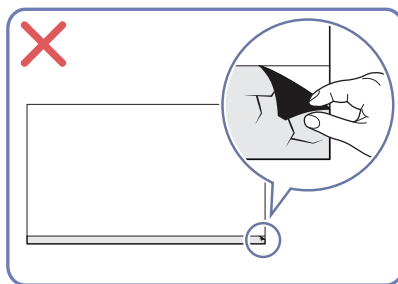

Checking the space around the product

Make sure to have enough space for ventilation when placing the product. An internal temperature rise may cause fire and damage the product. Maintain enough space around the product as shown in the diagram when installing the product.

 The exterior may differ depending on the product.

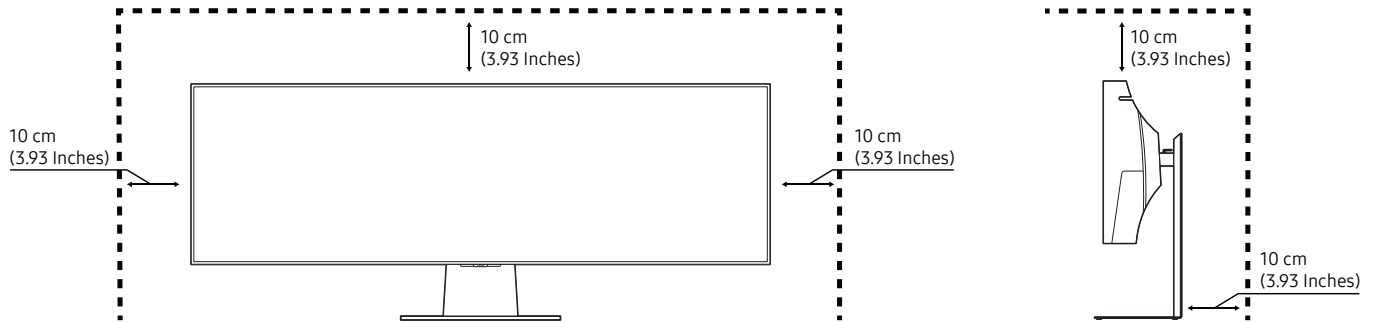

Adjusting the Product Tilt and Height

 The color and shape of parts may differ from what is shown. Specifications are subject to change without notice to improve quality.

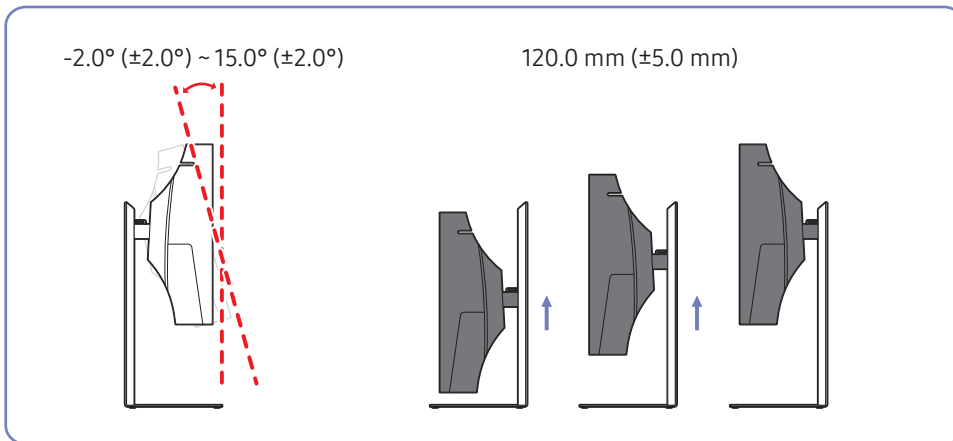

- The product tilt and height can be adjusted.
- When adjusting the tilt and height, hold both sides of the product and avoid using excessive force to prevent damage.
- When adjusting the stand height, you may hear a noise. This noise is generated because the ball inside the stand slides when the stand height is adjusted. It is a normal noise and not a product malfunction.

Attaching the BRACKET WALL

- The bracket may not be supplied, depending on the country and region.
- Power the product off and remove the power cord from the power socket.

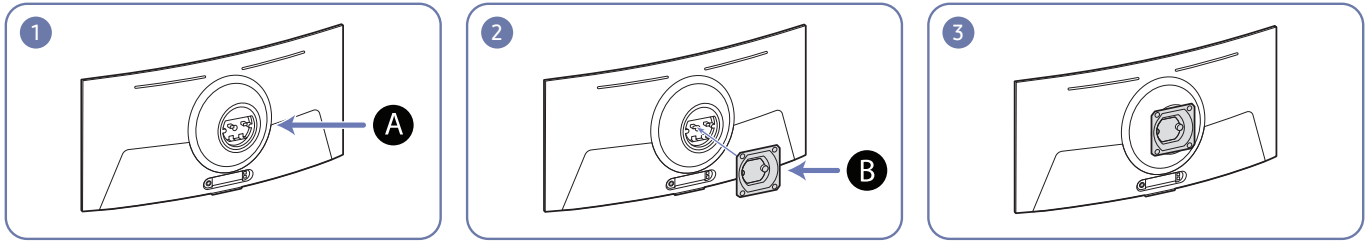

A Attach the BRACKET WALL here

B BRACKET WALL

Align **B** with **A** on the monitor, and tightly fasten the screws on **B**.

Notes

- Using a screw longer than the standard length can damage the internal components of the product.
- The length of screws required for a wall mount that does not comply with the VESA standards may vary depending on the specifications.
- Do not use screws that do not comply with the VESA standards. Do not attach the wall-mount kit or desktop stand using excessive force. The product may get damaged or fall and cause personal injury. Samsung shall not be held liable for any damage or injury caused by using improper screws or attaching the wall-mount kit or desktop stand using excessive force.
- Samsung shall not be held liable for any product damage or personal injury caused by using a wall-mount kit other than the one specified or from an attempt to install the wall-mount kit on your own.
- To mount the product on a wall, ensure you purchase a wall-mount kit that can be installed 10 cm or farther away from the wall.
- Be sure to use a wall-mount kit that complies with the standards.
- To install the monitor using a wall mount, disconnect the stand base from the monitor.

Model name	VESA screw hole specs (A * B) in millimeters	C	Standard Screw	Quantity	
S49CG95*	100.0 x 100.0	3.5 ~ 5.5 mm	M4	4 EA	

- The bracket may not be supplied, depending on the country and region.
- Do not install your Wall Mount Kit while your product is turned on. It may result in personal injury due to electric shock.
- Do not mount the product at more than a 15 degree tilt.

Control Panel

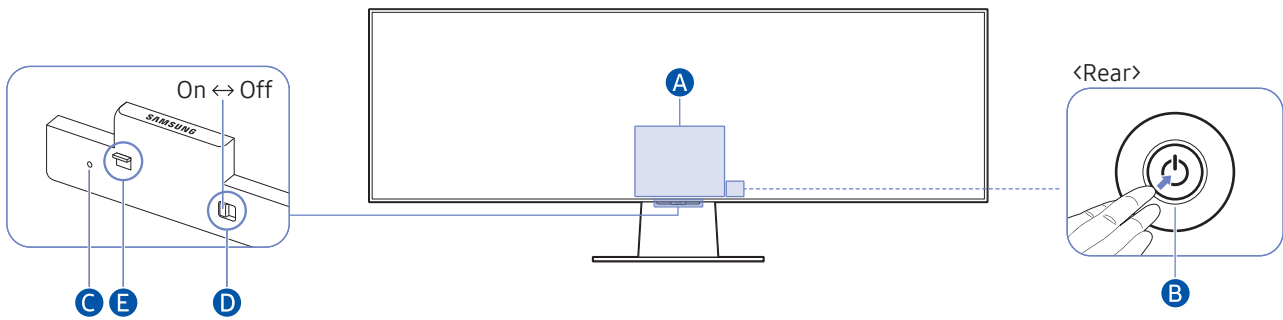

 You can turn on the product with the Power button, and then use the Control menu. The Control menu appears when the Power button is pressed while the product is On.



A Control menu



B Controller button

- Press  button: Display the Control menu. Select or run a focused item on the menu.
- Press and hold  button: The running function is terminated.
- Up/Down button: Changes the channel.
- Left/Right button: Changes the volume.

 The buttons may work differently depending on the situation.

C Microphone

D Microphone switch

You can turn on or off the microphone by using the switch at the bottom of the Product.

If microphone is turned off, All voice and sound features using microphone are not available.

- The position and shape of the microphone switch may differ depending on the model.
- During analysis using data from the microphone, the data is not saved.

E Power indicator

- The LED turns on when the product is turned off.
- The LED blinks when the product enters the standby mode.

 When 60 seconds elapses with no signal, the product enters the standby mode. In standby mode, the screen turns on again when any signal is input or any button is pressed on the remote control.

- The color and shape of parts may differ from what is shown.
- The screen may dim if the protective film on the SAMSUNG logo or the bottom of the product is not detached. Please remove the protective film.
- When using the buttons (excluding Power) on the Samsung Smart Remote, the receiver LED does not blink.







Connections

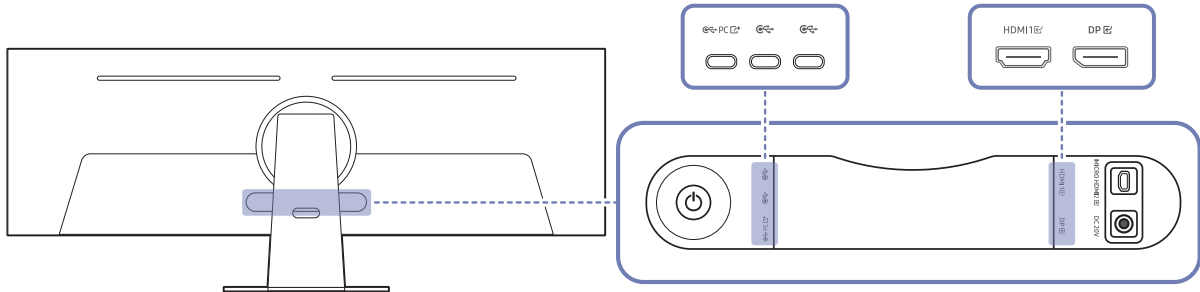



Using various connectors, you can also connect external devices.

Ports

 The functions available may vary depending on the product model. The color and shape of parts may differ from what is shown. Specifications are subject to change without notice to improve quality. Refer to the actual product.



Port	Description
 PC 	Connects to a PC using a USB cable. It operates as USB 3.0 only when using USB HUB.  For more information, see Connecting the Product to a PC as a USB HUB page.
	Connects to a USB device, such as a keyboard or mouse. Used to update the software.
HDMI 1 	Connects to a source device using an HDMI cable or HDMI-DVI cable.
DP 	Connects to a PC using a DP cable.
MICRO HDMI 2 	Connects to an external device using the HDMI cable supplied by Samsung (which is a High Speed HDMI certified cable).
DC 20V	Connects to the AC/DC adapter.

 For more information about connection to an external device, refer to  >  **Menu** >  **Connected Devices** > **Connection Guide**.

 When a still screen, such as a document, is displayed and the keyboard or mouse is left idle for more than 5 minutes, the screen slightly dims.

The brightness is restored when a keyboard button is pressed or the mouse is moved or clicked.

Connecting the Product to a PC as a USB HUB

Using the product as a hub, connect and use various source devices with the product at a time.

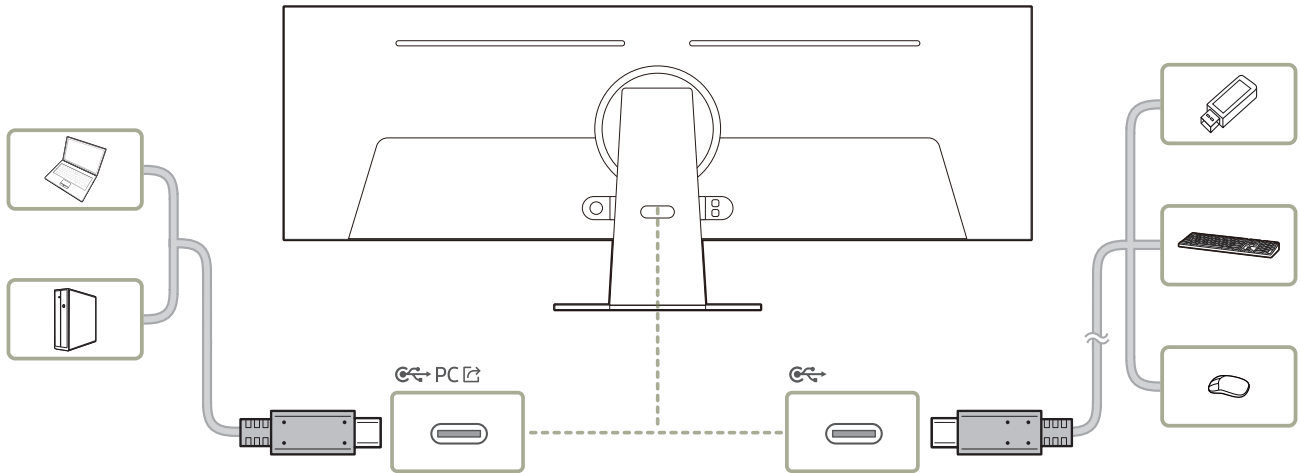

- ✎ To detect and start a USB device faster, connect the USB device to the  port on the product. The read/write rate will be affected by the USB device and your PC.
- ✎ For USB-related problems caused by OS, drive programs or software, please contact relevant suppliers.
- ✎ With the launch of various USB devices on the market, we cannot guarantee that our products are matched with all USB devices.
- ✎ For an external mass-storage HDD requiring external power supply, be sure to connect it to an external power source.
- ✎ The company is not liable for problems or damages to an external device caused by using an unauthorized cable for the connection.
- ✎ Some products do not follow the USB standard, and it may cause a malfunction of the device.

Tidying Up the Connected Cables

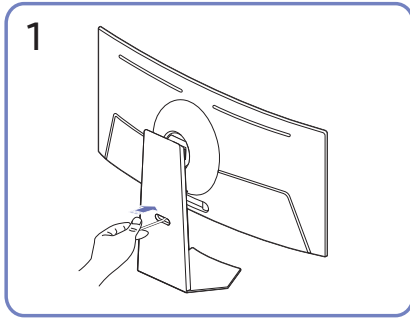

Pass cables through the hole on the stand.

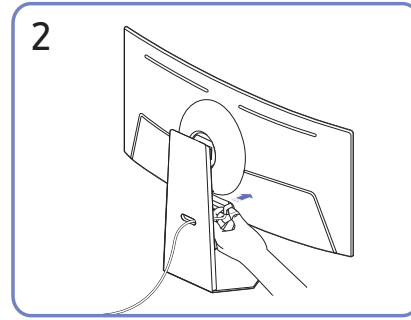

Connect the cables to the corresponding ports.

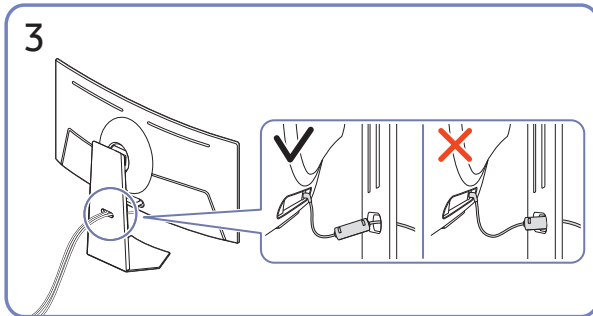

Organize cables by passing them through the hole on the stand, as shown in the figures.

Precautions and Notes

You can get instructions and information that you must read after installation.

Read After Installing the product

Read this information after installing the product.

Picture sizes and input signals

The **Picture Size** is applied to the current source. The applied **Picture Size** will remain in effect whenever you select that source unless you change them.

Input signal	Picture size
HDMI (3840 x 1080 @ 120 Hz)	32:9, 16:9
HDMI (5120 x 1440 @ 240 Hz)	32:9, 16:9
DisplayPort (5120 x 1440 @ 120 Hz)	32:9, 16:9
DisplayPort (5120 x 1440 @ 240 Hz)	32:9, 16:9



 The input ports for external devices may differ depending on the model and geographical area.

 Available **Picture Mode** may differ depending on the external device.

Read Before Connecting a Computer (Supported Resolutions)

Check the resolutions supported for PC input signals.

When you connect your product to a computer, set the computer's video card to one of the standard resolutions listed in the tables below or on the next pages. The product will automatically adjust to the resolution you choose. The optimal recommended resolution is 5120 x 1440 @ 120 Hz when **Game Mode** is on. Choosing a resolution not included in the tables can result in a blank screen or just the remote control sensor turning on. Refer to the user manual of your graphics card for compatible resolutions.

-  With **Input Signal Plus** enabled, the optimal resolutions are 3840 x 1080 @ 120 Hz (HDMI) and 5120 x 1440 @ 120 Hz (DisplayPort).
-  With **Input Signal Plus** disabled, the optimal resolution is 3840 x 1080 @ 60 Hz (HDMI, DisplayPort).
-  If the resolution is set to an unsupported one, the "**Mode Not Supported**" message may appear or noise may occur on the screen. Make sure to set the resolution to a supported one.

VESA DMT

Resolution (Dots x lines)	Display format	Horizontal frequency (KHz)	Vertical frequency (Hz)	Clock frequency (MHz)	Polarity (horizontal / vertical)	Port	
						HDMI	DP
640 x 480	60 Hz	31.469	59.940	25.175	- / -	0	0
640 x 480	75 Hz	37.500	75.000	31.500	- / -	0	0
800 x 600	60 Hz	37.879	60.317	40.000	+ / +	0	0
800 x 600	72 Hz	48.077	72.188	50.000	+ / +	0	0
800 x 600	75 Hz	46.875	75.000	49.500	+ / +	0	0
1024 x 768	60 Hz	48.363	60.004	65.000	- / -	0	0
1024 x 768	70 Hz	56.476	70.069	75.000	- / -	0	0
1024 x 768	75 Hz	60.023	75.029	78.750	+ / +	0	0
1152 x 864	75 Hz	67.500	75.000	108.000	+ / +	0	0
1280 x 720	60 Hz	45.000	60.000	74.250	+ / +	0	0
1280 x 800	60 Hz	49.702	59.810	83.500	- / +	0	0
1280 x 1024	60 Hz	63.981	60.020	108.000	+ / +	0	0
1280 x 1024	75 Hz	79.976	75.025	135.000	+ / +	0	0
1440 x 900	60 Hz	55.935	59.887	106.500	- / +	0	0
1600 x 900RB	60 Hz	60.000	60.000	108.000	+ / +	0	0
1680 x 1050	60 Hz	65.290	59.954	146.250	- / +	0	0
2560 x 1440RB	60 Hz	88.787	59.951	241.500	+ / -	0	0

VESA CVT

Resolution (Dots x lines)	Display format	Horizontal frequency (KHz)	Vertical frequency (Hz)	Clock frequency (MHz)	Polarity (horizontal / vertical)	Port	
						HDMI	DP
1920 x 1080RB	240 Hz	271.364	239.932	597.000	+ / -	0	0
2560 x 1440RB	120 Hz	182.996	119.998	497.750	+ / -	0	0

CVT Custom

Resolution (Dots x lines)	Display format	Horizontal frequency (KHz)	Vertical frequency (Hz)	Clock frequency (MHz)	Polarity (horizontal / vertical)	Port	
						HDMI	DP
2560 x 1440RB	240 Hz	355.919	240.000	1010.810	+/-	0	-
2560 x 1440RB	240 Hz	359.722	240.000	1036.000	+/-	-	0
3840 x 1080	60 Hz	66.658	59.998	274.630	+/-	0	0
3840 x 1080	120 Hz	137.279	119.999	565.590	+/-	0	0
3840 x 1080	240 Hz	291.600	240.000	1201.390	+/-	0	0
5120 x 1440	60 Hz	88.859	60.000	479.840	+/-	0	0
5120 x 1440	120 Hz	182.880	120.000	987.550	+/-	0	0
5120 x 1440	240 Hz	356.879	240.000	1941.420	+/-	0	0

Supported Resolutions for Video Signals

Check the resolutions supported for video signals.

CTA-861

Resolution (Dots x lines)	Display format	Horizontal frequency (KHz)	Vertical frequency (Hz)	Clock frequency (MHz)	Polarity (horizontal / vertical)	Port	
						HDMI	DP
720 x 576	50 Hz	31.250	50.000	27.000	-/-	0	0
720 x 480	60 Hz	31.469	59.940	27.000	-/-	0	0
1280 x 720	50 Hz	37.500	50.000	74.250	+/+	0	0
1280 x 720	60 Hz	45.000	60.000	74.250	+/+	0	0
1920 x 1080	50 Hz	56.250	50.000	148.500	+/+	0	0
1920 x 1080	60 Hz	67.500	60.000	148.500	+/+	0	0
1920 x 1080	120 Hz	135.000	120.003	297.000	+/+	0	0
3840 x 2160	30 Hz	67.500	30.000	297.000	+/+	0	0
3840 x 2160	50 Hz	112.500	50.000	594.000	+/+	0	0
3840 x 2160	60 Hz	135.000	60.000	594.000	+/+	0	0

List of graphic cards supporting HDR10

HDR10 is accessible only on Windows 10 systems equipped with graphic cards that support Play Ready 3.0 Digital Rights Management (for protected HDR content). Use graphic cards listed below for HDR10.

- NVIDIA GeForce 1000 series or higher
 - AMD Radeon™ RX 400 series or higher
 - Intel UHD Graphics 600 series or higher
-  Graphic cards that support hardware-accelerated 10-bit video decoding for HDR video codecs are recommended.

Specifications

General

Model Name		S49CG95*
Size		49 Class (48.9 Inches / 124.3 cm)
Display area		1196.7 mm (H) x 339.2 mm (V)
Pixel Pitch		0.233 mm (H) x 0.233 mm (V)
Maximum Pixel Frequency		69.16 MHz
Synchronization (PANEL Spec)	Horizontal Frequency	388.8 kHz
	Vertical Frequency	240 Hz
Resolution	Optimum Resolution	3840 x 1080 @ 120 Hz (Game Mode off) (HDMI) 5120 x 1440 @ 120 Hz (Game Mode off) (DP) 5120 x 1440 @ 120 Hz (Game Mode on) (HDMI, DP)
	Maximum Resolution	5120 x 1440 @ 240 Hz
Power Supply		AC100-240V~ 50/60Hz Based on the AC voltage of the adapter. For the DC voltage of the product, refer to the product label.
Signal connectors		Micro HDMI / HDMI / DisplayPort
Environmental conditions	Operating	Temperature: 50 °F to 104 °F (10 °C to 40 °C) Humidity: 10 % to 80 %, non-c ondensing
	Storage	Temperature: -4 °F to 113 °F (-20 °C to 45 °C) Humidity: 5 % to 95 %, non-condensing

- Plug-and-Play

This product can be installed and used with any Plug-and-Play compatible systems. Two-way data exchange between the product and PC system optimizes the product settings. Product installation takes place automatically. However, you can customize the installation settings if desired.

- Panel Dots (Pixels)

Due to the nature of the manufacturing of this product, approximately 1 pixel per million (1ppm) may be brighter or darker on the LCD panel. This does not affect product performance.

- The specifications are subject to change without notice to improve quality.

- For detailed device specifications, visit the Samsung website.

Appendix

Responsibility for the Pay Service (Cost to Customers)

When the service is requested, in spite of in warranty, we may charge you for a visit from a service technician in the following cases.

Not a product defect

Cleaning of the product, Adjustment, Explanation, Re-installation and etc.

- If a service technician is requested to give instructions on how to use product or simply adjusts options without disassembling product.
- If a defect is caused by external environmental factors (Internet, Antenna, Wired Signal, etc.)
- If a product is reinstalled or devices are connected additionally after installing the purchased product for the first time.
- If a product is reinstalled to move to a different spot or to move to a different house.
- If the customer requests instructions on how to use another company's product.
- If customer requests instructions on how to use the network or another company's Program.
- If customer requests software installation and setup for the product.
- If a service technician removes/cleans dusts or foreign materials inside of the product.
- If customer requests an installation additionally after purchasing a product through home-shopping or online.

A Product damage caused by customer's fault

Product damage caused by customer's mishandling or wrong repair

If a product damage is caused by;

- External impact or drop.
- Use of supplies or separately sold product unspecified by Samsung.
- Repair from a person besides an engineer of outsourcing service company or partner of Samsung Electronics Co., Ltd.
- Remodeling or repairing the product by customer.
- Using it with incorrect voltage or non-authorized electrical connections.
- Not following the "cautions" in User Manual.

Others

- If product fails by natural disaster. (lightning, fire, earthquake, flood damage, etc)
- If consumable components are all used up. (Battery, Toner, Fluorescent lights, Head, Vibrator, Lamp, Filter, Ribbon, etc.)
- ✎ If customer requests a service in case the product has no defect, service fee may be charged. So please read User Manual first.

FreeSync Premium pro (for AMD graphics card)





FreeSync Premium pro technology is solution that eliminates screen tearing without all the usual lag and latency.

This feature will eliminate screen tearing and lag during game play. Improve your gaming experience.



- **Game Mode - Off:** Disable **FreeSync Premium pro**.
- **Game Mode - On:** Turn on the AMD graphics cards' **FreeSync Premium pro** function. You may experience intermittent flickers when playing some games.

Apply the optimum resolution when using **FreeSync Premium pro**.

The refresh rate setting method please refer to [Q & A → How can I change the frequency?](#)

-  This menu is not available when **Multi View Mode** is enabled.
-  The FreeSync Premium pro function is only enabled in **HDMI** or **DisplayPort** mode.
Use the HDMI/DP cable provided by the manufacturer when using FreeSync Premium Pro.
-  If the **FreeSync Premium pro** function is in use and the text displayed on the PC screen looks blurry or corrupted, resolve the issue by changing the resolution of the PC screen to the recommended resolution.
-  If you set the **Input Signal Plus** to **Off**, the **FreeSync Premium pro** function is disabled.

If you use the **FreeSync Premium pro** function while playing a game, the following symptoms may occur:

- The screen may flicker depending on the type of graphics card, the game option settings, or the video being played. Try the following actions: decrease the game setting values, change the current **Game Mode** to **Off**, or visit the AMD website to check your graphics driver's version and update it with the latest one.
- While you are using the **FreeSync Premium pro** function, the screen may flicker due to variation of the output frequency from the graphics card.
- The response rate during the game may fluctuate depending on the resolution. A higher resolution generally decreases the response rate.
- The sound quality of the monitor may be degraded.
-  If you encounter any issues when using the function, contact the Samsung Service Center.
-  If you change the screen resolution while the function is **On**, the screen may intermittently blank out due to the graphic card. Set **FreeSync Premium pro** to **Off** and change the resolution.
-  The function is unavailable in the devices (e.g. AV devices) that have no AMD graphic card. If the function is applied, the screen may have malfunction.

The models in the Graphics Cards list supports FreeSync Premium pro

FreeSync Premium pro can only be used with specific AMD graphics card models. Refer to the following list for supported graphics cards:

Make sure to install the latest official graphics drivers from AMD that support **FreeSync Premium pro**.

 For additional AMD graphics card models that support the **FreeSync Premium pro** feature, visit the official AMD website.

 When applying the **FreeSync Premium pro** function via the HDMI cable, it may fail to work due to the bandwidth limitation of certain AMD graphics card.

- Radeon™ RX Vega series
- Radeon™ RX 500 series
- Radeon™ RX 400 series
- Radeon™ R9/R7 300 series (excluding R9 370/ X, R7 370/X, R7 265)
- AMD Radeon™ 5500 Series
- AMD Radeon™ 5700 Series
- Radeon™ Pro Duo (2016 edition)
- Radeon™ R9 Nano series
- Radeon™ R9 Fury series
- Radeon™ R9/R7 200 series (excluding R9 270/ X, R9 280/X)
- AMD Radeon™ 5600 Series
- AMD Radeon™ RX 6000 Series
- AMD Radeon™ RX 7000 Series

Supported Resolutions for FreeSync Premium pro (VRR)

Check the supported resolutions for the FreeSync Premium pro (VRR) signal.

When **Game Mode** is set to **On** or **Auto**, the FreeSync Premium pro (VRR) function is activated.

HDMI

Resolution (Dots x lines)	Display format	Horizontal frequency (KHz)	Vertical frequency (Hz)	Clock frequency (MHz)	SCAN
1920 x 1080	60 Hz	67.500	60.000	148.500	progressive
1920 x 1080	120 Hz	135.000	120.000	297.000	progressive
1920 x 1080	240 Hz	271.364	239.932	597.000	progressive
2560 x 1440	60 Hz	88.787	59.951	241.500	progressive
2560 x 1440	120 Hz	182.996	119.998	497.750	progressive
2560 x 1440RB	240 Hz	355.919	240.000	1010.810	progressive
3840 x 1080	60 Hz	66.658	59.998	274.630	progressive
3840 x 1080	120 Hz	137.279	119.999	565.590	progressive
3840 x 1080	240 Hz	291.600	240.000	1201.390	progressive
5120 x 1440	60 Hz	88.859	60.000	479.840	progressive
5120 x 1440	120 Hz	182.880	120.000	987.550	progressive
5120 x 1440	240 Hz	356.879	240.000	1941.420	progressive

DP

Resolution (Dots x lines)	Display format	Horizontal frequency (KHz)	Vertical frequency (Hz)	Clock frequency (MHz)	SCAN
1920 x 1080	60 Hz	67.500	60.000	148.500	progressive
1920 x 1080	120 Hz	135.000	120.000	297.000	progressive
1920 x 1080	240 Hz	271.364	239.932	597.000	progressive
2560 x 1440	60 Hz	88.787	59.951	241.500	progressive
2560 x 1440	120 Hz	182.996	119.998	497.750	progressive
2560 x 1440	240 Hz	359.722	240.000	1036.000	progressive
3840 x 1080	60 Hz	66.658	59.998	274.630	progressive
3840 x 1080	120 Hz	137.279	119.999	565.590	progressive
3840 x 1080	240 Hz	291.600	240.000	1201.390	progressive
5120 x 1440	60 Hz	88.859	60.000	479.840	progressive
5120 x 1440	120 Hz	182.880	120.000	987.550	progressive
5120 x 1440	240 Hz	356.879	240.000	1941.420	progressive