



Dell S2725DS Monitor

User's Guide

Monitor Model: S2725DS
Regulatory Model: S2725DSc



-  **NOTE:** A NOTE indicates important information that helps you make better use of your computer.
-  **CAUTION:** A CAUTION indicates potential damage to hardware or loss of data if instructions are not followed.
-  **WARNING:** A WARNING indicates a potential for property damage, personal injury or death.

© 2024 Dell Inc. or its subsidiaries. All rights reserved. Dell Technologies, Dell, and other trademarks are trademarks of Dell Inc. or its subsidiaries. Other trademarks may be trademarks of their respective owners.

2024 – 03

Rev. A00



Contents

Safety instructions	6
About your monitor	7
Package contents	7
Product features	8
Operating system compatibility	12
Identifying parts and controls	12
Front view	12
Back view	13
Side view.	14
Bottom view	14
Monitor specifications	16
Resolution specifications	19
Supported video modes	19
Preset display modes	20
Electrical specifications.	21
Physical characteristics.	23
Environmental characteristics	24
Pin assignments	25
DisplayPort connector	25
HDMI connector	26
Plug-and-Play capability	27
LCD monitor quality and pixel policy	27



Ergonomics	28
Handling and moving your display	30
Maintenance guidelines	31
Cleaning your monitor	31
Setting up the monitor	32
Attaching the stand	32
Using the tilt, swivel and height adjustment	34
Tilt, swivel	35
Height adjustment	35
Rotating the monitor	36
Connecting your monitor	38
Connecting the HDMI cable	38
Connecting the DisplayPort 1.2 cable (optional)	38
Routing the cables	39
Attaching the side I/O-cover	40
Organizing cables	40
Turn on the monitor	41
Securing your monitor using Kensington lock (optional)	41
Removing the monitor stand	42
VESA wall mounting (optional)	43
Operating your monitor	44
Power on the monitor	44
Using the joystick button	44
Using the Joystick Control	45
Direct key functions	45



- Using the On-Screen Display (OSD) menu 46
 - Accessing the Menu Launcher 46
 - Using the navigation keys 47
 - Accessing the menu system 48
 - Menu and power button lock 60
 - OSD warning messages 63
- Setting the maximum resolution 66
- Troubleshooting 67**
 - Self-Test 67
 - Built-in diagnostics 68
 - Common problems 70
- Regulatory information 74**
 - FCC notices (U.S. Only) and other regulatory information 74
 - EU product database for energy label and product information sheet 74
- Contacting Dell. 74**



Safety instructions

Use the following safety guidelines to protect your monitor from potential damage and to ensure your personal safety. Unless otherwise noted, each procedure included in this document assumes that you have read the safety information that shipped with your monitor.

 **NOTE: Before using the monitor, read the safety information that is shipped with your monitor and printed on the product. Keep the documentation at a secure location for future reference.**

 **WARNING: Use of controls, adjustments or procedures other than those specified in this documentation may result in exposure to shock, electrical hazards and/or mechanical hazards.**

 **WARNING: The possible long-term effect of listening to audio at high volume through the headphones (on monitor that support it) may cause damage to your hearing ability.**

- Place the monitor on a solid surface and handle it carefully. The screen is fragile and can be damaged if dropped or hit with a sharp object.
- Ensure that your monitor is electrically rated to operate with the AC power available in your location.
- Keep the monitor in room temperature. Excessive cold or hot conditions can have an adverse effect on the liquid crystal of the display.
- Connect the power cable from the monitor to a wall outlet that is near and accessible. See [Connecting your monitor](#).
- Do not place and use the monitor on a wet surface or near water.
- Do not subject the monitor to severe vibration or high impact conditions. For example, do not place the monitor inside a car trunk.
- Unplug the monitor when it is going to be left unused for an extended period.
- To avoid electric shock, do not attempt to remove any cover or touch the inside of the monitor.
- Read these instructions carefully. Keep this document for future reference. Follow all warnings and instructions marked on product.
- Certain monitors can be wall mounted using the VESA mount that is sold separately. Ensure to use the correct VESA specifications as mentioned in the wall mounting section of the User's Guide.

For information on safety instructions, see the *Safety, Environmental and Regulatory Information (SERI)* document that is shipped with your monitor.





About your monitor



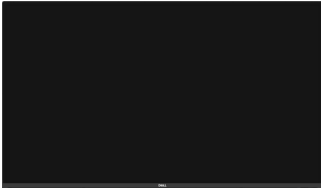
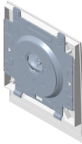

Package contents

The following table provides the list of components that are shipped with your monitor. If any component is missing, contact Dell. For more information, see [Contacting Dell](#).

 **NOTE: Some items may be optional and may not ship with your monitor. Some features may not be available in certain countries.**

Component image	Component description
	Display
	VESA cover
	Stand riser
	Stand base



	Side I/O-cover
	Power cable (varies by countries)
	HDMI cable (1.80 m)
	<ul style="list-style-type: none"> • Quick Start Guide • Safety, Environmental and Regulatory Information

Product features

The Dell **S2725DS** monitor has an active matrix, Thin-Film Transistor (TFT), Liquid Crystal Display (LCD), anti-static and LED backlight. The monitor has the following features:

- Supports the refresh rate of 100 Hz.
- Color gamut of 99% sRGB (typical).
- Digital connectivity with 2 HDMI and DP ports.
- Plug and play capability if supported by your computer.
- Integrated speakers (2 x 5 W).
- On-Screen Display (OSD) adjustments for ease of setup and screen optimization.
- Removable stand and 100 mm Video Electronics Standards Association (VESA) mounting holes for flexible mounting solutions.
- Tilt, swivel, rotate, and height adjustment capabilities.
- Security-lock slot for Kensington locks (sold separately).



- Offers Premium Panel Exchange during warranty period.
- Supports Dell ComfortView Plus feature.
Dell ComfortView Plus is an integrated low blue light screen feature that improves eye comfort by reducing potentially harmful blue light emissions without compromising color. Through ComfortView Plus technology, Dell has reduced harmful blue light exposure from $\leq 50\%$ to $\leq 35\%$. This monitor is certified with TÜV Rheinland Eye Comfort 3.0 with a 4-star rating. It incorporates key technologies that also deliver a flicker-free screen, up to 100 Hz refresh rate, and a color gamut of minimum 95% sRGB. Dell ComfortView Plus feature is enabled by default on your monitor.
- This monitor uses a low blue light panel. When the monitor is reset to factory settings or default setting, it is in compliance with TÜV Rheinland's hardware low blue light certification.*

Blue light ratio:

The ratio of light in the range from 415nm-455nm compared to 400nm-500nm shall be less than 50%.

Category	Blue light ratio
1	$\leq 20\%$
2	$20\% < R \leq 35\%$
3	$35\% < R \leq 50\%$

- Decreases the level of hazard blue light emitted from the screen to make viewing more comfortable for your eyes without distortion of color accuracy.
- The monitor adopts Flicker-Free technology, which clears the eye visible flicker, brings comfort viewing experience and preventing users suffer from eye strain and fatigue.
- * This monitor is in compliance with TÜV Rheinland hardware low blue light certification under Category 2.



About TÜV Rheinland Eye Comfort 3.0

TÜV Rheinland Eye Comfort 3.0 certification program presents a consumer-friendly star rating scheme to the display industry promoting eye wellness from safety to eye care. Compared to existing certifications, the 5-star-rating program adds rigorous testing requirements on overall eye care attributes such as low blue-light, flicker-free, refresh rate, color gamut, color accuracy and ambient light sensor performance. It lays out requirement metrics and rates the product performance on five levels, and the sophisticated technical assessment process provides consumers and buyers with indicators that are easier to judge.

The eye wellness factors being considered remain constant, however, the standards for the various star ratings are different. The higher the star rating, the more stringent the standards. The table below lists the major eye comfort requirements which apply in addition to the basic eye comfort requirements (such as pixel density, uniformity of luminance and color, and freedom of movement).

For more information around **TÜV Eye Comfort certification** please refer to: <https://www.tuv.com/world/en/eye-comfort.html>



Eye Comfort 3.0 Requirements and Star Rating Scheme for Monitors

Category	Test item	Star Rating Scheme		
		3-star	4-star	5-star
Eye Care	Low Blue Light	TÜV Hardware LBL Category III ($\leq 50\%$) or Software LBL solution ¹	TÜV Hardware LBL Category II ($\leq 35\%$) or Category I ($\leq 20\%$)	TÜV Hardware LBL Category II ($\leq 35\%$) or Category I ($\leq 20\%$)
	Flicker Free	TÜV Flicker Reduced or TÜV Flicker Free	TÜV Flicker Reduced or TÜV Flicker Free	Flicker Free
Ambient Light Management	Ambient Light Sensor performance	No sensor	No sensor	Ambient light sensor
	Intelligent CCT control	No	No	Yes
	Intelligent Luminance control	No	No	Yes
Image quality	Refresh Rate	$\geq 60\text{Hz}$	$\geq 75\text{Hz}$	$\geq 120\text{Hz}$
	Luminance uniformity	Luminance uniformity $\geq 75\%$		
	Color Uniformity	Color uniformity $\Delta u'v' \leq 0.02$		
	Freedom of movement	Luminance changes shall decrease less than 50%; The colour shift shall be less than 0.01		
	Gamma difference	Gamma difference $\leq \pm 0.2$	Gamma difference $\leq \pm 0.2$	Gamma difference $\leq \pm 0.2$
	Wide color gamut ²	NTSC ³ Min.72% (CIE 1931) or sRGB ⁴ Min 95% (CIE 1931)	sRGB ⁴ Min.95% (CIE 1931)	DCI-P3 ⁵ Min. 95% (CIE 1976) & sRGB ⁴ Min.95% (CIE 1931) or Adobe RGB ⁶ Min.95% (CIE 1931) & sRGB ⁴ Min.95% (CIE 1931)
Eye Comfort User Guide	User guide	Yes	Yes	Yes
Remark	<p>¹ Software controls the blue light emission by reducing excessive blue light, resulting in a more yellow tone.</p> <p>² Color gamut describes the availability of colors in the display. Various standards were developed for specific purposes. 100% corresponds to the full color space as defined in the standard.</p> <p>³ NTSC stands for National Television Standards Committee, which developed a color space for the television system that is used in the United States.</p> <p>⁴ sRGB is a standard red, green, and blue color space that is in use on monitors, printers, and the World Wide Web.</p> <p>⁵ DCI-P3, short for Digital Cinema Initiatives - Protocol 3, is a color space used in digital cinema that encompasses a wider range of colors than the standard RGB color space.</p> <p>⁶ Adobe RGB is a color space created by Adobe Systems that encompasses a broader range of colors than the standard RGB color model, particularly in the cyans and greens.</p>			



Operating system compatibility

- Windows 10 and later*
- macOS 12* and macOS 13*

*The operating system compatibility on Dell and Alienware branded monitors may vary based on factors such as:

- Specific release date(s) when operating system versions, patches, or updates are available.
- Specific release date(s) when Dell and Alienware branded monitor firmware, software application, or driver updates are available on the Dell support website.

Identifying parts and controls

Front view



Label	Description	Use
1	Power LED indicator	Solid white indicates that the monitor is turned on and functioning normally. Blinking white indicates that the monitor is in Standby Mode.



Back view



Label	Description	Use
1	Side I/O cover	Use to cover side I/O.
2	Joystick	Use to control the OSD menu. For more information, see Operating your monitor .
3	Power On/Off button	Press the power button to turn the monitor on and off.
4	Cable management guide	Use to organize cables by routing them through the guide.
5	VESA mounting holes (100 mm x 100 mm - behind the VESA cover)	Wall-mount the monitor using VESA-compatible wall-mount kit.  NOTE: Wall-mount kit is not shipped with your monitor and is sold separately.
6	Regulatory information label	Lists the regulatory approvals.
7	Regulatory label (including barcode, serial number and Service Tag label)	Lists the regulatory approvals. Refer to this label if you need to contact Dell for technical support. The Service Tag is a unique alphanumeric identifier that enables Dell service technicians to identify the hardware components in your computer and access warranty information.
8	Stand release button	Releases the stand from the monitor.



Side view



Bottom view

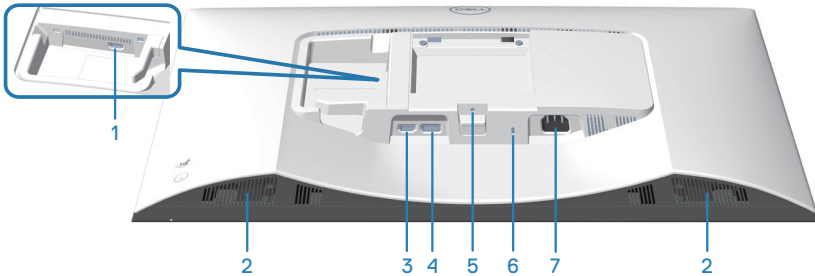

Bottom view without monitor stand

Label	Description	Use
1	HDMI 2 port	Connect to your computer or external device using a HDMI cable (shipped with your monitor).
2	Built-in speakers (2)	Provides audio output.
3	HDMI 1 port	Connect to your computer or external device using a HDMI cable (shipped with your monitor).
4	DisplayPort	Connect to your computer or external device using a DisplayPort cable (purchased separately).
5	Stand-lock feature	Lock the stand to the monitor using a M3 x 6 mm screw (screw not included).



6	Security-lock slot (based on Kensington security slot)	Secure your monitor using a security lock (purchased separately) to prevent unauthorized movement of your monitor.
7	Power connector	Connect the power cable (shipped with your monitor).



Monitor specifications

Description	Value
Screen type	Active matrix-TFT LCD
Panel type	In-Plane Switching (IPS) technology
Aspect ratio	16:9
Viewable image dimensions	
Diagonal	684.66 mm (27.0 in.)
Active Area	
Horizontal	596.74 mm (23.49 in.)
Vertical	335.66 mm (13.22 in.)
Area	200302.79 mm ² (310.47 in. ²)
Maximum resolution and refresh rate	2560 x 1440 at 100 Hz
Pixel pitch	0.2331 mm x 0.2331 mm
Pixel per inch (PPI)	109
Viewing angle:	
Horizontal	178° (typical)
Vertical	178° (typical)
Brightness	350 cd/m ² (typical)
Contrast ratio	1500 to 1 (typical)
Display screen coating	Anti-glare treatment of the front polarizer (3H) hard coating
Backlight	LED edgelight system



Description	Value
Response time (gray-to-gray)	8 ms (Normal mode) 5 ms (Fast mode) 4 ms (Extreme mode*) *Reduced visible motion blur and increased image responsiveness.  NOTE: Extreme mode may introduce some slight and noticeable visual artifacts into the image. You may select response time as per your requirement.
Color depth	16.7 million colors
Color gamut	sRGB Typ. 99% (CIE 1931)
Connectivity	2 x HDMI 2.1 (HDCP 1.4) (Supports up to QHD 2560x1440 100 Hz TMDS, VRR as per specified in HDMI 2.1) 1 x DisplayPort 1.2 (HDCP 1.4) (Supports up to QHD 2560x1440 100 Hz,VRR)
Bezel width (edge of monitor to active area):	
Top	7.30 mm
Left/Right	7.30 mm
Bottom	13.02 mm
Adjustability:	
Height-adjust	130 mm
Tilt	-5° to 21°
Swivel	-30° to 30°
Pivot	-90° to 90°
Cable management	Yes
Dell Display Manager 2.0 compatibility*	Easy Arrange and other key features
Security	Security-lock slot (for Kensington locks, sold separately)
Built-in speakers	2 x 5W



*Dell Display Manager

Dell Display Manager is an application software that enhances the experience of your Dell monitor ensuring more productivity and ease in customization.

With this application you can:

1. Adjust the monitor On-Screen Display (OSD) settings such as brightness, contrast, input source setting and so on with ease. No need to toggle using the joystick on the monitor; simply use the DDM software.
2. Organize multiple applications on your screen, snapping them into a template of your choice with the Easy Arrange.
3. Assign applications or even files to the partitions of Easy Arrange, save the layout as a profile and then restore the profile automatically using Easy Arrange Memory.
4. Connect your Dell Monitor to multiple input sources and manage these multiple video inputs using Input source.
5. Customize each application with different color mode using Color Preset.
6. Replicate the Dell Display Manager application settings from one monitor to another monitor of the same model with Import/export application settings

Moreover, this model comes with advanced remote management features for IT admins.

For more information on Dell Display Manager, visit

<https://www.dell.com/support/ddm>

You can download the software from this link and find detailed user guide of the software and knowledge base article under the documentation tab.

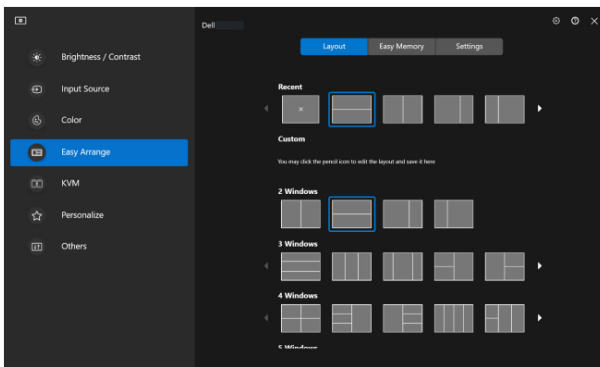

Dell Display Manager User Interface



Resolution specifications

Description	Value
Horizontal frequency	28 kHz to 151 kHz
Vertical refresh rate	48 Hz to 100 Hz
Maximum preset resolution	2560 x 1440

Supported video modes

Description	Value
Video display capabilities (HDMI or DisplayPort)	480p, 576p, 720p, 1080i (HDMI), 1080p, 1440p



Preset display modes

HDMI/DP Preset Display Modes

Display mode	Horizontal frequency (kHz)	Vertical frequency (Hz)	Pixel clock (MHz)	Sync polarity (Horizontal / Vertical)
VESA 640 x 480	31.47	59.94	25.17	-/-
VESA 640 x 480	37.50	75.00	31.50	-/-
IBM 720 x 400	31.47	70.08	28.32	-/+
VESA 800 x 600	37.88	60.32	40.00	+/+
VESA 800 x 600	46.88	75.00	49.50	+/+
VESA 1024 x 768	48.36	60.00	65.00	-/-
VESA 1024 x 768	60.02	75.03	78.75	+/+
VESA 1152 x 864	67.50	75.00	108.00	+/+
VESA 1280 x 720	45.00	59.94	74.25	-/+
VESA 1280 x 800	49.31	59.91	71.00	+/+
VESA 1280 x 960	60.00	60.00	108.00	+/+
VESA 1280 x 1024	63.98	60.02	108.00	+/+
VESA 1280 x 1024	79.98	75.02	135.00	+/+
VESA 1440 x 900	55.94	59.89	106.50	-/+
VESA 1680 x 1050	65.29	59.95	146.25	-/+
VESA 1920 x 1080	67.50	60.00	148.50	+/+
VESA 2048 x 1080	66.66	59.99	147.18	+/-
VESA 2560 x 1440	88.79	59.95	241.50	+/-
VESA 2560 x 1440	151.05	100.04	410.86	+/-



Electrical specifications

Description	Value
Video input signals	HDMI 600 mV for each differential line, 100 ohm input impedance per differential pair. DisplayPort 600 mV for each differential line, 100 ohm input impedance per differential pair.
AC input voltage/frequency/current	100 VAC to 240 VAC/50 Hz or 60 Hz \pm 3 Hz/1.5 A (typical)
Inrush current	120 V: 30 A (Maximum) 240 V: 60 A (Maximum)
Power consumption	0.3 W (Off mode) ¹ 0.3 W (Standby Mode) ¹ 21.4 W (On Mode) ¹ 57 W (Maximum) ² 19.2 W (P_{on}) ³ 60.58 kWh (TEC) ³

¹ As defined in EU 2019/2021 and EU 2019/2013.

² Maximum brightness and contrast setting.

³ P_{on} : Power consumption of On Mode as defined in Energy Star 8.0 version.

TEC: Total energy consumption in kWh as defined in Energy Star 8.0 version.

This document is informational only and reflects laboratory performance. Your product may perform differently, depending on the software, components and peripherals you ordered and Dell shall have no obligation to update such information.

Accordingly, the customer should not rely upon this information in making decisions about electrical tolerances or otherwise. No warranty as to accuracy or completeness is expressed or implied.



 **NOTE: This monitor is ENERGY STAR certified.**



This product qualifies for ENERGY STAR in the factory default settings which can be restored by “Factory Reset” function in the OSD menu. Changing the factory default settings or enabling other features may increase power consumption that could exceed the ENERGY STAR specified limit.



Physical characteristics

Description	Value
Dimensions (with stand):	
Height (maximum)	518.63 mm (20.42 in.)
Height (minimum)	388.63 mm (15.30 in.)
Width	611.34 mm (24.07 in.)
Depth	200.38 mm (7.89 in.)
Dimensions (without stand):	
Height	355.98 mm (14.02 in.)
Width	611.34 mm (24.07 in.)
Depth	58.81 mm (2.32 in.)
Stand dimensions:	
Height	411.80 mm (16.21 in.)
Width	248.00 mm (9.76 in.)
Depth	200.38 mm (7.89 in.)
Base	248.00 x 180.00 mm (9.76 in. x 7.09 in.)
Weight:	
Weight with packaging	8.64 kg (19.05 lb)
Weight with stand assembly and cables	6.54 kg (14.42 lb)
Weight without stand assembly (For wall mount or VESA mount considerations - no cables)	4.49 kg (9.90 lb)
Weight of stand assembly	1.78 kg (3.92 lb)



Environmental characteristics

Description	Value
Compliant standards:	
<ul style="list-style-type: none"> • RoHS-compliant • BFR/PVC reduce monitor (The circuit boards are made from BFR/PVC-free laminates.) • Arsenic-free glass and Mercury-free for the panel only • ENERGY STAR certified monitor 	
Temperature:	
Operating	0°C to 40°C (32°F to 104°F)
Non-operating	<ul style="list-style-type: none"> • Storage: -20°C to 60°C (-4°F to 140°F) • Shipping: -20°C to 60°C (-4°F to 140°F)
Humidity:	
Operating	10% to 80% (non-condensing)
Non-operating	<ul style="list-style-type: none"> • Storage 10% to 90% (non-condensing) • Shipping 10% to 90% (non-condensing)
Altitude:	
Operating (maximum)	5,000 m (16,400 ft)
Non-operating (maximum)	12,192 m (40,000 ft)
Thermal dissipation	194.53 BTU/hour (Maximum) 73.03 BTU/hour (On Mode)



Pin assignments

DisplayPort connector

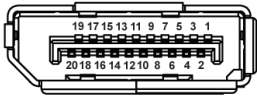

Pin number	20-pin side of the connected signal cable
1	ML3 (n)
2	GND
3	ML3 (p)
4	ML2 (n)
5	GND
6	ML2 (p)
7	ML1 (n)
8	GND
9	ML1 (p)
10	ML0 (n)
11	GND
12	ML0 (p)
13	GND
14	GND
15	AUX (p)
16	GND
17	AUX (n)
18	Hot Plug Detect
19	Re-PWR
20	+3.3 V DP_PWR



HDMI connector

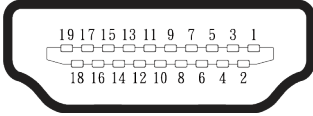

Pin number	19-pin side of the connected signal cable
1	TMDS DATA 2+
2	TMDS DATA 2 SHIELD
3	TMDS DATA 2-
4	TMDS DATA 1+
5	TMDS DATA 1 SHIELD
6	TMDS DATA 1-
7	TMDS DATA 0+
8	TMDS DATA 0 SHIELD
9	TMDS DATA 0-
10	TMDS CLOCK+
11	TMDS CLOCK SHIELD
12	TMDS CLOCK-
13	CEC
14	Reserved (N.C. on device)
15	DDC CLOCK (SCL)
16	DDC DATA (SDA)
17	DDC/CEC Ground
18	+5 V POWER
19	HOT PLUG DETECT



Plug-and-Play capability

You can connect the monitor to any Plug and Play-compatible system. The monitor automatically provides the computer with its Extended Display Identification Data (EDID) using Display Data Channel (DDC) protocols so the system can configure itself and optimize the monitor settings. Most monitor installations are automatic, you can select different settings as required. For more information about changing the monitor settings, see [Operating your monitor](#).

LCD monitor quality and pixel policy

During the LCD Monitor manufacturing process, it is not uncommon for one or more pixels to become fixed in an unchanging state, which are hard to see and do not affect the display quality or usability. For more information on Dell Monitor Quality and Pixel Policy, see www.dell.com/pixelguidelines.



Ergonomics

 **CAUTION: Improper or prolonged usage of keyboard may result in injury.**

 **CAUTION: Viewing the monitor screen for extended periods of time may result in eye strain.**

For comfort and efficiency, observe the following guidelines when setting up and using your computer workstation:

- Position your computer so that the monitor and keyboard are directly in front of you as you work. Special shelves are commercially available to help you correctly position your keyboard.
- To reduce the risk of eye strain and neck, arm, back or shoulder pain from using the monitor for long period, we recommend you to:
 1. Set the distance of the screen between 20 in. to 28 in. (50 cm - 70 cm) from your eyes.
 2. Blink frequently to moisten your eyes or wet your eyes with water after prolonged usage of the monitor.
 3. Take regular and frequent breaks for 20 minutes every two hours.
 4. Look away from your monitor and gaze at a distant object at 20 feet away for at least 20 seconds during the breaks.
 5. Perform stretches to relieve tension in the neck, arm, back and shoulders during the breaks.
- Ensure that the monitor screen is at eye level or slightly lower when you are sitting in front of the monitor.
- Adjust the tilt of the monitor, its contrast and brightness settings.
- Adjust the ambient lighting around you (such as overhead lights, desk lamps and the curtains or blinds on nearby windows) to minimize reflections and glare on the monitor screen.
- Use a chair that provides good lower-back support.
- Keep your forearms horizontal with your wrists in a neutral, comfortable position while using the keyboard or mouse.
- Always leave space to rest your hands while using the keyboard or mouse.
- Let your upper arms rest naturally on both sides.
- Ensure that your feet are resting flat on the floor.



- When sitting, ensure that the weight of your legs is on your feet and not on the front portion of your seat. Adjust your chair's height or use a footrest if necessary to maintain a proper posture.
- Vary your work activities. Try to organize your work so that you do not have to sit and work for extended periods of time. Try to stand or get up and walk around at regular intervals.
- Keep the area under your desk clear of obstructions and cables or power cords that may interfere with comfortable seating or present a potential trip hazard.

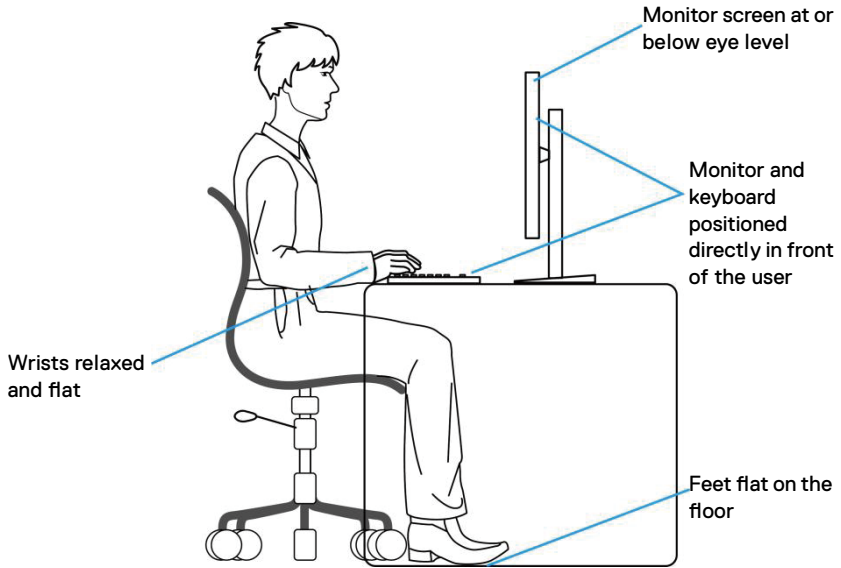

Handling and moving your display

To ensure that the monitor is handled safely when lifting or moving it, observe the following guidelines:

- Before moving or lifting the monitor, turn off your computer and the monitor.
- Disconnect all cables from the monitor.
- Place the monitor in the original box with the original packing materials.
- Hold the bottom edge and the side of the monitor firmly without applying excessive pressure when lifting or moving the monitor.

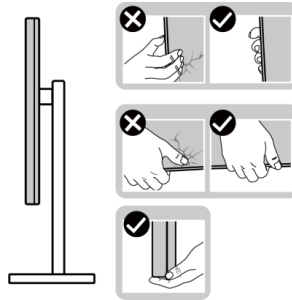

- When lifting or moving the monitor, ensure that the screen is facing away from you. Do not press on the display area to avoid any scratches or damage.

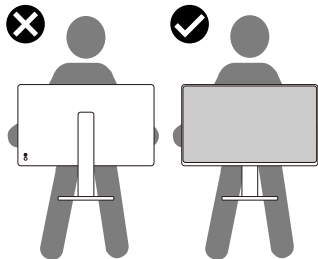

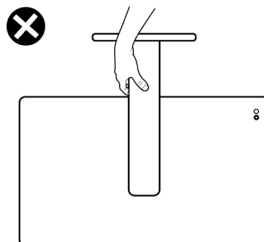

- When transporting the monitor, avoid any sudden shock or vibration to it.
- When lifting or moving the monitor, do not turn the monitor upside down while holding the stand base or stand riser. It may result in accidental damage to the monitor or cause personal injury.







Maintenance guidelines

Cleaning your monitor

-  **WARNING:** Before cleaning the monitor, unplug the monitor power cable from the electrical outlet.
-  **CAUTION:** Read and follow the [Safety instructions](#) before cleaning the monitor.



For best practices, follow the instructions in the list below when unpacking, cleaning or handling your monitor:

- Use a clean cloth that is slightly dampened with water to clean the stand assembly, the screen, and the chassis of your Dell monitor. If available, use a screen-cleaning tissue or solution suitable for cleaning Dell monitors.
 - After cleaning the surface of the table, ensure that it is thoroughly dry and free from any moisture or cleaning agent before placing your Dell monitor on it.
-  **CAUTION:** Do not use detergents or other chemicals such as benzene, thinner, ammonia, abrasive cleaners or compressed air.
 -  **CAUTION:** Using chemicals for cleaning may cause changes in the appearance of the monitor, such as color fading, milky film on the monitor, deformation, uneven dark shade and peeling of screen area.
 -  **WARNING:** Do not spray the cleaning solution or even water directly on the surface of the monitor. Doing so will allow liquids to accumulate at the bottom of the display panel and corrode the electronics resulting in permanent damage. Instead, apply the cleaning solution or water to a soft cloth and then clean the monitor.
-  **NOTE:** Monitor damage due to improper cleaning methods and the use of benzene, thinner, ammonia, abrasive cleaners, alcohol, compressed air, detergent of any kind will lead to a Customer Induced Damage (CID). CID is not covered under the standard Dell warranty.
- If you notice white powder when you unpack your monitor, wipe it off with a cloth.
 - Handle your monitor with care as a dark-colored monitor may get scratched and show white scuff marks more than a light-colored monitor.
 - To help maintain the best image quality on your monitor, use a dynamically changing screen saver and turn off your monitor when not in use.



Setting up the monitor

Attaching the stand

-  **NOTE: The stand is not installed at the factory when shipped.**
-  **NOTE: The following instructions are applicable only for the stand that was shipped with your monitor. If you are attaching a stand that you purchased from any other source, follow the setup instructions that were included with the stand.**

To attach the monitor stand:

1. Remove the VESA cover, the stand riser and the stand base from the cushion that secures it.
2. Align and place the stand base onto the stand riser.
3. Open the screw handle at the bottom of the stand base and turn it clockwise to secure the stand assembly.
4. Close the screw handle.

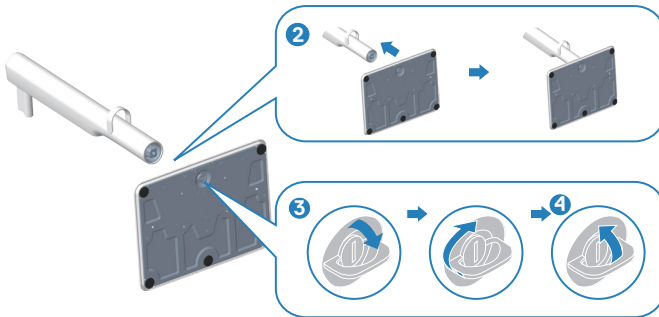

5. Align and place the VESA cover to the stand riser.
6. Check that the VESA plate is tilted back to flush with thumbscrew for ease of tightening.
7. Open the screw handle at the front of the VESA cover and turn it clockwise to secure the hinge assembly.
8. Close the screw handle.



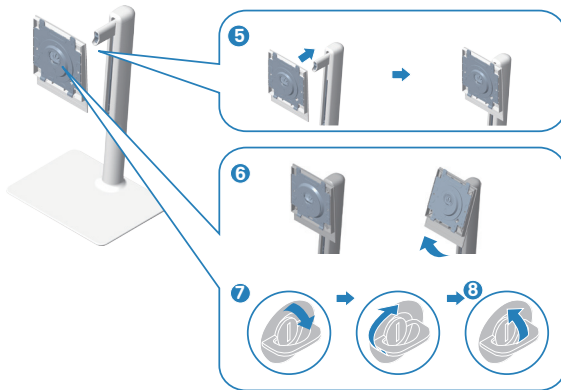

9. Open the protective cover on the monitor to access the VESA slot on the monitor.



10. Slide the tabs on the stand riser into the slots on the display back cover and press the stand assembly down to snap it into place.

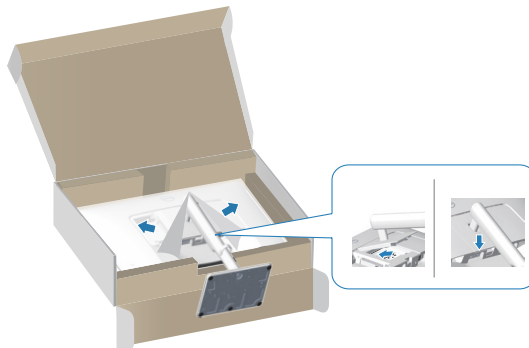

11. Hold the stand riser firmly with both hands and lift the monitor carefully, then place it on a flat surface.



12. Remove the cover from the monitor.

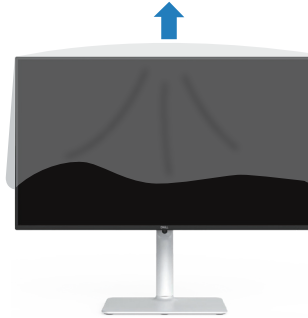

Using the tilt, swivel and height adjustment

-  **NOTE:** These values are applicable to the stand that was shipped with your monitor. To set up with any other stand, see the documentation that shipped with the stand.



Tilt, swivel

With the stand that is attached to the monitor, you can tilt and swivel the monitor for the most comfortable viewing angle.

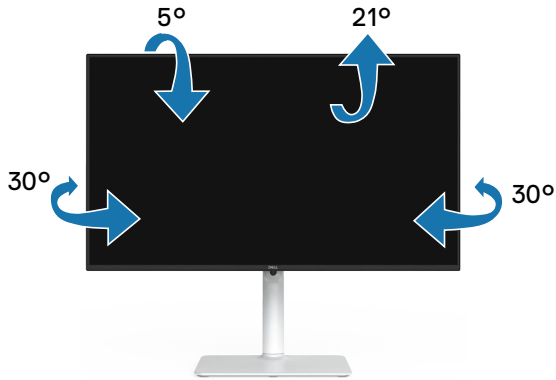

NOTE: The stand is detached when the monitor is shipped from the factory.

Height adjustment

NOTE: The stand can be extended vertically up to 130 mm.

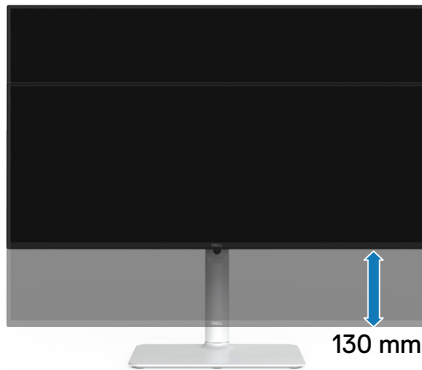

Rotating the monitor

Before you rotate the monitor, your monitor should be fully vertically extended (Height adjustment) and fully tilted up to avoid hitting the bottom edge of the monitor.

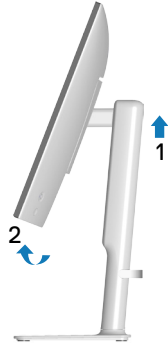

Rotate clockwise



Rotate counterclockwise

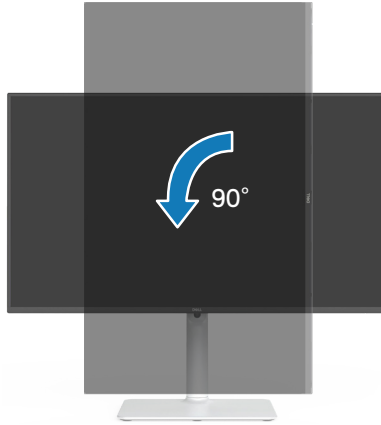

- NOTE: To use the Display Rotation function (Landscape versus Portrait view) with your Dell computer, you require an updated graphics driver that is not included with this monitor. To download the graphics driver, go to www.dell.com/support and see the Download section for Video Drivers for latest driver updates.
- NOTE: When in the Portrait View Mode, you may experience performance degradation in graphic-intensive applications (3D Gaming and so on).



Connecting your monitor

⚠ WARNING: Before you begin any of the procedures in this section, follow the [Safety instructions](#).

📎 NOTE: Dell monitors are designed to work optimally with Dell supplied inbox cables. Dell does not guarantee the video quality and performance if non-Dell cables are used.

📎 NOTE: Route the cables through the cable management guide before connecting them.

📎 NOTE: Do not connect all cables to the computer at the same time.

📎 NOTE: The images are for illustration only. The appearance of the computer may vary.

To connect your monitor to the computer:

1. Turn off your computer and disconnect the power cable.
2. Connect your monitor to the computer with a DisplayPort cable or an HDMI cable.

Connecting the HDMI cable

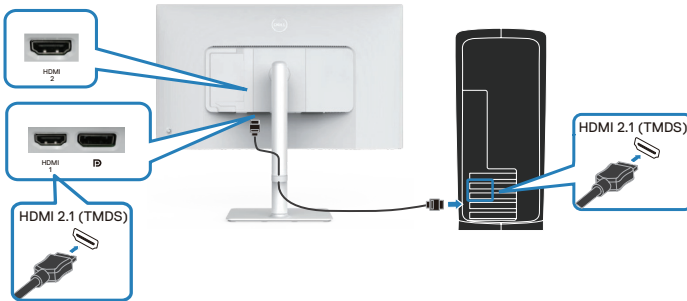

Connecting the DisplayPort 1.2 cable (optional)

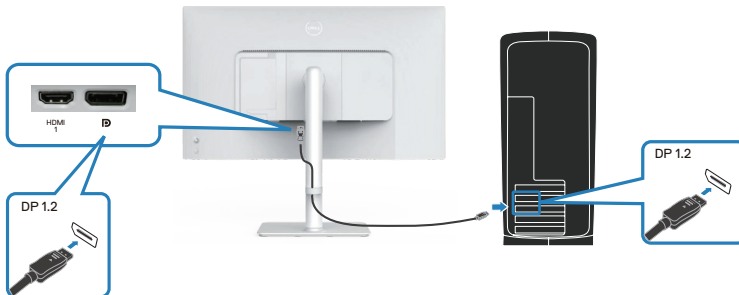

3. Connect the power cable to the monitor and the wall outlet.

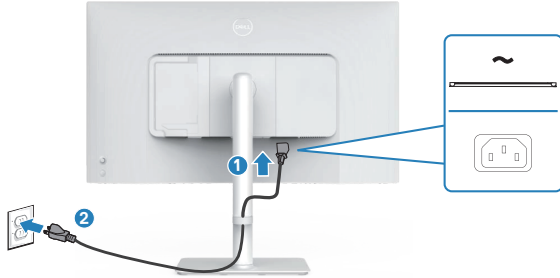

Routing the cables

⚠ WARNING: Place monitor on a flat, clean, and soft surface to avoid scratching the display panel. You can use the EPE foam cover as a protective blanket.

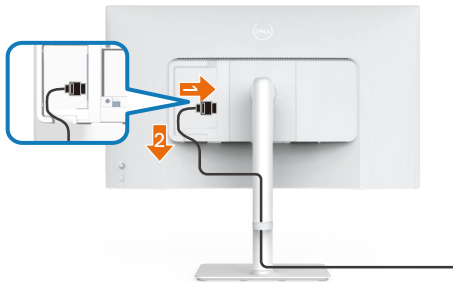

Spread the monitor protective cover on a flat surface.

- Place the monitor with its front facing downward on it.
- To route the cables:
 1. Insert HDMI cable into HDMI connector (see [Connecting your monitor](#)).
 2. Insert and organize the HDMI cable under the restraint lever as shown above.



Attaching the side I/O-cover

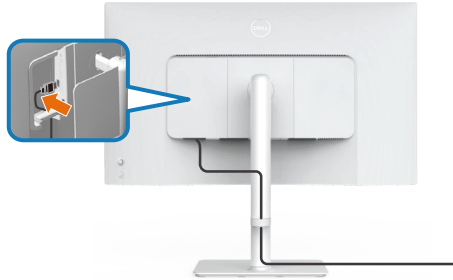

To attach the side I/O-cover:

- Align and place the tabs on the side I/O-cover with the slots on the display back-cover.
- Press the side I/O-cover to snap it into place.

Organizing cables

Install the cable management guide.

Route the cables through the cable management guide on the stand riser.

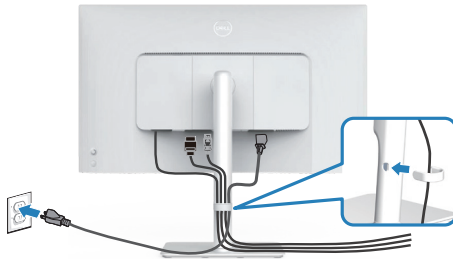

After connecting all necessary cables to your monitor and computer, (see [Connecting your monitor](#) for cable attachment) organize all cables as shown in the image.

If your cable is not able to reach your computer, you may connect directly to the computer without routing through the cable management guide on the monitor stand.



Turn on the monitor

Press the power button to turn on the monitor.



Securing your monitor using Kensington lock (optional)

The security-lock slot is at the bottom of the monitor. (see [Security-lock slot](#)). Secure your monitor to a table using the Kensington security lock.

For more information about using the Kensington lock (sold separately), see the documentation that is shipped with the lock.

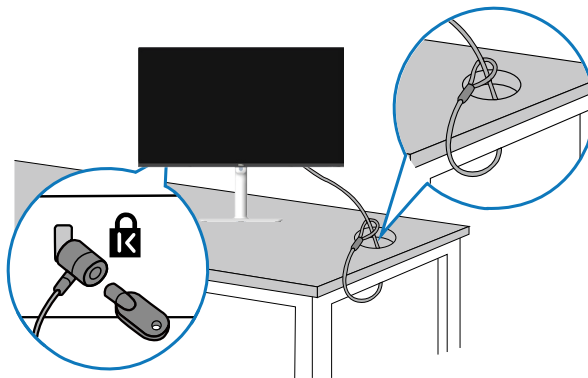

 **NOTE:** The image is for illustration only. The appearance of the lock may vary.



Removing the monitor stand

NOTE: To prevent scratches on the LCD screen when removing the stand, ensure that the monitor is placed on a soft surface and handle it carefully.

NOTE: The following steps are applicable for removing the stand that is shipped with your monitor. If you are removing a stand that you purchased from any other source, follow the setup instructions that are included with the stand.

To remove the stand:

1. Place the monitor on a soft cloth or cushion on a stable flat table.



2. Press and hold the stand-release button at the back of the display.

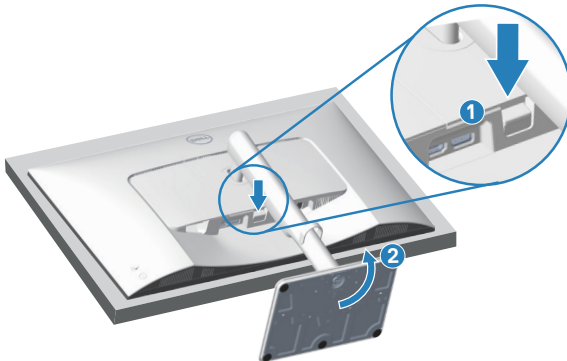

3. Lift the stand assembly up and away from the monitor.



VESA wall mounting (optional)

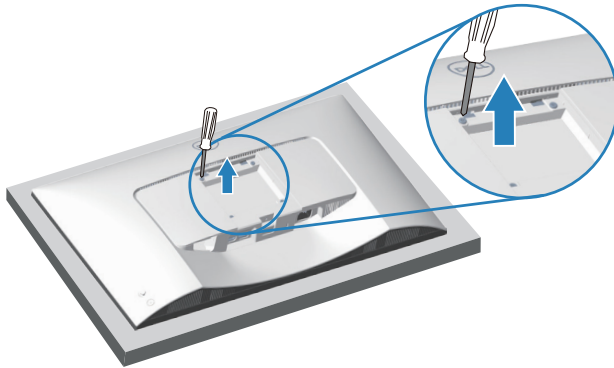

(Screw dimension: M4 x 10 mm).

See the documentation that is shipped with the VESA-compatible wall mounting kit.

1. Place the monitor on a soft cloth or cushion at the edge of the desk.
2. Remove the monitor stand. See [Removing the monitor stand](#).
3. Remove the four screws that secure the display back cover.
4. Install the mounting bracket from the wall mounting kit to the monitor.
5. To mount the monitor on the wall, see the documentation that is shipped with the wall mounting kit.

NOTE: For use only with UL or CSA or GS-listed wall mount bracket with minimum weight or load bearing capacity of 17.96 kg (39.6 lb).



Operating your monitor

Power on the monitor

Press the power button to turn on the monitor.



Using the joystick button

Use the joystick button on the rear of the monitor to adjust the monitor settings.



1. Press the joystick button to launch the OSD menu.
2. Move the joystick up/down/left/right to toggle between options.
3. Press the joystick again to confirm the selection.





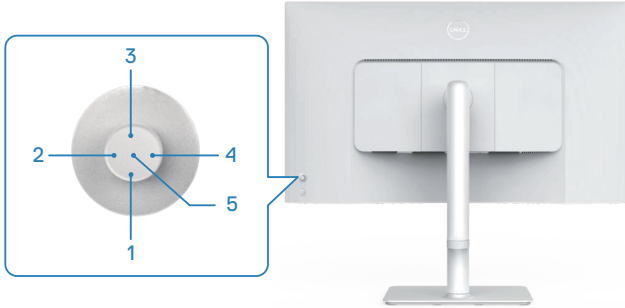

Using the Joystick Control



Direct key functions

The following table describes the Joystick control:

	Joystick control	Description
1	 Direct key 1/ Brightness	To access the adjustment slider of Brightness. Press again to decrease by one level.
2	 Direct key 2/Audio Profiles	To choose a preferred audio mode from the list of audio profiles.
3	 Direct key 3/ Brightness	To access the adjustment slider of Brightness. Press again to decrease by one level.
4	 Direct key 4/Volume	To access the adjustment slider of Volume.
5	 Menu Launcher	To access the Menu Launcher.



Using the On-Screen Display (OSD) menu





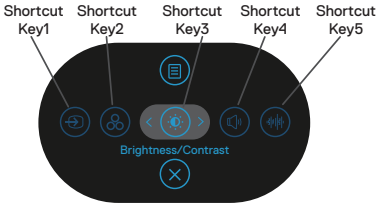

Accessing the Menu Launcher

When you press the joystick, the Menu Launcher appears to let you access the OSD main menu and shortcut functions.

To select a function, move the joystick.



The following table describes the Menu Launcher functions:

	Joystick	Description
1	 Shortcut key/Input Source	To choose an input source from the list of video signals that may be connected to your monitor.
2	 Shortcut key/Color Presets	To choose a preferred color mode from the list of Color Presets.
3	 Shortcut key/Brightness/Contrast	To access the adjustment sliders of Brightness and Contrast.
4	 Shortcut key/Volume	To access the adjustment slider of Volume.
5	 Shortcut key/Audio Profiles	To choose a preferred audio mode from the list of audio profiles.
6	 Menu	To launch the On-Screen Display (OSD) main menu. See Operating your monitor .
7	 Exit	To exit the Menu Launcher.



Using the navigation keys

When the OSD main menu is active, move the joystick to configure the settings, following the navigation keys displayed below the OSD.

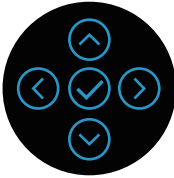

	Joystick	Description
1	⬆ Up	Use ⬆ to adjust (increase ranges) items in the OSD menu.
2	⬇ Down	Use ⬇ to adjust (decrease ranges) items in the OSD menu.
3	⬅ Left	For all first level in the Menu list, ⬅ exits/closes the OSD menu.
4	➡ Right	For all other levels except first level in the Menu list, ➡ takes to the next level.
5	✔ OK	Press the joystick to confirm your selection.







Accessing the menu system

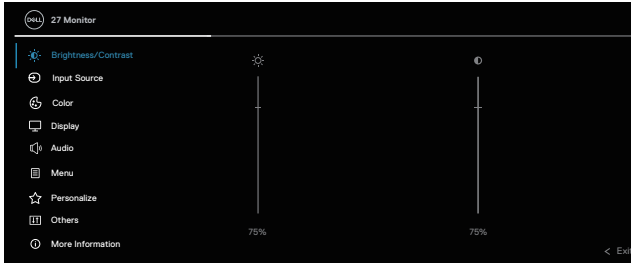

NOTE: If you change the settings and then either proceed to another menu or exit the OSD menu, the monitor automatically saves those changes. The changes are also saved if you change the settings and then wait for the OSD menu to disappear.







1. Select the  icon to launch the OSD and display the main menu.



2. Move the joystick in  or  direction to navigate within the menu options. Each feature gets highlighted when moving from one feature to another.
3. Move the joystick in  or  direction to activate the highlighted option.



NOTE: The directional buttons (and the OK button) displayed may differ according to the menu you've selected. Use available buttons to make your selection.

4. Press  and  directions to select the desired parameter.
5. Press  and then use the  and  directions, according to the indicators on the menu, to make your changes.
6. Select the  to return to the main menu.



Icon **Menu and submenus** **Description**



**Brightness/
Contrast**

Use this menu feature to adjust **brightness** and **contrast**.

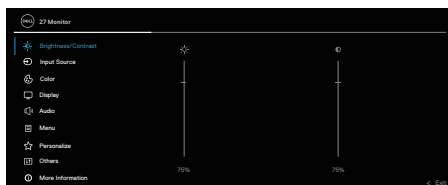

Brightness

Brightness adjusts the luminance of the backlight from 0 to 100.

Move the joystick ⤴ to increase the brightness.

Move the joystick ⤵ to decrease the brightness.

Contrast



Adjust the brightness first and then adjust the contrast only if further adjustments are necessary.

Move the joystick ⤴ to increase the contrast.

Move the joystick ⤵ to decrease the contrast (between 0 and 100).

The **Contrast** function adjusts the degree of difference between darkness and lightness on the monitor screen.

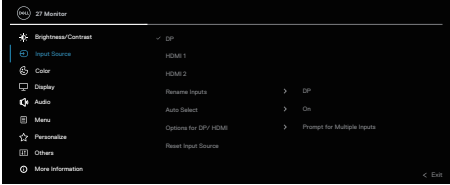

Icon	Menu and submenus	Description
	Input Source	<p>Uses the Input Source menu to select between the different video signals that may be connected to your monitor.</p> <div data-bbox="456 293 906 478" data-label="Image">  </div>
	DP	<p>Selects DP input when using the DP (DisplayPort) connector. Press the joystick button to confirm the selection.</p>
	HDMI 1	<p>Selects the HDMI 1 input when using the HDMI 1 connector. Press the joystick button to confirm the selection.</p>
	HDMI 2	<p>Selects the HDMI 2 input when using the HDMI 2 connector. Press the joystick button to confirm the selection.</p>
	Rename Inputs	<p>Allows you to specify a preset input name for the selected input source. The preset options are PC, PC 1, PC 2, Laptop, Laptop 1, and Laptop 2. The default setting is Off.</p>
		<p> NOTE: It is not applicable for the input names shown in the warning messages and Display Info.</p>
	Auto Select	<p>Turns on the function to allow the monitor to automatically scan for available input sources. Press the joystick button to confirm the selection.</p>



Icon	Menu and submenus	Description
------	-------------------	-------------

Options for DP/HDMI Allows you to set **Auto Select** for **DP/HDMI**:

- ♦ **Prompt for Multiple Inputs:** Always displays the Switch to DP/HDMI Input message for you to choose whether to switch or not.
- ♦ **Always Switch:** Always switches to DP/HDMI video input (without asking) when the DP/HDMI cable is connected.
- ♦ **Off:** Never automatically switches to DP/HDMI video input when the DP/HDMI cable is connected.

Press the joystick to confirm the selection.

 **NOTE: The option is available only when Auto Select is on.**

Reset Input Source Resets all settings under the **Input Source** menu to factory defaults.



Color Adjusts the color setting mode.

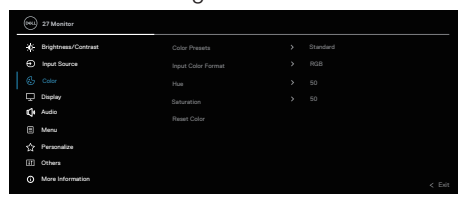

Icon	Menu and submenus	Description
------	-------------------	-------------

Color Presets Allows you to choose from the list of preset color modes. Press the joystick to confirm the selection.

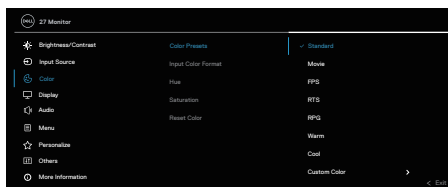

- **Standard:** Loads the monitor's default color settings. This is the default preset mode.
- **Movie:** Loads color settings ideal for movies.
- **FPS:** Loads color settings ideal for First-Person Shooter games.
- **RTS:** Loads color settings ideal for Real-Time Strategy games.
- **RPG:** Loads color settings ideal for Role-Playing games.
- **Warm:** Increases the color temperature. The screen appears warmer with a red/yellow tint.
- **Cool:** Presents colors at higher color temperatures. The screen appears cooler with a blue tint.
- **Custom Color:** Allows you to manually adjust the color settings. Move the joystick to adjust the R/G/B color values and create your own preset color mode.



Icon	Menu and submenus	Description
------	-------------------	-------------

Input Color Format

- Allows you to set the video input mode to:
- **RGB:** Select this option if your monitor is connected to a computer or a media player that supports RGB output.
 - **YCbCr:** Select this option if your media player supports only YCbCr output.

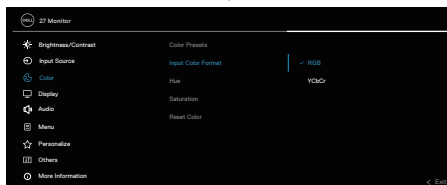

Hue

This feature can shift the color of the video image to green or purple. This is used to adjust the desired flesh tone color. Use ⤴ or ⤵ to adjust the hue from 0 to 100.

Move the joystick ⤴ to increase the green shade of the video image.

Move the joystick ⤵ to increase the purple shade of the video image.

 **NOTE: Hue adjustment is available only when you select Movie or Game preset mode.**

Saturation





This feature can adjust the color saturation of the video image. Use ⤴ or ⤵ to adjust the saturation from 0 to 100.

Move the joystick ⤴ to increase the colorful appearance of the video image.

Move the joystick ⤵ to increase the monochrome appearance of the video image.

 **NOTE: Saturation adjustment is available only when you select Movie or Game preset mode.**



Icon	Menu and submenus	Description
	Reset Color	Resets your monitor's color settings to the factory settings.
	Display	Uses the display to adjust image.
		 
	Aspect Ratio	Adjusts the image ratio to 16:9, 4:3, 5:4.
	Sharpness	<p>Make the image look sharper or softer.</p> <p>Move the joystick  and  to adjust the sharpness from 0 to 100.</p>
	Response Time	Allows you to set the Response Time to Normal , Fast or Extreme .
	Reset Display	Resets your monitor's display settings to the factory settings.



Icon	Menu and submenus	Description
------	-------------------	-------------

	Audio	Uses the display to adjust audio.
---	--------------	-----------------------------------

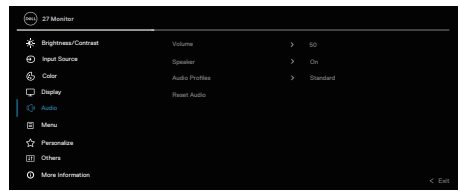

Volume	Volume adjusts the volume level of audio output. Move the joystick ⤴ to increase the volume and move the joystick ⤵ to decrease the volume (minimum 0%/maximum 100%).
---------------	--

Speaker	Allows you to turn on or off speaker function.
----------------	--

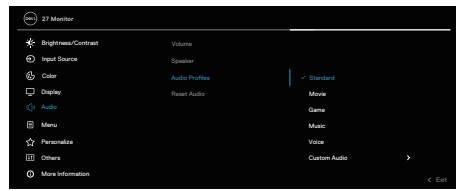

Audio Profiles	Expand to show the various audio profiles.
-----------------------	--



- Standard:** Default audio setting.
- Movie:** For motion picture viewing.
- Game:** For game.
- Music:** For music listening.
- Voice:** For speech.
- Custom Audio:** Allows you to manually adjust the sound. Move the joystick ⤴ and ⤵ to adjust the setting.

Reset Audio	Resets all audio settings to the factory preset values.
--------------------	---

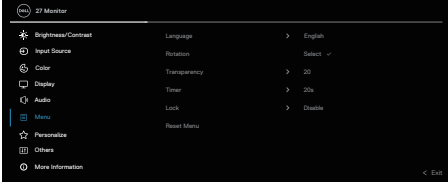

Icon	Menu and submenus	Description
	Menu	Select this option to adjust the settings of the OSD, such as the languages, the amount of time, the menu remains on screen and so on.  
	Language	Sets the OSD display to one of the following eight languages: English, Spanish, French, German, Brazilian Portuguese, Russian, Simplified Chinese or Japanese .
	Rotation	Press the joystick to rotate the OSD and the screen by 0/90/270 degrees. You can adjust the menu according to your display rotation.
	Transparency	Selects this option to change the menu transparency by moving the joystick button up or down (minimum 0; maximum 100).
	Timer	OSD Hold Time: Sets the length of time and then the OSD remains active after you press a button. Move the joystick to adjust the slider in 1 second increments, from 5 to 60 seconds.
	Lock	Controls user access to adjustments. User can select one of the following: Menu Buttons, Power Button, Menu + Power Buttons, Disable .
	Reset Menu	Resets all settings under the Menu to factory defaults.



Icon	Menu and submenus	Description
------	-------------------	-------------



Personalize Selects this option to adjust the settings of the personalization.

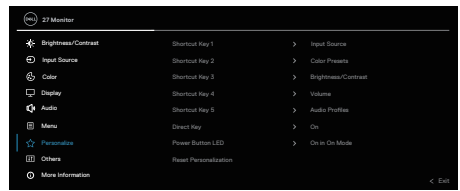

- Shortcut Key 1** Allows you to choose a feature from **Color Presets**, **Brightness/Contrast**, **Input Source**, **Aspect Ratio**, **Rotation**, **Volume**, **Display Info**, or **Audio Profiles** and set it as a shortcut key.
- Shortcut Key 2**
- Shortcut Key 3**
- Shortcut Key 4**
- Shortcut Key 5**

 **NOTE: To reduce to 4 Shortcut Keys, go to Shortcut Key 5, and select ‘-’. Once ‘-’ in Shortcut Key 5 is selected, the ‘-’ in Shortcut Key 4 will appear.**

- Direct Key** Turn on or off **Direct Key** function..
- Power Button LED** Enables you to set the state of the power light to save energy.
- Reset Personalization** Resets all settings under the **Personalize** menu to the factory preset values.



Others Changes the OSD settings, such as the **DDC/CI**, **LCD conditioning** and so on.

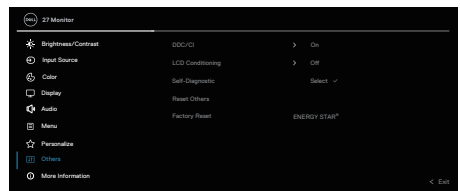

Icon	Menu and submenus	Description
	DDC/CI	<p>Enables your monitor parameters such as brightness, color balance and so on to be adjustable through the software on your computer. You can disable this feature by selecting Off.</p> <p>Enables this feature for best user experience and optimum performance of your monitor.</p>
	LCD Conditioning	<p>Helps reduce minor cases of image retention. Depending on the degree of image retention, the program may take some time to run. You can enable this feature by selecting On.</p>
	Self-Diagnostic	<p>Enables you to check if your monitor is functioning properly.</p>
Reset Others	<p>Resets all settings under the others setting menu to the factory preset values.</p>	
Factory Reset	<p>Restores all preset values to the factory default settings.</p>	

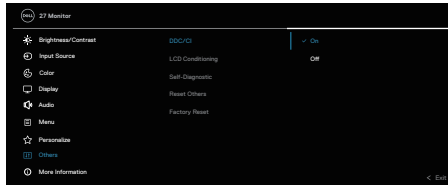

Icon	Menu and submenus	Description
------	-------------------	-------------



	More Information	Select this option for display information and Dell monitor support.
--	-------------------------	--

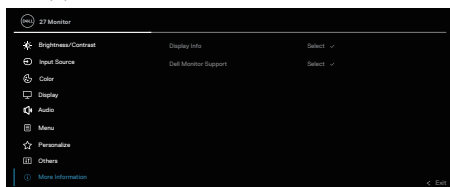



Menu and power button lock

Prevents users to access or change OSD menu settings on the display.

By default, the menu and power button lock setting is disabled.







To access the lock menu, move the joystick  or  or  or  and hold for four seconds. A lock menu appears at the bottom right corner of the display.

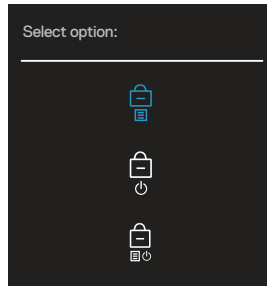

NOTE: The lock menu can be accessed using this method when the Menu and Power buttons are in unlocked state.





To access the unlock menu, move the joystick  or  or  or  and hold for four seconds. An unlock menu appears at the bottom right corner of the display.

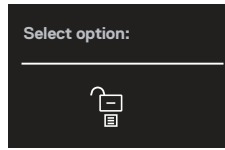

 **NOTE: The unlock menu can be accessed when the menu and power buttons are in locked state.**











There are three lock options.

	Menu	Description
1	Menu Buttons 	When Menu Buttons is selected, the OSD menu settings cannot be changed. All buttons are locked except for the power button.
2	Power Button 	When Power Button is selected, the display cannot be turned off using the power button.
3	Menu + Power Buttons 	When Menu + Power Buttons is selected, the OSD menu settings cannot be changed and the power button is locked.





 **NOTE: To access the Lock or Unlock menu, move the joystick  or  or  or  and hold for four seconds.**

In the following scenarios, the  icon appears at the center of the display:

- When you move the joystick  or  or  or . It indicates the OSD menu buttons are in lock state.
- When the power button is pressed. It indicates the power button is in lock state.
- When you move the joystick  or  or  or  and the power button is pressed. It indicates OSD menu buttons, and the power button is in lock state.



Unlocking the OSD menu and Power buttons:

1. Move the joystick  or  or  or  and hold for four seconds. The unlock menu appears.
2. Select the unlock icon  to unlock the buttons on the display.



OSD warning messages

When the monitor does not support a particular resolution mode, the following message is displayed:

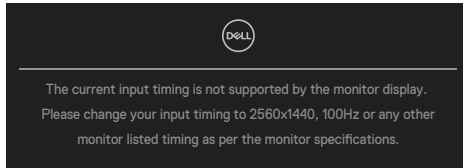

This message indicates that the monitor cannot synchronize with the signal that it is receiving from the computer. See [Monitor specifications](#) for the Horizontal and Vertical frequency ranges addressable by this monitor. The recommended mode is 2560 x 1440.

Before the **DDC/CI** function is disabled, the following message is displayed:

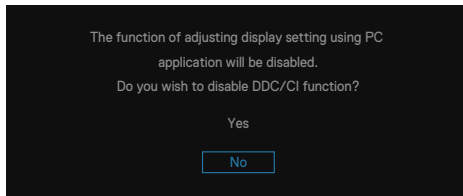

When you adjust the **Brightness** level above the default level for the first time, the following message appears:

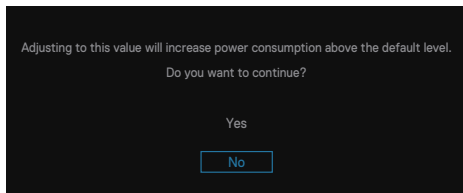

 **NOTE:** If you select **Yes**, the message will not appear the next time you change the brightness setting.



When the monitor enters the **Standby mode**, the following message appears:

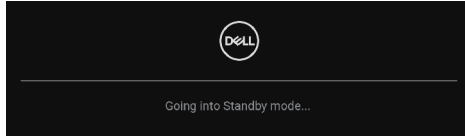

If you press any button other than the power button, the following messages appear depending on the selected input:

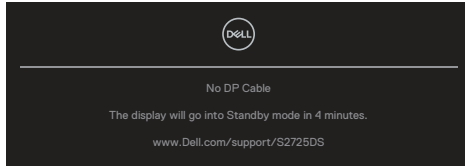

If an HDMI or DisplayPort cable is not connected, the following dialog box appears. The monitor enters Standby mode after four minutes if left at this state.

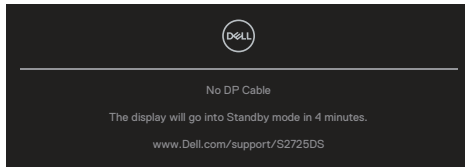

or

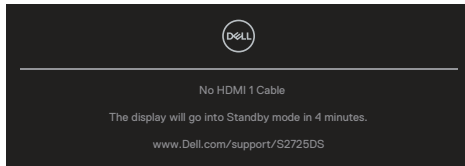

or

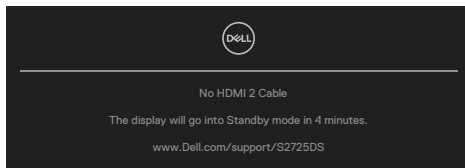



NOTE: The message may be slightly different according to the connected input signal.

When you select OSD items of **Factory Reset** in **Other** feature, the following message appears:

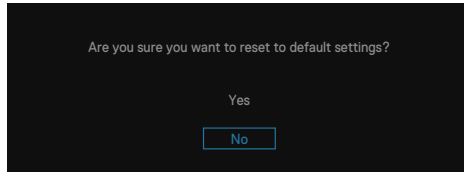

For more information, see [Troubleshooting](#).



Setting the maximum resolution

 **NOTE: The steps may vary slightly depending on the version of Windows you have.**

In Windows 10 and Windows 11:

1. Right-click the desktop and click **Display settings**.
2. If you have more than one monitor connected, ensure to select **S2725DS**.
3. Click the **Display Resolution** drop-down list and select **2560 x 1440**.
4. Click **Keep changes**.

If you do not see **2560 x 1440** as an option, you must update your graphics driver to the latest version. Depending on your computer, complete one of the following procedures:

If you have a Dell desktop or laptop, go to <https://www.dell.com/support>, enter your service tag and download the latest driver for your graphics card.

If you are using a non-Dell computer (laptop or desktop):

- Go to the support site for your computer and download the latest graphic drivers.
- Go to your graphics card website and download the latest graphic drivers.



Troubleshooting



WARNING: Before you begin working on the following steps, follow the [Safety instructions](#).

Self-Test

Your monitor provides a self-test feature that enables you to check if your monitor is functioning properly. If your monitor and computer are properly connected but the monitor screen remains dark, run the monitor self-test by performing the following steps:

1. Turn off both your computer and the monitor.
2. Disconnect all video cables from the monitor. This way, the computer does not have to be involved.
3. Turn on the monitor.

If the monitor is working correctly, it detects that there is no signal and one of the following messages appear. While in self-test mode, the power LED remains white.

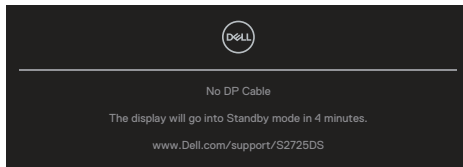

or

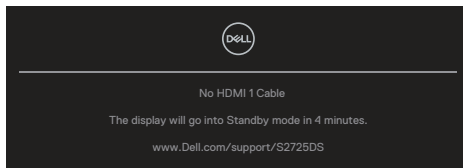

or

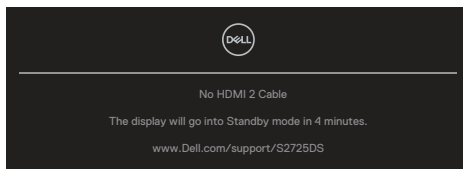

 **NOTE: This dialog box appears even during normal operation and when the video cable is disconnected or damaged.**

4. Turn off your monitor and reconnect the video cable; Turn on your computer and the monitor.

If your monitor remains dark after you reconnect the cables, check your video controller and computer, as your monitor is functioning properly.

 **NOTE: The message may be slightly different according to the connected input signal.**

 **NOTE: While in self-test mode, the power LED remains white.**

5. This box also appears during normal system operation, if the video cable becomes disconnected or damaged.
6. Turn Off your monitor and reconnect the video cable; then turn On both your computer and the monitor.

If your monitor screen remains blank after you use the previous procedure, check your video controller and computer, because your monitor is functioning properly.

Built-in diagnostics

Your monitor has a built-in diagnostic tool. It helps you determine if the screen abnormality that you are experiencing is an inherent problem with your monitor or with your computer and video card.

To run the built-in diagnostics:

1. Ensure that the screen is clean (no dust particles on the surface of the screen).
2. Press the Joystick button to launch the OSD Main Menu.
3. Move the joystick button to select **Others > Self-Diagnostic** to initiate the self-diagnostic process.

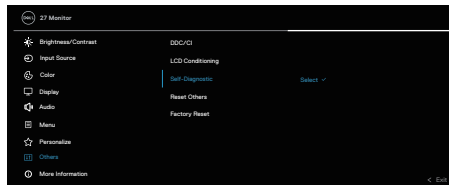

4. When initiated, a gray screen appears. Inspect the screen for abnormalities.
5. Switch the joystick button. The color of the screen changes to red. Inspect the screen for abnormalities.
6. Repeat step 5 and inspect the screen when it displays the colors green, blue, black and white followed by the on-screen text.
7. The test is complete when the text screen appears. To exit, toggle the joystick button again.

If you do not detect any screen abnormalities upon using the Built-in diagnostics tool, the monitor is functioning properly. Check the video card and computer.



Common problems

The following table contains general information about common monitor problems you might encounter and the possible solutions:

Common Symptoms	What you experience	Possible Solutions
No video or power LED off	No picture	<ul style="list-style-type: none">Ensure that the video cable connecting the monitor and the computer is properly connected and secure.Verify that the power outlet is functioning properly using any other electrical equipment.Ensure that the power button is pressed.Ensure that the correct input source is selected through the Input Source menu.
No video or power LED on	No picture or no brightness	<ul style="list-style-type: none">Increase brightness and contrast controls using the OSD.Perform monitor self-test feature check.Check for bent or broken pins in the video cable connector.Run the built-in diagnostics.Ensure that the correct input source is selected through the Input Source menu.
Poor focus	Picture is fuzzy, blurry or ghosting	<ul style="list-style-type: none">Eliminate video extension cables.Reset the monitor to factory settings (Factory Reset).Change the video resolution to the correct aspect ratio.
Shaky or jittery video	Wavy picture or fine movement	<ul style="list-style-type: none">Reset the monitor to factory settings (Factory Reset).Check environmental factors.Relocate the monitor and test in another room.



Common Symptoms	What you experience	Possible Solutions
Missing pixels	LCD screen has spots	<ul style="list-style-type: none"> • Cycle power On-Off. • Pixel that is permanently off is a natural defect that can occur in LCD technology. • For more information about Dell Monitor Quality and Pixel Policy, see Dell Support site at: www.dell.com/pixelguidelines.
Stuck-on pixels	LCD screen has bright spots	<ul style="list-style-type: none"> • Cycle power On-Off. • Pixel that is permanently off is a natural defect that can occur in LCD technology. • For more information about Dell Monitor Quality and Pixel Policy, see Dell Support site at: www.dell.com/pixelguidelines.
Brightness problems	Picture too dim or too bright	<ul style="list-style-type: none"> • Reset the monitor to factory settings (Factory Reset). • Adjust brightness and contrast controls through OSD.
Geometric distortion	Screen not centered correctly	<ul style="list-style-type: none"> • Reset the monitor to factory settings (Factory Reset). • Adjust horizontal and vertical controls through OSD.
Horizontal or vertical lines	Screen has one or more lines	<ul style="list-style-type: none"> • Reset the monitor to factory settings (Factory Reset). • Perform monitor self-test feature check and determine if these lines are also in self-test mode. • Check for bent or broken pins in the video cable connector. • Run the built-in diagnostics.



Common Symptoms	What you experience	Possible Solutions
Synchronization problems	Screen is scrambled or appears torn	<ul style="list-style-type: none"> Reset the monitor to factory settings (Factory Reset). Perform monitor self-test feature check to determine if the scrambled screen appears in self-test mode. Check for bent or broken pins in the video cable connector. Restart the computer in the safe mode.
Safety related issues	Visible signs of smoke or sparks	<ul style="list-style-type: none"> Do not perform any troubleshooting steps. Contact Dell immediately.
Intermittent problems	Monitor malfunctions on and off	<ul style="list-style-type: none"> Ensure that the video cable connecting the monitor to the computer is connected properly and is secure. Reset the monitor to factory settings (Factory Reset). Perform monitor self-test feature check to determine if the intermittent problem occurs in self-test mode.
Missing color	Picture missing color	<ul style="list-style-type: none"> Perform monitor self-test feature check. Ensure that the video cable connecting the monitor to the computer is connected properly and is secure. Check for bent or broken pins in the video cable connector.
Wrong color	Picture color not good	<ul style="list-style-type: none"> Try different Color Presets in Color settings OSD. Adjust R/G/B value in Custom Color in Color settings OSD. Change the Input Color Format to RGB or YCbCr in the Color settings OSD. Run the built-in diagnostics.



Common Symptoms	What you experience	Possible Solutions
Image retention from a static image left on the monitor for a long period	Faint shadow from the static image that is displayed appears on the screen	<ul style="list-style-type: none"> • Set the screen to turn off after a few minutes of screen idle time. These can be adjusted in Windows Power Options or Mac Energy Saver setting. • Alternatively, use a dynamically changing screensaver.
Screen image is too small	Image is centered on screen, but does not fill entire viewing area	<ul style="list-style-type: none"> • Check the Aspect Ratio setting in the Display settings OSD. • Reset the monitor to factory settings (Factory Reset).
Cannot adjust the monitor with the buttons on the rear of the panel	OSD does not appear on the screen	<ul style="list-style-type: none"> • Turn off the monitor, unplug the monitor power cable, plug it back and then turn on the monitor. • Check if the OSD menu is locked. If yes, move the joystick ⤴ or ⤵ or ⤶ or ⤷ and hold for four seconds to unlock.
No input signal when user controls are pressed	No picture, the LED light is white	<ul style="list-style-type: none"> • Check the signal source. Ensure that the computer is not in Standby Mode by moving the mouse or pressing any key on the keyboard. • Check if the video cable is plugged in properly. Disconnect and reconnect the video cable if necessary. • Reset the computer or video player.
The picture does not fill the entire screen	The picture cannot fill the height or width of the screen	<ul style="list-style-type: none"> • Due to different video formats (aspect ratio) of DVDs, the monitor may display in full screen. • Run the built-in diagnostics.



Common Symptoms	What you experience	Possible Solutions
No video at HDMI or DisplayPort	When connected to some dongle or docking device at the port, there is no video when unplugging or plugging the cable from the notebook.	<ul style="list-style-type: none"> Unplug the HDMI or DisplayPort or USB-C to DisplayPort cable from dongle or docking device, then plug the docking HDMI, DisplayPort or USB-C to DisplayPort cable to the notebook.

Regulatory information

FCC notices (U.S. Only) and other regulatory information

For FCC notices and other regulatory information, see the regulatory compliance website at www.dell.com/regulatory_compliance.

EU product database for energy label and product information sheet

S2725DS: <https://eprel.ec.europa.eu/qr/1837683>

Contacting Dell

To contact Dell for sales, technical support or customer service issues, see www.dell.com/contactdell.

 **NOTE: Availability varies by country and product and some services may not be available in your country.**

 **NOTE: If you do not have an active Internet connection, you can find contact information on your purchase invoice, packing slip, bill or Dell product catalog.**

