



NUC 14 Performance Kit

NUC14SRKU7A

NUC14SRKU9B

User Guide

Regulatory Model: NUC14SRK (Kit)

COPYRIGHT INFORMATION

No part of this manual, including the products and software described in it, may be reproduced, transmitted, transcribed, stored in a retrieval system, or translated into any language in any form or by any means, except documentation kept by the purchaser for backup purposes, without the express written permission of ASUSTeK COMPUTER INC. ("ASUS").

ASUS PROVIDES THIS MANUAL "AS IS" WITHOUT WARRANTY OF ANY KIND, EITHER EXPRESS OR IMPLIED, INCLUDING BUT NOT LIMITED TO THE IMPLIED WARRANTIES OR CONDITIONS OF MERCHANTABILITY OR FITNESS FOR A PARTICULAR PURPOSE. IN NO EVENT SHALL ASUS, ITS DIRECTORS, OFFICERS, EMPLOYEES OR AGENTS BE LIABLE FOR ANY INDIRECT, SPECIAL, INCIDENTAL, OR CONSEQUENTIAL DAMAGES (INCLUDING DAMAGES FOR LOSS OF PROFITS, LOSS OF BUSINESS, LOSS OF USE OR DATA, INTERRUPTION OF BUSINESS AND THE LIKE), EVEN IF ASUS HAS BEEN ADVISED OF THE POSSIBILITY OF SUCH DAMAGES ARISING FROM ANY DEFECT OR ERROR IN THIS MANUAL OR PRODUCT.

Products and corporate names appearing in this manual may or may not be registered trademarks or copyrights of their respective companies, and are used only for identification or explanation and to the owners' benefit, without intent to infringe.

SPECIFICATIONS AND INFORMATION CONTAINED IN THIS MANUAL ARE FURNISHED FOR INFORMATIONAL USE ONLY, AND ARE SUBJECT TO CHANGE AT ANY TIME WITHOUT NOTICE, AND SHOULD NOT BE CONSTRUED AS A COMMITMENT BY ASUS. ASUS ASSUMES NO RESPONSIBILITY OR LIABILITY FOR ANY ERRORS OR INACCURACIES THAT MAY APPEAR IN THIS MANUAL, INCLUDING THE PRODUCTS AND SOFTWARE DESCRIBED IN IT.

Copyright © 2024 ASUSTeK COMPUTER INC. All Rights Reserved.

LIMITATION OF LIABILITY

Circumstances may arise where because of a default on ASUS' part or other liability, you are entitled to recover damages from ASUS. In each such instance, regardless of the basis on which you are entitled to claim damages from ASUS, ASUS is liable for no more than damages for bodily injury (including death) and damage to real property and tangible personal property; or any other actual and direct damages resulted from omission or failure of performing legal duties under this Warranty Statement, up to the listed contract price of each product.

ASUS will only be responsible for or indemnify you for loss, damages or claims based in contract, tort or infringement under this Warranty Statement.

This limit also applies to ASUS' suppliers and its reseller. It is the maximum for which ASUS, its suppliers, and your reseller are collectively responsible.

UNDER NO CIRCUMSTANCES IS ASUS LIABLE FOR ANY OF THE FOLLOWING: (1) THIRD-PARTY CLAIMS AGAINST YOU FOR DAMAGES; (2) LOSS OF, OR DAMAGE TO, YOUR RECORDS OR DATA; OR (3) SPECIAL, INCIDENTAL, OR INDIRECT DAMAGES OR FOR ANY ECONOMIC CONSEQUENTIAL DAMAGES (INCLUDING LOST PROFITS OR SAVINGS), EVEN IF ASUS, ITS SUPPLIERS OR YOUR RESELLER IS INFORMED OF THEIR POSSIBILITY.

SERVICE AND SUPPORT

Visit our multi-language website at <https://www.asus.com/support/>.

Contents

About this guide	4
Package contents	6
Front view	8
Rear view	8
NUC Kit Setup Guide	10
Installing the stand.....	10
Connecting the display.....	11
Connecting the keyboard and mouse.....	12
Connecting the LAN cable.....	13
Connecting the power adapter	14
Powering on the system	16
NUC Component Integration Guide	17
Opening system.....	17
DDR5 SO-DIMM Installation	20
M.2 Installation.....	21
Closing system	23

About this guide

This user guide includes information on the following NUC SKUs:

- **NUC Kit (barebones)**
(Memory and M.2 solid state drive not included; Operating system not included):
Specifications and steps to set up your NUC Kit.
-

NOTE: Memory and M.2 solid state drive are purchased separately for this SKU.

Audience

This user guide is intended to provide basic setup information about the NUC Kit and its components to the vendors, system integrators, and other engineers and technicians who need this level of information.

Conventions used in this guide

To highlight key information in this manual, some text are presented as follows:

IMPORTANT! This message contains vital information that must be followed to complete a task.

NOTE: This message contains additional information and tips that can help complete tasks.

WARNING! This message contains important information that must be followed to keep you safe while performing certain tasks and prevent damage to your NUC system's data and components.

Other Common Notation

#	Used after a signal name to identify an active-low signal (such as USBP0#)
GB	Gigabyte (1,073,741,824 bytes)
GB/s	Gigabytes per second
Gb/s	Gigabits per second
KB	Kilobyte (1024 bytes)
Kb	Kilobit (1024 bits)
kb/s	1000 bits per second
MB	Megabyte (1,048,576 bytes)
MB/s	Megabytes per second
Mb	Megabit (1,048,576 bits)
Mb/s	Megabits per second
TDP	Thermal Design Power
xxh	An address or data value ending with a lowercase h indicates a hexadecimal value.
x.x V	Volts. Voltages are DC unless otherwise specified.
x.x A	Amperes.

Production Identification Information

ASUSTeK NUC Product NUC14SRKU[X]A,B Identification Information

Product Name	NUC 14 Performance
NUC14SRKU[X]A,B	NUC14SRKU[X]A,B

Where to find more information

Refer to the following sources for additional information and for product and software updates.

1. ASUS website

The ASUS website (www.asus.com) provides updated information on ASUS hardware and software products.

Package contents

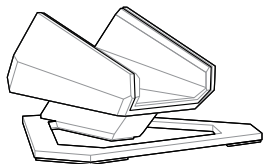
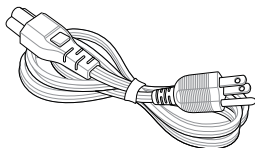
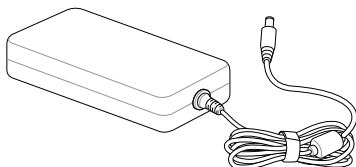
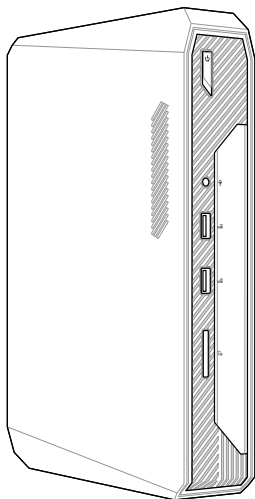

NOTE:





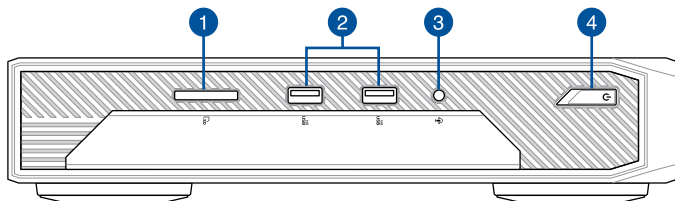

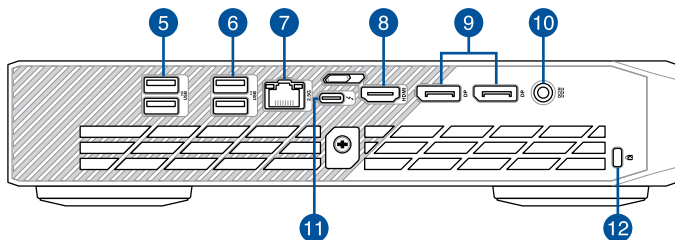

- The most up-to-date and accurate product specifications are available on www.asus.com for download.
 - Product and accessory images are for illustrative purposes only. The actual appearance and specifications may vary depending on the model.
 - *The bundled power adapter may vary depending on the model and the country (or region) of sale.
 - Some bundled accessories may vary depending on the model. For details on these accessories, refer to their respective user manuals.
 - If the device or its components fail or malfunction during normal and proper use within the warranty period, bring the warranty card to the ASUS Service Center for replacement of the defective components.
-

Front view



Rear view



- | | | | |
|---|---|----|--|
| 1 |  SD card slot | 7 | 2.5G LAN Port |
| 2 |  ^{10G} USB 3.2 Gen 2 port | 8 | HDMI HDMI™ port |
| 3 |  Headphone/Headset/
Microphone jack | 9 | DP DisplayPort |
| 4 |  Power button | 10 |  Power input |
| 5 |  ^{10G} USB 3.2 Gen 2 port | 11 |  Thunderbolt™ 4 port |
| 6 |  ^{2.0} USB 2.0 port | 12 |  Kensington security slot |

Thunderbolt 4 / USB 4 (Type-C®) specifications:

Feature	Details
Type-C® output support	Thunderbolt 4 (40Gbps), native USB 4 (10Gbps), native DP1.4
Power over Type-C®	15W; 18W
Power profiles support	12V @ 1.5A, 5V @ 3A and 9V @ 2A

Display resolution table:

Port	Video Output	Max. Resolution
HDMI	HDMI 2.1	8K (7680 x 4320) @ 60Hz (FRL Mode); 4K (3840 x 2160) @ 60Hz (TMDS Mode)
DisplayPort 1	DisplayPort 1.4a	5K (5120 x 2160) @ 60Hz
DisplayPort 2	DisplayPort 1.4a	5K (5120 x 2160) @ 60Hz
Thunderbolt (Type-C®)	DisplayPort 2.1	8K (7680 x 4320) @ 60Hz compressed

LAN port LED indications:



Link LED	
Status	Description
OFF	No link
GREEN	Linked
BLINKING	Data activity

Speed LED	
Status	Description
OFF	100 Mbps / 10 Mbps connection
YELLOW	1 Gbps connection
GREEN	2.5 Gbps connection

NUC Kit Setup Guide

Installing the stand

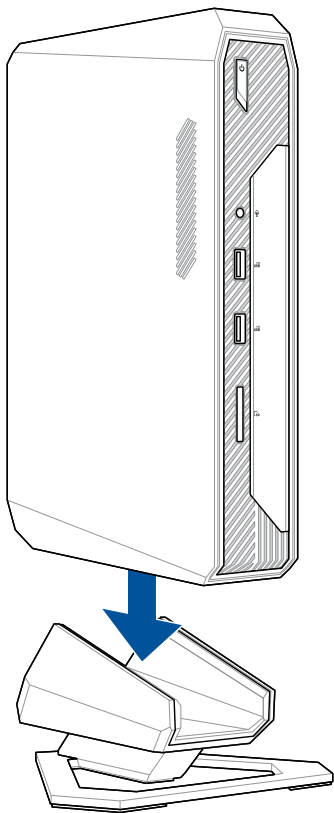

Connecting the display

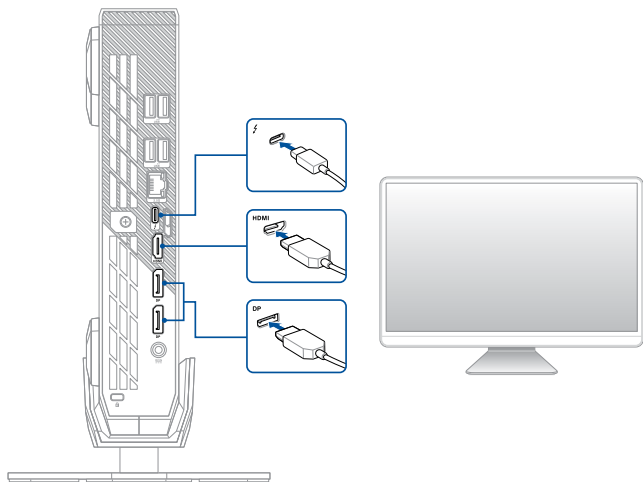

Connecting the keyboard and mouse

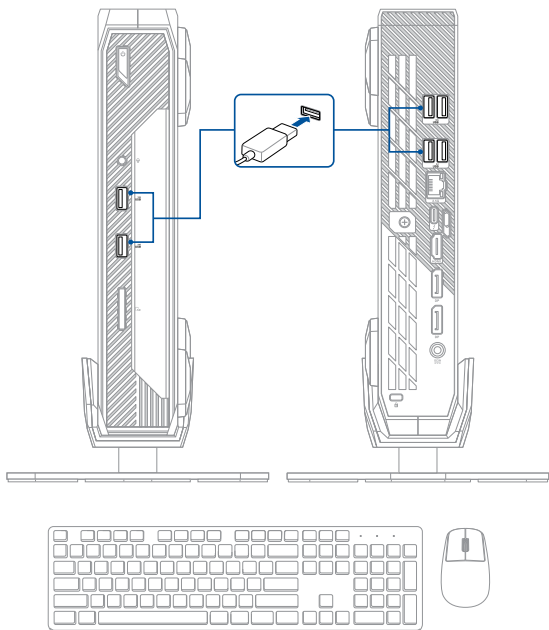

Connecting the LAN cable

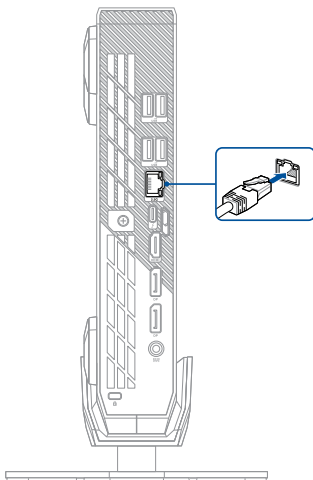

Connecting the power adapter

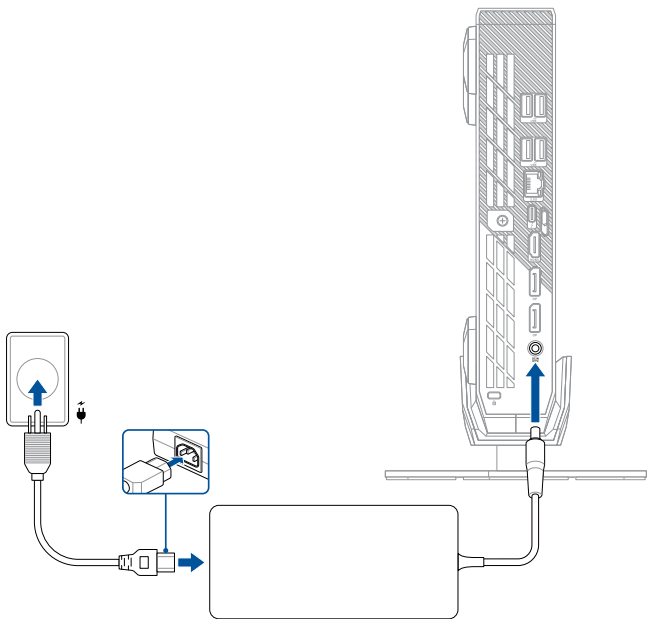



NOTE: Please refer to the following for more information on the adapter and the system:

330W Power adapter

- Input voltage: 100-240 Vac
- Input frequency: 50-60 Hz
- Output current: 16.92 A (330.0 W) / 16.5A (330.0 W)
- Output voltage: 19.5 Vdc / 20 Vdc
- Rated for use between 0°C and 35°C (32°F and 95°F)

System

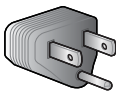
- Rated input current: 16.9 A (330.0 W) / 16.5A (330.0 W)
 - Rated input voltage: 19.5 Vdc / 20 Vdc
 - Operating temperature: 0°C to 35°C (32°F and 95°F)
-

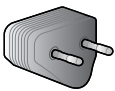
Plug			
Code	US	CN	EU
Country	United States	China	European Union

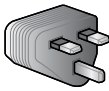
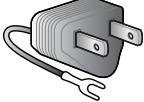
Plug			
Code	AU	UK	JP
Country	Australia	United Kingdom	Japan (Type-A)

Powering on the system

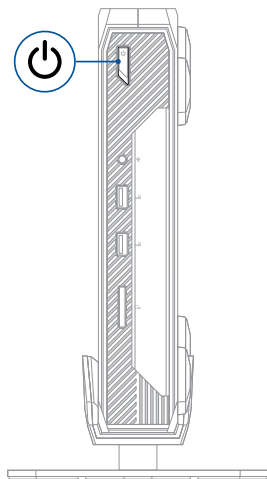

NUC Component Integration Guide

Opening system

1

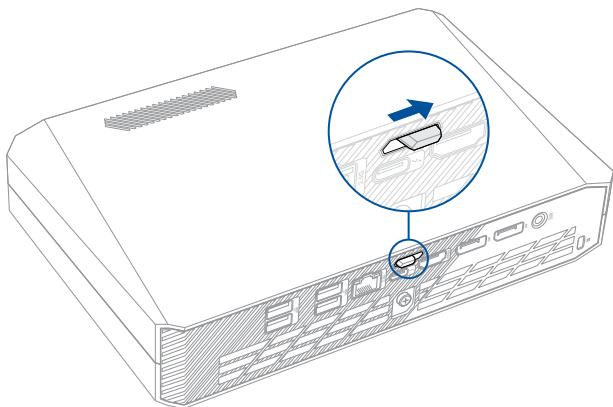

2

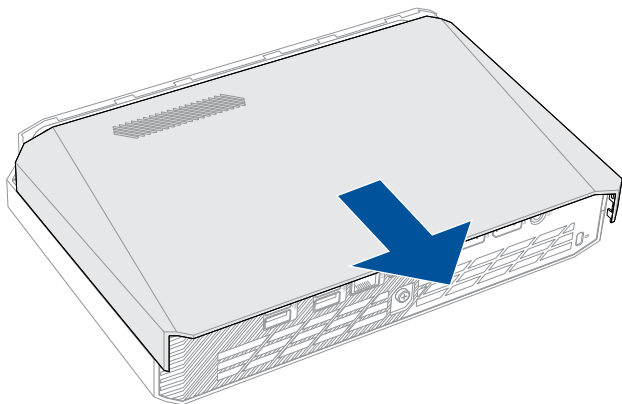

3

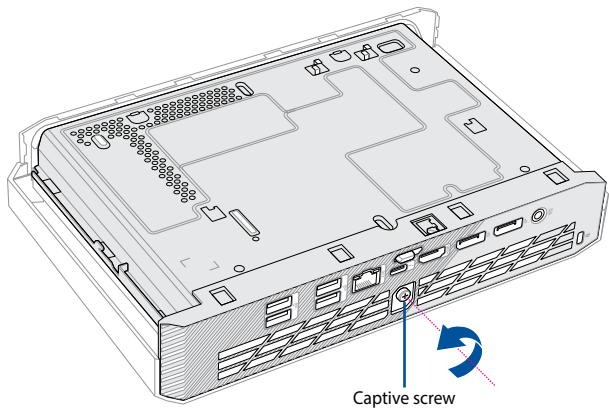

4

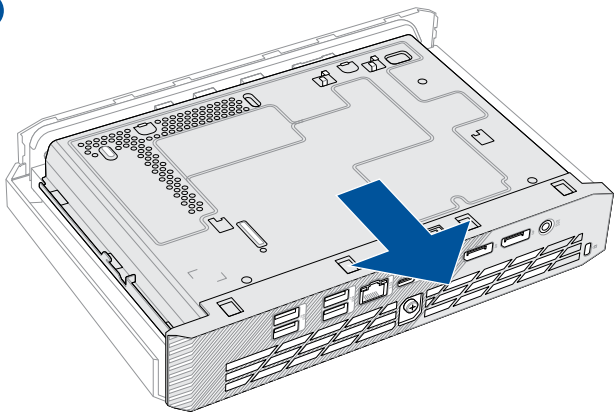

5

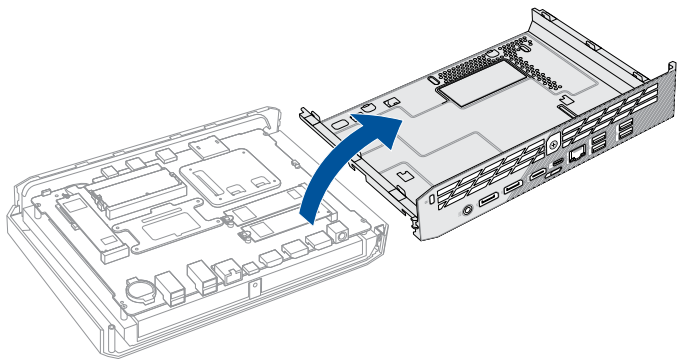

DDR5 SO-DIMM Installation

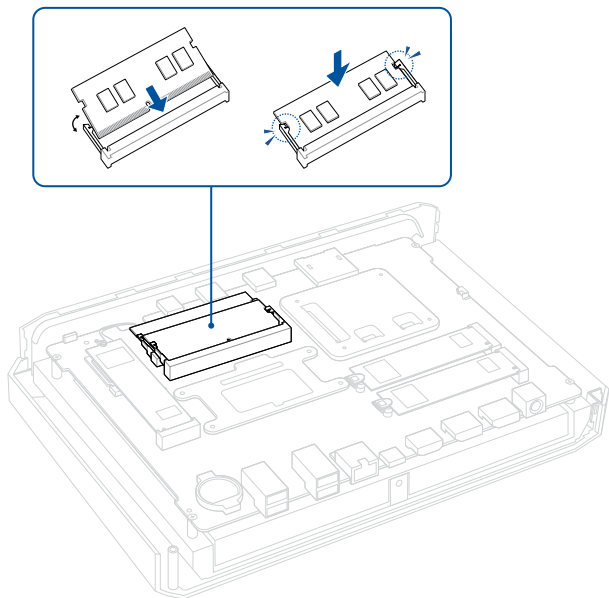

M.2 Installation

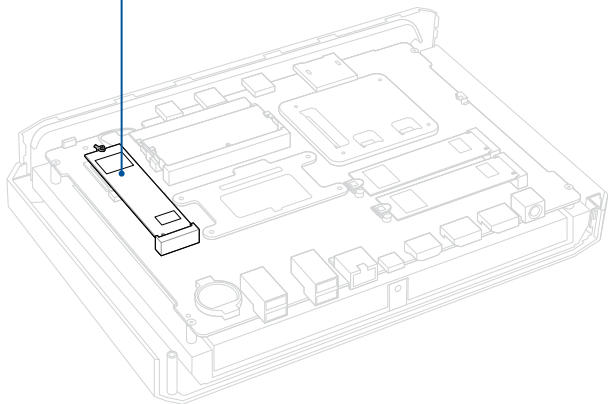
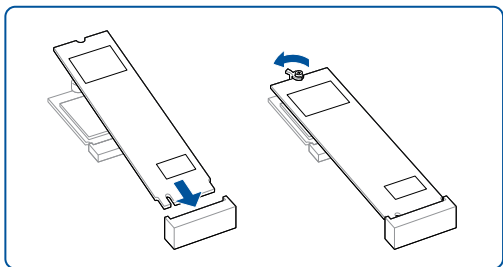

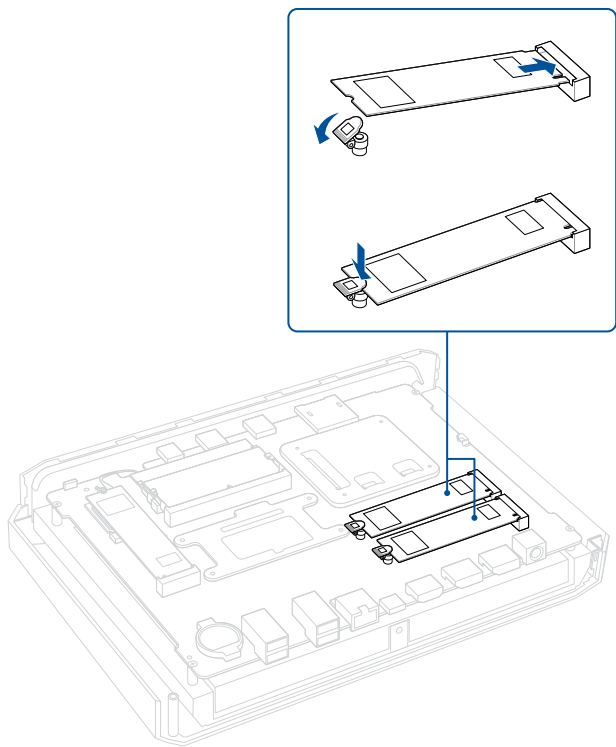

Closing system

1

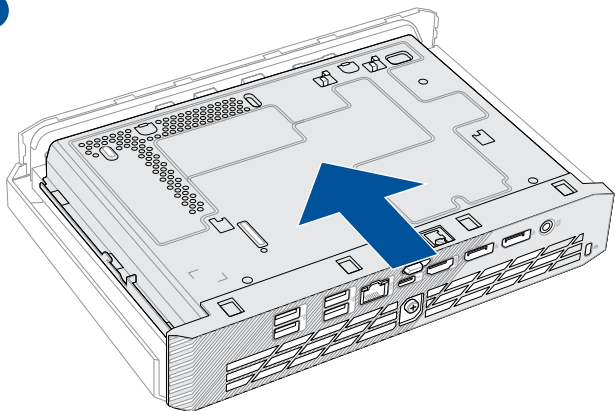

IMPORTANT! Do not remove the tape or film covering the thermal pad on the top shield module.

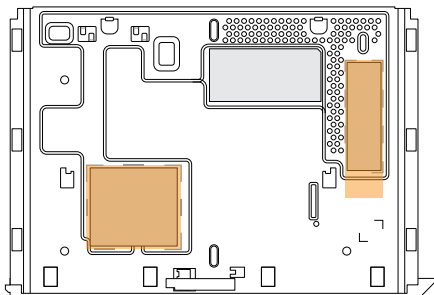

2

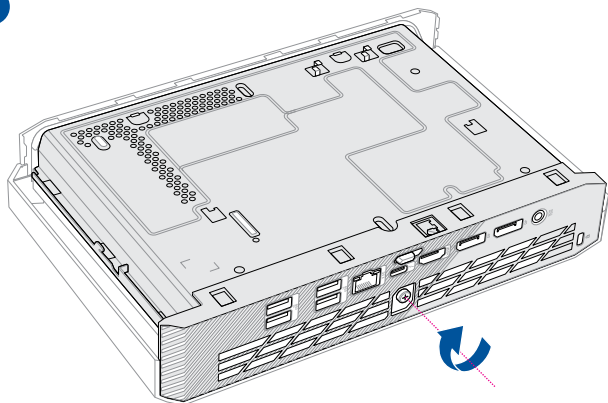

3

