

OptiPlex 3000 Thin Client

Service Manual

Notes, cautions, and warnings

 **NOTE:** A NOTE indicates important information that helps you make better use of your product.

 **CAUTION:** A CAUTION indicates either potential damage to hardware or loss of data and tells you how to avoid the problem.

 **WARNING:** A WARNING indicates a potential for property damage, personal injury, or death.











Chapter 1: Working inside your computer	5
Safety instructions.....	5
Before working inside your computer.....	5
Safety precautions.....	6
Electrostatic discharge—ESD protection.....	6
ESD Field Service kit	7
Transporting sensitive components.....	8
After working inside your computer.....	8
BitLocker.....	8
Coin-cell battery.....	9
Removing the coin-cell battery.....	9
Installing the coin-cell battery.....	9
Chapter 2: Removing and installing components	12
Recommended tools.....	12
Screw list.....	12
Major components of OptiPlex 3000 Thin Client.....	13
Side cover.....	14
Removing the side cover.....	14
Installing the side cover.....	15
Speaker.....	17
Removing the speaker.....	17
Installing the speaker.....	17
Solid-state drive	18
Removing the M.2 2230 solid-state drive	18
Installing the M.2 2230 solid-state drive	19
Memory modules.....	20
Removing the memory modules.....	20
Installing the memory modules.....	21
WLAN card.....	25
Removing the WLAN card.....	25
Installing the WLAN card.....	25
Small Form Factor Pluggable (SFP) port.....	27
Removing the Small Form Factor Pluggable (SFP) port.....	27
Installing the Small Form Factor Pluggable (SFP) port.....	29
Optional modules.....	31
Removing the optional Type-C module	31
Installing the optional Type-C module	32
Removing the optional HDMI module.....	32
Installing the optional HDMI module.....	33
Removing the optional Serial module.....	34
Installing the optional Serial module.....	35
Removing the optional PS/2 keyboard/mouse module.....	36
Installing the optional PS/2 keyboard/mouse module.....	37

Heat sink.....	38
Removing the heat sink.....	38
Installing the heat sink.....	38
Internal Antenna	39
Removing the internal antenna in Location 1.....	39
Installing the internal antenna in Location 1.....	40
Removing the internal antenna in Location 2.....	41
Installing the internal antenna in Location 2.....	43
SMA antenna kit	45
Removing the SMA antenna in Location 2.....	45
Installing the SMA antenna Location 2.....	46
System board.....	47
Removing the system board.....	47
Installing the system board.....	49
Chapter 3: Drivers and downloads.....	54
Chapter 4: BIOS Setup.....	55
Entering BIOS setup program.....	55
Navigation keys.....	55
F12 One Time Boot menu.....	55
System setup options.....	56
Updating the BIOS.....	63
Updating the BIOS in Windows.....	63
Updating the BIOS in Linux and Ubuntu.....	64
Updating the BIOS using the USB drive in Windows.....	64
Updating the BIOS from the F12 One-Time boot menu.....	64
System and setup password.....	65
Assigning a System Setup password.....	65
Deleting or changing an existing system setup password.....	66
Clearing CMOS settings.....	66
Clearing BIOS (System Setup) and System passwords.....	67
Chapter 5: Troubleshooting.....	68
Dell SupportAssist Pre-boot System Performance Check diagnostics.....	68
Running the SupportAssist Pre-Boot System Performance Check.....	68
System-diagnostic lights.....	68
Recovering the operating system.....	69
Real Time Clock—RTC reset.....	69
Backup media and recovery options.....	70
Wi-Fi power cycle.....	70
Chapter 6: Getting help and contacting Dell.....	71

Working inside your computer

Safety instructions

Use the following safety guidelines to protect your computer from potential damage and to ensure your personal safety. Unless otherwise noted, each procedure in this document assumes that you have read the safety information that shipped with your computer.

-  **WARNING:** Before working inside your computer, read the safety information that is shipped with your computer. For more safety best practices, see the Regulatory Compliance home page at [Dell Regulatory Compliance Home Page](#).
-  **WARNING:** Disconnect your computer from all power sources before opening the computer cover or panels. After you finish working inside the computer, replace all covers, panels, and screws before connecting your computer to an electrical outlet.
-  **CAUTION:** To avoid damaging the computer, ensure that the work surface is flat, dry, and clean.
-  **CAUTION:** To avoid damaging the components and cards, handle them by their edges, and avoid touching the pins and the contacts.
-  **CAUTION:** You should only perform troubleshooting and repairs as authorized or directed by the Dell technical assistance team. Damage due to servicing that is not authorized by Dell is not covered by your warranty. See the safety instructions that is shipped with the product or at [Dell Regulatory Compliance Home Page](#).
-  **CAUTION:** Before touching anything inside your computer, ground yourself by touching an unpainted metal surface, such as the metal at the back of the computer. While you work, periodically touch an unpainted metal surface to dissipate static electricity which could harm internal components.
-  **CAUTION:** When you disconnect a cable, pull it by its connector or its pull tab, not the cable itself. Some cables have connectors with locking tabs or thumbscrews that you must disengage before disconnecting the cable. When disconnecting cables, keep them evenly aligned to avoid bending the connector pins. When connecting cables, ensure that the ports and the connectors are correctly oriented and aligned.
-  **CAUTION:** Press and eject any installed card from the media-card reader.
-  **CAUTION:** Exercise caution when handling rechargeable Li-ion batteries in laptops. Swollen batteries should not be used and should be replaced and disposed properly.
-  **NOTE:** The color of your computer and certain components may differ from what is shown in this document.

Before working inside your computer

About this task

-  **NOTE:** The images in this document may differ from your computer depending on the configuration you ordered.

Steps

1. Save and close all open files and exit all open applications.
2. Shut down your computer. For Windows operating system, click **Start** >  **Power** > **Shut down**.

 **NOTE:** If you are using a different operating system, see the documentation of your operating system for shut-down instructions.

3. Disconnect your computer and all attached devices from their electrical outlets.
4. Disconnect all attached network devices and peripherals, such as keyboard, mouse, and monitor from your computer.

 **CAUTION:** To disconnect a network cable, first unplug the cable from your computer and then unplug the cable from the network device.

5. Remove any media card and optical disc from your computer, if applicable.

Safety precautions

The safety precautions chapter details the primary steps to be taken before performing any disassembly instructions.

Observe the following safety precautions before you perform any installation or break-fix procedures involving disassembly or reassembly:

- Turn off the computer and all attached peripherals.
- Disconnect the computer and all attached peripherals from AC power.
- Disconnect all network cables, telephone, and telecommunications lines from the computer.
- Use an ESD field service kit when working inside any tablet/notebook/desktop to avoid electrostatic discharge (ESD) damage.
- After removing any computer component, carefully place the removed component on an anti-static mat.
- Wear shoes with non-conductive rubber soles to reduce the chance of getting electrocuted.
- Unplugging, pressing, and holding the power button for 15 seconds should discharge residual power in the system board.

Standby power

Dell products with standby power must be unplugged before you open the case. Systems that incorporate standby power are powered while turned off. The internal power enables the computer to be remotely turned on (Wake-on-LAN) and suspended into a sleep mode and has other advanced power management features.

Bonding

Bonding is a method for connecting two or more grounding conductors to the same electrical potential. This is done by using a field service electrostatic discharge (ESD) kit. When connecting a bonding wire, ensure that it is connected to bare metal and never to a painted or nonmetal surface. The wrist strap should be secure and in full contact with your skin, and ensure that you remove all jewelry such as watches, bracelets, or rings prior to bonding yourself and the equipment.

Electrostatic discharge—ESD protection

ESD is a major concern when you handle electronic components, especially sensitive components such as expansion cards, processors, memory modules, and system boards. Slight charges can damage circuits in ways that may not be obvious, such as intermittent problems or a shortened product life span. As the industry pushes for lower power requirements and increased density, ESD protection is an increasing concern.

Due to the increased density of semiconductors used in recent Dell products, the sensitivity to static damage is now higher than in previous Dell products. For this reason, some previously approved methods of handling parts are no longer applicable.

Two recognized types of ESD damage are catastrophic and intermittent failures.

- **Catastrophic** – Catastrophic failures represent approximately 20 percent of ESD-related failures. The damage causes an immediate and complete loss of device functionality. An example of catastrophic failure is a memory DIMM that has received a static shock and immediately generates a "No POST/No Video" symptom with a beep code that is emitted for missing or nonfunctional memory.
- **Intermittent** – Intermittent failures represent approximately 80 percent of ESD-related failures. The high rate of intermittent failures means that most of the time when damage occurs, it is not immediately recognizable. The DIMM receives a static shock, but the tracing is merely weakened and does not immediately produce outward symptoms that are related to the damage. The weakened trace may take weeks or months to melt, and in the meantime may cause degradation of memory integrity, intermittent memory errors, and so on.

The more difficult type of damage to recognize and troubleshoot is the intermittent (also called latent or "walking wounded") failure.

Perform the following steps to prevent ESD damage:

- Use a wired ESD wrist strap that is properly grounded. Wireless anti-static straps do not provide adequate protection. Touching the chassis before handling parts does not ensure adequate ESD protection on parts with increased sensitivity to ESD damage.
- Handle all static-sensitive components in a static-safe area. If possible, use anti-static floor pads and workbench pads.
- When unpacking a static-sensitive component from its shipping carton, do not remove the component from the anti-static packing material until you are ready to install the component. Before unwrapping the anti-static packaging, ensure that you discharge static electricity from your body.
- Before transporting a static-sensitive component, place it in an anti-static container or packaging.

ESD Field Service kit

The unmonitored Field Service kit is the most commonly used service kit. Each Field Service kit includes three main components: anti-static mat, wrist strap, and bonding wire.

Components of an ESD field service kit

The components of an ESD field service kit are:

- **Anti-Static Mat** – The anti-static mat is dissipative and parts can be placed on it during service procedures. When using an anti-static mat, your wrist strap should be snug and the bonding wire should be connected to the mat and to any bare metal on the computer being worked on. Once deployed properly, service parts can be removed from the ESD bag and placed directly on the mat. ESD-sensitive items are safe in your hand, on the ESD mat, in the computer, or inside an ESD bag.
- **Wrist Strap and Bonding Wire** – The wrist strap and bonding wire can be either directly connected between your wrist and bare metal on the hardware if the ESD mat is not required, or connected to the anti-static mat to protect hardware that is temporarily placed on the mat. The physical connection of the wrist strap and bonding wire between your skin, the ESD mat, and the hardware is known as bonding. Use only Field Service kits with a wrist strap, mat, and bonding wire. Never use wireless wrist straps. Always be aware that the internal wires of a wrist strap are prone to damage from normal wear and tear, and must be checked regularly with a wrist strap tester in order to avoid accidental ESD hardware damage. It is recommended to test the wrist strap and bonding wire at least once per week.
- **ESD Wrist Strap Tester** – The wires inside an ESD strap are prone to damage over time. When using an unmonitored kit, it is a best practice to regularly test the strap prior to each service call, and at a minimum, test once per week. A wrist strap tester is the best method for doing this test. If you do not have your own wrist strap tester, check with your regional office to find out if they have one. To perform the test, plug the bonding-wire of wrist-strap into the tester while it is strapped to your wrist and push the button to test. A green LED is lit if the test is successful; a red LED is lit and an alarm sounds if the test fails.
- **Insulator Elements** – It is critical to keep ESD sensitive devices, such as plastic heat sink casings, away from internal parts that are insulators and often highly charged.
- **Working Environment** – Before deploying the ESD Field Service kit, assess the situation at the customer location. For example, deploying the kit for a server environment is different than for a desktop or laptop environment. Servers are typically installed in a rack within a data center; desktops or laptops are typically placed on office desks or cubicles. Always look for a large open flat work area that is free of clutter and large enough to deploy the ESD kit with additional space to accommodate the type of computer that is being repaired. The workspace should also be free of insulators that can cause an ESD event. On the work area, insulators such as Styrofoam and other plastics should always be moved at least 12 inches or 30 centimeters away from sensitive parts before physically handling any hardware components.
- **ESD Packaging** – All ESD-sensitive devices must be shipped and received in static-safe packaging. Metal, static-shielded bags are preferred. However, you should always return the damaged part using the same ESD bag and packaging that the new part arrived in. The ESD bag should be folded over and taped shut and all the same foam packing material should be used in the original box that the new part arrived in. ESD-sensitive devices should be removed from packaging only at an ESD-protected work surface, and parts should never be placed on top of the ESD bag because only the inside of the bag is shielded. Always place parts in your hand, on the ESD mat, in the computer, or inside an anti-static bag.
- **Transporting Sensitive Components** – When transporting ESD sensitive components such as replacement parts or parts to be returned to Dell, it is critical to place these parts in anti-static bags for safe transport.

ESD protection summary

It is recommended to always use the traditional wired ESD grounding wrist strap and protective anti-static mat when servicing Dell products. In addition, it is critical to keep sensitive parts separate from all insulator parts while performing service and use anti-static bags for transporting sensitive components.

Transporting sensitive components

When transporting ESD sensitive components such as replacement parts or parts to be returned to Dell, it is critical to place these parts in anti-static bags for safe transport.

Lifting equipment

Adhere to the following guidelines when lifting heavy equipment:

 **CAUTION: Do not lift greater than 50 pounds. Always obtain additional resources or use a mechanical lifting device.**

1. Get a firm balanced footing. Keep your feet apart for a stable base, and point your toes out.
2. Tighten stomach muscles. Abdominal muscles support your spine when you lift, offsetting the force of the load.
3. Lift with your legs, not your back.
4. Keep the load close. The closer it is to your spine, the less force it exerts on your back.
5. Keep your back upright, whether lifting or setting down the load. Do not add the weight of your body to the load. Avoid twisting your body and back.
6. Follow the same technique in reverse to set the load down.

After working inside your computer

About this task

 **CAUTION: Leaving stray or loose screws inside your computer may severely damage your computer.**

Steps

1. Replace all screws and ensure that no stray screws remain inside your computer.
2. Connect any external devices, peripherals, or cables you removed before working on your computer.
3. Replace any media cards, discs, or any other parts that you removed before working on your computer.
4. Connect your computer and all attached devices to their electrical outlets.
5. Turn on your computer.

BitLocker

 **CAUTION: If BitLocker is not suspended before updating the BIOS, the next time you reboot the system it will not recognize the BitLocker key. You will then be prompted to enter the recovery key to progress, and the system will ask for the recovery key on each reboot. If the recovery key is not known, this can result in data loss or an unnecessary operating system reinstall. For more information about this subject, see Knowledge Article: [updating the BIOS on Dell systems with BitLocker enabled](#).**

The installation of the following components triggers BitLocker:

- Hard disk drive or solid-state drive
- System board

Coin-cell battery

Removing the coin-cell battery

⚠️ WARNING: This computer contains a coin-cell battery and requires trained technicians for handling guidance.

⚠️ CAUTION: Removing the coin-cell battery clears the CMOS and reset the BIOS settings.

Prerequisites

1. Follow the procedure in [before working inside your computer](#).
2. Remove the [side cover](#).

About this task

The following image indicates the location of the coin-cell battery and provides a visual representation of the removal procedure.

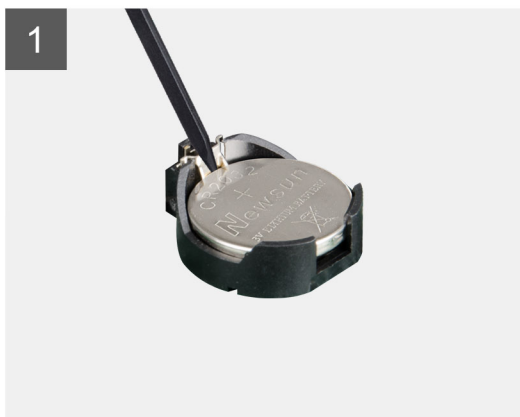
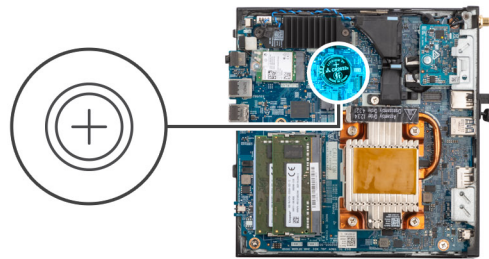

Steps

1. Using a plastic scribe, gently pry the coin-cell battery out of the coin-cell battery slot on the system board.
2. Lift the coin-cell battery out of the socket on the system board.

Installing the coin-cell battery

⚠️ WARNING: This computer contains a coin-cell battery and requires trained technicians for handling guidance.

Prerequisites

If you are replacing a component, remove the existing component before performing the installation procedure.

About this task

The following image indicates the location of the coin-cell battery and provides a visual representation of the installation procedure.

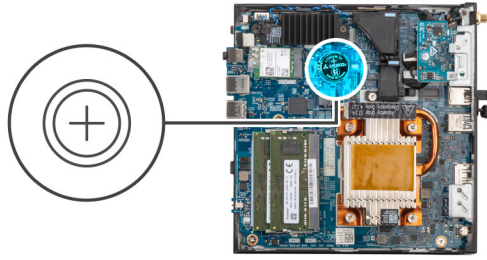

Steps

Insert the coin-cell battery into the battery socket with the positive side facing up, and snap the battery into place. To install the mylar sheet, follow the below mentioned steps:

i **NOTE:** The coin-cell battery has a black mylar for cosmetic purpose only and has no functional impact. During the installation of a new system board, it is recommended to transfer the black mylar from the previous system board to the new system board.

i **NOTE:** The design of the coin-cell battery mylar may vary depending on the configuration.

For mylar sheet with folding lines:

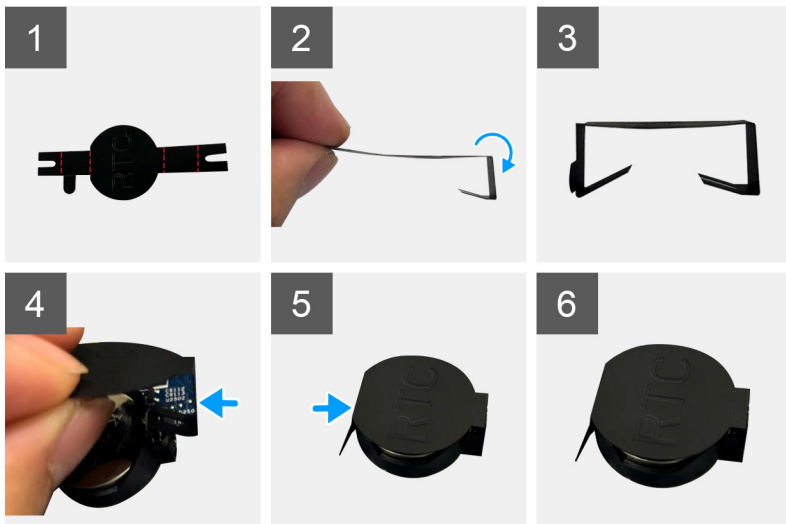

- Use the folding lines on the mylar sheet to fold the mylar sheet.
- Insert one end of the mylar sheet under the RTC socket.
- Insert another end of the mylar sheet under another side of the RTC socket.

For mylar sheet with adhesive:

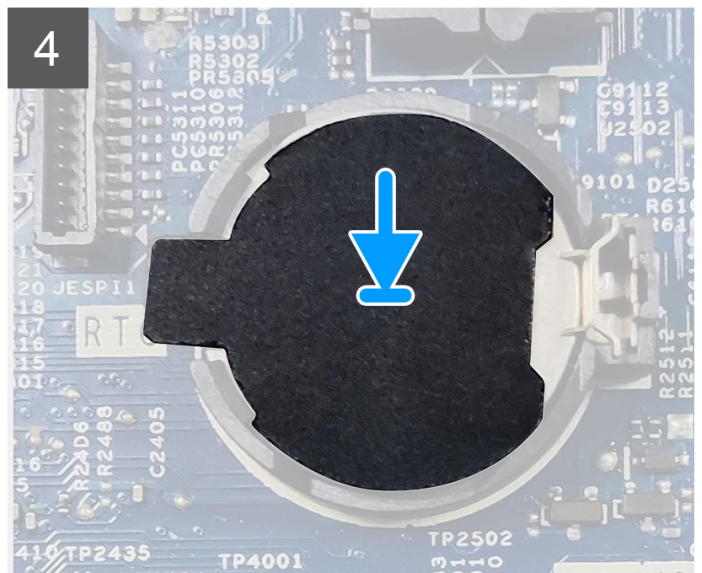
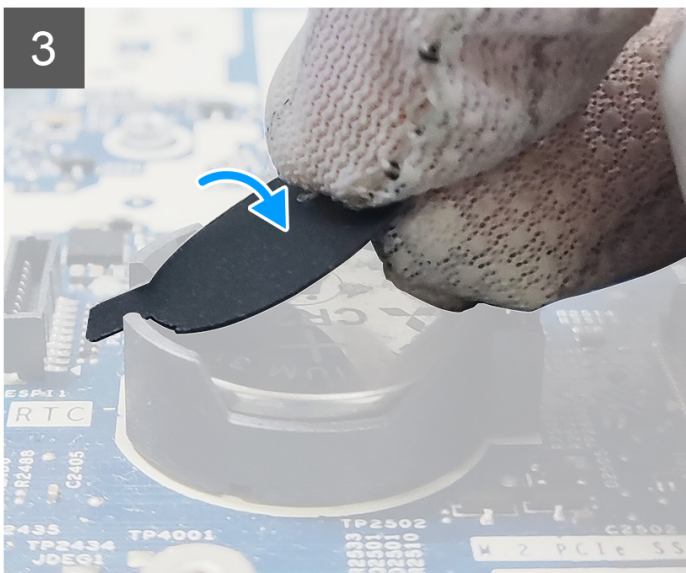
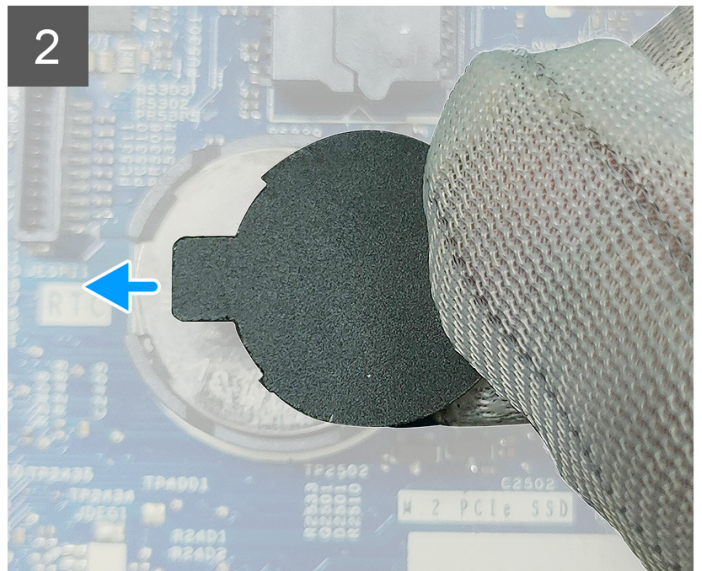
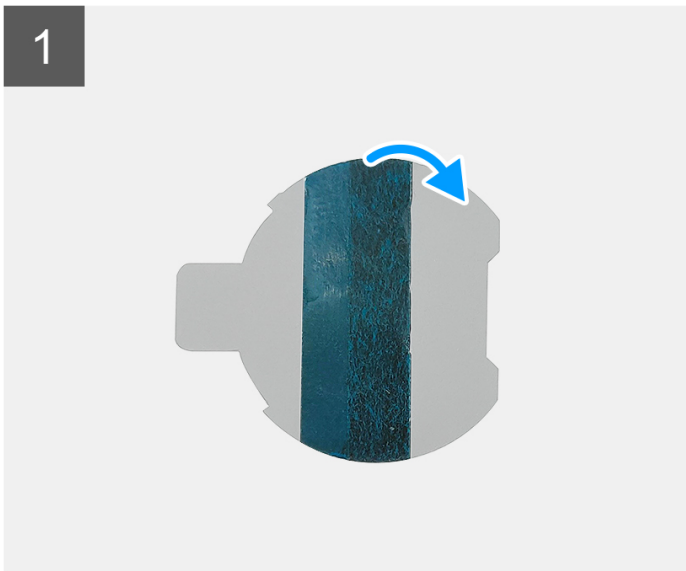

- a. Peel off the adhesive tape at the back of the mylar sheet.
- b. Align and affix the mylar sheet on the RTC socket.

Next steps

1. Install the [side cover](#).
2. Follow the procedure in [after working inside your computer](#).

Removing and installing components

NOTE: The images in this document may differ from your computer depending on the configuration you ordered.

Recommended tools

The procedures in this document may require the following tools:

- Phillips screwdriver #0
- Phillips screwdriver #1
- Plastic scribe

Screw list

NOTE: When removing screws from a component, it is recommended to note the screw type, and the quantity of screws, and then place them in a screw storage box. This is to ensure that the correct number of screws and correct screw type is restored when the component is replaced.

NOTE: Some computers have magnetic surfaces. Ensure that the screws are not left attached to such surfaces when replacing a component.

NOTE: Screw color may vary with the configuration ordered.

Table 1. Screw list







Component	Screw type	Quantity	Image
Side cover	Thumb screw (#6-32)	1	
M.2 2230 solid-state drive heat sink	Captive screw	2	NA
M.2 2230 solid-state drive	M2x3.5	1	
WLAN card	M2x3.5	1	
Small Form Factor Pluggable (SFP) port	M3x3	2	 
	M2x3	1	
Heat sink	Captive screw	4	NA
System board	M3x4 M3x5	2 (1 for M.2 WiFi standoff and 1 for M.2 SSD standoff)	

Table 1. Screw list (continued)

Component	Screw type	Quantity	Image
		6 (5 for system board and 1 for speaker holder)	

Major components of OptiPlex 3000 Thin Client

The following image shows the major components of OptiPlex 3000 Thin Client.

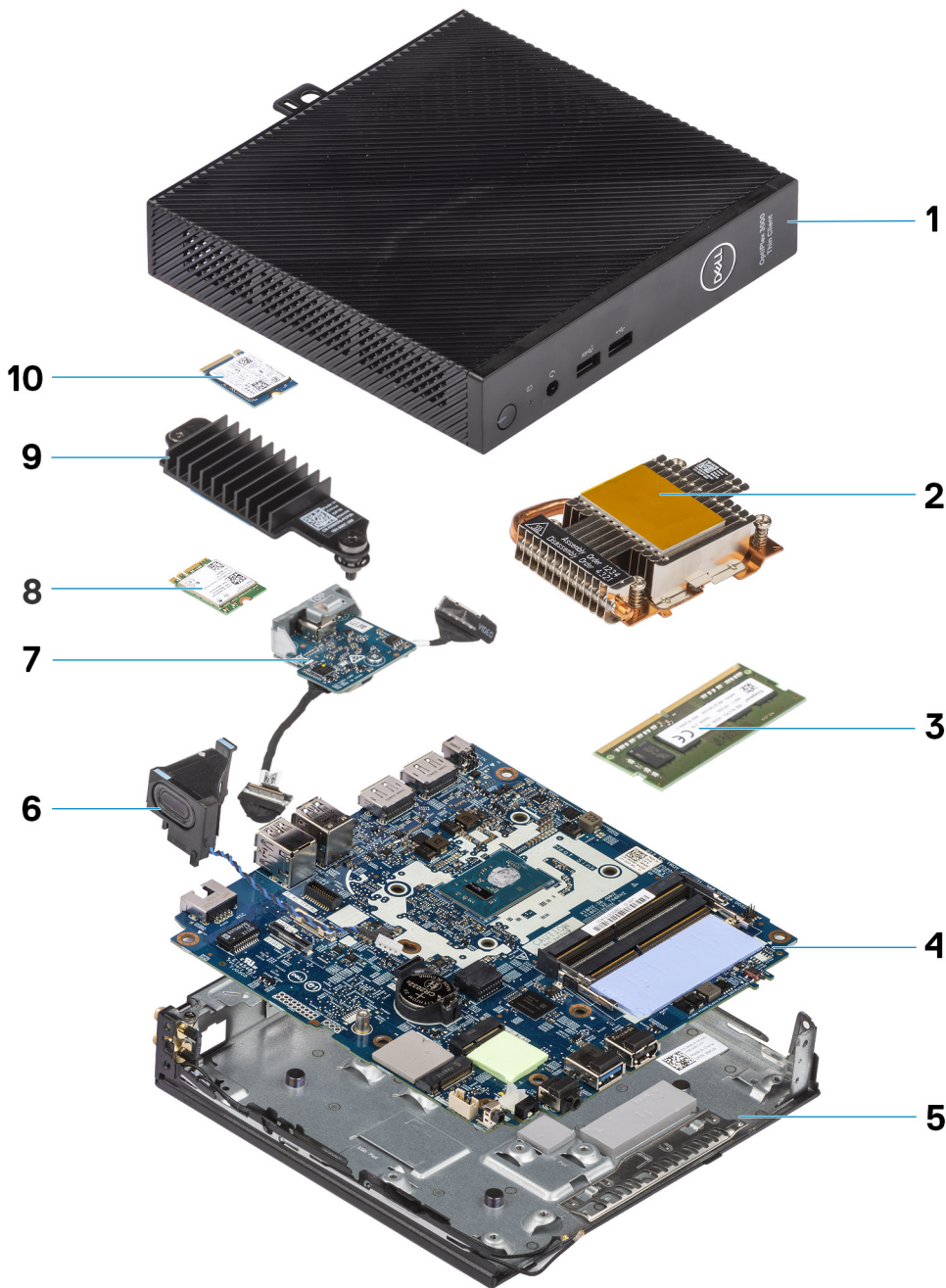

1. Side cover
2. Heat sink
3. Memory module
4. System board
5. Chassis
6. Speaker
7. Optional module
8. WLAN card
9. Solid-state drive heat sink
10. M.2 2230 solid-state drive

NOTE: For systems configured with Small Form Factor Pluggable (SFP) port, wireless card and external antenna cannot be installed.

NOTE: Dell provides a list of components and their part numbers for the original system configuration purchased. These parts are available according to warranty coverages purchased by the customer. Contact your Dell sales representative for purchase options.

Side cover

Removing the side cover

Prerequisites

1. Follow the procedure in [before working inside your computer](#).

About this task

The following images indicate the location of the side cover and provide a visual representation of the removal procedure.



1x
6-32



2

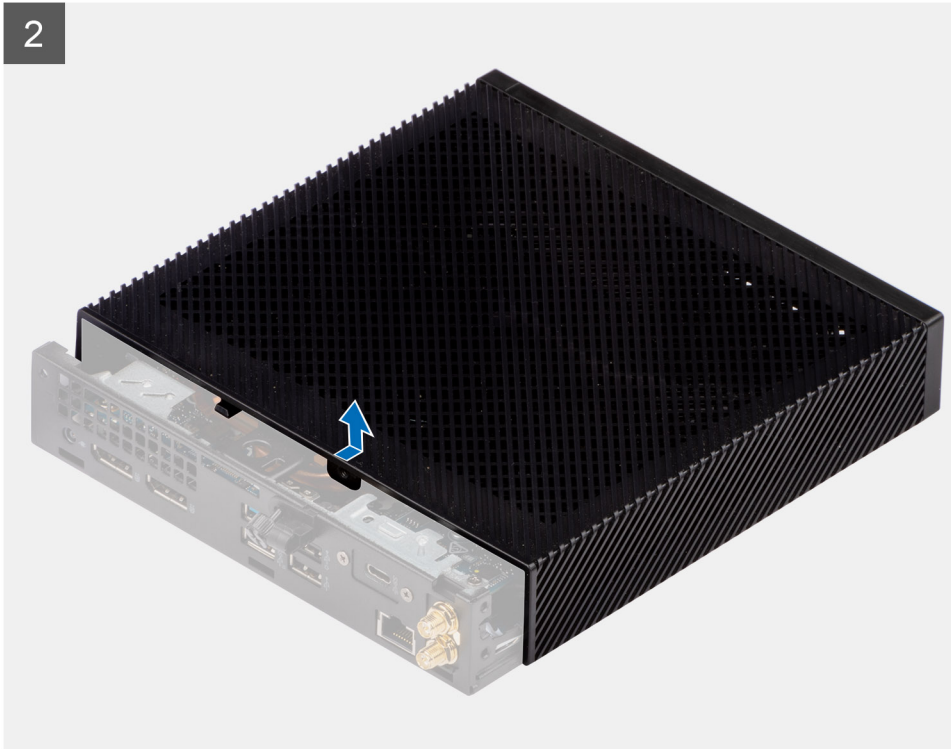

Steps

1. Loosen the thumbscrew (6-32) that secures the side cover to the chassis.
2. Slide the side cover towards the front of the computer to disengage the tabs on the side cover from the slots on the chassis.
3. Lift the side cover away from the chassis.

Installing the side cover

Prerequisites

If you are replacing a component, remove the existing component before performing the installation procedure.

About this task

The following images indicate the location of the side cover and provide a visual representation of the installation procedure.

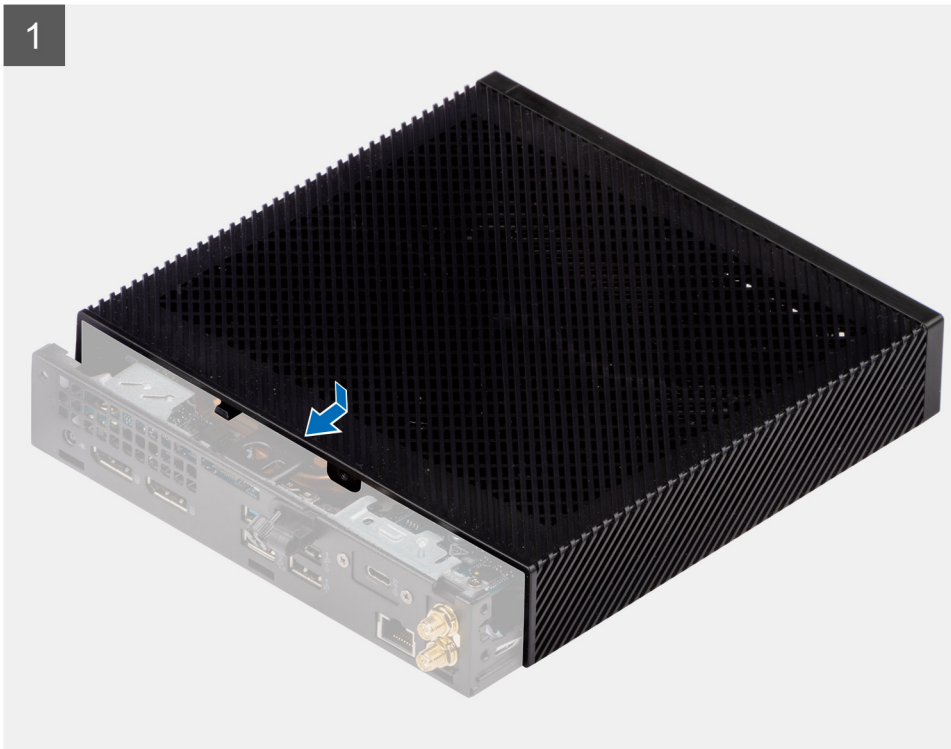

1x
6-32



Steps

1. Align the tabs on the side cover with the slots on the chassis.

2. Slide the side cover towards the back of the computer to engage the tabs on the side cover with the slots on the chassis.
3. Tighten the thumbscrew (6-32) to secure the side cover to the chassis.

Next steps

1. Follow the procedure in [after working inside your computer](#).

Speaker

Removing the speaker

Prerequisites

1. Follow the procedure in [before working inside your computer](#).
2. Remove the [side cover](#).

About this task

The following image indicates the location of the speaker and provides a visual representation of the removal procedure.

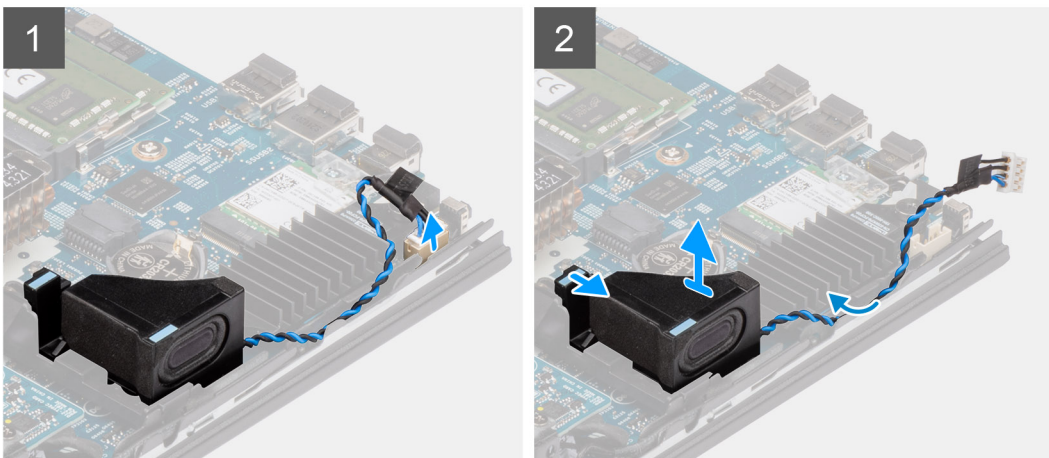
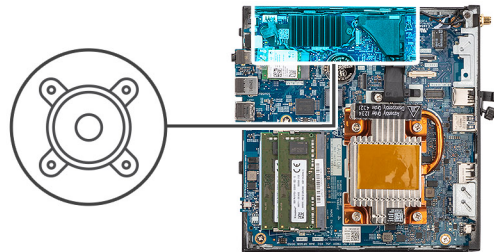

Steps

1. Disconnect the speaker cable from the connector on the system board.
2. Unroute the speaker cable from the routing guides on the chassis.
3. Press the release tab to release the speaker from the slot on the chassis.
4. Lift and remove the speaker from the chassis.

Installing the speaker

Prerequisites

If you are replacing a component, remove the existing component before performing the installation procedure.

About this task

The following image indicates the location of the speaker and provides a visual representation of the installation procedure.

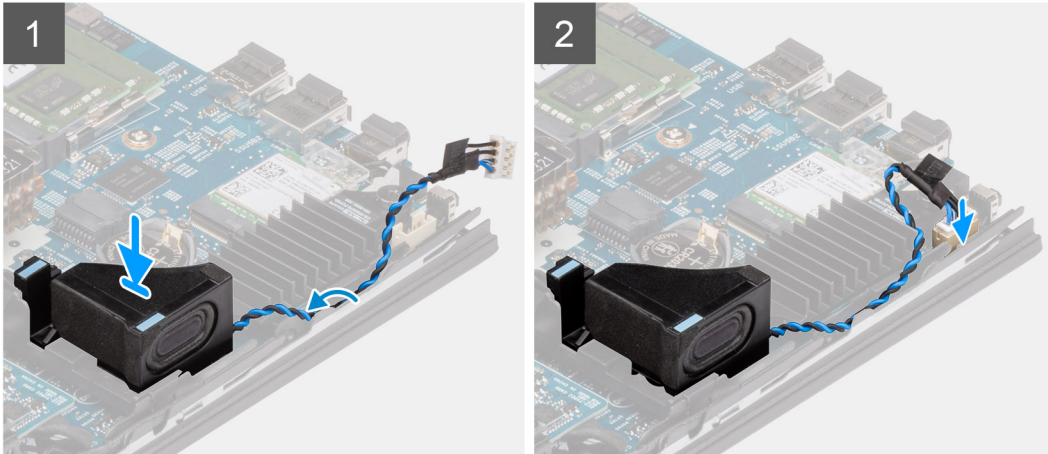
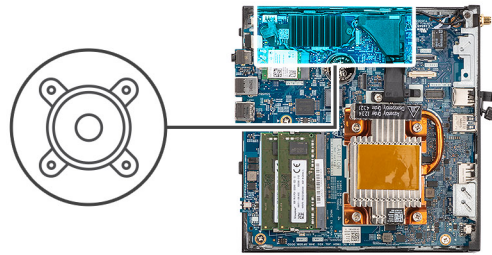

Steps

1. Align and insert the speaker into the slot on the chassis.
2. Press the speaker into the slot on the chassis until the release tab clicks.
3. Route the speaker cable through the routing guides on the chassis.
4. Connect the speaker cable to the connector on the system board.

Next steps

1. Install the [side cover](#).
2. Follow the procedure in [after working inside your computer](#).

Solid-state drive

Removing the M.2 2230 solid-state drive

Prerequisites

1. Follow the procedure in [before working inside your computer](#).
2. Remove the [side cover](#).

About this task

The following image indicates the location of the solid-state drive and provides a visual representation of the removal procedure.

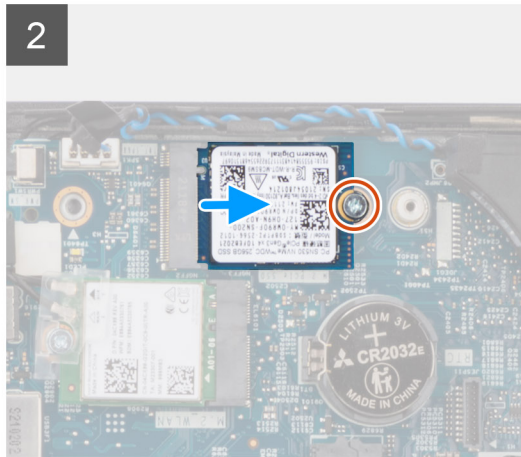
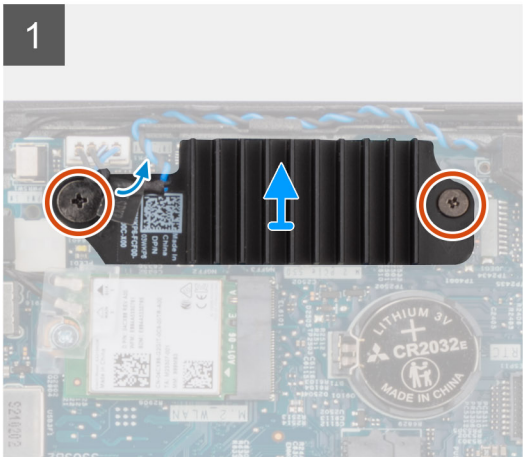
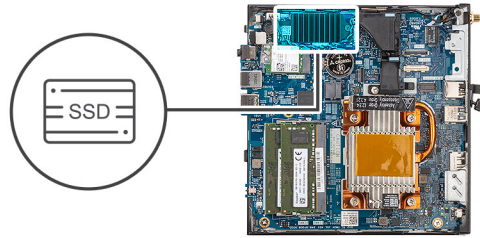
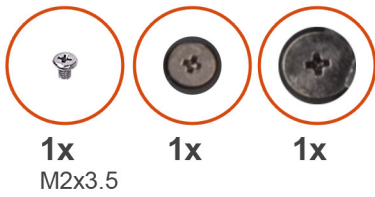

Steps

1. Loosen the two captive screws that secure the solid-state drive heat sink to the system board.
2. Lift and remove the solid-state drive heat sink from the system board.
3. Remove the screw (M2x3.5) that secures the M.2 2230 solid-state drive to the system board.
4. Slide and lift the M.2 2230 solid-state drive from the M.2 card slot.

Installing the M.2 2230 solid-state drive

Prerequisites

If you are replacing a component, remove the existing component before performing the installation procedure.

About this task

The following image indicates the location of the solid-state drive and provides a visual representation of the installation procedure.

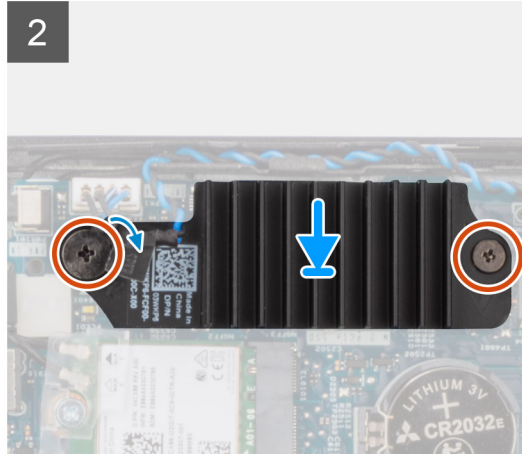
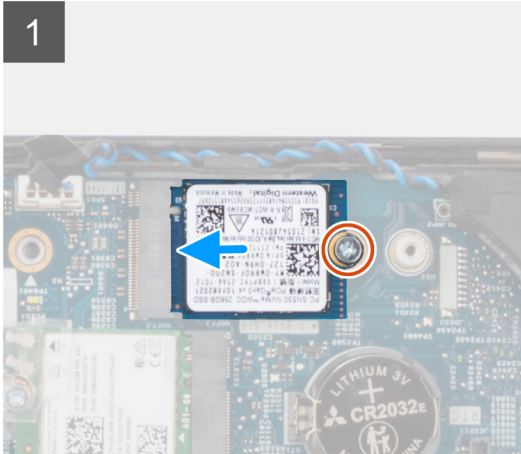
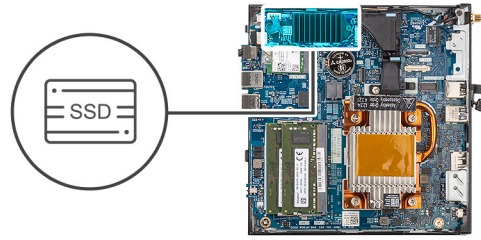
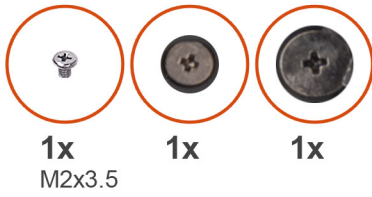

Steps

1. Align the notch on the M.2 2230 solid-state drive with the tab on the M.2 card slot.
2. Slide the M.2 2230 solid-state drive at an angle into the M.2 card slot.
3. Replace the screw (M2x3.5) to secure the M.2 2230 solid-state drive to the system board.
4. Place the solid-state drive heat sink on the M.2 2230 solid-state drive.
5. Align the screws on the solid-state drive heat sink to the screw holes on the system board.
6. Tighten the two captive screws to secure the solid-state drive heat sink to the system board.

Next steps

1. Install the [side cover](#).
2. Follow the procedure in [after working inside your computer](#).

Memory modules

Removing the memory modules

Prerequisites

1. Follow the procedure in [before working inside your computer](#).
2. Remove the [side cover](#).

About this task

The following image indicates the location of the memory modules and provides a visual representation of the removal procedure.

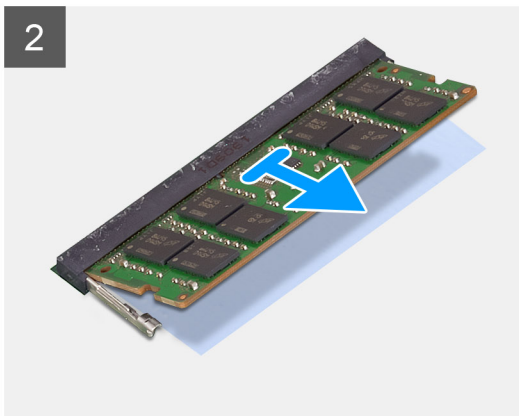
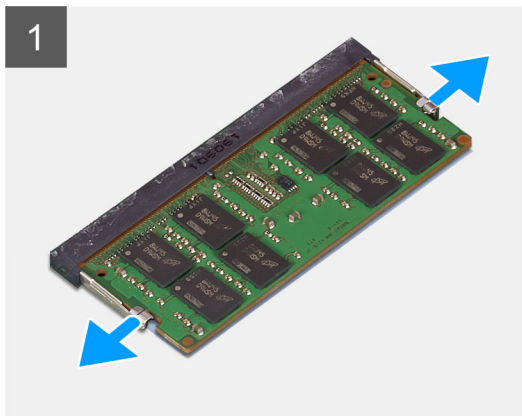
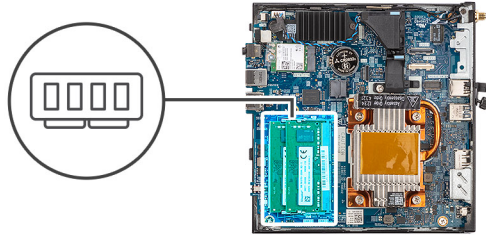

Steps

1. Pull the securing clips on each end of the memory-module slot until the memory module pops up.
2. Slide and remove the memory module from the memory-module slot.

CAUTION: To prevent damage to the memory module, hold the memory module by the edges. Do not touch the components on the memory module.

NOTE: Repeat step 1 to step 2 to remove any other memory modules installed in your computer.

NOTE: Note the slot and the orientation of the memory module in order to replace it in the correct slot.

Installing the memory modules

Prerequisites

If you are replacing a component, remove the existing component before performing the installation procedure.

About this task

The following image indicates the location of the memory modules and provides a visual representation of the installation procedure.

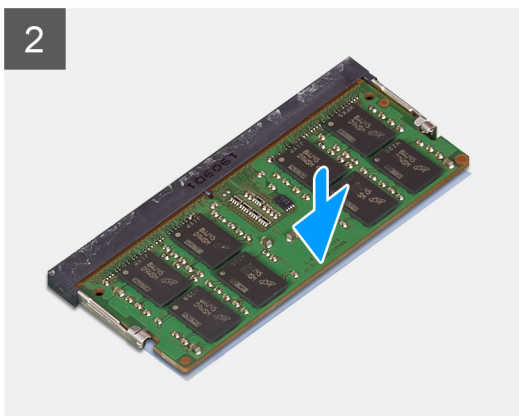
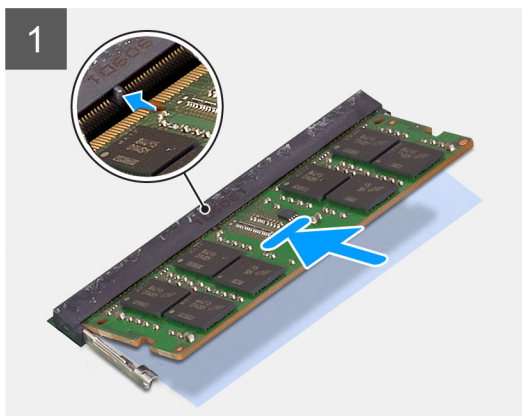
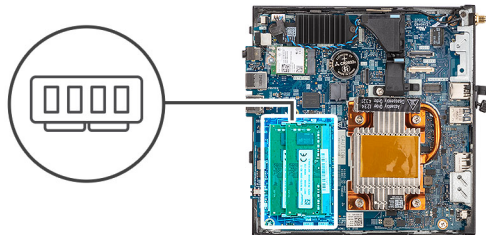

Steps

1. Verify if the SODIMM thermal pad is bent or out of shape. If yes, then press the thermal pad to secure it properly to the system board.

OptiPlex 3000 Thin Client has SODIMM thermal pad 100% attached on system board. SODIMM thermal pad is not reusable. There is no residual upon removal of the SODIMM thermal pad from the system board.

i **NOTE:** The thermal pad can create the push up force, when assembling the SODIMM module have to pressed down and latched.

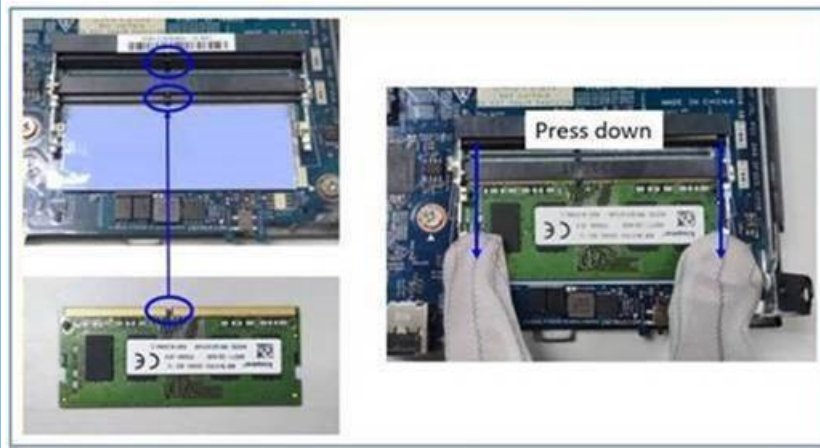

2. Partially remove the anti-adhesive paper from the SODIMM thermal pad.

i **NOTE:** Do not touch the adhesive surface of the SODIMM thermal pad.

3. Using a scraper, press the SODIMM thermal pad from left to right edge on the memory module slot.

i **NOTE:** Refer the thermal pad area in the image as reference for assembly positioning.

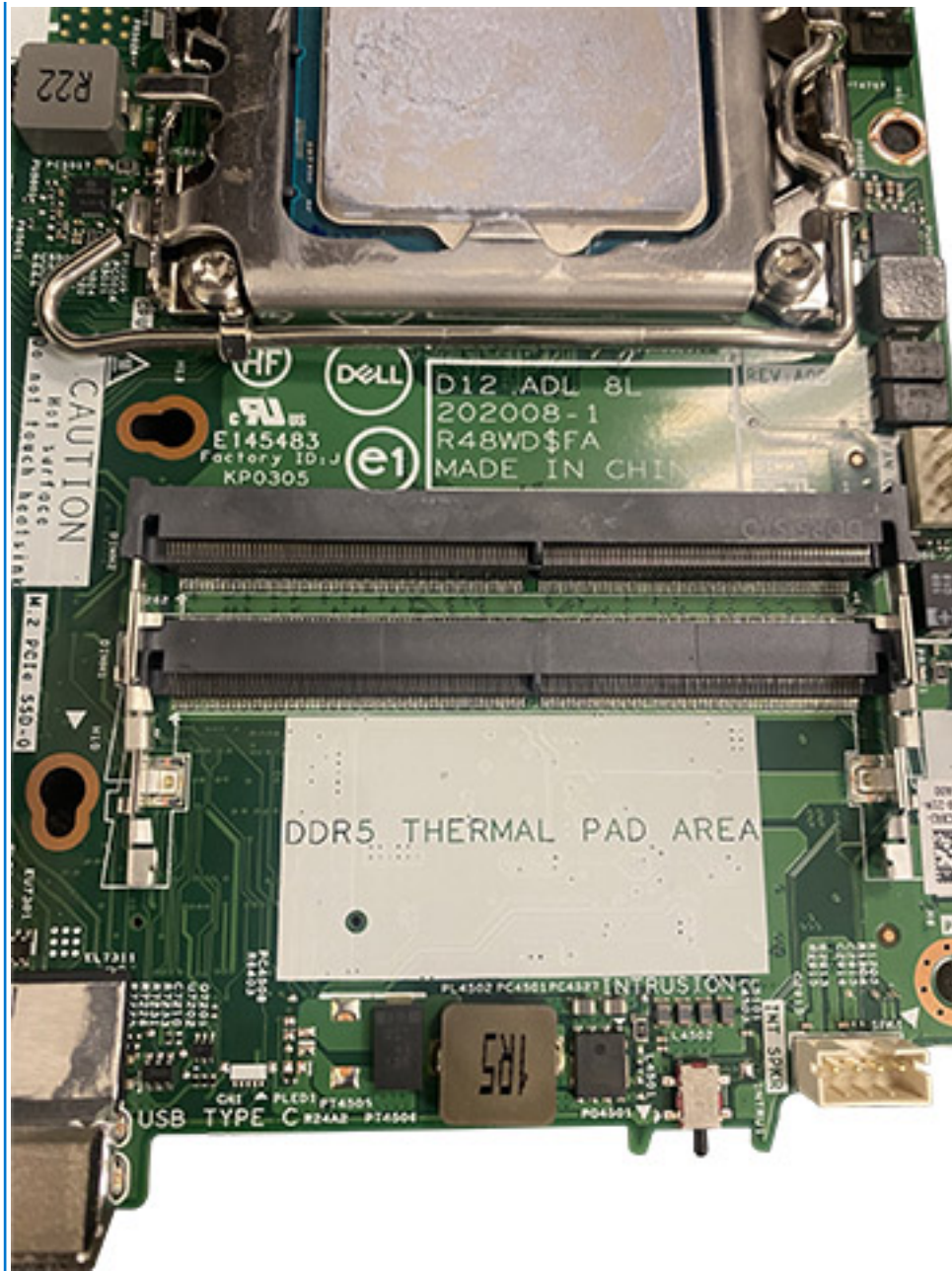

NOTE: Ensure that the SODIMM thermal pad is attached properly and the thermal pad is not bent or out of shape.

4. Push and remove the adhesive layer on the SODIMM thermal pad.



NOTE: Check if there is any SODIMM pad residual on the thermal pad and clean the residual up.

5. Align the notch on the memory module with the tab on the memory-module slot.
6. Press the memory module down until the memory module snaps into place and the securing clips lock in place.

NOTE: The securing clips return to the locked position. If you do not hear the click, remove the memory module and reinstall it.

NOTE: Repeat step 5 to 6 when installing more than one memory module in your computer.

CAUTION: To prevent damage to the memory module, hold the memory module by the edges. Do not touch the components on the memory module.

Next steps

1. Install the [side cover](#).
2. Follow the procedure in [after working inside your computer](#).

WLAN card

Removing the WLAN card

Prerequisites

1. Follow the procedure in [before working inside your computer](#).
2. Remove the [side cover](#).

About this task

The following image indicates the location of the WLAN card and provides a visual representation of the removal procedure.



1x
M2x3.5

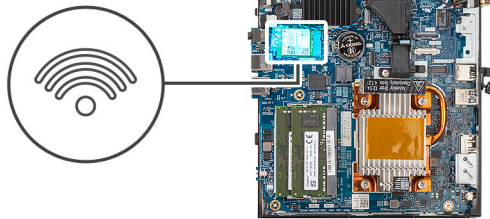

Steps

1. Remove the screw (M2x3.5) that secures the WLAN card on the system board.
2. Slide and lift the WLAN-card bracket off the WLAN card.
3. Disconnect the WLAN antenna cables from the connectors on the WLAN card.
4. Slide and remove the WLAN card from the WLAN-card slot.

Installing the WLAN card

Prerequisites

If you are replacing a component, remove the existing component before performing the installation procedure.

About this task

The following image indicates the location of the WLAN card and provides a visual representation of the installation procedure.



1x
M2x3.5

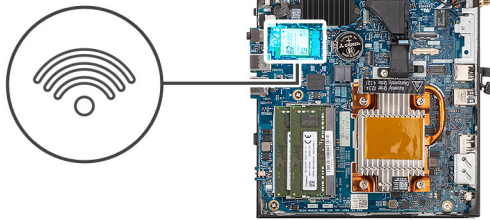

Steps

1. Connect the WLAN antenna cables to the connectors on the WLAN card.
The following table provides the antenna-cable color scheme for the WLAN card of your computer.

Table 2. Antenna-cable color scheme

Connectors on the wireless card	Antenna-cable color
Main (white triangle)	White
Auxiliary (black triangle)	Black

2. Align and place the WLAN-card bracket on the WLAN card to secure the antenna cables.
3. Align the notch on the WLAN card with the tab on the WLAN-card slot.
4. Slide the WLAN card at an angle into the WLAN-card slot.
5. Replace the screw (M2x3.5) to secure the WLAN card on the system board.

Next steps

1. Install the [side cover](#).
2. Follow the procedure in [after working inside your computer](#).

Small Form Factor Pluggable (SFP) port

Removing the Small Form Factor Pluggable (SFP) port

Prerequisites

1. Follow the procedure in [before working inside your computer](#).
2. Remove the [side cover](#).

About this task

The following image indicates the location of the Small Form Factor Pluggable (SFP) port and provides a visual representation of the removal procedure.



2x
M3x3



1x
M2x3

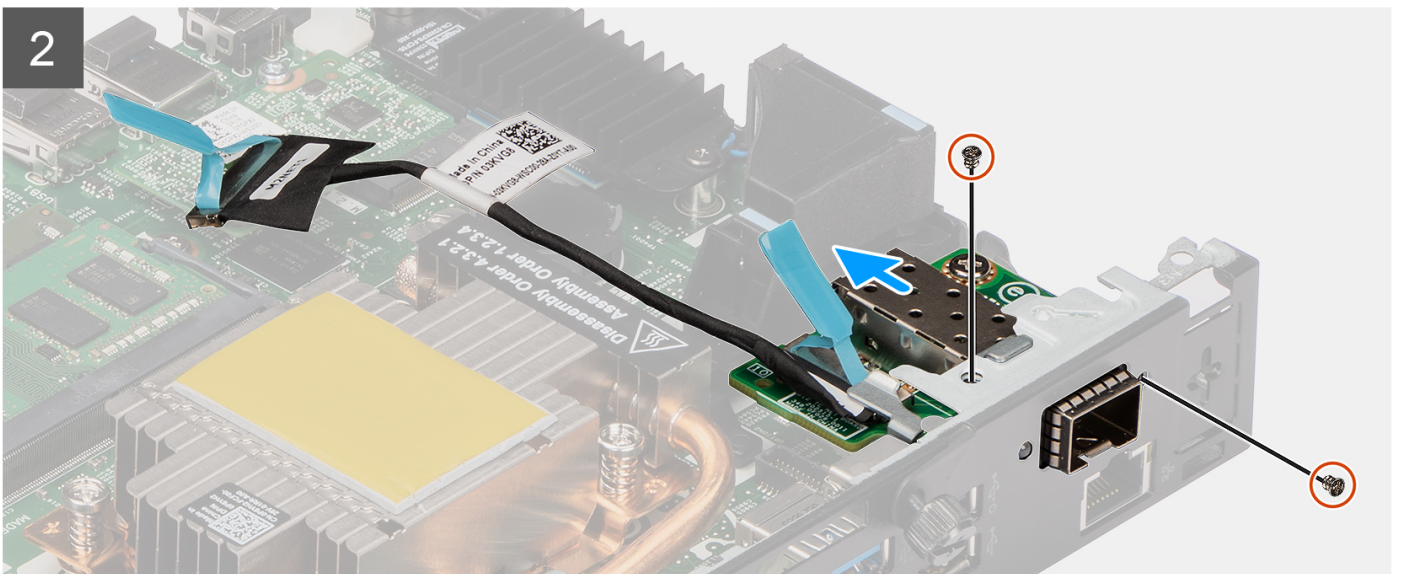
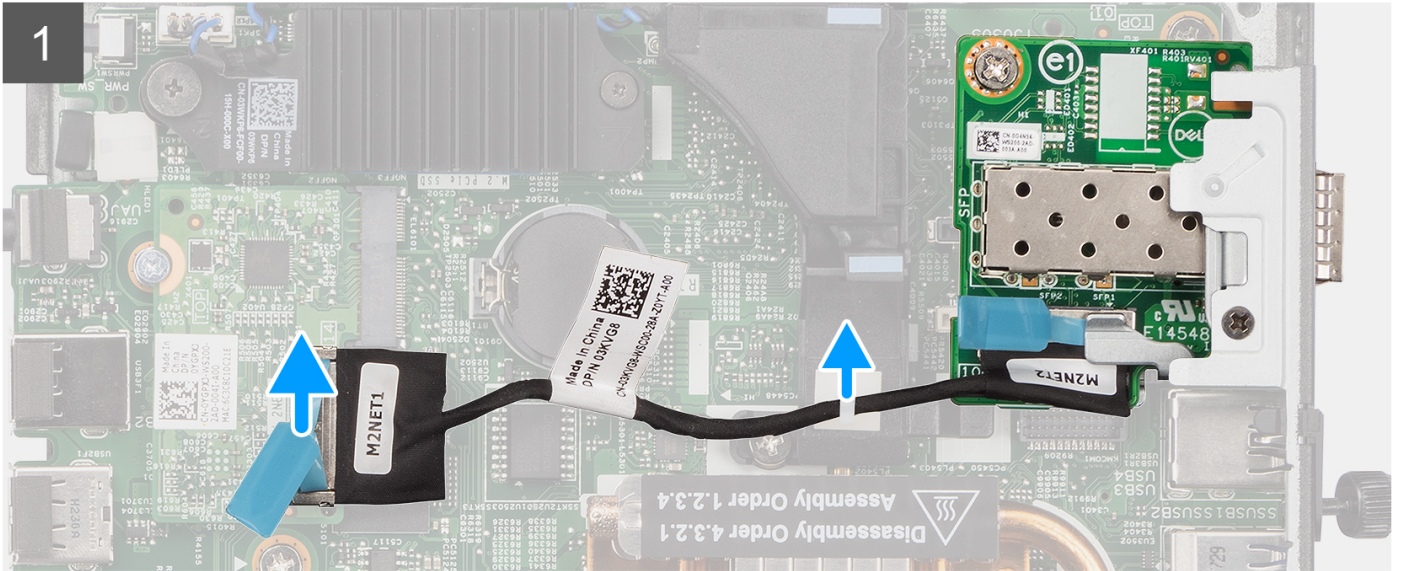
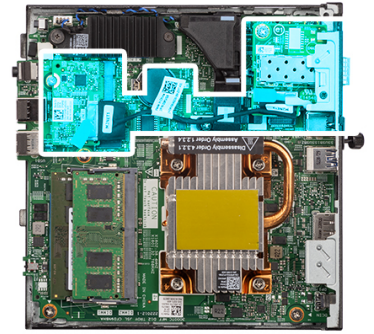

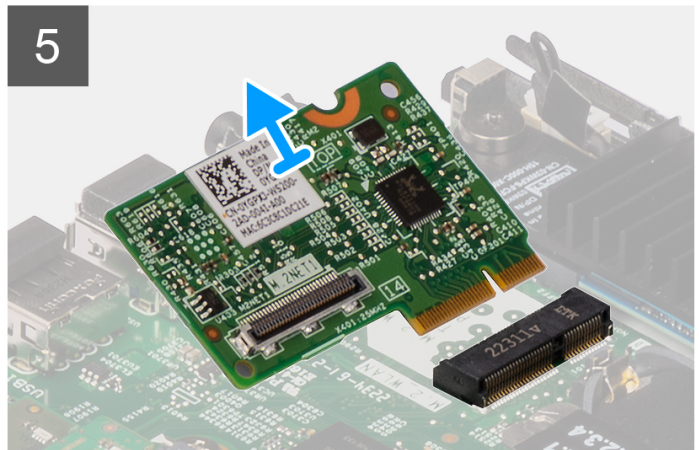
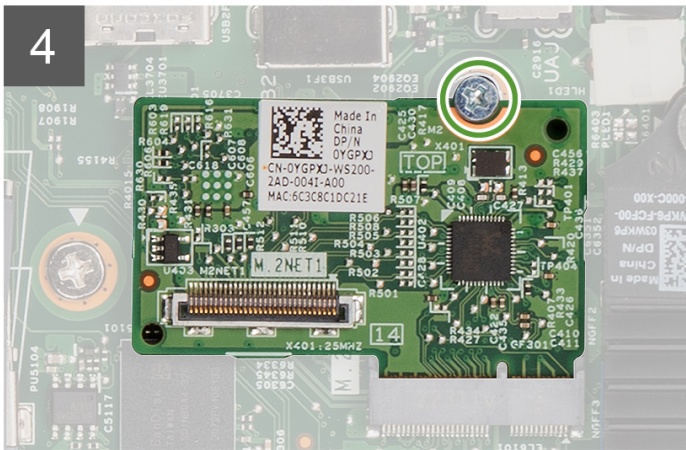
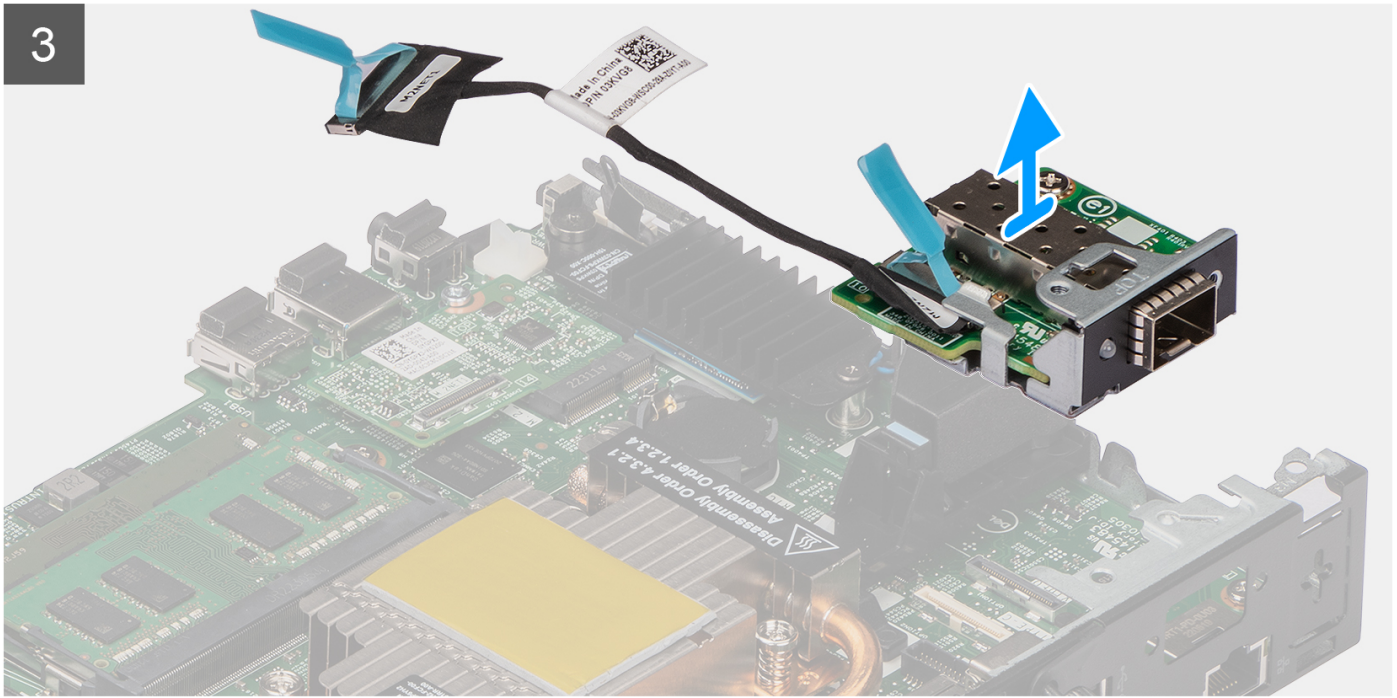

Steps

1. Disconnect the SFP cable from the connector on the system board.
2. Unroute the SFP cable from the clip on the system board.
3. Remove the two screws (M3x3) that secure the SFP Net board module to the chassis.
4. Slide and remove the SFP Net board module and the cables off the chassis.
5. Remove the screw (M2x3) that secures the M.2 board module to the chassis.
6. Slide and remove the M.2 board module off the chassis.

Installing the Small Form Factor Pluggable (SFP) port

Prerequisites

If you are replacing a component, remove the existing component before performing the installation procedure.

About this task

The following image indicates the location of the Small Form Factor Pluggable (SFP) port and provides a visual representation of the installation procedure.



2x
M3x3



1x
M2x3

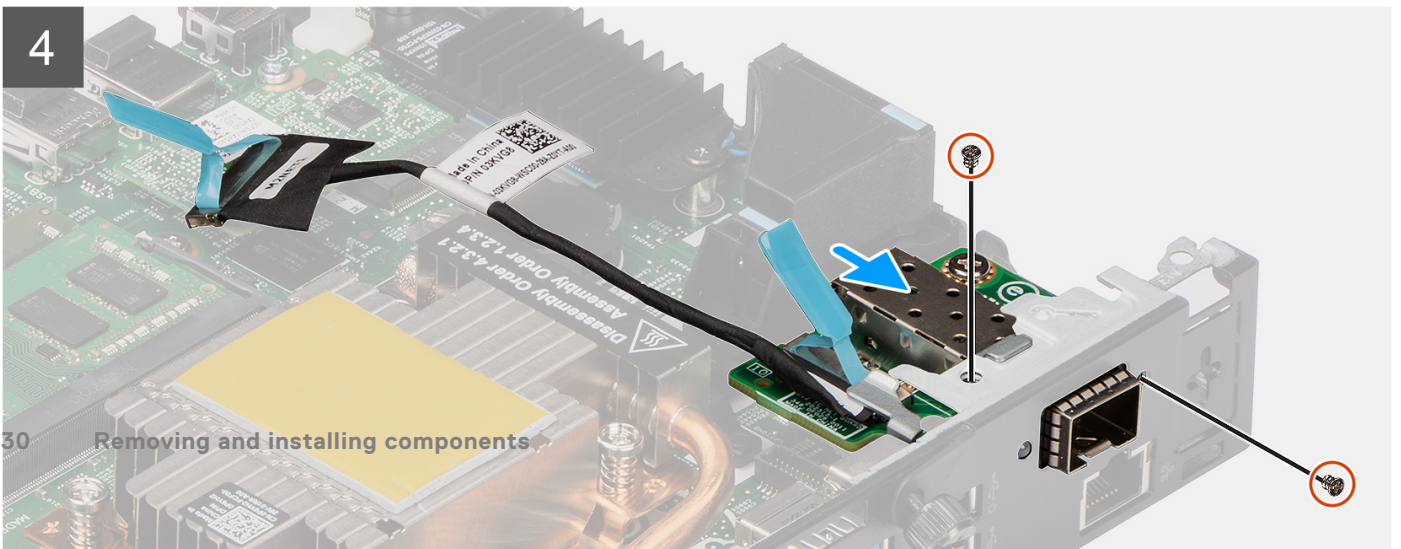
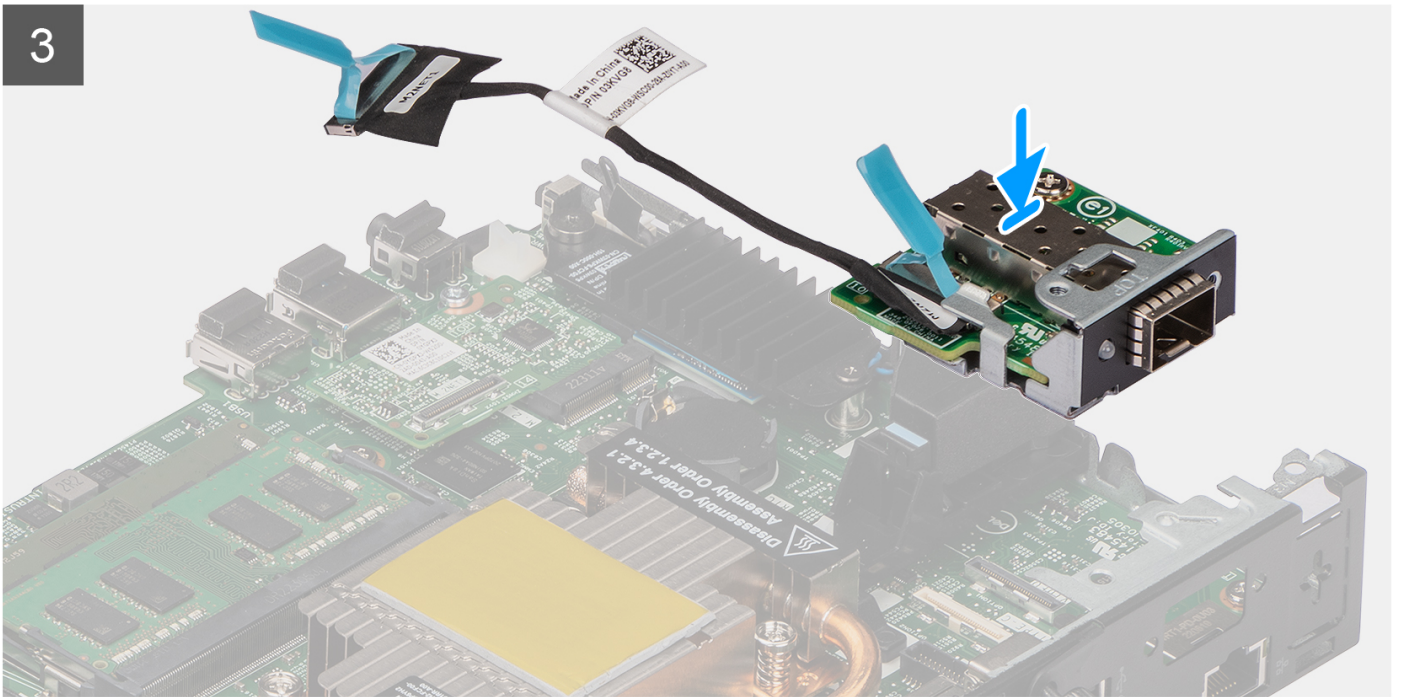
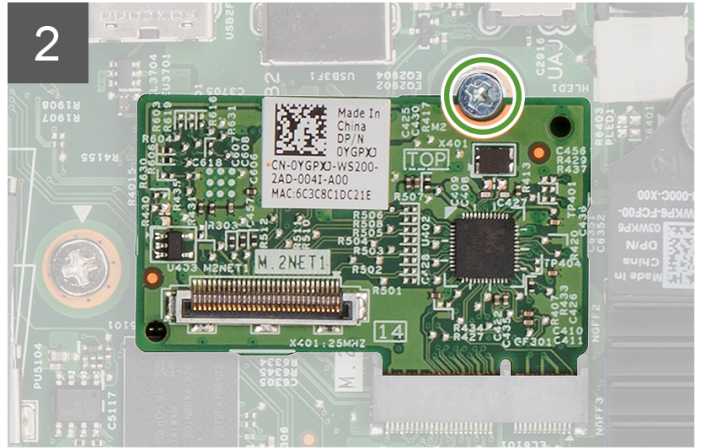
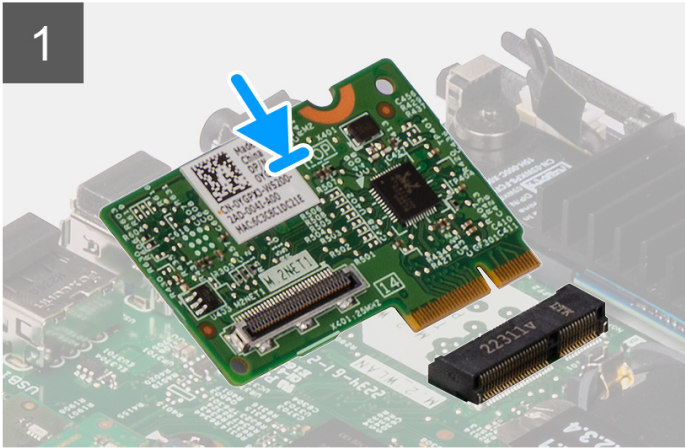
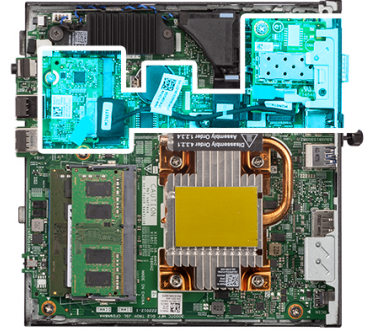

Steps

1. Slide and insert the M.2 board module into the M.2 board module slot on the chassis.
2. Replace the screw (M2x3) to secure the M.2 board module to the chassis.
3. Insert the SFP Net board module through the opening at the back of the system.
4. Connect the SFP cable to the connector on the system board.
5. Route the SFP cable through the clip on the system board.
6. Replace the two screws (M3x3) to secure the SFP Net board module to the chassis.

Next steps

1. Install the [side cover](#).
2. Follow the procedure in [after working inside your computer](#).

Optional modules

Removing the optional Type-C module

Prerequisites

1. Follow the procedure in [before working inside your computer](#).
2. Remove the [side cover](#).

About this task

The following image indicates the location of the optional Type-C module and provides a visual representation of the removal procedure.

To identify the ports and connectors, see the [system board connectors](#).



2x
M3x3

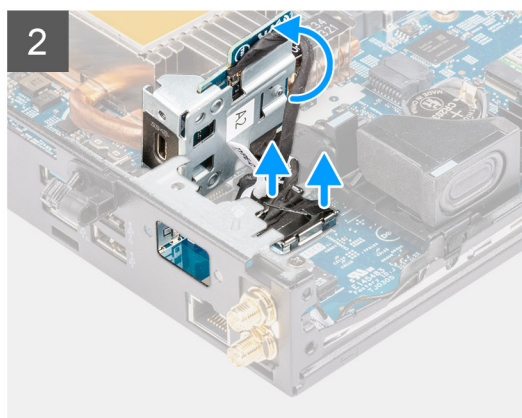
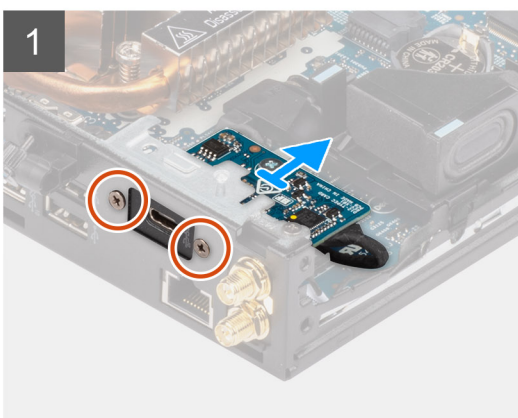

Steps

1. Remove the two screws (M3x3) that secure the Type-C module to the chassis.
2. Slide and rotate the Type-C module.
3. Disconnect the Type-C cable and the DisplayPort cable from the connectors on the system board.
4. Lift the Type-C module and the cables off the chassis.

Installing the optional Type-C module

Prerequisites

If you are replacing a component, remove the existing component before performing the installation procedure.

About this task

The following image indicates the location of the optional Type-C module and provides a visual representation of the installation procedure.

To identify the ports and connectors, see the [system board connectors](#).



2x
M3x3

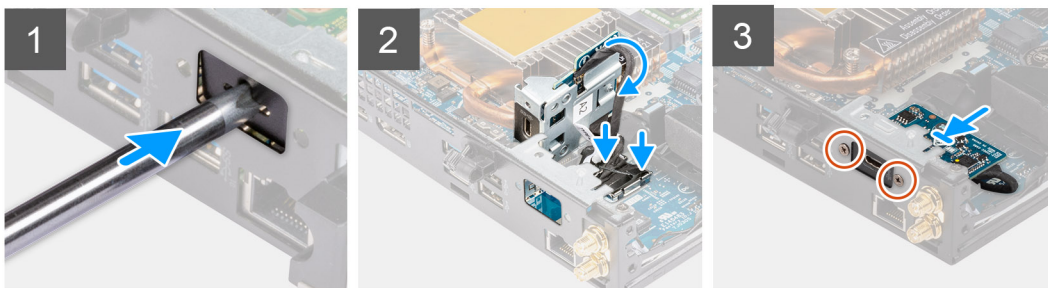

Steps

1. Insert and push the flat-head screwdriver into the slot on the optional module filler to release the optional module filler from the chassis.

NOTE: Step one is only applicable for new installation or component upgrade. For replacing an existing component, follow the procedure from step two.

2. Connect the Type-C cable and the DisplayPort cable to the connectors on the system board.
3. Align and place the Type-C module into the optional I/O module slot on the chassis.
4. Rotate and slide the Type-C module.
5. Replace the two screws (M3x3) to secure the Type-C module to the chassis.

Next steps

1. Install the [side cover](#).
2. Follow the procedure in [after working inside your computer](#).

Removing the optional HDMI module

Prerequisites

1. Follow the procedure in [before working inside your computer](#).
2. Remove the [side cover](#).

About this task

The following image indicates the location of the optional HDMI module and provides a visual representation of the removal procedure.

NOTE: Optional VGA and DisplayPort modules have similar procedure as optional HDMI module.

To identify the ports and connectors, see the [system board connectors](#).



2x
M3x3

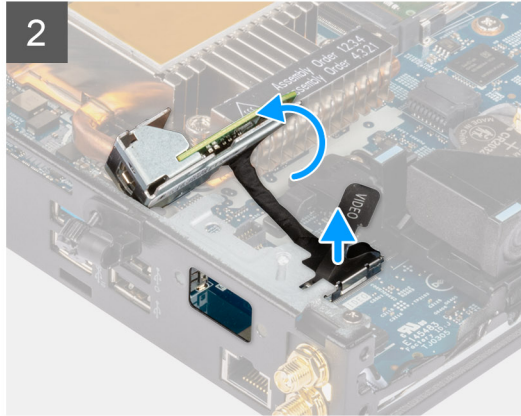
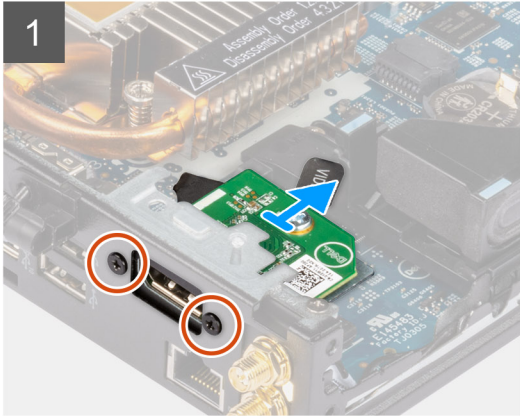

Steps

1. Remove the two screws (M3X3) that secure the optional HDMI module to the chassis.
2. Disconnect the HDMI module cable from the connector on the system board.
3. Lift the HDMI module and the cable off the chassis.

Installing the optional HDMI module

Prerequisites

If you are replacing a component, remove the existing component before performing the installation procedure.

About this task

The following image indicates the location of the optional HDMI module and provides a visual representation of the installation procedure.

NOTE: Optional VGA and DisplayPort modules have similar procedure as optional HDMI module.

To identify the ports and connectors, see the [system board connectors](#).



2x
M3x3

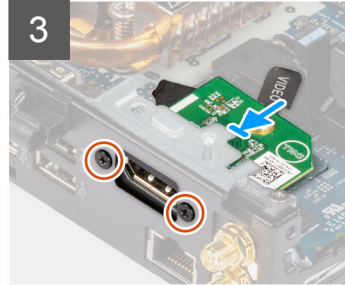
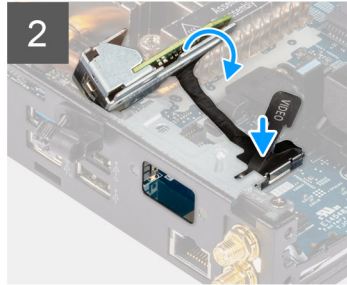
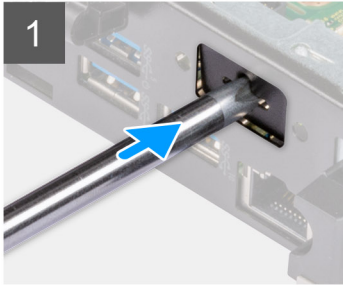

Steps

1. Insert and push the flat-head screwdriver into the slot on the optional module filler to release the optional module filler from the chassis.
NOTE: Step one is only applicable for new installation or component upgrade. For replacing an existing component, follow the procedure from step two.
2. Connect the HDMI module cable to the connector on the system board.
3. Insert the HDMI module into the optional module slot on the chassis.
4. Replace the two screws (M3X3) to secure the HDMI module to the chassis.

Next steps

1. Follow the procedure in [after working inside your computer](#).
2. Install the [side cover](#).

Removing the optional Serial module

Prerequisites

1. Follow the procedure in [before working inside your computer](#).
2. Remove the [side cover](#).

About this task

The following image indicates the location of the optional Serial module and provides a visual representation of the removal procedure.

To identify the ports and connectors, see the [system board connectors](#).



2x

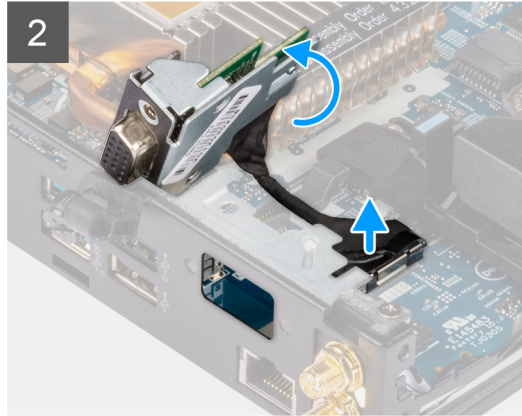
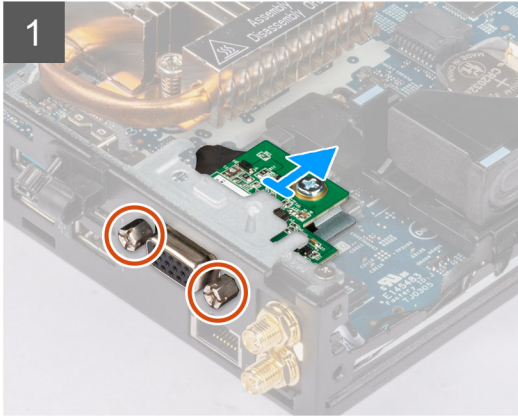

Steps

1. Remove the two screws that secure the Serial module to the chassis.
2. Disconnect the Serial module cable from the connector on the system board.
3. Lift the Serial module and the cable off the chassis.

Installing the optional Serial module

Prerequisites

If you are replacing a component, remove the existing component before performing the installation procedure.

About this task

The following image indicates the location of the optional Serial module and provides a visual representation of the installation procedure.

To identify the ports and connectors, see the [system board connectors](#).



2x

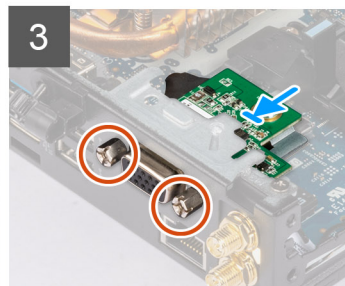
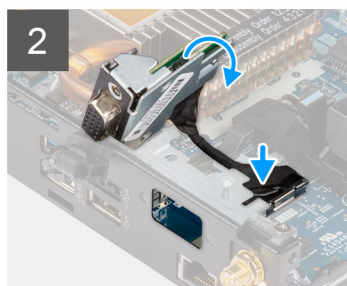
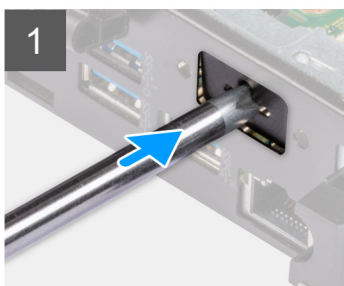

Steps

1. Insert and push the flat-head screwdriver into the slot on the optional module filler to release the optional module filler from the chassis.

i **NOTE:** Step one is only applicable for new installation or component upgrade. For replacing an existing component, follow the procedure from step two.

2. Insert the Serial module into the optional I/O module slot on the chassis.
3. Connect the Serial module cable to the connector on the system board.
4. Replace the two screws to secure the Serial module to the chassis.

Next steps

1. Install the [side cover](#).
2. Follow the procedure in [after working inside your computer](#).

Removing the optional PS/2 keyboard/mouse module

Prerequisites

1. Follow the procedure in [before working inside your computer](#).
2. Remove the [side cover](#).

About this task

The following image indicates the location of the optional PS/2 keyboard/mouse module and provides a visual representation of the removal procedure.

To identify the ports and connectors, see the [system board connectors](#).



2x
M3x3

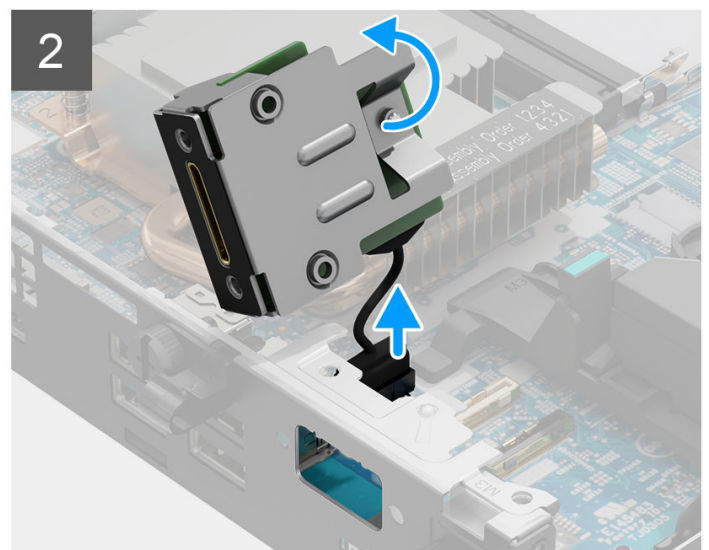
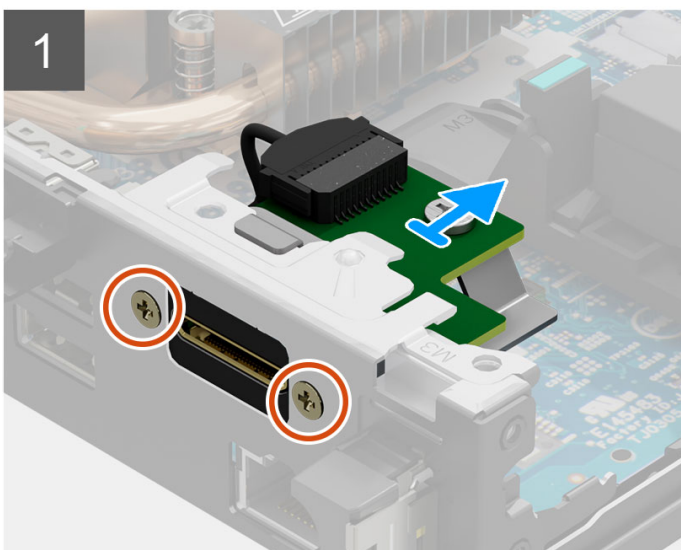
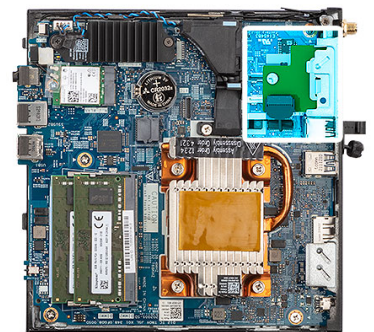

Steps

1. Remove the two screws (M3X3) that secure the PS/2 keyboard/mouse module to the chassis.
2. Slide and lift the PS/2 keyboard/mouse module off the chassis.
3. Disconnect the three PS/2 keyboard/mouse module cables from the connectors on the system board.
4. Remove the PS/2 keyboard/mouse module with the cables off the chassis.

Installing the optional PS/2 keyboard/mouse module

Prerequisites

If you are replacing a component, remove the existing component before performing the installation procedure.

About this task

The following image indicates the location of the optional PS/2 keyboard/mouse module and provides a visual representation of the installation procedure.

To identify the ports and connectors, see the [system board connectors](#).



2x
M3x3

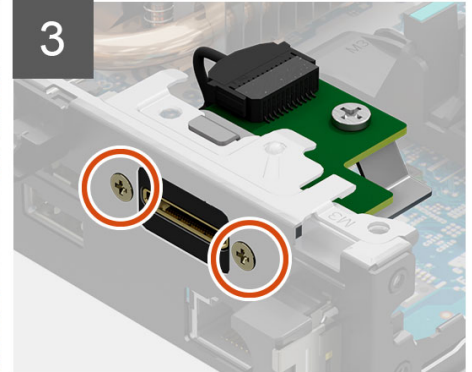
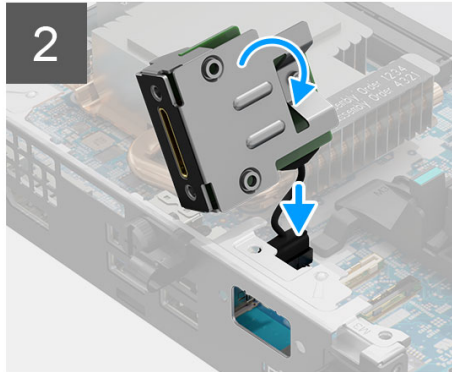
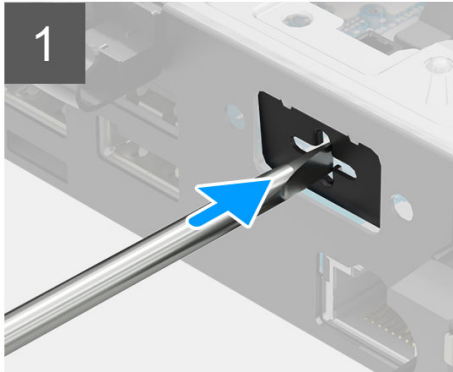
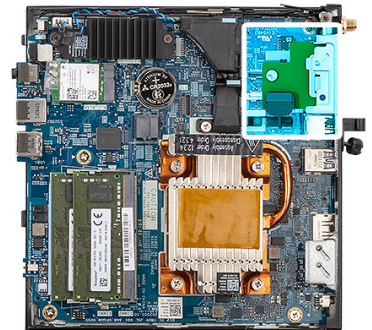

Steps

1. Insert and push the flat-head screwdriver into the slot on the optional module filler to release the optional module filler from the chassis.
NOTE: Step one is only applicable for new installation or component upgrade. For replacing an existing component, follow the procedure from step two.
2. Insert the PS/2 keyboard/mouse module into the optional I/O module slot on the chassis.
3. Connect the three PS/2 keyboard/mouse module cables to the connectors on the system board.
4. Replace the two screws (M3X3) to secure the PS/2 keyboard/mouse module to the chassis.

Next steps

1. Install the [side cover](#).
2. Follow the procedure in [after working inside your computer](#).

Heat sink

Removing the heat sink

Prerequisites

1. Follow the procedure in [before working inside your computer](#).
2. Remove the [side cover](#).

About this task

The following image indicates the location of the heat sink and provides a visual representation of the removal procedure.

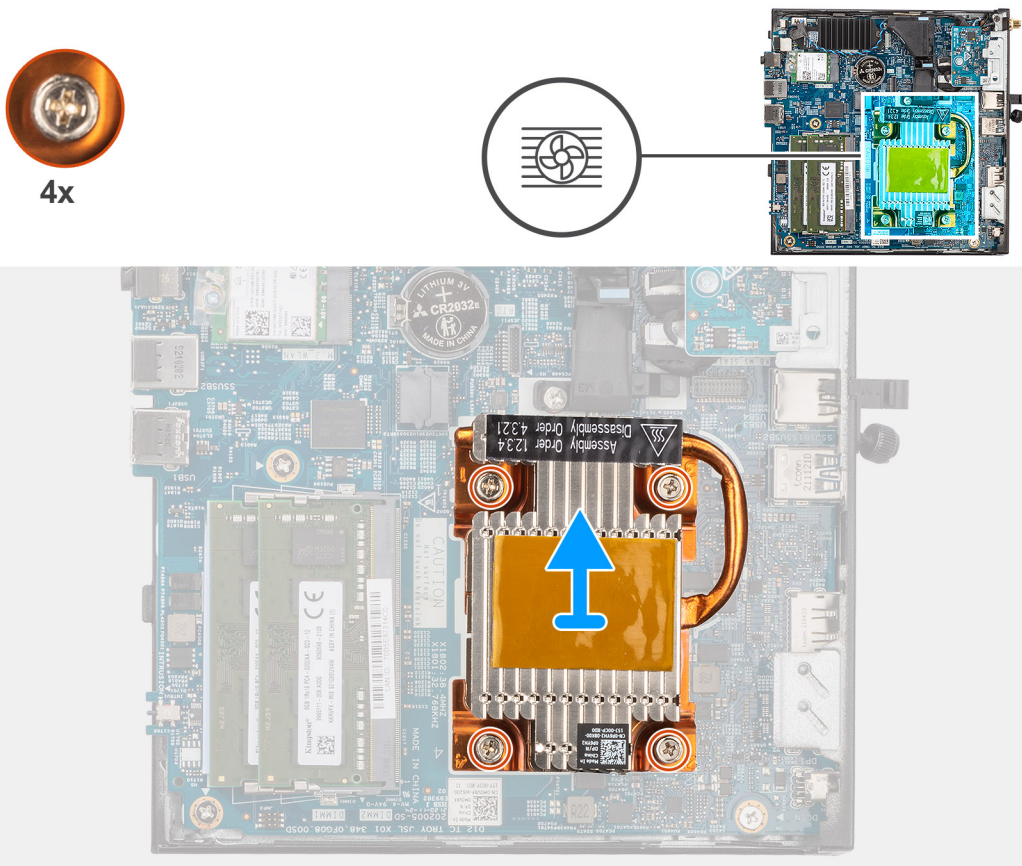

Steps

1. In reverse sequential order (as indicated by the numbers on the heat sink), loosen the four captive screws that secure the heat sink to the system board.
2. Lift the heat sink off the system board.

Installing the heat sink

Prerequisites

If you are replacing a component, remove the existing component before performing the installation procedure.

About this task

The following image indicates the location of the heat sink and provides a visual representation of the installation procedure.



4x

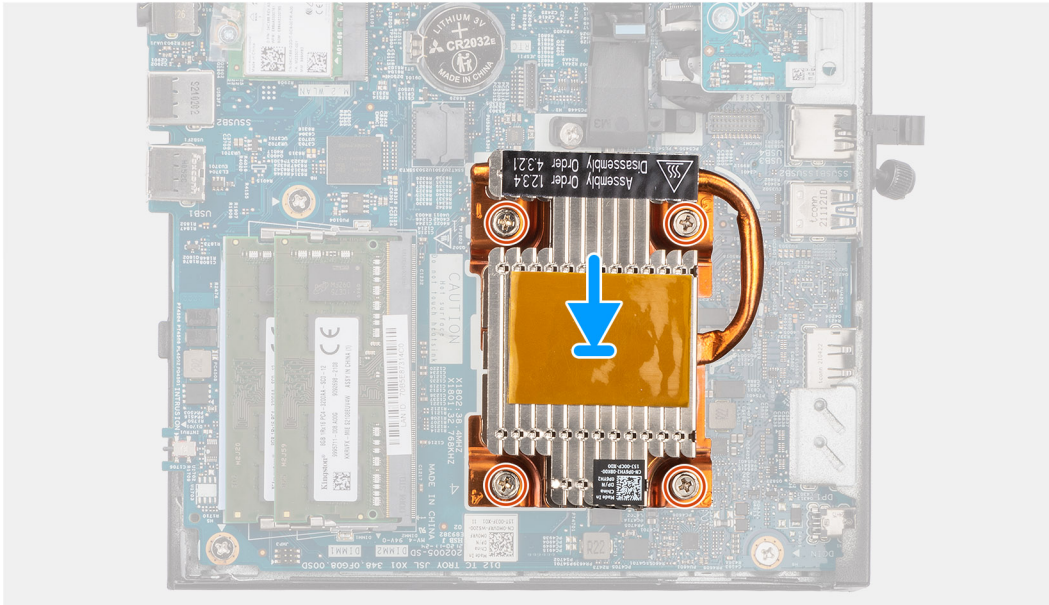
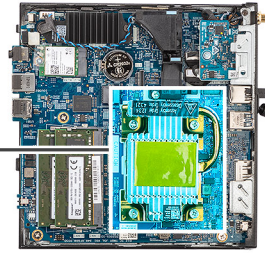

Steps

1. Align the screws on the heat sink with the screw holders on the system board and place the heat sink on the processor.
2. In sequential order (as indicated by the numbers on the heat sink), tighten the four captive screws that secure the heat sink to the system board.

Next steps

1. Install the [side cover](#).
2. Follow the procedure in [after working inside your computer](#).

Internal Antenna

Removing the internal antenna in Location 1

Prerequisites

1. Follow the procedure in [before working inside your computer](#).
2. Remove the [side cover](#).
3. Remove the [WLAN card](#).

About this task

The following image indicates the location of an internal antenna in location 1 and provides a visual representation of the removal procedure.



1x
M3x3

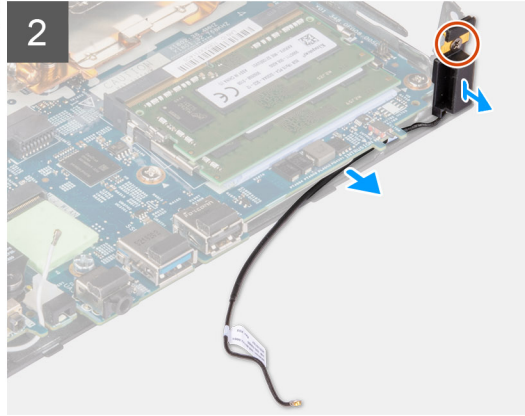
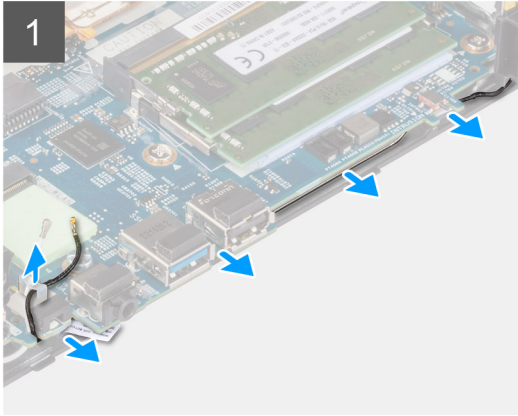

Steps

1. Unroute the black antenna-cable from the routing guides under the system board and from the cable clip.
2. Remove the screw (M3x3) that secures the antenna to the chassis.
3. Lift and remove the antennas and the cables from the chassis.

Installing the internal antenna in Location 1

Prerequisites

If you are replacing a component, remove the existing component before performing the installation procedure.

About this task

The following image indicates the location of an internal antenna in location 1 and provides a visual representation of the removal procedure.



1x
M3x3

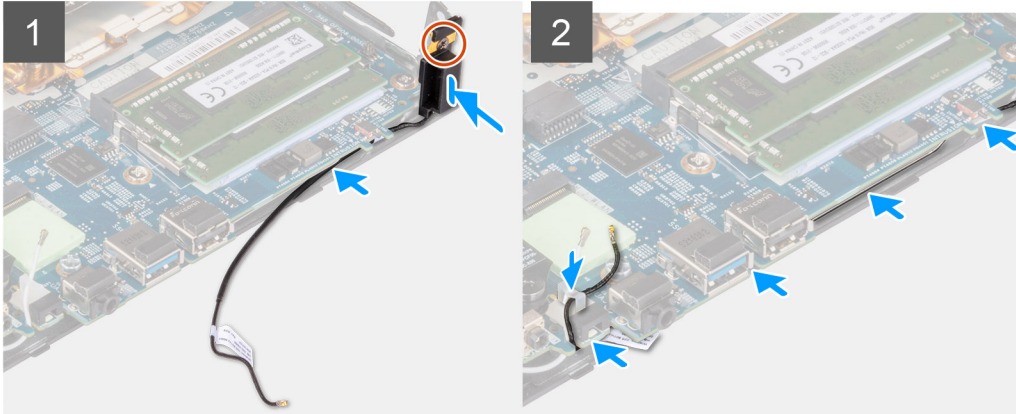
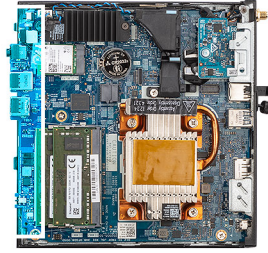

Steps

1. Remove the adhesive tape from the antenna.
2. Align the hole on the antenna with the stand on the chassis.
3. Replace the screw (M3x3) to secure the antenna to the chassis.
4. Using a plastic scribe, route the black antenna-cable under the system board and through the cable clip.

Next steps

1. Install the [WLAN card](#).
2. Install the [side cover](#).
3. Follow the procedure in [after working inside your computer](#).

Removing the internal antenna in Location 2

Prerequisites

1. Follow the procedure in [before working inside your computer](#).
2. Remove the [side cover](#).
3. Remove the [WLAN card](#).

About this task

The following image indicates the location of an internal antenna in location 2 and provides a visual representation of the removal procedure.



1x



1x
M3x3

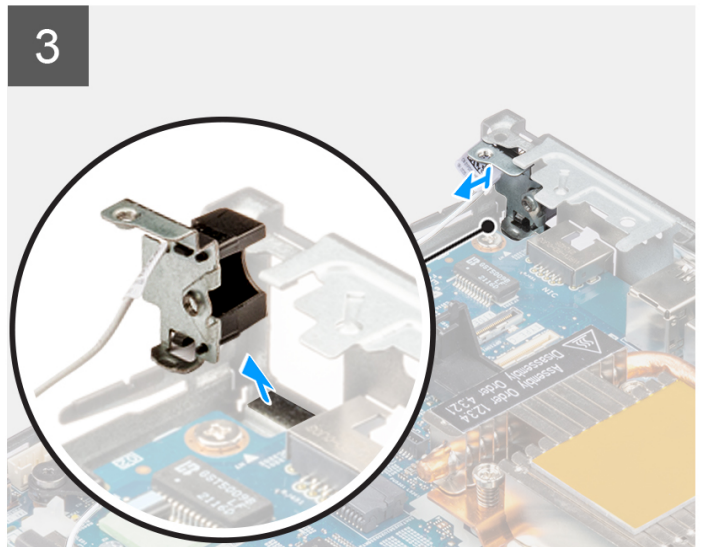
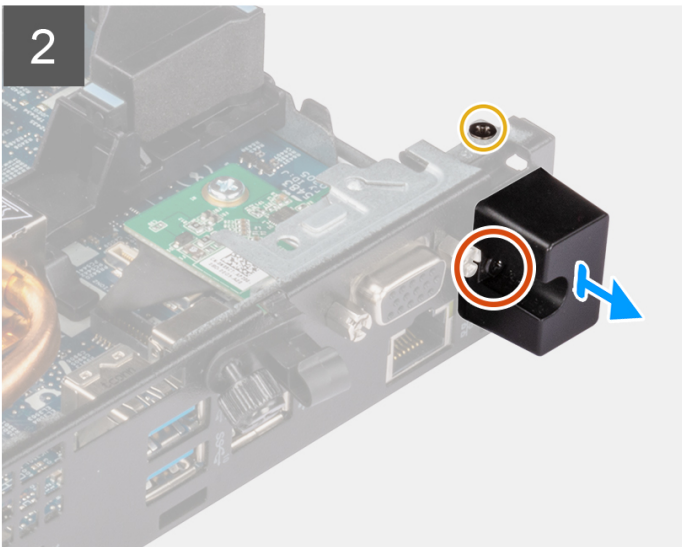
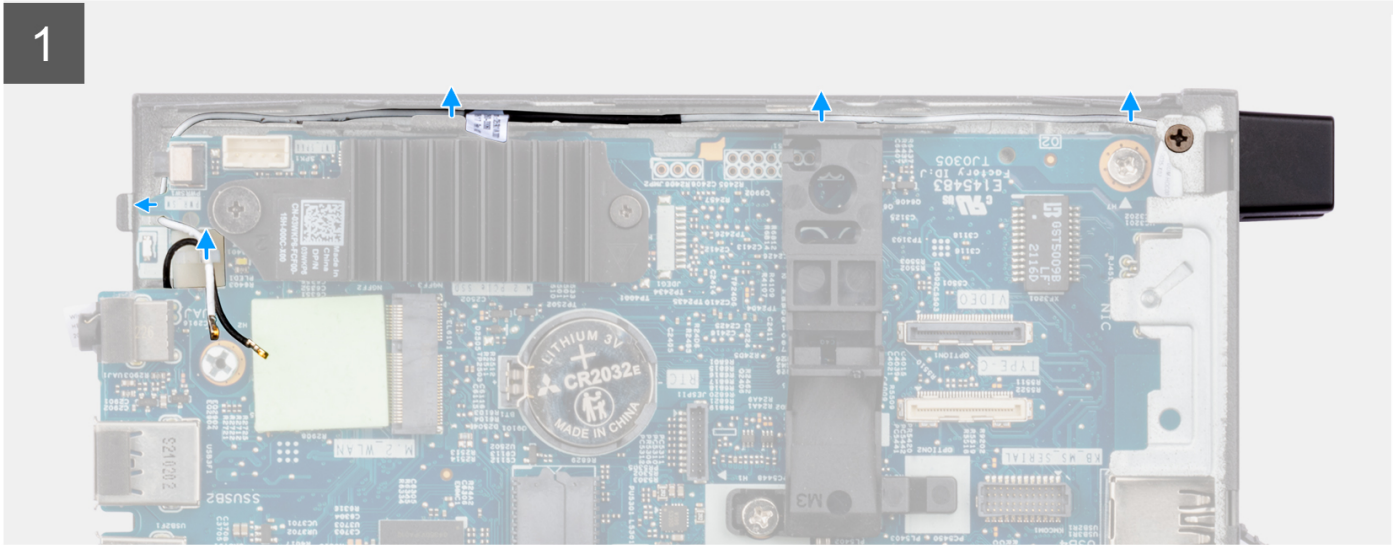

Steps

1. Loosen the captive screw that secures the antenna cover to the antenna.
2. Remove the antenna cover from the antenna.
3. Remove the screw (M3x3) that secures the antenna to the chassis.
4. Unroute the antenna-cable from cable clip and the routing guides on the chassis.
5. Lift and pull the antenna along with its cable to remove it from the chassis.

Installing the internal antenna in Location 2

Prerequisites

If you are replacing a component, remove the existing component before performing the installation procedure.

About this task

The following image indicates the location of an internal antenna in location 2 and provides a visual representation of the removal procedure.



1x



1x
M3x3

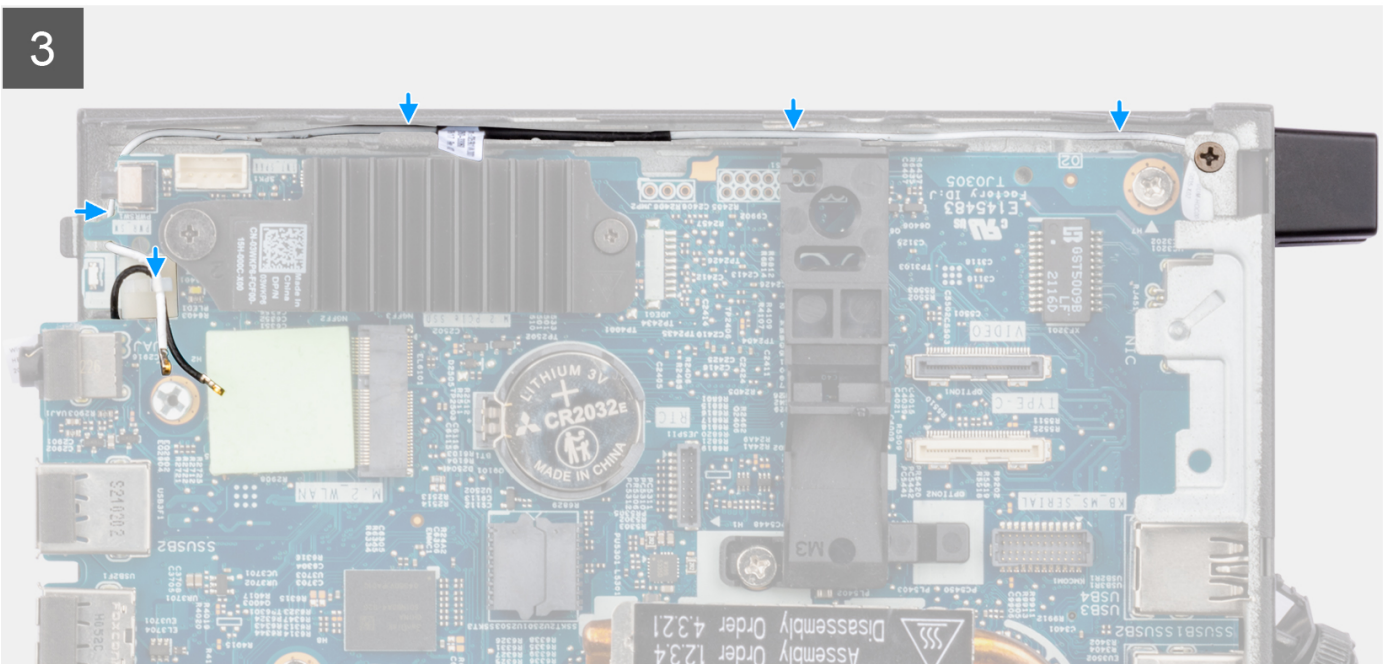
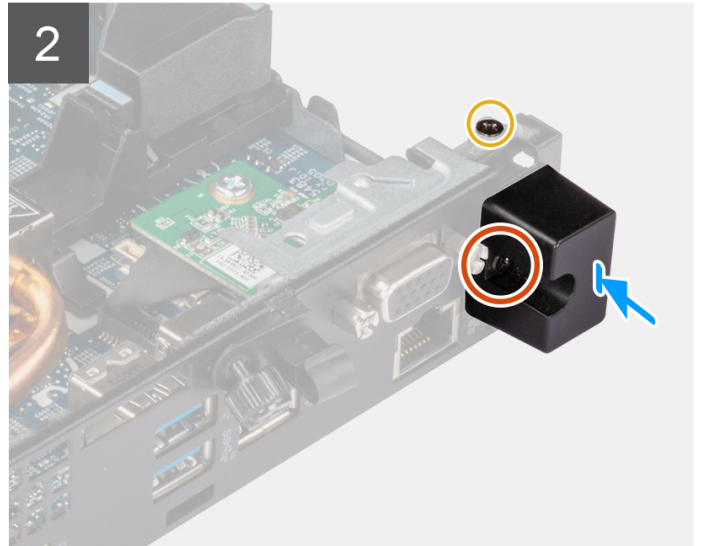
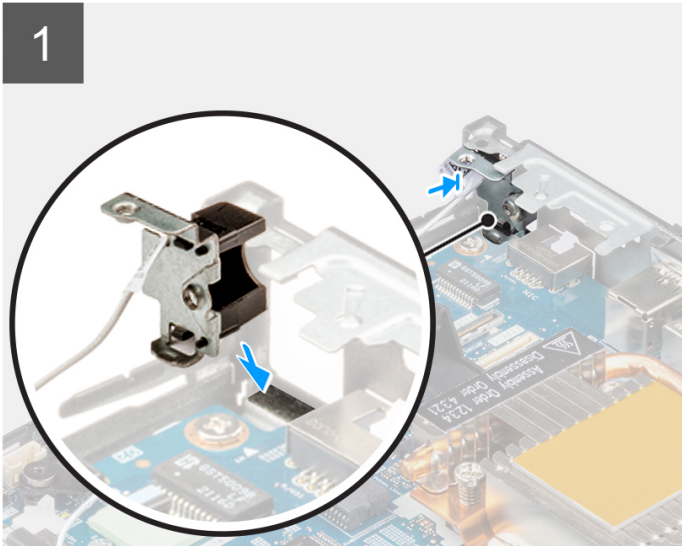
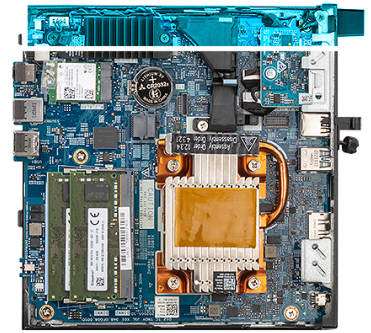

Steps

1. Remove the filler on the back of the system.

 **NOTE:** Step one is only applicable for new installation. For replacing an existing component, follow the procedure from step two.

2. Loosen the captive screw that secures the antenna cover to the antenna.

3. Insert the antenna cable through the opening at the back of the system.
4. Route the antenna-cable through cable clip and the routing guides on the chassis.
5. Tilt and align the tab on the antenna with the slot on the chassis.
6. Replace the screw (M3x3) to secure the antenna to the chassis.
7. Place the antenna cover on the antenna and tighten the captive screw to secure the antenna.

Next steps

1. Install the [WLAN card](#).
2. Install the [side cover](#).
3. Follow the procedure in [after working inside your computer](#).

SMA antenna kit

Removing the SMA antenna in Location 2

Prerequisites

1. Follow the procedure in [before working inside your computer](#).
2. Remove the [side cover](#).
3. Remove the [WLAN card](#).

About this task

The following image indicates the location of the SMA antenna and provides a visual representation of the removal procedure.

 **NOTE:** To upgrade to SMA antenna, the internal antenna Location 2 is required to be removed.



1x
M3x3

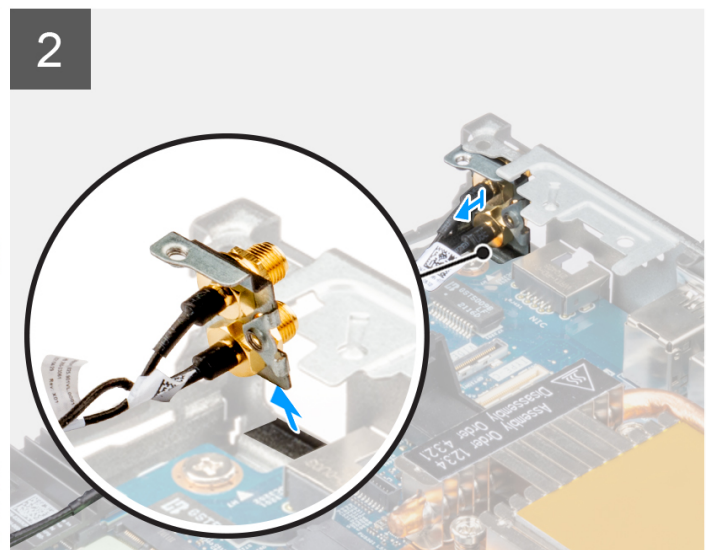
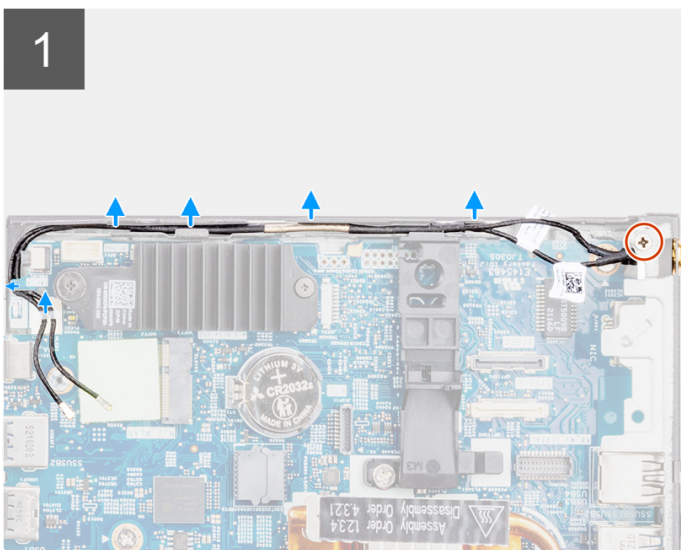
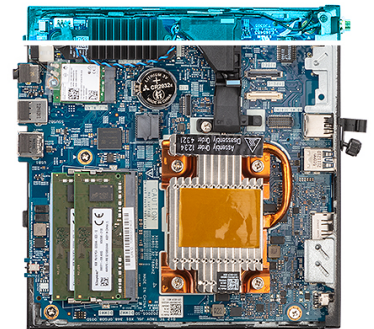

Steps

1. Remove the screw (M3x3) that secures the SMA antenna to the chassis.
2. Unroute the antenna cables from the cable clips and the routing guides on the chassis.
3. Push the SMA antenna inside the chassis. Lift and pull the antenna and the cables to remove it from the chassis.

Installing the SMA antenna Location 2

Prerequisites

If you are replacing a component, remove the existing component before performing the installation procedure.

About this task

The following image indicates the location of the SMA antenna and provides a visual representation of the removal procedure.

 **NOTE:** To upgrade to SMA antenna, the internal antenna Location 2 is required to be removed.



1x
M3x3

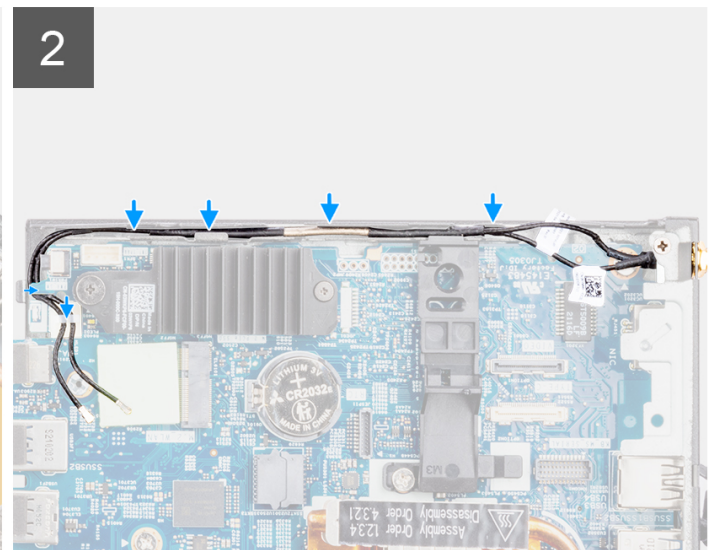
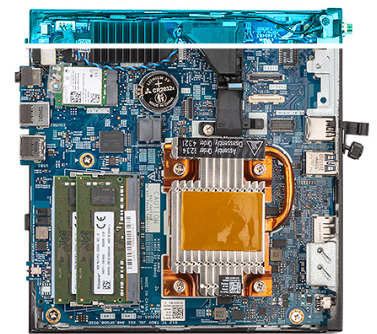

Steps

1. Remove the filler on the back of the system.

 **NOTE:** Step one is only applicable for new installation or an upgrade. For replacing an existing component, follow the procedure from step two.

2. Route the antenna cable through cable clip and the routing guides on the system.
3. Tilt and align the tab on the antenna with the slot on the chassis.
4. Insert the antenna bracket into the opening on the system board.
5. Rotate the antenna bracket to align the SMA antenna assembly with the screw hole on the back view.
6. Replace the screw (M3x3) to secure the SMA antenna assembly to the system.

Next steps

1. Install the [WLAN card](#).
2. Install the [side cover](#).
3. Follow the procedure in [after working inside your computer](#).

System board

Removing the system board

Prerequisites

1. Follow the procedure in [before working inside your computer](#).
2. Remove the [side cover](#).
3. Remove the [speaker](#).
4. Remove the [solid-state drive assembly](#).
5. Remove the [memory](#).
6. Remove the [WLAN card](#) or [Small Form Factor Pluggable \(SFP\) port](#).
7. Remove the [heat sink](#).

About this task

The following image indicates the connectors on your system board.

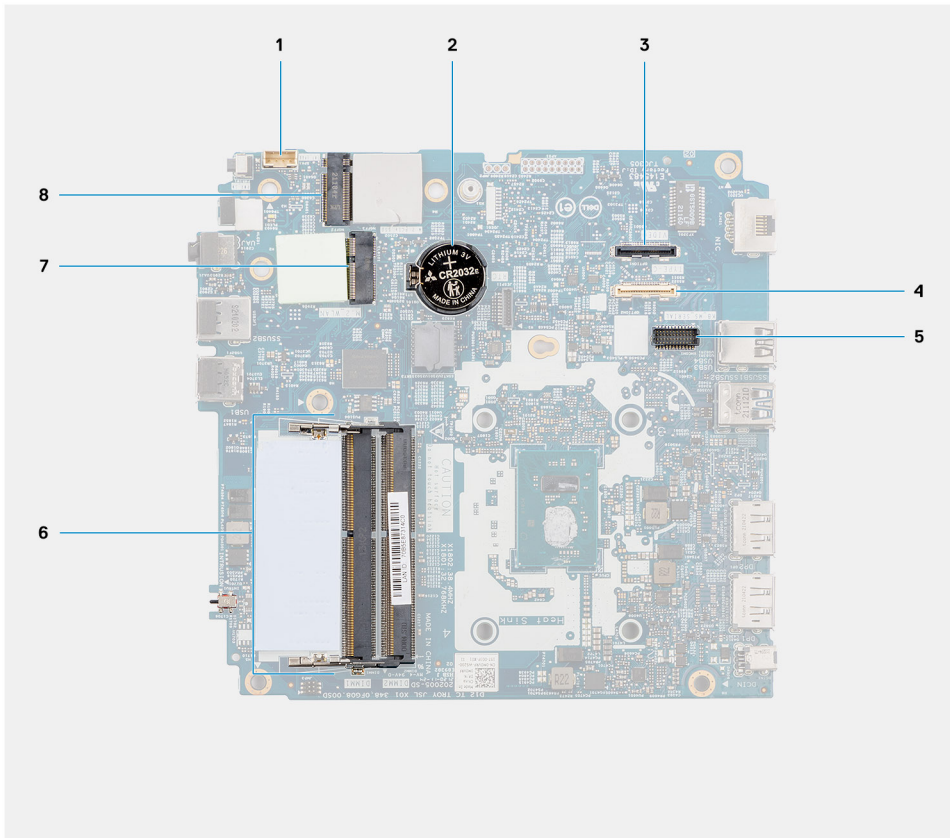

- | | |
|--|---|
| 1. Speaker cable | 2. Coin-cell battery |
| 3. Optional video connector (HDMI/VGA/DP port) | 4. Optional I/O cable connector (USB 3.2 Gen 1 Type-C port with DisplayPort Alt mode) |
| 5. Optional PS/2 keyboard/mouse module connector | 6. Memory module slots |
| 7. WLAN card connector | 8. M.2 2230 solid-state drive connector |

The following images indicate the location of the system board and provide a visual representation of the removal procedure.

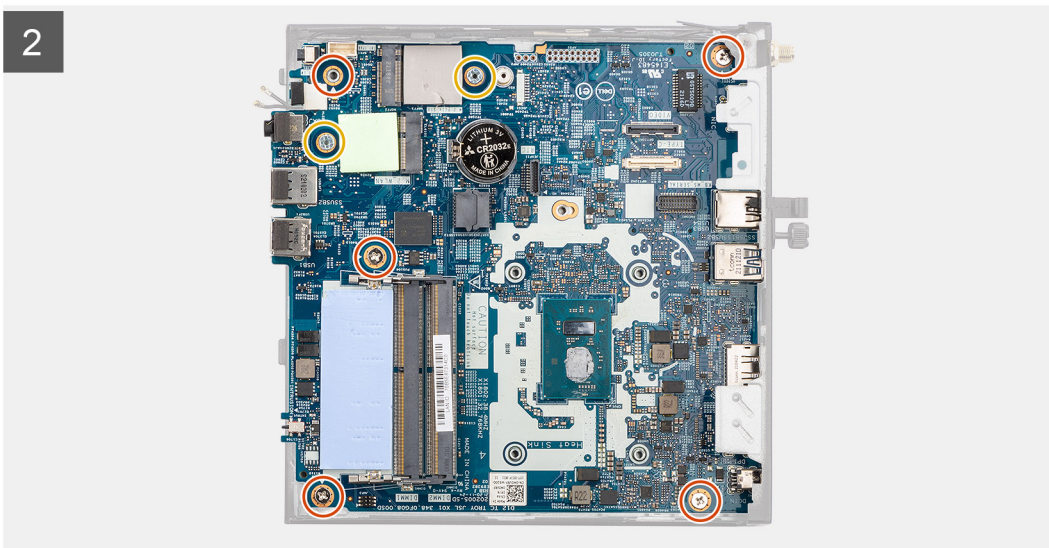
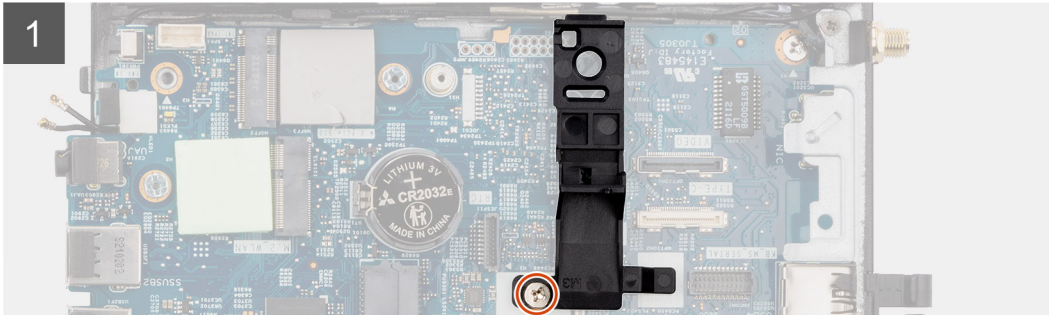
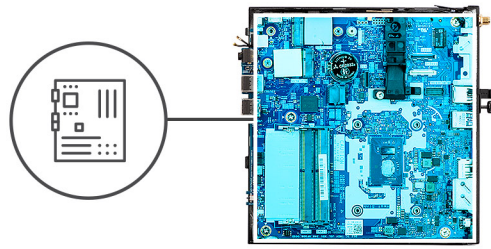
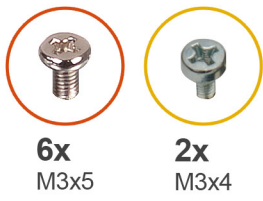

3

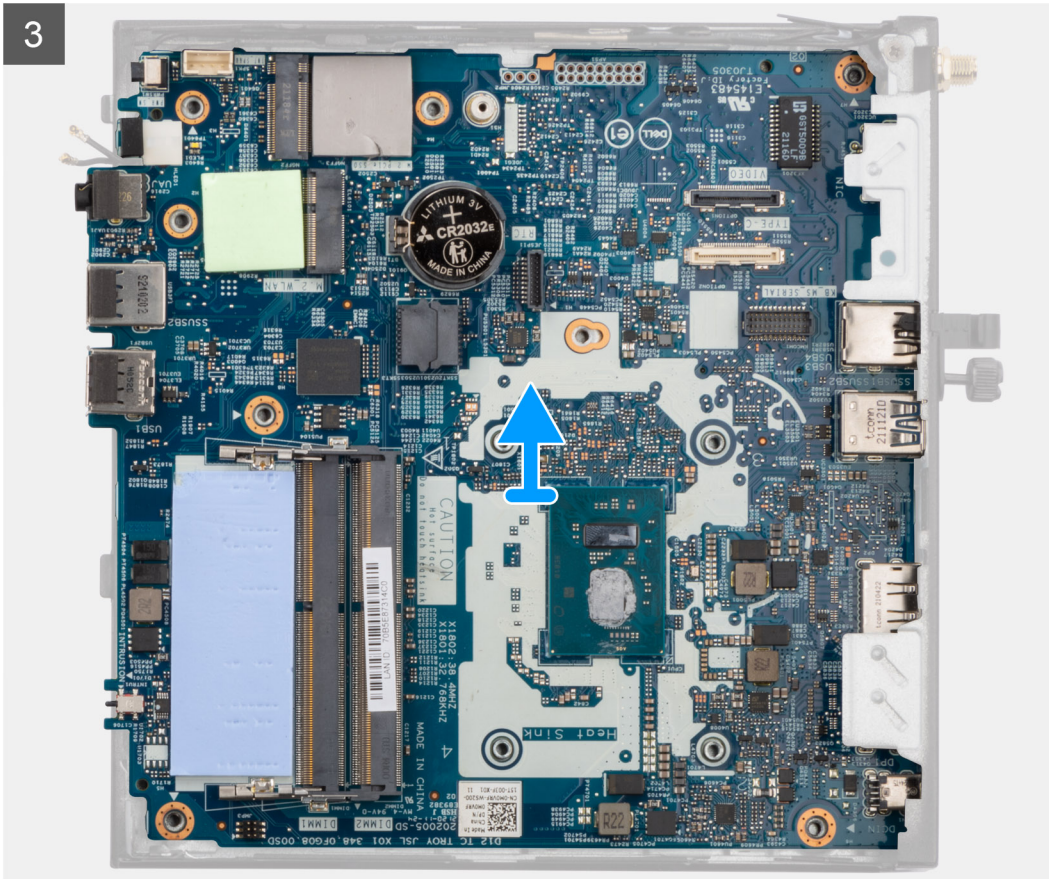

Steps

1. Remove the screw (M3x5) that secures the speaker holder to the system board.
2. Lift and remove the speaker holder from the system board.
3. Remove the five (M3x5) screws and two (M3x4) screws that secure the system board to the computer chassis.
4. Lift and remove the system board from the computer chassis.

Installing the system board

Prerequisites

If you are replacing a component, remove the existing component before performing the installation procedure.

About this task

The following image indicates the connectors on your system board.

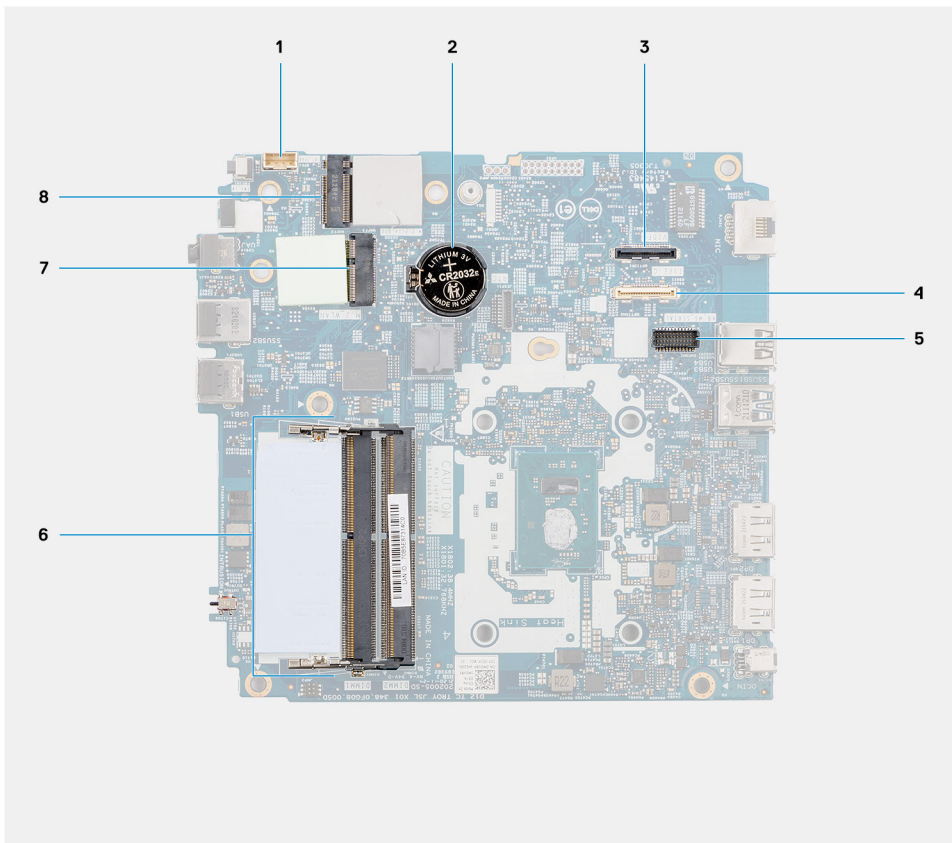

- | | |
|--|---|
| 1. Speaker cable | 2. Coin-cell battery |
| 3. Optional video connector (HDMI/VGA/DP port) | 4. Optional I/O cable connector (USB 3.2 Gen 1 Type-C port with DisplayPort Alt mode) |
| 5. Optional PS/2 keyboard/mouse module connector | 6. Memory module slots |
| 7. WLAN card connector | 8. M.2 2230 solid-state drive connector |

The following images indicate the location of the system board and provide a visual representation of the installation procedure.

1

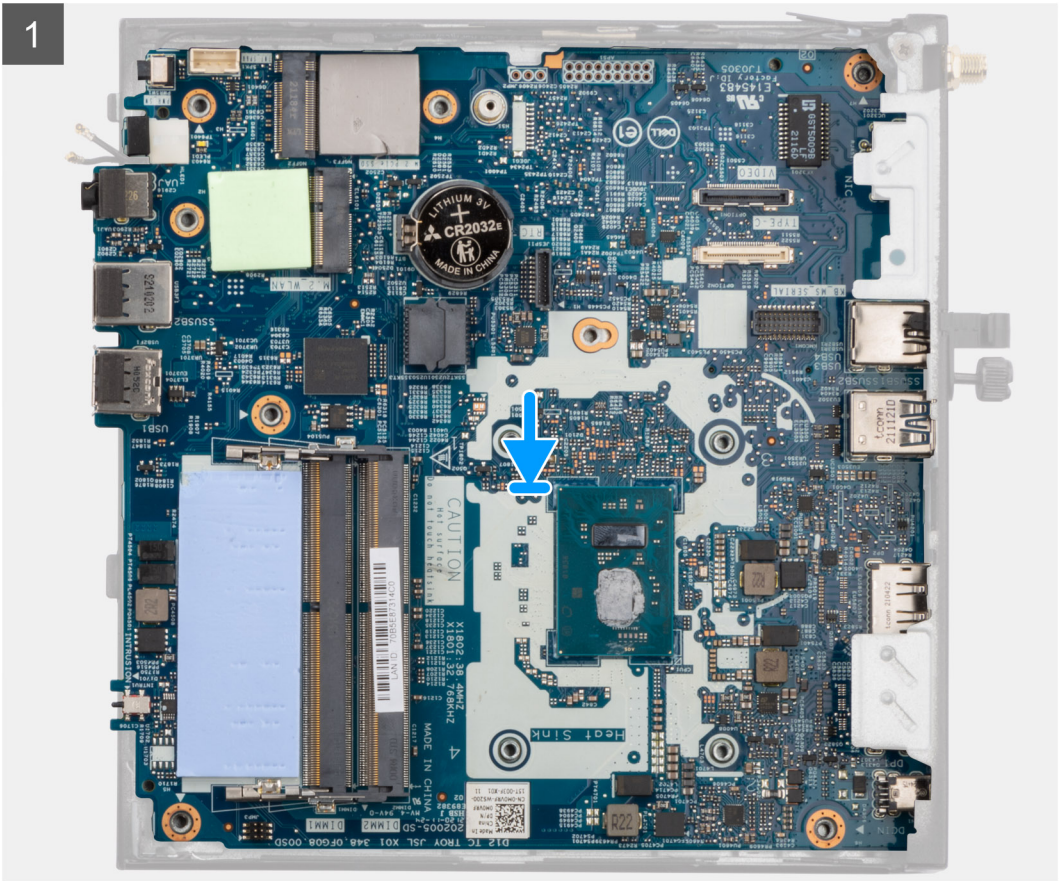



6x
M3x5



2x
M3x4

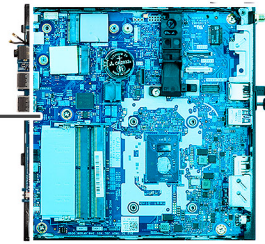

2

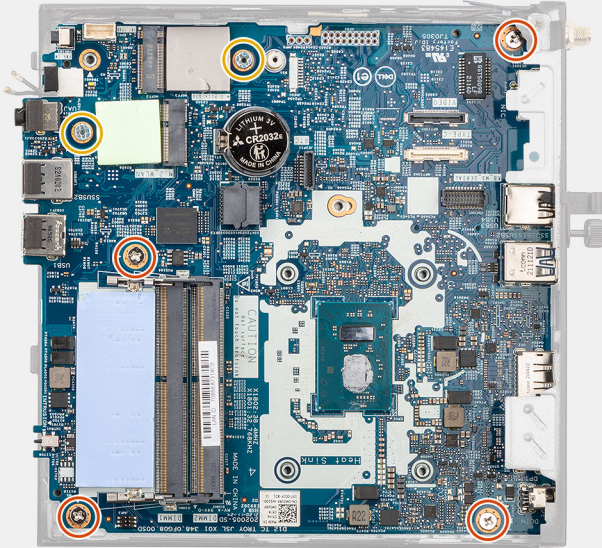

3

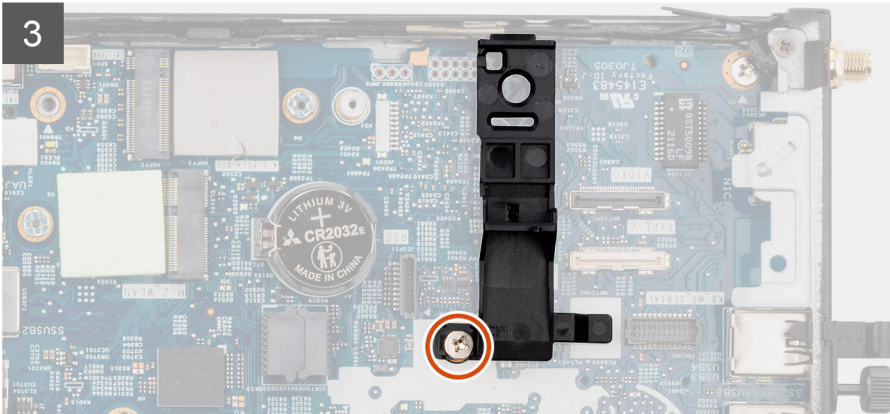

Steps

1. Align and lower the system board into the system until the connectors at the back of the system board align with the slots on the chassis, and the screw holes on the system board align with the standoffs on the system.
2. Replace the five (M3x5) screws and two (M3x4) screws to secure the system board to the computer chassis.

i NOTE: The coin-cell battery has a black mylar for cosmetic purpose only and has no functional impact. During the installation of a new system board, it is recommended to transfer the black mylar from the previous system board to the new system board.

To install the mylar sheet, follow the below mentioned steps:

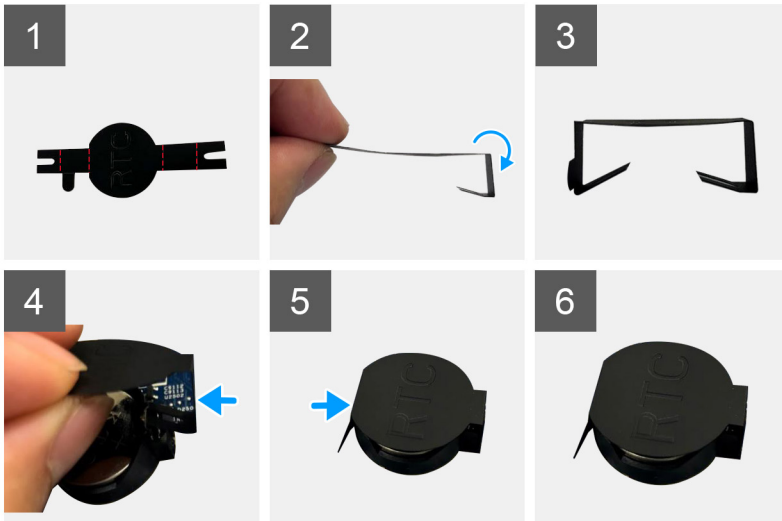

- a. Use the folding lines on the mylar sheet to fold the mylar sheet.
- b. Insert one end of the mylar sheet under the RTC socket.
- c. Insert another end of the mylar sheet under another side of the RTC socket.

3. Align and place the speaker holder into the speaker holder slot on the system board.
4. Replace the screw (M3x5) to secure the speaker holder to the system board.

Next steps

1. Install the [heat sink](#).
2. Install the [WLAN card](#) or [Small Form Factor Pluggable \(SFP\) port](#).
3. Install the [memory](#).
4. Install the [solid-state drive assembly](#).
5. Install the [speaker](#).
6. Install the [side cover](#).
7. Follow the procedure in [after working inside your computer](#).

Drivers and downloads

When troubleshooting, downloading, or installing drivers, it is recommended that you read the Dell Knowledge Base article Drivers and Downloads FAQs [000123347](#).

BIOS Setup

CAUTION: Unless you are an expert computer user, do not change the settings in the BIOS Setup. Certain changes can make your computer work incorrectly.

NOTE: Depending on the computer and its installed devices, the items that are listed in this section may or may not be displayed.

NOTE: Before you change the settings in BIOS Setup, it is recommended that you note down the original settings for future reference.

Use BIOS Setup for the following purposes:

- Get information about the hardware installed in your computer, such as the amount of RAM and the size of the storage device.
- Change the system configuration information.
- Set or change a user-selectable option, such as the user password, type of hard drive installed, and enabling or disabling base devices.

Entering BIOS setup program

About this task

Turn on (or restart) your computer and press F2 immediately.

Navigation keys

NOTE: For most of the System Setup options, changes that you make are recorded but do not take effect until you restart the computer.

Table 3. Navigation keys

Keys	Navigation
Up arrow	Moves to the previous field.
Down arrow	Moves to the next field.
Enter	Selects a value in the selected field (if applicable) or follows the link in the field.
Spacebar	Expands or collapses a drop-down list, if applicable.
Tab	Moves to the next focus area. NOTE: For the standard graphical user interface only.
Esc	Moves to the previous page until you view the main screen. Pressing Esc in the main screen displays a message that prompts you to save any unsaved changes and restart the computer.

F12 One Time Boot menu

To enter the One Time Boot menu, turn on your computer, and then press F12 immediately.

 **NOTE:** It is recommended to shut down the computer, if it is on.

The F12 One Time Boot menu displays the devices that you can boot from including the diagnostic option. The boot menu options are:

- Removable Drive (if available)
- STXXXX Drive (if available)
 -  **NOTE:** XXX denotes the SATA drive number.
- Optical Drive (if available)
- SATA Hard Drive (if available)
- Diagnostics

The boot sequence screen also displays the option to access System Setup.

System setup options

 **NOTE:** Depending on your computer and its installed devices, the items that are listed in this section may or may not appear.

Table 4. System setup options—System information menu

Overview	
OptiPlex 3000 Thin Client	
BIOS Version	Displays the BIOS version number.
Service Tag	Displays the Service Tag of the computer.
Asset Tag	Displays the Asset Tag of the computer.
Manufacture Date	Displays the manufacture date of the computer.
Ownership Date	Displays the ownership date of the computer.
Express Service Code	Displays the express service code of the computer.
Ownership Tag	Displays the Ownership Tag of the computer.
Signed Firmware Update	Displays whether the Signed Firmware Update is enabled on your computer.
Processor Information	
Processor Type	Displays the processor type.
Maximum Clock Speed	Displays the maximum processor clock speed.
Minimum Clock Speed	Displays the minimum processor clock speed.
Current Clock Speed	Displays the current processor clock speed.
Core Count	Displays the number of cores on the processor.
Processor ID	Displays the processor identification code.
Processor L2 Cache	Displays the processor L2 Cache size.
Processor L3 Cache	Displays the processor L3 Cache size.
Microcode Version	Displays the microcode version.
Intel Hyper-Threading Capable	Displays whether the processor is Hyper-Threading (HT) capable.
64-Bit Technology	Displays whether 64-bit technology is used.
Memory Information	
Memory Installed	Displays the total computer memory installed.
Memory Available	Displays the total computer memory available.
Memory Speed	Displays the memory speed.
Memory Channel Mode	Displays single or dual channel mode.

Table 4. System setup options—System information menu (continued)

Overview	
Memory Technology	Displays the technology that is used for the memory.
DIMM 1 Size	Displays the DIMM 1 memory size.
DIMM 2 Size	Displays the DIMM 2 memory size.
Devices Information	
Video Controller	Displays the video controller type of the computer.
Video Memory	Displays the video memory information of the computer.
Wi-Fi Device	Displays the wireless device information of the computer.
Native Resolution	Displays the native resolution of the computer.
Video BIOS Version	Displays the video BIOS version of the computer.
Audio Controller	Displays the audio controller information of the computer.
Bluetooth Device	Displays the Bluetooth device information of the computer.
LOM MAC Address	Displays the LAN On Motherboard (LOM) MAC address of the computer.

Table 5. System setup options—Boot Configuration menu

Boot Configuration	
Boot Sequence	
Boot Mode: UEFI only	Displays the boot mode.
Boot Sequence	Displays the boot sequence.
Secure Boot	
Enable Secure Boot	Enable or disable the secure boot feature. By default, the option is not enabled.
Enable Microsoft UEFI CA	Enable or disable the Microsoft UEFI CA feature. By default, the option is enabled.
Secure Boot Mode	Enable or disable to change the secure boot mode options. By default, the Deployed Mode is enabled.
Expert Key Management	
Enable Custom Mode	Enable or disable custom mode. By default, the custom mode option is not enabled.
Custom Mode Key Management	Select the custom values for expert key management.

Table 6. System setup options—Integrated Devices menu

Integrated Devices	
Date/Time	Displays the current date in MM/DD/YYYY format and current time in HH:MM:SS AM/PM format.
Audio	
Enable Audio	Enable or disable the integrated audio controller. By default, all the options are enabled.
USB Configuration	Enable or disable booting from USB mass storage devices through the boot sequence or boot menu. By default, all options are enabled.

Table 6. System setup options—Integrated Devices menu (continued)

Integrated Devices	
Front USB ports	Enable or disable the individual front USB ports. By default, all options are enabled.
Rear USB ports	Enable or disable the individual rear USB ports. By default, all options are enabled.

Table 7. System setup options—Storage menu

Storage	
SATA/NVMe Operation	Enable or disable the operating mode of the integrated SATA hard drive controller. By default, AHCI/NVMe option is enabled.
Storage Interface	
Port Enablement	Enable or disable the onboard drives. By default, all the options are enabled.
SMART Reporting	
Enable SMART Reporting	Enable or disable Self-Monitoring, Analysis, and Reporting Technology (SMART) during computer startup. By default, the Enable SMART Reporting option is not enabled.
Drive Information	
M.2 PCIe SSD	
Type	Displays the M.2 PCIe SSD type information of the computer.
Device	Displays the M.2 PCIe SSD device information of the computer.
Onboard eMMC	
Type	Displays the eMMC type information of the computer.
Device	Displays the eMMC device information of the computer.

Table 8. System setup options—Display menu

Display	
Primary Display	
Video Primary Display	Determines the primary display when multiple controllers are available on the computer. By default, the Auto option is enabled.

Table 9. System setup options—Connection menu

Connection	
Network Controller Configuration	
Integrated NIC	Controls the on-board LAN controller. By default, the Enabled with PXE option is enabled.
Wireless Device Enable	
WLAN	Enable or disable the internal WLAN device By default, the option enabled.
Bluetooth	Enable or disable the internal Bluetooth device

Table 9. System setup options—Connection menu (continued)

Connection	
Enable UEFI Network Stack	<p>By default, the option enabled.</p> <p>Enable or disable UEFI Network Stack and controls the on-board LAN Controller.</p> <p>By default, the option is enabled.</p>
HTTPs Boot Feature	
HTTPs Boot	<p>Enable or disable the HTTPs Boot feature.</p> <p>By default, the HTTPs Boot option is enabled.</p>
HTTPs Boot Mode	<p>With Auto Mode, the HTTPs Boot extracts Boot URL from the DHCP. With Manual Mode, the HTTPs Boot reads Boot URL from the user-provided data.</p> <p>By default, the Auto Mode option is enabled.</p>

Table 10. System setup options—Power menu

Power	
USB Wake Support	
Enable USB Wake Support	<p>When enabled, you can use the USB devices like a mouse or keyboard to wake your computer from standby.</p> <p>By default, the option is enabled.</p>
AC Behavior	
AC Recovery	<p>Enables the system to turn on automatically, when AC is inserted.</p> <p>By default, the Power Off option is enabled.</p>
Active State Power Management	
Aspm	<p>Enables or disables the Active State Power Management (ASPM) level</p> <p>By default, the Auto option is enabled.</p>
Block Sleep	<p>Enables to block entering sleep (S3) mode in the operating system.</p> <p>By default, the Block Sleep option is disabled.</p>
Deep Sleep Control	<p>Enable or disable the Deep Sleep mode support.</p> <p>By default, the Disabled option is enabled.</p>
Intel Speed Shift Technology	<p>Enable or disable the Intel speed shift technology support.</p> <p>By default, the Intel Speed Shift Technology option is enabled.</p>

Table 11. System setup options—Security menu

Security	
Intel Platform Trust Technology	
Intel Platform Trust Technology On	<p>Enable or disable Intel Platform Trust Technology security options.</p> <p>By default, the option is enabled.</p>
PPI ByPass for Clear Commands	<p>Controls the TPM Physical Presence Interface (PPI).</p> <p>By default, the PPI ByPass for Clear Commands option is disabled.</p>
Clear	<p>Enables to clear the PTT owner information and returns the PTT to the default state.</p> <p>By default, the Clear option is disabled.</p>

Table 11. System setup options—Security menu (continued)

Security	
Chassis intrusion	Controls the chassis intrusion feature. By default, the option is disabled.
SMM Security Mitigation	Enable or disable SMM Security Mitigation. By default, the option is disabled.
Data Wipe on Next Boot	
Start Data Wipe	Enable or disable the data wipe on next boot. By default, the option is disabled.
Absolute	Enable or disable or permanently disable the BIOS module interface of the optional Absolute Persistence Module service from Absolute software. By default, the Enable Absolute option is enabled.
UEFI Boot Path Security	Controls whether or not the computer will prompt the user to enter the admin password (if set) when booting to a UEFI boot device from the F12 boot menu. By default, the Always Except Internal HDD option is enabled.

Table 12. System setup options—Passwords menu

Passwords	
Admin Password	Set, change, or delete the administrator password.
System Password	Set, change, or delete the computer password.
M.2 PCIe SSD-0	Set, change, or delete the M.2 PCIe SSD-0 password.
Password Configuration	
Upper Case Letter	Reinforces password must have at least one upper case letter. By default, the option is disabled.
Lower Case Letter	Reinforces password must have at least one lower case letter. By default, the option is disabled.
Digit	Reinforces password must have at least one digit. By default, the option is disabled.
Special Character	Reinforces password must have at least one special character. By default, the option is disabled.
Minimum Characters	Set the minimum characters allowed for password.
Password Bypass	When enabled, this always prompts for computer and internal hard drive passwords when powered on from the Off state. By default, the Disabled option is enabled.
Password Changes	
Enable Non-Admin Password Changes	Enable or disable to change computer and hard drive password without the need for admin password. By default, the option is enabled.
Admin Setup Lockout	
Enable Admin Setup Lockout	Enables administrators control over how their users can or cannot access BIOS setup. By default, the option is disabled.

Table 12. System setup options—Passwords menu (continued)

Passwords	
Master Password Lockout	
Enable Master Password Lockout	When enabled, this will disable the master password support. By default, the option is disabled.
Allow Non-Admin PSID Revert	
Enable Allow Non-Admin PSID Revert	Controls access to the Physical Security ID (PSID) revert of NVMe hard-drives from the Dell Security Manager prompt. By default, the option is disabled.

Table 13. System setup options—Update, Recovery menu

Update, Recovery	
UEFI Capsule Firmware Updates	Enable or disable BIOS updates through UEFI capsule update packages. By default, the option is enabled.
BIOS Recovery from Hard Drive	Enables the user to recover from certain corrupted BIOS conditions from a recovery file on the user primary hard drive or an external USB key. By default, the option is enabled.
BIOS Downgrade	
Allow BIOS Downgrade	Enable or disable the flashing of the computer firmware to previous revision is blocked. By default, the option is enabled.
SupportAssist OS Recovery	Enable or disable the boot flow for SupportAssist OS Recovery tool in the event of certain computer errors. By default, the option is enabled.
Dell Auto OS Recovery Threshold	Controls the automatic boot flow for SupportAssist System Resolution Console and for Dell OS Recovery Tool. By default, the threshold value is set to 2.

Table 14. System setup options—System Management menu

System Management	
Service Tag	Displays the Service Tag of the computer.
Asset Tag	Create a computer Asset Tag.
Wake on LAN/WLAN	Enable or disable the computer to power on by special LAN signals when it receives a wake up signal from the WLAN. By default, the Disabled option is selected.
Auto On Time	Enable to set the computer to turn on automatically every day or on a preselected date and time. This option can be configured only if the Auto On Time is set to Everyday, Weekdays, or Selected Days. By default, the option is disabled.
SERR Messages	Enable or disable SERR messages. By default, the option is enabled.
First Power On Date	Set Ownership Date. By default, the option is disabled.
Diagnostics	

Table 14. System setup options—System Management menu (continued)

System Management	
OS Agent Requests	When enabled, Dell OS Agent(s) will be capable of scheduling onboard diagnostics on a subsequent boot which can help assist in the prevention and resolution of hardware related issues. By default, the option is enabled.
Power-on-Self-Test Automatic Recovery	When enabled, if the computer should become unresponsive before completing the BIOS Power-On-Self-Test (POST), the BIOS will attempt to automatically recover the computer in some cases, this may include reverting BIOS Setup configuration settings to BIOS default values, and unprovisioning Intel AMT vPro (if applicable). By default, the option is enabled.

Table 15. System setup options—Keyboard menu

Keyboard	
Keyboard Errors	
Enable Keyboard Error Detection	Enable or disable the keyboard error detection. By default, the option is enabled.
Numlock LED	
Enable Numlock LED	Enable or disable Numlock LED. By default, the option is enabled.

Table 16. System setup options—Pre-boot Behavior menu

Pre-boot Behavior	
Adapter Warnings	
Enable Adapter Warnings	Enable or disable adapter warnings when adapters with too little power capacity are detected. By default, the option is enabled.
Warning and Errors	
	Enable or disable the action to be done when a warning or error is encountered. By default, the Prompt on Warnings and Errors option is enabled.
Fastboot	
	Enable to set the speed of the UEFI boot process. By default, the Minimal option is enabled.
Extend BIOS POST Time	
	Set the BIOS POST time. By default, the 0 seconds option is enabled.

Table 17. System setup options—Virtualization Support menu

Virtualization Support	
Intel Virtualization Technology	
Enable Intel Virtualization Technology (VT)	Specify whether a Virtual Machine Monitor (VMM) can utilize the additional hardware capabilities that are provided by Intel Virtualization Technology. By default, the option is enabled.
VT for Direct I/O	
	Specify whether a Virtual Machine Monitor (VMM) can utilize the additional hardware capabilities that are provided by Intel Virtualization Technology for Direct I/O. By default, the option is enabled.

Table 17. System setup options—Virtualization Support menu (continued)

Virtualization Support	
DMA Protection	
Enable Pre-Boot DMA Support	Control Pre-Boot DMA protection for both internal and external ports. By default, the option is enabled.
Enable OS Kernel DMA Support	Controls Kernel DNA protection for both internal and external ports. By default, the option is enabled.

Table 18. System setup options—Performance menu

Performance	
Multi Core Support	
Active Cores	Enables to change the number of CPU cores available to the operating system. By default, the All Cores option is enabled.
Intel SpeedStep	
Enable Intel SpeedStep Technology	Enables the computer to dynamically adjust processor voltage and core frequency, decreasing average power consumption and heat production. By default, the option is enabled.
C-States Control	
Enable C-State Control	Enable or disable the CPU's ability to enter and exit low power states. By default, the option is enabled.
Intel Turbo Boost Technology	
Enable Intel Turbo Boost Technology	Enable or disable Intel TurboBoost mode of the processor. By default, the option is enabled.

Table 19. System setup options—System Logs menu

System Logs	
BIOS Event Log	
Clear BIOS Event Log	Displays BIOS events. By default, the Keep Log option is enabled.

Updating the BIOS

Updating the BIOS in Windows

About this task

 **CAUTION:** If BitLocker is not suspended before updating the BIOS, the next time you reboot the computer it will not recognize the BitLocker key. You will then be prompted to enter the recovery key to progress, and the computer will ask for this on each reboot. If the recovery key is not known this can result in data loss or an unnecessary operating system reinstall. For more information about this subject, search in the Knowledge Base Resource at [Dell Support Site](#).

Steps

1. Go to [Dell Support Site](#).

2. Click **Product support**. In the **Search support** box, enter the Service Tag of your computer, and then click **Search**.

 **NOTE:** If you do not have the Service Tag, use the SupportAssist feature to automatically identify your computer. You can also use the product ID or manually browse for your computer model.

3. Click **Drivers & Downloads**. Expand **Find drivers**.
4. Select the operating system installed on your computer.
5. In the **Category** drop-down list, select **BIOS**.
6. Select the latest version of BIOS, and click **Download** to download the BIOS file for your computer.
7. After the download is complete, browse the folder where you saved the BIOS update file.
8. Double-click the BIOS update file icon and follow the on-screen instructions.

For more information, search in the Knowledge Base Resource at [Dell Support Site](#).

Updating the BIOS in Linux and Ubuntu

To update the system BIOS on a computer that is installed with Linux or Ubuntu, see the knowledge base article [000131486](#) at [Dell Support Site](#).

Updating the BIOS using the USB drive in Windows

About this task

 **CAUTION:** If BitLocker is not suspended before updating the BIOS, the next time you reboot the computer it will not recognize the BitLocker key. You will then be prompted to enter the recovery key to progress, and the computer will ask for this on each reboot. If the recovery key is not known this can result in data loss or an unnecessary operating system reinstall. For more information about this subject, search in the Knowledge Base Resource at [Dell Support Site](#).

Steps

1. Follow the procedure from step 1 to step 6 in [Updating the BIOS in Windows](#) to download the latest BIOS setup program file.
2. Create a bootable USB drive. For more information, search in the Knowledge Base Resource at [Dell Support Site](#).
3. Copy the BIOS setup program file to the bootable USB drive.
4. Connect the bootable USB drive to the computer that needs the BIOS update.
5. Restart the computer and press **F12**.
6. Select the USB drive from the **One Time Boot Menu**.
7. Type the BIOS setup program filename and press **Enter**.
The **BIOS Update Utility** appears.
8. Follow the on-screen instructions to complete the BIOS update.

Updating the BIOS from the F12 One-Time boot menu

Update your computer BIOS using the BIOS update.exe file that is copied to a FAT32 USB drive and booting from the F12 One-Time boot menu.

About this task

 **CAUTION:** If BitLocker is not suspended before updating the BIOS, the next time you reboot the computer it will not recognize the BitLocker key. You will then be prompted to enter the recovery key to progress, and the computer will ask for this on each reboot. If the recovery key is not known this can result in data loss or an unnecessary operating system reinstall. For more information about this subject, search in the Knowledge Base Resource at [Dell Support Site](#).

BIOS Update

You can run the BIOS update file from Windows using a bootable USB drive or you can also update the BIOS from the F12 One-Time boot menu on the computer.

Most of the Dell computers built after 2012 have this capability, and you can confirm by booting your computer to the F12 One-Time Boot Menu to see if BIOS FLASH UPDATE is listed as a boot option for your computer. If the option is listed, then the BIOS supports this BIOS update option.

 **NOTE:** Only computers with the BIOS Flash Update option in the F12 One-Time boot menu can use this function.

Updating from the One-Time boot menu

To update your BIOS from the F12 One-Time boot menu, you need the following:

- USB drive formatted to the FAT32 file system (key does not have to be bootable)
- BIOS executable file that you downloaded from the Dell Support website and copied to the root of the USB drive
- AC power adapter that is connected to the computer
- Functional computer battery to flash the BIOS

Perform the following steps to perform the BIOS update flash process from the F12 menu:

 **CAUTION: Do not turn off the computer during the BIOS update process. The computer may not boot if you turn off your computer.**

Steps

1. From a turn off state, insert the USB drive where you copied the flash into a USB port of the computer.
2. Turn on the computer and press F12 to access the One-Time Boot Menu, select BIOS Update using the mouse or arrow keys then press Enter.
The flash BIOS menu is displayed.
3. Click **Flash from file**.
4. Select an external USB device.
5. Select the file and double-click the flash target file, and then click **Submit**.
6. Click **Update BIOS**. The computer restarts to flash the BIOS.
7. The computer will restart after the BIOS update is completed.

System and setup password

Table 20. System and setup password

Password type	Description
System password	Password that you must enter to log in to your system.
Setup password	Password that you must enter to access and make changes to the BIOS settings of your computer.

You can create a system password and a setup password to secure your computer.

 **CAUTION: The password features provide a basic level of security for the data on your computer.**

 **CAUTION: Anyone can access the data that is stored on your computer, when not locked and left unattended.**

 **NOTE:** System and setup password feature is disabled.

Assigning a System Setup password

Prerequisites

You can assign a new System or Admin Password only when the status is in **Not Set**.

About this task

To enter BIOS System Setup, press F2 immediately after a power-on or reboot.

Steps

1. In the **System BIOS** or **System Setup** screen, select **Security** and press Enter.
The **Security** screen is visible.
2. Select **System/Admin Password** and create a password in the **Enter the new password** field.
Use the following guidelines to assign the system password:
 - A password can have up to 32 characters.
 - At least one special character: "(! " # \$ % & ' * + , - . / : ; < = > ? @ [\] ^ _ ` { | })"
 - Numbers 0 to 9.
 - Upper case letters from A to Z.
 - Lower case letters from a to z.
3. Type the system password that you entered earlier in the **Confirm new password** field and click **OK**.
4. Press Esc and save the changes as prompted by the message.
5. Press Y to save the changes.
The computer restarts.

Deleting or changing an existing system setup password

Prerequisites

Ensure that the **Password Status** is Unlocked (in the System Setup) before attempting to delete or change the existing System and/or Setup password. You cannot delete or change an existing System or Setup password, if the **Password Status** is Locked.

About this task

To enter the System Setup, press F2 immediately after a power-on or reboot.

Steps

1. In the **System BIOS** or **System Setup** screen, select **System Security** and press Enter.
The **System Security** screen is displayed.
2. In the **System Security** screen, verify that the Password Status is **Unlocked**.
3. Select **System Password**, update, or delete the existing system password, and press Enter or Tab.
4. Select **Setup Password**, update, or delete the existing setup password, and press Enter or Tab.
 **NOTE:** If you change the System and/or Setup password, reenter the new password when prompted. If you delete the System and/or Setup password, confirm the deletion when prompted.
5. Press Esc. A message prompts you to save the changes.
6. Press Y to save the changes and exit from System Setup.
The computer restarts.

Clearing CMOS settings

About this task

 **CAUTION:** Clearing CMOS settings will reset the BIOS settings on your computer.

Steps

1. Remove the [side cover](#).
2. Remove the [coin-cell battery](#).
3. Wait for one minute.

4. Replace the [coin-cell battery](#).
5. Replace the [side cover](#).

Clearing BIOS (System Setup) and System passwords

About this task

To clear the computer or BIOS passwords, contact Dell technical support as described at [Contact Support at Dell Support Site](#).

 **NOTE:** For information about how to reset Windows or application passwords, see the documentation accompanying Windows or your application.

Troubleshooting

Dell SupportAssist Pre-boot System Performance Check diagnostics

About this task

SupportAssist diagnostics (also known as system diagnostics) performs a complete check of your hardware. The Dell SupportAssist Pre-boot System Performance Check diagnostics is embedded with the BIOS and launched by the BIOS internally. The embedded system diagnostics provides options for particular devices or device groups allowing you to:

- Run tests automatically or in an interactive mode.
- Repeat the tests.
- Display or save test results.
- Run thorough tests to introduce additional test options to provide extra information about one or more failed devices.
- View status messages that inform you the tests are completed successfully.
- View error messages that inform you of problems encountered during testing.

NOTE: Some tests for specific devices require user interaction. Always ensure that you are present at the computer terminal when the diagnostic tests are performed.

For more information, see the knowledge base article [000180971](#).

Running the SupportAssist Pre-Boot System Performance Check

Steps

1. Turn on your computer.
2. As the computer boots, press the F12 key as the Dell logo appears.
3. On the boot menu screen, select the **Diagnostics** option.
4. Click the arrow at the bottom left corner.
Diagnostics front page is displayed.
5. Click the arrow in the lower-right corner to go to the page listing.
The items that are detected are listed.
6. To run a diagnostic test on a specific device, press Esc and click **Yes** to stop the diagnostic test.
7. Select the device from the left pane and click **Run Tests**.
8. If there are any issues, error codes are displayed.
Note the error code and validation number and contact Dell.

System-diagnostic lights

This section lists the system-diagnostic lights of your OptiPlex 3000 Thin Client.

Table 21. System-diagnostic lights

Blinking pattern		Problem description
Amber	White	
1	1	TPM detection failure
1	2	Unrecoverable SPI Flash Failure
1	5	EC unable to program i-Fuse

Table 21. System-diagnostic lights (continued)

Blinking pattern		Problem description
Amber	White	
1	6	Generic catch-all for ungraceful EC code flow errors
2	1	CPU failure
2	2	System board failure (included BIOS corruption or ROM error)
2	3	No memory or RAM detected
2	4	Memory or RAM failure
2	5	Invalid memory installed
2	6	System board or Chipset Error
2	7	LCD failure (SBIOS message)
2	8	LCD failure (EC detection of power rail failure)
3	1	CMOS battery failure
3	2	PCI or Video card or chip failure
3	3	BIOS Recovery image not found
3	4	BIOS Recovery image found but invalid
3	5	Power rail failure
3	6	Flash corruption is detected by SBIOS.
3	7	Timeout waiting on ME to reply to HECI message.

NOTE: Blinking 3-3-3 LEDs on Lock LED (Caps-Lock or Num-Lock), Power button LED (without Fingerprint reader), and Diagnostic LED indicates failure to provide input during LCD panel test on Dell SupportAssist Pre-boot System Performance Check diagnostics.

Recovering the operating system

When your computer is unable to boot to the operating system even after repeated attempts, it automatically starts Dell SupportAssist OS Recovery.

Dell SupportAssist OS Recovery is a stand-alone tool that is preinstalled in all Dell computers that are installed with the Windows operating system. It consists of tools to diagnose and troubleshoot issues that may occur before your computer boots to the operating system. It enables you to diagnose hardware issues, repair your computer, back up your files, or restore your computer to its factory state.

You can also download it from the Dell Support website to troubleshoot and fix your computer when it fails to boot into their primary operating system due to software or hardware failures.

For more information about the Dell SupportAssist OS Recovery, see *Dell SupportAssist OS Recovery User's Guide* at [Serviceability Tools at the Dell Support Site](#). Click **SupportAssist** and then, click **SupportAssist OS Recovery**.

Real Time Clock—RTC reset

The Real Time Clock (RTC) reset function allows you or the service technician to recover the recently launched model Dell Latitude and Precision systems from **No POST/No Boot/No Power** situations. You can initiate the RTC reset on the system from a power-off state only if it is connected to AC power. Press and hold the power button for 25 seconds. The system RTC reset occurs after you release the power button.

NOTE: If AC power is disconnected from the system during the process or the power button is held longer than 40 seconds, the RTC reset process gets aborted.

The RTC reset will reset the BIOS to Defaults, un-provision Intel vPro and reset the system date and time. The following items are unaffected by the RTC reset:

- Service Tag
- Asset Tag
- Ownership Tag
- Admin Password
- System Password
- HDD Password
- Key Databases
- System Logs

NOTE: The IT administrator's vPro account and password on the system will be un-provisioned. The system needs to go through the setup and configuration process again to reconnect it to the vPro server.

The below items may or may not reset based on your custom BIOS setting selections:

- Boot List
- Enable Legacy Option ROMs
- Secure Boot Enable
- Allow BIOS Downgrade

Backup media and recovery options

It is recommended to create a recovery drive to troubleshoot and fix problems that may occur with Windows. Dell proposes multiple options for recovering the Windows operating system on your Dell computer. For more information, see [Dell Windows Backup Media and Recovery Options](#).

Wi-Fi power cycle

About this task

If your computer is unable to access the Internet due to Wi-Fi connectivity issues a Wi-Fi power cycle procedure may be performed. The following procedure provides the instructions on how to conduct a Wi-Fi power cycle:

NOTE: Some Internet Service Providers (ISPs) provide a modem or router combo device.

Steps

1. Turn off your computer.
2. Turn off the modem.
3. Turn off the wireless router.
4. Wait for 30 seconds.
5. Turn on the wireless router.
6. Turn on the modem.
7. Turn on your computer.

Getting help and contacting Dell

Self-help resources

You can get information and help on Dell products and services using these self-help resources:

Table 22. Self-help resources

Self-help resources	Resource location
Information about Dell products and services	Dell Site
Tips	
Contact Support	In Windows search, type <code>Contact Support</code> , and press Enter.
Online help for operating system	Linux Support Site Windows Support Site
Access top solutions, diagnostics, drivers and downloads, and learn more about your computer through videos, manuals and documents.	Your Dell computer is uniquely identified by a Service Tag or Express Service Code. To view relevant support resources for your Dell computer, enter the Service Tag or Express Service Code at Dell Support Site . For more information on how to find the Service Tag for your computer, see Locate the Service Tag on your computer .
Dell knowledge base articles for a variety of computer concerns	<ol style="list-style-type: none"> 1. Go to Dell Support Site. 2. On the menu bar at the top of the Support page, select Support > Knowledge Base. 3. In the Search field on the Knowledge Base page, type the keyword, topic, or model number, and then click or tap the search icon to view the related articles.

Contacting Dell

To contact Dell for sales, technical support, or customer service issues, see [Contact Support at Dell Support Site](#).

 **NOTE:** Availability varies by country/region and product, and some services may not be available in your country/region.

 **NOTE:** If you do not have an active Internet connection, you can find contact information about your purchase invoice, packing slip, bill, or Dell product catalog.