

Precision 5490

Owner's Manual

Notes, cautions, and warnings

 **NOTE:** A NOTE indicates important information that helps you make better use of your product.

 **CAUTION:** A CAUTION indicates either potential damage to hardware or loss of data and tells you how to avoid the problem.

 **WARNING:** A WARNING indicates a potential for property damage, personal injury, or death.

Chapter 1: Views of Precision 5490	7
Right	7
Left	8
Top	9
Front	10
Bottom	11
Service Tag	11
Battery charge and status light	12
Chapter 2: Set up your Precision 5490	13
Chapter 3: Specifications of Precision 5490	16
Dimensions and weight	16
Processor	16
Chipset	17
Operating system	17
Memory	17
External ports	18
Internal slots	18
Wireless module	18
Audio	19
Storage	19
Media-card reader	20
Keyboard	20
Keyboard shortcuts of Precision 5490	20
Camera	22
Touchpad	23
Power adapter	23
Battery	24
Display	25
Fingerprint reader	26
Sensor	26
GPU—Integrated	27
GPU—Discrete	27
Multiple display support matrix	27
Hardware security	27
Smart-card reader	28
Contactless smart-card reader	28
Contacted smart-card reader	31
Operating and storage environment	31
Dell support policy	32
ComfortView	32
Dell Optimizer	32

Chapter 4: Working inside your computer.....	34
Safety instructions.....	34
Before working inside your computer.....	34
Safety precautions.....	35
Electrostatic discharge—ESD protection.....	35
ESD Field Service kit	36
Transporting sensitive components.....	37
After working inside your computer.....	37
BitLocker.....	37
Recommended tools.....	37
Screw list.....	38
Major components of Precision 5490.....	40
Chapter 5: Removing and installing Field Replaceable Units (FRUs).....	43
Base cover.....	43
Removing the base cover.....	43
Installing the base cover.....	47
M.2 solid state drive.....	49
Removing the M.2 2230 solid state drive.....	49
Installing the M.2 2230 solid-state drive.....	51
Removing the M.2 2280 solid state drive.....	53
Installing the M.2 2280 solid state drive.....	54
Battery.....	55
Rechargeable Li-ion battery precautions.....	55
Removing the battery.....	55
Installing the battery.....	56
Processor fan.....	57
Removing the processor fan.....	57
Installing the processor fan.....	58
Graphics-card fan.....	59
Removing the graphics-card fan.....	59
Installing the graphics-card fan.....	60
Heat sink.....	61
Removing the heat sink for integrated graphics.....	61
Installing the heat sink for integrated graphics.....	62
Removing the heat sink for discrete graphics.....	63
Installing the heat sink for discrete graphics.....	64
Audio jack.....	65
Removing the audio jack.....	65
Installing the audio jack.....	66
Speakers.....	67
Removing the speaker.....	67
Installing the speaker.....	69
Smart-card reader.....	71
Removing the smart-card reader.....	71
Installing the smart-card reader.....	72
Display assembly.....	73
Removing the display assembly.....	73

Installing the display assembly.....	76
System board.....	79
Removing the system board.....	79
Installing the system board.....	84
Power button with fingerprint reader.....	90
Removing the power-button board with a fingerprint reader.....	90
Installing the power-button board with a fingerprint reader.....	91
USH-board FPC.....	92
Removing the USH-board FPC.....	92
Installing the USH-board FPC.....	92
WLAN antennas.....	93
Removing the WLAN antennas.....	93
Installing the WLAN antennas.....	95
Palm-rest and keyboard assembly.....	96
Removing the palm-rest and keyboard assembly.....	96
Installing the palm-rest and keyboard assembly.....	97
Chapter 6: Software.....	99
Operating system.....	99
Drivers and downloads.....	99
Chapter 7: Technology and components.....	100
Intel Arc Graphics.....	100
Chapter 8: BIOS Setup.....	101
Entering BIOS setup program.....	101
Navigation keys.....	101
F12 One Time Boot menu.....	101
View Advanced Setup options.....	102
View Service options.....	102
System Setup options.....	102
Updating the BIOS.....	121
Updating the BIOS in Windows.....	121
Updating the BIOS in Linux and Ubuntu.....	121
Updating the BIOS using the USB drive in Windows.....	121
Updating the BIOS from the F12 One-Time boot menu.....	122
System and setup password.....	122
Assigning a System Setup password.....	123
Deleting or changing an existing system setup password.....	123
Clearing BIOS (System Setup) and System passwords.....	124
Clearing chassis intrusion alert.....	124
Chapter 9: Troubleshooting.....	128
Handling swollen rechargeable Li-ion batteries.....	128
Locate the Service Tag or Express Service Code of your Dell computer	128
Dell SupportAssist Pre-boot System Performance Check diagnostics.....	129
Running the SupportAssist Pre-Boot System Performance Check.....	129
Built-in self-test (BIST).....	129
M-BIST.....	129

LCD Power rail test (L-BIST).....	130
LCD Built-in Self-Test (BIST).....	130
System-diagnostic lights.....	131
Recovering the operating system.....	133
Real-Time Clock (RTC Reset).....	133
Backup media and recovery options.....	133
Wi-Fi power cycle.....	133
Drain residual flea power (perform hard reset).....	133
Chapter 10: Getting help and contacting Dell.....	135

Views of Precision 5490

Right



Figure 1. Right view

1. microSD-card slot

Reads from and writes to the microSD card. The computer supports the following card types:

- micro-Secure Digital (microSD)
- micro-Secure Digital High Capacity (micro-SDHC)
- micro-Secure Digital Extended Capacity (micro-SDXC)

2. ThunderBolt 4 (40 Gbps) ports with Power Delivery and DisplayPort

Supports USB4, DisplayPort 2.1, Thunderbolt 4 and also enables you to connect to an external display using a display adapter. Provides data transfer rates of up to 40 Gbps for USB4 and Thunderbolt 4.

NOTE: You can connect a Dell Docking Station to the Thunderbolt 4 ports. For more information, see the knowledge base article [000124295](https://www.dell.com/support/000124295) at www.dell.com/support.

NOTE: A USB Type-C to DisplayPort adapter (sold separately) is required to connect a DisplayPort device.

NOTE: USB4 is backward compatible with USB 3.2, USB 2.0, and Thunderbolt 3.

NOTE: Thunderbolt 4 supports two 4K displays or one 8K display.

3. Security-cable slot (wedge-shaped)

Connect a security cable to prevent unauthorized movement of your computer.

Left



Figure 2. Left view

1. Universal audio jack

Connect headphones or a headset (headphone and microphone combo).

2. ThunderBolt 4 (40 Gbps) ports with Power Delivery and DisplayPort

Supports USB4, DisplayPort 2.1, Thunderbolt 4 and also enables you to connect to an external display using a display adapter. Provides data transfer rates of up to 40 Gbps for USB4 and Thunderbolt 4.

NOTE: You can connect a Dell Docking Station to the Thunderbolt 4 ports. For more information, see the knowledge base article [000124295](https://www.dell.com/support/000124295) at www.dell.com/support.

NOTE: A USB Type-C to DisplayPort adapter (sold separately) is required to connect a DisplayPort device.

NOTE: USB4 is backward compatible with USB 3.2, USB 2.0, and Thunderbolt 3.

NOTE: Thunderbolt 4 supports two 4K displays or one 8K display.

3. Smart card reader slot

Provides physical electronic authorization for access control to the resources.

Supports both Contactless and Contacted Smart Cards.

Provides personal identification, authentication, data storage, and application processing.

Top



Figure 3. Top view

1. Microphone

Provides digital sound input for audio recording, voice calls, and so on.

2. Power button with optional fingerprint reader

Press to turn on the computer if it is turned off, in sleep state, or in hibernation state.

When the computer is turned on, press the power button to put the computer into a sleep state; press and hold the power button for four seconds to force shut-down the computer.

If the power button has a fingerprint reader, place your finger on the power button steadily to log in.

NOTE: You can customize the power-button behavior in Windows.

3. Right speaker

Provides audio output.

4. Precision touchpad with optional NFC/contactless smart-card reader

Move your finger on the touchpad to move the mouse pointer. Tap to left-click and two fingers tap to right-click.

5. Left speaker

Provides audio output.

Front

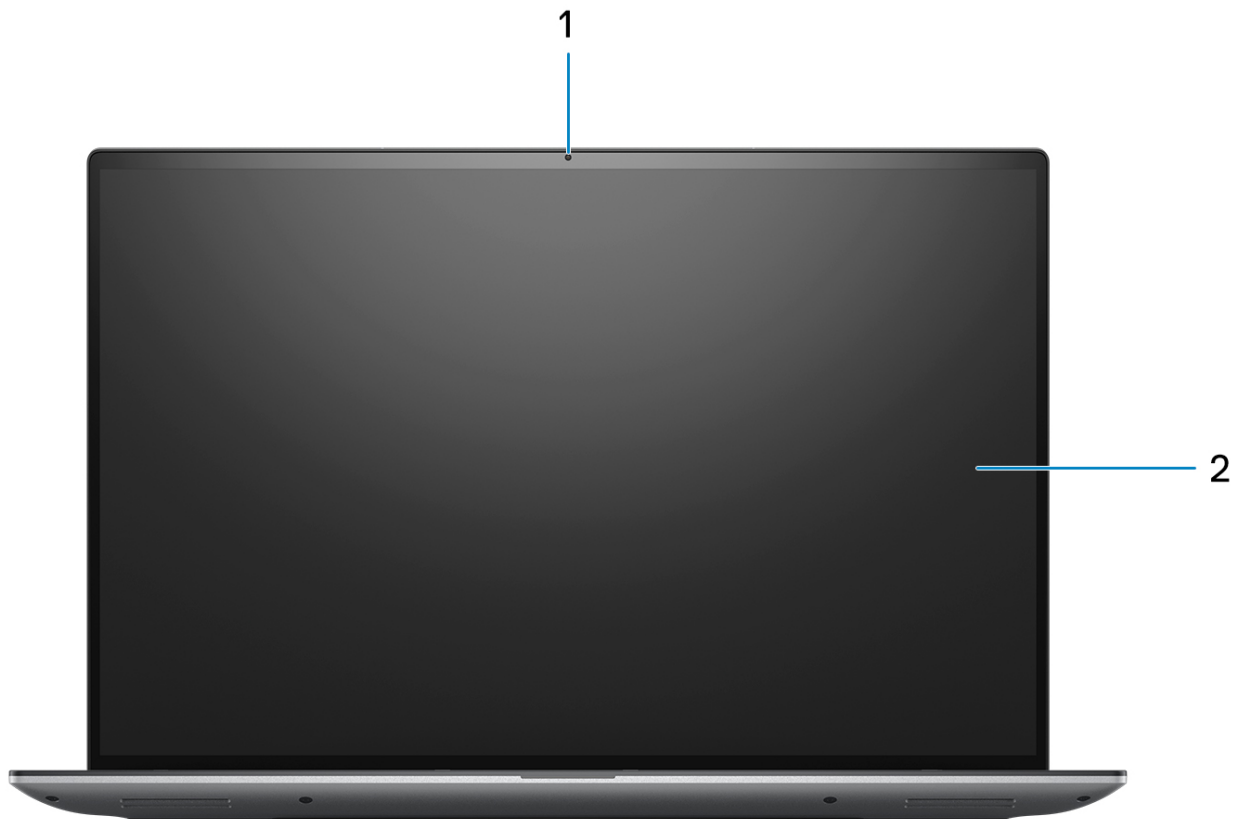

Figure 4. Front view

1. RGB camera

Enables you to video chat, capture photos, and record videos.

2. LCD panel

Provides visual output to the user.

Bottom

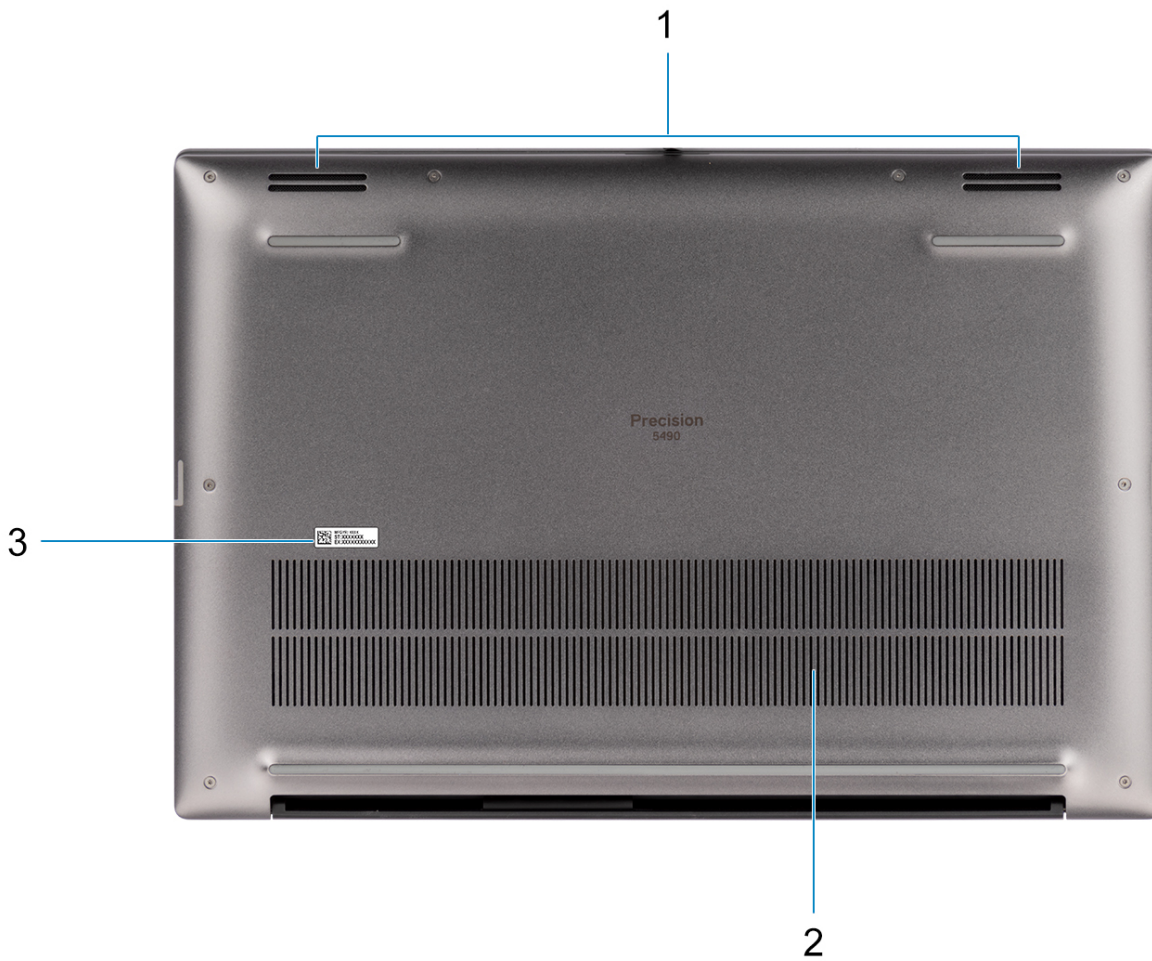

Figure 5. Bottom view

1. Speakers

Provide audio output.

2. Air vents

Air is pulled by the internal fans through the air vents.

i **NOTE:** To prevent the computer from overheating, ensure that the air vents are not blocked when the computer is running.

3. Service Tag and regulatory labels

The Service Tag is a unique alphanumeric identifier that enables Dell service technicians to identify the hardware components in your computer and access warranty information. The regulatory label contains regulatory information of your computer.

Service Tag

The service tag is a unique alphanumeric identifier that allows Dell service technicians to identify the hardware components in your computer and access warranty information.

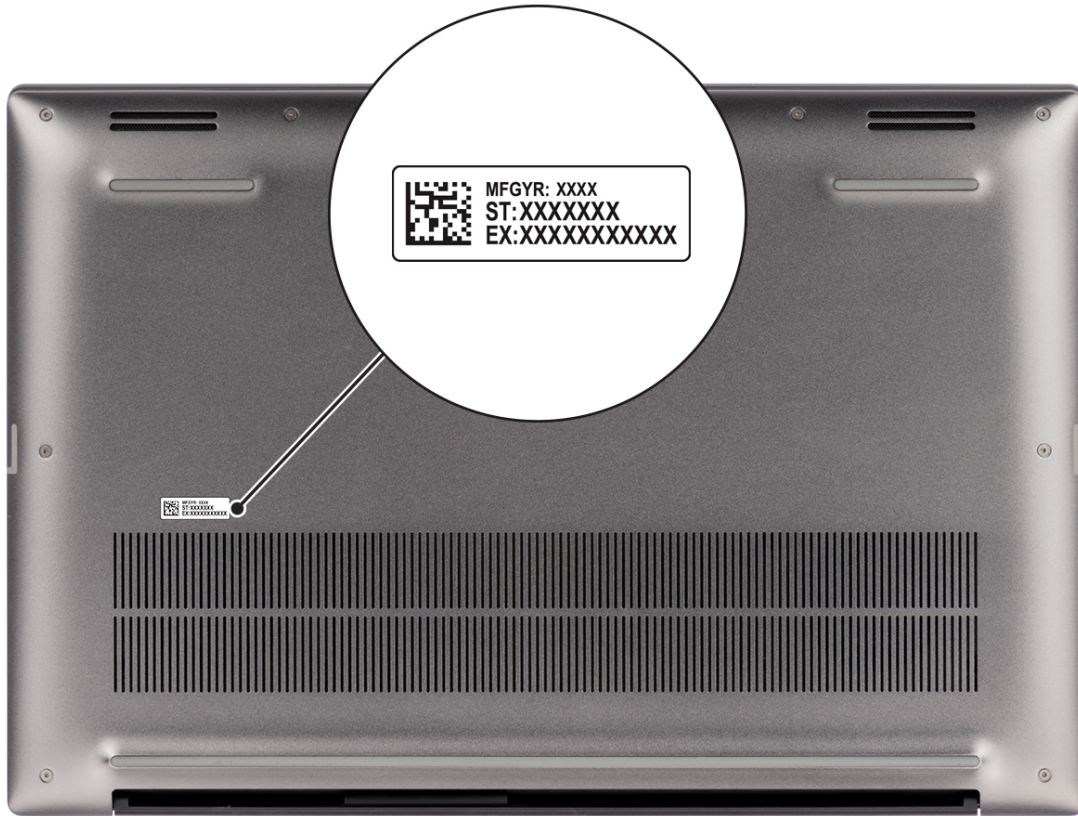

Figure 6. Service tag location

Battery charge and status light

The following table lists the battery charge and status light behavior of your Precision 5490.

Table 1. Battery charge and status light behavior

Power Source	LED Behavior	System Power State	Battery Charge Level
AC Adapter	Off	S0 - S5	Fully Charged
AC Adapter	Solid White	S0 - S5	< Fully Charged
Battery	Off	S0 - S5	11-100%
Battery	Solid Amber (590+/-3 nm)	S0 - S5	< 10%

- S0 (ON) - System is turned on.
- S4 (Hibernate) - The system consumes the least power compared to all other sleep states. The system is almost at an OFF state, except for a trickle power. The context data is written to a hard drive.
- S5 (OFF) - The system is in a shutdown state.

Set up your Precision 5490

About this task

NOTE: The images in this document may differ from your computer depending on the configuration you ordered.

Steps

1. Connect the power adapter and press the power button.



Figure 7. Connect the power adapter and press the power button.

NOTE: The battery may go into power-saving mode during shipment to conserve charge on the battery. Ensure that the power adapter is connected to your computer when it is turned on for the first time.

2. Finish the operating system setup.

For Ubuntu:

Follow the on-screen instructions to complete the setup. For more information about installing and configuring Ubuntu, search in the Knowledge Base Resource at www.dell.com/support.

For Windows:

Follow the on-screen instructions to complete the setup. When setting up, Dell Technologies recommends that you:

- Connect to a network for Windows updates.
 - ① **NOTE:** If connecting to a secured wireless network, enter the password for the wireless network access when prompted.
- If connected to the Internet, sign in with or create a Microsoft account. If not connected to the Internet, create an offline account.
- On the **Support and Protection** screen, enter your contact details.

3. Locate and use Dell apps from the Windows Start menu—Recommended.

Table 2. Locate Dell apps in Windows in S-mode



Resources	Description
	<p>Dell Product Registration</p> <p>Register your computer with Dell.</p>
	<p>Dell Help & Support</p> <p>Access help and support for your computer.</p>
	<p>SupportAssist</p> <p>SupportAssist proactively and predictively identifies hardware and software issues on your computer and automates the engagement process with Dell Technical support. It addresses performance and stabilization issues, prevents security threats, monitors, and detects hardware failures. For more information, see <i>SupportAssist for Home PCs User's Guide</i> at www.dell.com/support/home/product-support/product/dell-supportassist-pcs-tablets/docs.</p> <p>① NOTE: In SupportAssist, click the warranty expiry date to renew or upgrade your warranty.</p>

Table 3. Locate Dell apps in Windows





Resources	Description
	<p>My Dell</p> <p>MyDell is a software application that offers you a single streamlined engagement platform including account access, device information, and hardware settings. This software delivers intelligent features that automatically fine-tune your computer for the best possible audio, power, and performance. Get the most out of your Dell device with intelligent, personalized technology from MyDell. Following are the key features of MyDell:</p> <ul style="list-style-type: none"> • Application • Audio • Power • Color and Display • Presence detection <p>For more information about how to use MyDell, see product guides at www.dell.com/support.</p>
	<p>Dell Update</p> <p>Updates your computer with critical fixes and latest device drivers as they become available. For more information about using Dell Update, see the product guides and third-party license documents at www.dell.com/support.</p>
	<p>Dell Digital Delivery</p> <p>Download software applications, which are purchased but not preinstalled on your computer. For more information about using Dell Digital Delivery, search in the Knowledge Base Resource at www.dell.com/support.</p>
	<p>SupportAssist</p>

Table 3. Locate Dell apps in Windows (continued)

Resources	Description
	<p>SupportAssist proactively and predictively identifies hardware and software issues on your computer and automates the engagement process with Dell Technical support. It addresses performance and stabilization issues, prevents security threats, monitors, and detects hardware failures. For more information, see <i>SupportAssist for Home PCs User's Guide</i> at www.dell.com/support/home/product-support/product/dell-supportassist-pcs-tablets/docs.</p> <p> NOTE: In SupportAssist, click the warranty expiry date to renew or upgrade your warranty.</p>

Specifications of Precision 5490

Dimensions and weight

The following table lists the height, width, depth, and weight of your Precision 5490.

Table 4. Dimensions and weight

Description	Values
Height:	
Front height	0.29 in. (7.49 mm)
Rear height	0.74 in. (18.95 mm)
Width	12.22 in. (310.60 mm)
Depth	8.27 in. (210.35 mm)
Weight  NOTE: The weight of your computer depends on the configuration that is ordered and manufacturing variability.	3.30 lb (1.49 kg)

Processor

The following table lists the details of the processors that are supported for your Precision 5490.

Table 5. Processor

Description	Option one	Option two	Option three	Option four
Processor type	Intel Core Ultra 9 185H vPro	Intel Core Ultra 7 165H vPro	Intel Core Ultra 7 155H vPro Essentials	Intel Core Ultra 5 135H vPro
Processor wattage	45 W	45 W	45 W	45 W
Processor core count	16	16	16	14
Processor thread count	22	22	22	18
Processor speed	Up to 5.10 GHz	Up to 5.00 GHz	Up to 4.80 GHz	Up to 4.60 GHz
Processor cache	24 MB	24 MB	24 MB	18 MB
Integrated graphics	Intel Arc Graphics	Intel Arc Graphics	Intel Arc Graphics	Intel Arc Graphics

Chipset

The following table lists the details of the chipset that is supported for your Precision 5490.

Table 6. Chipset

Description	Values
Chipset	Intel MTL-H
Processor	Intel Core Ultra 5/7/9
DRAM bus width	64-bit
Flash EPROM	64 MB
PCIe bus	Up to Gen4.0

Operating system

Your Precision 5490 supports the following operating systems:

- Windows 11 23H2
- Windows 11 22H2
- Windows 10 22H2
- Ubuntu Linux 22.04, 64-bit

Memory

The following table lists the memory specifications of your Precision 5490.

Table 7. Memory specifications

Description	Values
Memory slots	Integrated on system board
Memory type	LPDDR5x
Memory speed	7467 MT/s
Maximum memory configuration	64 GB
Minimum memory configuration	16 GB
Memory configurations supported	<ul style="list-style-type: none">• 16 GB: LPDDR5x, 7467 MT/s, dual-channel (onboard)• 32 GB: LPDDR5x, 7467 MT/s, dual-channel (onboard)• 64 GB: LPDDR5x, 7467 MT/s, dual-channel (onboard)

External ports

The following table lists the external ports on your Precision 5490.

Table 8. External ports

Description	Values
USB ports	Four ThunderBolt 4 (40 Gbps) ports with Power Delivery and DisplayPort
Audio port	One headset (headphone and microphone combo) port
Video port/ports	Thunderbolt 4 ports with DisplayPort (USB Type-C)
Media-card reader	One microSD-card slot
Power-adaptor port	USB Type-C
Security-cable slot	One wedge-shaped lock slot

Internal slots

The following table lists the internal slots of your Precision 5490.

Table 9. Internal slots

Description	Values
M.2	M.2 2230/2280 solid-state drive  NOTE: To learn more about the features of different types of M.2 cards, search in the Knowledge Base Resource at www.dell.com/support .

Wireless module

The following table lists the Wireless Local Area Network (WLAN) module that is supported on your Precision 5490.

Table 10. Wireless module specifications

Description	Values
Model number	Intel BE200
Transfer rate	Up to 5760 Mbps
Frequency bands supported	2.4 GHz/5 GHz/6 GHz  NOTE: The 6 GHz frequency is supported on computers installed with Windows 11 operating system only.
Wireless standards	<ul style="list-style-type: none">• WiFi 802.11a/b/g• Wi-Fi 4 (Wi-Fi 802.11n)• Wi-Fi 5 (WiFi 802.11ac)• Wi-Fi 6E (WiFi 802.11ax)• Wi-Fi 7 (WiFi 802.11be)
Encryption	<ul style="list-style-type: none">• 64-bit and 128-bit WEP

Table 10. Wireless module specifications (continued)

Description	Values
	<ul style="list-style-type: none"> • AES-CCMP • TKIP
Bluetooth wireless card	Bluetooth 5.4 wireless card
	<p>i NOTE: The version of the Bluetooth wireless card may vary depending on the operating system that is installed on your computer.</p>

Audio

The following table lists the audio specifications of your Precision 5490.

Table 11. Audio specifications

Description	Values	
Audio controller	Realtek ALC713	
Stereo conversion	Supported	
Internal audio interface	SoundWire	
External audio interface	One headset (headphone and microphone combo) port	
Number of speakers	Four (Two tweeter speakers and two woofer speakers)	
Internal-speaker amplifier	Realtek ALC1319D	
External volume controls	Keyboard shortcut controls	
Speaker output:		
	Average speaker output	2 W + 2 W (tweeter), 2 W + 2 W (woofer)
	Peak speaker output	2.5 W + 2.5 W (tweeter), 2.5 W + 2.5 W (woofer)
Subwoofer output	Supported	
Microphone	Dual digital-array microphones	

Storage

This section lists the storage options on your Precision 5490.

- M.2 2230, Gen 4 PCIe NVMe, SSD, Class 35
- M.2 2280, Gen 4 PCIe NVMe, SSD, Class 40
- M.2 2280, Gen 4 PCIe NVMe, SSD, Self Encrypting Opal 2.0, Class 40

Table 12. Storage specifications

Storage type	Interface type	Capacity
M.2 2230 Class 35 SSD	PCIe NVMe Gen4 x4	256 GB
M.2 2280 Class 40 SSD	PCIe NVMe Gen4 x4	Up to 4 TB

Table 12. Storage specifications (continued)

Storage type	Interface type	Capacity
M.2 2280 Class 40 Self Encrypting Opal 2.0	PCIe NVMe Gen4 x4	Up to 1 TB

Media-card reader

The following table lists the media cards that are supported on your Precision 5490.

Table 13. Media-card reader specifications

Description	Values
Media-card type	microSD card
Media-cards supported	<ul style="list-style-type: none">• micro-Secure Digital (SD)• micro-Secure Digital High Capacity (SDHC)• micro-Secure Digital Extended Capacity (SDXC)
 NOTE: The maximum capacity supported by the media-card reader varies depending on the standard of the media card that is installed on your computer.	

Keyboard

The following table lists the keyboard specifications of your Precision 5490.

Table 14. Keyboard specifications

Description	Values
Keyboard type	Backlit keyboard
Keyboard layout	QWERTY
Number of keys	<ul style="list-style-type: none">• United States and Canada: 79 keys• United Kingdom: 80 keys• Japan: 83 keys
Keyboard size	X=19.05 mm key pitch Y=18.05 mm key pitch
Keyboard shortcuts	<p>Some keys on your keyboard have two symbols on them. These keys can be used to type alternate characters or to perform secondary functions. To type the alternate character, press Shift and the desired key. To perform secondary functions, press Fn and the desired key.</p> <p> NOTE: You can define the primary behavior of the function keys (F1–F12) changing Function Key Behavior in BIOS setup program.</p>

Keyboard shortcuts of Precision 5490

 **NOTE:** Keyboard characters may differ depending on the keyboard language configuration. Keys that are used for shortcuts remain the same across all language configurations.

Some keys on your keyboard have two symbols on them. These keys can be used to type alternate characters or to perform secondary functions. The symbol that is shown on the lower part of the key refers to the character that is typed out when the key is pressed. If you press shift and the key, the symbol that is shown on the upper part of the key is typed out. For example, if you press **2**, **2** is typed out; if you press **Shift + 2**, **@** is typed out.

The keys F1-F12 at the top row of the keyboard are function keys for multimedia control, as indicated by the icon at the bottom of the key. Press the function key to invoke the task represented by the icon. For example, pressing F1 mutes the audio (refer to the table below).

However, if the function keys F1-F12 are needed for specific software applications, multimedia functionality can be disabled by pressing **Fn + Esc**. Later, multimedia control can be invoked by pressing **Fn** and the respective function key. For example, mute audio by pressing **Fn + F1**.

i **NOTE:** You can also define the primary behavior of the function keys (F1–F12) by changing **Function Key Behavior** in BIOS setup program.

Table 15. List of keyboard shortcuts

Keyboard shortcut	Behavior
Copilot	Launch Copilot in Windows i NOTE: If Copilot in Windows is not available on your computer, the Copilot key launches Windows Search. For more information about Copilot in Windows, search in the Knowledge Base Resource at www.dell.com/support .
F1	Mute audio
F2	Decrease volume
F3	Increase volume
F4	Play the previous track or chapter
F5	Play or Pause
F6	Play the next track or chapter
F8	Switch to external display
F9	Search
F10	Click keyboard backlight (optional). i NOTE: Non-backlight keyboards have the F10 function key without the backlight icon and do not support the toggle keyboard backlight function. i NOTE: Toggle to cycle the keyboard backlight status through off, low-backlight, and high-backlight.
F11	Decrease brightness
F12	Increase brightness

The **Fn** key is also used with selected keys on the keyboard to invoke other secondary functions.

Table 16. Secondary behavior

Function key	Secondary behavior
Fn + F1	Operating system and application-specific F1 behavior
Fn + F2	Operating system and application-specific F2 behavior
Fn + F3	Operating system and application-specific F3 behavior
Fn + F4	Operating system and application-specific F4 behavior
Fn + F5	Operating system and application-specific F5 behavior
Fn + F6	Operating system and application-specific F6 behavior

Table 16. Secondary behavior (continued)

Function key	Secondary behavior
Fn + F8	Operating system and application-specific F8 behavior
Fn + F9	Operating system and application-specific F9 behavior
Fn + F10	Operating system and application-specific F10 behavior
Fn + F11	Operating system and application-specific F11 behavior
Fn + F12	Operating system and application-specific F12 behavior
Fn + PrtScr	Turn off or on wireless
Fn + B	Pause or Break
Fn + Insert	Sleep
Fn + S	Toggle scroll lock
Fn + H	Toggle between power and battery-status light or hard drive activity light
Fn + R	System request
Fn + Ctrl	Open the application menu
Fn + Esc	Toggle Fn-key lock
Fn + PgUp	Page up
Fn + PgDn	Page down
Fn + Home	Home
Fn + End	End

Camera

The following table lists the camera specifications of your Precision 5490.

Table 17. Camera specifications

Description	Values
Number of cameras	One
Camera type	HD RGB and IR camera
Camera location	Front camera
Camera sensor type	CMOS sensor technology
Camera resolution:	
Still image	0.92 megapixel
Video	1280 x 720 (HD) at 30 fps
Infrared camera resolution:	
Still image	0.25 megapixel
Video	640 x 400 at 30 fps
Diagonal viewing angle:	

Table 17. Camera specifications (continued)

Description		Values
	Camera	75.8 degrees
	Infrared camera	75.8 degrees

Touchpad

The following table lists the touchpad specifications of your Precision 5490.

Table 18. Touchpad specifications

Description		Values
Touchpad resolution:		
	Horizontal	>300 dpi
	Vertical	761
Touchpad dimensions:		
	Horizontal	105.95 mm (4.17 in.)
	Vertical	65.30 mm (2.57 in.)
Touchpad gestures		For more information about touchpad gestures available on Windows, see the Microsoft Knowledge Base article at support.microsoft.com .

Power adapter

The following table lists the power adapter specifications of your Precision 5490.

Table 19. Power adapter specifications

Description	Option one	Option two
Type	100 W AC adapter, USB-C (UMA only)	130 W AC adapter, USB-C (Discrete only)
Power-adapter dimensions:		
Height	26.50 mm (1.04 in.)	22.00 mm (0.87 in.)
Width	60.00 mm (2.36 in.)	66.00 mm (2.60 in.)
Depth	122.00 mm (4.80 in.)	143.00 mm (5.63 in.)
Input voltage	100 VAC to 240 VAC	100 VAC to 240 VAC
Input frequency	50 Hz to 60 Hz	50 Hz to 60 Hz
Input current (maximum)	1.7 A	1.80 A
Output current (continuous)	<ul style="list-style-type: none"> • 20 V/5 A (Continuous) • 15 V/3 A (Continuous) • 9 V/3 A (Continuous) • 5 V/3 A (Continuous) 	<ul style="list-style-type: none"> • 20 V/6.50 A (Continuous) • 5 V/1 A (Continuous)

Table 19. Power adapter specifications (continued)

Description		Option one	Option two
Rated output voltage		<ul style="list-style-type: none"> • 20 VDC • 15 VDC • 9 VDC • 5 VDC 	<ul style="list-style-type: none"> • 20 VDC • 5 VDC
Temperature range:			
	Operating	0°C to 40°C (32°F to 104°F)	0°C to 40°C (32°F to 104°F)
	Storage	-40°C to 70°C (-40°F to 158°F)	-40°C to 70°C (-40°F to 158°F)
 CAUTION: Operating and storage temperature ranges may differ among components, so operating or storing the device outside these ranges may impact the performance of specific components.			

Battery

The following table lists the battery specifications of your Precision 5490.

Table 20. Battery specifications

Description		Values
Battery type		4-cell, 72 Wh, ExpressCharge Capable, Long Life Cycle
Battery voltage		15.40 VDC
Battery weight (maximum)		0.285 kg (0.63 lb)
Battery dimensions:		
	Height	8.25 mm (0.32 in.)
	Width	255.20 mm (10.05 in.)
	Depth	65.70 mm (2.59 in.)
Temperature range:		
	Operating	<ul style="list-style-type: none"> • Charge: 0°C to 50°C (32°F to 122°F) • Discharge: 0°C to 70°C (32°F to 158°F)
	Storage	-20°C to 60°C (-4°F to 140°F)
Battery operating time		Varies depending on operating conditions and can significantly reduce under certain power-intensive conditions.
Battery charging time (approximate)  NOTE: Control the charging time, duration, start and end time, and so on, using the Dell Power Manager application. For more information about Dell Power Manager, search in the Knowledge Base Resource at www.dell.com/support .		Express Charge Method: <ul style="list-style-type: none"> • 0 - 15°C maximum allowable charge time from 0 to 100% RSOC is 4 hours • 16 - 45°C normal express charge • 46 - 50°C maximum allowable charge time from 0 to 100% RSOC is 3 hours Standard Charge/Predominately AC User Charge Method: <ul style="list-style-type: none"> • 0 - 15°C maximum allowable charge time from 0 to 100% RSOC is 4 hours • 16 - 50°C maximum allowable charge time from 0 to 100% RSOC is 3 hours

Table 20. Battery specifications (continued)

Description	Values
	Express Charge Boost Charge Method (Fast Charge for Initial 35%): <ul style="list-style-type: none"> 16 - 45°C target charge time from 0 to 35% RSOC is 20 mins for Accelerated Charge
Coin-cell battery	No coin-cell. Supported by main battery
<p>⚠ CAUTION: Operating and storage temperature ranges may differ among components, so operating or storing the device outside these ranges may impact the performance of specific components.</p> <p>⚠ CAUTION: Dell Technologies recommends that you charge the battery regularly for optimal power consumption. If your battery charge is depleted, connect the power adapter, turn on your computer, and then restart your computer to reduce the power consumption.</p>	

Display

The following table lists the display specifications of your Precision 5490.

Table 21. Display specifications

Description	Option one	Option two
Display type	14-inch Full High Definition+ (FHD+)	14-inch Quad High Definition (QHD+)
Touch options	No	Yes with active pen support
Display-panel technology	Wide-viewing angle (WVA) narrow bent, TÜV low blue light	Wide-viewing angle (WVA), WLED, TÜV low blue light
Display-panel dimensions (active area):		
	Height	188.49 mm (7.42 in.)
	Width	301.59 mm (11.87 in.)
	Diagonal	355.6 mm (14.00 in.)
Display-panel native resolution	1920 x 1200	2560 x 1600
Luminance (typical)	500 nits	500 nits
Megapixels	2.30	4.09
Color gamut	100% sRGB	100% sRGB
Pixels Per Inch (PPI)	161 ppi	216 PPI
Contrast ratio (minimum)	1000:1	1000:1
Response time (maximum)	35 ms	35 ms
Refresh rate	60 Hz	60 Hz
Horizontal view angle	+/- 88 degrees	+/- 88 degrees
Vertical view angle	+/- 88 degrees	+/- 88 degrees

Table 21. Display specifications (continued)

Description	Option one	Option two
Pixel pitch	0.1578 mm	0.1178 mm
Power consumption (maximum)	2.80 W	3.35 W
Anti-glare vs glossy finish	Anti-glare	Anti-Reflection and Anti-Smudge on touch screen

Fingerprint reader

The following table lists the fingerprint-reader specifications of your Precision 5490.

 **NOTE:** The fingerprint reader is on the power button.

Table 22. Fingerprint reader specifications

Description	Values
Fingerprint-reader sensor technology	Capacitive
Fingerprint-reader sensor resolution	500 dpi
Fingerprint-reader sensor pixel size	<ul style="list-style-type: none">• X: 108• Y: 88

Sensor

The following table lists the sensor of your Precision 5490.

Table 23. Sensor

Sensor support
Ambient Light Sensor
Windows Auto Brightness
IR User Proximity Detection
Clover Falls+
Accelerometer
Adaptive Thermal Performance (Lap vs. Desk mode) requires Gyro/Accelerometer
 NOTE: This is for thermal only.
Hall Effect Sensor
Sensor Hub (integrated)

GPU—Integrated

The following table lists the specifications of the integrated Graphics Processing Unit (GPU) supported by your Precision 5490.

Table 24. GPU—Integrated

Controller	Memory size	Processor
Intel Arc Graphics	Shared system memory	Intel Core Ultra 5/7/9

GPU—Discrete

The following table lists the specifications of the discrete Graphics Processing Unit (GPU) supported by your Precision 5490.

Table 25. GPU—Discrete

Controller	Memory size	Memory type
NVIDIA RTX 1000 Ada Generation Laptop GPU	6 GB	GDDR6
NVIDIA RTX 2000 Ada Generation laptop GPU	8 GB	GDDR6
NVIDIA RTX 3000 Ada Generation laptop GPU	8 GB	GDDR6

Multiple display support matrix

The following table lists the multiple display support matrix for your Precision 5490.

Table 26. Multiple display support matrix

Graphics Card	Direct Graphics Controller Direct Output Mode	Supported external displays with computer internal display on	Supported external displays with computer internal display off
Intel Arc Graphics	Integrated	3	4

Hardware security

The following table lists the hardware security of your Precision 5490.

Table 27. Hardware security

Hardware security
Wedge-shaped lock slot
Chassis Intrusion Prevention Lock
TPM 2.0 discrete
FIPS 140-3 certification for TPM
Trusted Computing Group (TCG) Certification for TPM
No-TPM option (BIOS Disable TPM/BIOS KillTPM/Main TPM for Russia)
ControlVault 3 Advanced Authentication with FIPS 140-3 Level 3 Certification

Table 27. Hardware security (continued)

Hardware security
Fingerprint Reader
Contacted Smart Card and ControlVault 3
Contactless Smart Card, NFC, and ControlVault 3
SED SSD NVMe
Battery Removal Detection
RPMC (specify through SPI Flash or eRPMC)
SPI Flash Tamper Detection/Prevention Shunt Circuit
Board Level Shield Tamper Detection

Smart-card reader

Contactless smart-card reader

This section lists the contactless smart-card reader specifications of your Precision 5490. This module is only available in computers shipped with Smart-card readers.

Table 28. Contactless smart-card reader specifications

Title	Description	Dell ControlVault 3 contactless smart-card reader with NFC
Felica Card Support	Reader and software capable of supporting Felica contactless cards	Yes
Prox (Proximity) (125kHz) Card support	Reader and software capable of supporting Prox /Proximity/125kHz contactless cards	No
ISO 14443 Type A Card Support	Reader and software capable of supporting ISO 14443 Type A contactless cards	Yes
ISO 14443 Type B Card Support	Reader and software capable of supporting ISO 14443 Type B contactless cards	Yes
ISO/IEC 21481	Reader and software capable of supporting ISO/IEC 21481 compliant contactless cards and tokens	Yes
ISO/IEC 18092	Reader and software capable of supporting ISO/IEC 21481 compliant contactless cards and tokens	Yes
ISO 15693 Card Support	Reader and software capable of supporting ISO15693 contactless cards	Yes
NFC Tag Support	Supports reading and processing of NFC compliant tag information	Yes
NFC Reader Mode	Support for NFC Forum Defined Reader mode	Yes
NFC Writer Mode	Support for NFC Forum Defined Writer mode	Yes

Table 28. Contactless smart-card reader specifications (continued)

Title	Description	Dell ControlVault 3 contactless smart-card reader with NFC
NFC Peer-to-Peer Mode	Support for NFC Forum Defined Peer to Peer mode	Yes
NFC Proximity OS Interface	Enumerates NFP (Near Field Proximity) device for OS to utilize	Yes
PC/SC OS interface	Personal Computer/Smart Card specification for integration of hardware readers into personal computer environments	Yes
CCID driver compliance	Common driver support for Integrated Circuit Card Interface Device for OS level drivers	Yes
Dell ControlVault support	Device connects to Dell ControlVault for usage and processing	Yes

 **NOTE:** 125 Khz proximity cards are not supported.

Table 29. Supported cards

Manufacturer	Card
HID	jCOP readertest3 A card (14443a)
	1430 1L
	DESFire D8H
	DESFIRE 4K Standard - 1450NGGNN
	iClass 16K/16 - 2002PGGMN
	iClass SR 16K/16 - 2002HPGGMN
	iCLASS 2K tag
	iCLASS GP - 2003 PGGMN
	iClass Clamshell - 2080PMSMV
	iClass Prox 16K/16 - 2022BGGMNN
	Mifare M1P 1430 NGGNN
	iclass Prox 2020BGGMNM
	DesFire D8P 1456CSGMN
	iCLASS MIFARE Px GM49Y 2623BNPGGBNAB
	iCLASS MIFARE Px 8M1L
	iClass SEOS JW 5006PGGMN
	Crescendo iCLASS Px G8H
	iCLASS Seos IY
	SEOS JMC4 J1Y 5806VNG1NNN4
	SEOS Key FOB 5266PNNA
SEOS Clamshell 5656PMSAV	
SEOS + Prox 5106RGGMNN	
SEOS + DESFire 5906PNG1ANN7	

Table 29. Supported cards (continued)

Manufacturer	Card
	SEOS iClass 5006PGGMN7
	Seos Essential + Prox 551PPGGANN
	iCLASS 2K 2000PGGMN
	iCLASS 2K 3000PGGMN
	MIFARE DESFire 3700CPGGAN
	iCLASS DP
	DESFire 1Y
NXP/Mifare	Mifare DESFire 8K White PVC Cards
	Mifare Classic 1K White PVC Cards
	Mifare Mifare S50 ISO Cards
	Mifare DESFire 2K
	Mifare Plus S 2K/4K
	Mifare Plus X 4K
G&D	idOnDemand - SCE3.2 144K
	SCE6.0 FIPS 80K Dual+ 1 K Mifare
	SCE6.0 nonFIPS 80K Dual+ 1 K Mifare
	SCE6.0 FIPS 144K Dual + 1K Mifare
	SCE6.0 nonFIPS 144K Dual + 1 K Mifare
	SCE7.0 FIPS 144K
Oberthur	idOnDemand - OCS5.2 80K
	ID-One Cosmo 64 RSA D V5.4 T=0 card
	ID-One Cosmo 128K V5.5 card
Gemalto	TOP DL GX4 144K card
Sony	Felica RC-S962
	Felica RC-S965
	Felica RC-S966
PIVKey	C910 PKI
NIST	PIV1
IDENTIV	PIV programmed cards
	uTrust
Transport cards	Oyster (London) MIFARE DESFire
	T-Money (Korea)
	Octopus Card (Hong Kong)
	SUICA (Japan)

Contacted smart-card reader

The following table lists the contacted smart-card reader specifications of your Precision 5490.

Table 30. Contacted smart-card reader specifications

Title	Description	Dell ControlVault 3 smart-card reader
ISO 7816 -3 Class A Card Support	Reader capable of reading 5V powered smart mcard	Yes
ISO 7816 -3 Class B Card Support	Reader capable of reading 3V powered smart card	Yes
ISO 7816 -3 Class C Card support	Reader capable of reading 1.8V powered smart card	Yes
ISO 7816-1 Compliant	Specification for the reader	Yes
ISO 7816 -2 Compliant	Specification for smart card device physical characteristics (size, location of connection points, etc.)	Yes
ISO 7816-3 Compliant	Specification for electrical interface and transmission protocols	Yes
ISO 7816-4 Compliant	Specification for organization, security and commands for interchange	Yes
Dell ControlVault support	Device connects to Dell ControlVault for usage and processing	Yes
T=0 support	Cards support character level transmission	Yes
T=1 support	Cards support block level transmission	Yes
EMVCo Certified	Formally certified based on EMVCO smart card standards	Yes
PC/SC OS interface	Personal Computer/Smart Card specification for integration of hardware readers into personal computer environments	Yes
CCID driver compliance	Common driver support for Integrated Circuit Card Interface Device for OS level drivers.	Yes
Windows Certified	Device certified by WHCK	Yes
FIPS 201 (PIV/HSPD-12) Compliant via GSA	Device compliant with FIPS 201/PIV/HSPD-12 requirements	Yes

Operating and storage environment

This table lists the operating and storage specifications of your Precision 5490.

Airborne contaminant level: G1 as defined by ISA-S71.04-1985

Table 31. Computer environment

Description	Operating	Storage
Temperature range	0°C to 35°C (32°F to 95°F)	-40°C to 65°C (-40°F to 149°F)
Relative humidity (maximum)	10% to 90% (non-condensing)	0% to 95% (non-condensing)

Table 31. Computer environment (continued)

Description	Operating	Storage
Vibration (maximum)*	0.66 GRMS	1.30 GRMS
Shock (maximum)	110 G†	160 G†
Altitude range	-15.2 m to 3048 m (49.87 ft to 10000 ft)	-15.2 m to 10668 m (49.87 ft to 35000 ft)
 CAUTION: Operating and storage temperature ranges may differ among components, so operating or storing the device outside these ranges may impact the performance of specific components.		

* Measured using a random vibration spectrum that simulates the user environment.

† Measured using a 2 ms half-sine pulse.

Dell support policy

For information about Dell support policy, search in the Knowledge Base Resource at www.dell.com/support.

ComfortView

 **WARNING: Prolonged exposure to blue light from the display may lead to long-term effects such as eye strain, eye fatigue, or damage to the eyes.**

Blue light is a color in the light spectrum which has a short wavelength and high energy. Chronic exposure to blue light, particularly from digital sources, may disrupt sleep patterns and cause long-term effects such as eye strain, eye fatigue, or damage to the eyes.

ComfortView mode can be enabled and configured using the Dell CinemaColor application.

ComfortView mode complies with TÜV Rheinland's requirement for low blue light displays.

Low blue light: Dell ComfortView software technology reduces harmful blue light emissions to make extended screen time easy on your eyes.

To reduce the risk of eye strain, it is also recommended that you:

- Position the display at a comfortable viewing distance between 20 and 28 inches (50 cm and 70 cm) from your eyes.
- Blink frequently to moisten your eyes, wet your eyes with water, or apply suitable eye drops.
- Look away from your display, and gaze at a distant object at 20 ft (609.60 cm) away for at least 20 seconds during each break.
- Take an extended break for 20 minutes every two hours.

Dell Optimizer

This section details the Dell Optimizer specifications of your Precision 5490.

Dell Optimizer is a software application that intelligently optimizes the performance of your computer by using artificial intelligence and machine learning. Dell Optimizer dynamically configures your computer settings to optimize the performance of your applications. It improves the productivity, performance, and user experience through computer usage analysis and learning.

On Precision 5490 with Dell Optimizer, the following features are supported:

- Improves user experience through computer usage analysis and learning
- Faster application launch and seamless application transition
- Intelligent battery run-time extension
- Optimized Audio for best meeting experience
- Locks computer when walks away for enhanced security











- Faster computer wake-on-user approach
- Intelligently shows alerts
- Updates automatically to minimize disruption

For more information about configuring and using these features, search for the Dell Optimizer User Guide at www.dell.com/support.

Working inside your computer



Safety instructions

Use the following safety guidelines to protect your computer from potential damage and to ensure your personal safety. Unless otherwise noted, each procedure in this document assumes that you have read the safety information that shipped with your computer.

-  **WARNING:** Before working inside your computer, read the safety information that is shipped with your computer. For more safety best practices, see the Regulatory Compliance home page at www.dell.com/regulatory_compliance.
-  **WARNING:** Disconnect your computer from all power sources before opening the computer cover or panels. After you finish working inside the computer, replace all covers, panels, and screws before connecting your computer to an electrical outlet.
-  **CAUTION:** To avoid damaging the computer, ensure that the work surface is flat, dry, and clean.
-  **CAUTION:** To avoid damaging the components and cards, handle them by their edges, and avoid touching the pins and the contacts.
-  **CAUTION:** You should only perform troubleshooting and repairs as authorized or directed by the Dell technical assistance team. Damage due to servicing that is not authorized by Dell is not covered by your warranty. See the safety instructions that is shipped with the product or at www.dell.com/regulatory_compliance.
-  **CAUTION:** Before touching anything inside your computer, ground yourself by touching an unpainted metal surface, such as the metal at the back of the computer. While you work, periodically touch an unpainted metal surface to dissipate static electricity which could harm internal components.
-  **CAUTION:** When you disconnect a cable, pull it by its connector or its pull tab, not the cable itself. Some cables have connectors with locking tabs or thumbscrews that you must disengage before disconnecting the cable. When disconnecting cables, keep them evenly aligned to avoid bending the connector pins. When connecting cables, ensure that the ports and the connectors are correctly oriented and aligned.
-  **CAUTION:** Press and eject any installed card from the media-card reader.
-  **CAUTION:** Exercise caution when handling rechargeable Li-ion batteries in laptops. Swollen batteries should not be used and should be replaced and disposed properly.
-  **NOTE:** The color of your computer and certain components may differ from what is shown in this document.

Before working inside your computer

Steps

1. Save and close all open files and exit all open applications.
2. Shut down your computer. For Windows operating system, click **Start** >  **Power** > **Shut down**.
 -  **NOTE:** If you are using a different operating system, see the documentation of your operating system for shut-down instructions.
3. Disconnect your computer and all attached devices from their electrical outlets.
4. Disconnect all attached network devices and peripherals, such as keyboard, mouse, and monitor from your computer.

5. Remove any media card and optical disk from your computer, if applicable.
6. Enter the service mode, if you can turn on your computer.

Service Mode

Service Mode is used to cut off power, without disconnecting the battery cable from the system board prior to conducting repairs in the computer.

 **CAUTION:** If you are unable to turn on the computer to put it into Service Mode, or the computer does not support Service Mode, proceed to disconnect the battery cable. To disconnect the battery cable, follow the steps in [Removing the battery](#).

 **NOTE:** Ensure that your computer is shut down and the AC adapter is disconnected.

- a. Hold the **** key on the keyboard and press the power button for 3 seconds or until the Dell logo appears on the screen.
- b. Press any key to continue.
- c. If the AC adapter is not disconnected, a message prompting you to remove the AC adapter appears on the screen. Remove the AC adapter and then press any key to continue the **Service Mode** process. The **Service Mode** process automatically skips the following step if the **Owner Tag** of the computer is not set up in advance by the user.
- d. When the **ready-to-proceed** message appears on the screen, press any key to proceed. The computer emits three short beeps and shuts down immediately.
- e. Once the computer shuts down, it has successfully entered Service Mode.

 **NOTE:** If you are unable to turn on your computer or unable to enter Service Mode, skip this process.

Safety precautions

The safety precautions chapter details the primary steps to be taken before performing any disassembly instructions.

Observe the following safety precautions before you perform any installation or break-fix procedures involving disassembly or reassembly:

- Turn off the computer and all attached peripherals.
- Disconnect the computer and all attached peripherals from AC power.
- Disconnect all network cables, telephone, and telecommunications lines from the computer.
- Use an ESD field service kit when working inside any notebook to avoid electrostatic discharge (ESD) damage.
- After removing any computer component, carefully place the removed component on an anti-static mat.
- Wear shoes with non-conductive rubber soles to reduce the chance of getting electrocuted.
- Unplugging, pressing, and holding the power button for 15 seconds should discharge residual power in the system board.

Standby power

Dell products with standby power must be unplugged before you open the case. Systems that incorporate standby power are powered while turned off. The internal power enables the computer to be remotely turned on (Wake-on-LAN) and suspended into a sleep mode and has other advanced power management features.

Bonding

Bonding is a method for connecting two or more grounding conductors to the same electrical potential. This is done by using a field service electrostatic discharge (ESD) kit. When connecting a bonding wire, ensure that it is connected to bare metal and never to a painted or nonmetal surface. The wrist strap should be secure and in full contact with your skin, and ensure that you remove all jewelry such as watches, bracelets, or rings prior to bonding yourself and the equipment.

Electrostatic discharge—ESD protection

ESD is a major concern when you handle electronic components, especially sensitive components such as expansion cards, processors, memory modules, and system boards. Slight charges can damage circuits in ways that may not be obvious, such as intermittent problems or a shortened product life span. As the industry pushes for lower power requirements and increased density, ESD protection is an increasing concern.

Due to the increased density of semiconductors used in recent Dell products, the sensitivity to static damage is now higher than in previous Dell products. For this reason, some previously approved methods of handling parts are no longer applicable.

Two recognized types of ESD damage are catastrophic and intermittent failures.

- **Catastrophic** – Catastrophic failures represent approximately 20 percent of ESD-related failures. The damage causes an immediate and complete loss of device functionality. An example of catastrophic failure is a memory DIMM that has received a static shock and immediately generates a "No POST/No Video" symptom with a beep code that is emitted for missing or nonfunctional memory.
- **Intermittent** – Intermittent failures represent approximately 80 percent of ESD-related failures. The high rate of intermittent failures means that most of the time when damage occurs, it is not immediately recognizable. The DIMM receives a static shock, but the tracing is merely weakened and does not immediately produce outward symptoms that are related to the damage. The weakened trace may take weeks or months to melt, and in the meantime may cause degradation of memory integrity, intermittent memory errors, and so on.

The more difficult type of damage to recognize and troubleshoot is the intermittent (also called latent or "walking wounded") failure.

Perform the following steps to prevent ESD damage:

- Use a wired ESD wrist strap that is properly grounded. Wireless anti-static straps do not provide adequate protection. Touching the chassis before handling parts does not ensure adequate ESD protection on parts with increased sensitivity to ESD damage.
- Handle all static-sensitive components in a static-safe area. If possible, use anti-static floor pads and workbench pads.
- When unpacking a static-sensitive component from its shipping carton, do not remove the component from the anti-static packing material until you are ready to install the component. Before unwrapping the anti-static packaging, ensure that you discharge static electricity from your body.
- Before transporting a static-sensitive component, place it in an anti-static container or packaging.

ESD Field Service kit

The unmonitored Field Service kit is the most commonly used service kit. Each Field Service kit includes three main components: anti-static mat, wrist strap, and bonding wire.

Components of an ESD field service kit

The components of an ESD field service kit are:

- **Anti-Static Mat** – The anti-static mat is dissipative and parts can be placed on it during service procedures. When using an anti-static mat, your wrist strap should be snug and the bonding wire should be connected to the mat and to any bare metal on the computer being worked on. Once deployed properly, service parts can be removed from the ESD bag and placed directly on the mat. ESD-sensitive items are safe in your hand, on the ESD mat, in the computer, or inside an ESD bag.
- **Wrist Strap and Bonding Wire** – The wrist strap and bonding wire can be either directly connected between your wrist and bare metal on the hardware if the ESD mat is not required, or connected to the anti-static mat to protect hardware that is temporarily placed on the mat. The physical connection of the wrist strap and bonding wire between your skin, the ESD mat, and the hardware is known as bonding. Use only Field Service kits with a wrist strap, mat, and bonding wire. Never use wireless wrist straps. Always be aware that the internal wires of a wrist strap are prone to damage from normal wear and tear, and must be checked regularly with a wrist strap tester in order to avoid accidental ESD hardware damage. It is recommended to test the wrist strap and bonding wire at least once per week.
- **ESD Wrist Strap Tester** – The wires inside an ESD strap are prone to damage over time. When using an unmonitored kit, it is a best practice to regularly test the strap prior to each service call, and at a minimum, test once per week. A wrist strap tester is the best method for doing this test. If you do not have your own wrist strap tester, check with your regional office to find out if they have one. To perform the test, plug the bonding-wire of wrist-strap into the tester while it is strapped to your wrist and push the button to test. A green LED is lit if the test is successful; a red LED is lit and an alarm sounds if the test fails.
- **Insulator Elements** – It is critical to keep ESD sensitive devices, such as plastic heat sink casings, away from internal parts that are insulators and often highly charged.
- **Working Environment** – Before deploying the ESD Field Service kit, assess the situation at the customer location. For example, deploying the kit for a server environment is different than for a desktop or laptop environment. Servers are typically installed in a rack within a data center; desktops or laptops are typically placed on office desks or cubicles. Always look for a large open flat work area that is free of clutter and large enough to deploy the ESD kit with additional space to accommodate the type of computer that is being repaired. The workspace should also be free of insulators that can cause an ESD event. On the work area, insulators such as Styrofoam and other plastics should always be moved at least 12 inches or 30 centimeters away from sensitive parts before physically handling any hardware components.

- **ESD Packaging** – All ESD-sensitive devices must be shipped and received in static-safe packaging. Metal, static-shielded bags are preferred. However, you should always return the damaged part using the same ESD bag and packaging that the new part arrived in. The ESD bag should be folded over and taped shut and all the same foam packing material should be used in the original box that the new part arrived in. ESD-sensitive devices should be removed from packaging only at an ESD-protected work surface, and parts should never be placed on top of the ESD bag because only the inside of the bag is shielded. Always place parts in your hand, on the ESD mat, in the computer, or inside an anti-static bag.
- **Transporting Sensitive Components** – When transporting ESD sensitive components such as replacement parts or parts to be returned to Dell, it is critical to place these parts in anti-static bags for safe transport.

ESD protection summary

It is recommended to always use the traditional wired ESD grounding wrist strap and protective anti-static mat when servicing Dell products. In addition, it is critical to keep sensitive parts separate from all insulator parts while performing service and use anti-static bags for transporting sensitive components.

Transporting sensitive components

When transporting ESD sensitive components such as replacement parts or parts to be returned to Dell, it is critical to place these parts in anti-static bags for safe transport.

After working inside your computer

About this task

 **CAUTION:** Leaving stray or loose screws inside your computer may severely damage your computer.

Steps

1. Replace all screws and ensure that no stray screws remain inside your computer.
2. Connect any external devices, peripherals, or cables you removed before working on your computer.
3. Replace any media cards, discs, or any other parts that you removed before working on your computer.
4. Connect your computer and all attached devices to their electrical outlets.
 -  **NOTE:** To exit service mode, ensure to connect the AC adapter to the power-adapter port on your computer.
5. Press the power button to turn on the computer. Your computer will automatically return to normal functioning mode.

BitLocker

 **CAUTION:** If BitLocker is not suspended before updating the BIOS, the next time you reboot the system it will not recognize the BitLocker key. You will then be prompted to enter the recovery key to progress, and the system will ask for the recovery key on each reboot. If the recovery key is not known, this can result in data loss or an unnecessary operating system reinstall. For more information about this subject, see Knowledge Article: [updating the BIOS on Dell systems with BitLocker enabled](#).

The installation of the following components triggers BitLocker:

- Hard disk drive or solid-state drive
- System board

Recommended tools

The procedures in this document may require the following tools:

- Phillips screwdriver #0
- Phillips screwdriver #1
- Torx #5 (T5) screwdriver

- Plastic scribe

Screw list

- NOTE:** When removing screws from a component, it is recommended to note the screw type, and the quantity of screws, and then place them in a screw storage box. This is to ensure that the correct number of screws and correct screw type is restored when the component is replaced.
- NOTE:** Some computers have magnetic surfaces. Ensure that the screws are not left attached to such surfaces when replacing a component.
- NOTE:** Screw color may vary with the configuration ordered.

Table 32. Screw list









Component	Screw type	Quantity	Screw image
Base cover	T5, M2x3	8	 <p>Figure 8. T5, M2x3</p>
M.2 2230 solid state drive NOTE: For computers shipped with M.2 2230 solid state drive.	M2x2	2	 <p>Figure 9. M2x2</p>
M.2 2280 solid state drive NOTE: For computers shipped with M.2 2280 solid state drive.	M2x2	1	 <p>Figure 10. M2x2</p>
Battery	M2x4	5	 <p>Figure 11. M2x4</p>
Left fan	M2x4	2	 <p>Figure 12. M2x4</p>
Right fan	M2x4	2	 <p>Figure 13. M2x4</p>
Heat-sink for integrated graphics	Captive screw	4	 <p>Figure 14. Captive screw</p>

Table 32. Screw list (continued)

Component	Screw type	Quantity	Screw image
Heat-sink for discrete graphics	Captive screw	5	 <p>Figure 15. Captive screw</p>
Audio jack	M2x4	3	 <p>Figure 16. M2x4</p>
	M1.6x3	1	 <p>Figure 17. M1.6x3</p>
Speakers	M1.6x1.8	2	 <p>Figure 18. M1.6x1.8</p>
Smart-card reader	M1.6x1.7	2	 <p>Figure 19. M1.6x1.7</p>
Display assembly	M2.5x5	6	 <p>Figure 20. M2.5x5</p>
	T5, M1.4x4	4	 <p>Figure 21. T5, M1.4x4</p>
System board	M2x4	6	 <p>Figure 22. M2x4</p>
	T5, M1.4x4	4	 <p>Figure 23. T5, M1.4x4</p>
	M1.6x2.3	1	 <p>Figure 24. M1.6x2.3</p>

Table 32. Screw list (continued)

Component	Screw type	Quantity	Screw image
Power button board with fingerprint reader	M1.6x2	3	 Figure 25. M1.6x2
USH board	M1.4x1.2	2	 Figure 26. M1.4x1.2
WLAN antennas	M1.4x2.5	4	 Figure 27. M1.4x2.5

Major components of Precision 5490

The following image shows the major components of Precision 5490.

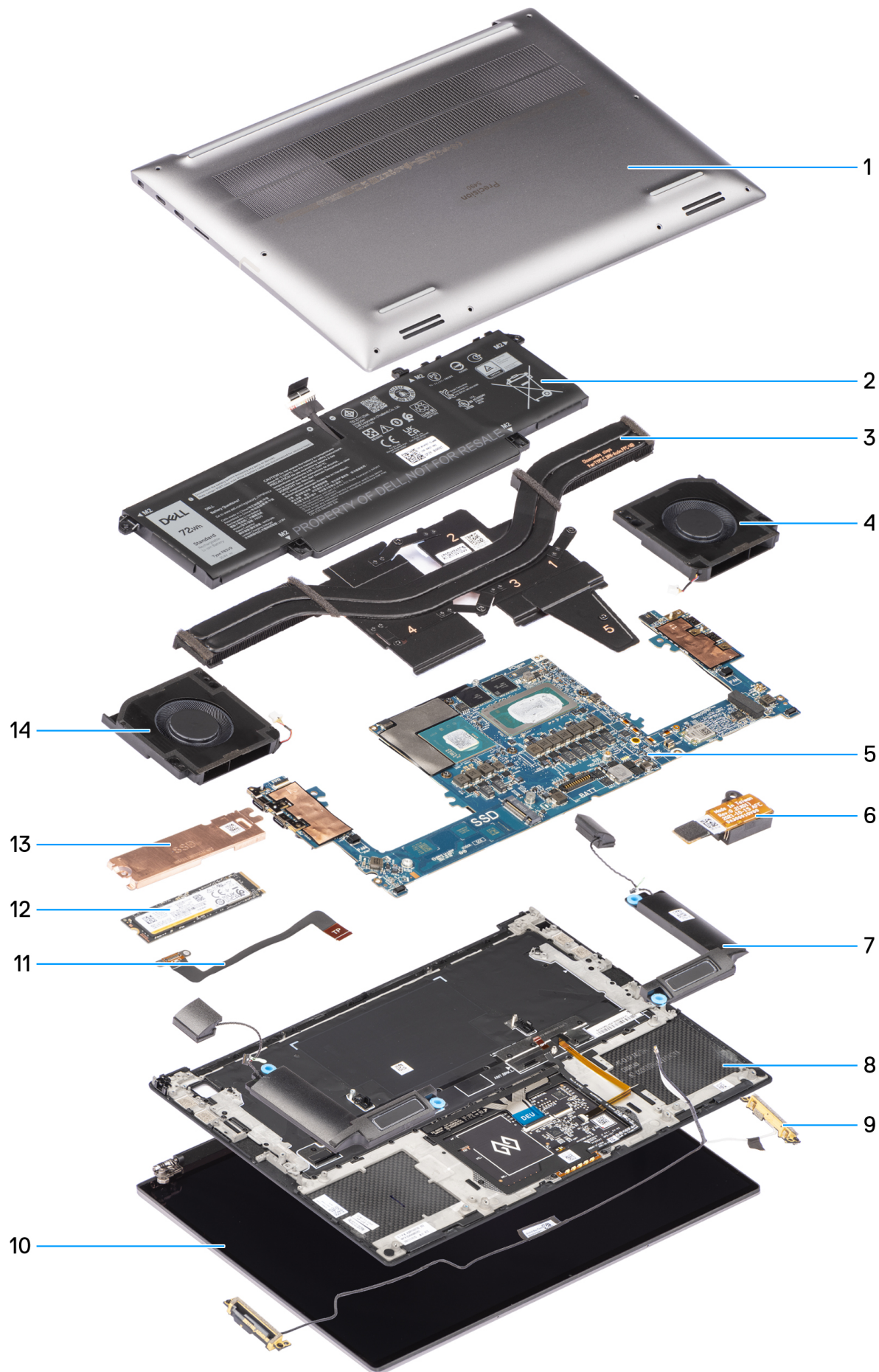

1. Base cover
2. Battery
3. Heat sink
4. Right fan
5. System board
6. Audio jack
7. Speakers
8. Palm-rest and keyboard assembly
9. WLAN antennas
10. Display assembly
11. Touchpad flat printed cable
12. Solid-state drive
13. SSD thermal plate
14. Left fan

 **NOTE:** Dell provides a list of components and their part numbers for the original system configuration purchased. These parts are available according to warranty coverages purchased by the customer. Contact your Dell sales representative for purchase options.

Removing and installing Field Replaceable Units (FRUs)

The replaceable components in this chapter are Field Replaceable Units (FRUs).

CAUTION: The information in this section is intended for authorized service technicians only.

CAUTION: To avoid any potential damage to the component or loss of data, ensure that an authorized service technician replaces the Field Replaceable Units (FRUs).

CAUTION: Dell Technologies recommends that this set of repairs, if needed, to be conducted by trained technical repair specialists.

CAUTION: As a reminder, your warranty does not cover damages that may occur during FRU repairs that are not authorized by Dell Technologies.

NOTE: The images in this document may differ from your computer depending on the configuration you ordered.

Base cover

Removing the base cover

CAUTION: The information in this removal section is intended for authorized service technicians only.

Prerequisites

Follow the procedure in [Before working inside your computer](#).

NOTE: Ensure that your computer is in Service Mode. For more information, see [Before working inside your computer](#).

CAUTION: If you are unable to turn on the computer, if your computer is unable to enter Service Mode, or the computer does not support Service Mode, go to disconnect the battery cable.

About this task

The figure indicates the location of the base cover and provides a visual representation of the removal procedure.



8x
T5 M2x3



Figure 28. Removing the base cover



Figure 29. Removing the base cover



Figure 30. Removing the base cover

Steps

1. Remove the eight torx screws (T5, M2x3) that secure the base cover to the computer.
2. Use a scribe to pry from the gap at the bottom-left corner of the base cover. Then slide the scribe towards the middle of the bottom side, and then the left side of the computer to disengage the clips. Repeat the same process for the other side of the computer.

NOTE: Do not pry up from the top side (near the vents) of the base cover as it can damage the rear side of the cover.



Figure 31. Do not pry from the top side of the base cover

CAUTION: Only use the plastic scribe to disengage and release the clips with the prying motion along the edges of the base cover. Do not use your fingers.

3. Lift the base cover starting from the bottom edge and push it towards the rear to remove it from the computer.

Installing the base cover

CAUTION: The information in this installation section is intended for authorized service technicians only.

Prerequisites

If you are replacing a component, remove the existing component before performing the installation procedure.

About this task

The figure indicates the location of the base cover and provides a visual representation of the installation procedure.



8x
T5 M2x3



Figure 32. Installing the base cover

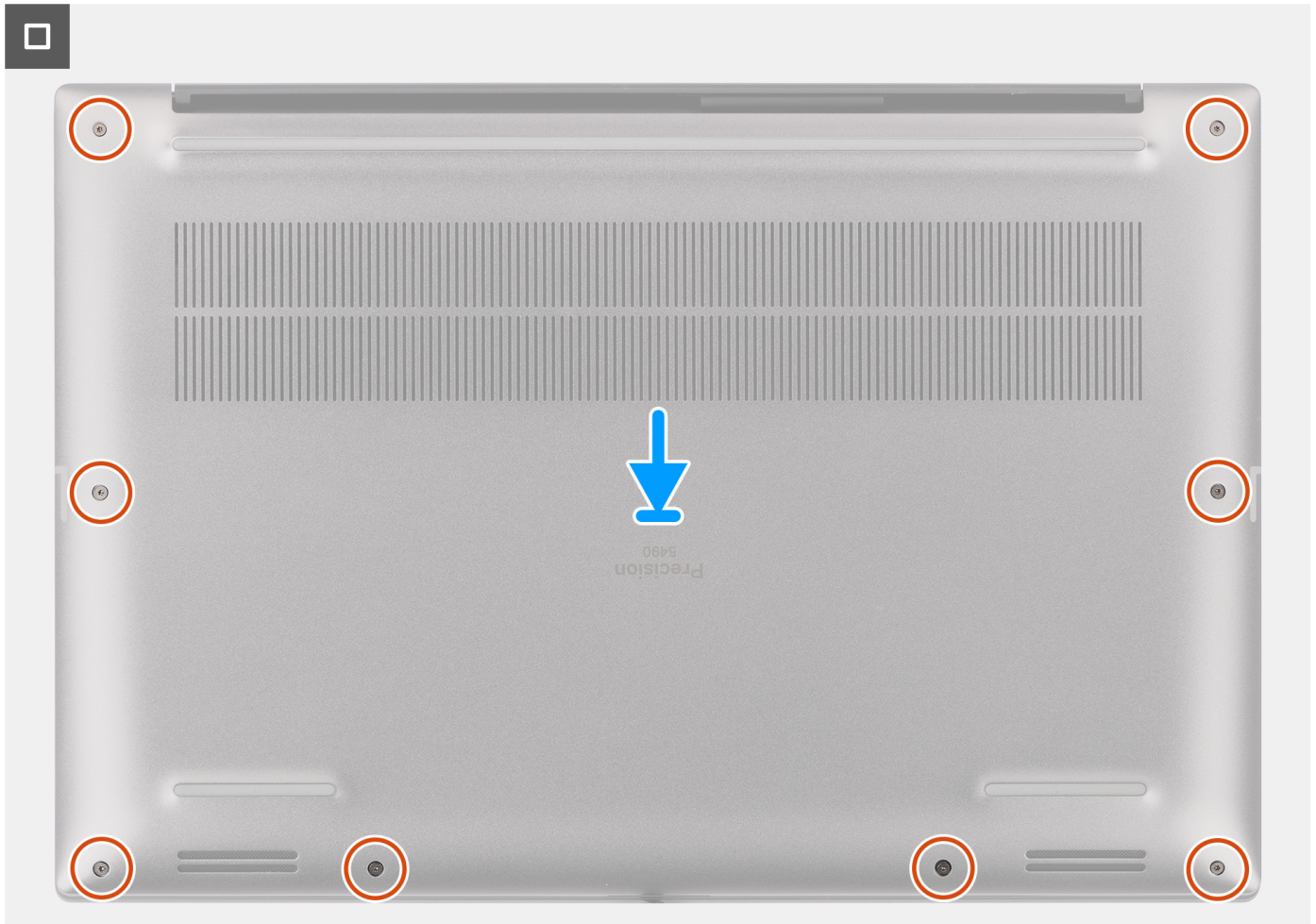

Figure 33. Installing the base cover

Steps

1. Connect the battery cable to the connector on the system board.
2. Slide the base cover into its slot until it clicks into place and replace the eight torx screws (T5, M2x3) to secure the base cover to the computer.

Next steps

Follow the procedure in [After working inside your computer](#).

M.2 solid state drive

Removing the M.2 2230 solid state drive

CAUTION: The information in this removal section is intended for authorized service technicians only.

Prerequisites

NOTE: For computers shipped with M.2 2230 solid state drive.

1. Follow the procedure in [Before working inside your computer](#).
2. Remove the [base cover](#).

About this task

The figure indicates the location of the M.2 2230 solid state drive and provides a visual representation of the removal procedure.

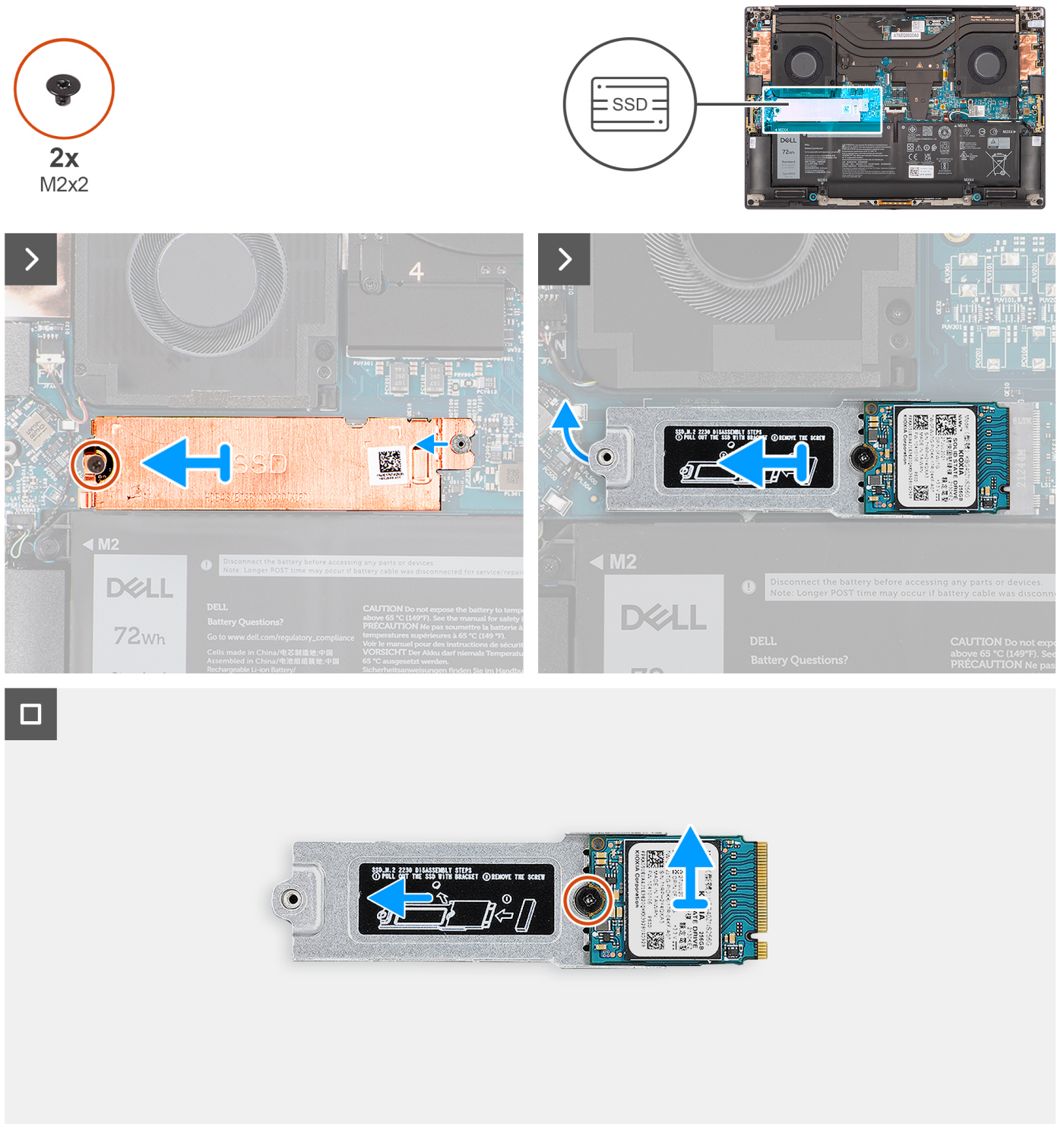

Figure 34. Removing the M.2 2230 solid-state drive

Steps

1. Remove the screw (M2x2) that secures the SSD thermal plate to the M.2 2230 solid state drive bracket.
2. Lift to remove the SSD thermal plate away from the computer.
3. Lift the M.2 2230 solid state drive bracket at an angle and slide to remove from its slot on the system board.

4. Remove the screw (M2x2) that secures the M.2 2230 solid state drive to the M.2 2230 solid state drive bracket.
5. Lift to remove M.2 2230 solid state drive from the M.2 2230 solid state drive bracket.

Installing the M.2 2230 solid-state drive

 **CAUTION:** The information in this installation section is intended for authorized service technicians only.

Prerequisites

 **NOTE:** For computers shipped with M.2 2230 solid-state drive.

If you are replacing a component, remove the existing component before performing the installation procedure.

About this task

The figure indicates the location of the M.2 2230 solid-state drive and provides a visual representation of the installation procedure.

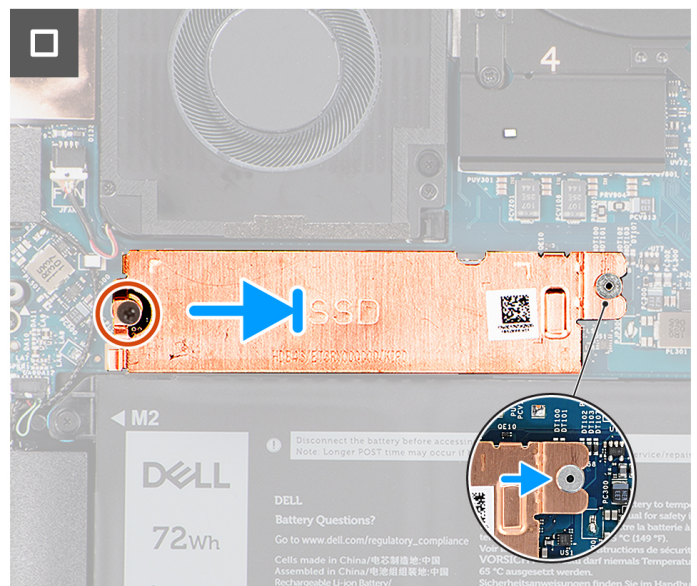
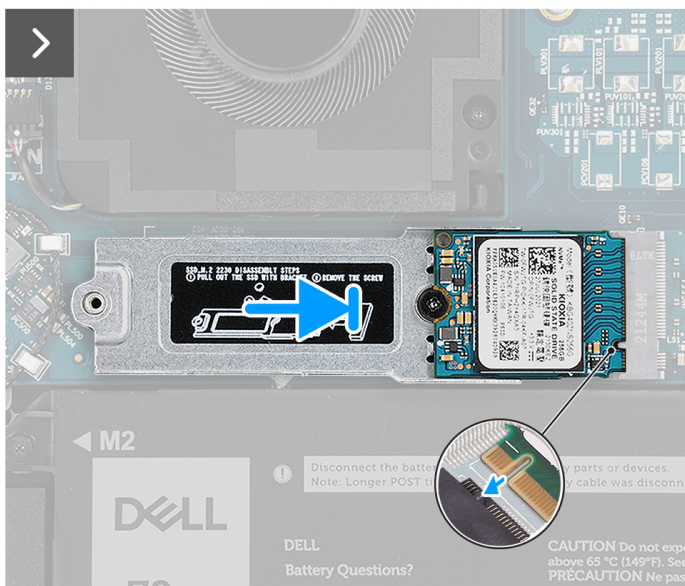
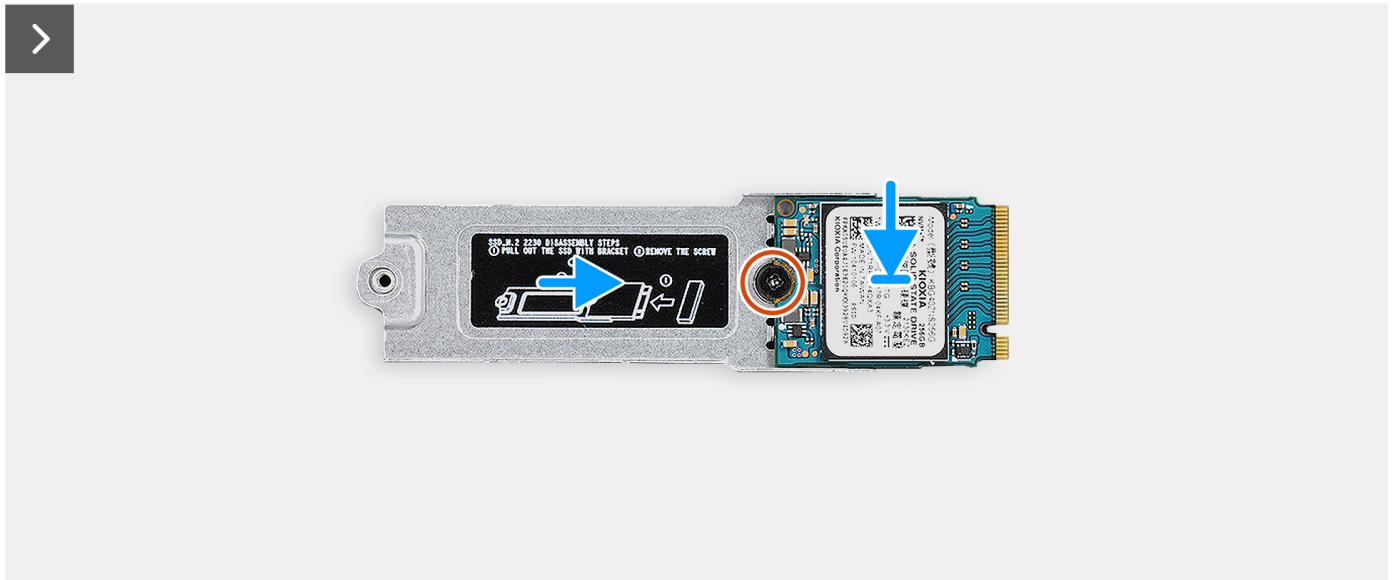
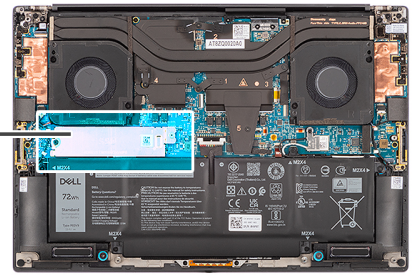

Figure 35. Installing the M.2 2230 solid-state drive

Steps

1. Align and place the M.2 2230 solid-state drive on the M.2 2230 solid-state drive bracket.
 - NOTE:** Install the M.2 2230 solid-state drive to the SSD bracket so that the top side (with the sticker) of the M.2 2230 solid-state drive is facing up.
2. Replace the screw (M2x2) that secures the M.2 2230 solid-state drive to the M.2 2230 solid-state drive bracket.
3. Carefully align and insert the M.2 2230 solid-state drive bracket to its slot on the system board.

- Slide the thermal plate into place over the SSD so that the tab on the plate is inserted into the securing peg on the system board.
- Replace the screw (M2x2) that secures the SSD thermal plate to the M.2 2230 solid state drive bracket.

Next steps

- Install the [base cover](#).
- Follow the procedure in [After working inside your computer](#).

Removing the M.2 2280 solid state drive

CAUTION: The information in this removal section is intended for authorized service technicians only.

Prerequisites

NOTE: For computers shipped with M.2 2280 solid state drive.

- Follow the procedure in [Before working inside your computer](#).
- Remove the [base cover](#).

About this task

The figure indicates the location of the M.2 2280 solid state drive and provides a visual representation of the removal procedure.

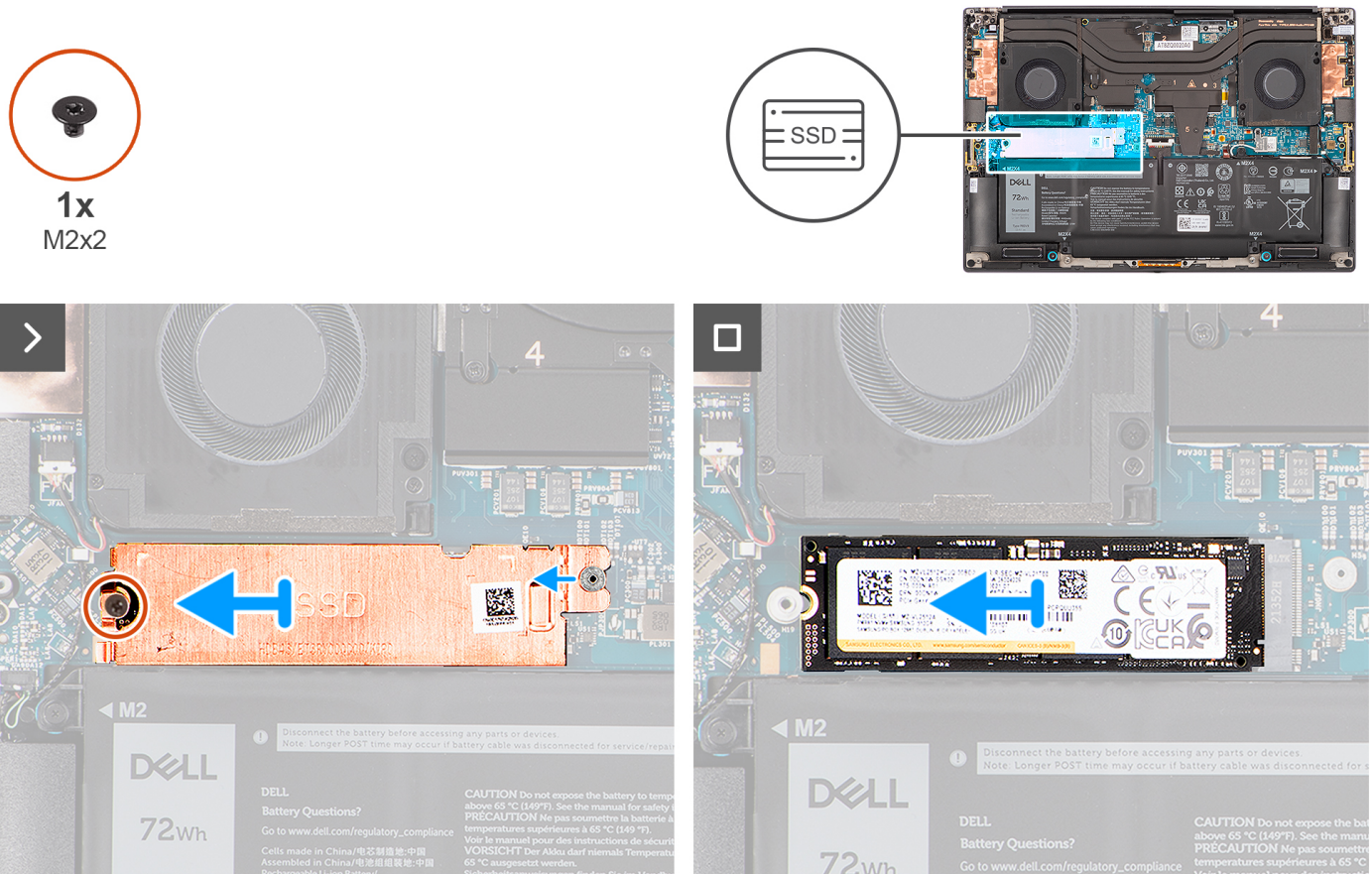

Figure 36. Removing the M.2 2280 solid-state drive

Steps

- Remove the screw (M2x2) that secures the SSD thermal plate to the M.2 2280 solid state drive.

2. Lift to remove the SSD thermal plate away from the computer.
3. Lift the M.2 2280 solid state drive at an angle and slide to remove from its slot on the system board.

Installing the M.2 2280 solid state drive

CAUTION: The information in this installation section is intended for authorized service technicians only.

Prerequisites

NOTE: For computers shipped with M.2 2280 solid state drive.

If you are replacing a component, remove the existing component before performing the installation procedure.

About this task

The figure indicates the location of the M.2 2280 solid state drive and provides a visual representation of the installation procedure.

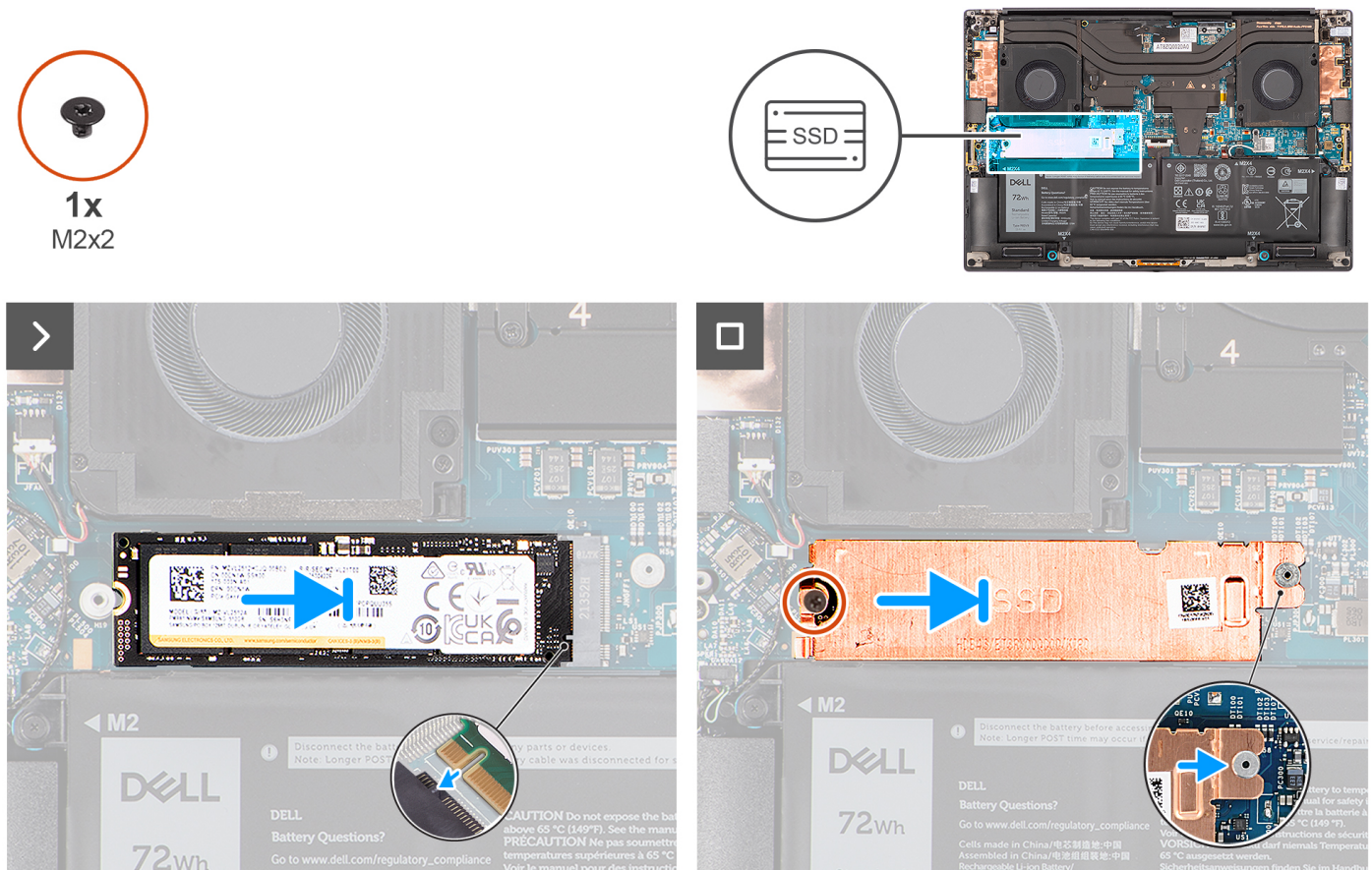

Figure 37. Installing the M.2 2280 solid-state drive

Steps

1. Carefully align and insert the M.2 2280 solid state drive to its slot on the system board.
2. Replace the screw (M2x2) to secure the SSD thermal plate to the M.2 2280 solid state drive.

Next steps

1. Install the [base cover](#).
2. Follow the procedure in [After working inside your computer](#).

Battery

Rechargeable Li-ion battery precautions

⚠ CAUTION:

- Exercise caution when handling rechargeable Li-ion batteries.
- Discharge the battery completely before removing it. Disconnect the AC power adapter from the computer and operate the computer solely on battery power—the battery is fully discharged when the computer no longer turns on when the power button is pressed.
- Do not crush, drop, mutilate, or penetrate the battery with foreign objects.
- Do not expose the battery to high temperatures, or disassemble battery packs and cells.
- Do not apply pressure to the surface of the battery.
- Do not bend the battery.
- Do not use tools of any kind to pry on or against the battery.
- Ensure any screws during the servicing of this product are not lost or misplaced, to prevent accidental puncture or damage to the battery and other computer components.
- If the battery gets stuck inside your computer as a result of swelling, do not try to release it as puncturing, bending, or crushing a rechargeable Li-ion battery can be dangerous. In such an instance, contact Dell technical support for assistance. See www.dell.com/contactdell.
- Always purchase genuine batteries from www.dell.com or authorized Dell partners and resellers.
- Swollen batteries should not be used and should be replaced and disposed properly. For guidelines on how to handle and replace swollen rechargeable Li-ion batteries, see [Handling swollen rechargeable Li-ion batteries](#).

Removing the battery

⚠ CAUTION: The information in this removal section is intended for authorized service technicians only.

Prerequisites

1. Follow the procedure in [Before working inside your computer](#).
2. Remove the [base cover](#).

About this task

The figure indicates the location of the battery and provides a visual representation of the removal procedure.

i NOTE: For models shipped with WLAN antennas, unroute the cables from the upper-right side of the battery before battery removal and then tuck the cables back into the routing channels when reinstalling the battery.

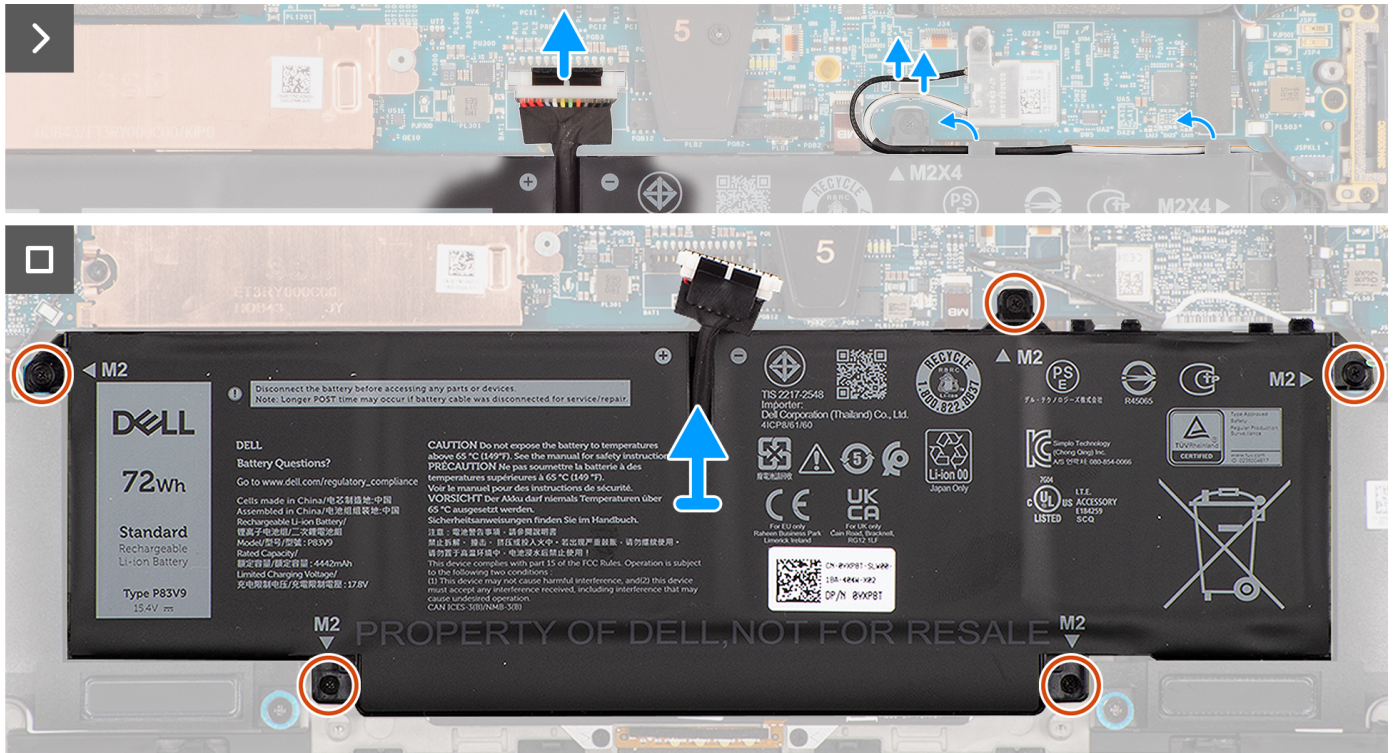
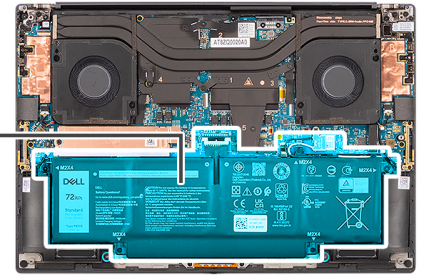
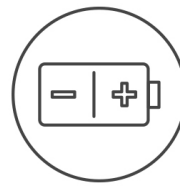

Figure 38. Removing the battery

Steps

1. Disconnect the battery cable from the connector on the system board.
2. Unroute the WLAN antennas from the routing guides on the battery.
3. Remove the five screws (M2x4) that secure the battery to the palm-rest and keyboard assembly.
4. Slightly lift the battery at an angle and slide to remove from the palm-rest and keyboard assembly.

Installing the battery

CAUTION: The information in this installation section is intended for authorized service technicians only.

Prerequisites

If you are replacing a component, remove the existing component before performing the installation procedure.

About this task

The figure indicates the location of the battery and provides a visual representation of the installation procedure.

NOTE: For models shipped with WLAN antennas, unroute the cables from the upper-right side of the battery before battery removal and then tuck the cables back into the routing channels when reinstalling the battery.



5x
M2x4

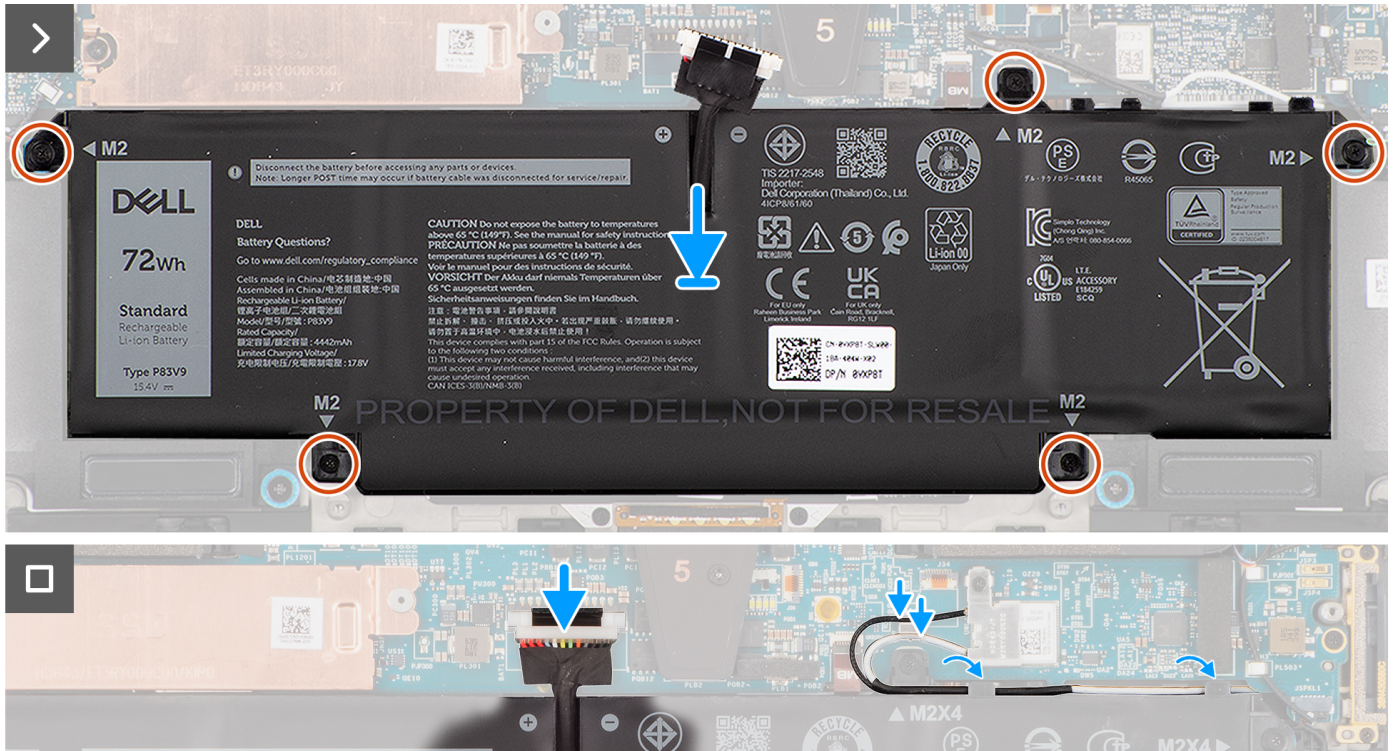
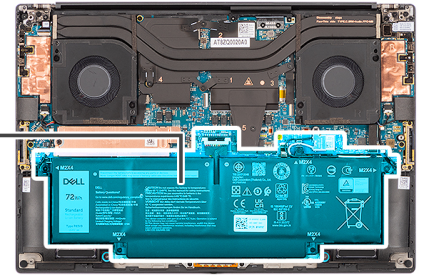
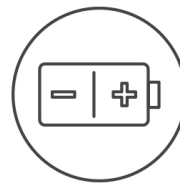

Figure 39. Installing the battery

Steps

1. Place the battery onto its slot in the palm-rest and keyboard assembly.
2. Replace the five screws (M2x4) to secure the battery to the palm-rest and keyboard assembly.
3. Route the WLAN antennas using the routing guides on the battery.
4. Connect the battery cable to the connector on the system board.

Next steps

1. Install the [base cover](#).
2. Follow the procedure in [After working inside your computer](#).

Processor fan

Removing the processor fan

CAUTION: The information in this removal section is intended for authorized service technicians only.

Prerequisites

1. Follow the procedure in [Before working inside your computer](#).
2. Remove the [base cover](#).

About this task

The following images indicate the location of the processor fan and provide a visual representation of the removal procedure.



2x
M2x4

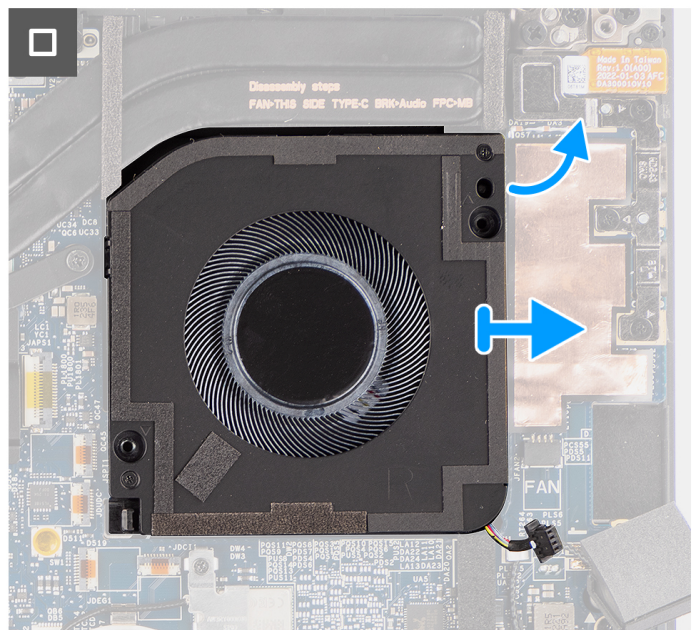
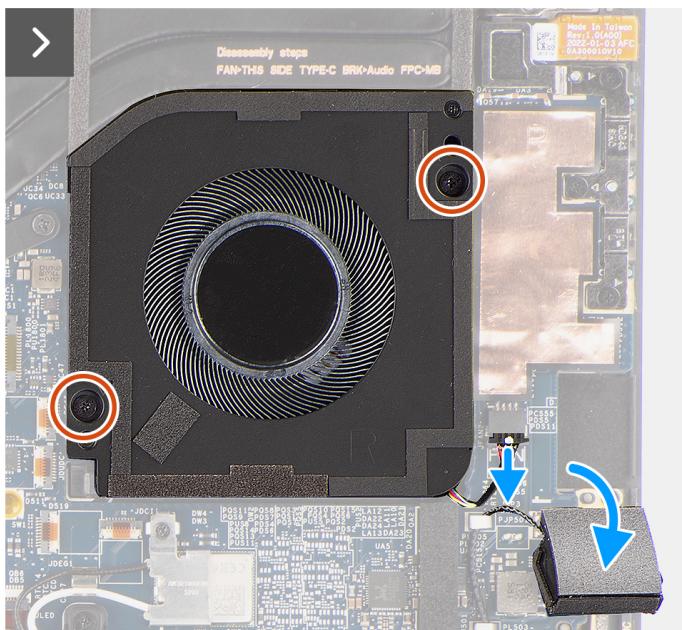
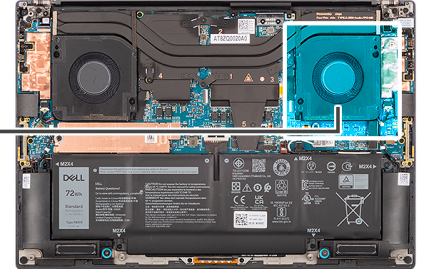
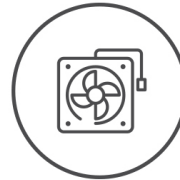

Figure 40. Removing the processor fan

Steps

1. Carefully peel off the tweeter speaker from its compartment next to the fan connector to create more space to disconnect the fan cable.
2. Disconnect the processor fan cable from the connector on the system board.
3. Remove the two screws (M2x4) that secure the processor fan to the palm-rest and keyboard assembly.
4. Lift the fan from its outer edge and slide it away from the palm-rest and keyboard assembly.

Installing the processor fan

⚠ CAUTION: The information in this installation section is intended for authorized service technicians only.

Prerequisites

If you are replacing a component, remove the existing component before performing the installation procedure.

About this task

The following images indicate the location of the processor fan and provide a visual representation of the installation procedure.

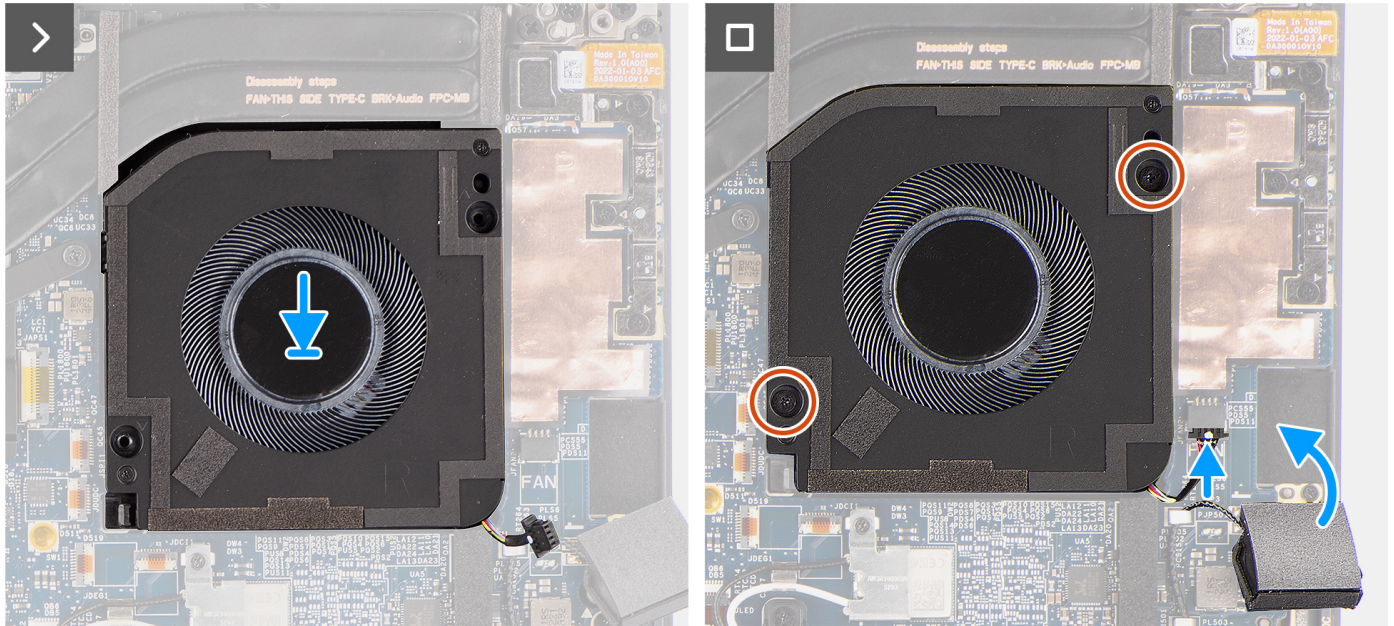
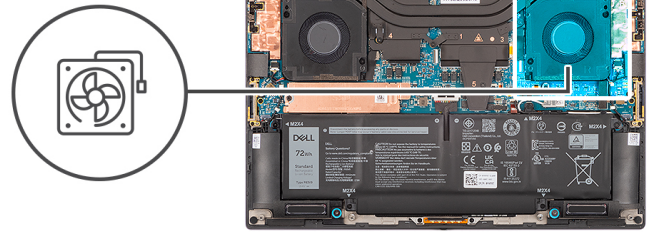

Figure 41. Installing the processor fan

Steps

1. Align the screw holes on the processor fan with the screw holes on the palm-rest and keyboard assembly.
2. Replace the two screws (M2x4) to secure the processor fan to the palm-rest and keyboard assembly.
3. Connect the processor fan cable to the connector on the system board.
4. Adhere the tweeter speaker in its compartment on the palm-rest and keyboard assembly.

Next steps

1. Install the [base cover](#).
2. Follow the procedure in [After working inside your computer](#).

Graphics-card fan

Removing the graphics-card fan

⚠ CAUTION: The information in this removal section is intended for authorized service technicians only.

Prerequisites

1. Follow the procedure in [Before working inside your computer](#).

2. Remove the [base cover](#).

About this task

The following images indicate the location of the graphics-card fan and provide a visual representation of the removal procedure.

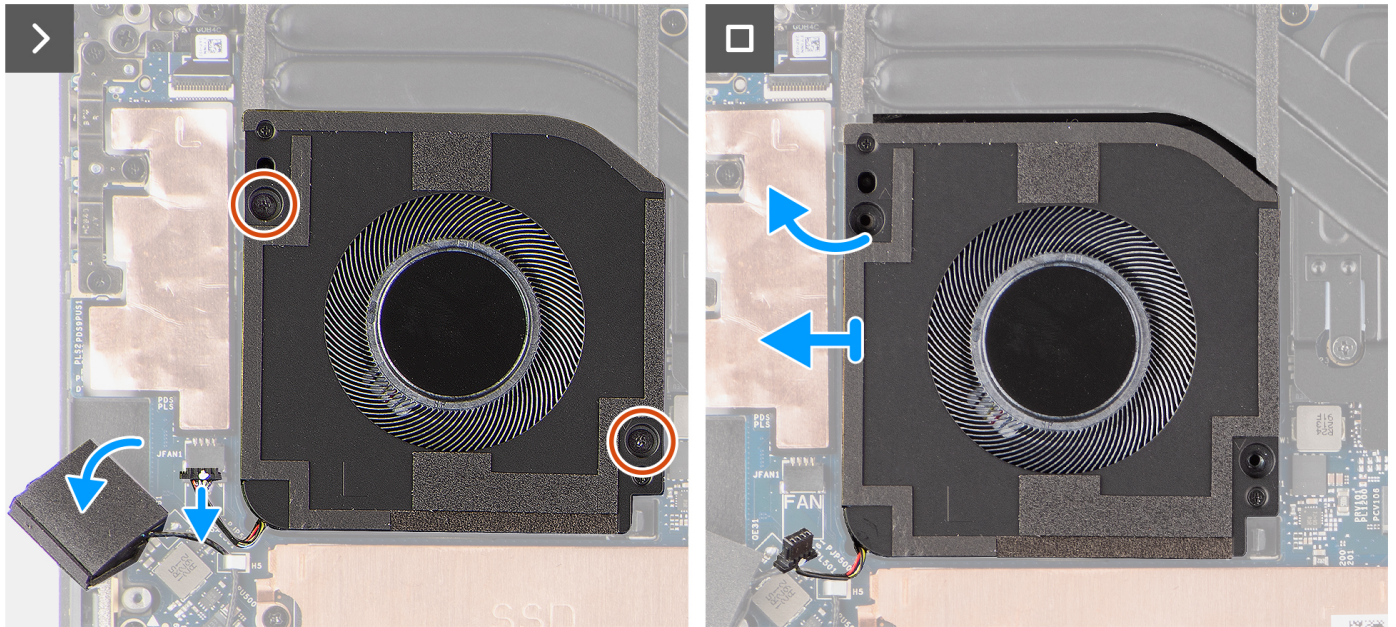
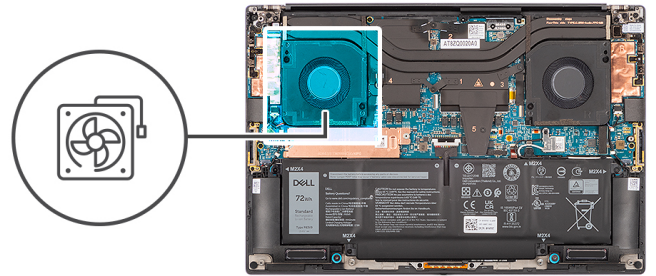

Figure 42. Removing the graphics-card fan

Steps

1. Carefully peel off the tweeter speaker from its compartment next to the fan connector to create more space to disconnect the fan cable.
2. Disconnect the graphics-card fan cable from the connector on the system board.
3. Remove the two screws (M2x4) that secure the graphics-card fan to the palm-rest and keyboard assembly.
4. Lift the fan from its outer edge and slide it away from the palm-rest and keyboard assembly.

Installing the graphics-card fan

 **CAUTION:** The information in this removal section is intended for authorized service technicians only.

Prerequisites

If you are replacing a component, remove the existing component before performing the installation procedure.

About this task

The following images indicate the location of the graphics-card fan and provide a visual representation of the installation procedure.



2x
M2x4

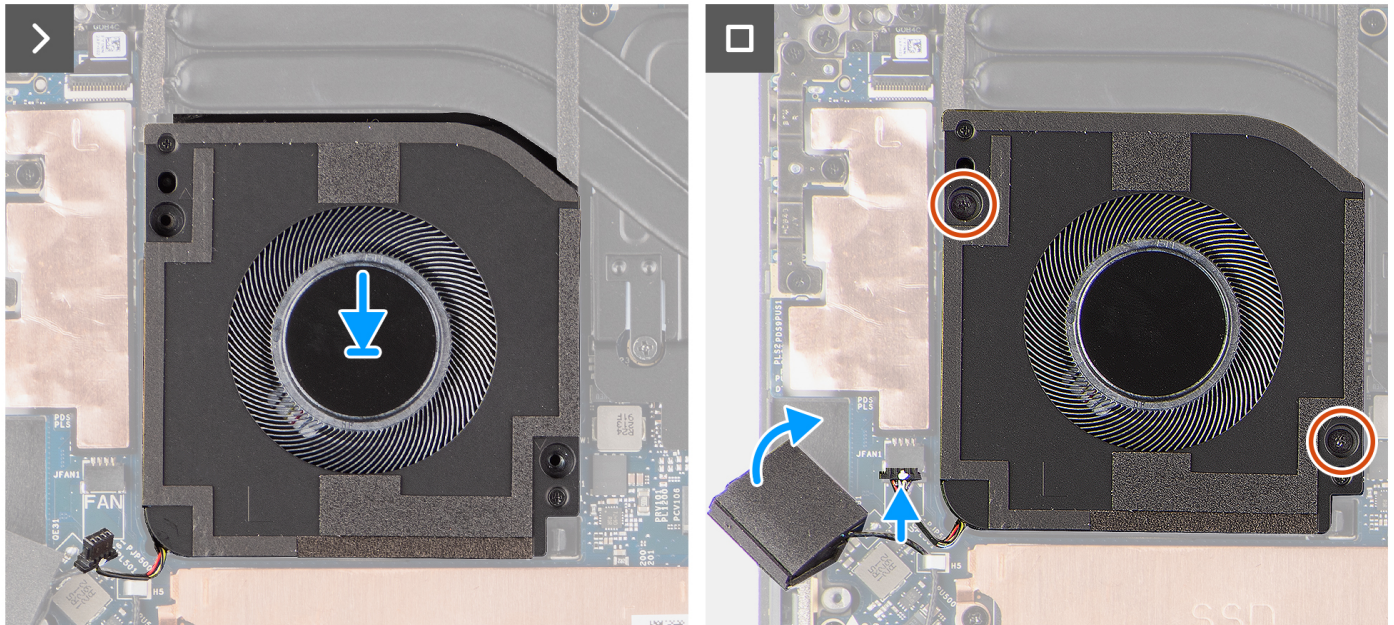
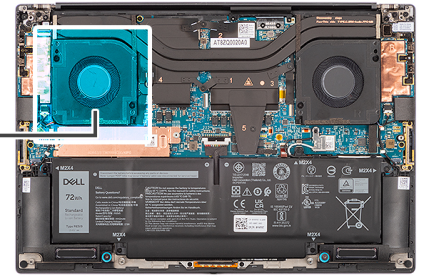
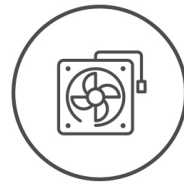

Figure 43. Removing the graphics-card fan

Steps

1. Align the screw holes on the graphics-card fan with the screw holes on the palm-rest and keyboard assembly.
2. Replace the two screws (M2x4) that secure the graphics-card fan to the palm-rest and keyboard assembly.
3. Connect the graphics-card fan cable to the connector on the system board.
4. Adhere the tweeter speaker in its compartment on the palm-rest and keyboard assembly.

Next steps

1. Install the [base cover](#).
2. Follow the procedure in [After working inside your computer](#).

Heat sink

Removing the heat sink for integrated graphics

CAUTION: The information in this removal section is intended for authorized service technicians only.

Prerequisites

1. Follow the procedure in [Before working inside your computer](#).
2. Remove the [base cover](#).

About this task

The figure indicates the location of the heat sink and provides a visual representation of the removal procedure.

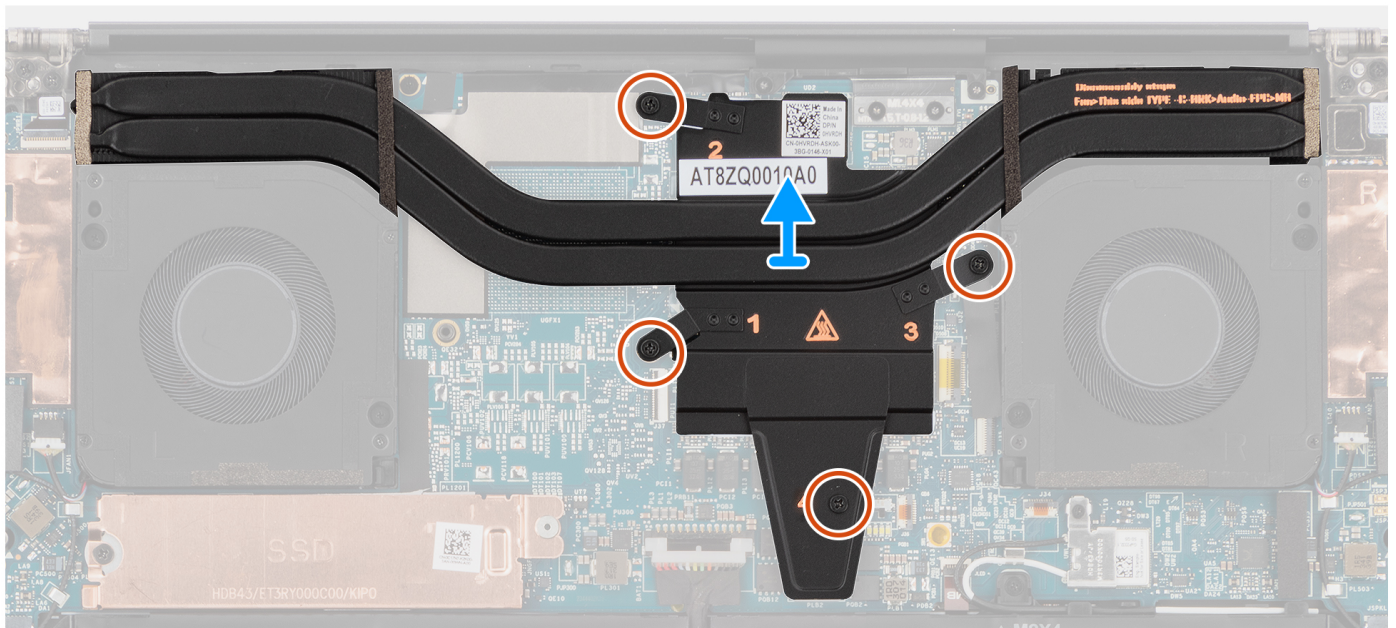
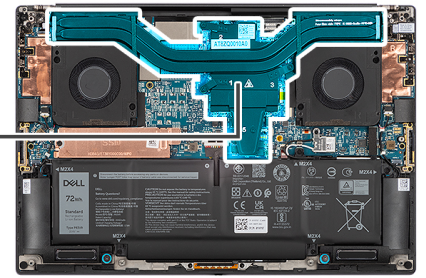



Figure 44. Removing the heat sink for integrated graphics

Steps

1. Loosen the four captive screws that secure the heat sink to the system board.

 **NOTE:** Loosen the captive screws in the order that is marked on the heat sink assembly next to the screws [4 > 3 > 2 > 1].

2. Carefully lift the heat sink to remove it from the system board.

Installing the heat sink for integrated graphics

 **CAUTION:** The information in this installation section is intended for authorized service technicians only.

Prerequisites

If you are replacing a component, remove the existing component before performing the installation procedure.

About this task

The figure indicates the location of the heat sink and provides a visual representation of the installation procedure.

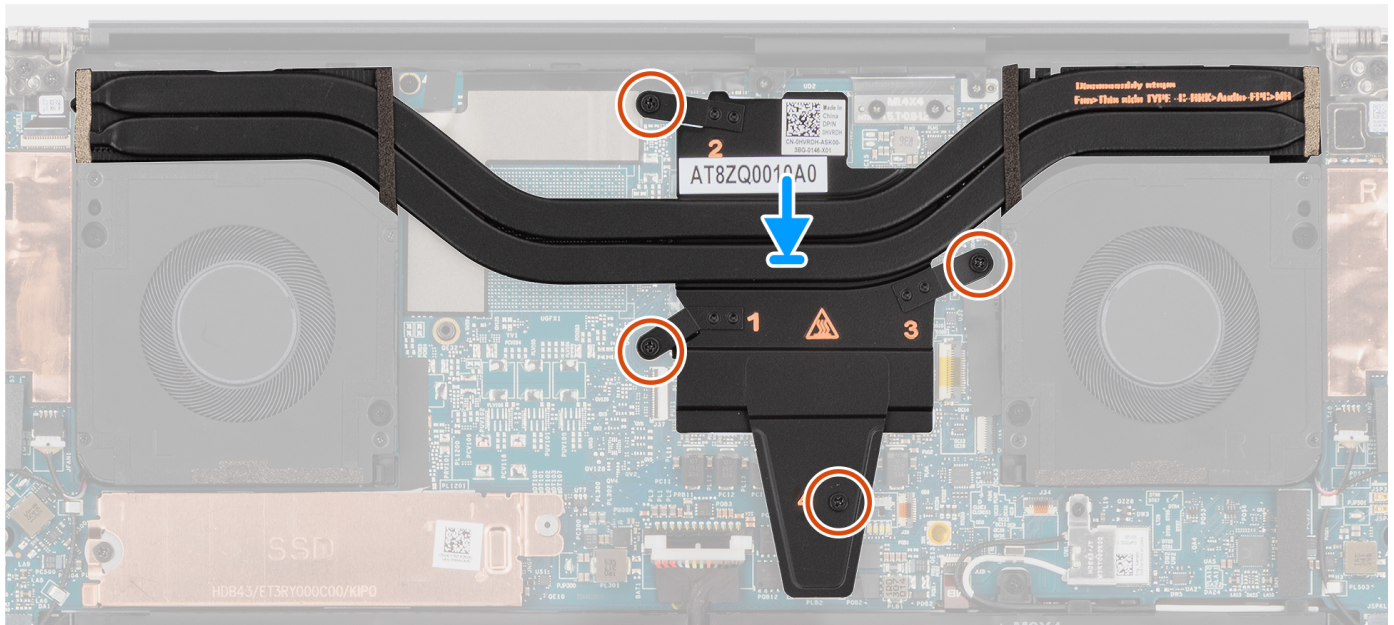
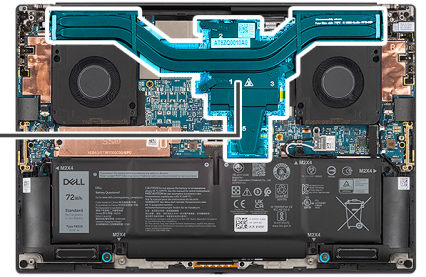

Figure 45. Installing the heat sink for integrated graphics

Steps

1. Align and insert the heat sink into its slot on the system board.
2. Tighten the four captive screws that secure the heat sink to the system board.

NOTE: Tighten the captive screws in the order that is marked on the heat sink next to the screws [1 > 2 > 3 > 4].

CAUTION: Do not over-torque the screws for the heat sink. Install the screws to a point where they are firmly secured. Overtorquing the screws can flex and damage the system board.

Next steps

1. Install the [base cover](#).
2. Follow the procedure in [After working inside your computer](#).

Removing the heat sink for discrete graphics

CAUTION: The information in this removal section is intended for authorized service technicians only.

Prerequisites

1. Follow the procedure in [Before working inside your computer](#).
2. Remove the [base cover](#).

About this task

The figure indicates the location of the heat sink and provides a visual representation of the removal procedure.

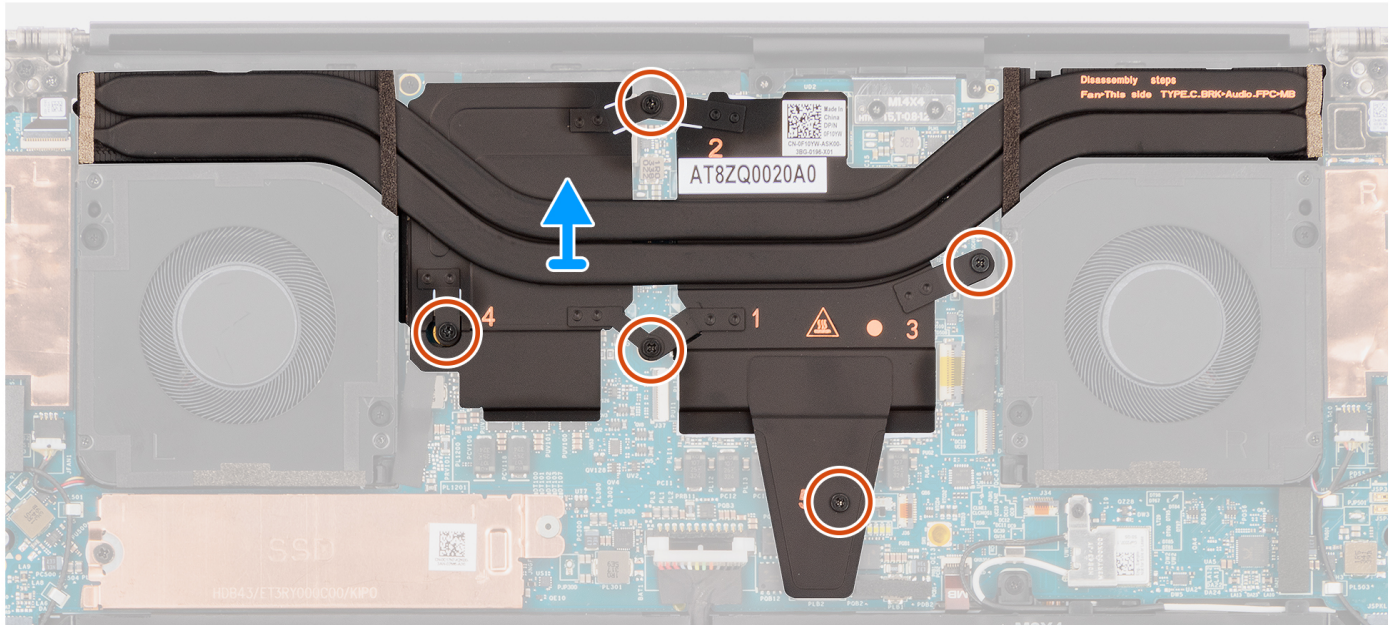
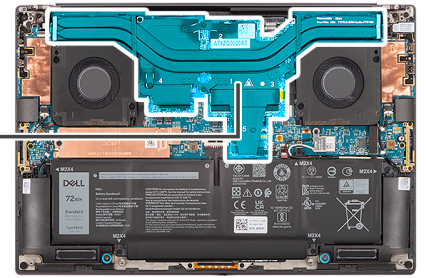

Figure 46. Removing the heat sink for discrete graphics

Steps

1. Loosen the five captive screws that secure the heat sink to the system board.

 **NOTE:** Loosen the captive screws in the order that is marked on the heat sink assembly next to the screws [5 > 4 > 3 > 2 > 1].

2. Carefully lift the heat sink to remove it from the system board.

Installing the heat sink for discrete graphics

 **CAUTION:** The information in this installation section is intended for authorized service technicians only.

Prerequisites

If you are replacing a component, remove the existing component before performing the installation procedure.

About this task

The figure indicates the location of the heat sink and provides a visual representation of the installation procedure.

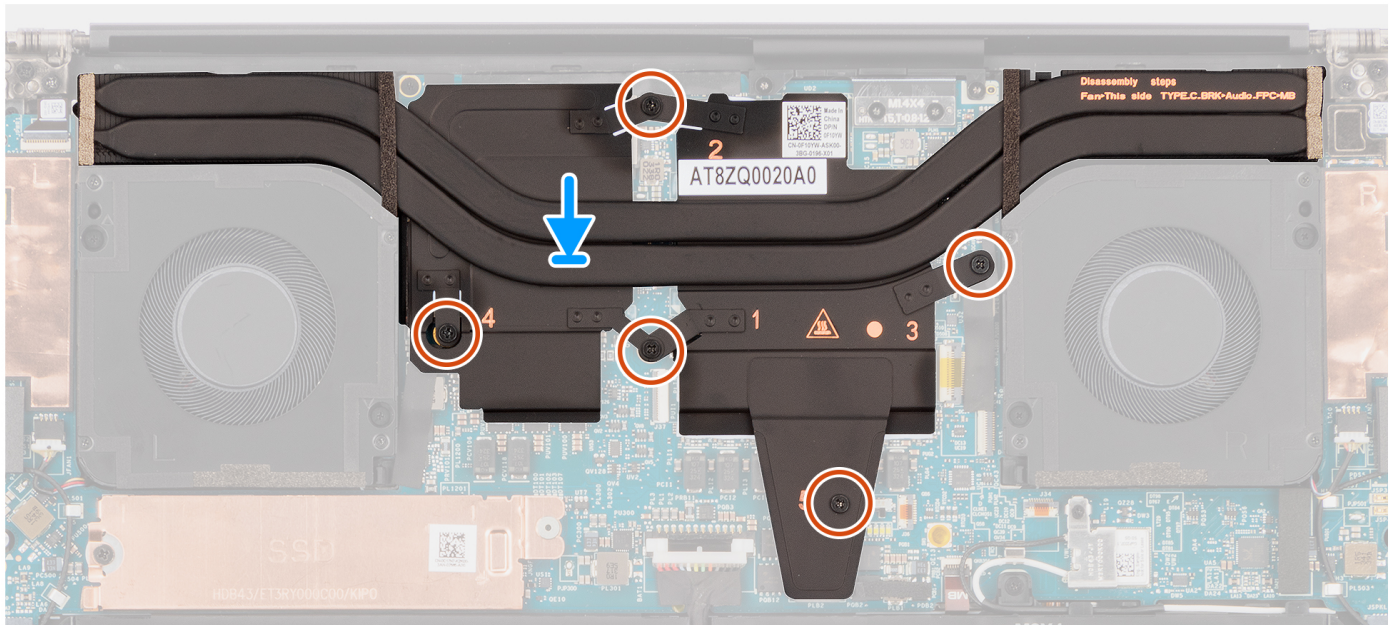
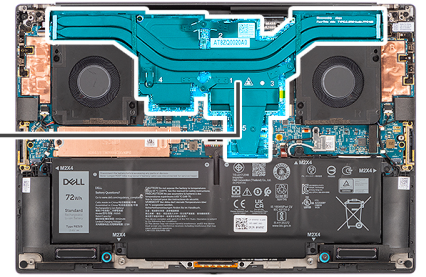

Figure 47. Installing the heat sink for discrete graphics

Steps

1. Align and insert the heat sink into its slot on the system board.
2. Tighten the five captive screws that secure the heat sink to the system board.

NOTE: Tighten the captive screws in the order that is marked on the heat sink next to the screws [1 > 2 > 3 > 4 > 5].

CAUTION: Do not over-torque the screws for the heat sink. Install the screws to a point where they are firmly secured. Overtorquing the screws can flex and damage the system board.

Next steps

1. Install the [base cover](#).
2. Follow the procedure in [After working inside your computer](#).

Audio jack

Removing the audio jack

CAUTION: The information in this removal section is intended for authorized service technicians only.

Prerequisites

1. Follow the procedure in [Before working inside your computer](#).

2. Remove the [base cover](#).

About this task

The following images indicate the location of the audio jack and provide a visual representation of the removal procedure.

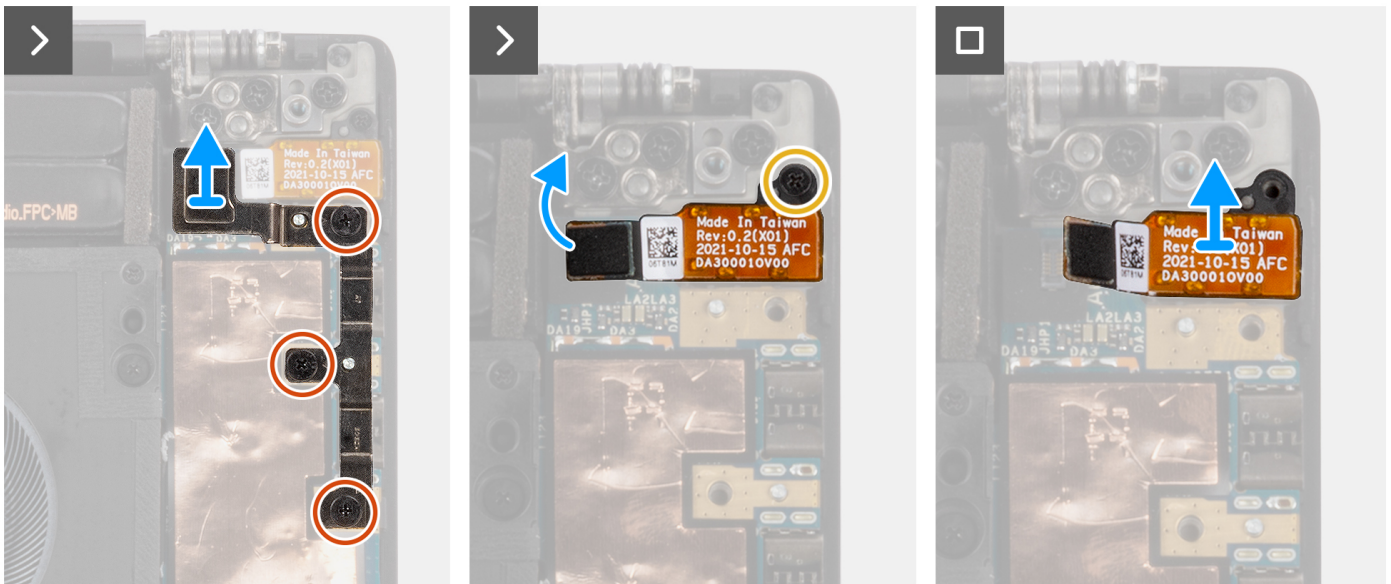
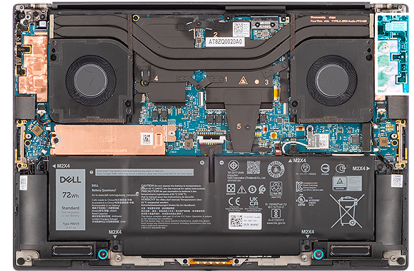

Figure 48. Removing the audio jack

Steps

1. Remove the three screws (M2x4) that secure the left USB Type-C bracket to the system board.
2. Lift to remove the left USB Type-C bracket from the connector on the system board.
3. Disconnect the audio-jack FPC from the connector on the system board.
4. Remove the screw (M1.6x3) that secures the audio jack to the system board.
5. Lift to remove the audio jack from the palm-rest and keyboard assembly.

Installing the audio jack

CAUTION: The information in this installation section is intended for authorized service technicians only.

Prerequisites

If you are replacing a component, remove the existing component before performing the installation procedure.

About this task

The following images indicate the location of the audio jack and provide a visual representation of the installation procedure.

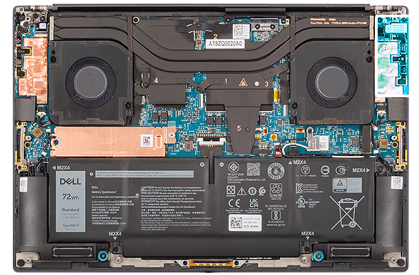
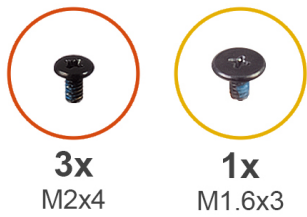

Figure 49. Installing the audio jack

Steps

1. Align and place the audio jack in its slot on the palm-rest and keyboard assembly.
2. Connect the audio-jack FPC to the connector on the system board.
3. Replace the screw (M1.6x3) to secure the audio jack to the system board.
4. Align and place the left USB Type-C bracket on the system board.
5. Replace the three screws (M2x4) to secure the left USB Type-C bracket to the system board.

Next steps

1. Install the [base cover](#).
2. Follow the procedure in [After working inside your computer](#).

Speakers

Removing the speaker

CAUTION: The information in this removal section is intended for authorized service technicians only.

Prerequisites

1. Follow the procedure in [Before working inside your computer](#).
2. Remove the [base cover](#).
3. Remove the [battery](#).

About this task

The figure indicates the location of the speaker and provides a visual representation of the removal procedure.



2x
M1.6x1.8

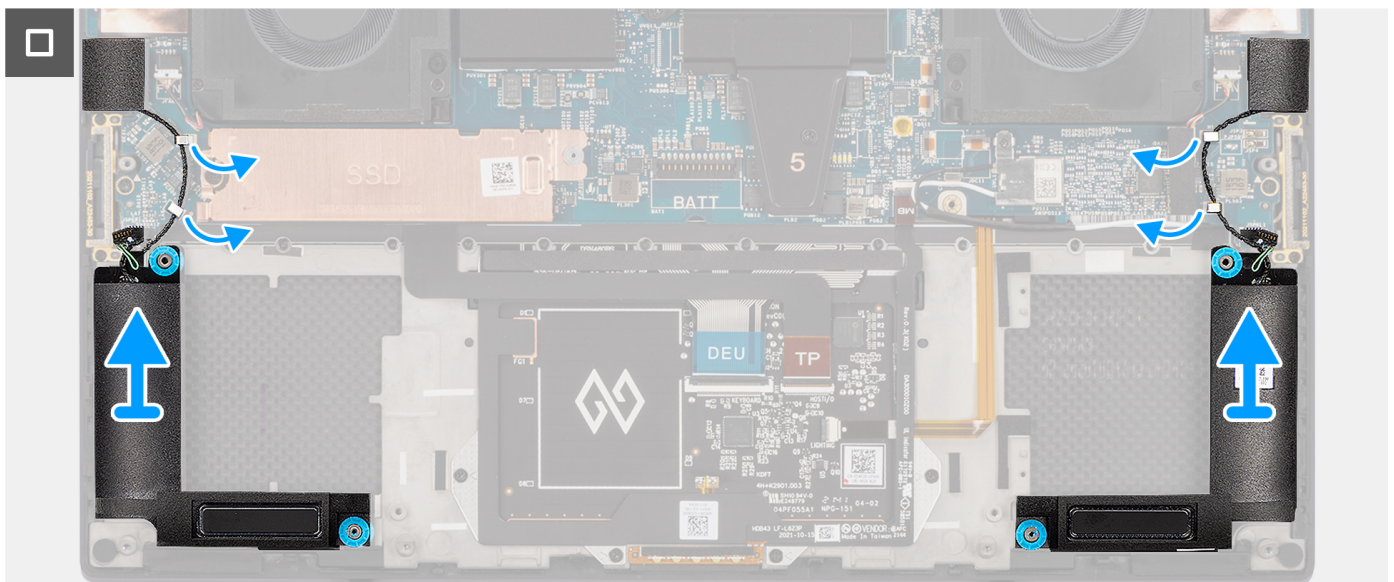
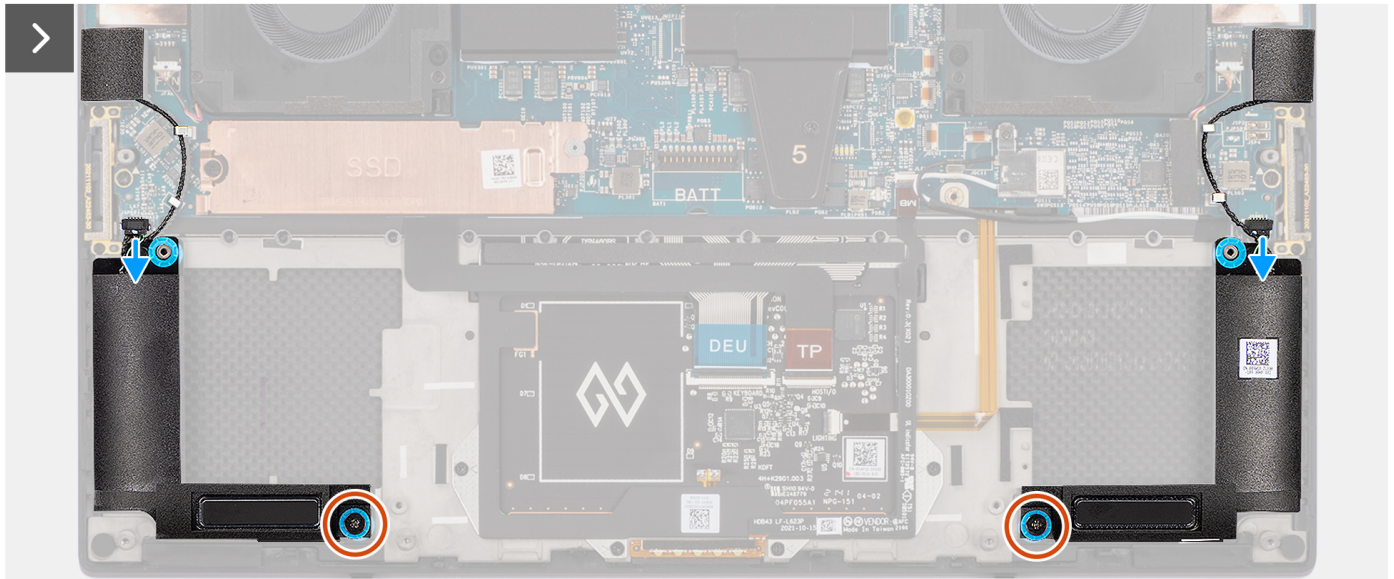
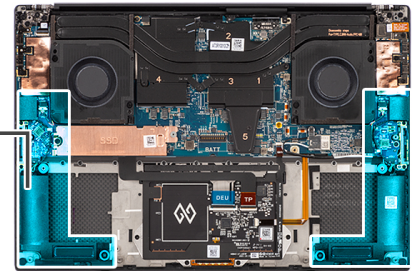
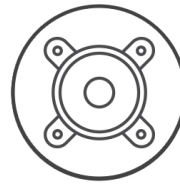

Figure 50. Removing the speaker

Steps

1. Disconnect the left and right speaker cables from the connectors on the system board.
2. Peel the left and right tweeter speakers from their compartments on the palm-rest and keyboard assembly.
3. Remove the two screws (M1.6x1.8) that secure the left and right speakers to the palm-rest and keyboard assembly.
4. Unroute the left and right tweeter speaker cables from their routing guides on the system board.

5. Lift to remove the left and right speakers from the palm-rest and keyboard assembly.

Installing the speaker

 **CAUTION:** The information in this installation section is intended for authorized service technicians only.

Prerequisites

If you are replacing a component, remove the existing component before performing the installation procedure.

About this task

The figure indicates the location of the speakers and provides a visual representation of the installation procedure.



2x
M1.6x1.8

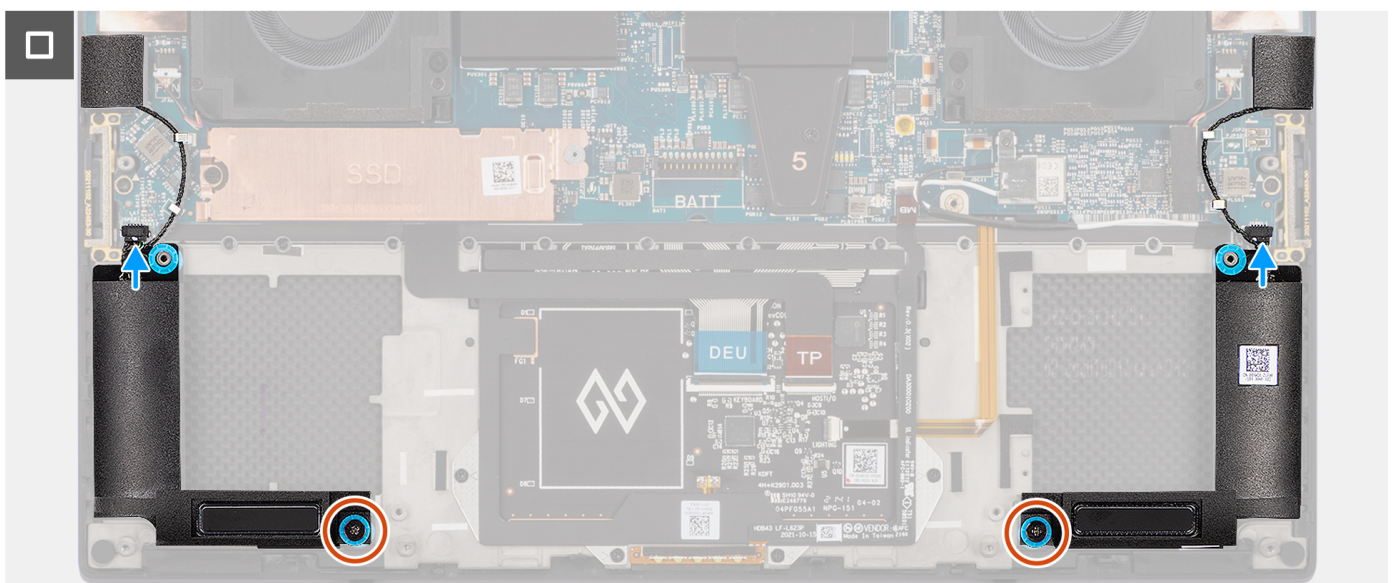
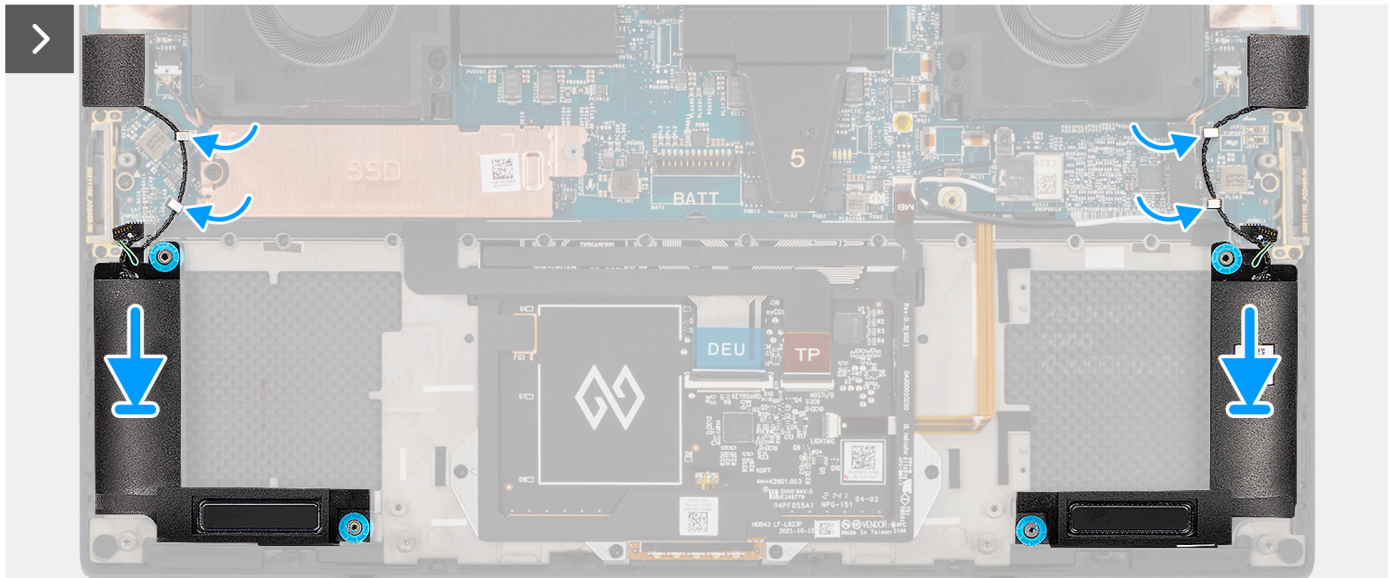
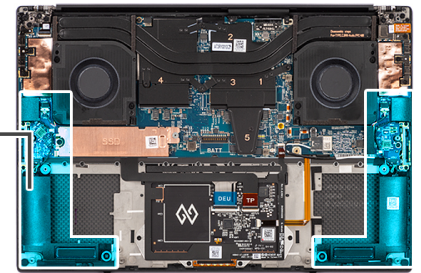
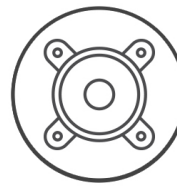

Figure 51. Installing the speaker

Steps

1. Align and place the left and right speakers into its slot on the palm-rest and keyboard assembly.
2. Route the left and right tweeter speakers using the routing guides on the system board.
3. Replace the two screws (M1.6x1.8) to secure the left and right speakers to the palm-rest and keyboard assembly.
4. Adhere the left and right tweeter speakers in their compartments on the system board.
5. Connect the left and right speaker cables to the connectors on the system board.

Next steps

1. Install the [battery](#).
2. Install the [base cover](#).
3. Follow the procedure in [After working inside your computer](#).

Smart-card reader

Removing the smart-card reader

CAUTION: The information in this removal section is intended for authorized service technicians only.

Prerequisites

1. Follow the procedure in [Before working inside your computer](#).
2. Remove the [base cover](#).
3. Remove the [battery](#).
4. Remove the [speakers](#).

About this task

The figure indicates the location of the smart-card reader and provides a visual representation of the removal procedure.

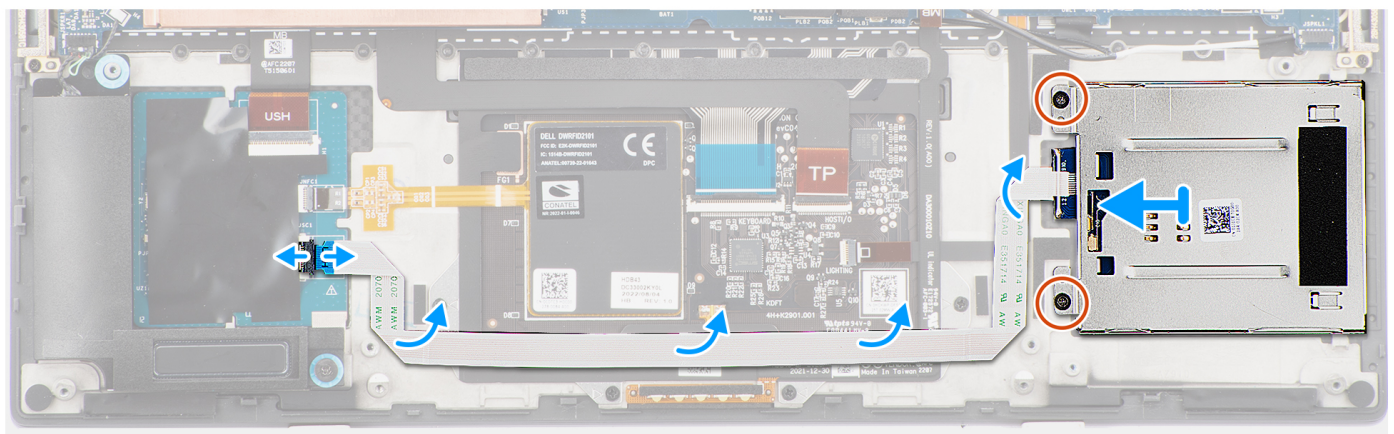
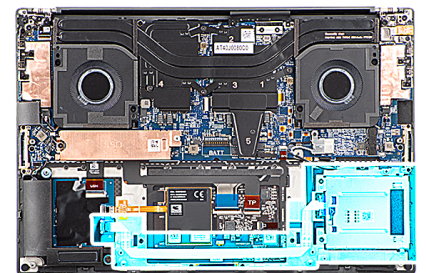

Figure 52. Removing the smart-card reader

Steps

1. Disconnect the smart-card reader FFC from the connector on the USH board.
2. Peel the smart-card reader FFC from the palm-rest and keyboard assembly.
3. Remove the two screws (M1.6x1.7) that secure the smart-card reader to the palm-rest and keyboard assembly.
4. Lift the smart-card reader module away from the palm-rest and keyboard assembly.

Installing the smart-card reader

CAUTION: The information in this installation section is intended for authorized service technicians only.

Prerequisites

If you are replacing a component, remove the existing component before performing the installation procedure.

About this task

The figure indicates the location of the smart-card reader and provides a visual representation of the installation procedure.

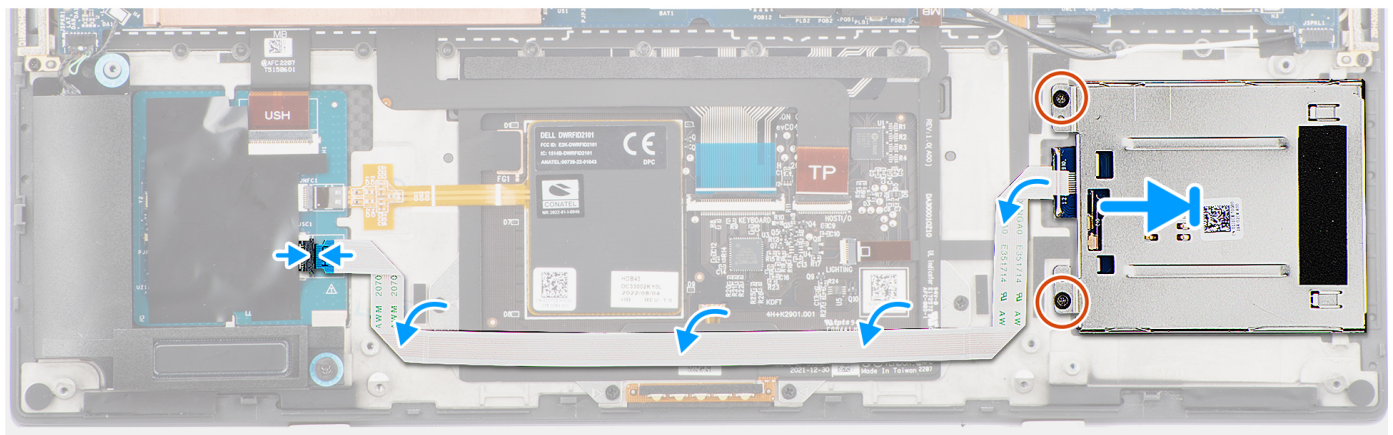
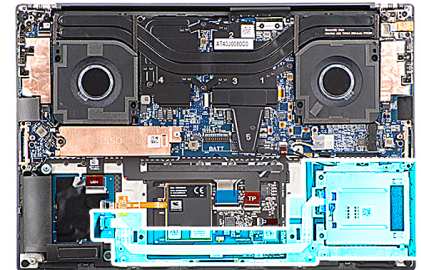

Figure 53. Installing the smart-card reader

Steps

1. Align and place the smart-card reader into its slot on the palm-rest and keyboard assembly.
2. Replace the two screws (M1.6x1.7) to secure the smart-card reader to the palm-rest and keyboard assembly.
3. Adhere the smart-card reader FFC to the palm-rest and keyboard assembly.
4. Connect the smart-card reader FFC to the connector on the USH board.

Next steps

1. Install the [speakers](#).
2. Install the [battery](#).
3. Install the [base cover](#).
4. Follow the procedure in [After working inside your computer](#).

Display assembly

Removing the display assembly

 **CAUTION:** The information in this removal section is intended for authorized service technicians only.

Prerequisites

1. Follow the procedure in [Before working inside your computer](#).
2. Remove the [base cover](#).

About this task

The figure indicates the location of the display assembly and provides a visual representation of the removal procedure.

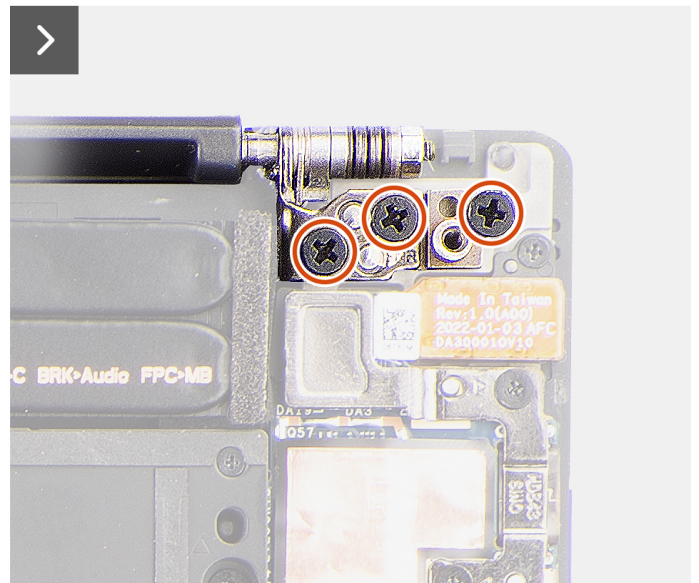
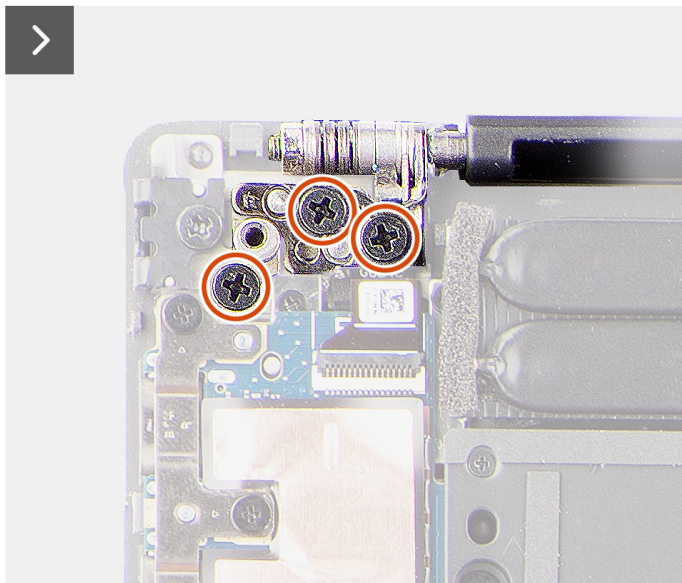
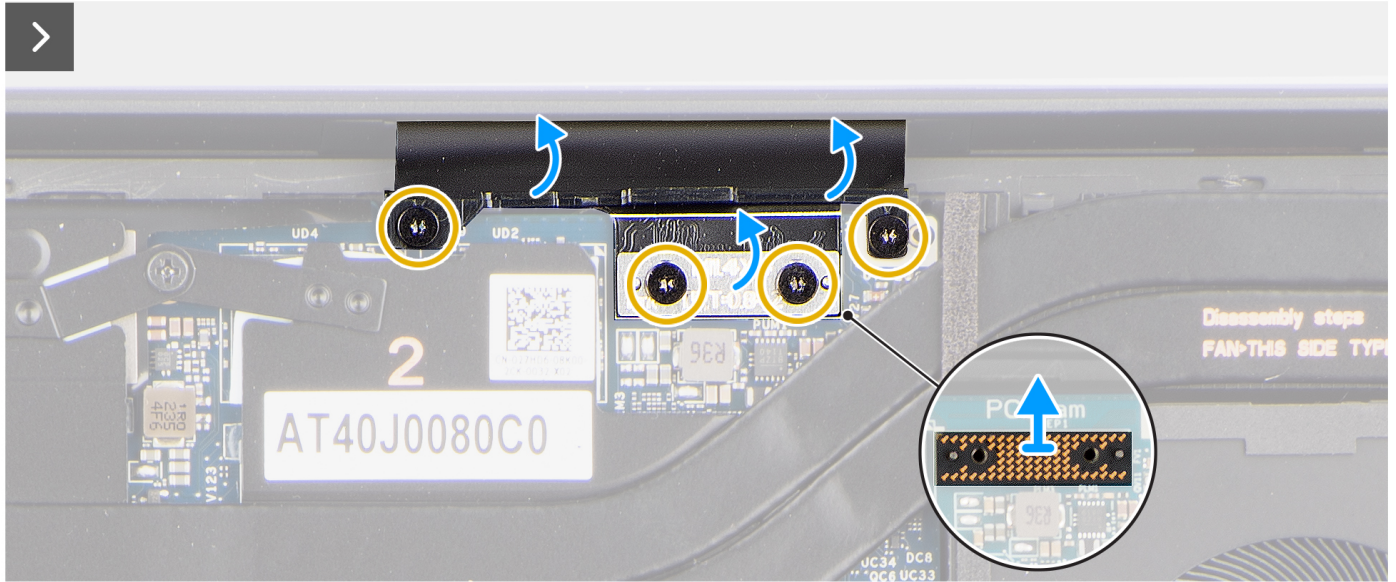
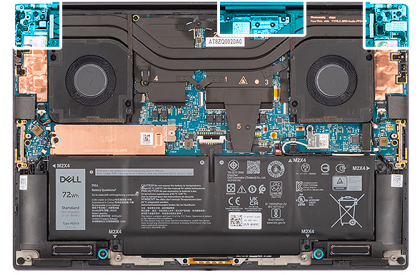

Figure 54. Removing the display assembly

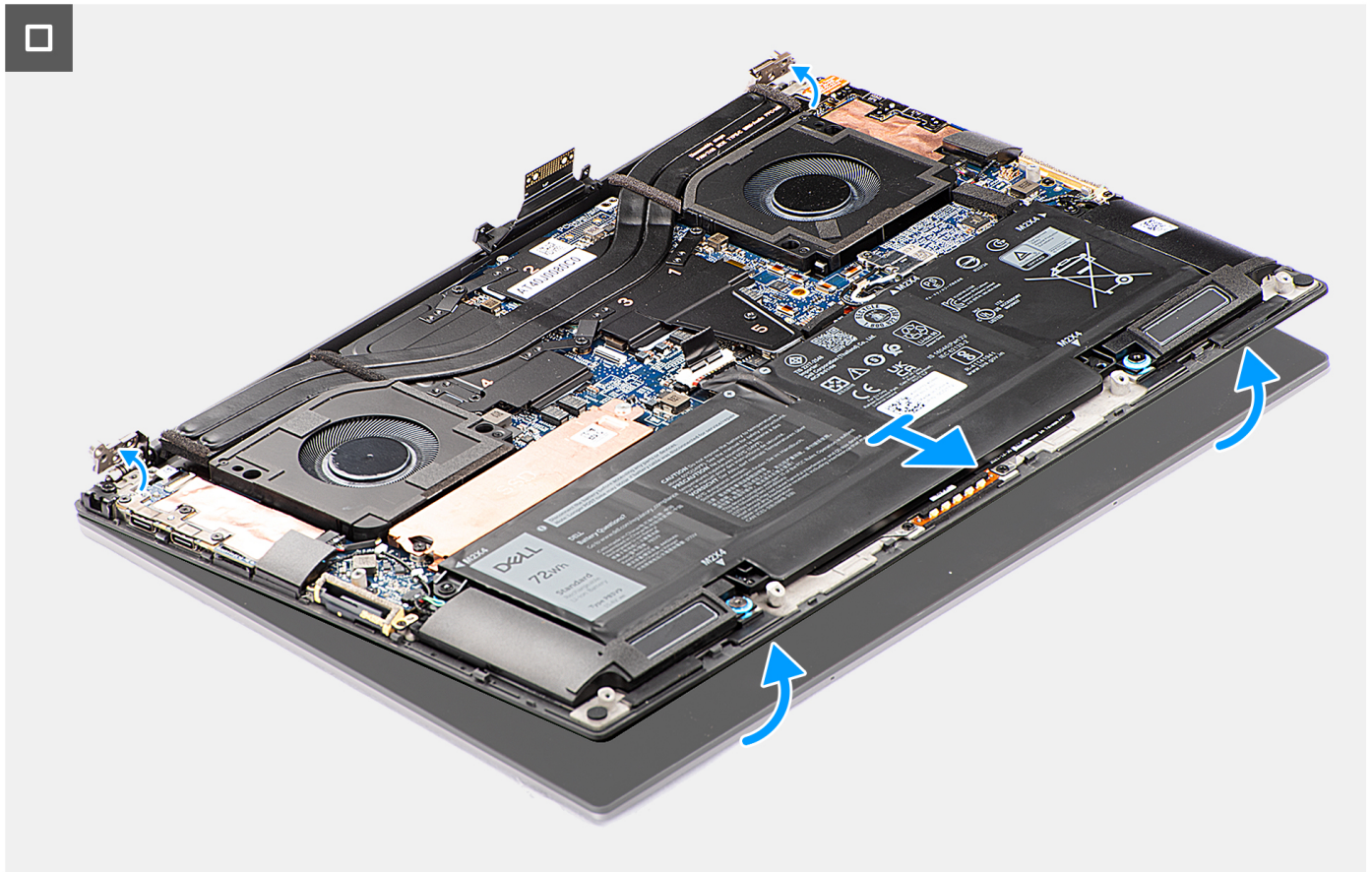
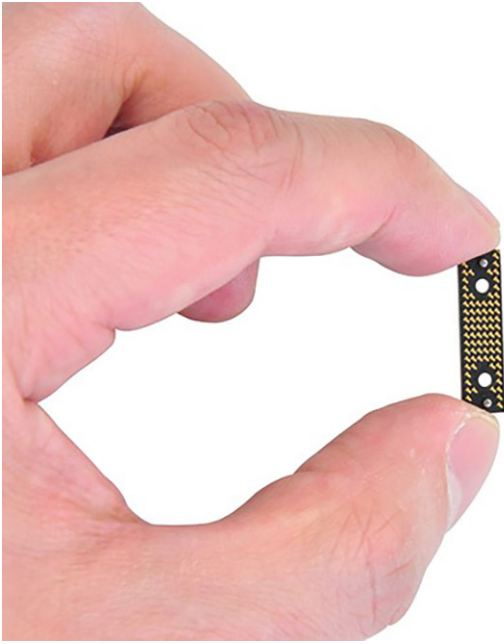

Figure 55. Removing the display assembly

Steps

1. Remove the two Torx screws (T5, M1.4x4) that secure the display FPC holder to the system board.
2. Remove the two Torx screws (T5, M1.4x4) that secure the display FPC to the system board.
3. Disconnect the display FPC from the system board and remove the interposer board.

CAUTION: The pins on the interposer board are fragile. Do not push or apply pressure to the pins on the interposer board or perform any action that may scratch the pins, such as rotating or turning the board while they are in contact with any surface. When handling the interposer board, lift and hold the board from the edges or the sides.



4. Remove the six screws (M2.5x5) that secure the display hinges to the palm-rest and keyboard assembly.
 5. Slide the bottom assembly slightly to the left and then move it away from the display assembly.
- NOTE:** The display assembly is a Hinge-Up Design (HUD) assembly and cannot be further disassembled once it is removed from the bottom chassis. If any components in the display assembly are malfunctioning, then you must replace the entire display assembly.

Installing the display assembly

CAUTION: The information in this installation section is intended for authorized service technicians only.

Prerequisites

If you are replacing a component, remove the existing component before performing the installation procedure.

About this task

The figure indicates the location of the display assembly and provides a visual representation of the installation procedure.



6x
M2.5x5



4x
M1.4x4, T5

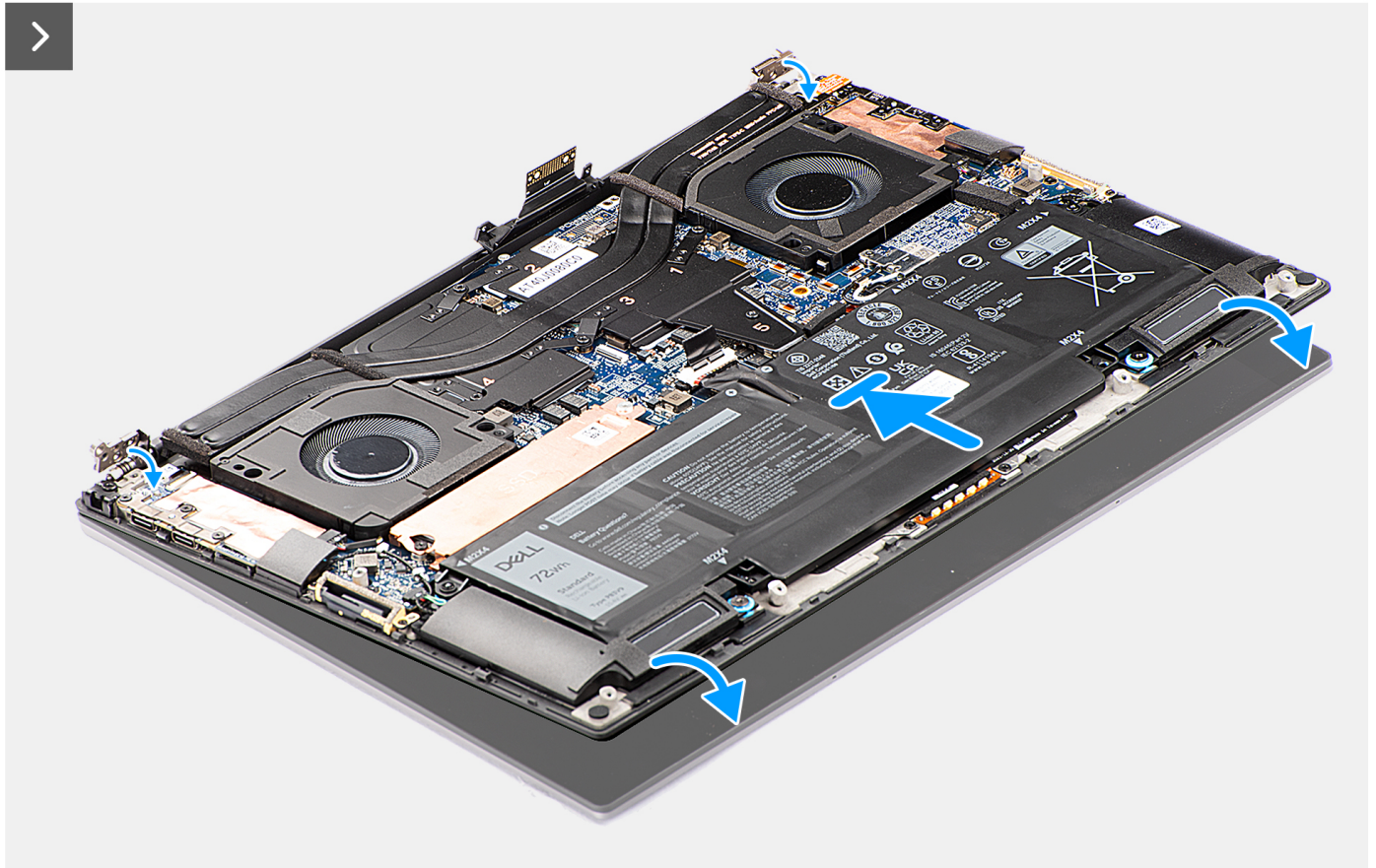
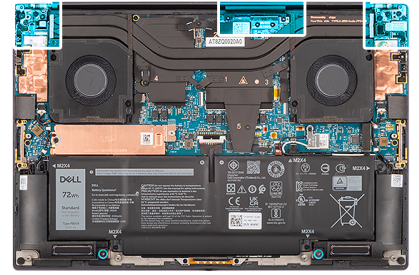

Figure 56. Installing the display assembly

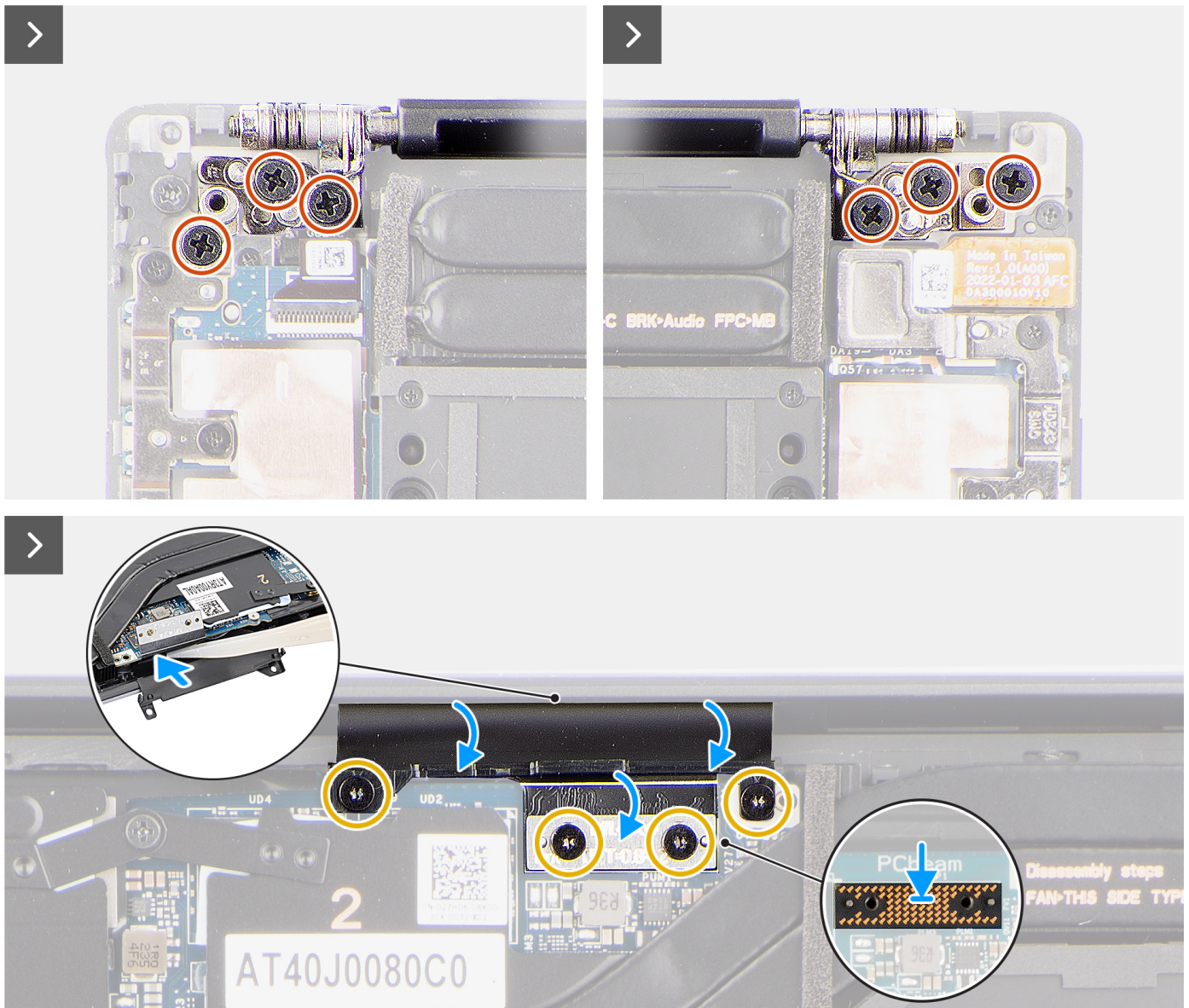

Figure 57. Installing the display assembly

Steps

1. Align the screw holes on the display hinges to the screw holes on the palm-rest and keyboard assembly.
2. Replace the six screws (M2.5x5) to secure the display assembly to the palm-rest and keyboard assembly.
3. Use a plastic scribe to tuck the display FPC into the gap between the system board and the bottom assembly until the white line on the display connector lines up with the edge of the system board.
4. Place the interposer board and connect the display FPC to the system board.
5. Replace the two Torx screws (T5, M1.4x4) to secure the display FPC to the system board.
6. Replace the two Torx screws (T5, M1.4x4) to secure the display FPC holder to the system board.

Next steps

1. Install the [base cover](#).
2. Follow the procedure in [After working inside your computer](#).

System board

Removing the system board

CAUTION: The information in this removal section is intended for authorized service technicians only.

Prerequisites

1. Follow the procedure in [Before working inside your computer](#).
2. Remove the [base cover](#).
3. Remove the [M.2 2230 solid state drive](#) or [M.2 2280 solid state drive](#).
4. Remove the [battery](#).
5. Remove the [processor fan](#).
6. Remove the [graphics-card fan](#).
7. Remove the [audio jack](#).
8. Remove the [heat sink for integrated graphics](#) or [heat sink for discrete graphics](#).

About this task

The following image indicates the connectors on your system board:

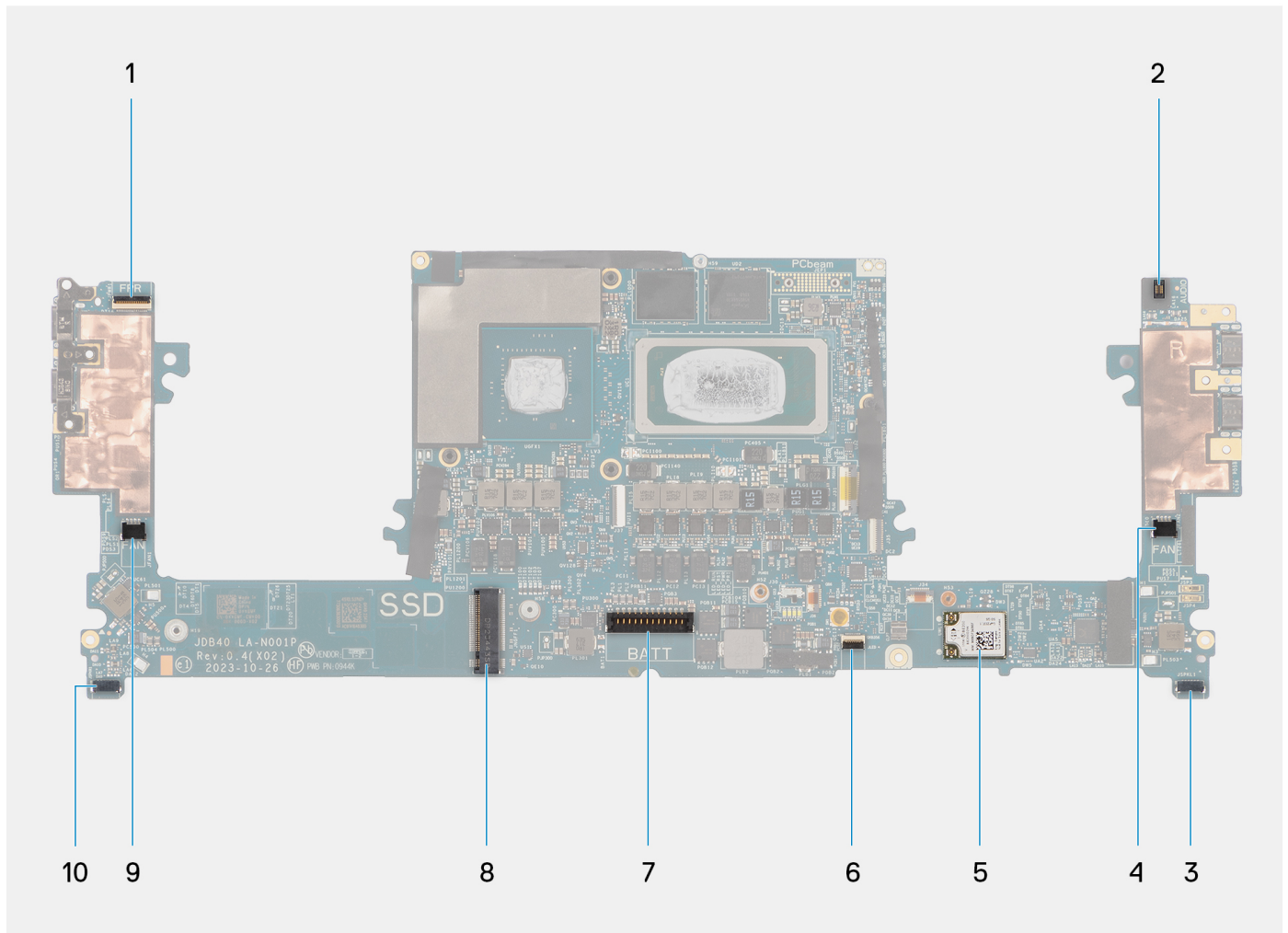

Figure 58. Connectors on your system board

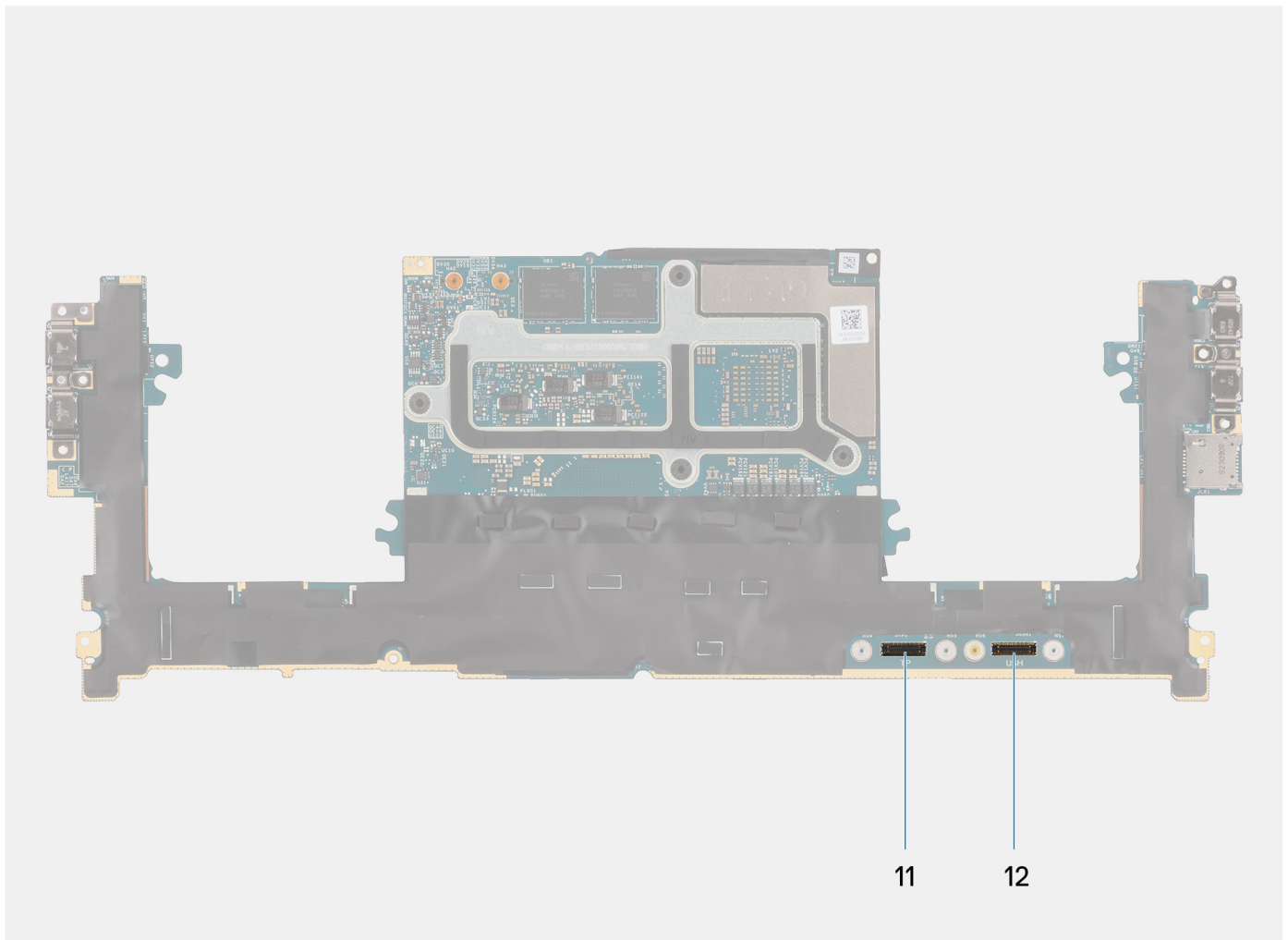

Figure 59. Connectors on your system board

1. Power button with fingerprint reader FPC connector
2. Audio jack FPC connector
3. Processor-fan cable connector
4. Left tweeter speaker cable connector
5. Integrated WLAN card
6. Battery LED FPC connector
7. Battery cable connector
8. M.2 2230/2280 solid state drive slot
9. Graphics-fan cable connector
10. Right tweeter speaker cable connector
11. Touchpad FPC connector
12. USh board FPC connector

The figure indicates the location of the system board and provides a visual representation of the removal procedure.

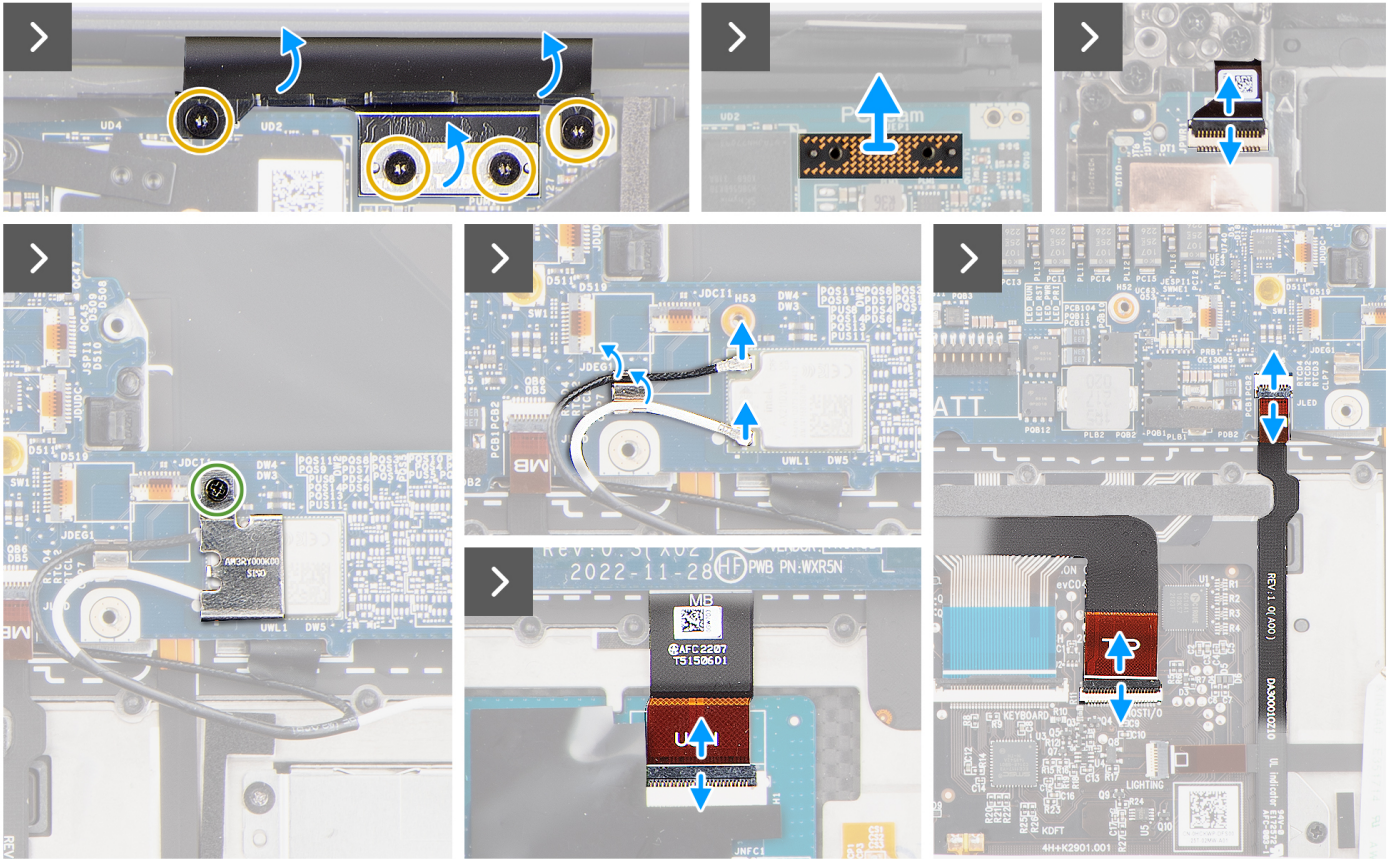
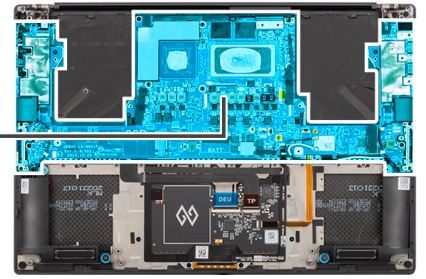
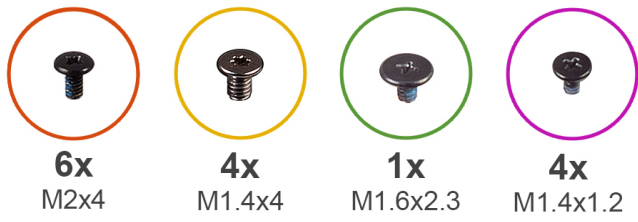

Figure 60. Removing the system board

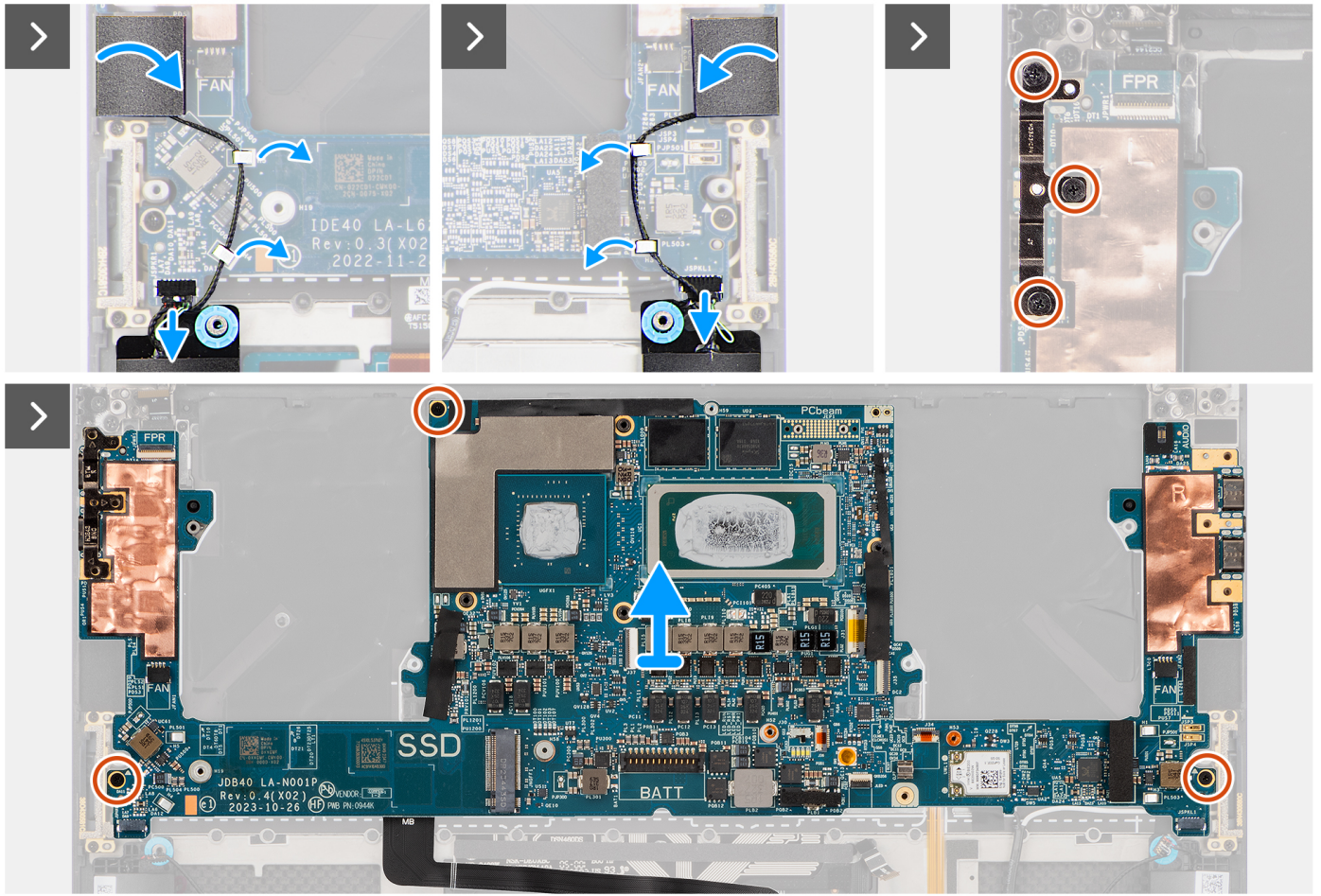

Figure 61. Removing the system board

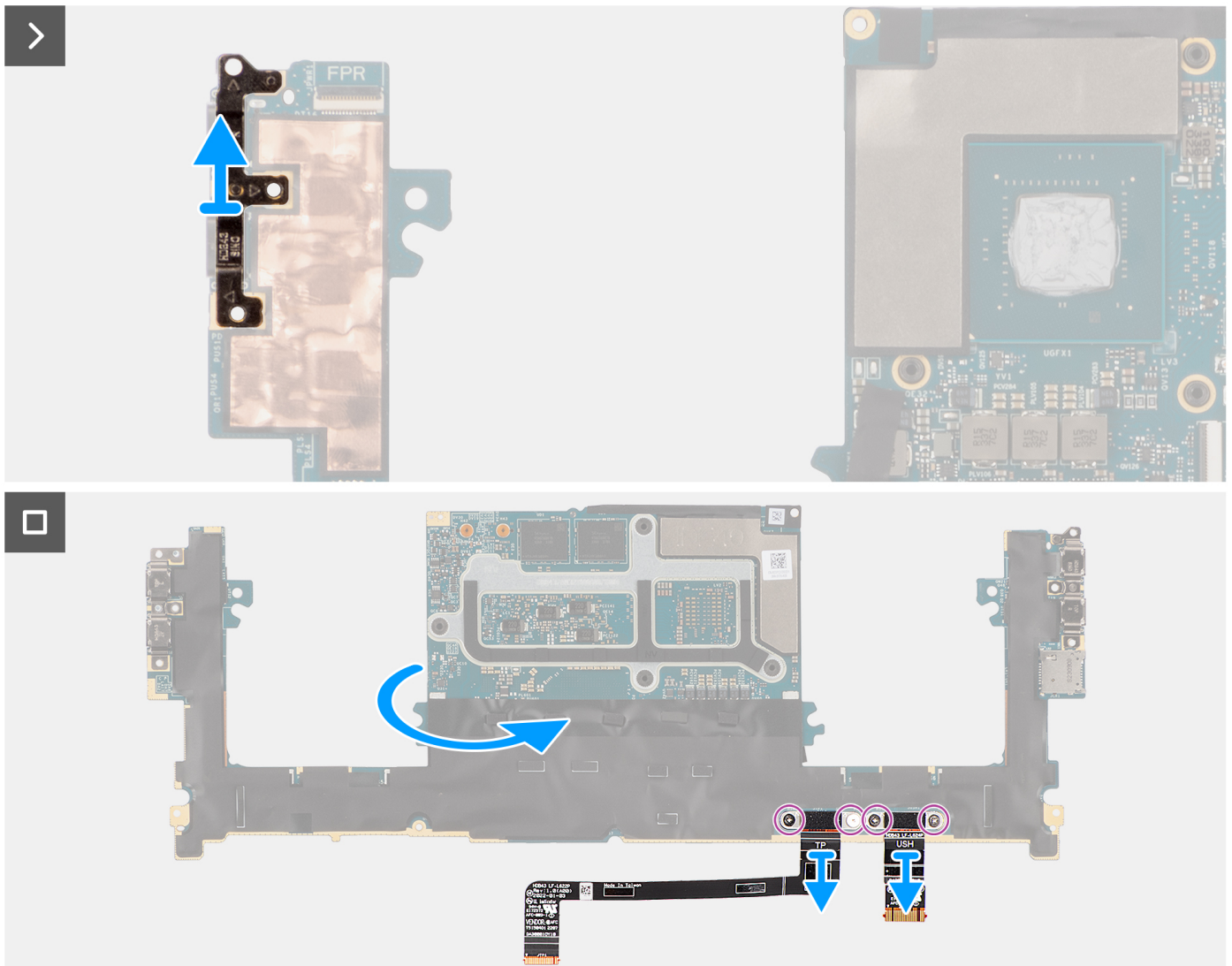

Figure 62. Removing the system board

Steps

1. Remove the four Torx screws (T5, M1.4x4) that secure the display FPC holder and display FPC to the system board.
2. Disconnect the display FPC from the system board and remove the interposer board.

CAUTION: Technicians must remove the interposer board immediately after disconnecting the display FPC to prevent the board from falling out of the computer during subsequent removal procedures. The pins on the interposer board are fragile. Avoid contact with the pins on the board. Instead, handle the board by lifting and holding from the edges or the sides.

3. Loosen the single captive screw (M1.6x2.3) that secure the WLAN bracket to the system board.
4. Disconnect the antenna cables from the WLAN module and unroute them from the metal clips on the system board.
5. Open the latch and disconnect the power button board with fingerprint reader FPC from the system board.
6. Open the latch and disconnect the USH board FPC (for models that are shipped with a USH board) and touchpad FPC from their respective connectors.
7. Open the latch and disconnect the battery LED FPC from the system board.
8. Peel the left and right tweeter speakers from their compartments on the palm-rest and keyboard assembly.
9. Unroute the tweeter speaker cables from the metal clips on the system board.
10. Disconnect the left and right speaker cables from the system board.
11. Remove the three screws (M2x4) that secure the right USB Type-C bracket to the system board.
12. Remove the three screws (M2x4) that secure the system board to the palm-rest and keyboard assembly.

13. Remove the system board from the palm-rest and keyboard assembly.
14. Remove the USB Type-C bracket from the upper-right side of the system board.
 - NOTE:** The new replacement system board is preassembled with the USB Type-C brackets. Only the USB Type-C bracket at the upper-right side of the system board must be removed.
15. Flip-over the system board and remove the four screws (M1.4x1.2) that secure the USH board FPC (for models that are shipped with a USH board) and touchpad FPC to the system board.
16. Remove the USH board FPC (for models that are shipped with a USH board) and touchpad FPC away from the system board.
 - NOTE:** The USH board FPC and touchpad FPC must be transferred to the new replacement system board.
 - NOTE:** Do not remove the USB Type-C brackets from the bottom side of the system board.

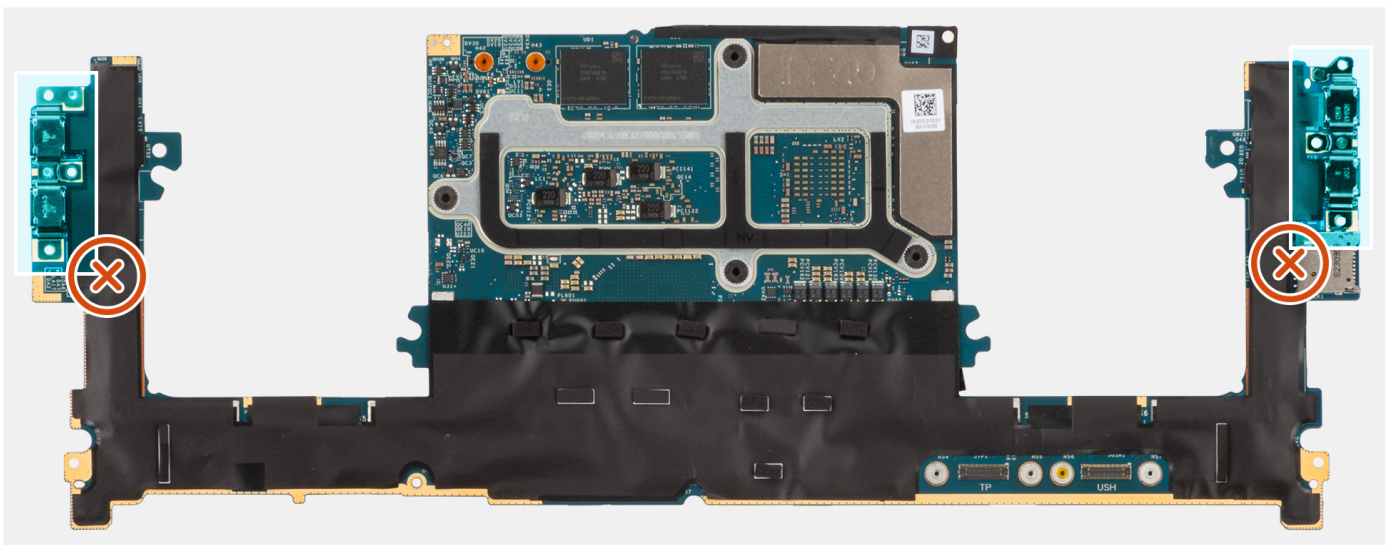

Figure 63. USB Type-C brackets at the bottom side of the system board

Installing the system board

CAUTION: The information in this installation section is intended for authorized service technicians only.

Prerequisites

If you are replacing a component, remove the existing component before performing the installation procedure.

About this task

The following image indicates the connectors on your system board:

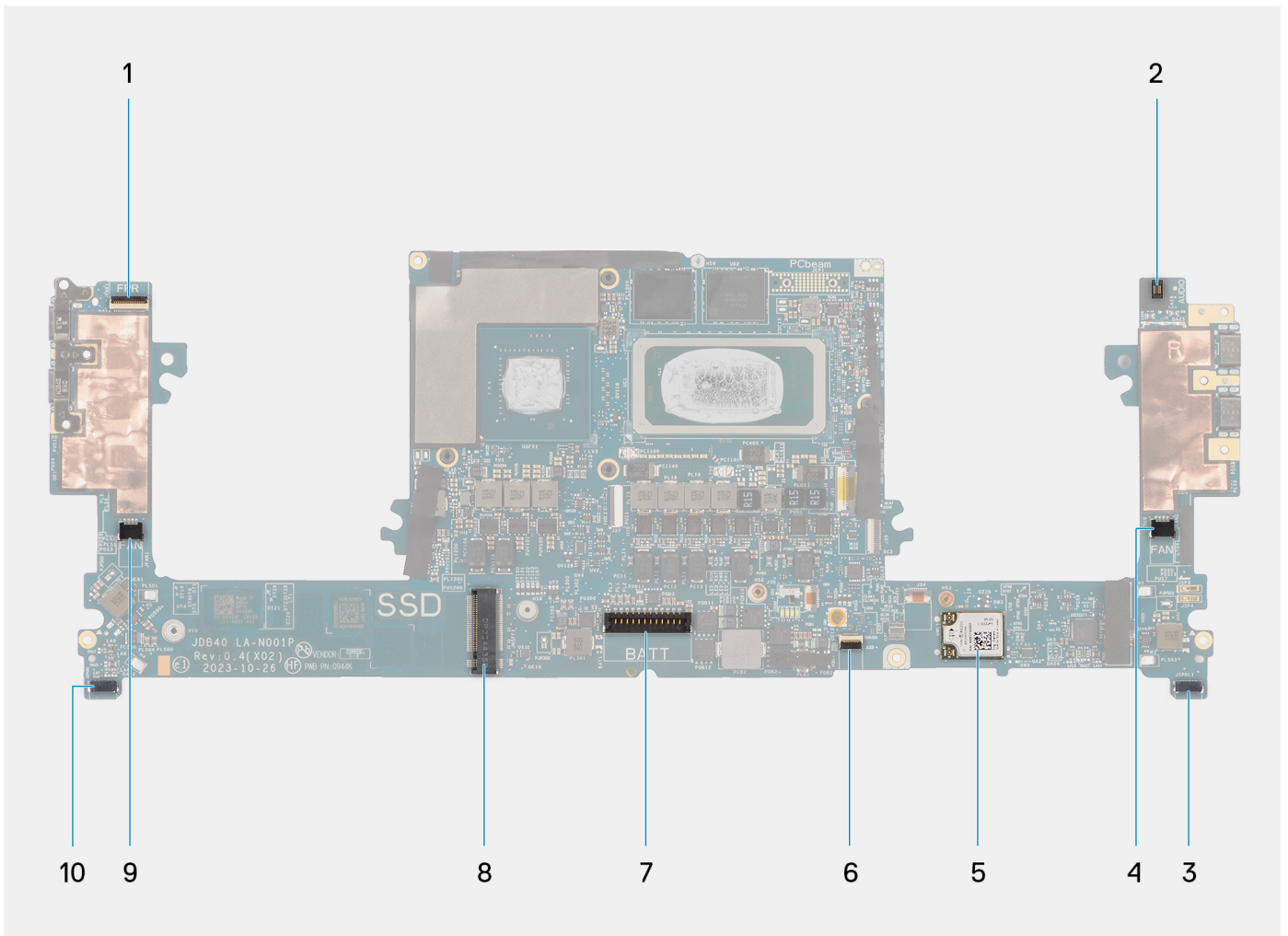

Figure 64. Connectors on your system board

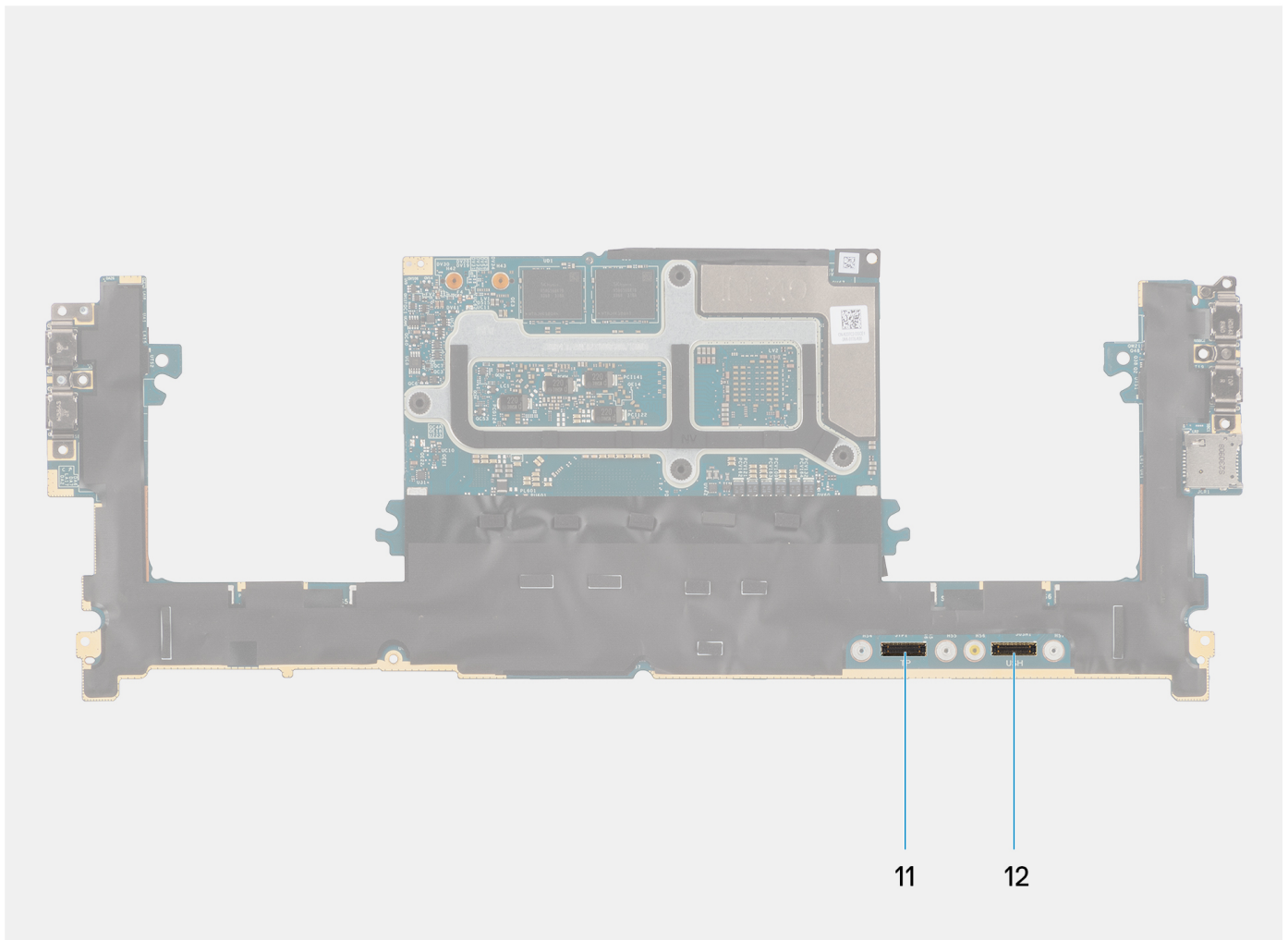

Figure 65. Connectors on your system board

1. Power button with fingerprint reader FPC connector
2. Audio jack FPC connector
3. Processor-fan cable connector
4. Left tweeter speaker cable connector
5. Integrated WLAN card
6. Battery LED FPC connector
7. Battery cable connector
8. M.2 2230/2280 solid state drive slot
9. Graphics-card fan cable connector
10. Right tweeter speaker cable connector
11. Touchpad FPC connector
12. USH board FPC connector

The figure indicates the location of the system board and provides a visual representation of the installation procedure.



6x
M2x4



4x
M1.4x4



1x
M1.6x2.3



4x
M1.4x1.2

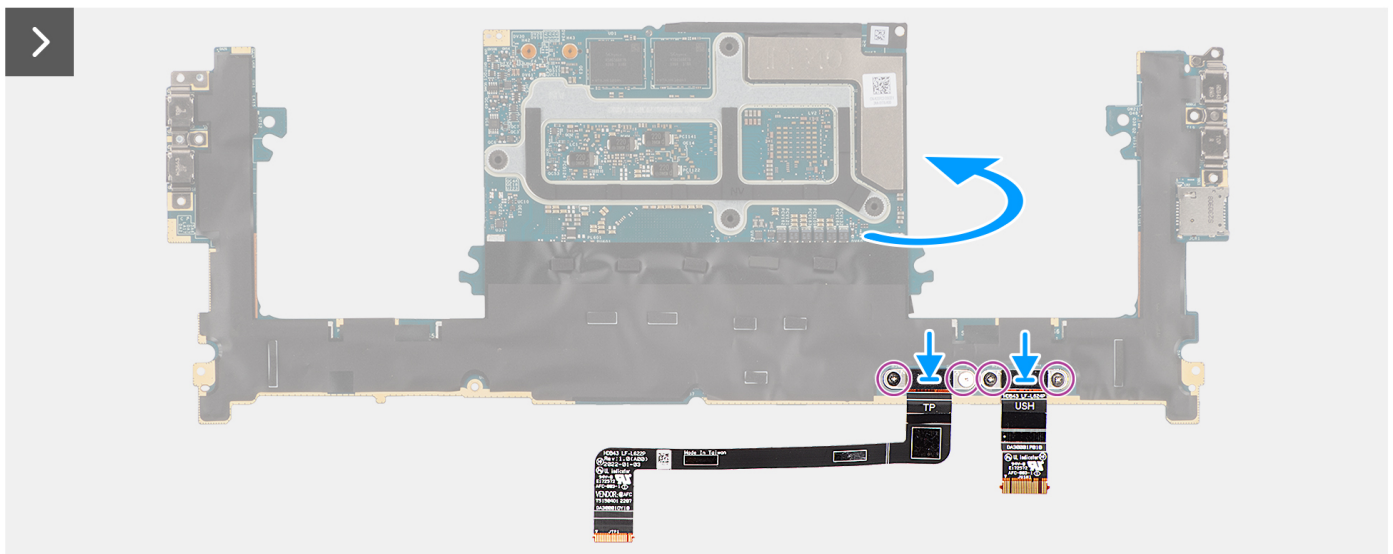
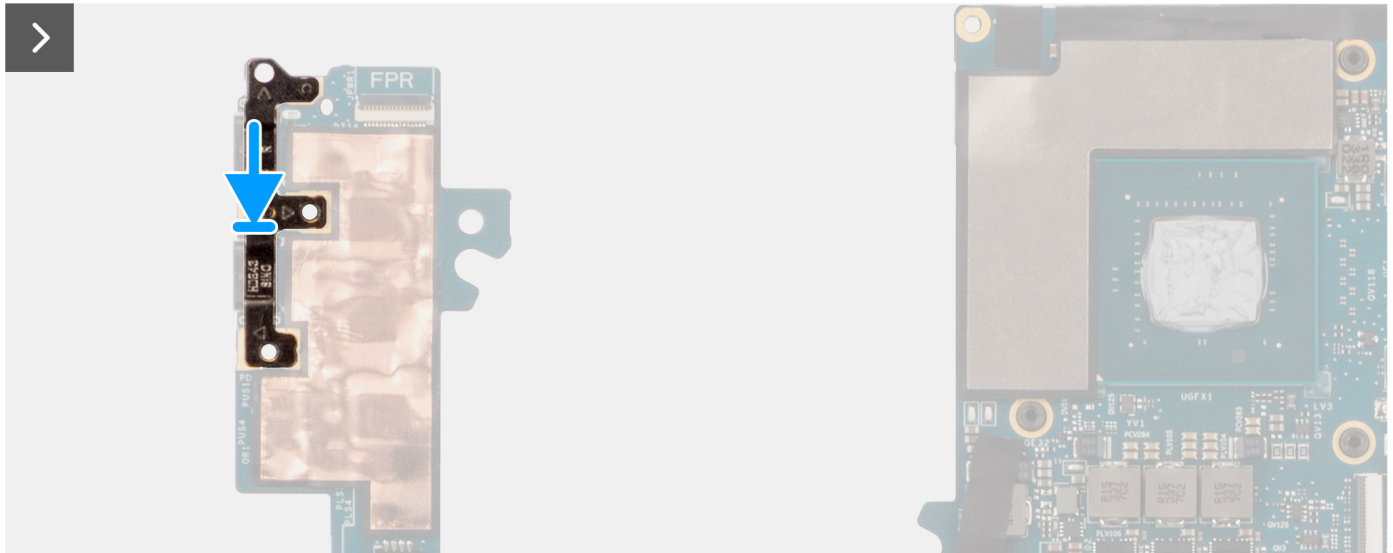
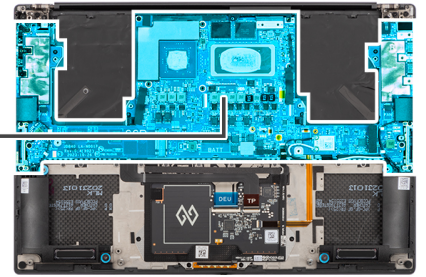

Figure 66. Installing the system board

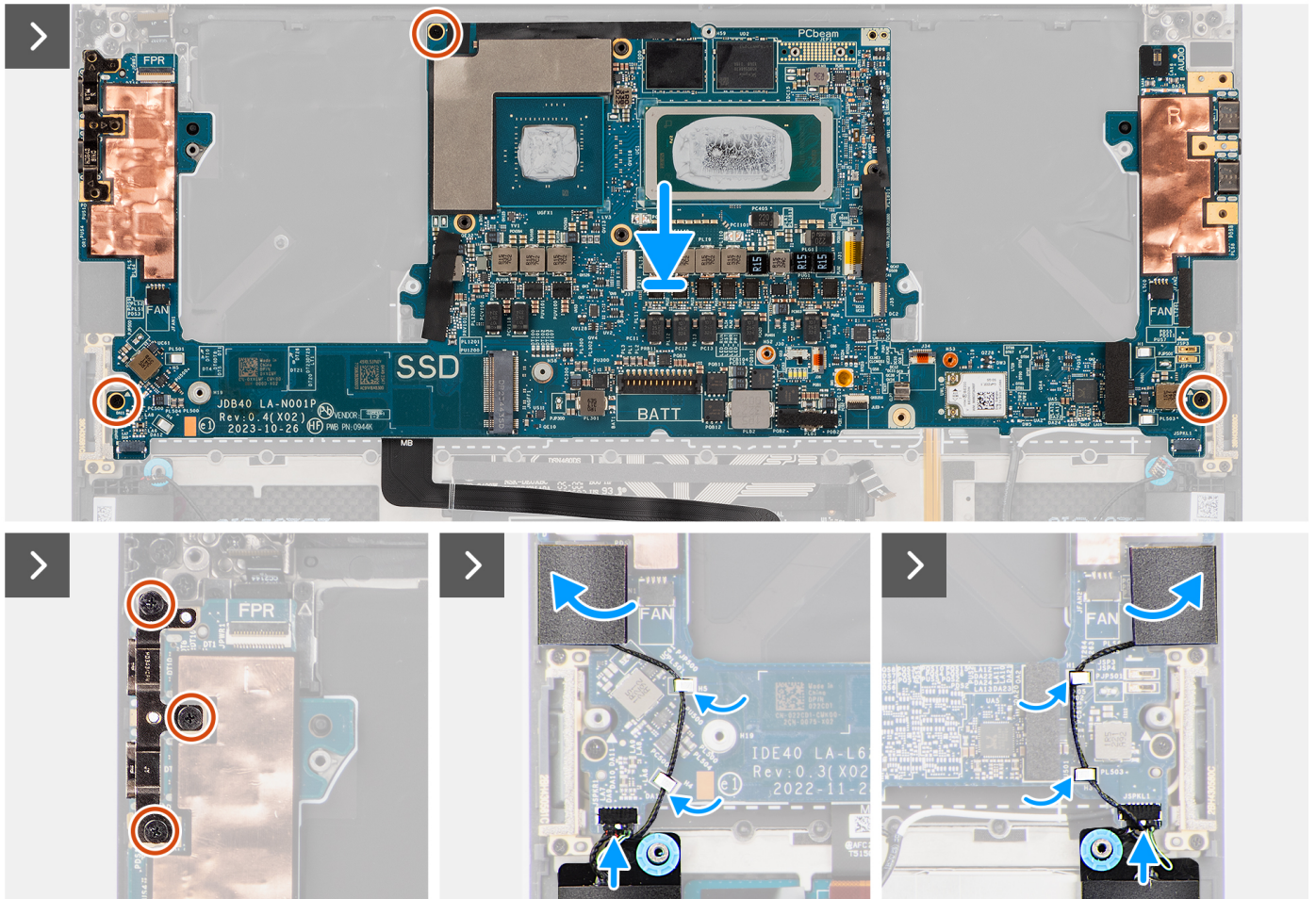

Figure 67. Installing the system board

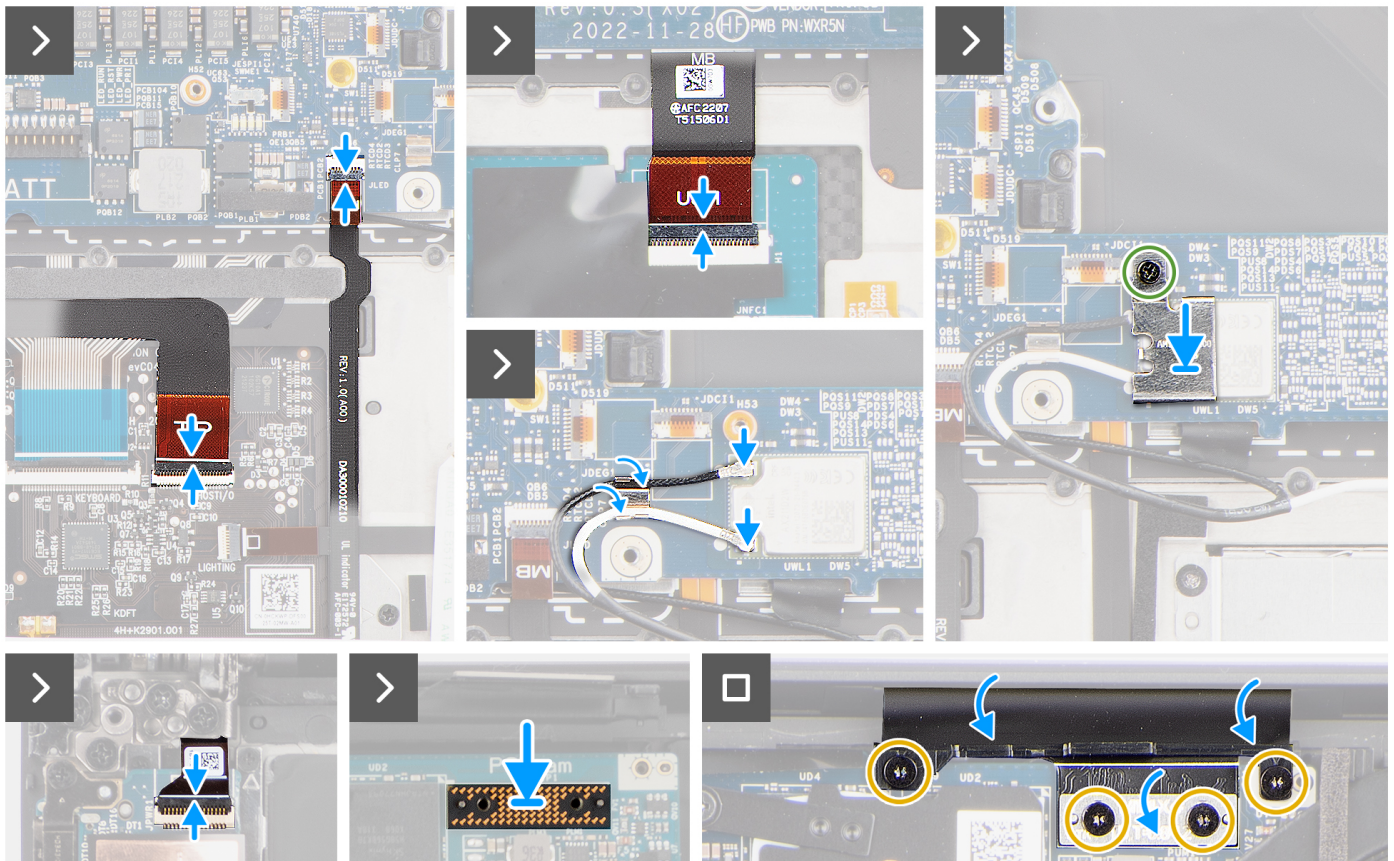

Figure 68. Installing the system board

Steps

1. Align the screw holes on the USH board FPC (for models that are shipped with a USH board) and touchpad FPC.
2. Replace the four screws (M1.4x1.2) to secure the USH board FPC (for models that are shipped with a USH board) and touchpad FPC to the system board.
3. Flip-over the system board and align the screw holes on the system board with the holes on the palm-rest and keyboard assembly.
4. Replace the USB Type-C bracket at the upper-right side of the system board.
5. Replace the three screws (M2x4) to secure the system board to the palm-rest and keyboard assembly.
6. Replace the three screws (M2x4) to secure the right USB Type-C bracket on the system board.
7. Adhere the left and right tweeter speakers to their compartments on the palm-rest and keyboard assembly and route the speaker cables through the metal clips on the system board.
8. Connect the left and right speaker cables to the connectors on the system board.
9. Connect the battery LED FPC to the system board and close the latch.
10. Connect the USH board FPC (for models that are shipped with a USH board) and touchpad FPC to their respective connectors and close the latch.
11. Connect the power button board with fingerprint reader FPC to the connector on the system board and close the latch.
12. Route the WLAN antenna cables using the metal clips on the system board and connect them to the WLAN module.
13. Tighten the single captive screw (M1.6x2.3) to secure the WLAN bracket on the system board.
14. Place the interposer board and connect the display FPC to the system board.
15. Replace the four Torx screws (T5, M1.4x4) to secure the display FPC holder and display FPC to the system board.

Next steps

1. Install the [heat sink for integrated graphics](#) or [heat sink for discrete graphics](#).
2. Install the [audio jack](#).
3. Install the [graphics-card fan](#).
4. Install the [processor fan](#).

5. Install the [battery](#).
6. Install the [M.2 2230 solid state drive](#) or [M.2 2280 solid state drive](#).
7. Install the [base cover](#).
8. Follow the procedure in [After working inside your computer](#).

Power button with fingerprint reader

Removing the power-button board with a fingerprint reader

CAUTION: The information in this removal section is intended for authorized service technicians only.

Prerequisites

1. Follow the procedure in [Before working inside your computer](#).
2. Remove the [base cover](#).
3. Remove the [M.2 2230 solid state drive](#) or [M.2 2280 solid state drive](#).
4. Remove the [battery](#).
5. Remove the [processor fan](#).
6. Remove the [graphics-card fan](#).
7. Remove the [audio jack](#).
8. Remove the [display assembly](#).
9. Remove the [system board](#).

NOTE: The system board can be removed or installed together with the heat sink attached. This simplifies the procedure and avoids breaking the thermal bond between the system board and the heat sink.

About this task

The figure indicates the location of the power-button board with fingerprint reader and provides a visual representation of the removal procedure.

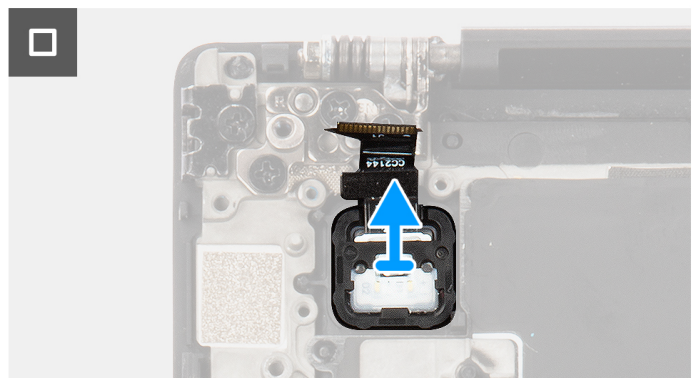
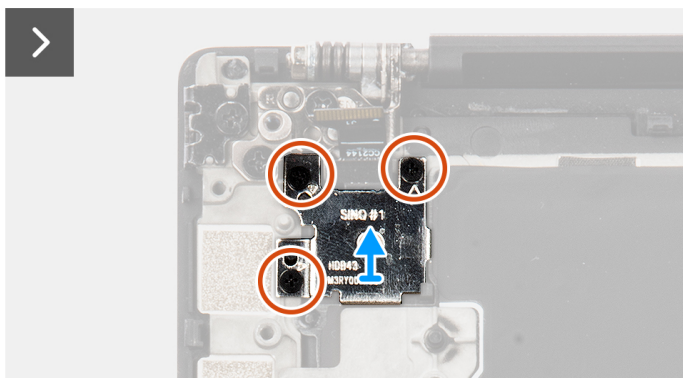
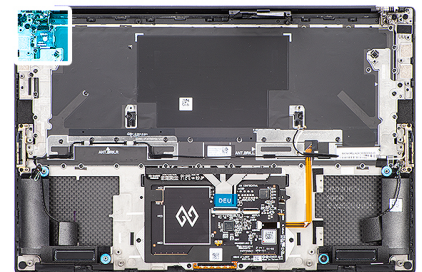

Figure 69. Removing the power-button board with fingerprint reader

Steps

1. Remove the three screws (M1.6x2) that secure the fingerprint-reader bracket to the power-button board.

2. Remove the fingerprint-reader bracket from the power-button board.
3. Remove the power-button board with power-button FPC from the palm-rest and keyboard assembly.

Installing the power-button board with a fingerprint reader

CAUTION: The information in this installation section is intended for authorized service technicians only.

Prerequisites

If you are replacing a component, remove the existing component before performing the installation procedure.

About this task

The figure indicates the location of the power-button board with fingerprint reader and provides a visual representation of the installation procedure.



3x
M1.6x2

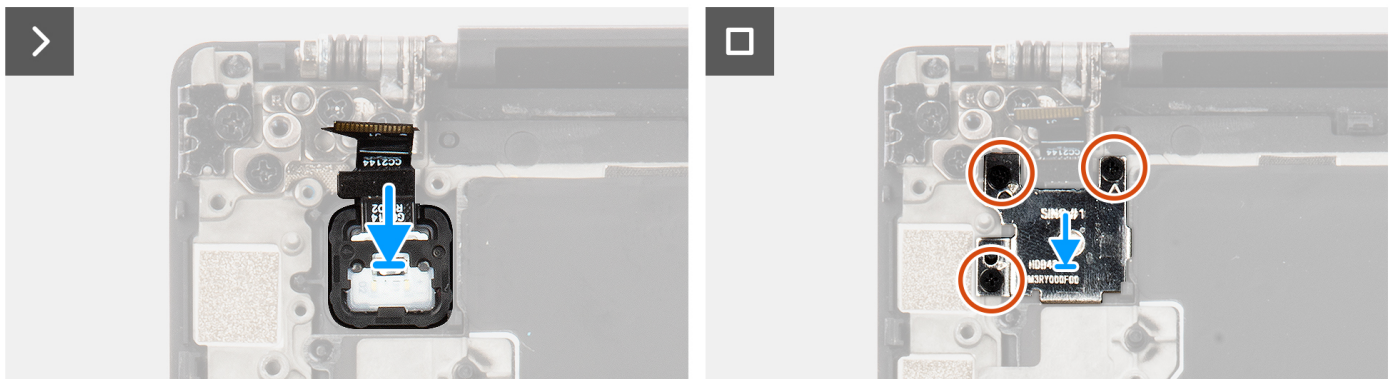
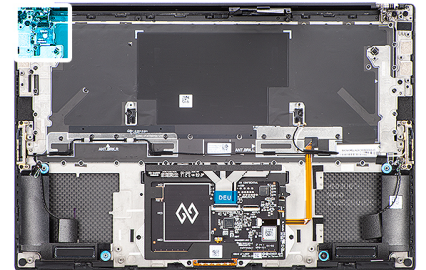

Figure 70. Installing the power-button board with fingerprint reader

Steps

1. Align and place the power-button board with a power-button FPC into its slot on the palm-rest and keyboard assembly.
2. Align and place the fingerprint-reader bracket on the power-button board.
3. Replace the three screws (M1.6x2) to secure the fingerprint-reader bracket to the power-button board.

Next steps

1. Install the [system board](#).
2. Install the [display assembly](#).
3. Install the [audio jack](#).
4. Install the [graphics-card fan](#).
5. Install the [processor fan](#).
6. Install the [battery](#).
7. Install the [M.2 2230 solid state drive](#) or [M.2 2280 solid state drive](#).
8. Install the [base cover](#).
9. Follow the procedure in [After working inside your computer](#).

USH-board FPC

Removing the USH-board FPC

CAUTION: The information in this removal section is intended for authorized service technicians only.

Prerequisites

1. Follow the procedure in [Before working inside your computer](#).
2. Remove the [base cover](#).
3. Remove the [M.2 2230 solid state drive](#) or [M.2 2280 solid state drive](#).
4. Remove the [battery](#).
5. Remove the [processor fan](#).
6. Remove the [graphics-card fan](#).
7. Remove the [audio jack](#).
8. Remove the [system board](#).

NOTE: The system board can be removed or installed together with the heat-sink attached. This simplifies the procedure and avoids breaking the thermal bond between the system board and the heat-sink.

About this task

The figure indicates the location of the USH-board FPC and provides a visual representation of the removal procedure.

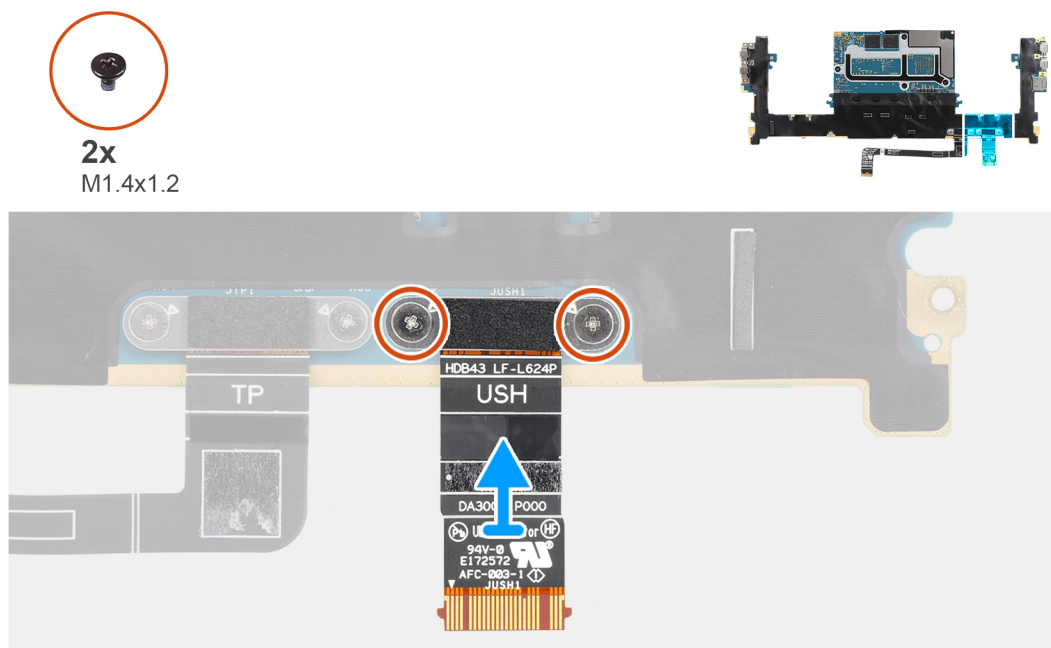

Figure 71. Removing the USH-board FPC

Steps

1. Remove the two screws (M1.4x1.2) that secure the USH-board FPC on the system board.
2. Remove the USH-board FPC from the system board.

Installing the USH-board FPC

CAUTION: The information in this installation section is intended for authorized service technicians only.

Prerequisites

If you are replacing a component, remove the existing component before performing the installation procedure.

About this task

The figure indicates the location of the USH-board FPC and provides a visual representation of the installation procedure.

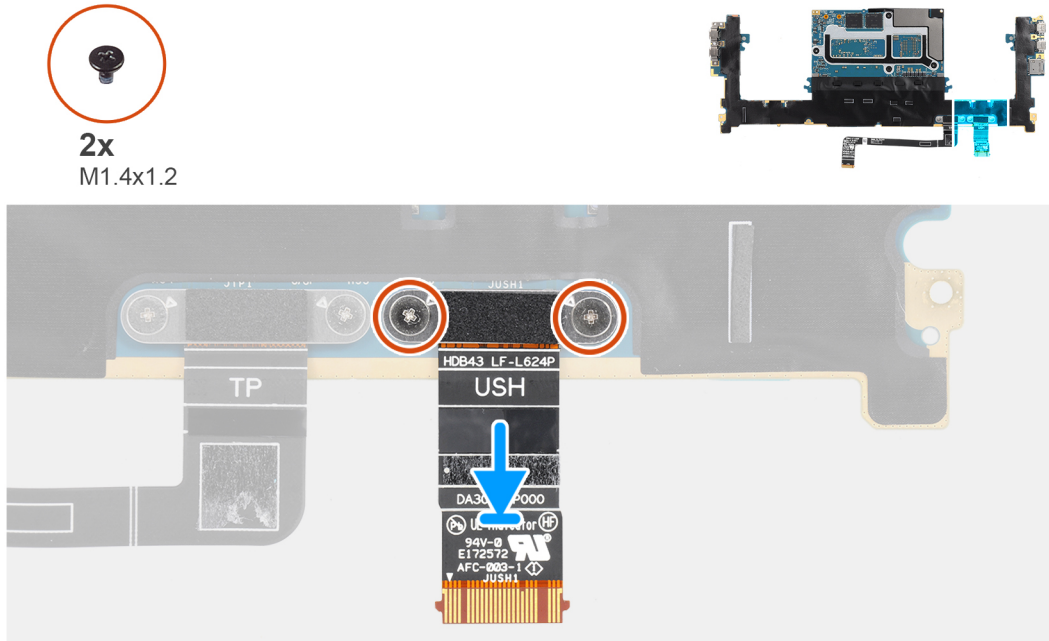

Figure 72. Installing the USH-board FPC

Steps

1. Align and place the USH-board FPC on the system board.
2. Replace the two screws (M1.4x1.2) to secure the USH-board FPC to the system board.

Next steps

1. Install the [system board](#).
2. Install the [audio jack](#).
3. Install the [graphics-card fan](#).
4. Install the [processor fan](#).
5. Install the [battery](#).
6. Install the [M.2 2230 solid state drive](#) or [M.2 2280 solid state drive](#).
7. Install the [base cover](#).
8. Follow the procedure in [After working inside your computer](#).

WLAN antennas

Removing the WLAN antennas

CAUTION: The information in this removal section is intended for authorized service technicians only.

Prerequisites

1. Follow the procedure in [Before working inside your computer](#).
2. Remove the [base cover](#).

3. Remove the [M.2 2230 solid state drive](#) or [M.2 2280 solid state drive](#).
4. Remove the [battery](#).
5. Remove the [processor fan](#).
6. Remove the [graphics-card fan](#).
7. Remove the [audio jack](#).
8. Remove the [system board](#).

NOTE: The system board can be removed or installed together with the heat-sink attached. This simplifies the procedure and avoids breaking the thermal bond between the system board and the heat-sink.

About this task

The figure indicates the location of the WLAN antennas and provides a visual representation of the removal procedure.



4x
M1.4x2.5

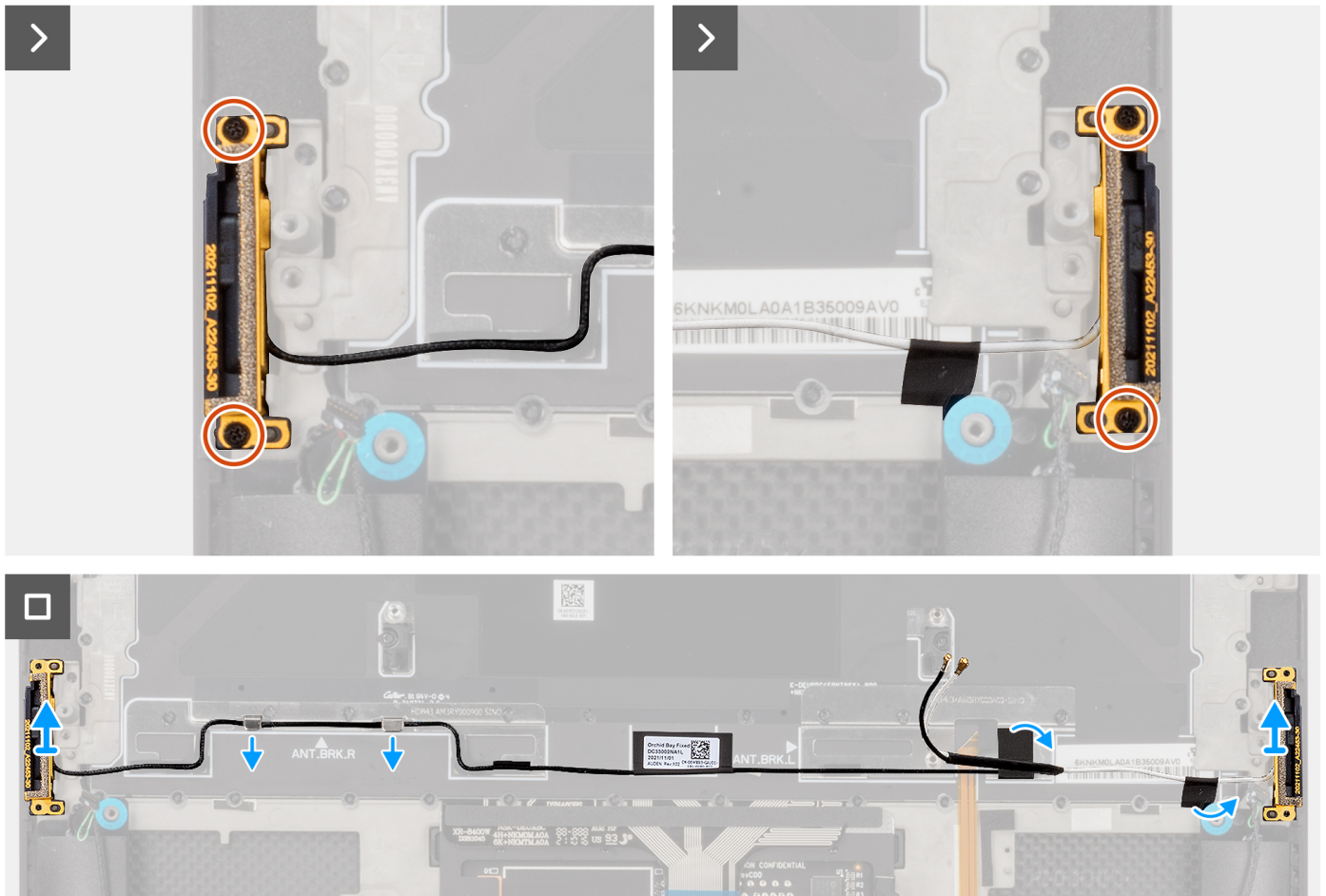
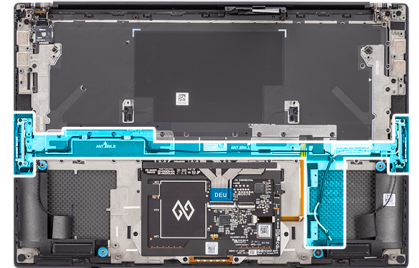

Figure 73. Removing the WLAN antennas

Steps

1. Remove the two captive screws (M1.4x2.5) that secure the auxiliary antenna on the palm-rest and keyboard assembly.
2. Remove the two captive screws (M1.4x2.5) that secure the main antenna on the palm-rest and keyboard assembly.

3. Peel the adhesives securing the auxiliary and main antennas to the palm-rest and keyboard assembly.
4. Unroute the auxiliary and main antennas from the routing guides on the palm-rest and keyboard assembly.
5. Lift to remove the auxiliary and main antennas from the palm-rest and keyboard assembly.

Installing the WLAN antennas

CAUTION: The information in this installation section is intended for authorized service technicians only.

Prerequisites

If you are replacing a component, remove the existing component before performing the installation procedure.

About this task

The figure indicates the location of the WLAN antennas and provides a visual representation of the installation procedure.



4x
M1.4x2.5

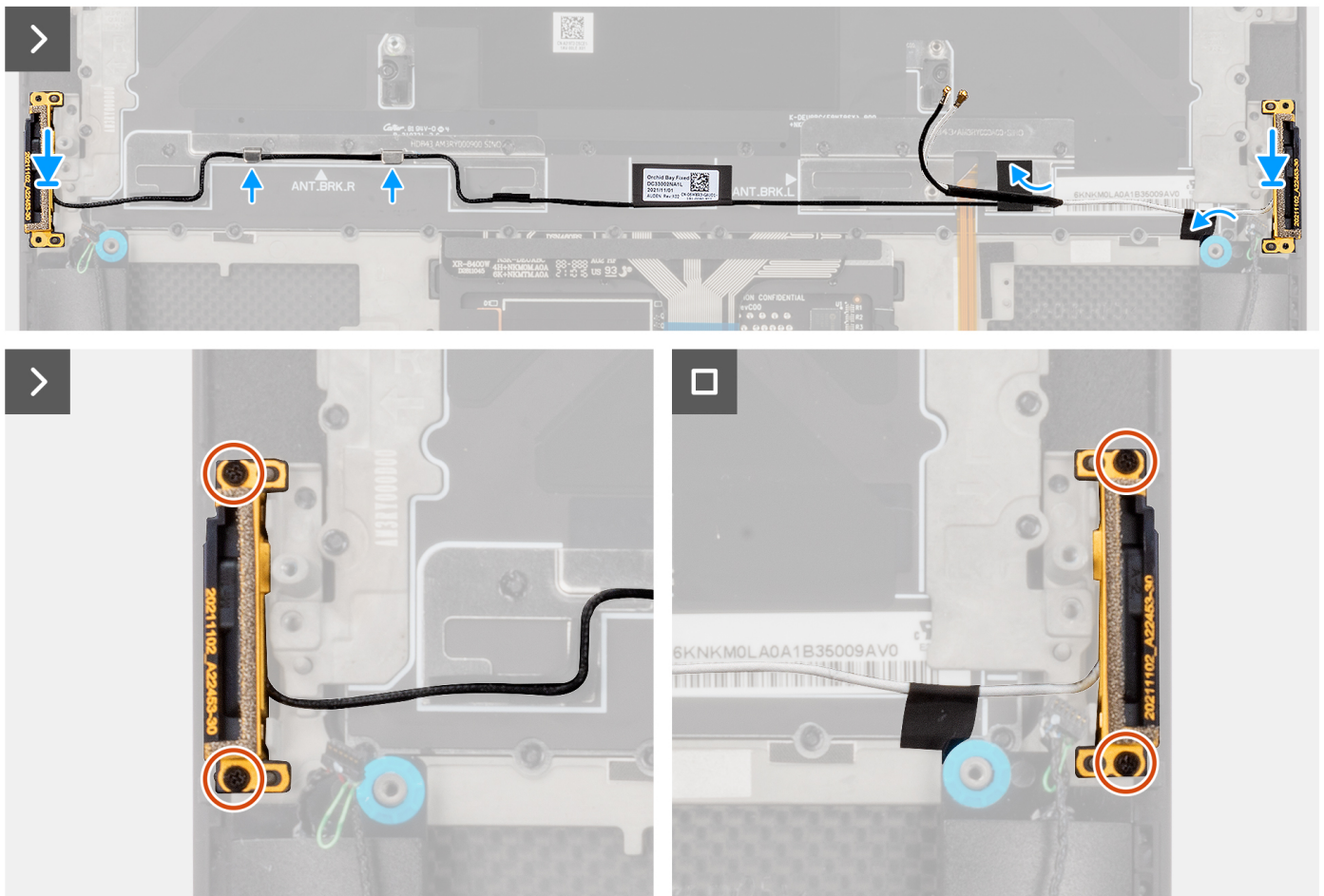
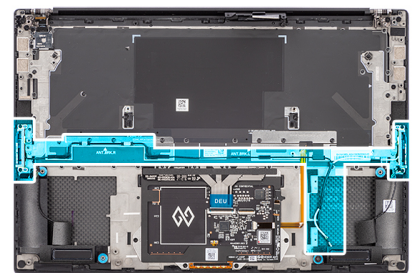

Figure 74. Installing the WLAN antennas

Steps

1. Align and place the auxiliary and main antennas into its slot on the palm-rest and keyboard assembly.
2. Reroute the auxiliary and main antennas using the routing guides on the palm-rest and keyboard assembly.
3. Adhere the tapes securing the auxiliary and main antennas to the palm-rest and keyboard assembly.
4. Replace the two captive screws (M1.4x2.5) to secure the main antenna on the palm-rest and keyboard assembly.
5. Replace the two captive screws (M1.4x2.5) to secure the auxiliary antenna on the palm-rest and keyboard assembly.

Next steps

1. Install the [system board](#).
2. Install the [audio jack](#).
3. Install the [graphics fan](#).
4. Install the [processor fan](#).
5. Install the [battery](#).
6. Install the [M.2 2230 solid state drive](#) or [M.2 2280 solid state drive](#).
7. Install the [base cover](#).
8. Follow the procedure in [After working inside your computer](#).

Palm-rest and keyboard assembly

Removing the palm-rest and keyboard assembly

Prerequisites

1. Follow the procedure in [Before working inside your computer](#).
2. Remove the [base cover](#).
3. Remove the [M.2 2230 solid state drive](#) or [M.2 2280 solid state drive](#).
4. Remove the [battery](#).
5. Remove the [processor fan](#).
6. Remove the [graphics-card fan](#).
7. Remove the [audio jack](#).
8. Remove the [speakers](#).
9. Remove the [display assembly](#).
10. Remove the [system board](#).

 **NOTE:** The system board can be removed or installed together with the heat sink attached. This simplifies the procedure and avoids breaking the thermal bond between the system board and the heat sink.

11. Remove the [power button board with finger print reader](#).
12. Remove the [WLAN antennas](#).

About this task

The following image indicates the palm-rest and keyboard assembly and provides a visual representation of the removal procedure.

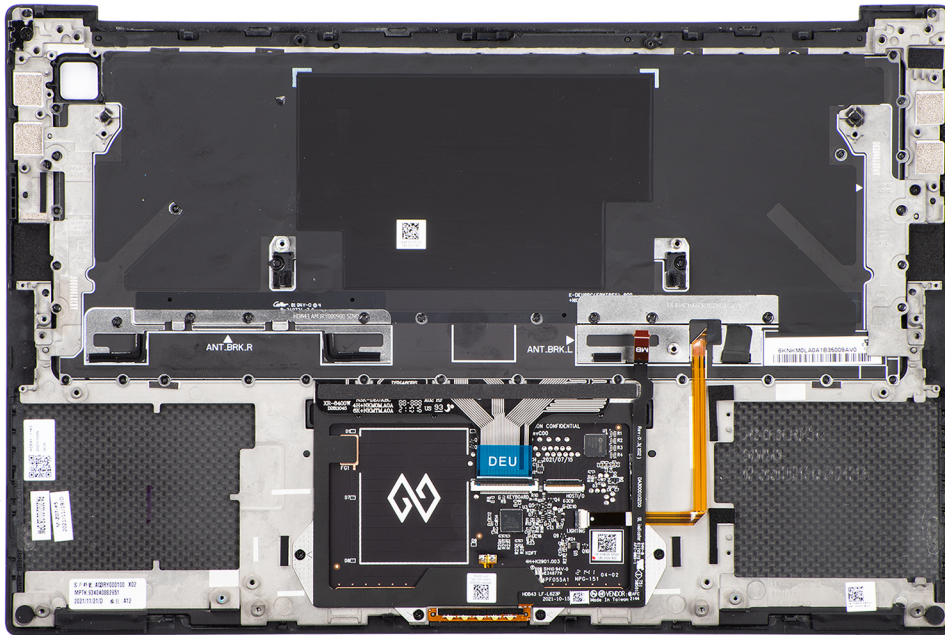

Figure 75. Removing the palm-rest and keyboard assembly

Steps

After performing the steps in the pre-requisites, we are left with the palm-rest and keyboard assembly.

Installing the palm-rest and keyboard assembly

CAUTION: The information in this installation section is intended for authorized service technicians only.

Prerequisites

If you are replacing a component, remove the existing component before performing the installation procedure.

About this task

The following image indicates the palm-rest and keyboard assembly and provides a visual representation of the installation procedure.

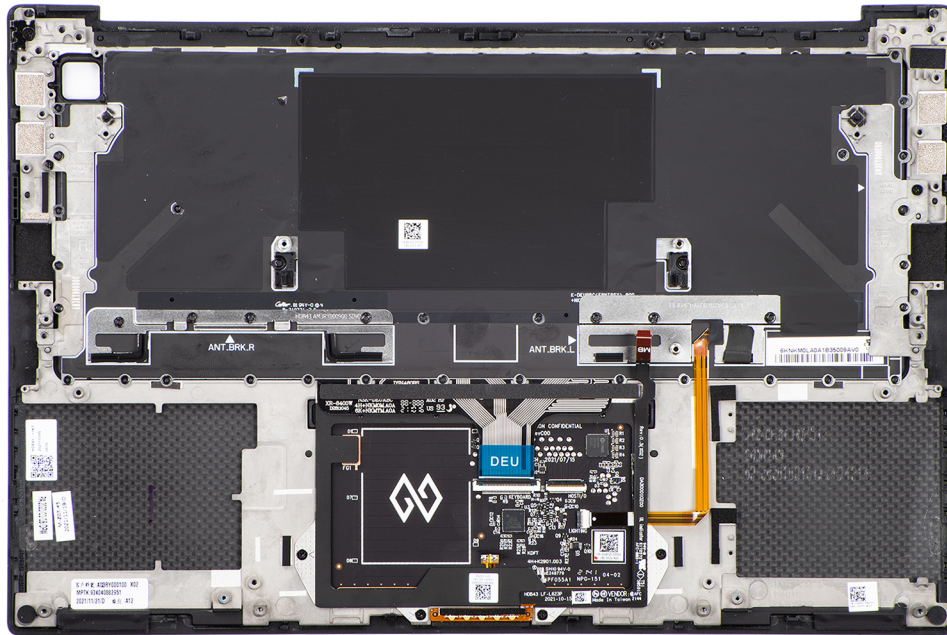

Figure 76. Installing the palm-rest and keyboard assembly

Steps

1. Place the palm-rest assembly on a flat surface.
2. Perform the steps in the prerequisites.

Next steps

1. Install the [WLAN antennas](#).
2. Install the [power-button board with finger print reader](#).
3. Install the [system board](#).
4. Install the [display assembly](#).
5. Install the [speakers](#).
6. Install the [audio jack](#).
7. Install the [graphics-card fan](#).
8. Install the [processor fan](#).
9. Install the [battery](#).
10. Install the [M.2 2230 solid state drive](#) or [M.2 2280 solid state drive](#).
11. Install the [base cover](#).
12. Follow the procedure in [After working inside your computer](#).

Software

This chapter details the supported operating systems along with instructions on how to install the drivers.

Operating system

Your Precision 5490 supports the following operating systems:

- Windows 11 23H2
- Windows 11 22H2
- Windows 10 22H2
- Ubuntu Linux 22.04, 64-bit

Drivers and downloads

When troubleshooting, downloading, or installing drivers, it is recommended that you read the Dell Knowledge Base article [Drivers and Downloads FAQs 000123347](#).

Technology and components

NOTE: Instructions that are provided in the following section are applicable on computers that are shipped with the Windows operating system. Windows is factory-installed with this computer.

Intel Arc Graphics

The following table lists the Intel Arc Graphics specifications.

Table 33. Intel Arc Graphics specifications

Description	Values
Bus type	Integrated graphics NOTE: Intel Arc Graphics uses the computers memory as video memory.
Memory type	Shared with system memory
Graphics level	Intel Core Ultra 5/7/9 processors
Memory interface	64 Gbps, Unified Memory Architecture
Estimated maximum power consumption (TDP)	45 W, in the CPU power
Overlay planes	Yes
Operating systems graphics/ video API support	DirectX 12 Ultimate, OpenGL 4.6
Maximum color depth	10 bits
Maximum vertical refresh rate	Up to 120 Hz NOTE: The refresh rate depends on the resolution.
External ports	DisplayPort USB Type-C
Multiple display support	Up to four displays including laptop display.

BIOS Setup

CAUTION: Unless you are an expert computer user, do not change the settings in the BIOS Setup. Certain changes can make your computer work incorrectly.

NOTE: Depending on the computer and its installed devices, the items that are listed in this section may or may not be displayed.

NOTE: Before you change the settings in BIOS Setup, it is recommended that you note down the original settings for future reference.

Use BIOS Setup for the following purposes:

- Get information about the hardware installed in your computer, such as the amount of RAM and the size of the storage device.
- Change the system configuration information.
- Set or change a user-selectable option, such as the user password, type of hard drive installed, and enabling or disabling base devices.

Entering BIOS setup program

About this task

Turn on (or restart) your computer and press F2 immediately.

Navigation keys

NOTE: For most of the System Setup options, changes that you make are recorded but do not take effect until you restart the computer.

Table 34. Navigation keys

Keys	Navigation
Up arrow	Moves to the previous field.
Down arrow	Moves to the next field.
Enter	Selects a value in the selected field (if applicable) or follows the link in the field.
Spacebar	Expands or collapses a drop-down list, if applicable.
Tab	Moves to the next focus area. NOTE: For the standard graphical user interface only.
Esc	Moves to the previous page until you view the main screen. Pressing Esc in the main screen displays a message that prompts you to save any unsaved changes and restart the computer.

F12 One Time Boot menu

To enter the One Time Boot menu, turn on your computer, and then press F12 immediately.

 **NOTE:** It is recommended to shut down the computer, if it is on.

The F12 One Time Boot menu displays the devices that you can boot from including the diagnostic option. The boot menu options are:

- Removable Drive (if available)
- STXXXX Drive (if available)
 -  **NOTE:** XXX denotes the SATA drive number.
- Optical Drive (if available)
- SATA Hard Drive (if available)
- Diagnostics

The boot sequence screen also displays the option to access System Setup.

View Advanced Setup options

About this task

Some BIOS Setup options are only visible by enabling **Advanced Setup** mode, which is disabled by default.

 **NOTE:** BIOS Setup options, including **Advanced Setup** options, are described in [System setup options](#).

To enable Advanced Setup

Steps

1. Enter BIOS Setup.
The Overview menu appears.
2. Click the **Advanced Setup** option to move it to the **ON** mode.
Advanced BIOS Setup options are visible.

View Service options

About this task

Service options are hidden by default and only visible by entering a hotkey command.

 **NOTE:** Service options are described in [System setup options](#).

To view Service options:

Steps

1. Enter BIOS Setup.
The Overview menu appears.
2. Enter the hotkey combination **Ctrl +Alt + s** to view the **Service** options.
Service options are visible.

System Setup options

 **NOTE:** For most of the System Setup options, changes that you make are recorded but do not take effect until you restart the computer.

 **NOTE:** Depending on your computer and its installed devices, the items that are listed in this section may differ.

Table 35. System Setup options—Overview menu**Overview**

Precision 5490	
BIOS Version	Displays the BIOS version number.
Service Tag	Displays the Service Tag of the computer.
Asset Tag	Displays the Asset Tag of the computer.
Manufacture Date	Displays the manufacture date of the computer.
Ownership Date	Displays the ownership date of the computer.
Express Service Code	Displays the Express Service Code of the computer.
Ownership Tag	Displays the Ownership Tag of the computer.
Signed Firmware Update	Displays whether the Signed Firmware Update is enabled on your computer. By default, the Signed Firmware Update option is enabled.  NOTE: To view this option, enable Service options as described in View Service options .

BATTERY Information

Primary	Displays the primary battery of the computer.
Battery Level	Displays the battery level of the computer.
Battery State	Displays the battery state of the computer.
Health	Displays the battery health of the computer.
AC Adapter	Displays whether an AC adapter is connected. If connected, displays the type of AC adapter that is connected.
Battery Life Type	Displays the battery life type of the computer.

PROCESSOR Information





Processor Type	Displays the processor type.
Maximum Clock Speed	Displays the maximum processor clock speed.  NOTE: To view this option, enable Advanced Setup mode as described in View Advanced Setup options .
Minimum Clock Speed	Displays the minimum processor clock speed.  NOTE: To view this option, enable Advanced Setup mode as described in View Advanced Setup options .
Current Clock Speed	Displays the current processor clock speed.  NOTE: To view this option, enable Advanced Setup mode as described in View Advanced Setup options .
Core Count	Displays the number of cores on the processor.
Processor ID	Displays the processor identification code.
Processor L2 Cache	Displays the processor L2 Cache size.
Processor L3 Cache	Displays the processor L3 Cache size.
Microcode Version	Displays the microcode version.  NOTE: To view this option, enable Advanced Setup mode as described in View Advanced Setup options .
Intel Hyper-Threading Capable	Displays whether the processor is Hyper-Threading (HT) capable.

Table 35. System Setup options—Overview menu (continued)

Overview





	<p> NOTE: To view this option, enable Advanced Setup mode as described in View Advanced Setup options.</p>
64-Bit Technology	Displays whether 64-bit technology is used.
MEMORY Information	
Memory Installed	Displays the total computer memory installed.
Memory Available	Displays the total computer memory available.
Memory Speed	<p>Displays the memory speed.</p> <p> NOTE: To view this option, enable Advanced Setup mode as described in View Advanced Setup options.</p>
Memory Channel Mode	<p>Displays single or dual channel mode.</p> <p> NOTE: To view this option, enable Advanced Setup mode as described in View Advanced Setup options.</p>
Memory Technology	Displays the technology that is used for the memory.
DEVICES Information	
Panel Type	Displays the panel type of the computer.
Panel Revision	Displays the panel revision of the computer.
Video Controller	Displays the video controller type of the computer.
Video Memory	Displays the video memory information of the computer.
Wi-Fi Device	Displays the wireless device information of the computer.
Native Resolution	Displays the native resolution of the computer.
Video BIOS Version	<p>Displays the video BIOS version of the computer.</p> <p> NOTE: To view this option, enable Advanced Setup mode as described in View Advanced Setup options.</p>
Audio Controller	Displays the audio controller information of the computer.
Bluetooth Device	Displays the Bluetooth device information of the computer.
Pass Through MAC Address	Displays the MAC address of the video pass-through.

Table 36. System Setup options—Boot Configuration menu



Boot Configuration	
Boot Sequence	
Boot Mode: UEFI only	<p>Displays the boot mode of the computer.</p> <p> NOTE: To view this option, enable Service options as described in View Service options.</p>
Boot Sequence	Displays the boot sequence.
Enable PXE Boot Priority	<p>When enabled, the new PXE boot option is detected and added to the top of the boot sequence.</p> <p>By default, the PXE Boot priority option is disabled.</p>
Secure Digital (SD) Card Boot	<p>Enables or disables read-only boot from Secure Digital (SD) card.</p> <p>By default, the Secure Digital (SD) Card Boot option is disabled.</p> <p> NOTE: To view this option, enable Advanced Setup mode as described in View Advanced Setup options.</p>

Table 36. System Setup options—Boot Configuration menu (continued)

Boot Configuration	
Secure Boot	Secure Boot is a method of guaranteeing the integrity of the boot path by performing additional validation of the operating system and PCI add-in cards. The computer stops booting to the operating system when a component is not authenticated during the boot process. Secure Boot can be enabled in BIOS setup or using management interfaces like Dell Command Configure, but can only be disabled from BIOS setup.
Enable Secure Boot	<p>Enables the computer to boot using only validated boot software.</p> <p>By default, this Enable Secure Boot option is disabled. For additional security, Dell Technologies recommends keeping the Secure Boot option enabled to ensure that the UEFI firmware validates the operating system during the boot process.</p> <p>i NOTE: To view this option, enable Advanced Setup mode as described in View Advanced Setup options.</p> <p>i NOTE: To enable Secure Boot, the computer is required to be in UEFI boot mode and the Enable Legacy Option ROMs option is required to be turned off.</p>
Enable Microsoft UEFI CA	<p>When disabled, the UEFI CA is removed from the BIOS UEFI Secure Boot database.</p> <p>i NOTE: When disabled, the Microsoft UEFI CA could render your computer unable to boot, computer graphics may not function, some devices may not function properly, and the computer could become unrecoverable.</p> <p>By default, the Enable Microsoft UEFI CA option is enabled.</p> <p>For additional security, Dell Technologies recommends keeping the Microsoft UEFI CA option enabled to ensure the broadest compatibility with devices and operating systems.</p>
Secure Boot Mode	<p>Enables or disables the Secure Boot operation mode.</p> <p>By default, the Deployed Mode is selected. Deployed Mode should be selected for normal operation of Secure Boot.</p> <p>i NOTE: To view this option, enable Advanced Setup mode as described in View Advanced Setup options.</p>
Expert Key Management	
Enable Custom Mode	<p>Enables or disables the keys in the PK, KEK, db, and dbx security key databases to be modified.</p> <p>By default, the Enable Custom Mode option is disabled.</p> <p>i NOTE: To view this option, enable Advanced Setup mode as described in View Advanced Setup options.</p>
Custom Mode Key Management	<p>Selects the custom values for expert key management.</p> <p>By default, the PK option is selected.</p> <p>i NOTE: To view this option, enable Advanced Setup mode as described in View Advanced Setup options.</p>

Table 37. System Setup options—Integrated Devices menu

Integrated Devices	
Date/Time	
Date	Sets the computer date in MM/DD/YYYY format. Changes to the date format take effect immediately.

Table 37. System Setup options—Integrated Devices menu (continued)

Integrated Devices	
Time	Sets the computer time in HH/MM/SS 24-hour format. You can switch between a 12-hour or 24-hour clock. Changes to the time format take effect immediately.
Audio	
Enable Audio	Enables all integrated audio controller. By default, all the options are enabled.
Enable Microphone	Enables the microphone. By default, the Enable Microphone option is enabled. i NOTE: Depending on the configuration ordered, the microphone setup option may not be available.
Enable Internal Speaker	Enables the internal speaker. By default, the Enable Internal Speaker option is enabled.
USB/Thunderbolt Configuration	
Enable USB Boot Support	Enables booting from USB mass storage devices that are connected to external USB ports. By default, the Enable USB Boot Support option is enabled. i NOTE: To view this option, enable Advanced Setup mode as described in View Advanced Setup options .
Enable External USB Ports	Enables the external USB ports. By default, the Enable External USB Ports option is enabled. i NOTE: To view this option, enable Advanced Setup mode as described in View Advanced Setup options .
Enable Thunderbolt Technology Support	
Enable Thunderbolt Technology Support	Enables the associated ports and adapters for Thunderbolt Technology support. By default, the Enable Thunderbolt Technology Support option is enabled. i NOTE: To view this option, enable Advanced Setup mode as described in View Advanced Setup options .
Enable Thunderbolt Boot Support	
Enable Thunderbolt Boot Support	Enables the Thunderbolt adapter-peripheral device and USB devices that are connected to the Thunderbolt adapter to be used during BIOS Preboot. By default, the Enable Thunderbolt Boot Support option is disabled. i NOTE: To view this option, enable Advanced Setup mode as described in View Advanced Setup options .
Enable Thunderbolt (and PCIe behind TBT) pre-boot modules	Enables the PCIe devices that are connected through a Thunderbolt adapter to run the PCIe devices UEFI Option ROM (if present) during preboot. By default, the Enable Thunderbolt (and PCIe behind TBT) pre-boot modules option is disabled. i NOTE: To view this option, enable Advanced Setup mode as described in View Advanced Setup options .
Disable USB4 PCIe Tunneling	Disables the USB4 PCIe Tunneling option. By default, the Disable USB4 PCIe Tunneling option is disabled.

Table 37. System Setup options—Integrated Devices menu (continued)

Integrated Devices	
	<p>i NOTE: To view this option, enable Advanced Setup mode as described in Entering BIOS Setup program.</p>
Video/Power only on Type-C Ports	<p>Enables or disables the Type-C port functionality to video or only power. By default, the Video/Power only on Type-C Ports option is disabled.</p> <p>i NOTE: To view this option, enable Advanced Setup mode as described in View Advanced Setup options.</p>
Type-C Dock	
Type-C Dock Override	<p>Enables or disables to use connected Type-C Dell Dock to provide data stream with external USB ports disabled. When Type-C Dock override is enabled, the Video/Audio/LAN submenu is activated.</p> <p>By default, the Type-C Dock Override option is enabled.</p> <p>i NOTE: To view this option, enable Advanced Setup mode as described in Entering BIOS Setup program.</p>
Type-C Dock Audio	<p>Enables or disables the usage of audio inputs and outputs from the connected Type-C Dell docking station.</p> <p>By default, the Type-C Dock Audio option is enabled.</p> <p>i NOTE: To view this option, enable Advanced Setup mode as described in View Advanced Setup options.</p>
Type-C Dock LAN	<p>Enables or disables the usage of LAN on the external ports of the connected Type-C Dell docking station.</p> <p>By default, the Type-C Dock LAN option is enabled.</p> <p>i NOTE: To view this option, enable Advanced Setup mode as described in View Advanced Setup options.</p>
Miscellaneous Devices	
Enable Fingerprint Reader Device	<p>Enables or disables the Fingerprint Reader Device option.</p> <p>By default, the Enable Fingerprint Reader Device option is enabled.</p> <p>i NOTE: To view this option, enable Advanced Setup mode as described in View Advanced Setup options.</p>
Unobtrusive Mode	<p>Enables or disables the unobtrusive mode. When enabled, all system LEDs, LCD panel backlight and audio devices of the computer are turned off.</p> <p>By default, the Unobtrusive Mode option is disabled.</p> <p>i NOTE: On computers with collaboration touchpad, the Collaboration Touchpad is disabled when the Unobtrusive Mode option is enabled.</p> <p>i NOTE: To view this option, enable Advanced Setup mode as described in View Advanced Setup options.</p>

Table 38. System Setup options—Storage menu

Storage	
SATA/NVMe Operation	
SATA/NVMe Operation	<p>Sets the operating mode of the integrated SATA hard drive controller.</p> <p>By default, the Raid On option is selected.</p>
Storage Interface	<p>Displays the information of various onboard drives.</p>

Table 38. System Setup options—Storage menu (continued)

Storage	
Port Enablement	Enables or disables the M.2 PCIe SSD option. By default, the M.2 PCIe SSD-0 option is enabled.
Smart Reporting	Enables or disables the Smart reporting option. By default, the Smart Reporting option is disabled. i NOTE: To view this option, enable Advanced Setup mode as described in View Advanced Setup options .
Drive Information	Displays the information of onboard drives.
Enable MediaCard	
Secure Digital (SD) Card	Enables or disables the SD card. By default, the Secure Digital (SD) Card option is enabled. i NOTE: To view this option, enable Advanced Setup mode as described in View Advanced Setup options .
Secure Digital (SD) Card Read-Only Mode	Enables or disables the SD card read-only mode. i NOTE: To view this option, enable Advanced Setup mode as described in View Advanced Setup options . By default, the Secure Digital (SD) Card Read-Only Mode option is disabled.

Table 39. System Setup options—Display menu

Display	
Display Brightness	
Brightness on battery power	Enables to set the screen brightness when the computer is running on battery power. By default, the screen brightness is set to 50 when the computer is running on battery power. i NOTE: To view this option, enable Advanced Setup mode as described in View Advanced Setup options .
Brightness on AC power	Enables to set the screen brightness when the computer is running on AC power. By default, the screen brightness is set to 100 when the computer is running on AC power. i NOTE: To view this option, enable Advanced Setup mode as described in View Advanced Setup options .
Full Screen Logo	Enables or disables the computer to display full screen logo, if the image matches screen resolution. By default, the Full Screen Logo option is disabled. i NOTE: To view this option, enable Advanced Setup mode as described in View Advanced Setup options .

Table 40. System Setup options—Connection menu

Connection	
Wireless Device Enable	
WLAN	Enables or disables the internal WLAN device. By default, the WLAN option is enabled.

Table 40. System Setup options—Connection menu (continued)

Connection	
Bluetooth	<p>Enables or disables the internal Bluetooth device.</p> <p>By default, the Bluetooth option is enabled.</p>
Enable UEFI Network Stack	<p>Enables or disables the UEFI Network Stack and controls the onboard LAN Controller.</p> <p>By default, the Enable UEFI Network Stack option is enabled.</p> <p>i NOTE: To view this option, enable Advanced Setup mode as described in View Advanced Setup options.</p>
Wireless Radio Control	
Control WLAN Radio	<p>Enables to sense the connection of the computer to a wired network and then disables the selected WLAN radio. Upon disconnection from the wired network, the selected wireless radios are reenabled.</p> <p>By default, the Control WLAN Radio option is disabled.</p> <p>i NOTE: To view this option, enable Advanced Setup mode as described in View Advanced Setup options.</p>
Enable UEFI Network Stack	<p>Enables the UEFI Network Stack and controls the onboard LAN Controller.</p> <p>By default, the Enable UEFI Network Stack option is enabled.</p>
HTTP(s) Boot Feature	
HTTP(s) Boot	<p>When enabled, supports HTTP(s) boot on the client BIOS, which offers wired or wireless and HTTP/HTTPS connection options.</p> <p>i NOTE: To view this option, enable Advanced Setup mode as described in View Advanced Setup options.</p>
HTTP(s) Boot Modes	<p>In Auto Mode, the boot URL is obtained from the DHCP response; the boot URL specifies the HTTP Boot Server and location of the Network Boot Program (NBP) file. In Manual mode, the user enters the URL in the text box, which must start with <code>http://</code> or <code>https://</code> and end with the NBP file name.</p> <p>By default, Auto Mode is selected.</p> <p>i NOTE: To view this option, enable Advanced Setup mode as described in View Advanced Setup options.</p>
CA Certificate	<p>Upload or delete the CA certificate.</p> <p>i NOTE: To view this option, enable Advanced Setup mode as described in View Advanced Setup options.</p>

Table 41. System Setup options—Power menu

Power	
Battery Configuration	<p>Enables or disables the computer to run on battery during peak power usage hours. Use the table Custom Charge Start and Custom Charge Stop, to prevent AC power usage between certain times of each day.</p> <p>By default, the Adaptive option is selected. Battery settings are adaptively optimized based on your typical battery usage pattern.</p>
Advanced Configuration	
Enable Advanced Battery Charge Configuration	<p>Enables Advanced Battery Charge Configuration from the beginning of the day to a specified work period. When enabled, Advanced Battery Charged maximizes battery health while still supporting heavy use during the work day.</p> <p>By default, the Enable Advanced Battery Charge Configuration option is disabled.</p>

Table 41. System Setup options—Power menu (continued)

Power	
	<p>i NOTE: To view this option, enable Advanced Setup mode as described in View Advanced Setup options.</p>
Peak Shift	
Enable Peak Shift	<p>Enables or disables the computer to run on battery during peak power usage hours.</p> <p>By default, the Enable Peak Shift option is disabled.</p> <p>i NOTE: To view this option, enable Advanced Setup mode as described in View Advanced Setup options.</p>
Enable USB PowerShare	<p>Enables or disables the USB PowerShare on the computer.</p> <p>By default, the USB Powershare option is disabled.</p>
Thermal Management	
	<p>Enables or disables cooling of the fan and manages the processor heat to adjust the system performance, noise, and temperature.</p> <p>By default, the Optimized option is selected. Standard settings for balanced performance, noise, and temperature.</p>
USB Wake Support	
Wake on Dell USB-C Dock	<p>When enabled, connecting a Dell USB-C Dock wakes the computer from Standby, Hibernate, and Power Off.</p> <p>By default, the Wake on Dell USB-C Dock option is enabled.</p> <p>i NOTE: To view this option, enable Advanced Setup mode as described in View Advanced Setup options.</p>
Block Sleep	
	<p>Enables or disables the computer from entering Sleep (S3) mode in the operating system.</p> <p>By default, the Block Sleep option is disabled.</p> <p>i NOTE: When enabled, the computer does not go to Sleep, Intel Rapid Start is disabled automatically, and the operating system power option is blank if it was set to Sleep.</p> <p>i NOTE: To view this option, enable Advanced Setup mode as described in View Advanced Setup options.</p>
Lid Switch	
Enable Lid Switch	<p>Enables or disables the Lid Switch.</p> <p>By default, the Enable Lid Switch option is enabled.</p>
Power On Lid Open	<p>When enabled, allows the computer to turn on from the off state whenever the lid is opened.</p> <p>By default, the Power On Lid Open option is enabled.</p>
Intel Speed Shift Technology	
	<p>Enables or disables the Intel Speed Shift Technology support. When enabled, the operating system selects the appropriate processor performance automatically.</p> <p>By default, the Intel Speed Shift Technology option is enabled.</p> <p>i NOTE: To view this option, enable Service options as described in View Service options.</p>

Table 42. System Setup options—Security menu

Security
Intel Platform Trust Technology

Table 42. System Setup options—Security menu (continued)





Security	
Intel Platform Trust Technology On	<p>Enables you to control whether the Intel Platform Trust Technology (PTT) is visible to the operating system.</p> <p>By default, the Intel Platform Trust Technology option is enabled.</p>
Intel Total Memory Encryption	
Multi-key Total Memory Encryption (Up to 16 keys)	<p>When enabled, the Total Memory Encryption (TME) protects the memory from physical attacks including freeze spray, probing DDR to read the cycles, and others.</p> <p>By default, the Multi-key Total Memory Encryption (Up to 16 keys) option is disabled.</p>
Chassis Intrusion	
Chassis Intrusion	<p>Enables or disables the detection of chassis intrusion events. This feature notifies the user when the base cover has been removed from the computer.</p> <p>When set to Enabled, a notification is displayed on the next boot and the event is logged in the BIOS Events log.</p> <p>When set to Disabled, no notification is displayed and no event is logged in the BIOS Events log.</p> <p>When set to On-Silent, the event is logged in the BIOS Events log, but no notification is displayed.</p> <p>By default, the Chassis Intrusion Detection option is disabled.</p> <p>For additional security, Dell Technologies recommends keeping the Chassis Intrusion option enabled.</p> <p> NOTE: To view this option, enable Advanced Setup mode as described in View Advanced Setup options.</p>
Block Boot Until Cleared	<p>The Block Boot Until Clear option is enabled when Chassis Intrusion is enabled. When enabled, the computer does not boot until the chassis intrusion is cleared.</p> <p> NOTE: To view this option, enable Advanced Setup mode as described in View Advanced Setup options.</p>
SMM Security Mitigation	
	<p>Enables or disables additional UEFI SMM Security Mitigation protections. This option uses the Windows SMM Security Mitigations Table (WSMT) to confirm to the operating system that security best practices have been implemented by the UEFI firmware.</p> <p>By default, the SMM Security Mitigation option is enabled.</p> <p>For additional security, Dell Technologies recommends keeping the SMM Security Mitigation option enabled unless you have a specific application which is not compatible.</p> <p> NOTE: This feature may cause compatibility issues or loss of functionality with some legacy tools and applications.</p> <p> NOTE: To view this option, enable Service options as described in View Service options.</p>
Data Wipe on Next Boot	
Start Data Wipe	<p>Data Wipe is a secure wipe operation that deletes information from a storage device.</p> <p> CAUTION: The Secure Data Wipe operation erases information in a way that it cannot be reconstructed.</p> <p>Commands such as delete and format in the operating system may remove files from showing up in the file system, however they can be reconstructed through</p>

Table 42. System Setup options—Security menu (continued)







<p>Security</p>	<p>forensic means as they are still represented on the physical media. Data Wipe prevents this reconstruction and is not recoverable.</p> <p>When enabled, the BIOS will queue up a data wipe cycle for storage devices that are connected to the motherboard on the next reboot.</p> <p>By default, the Start Data Wipe option is disabled.</p> <p> NOTE: To view this option, enable Advanced Setup mode as described in View Advanced Setup options.</p>
<p>Absolute</p>	<p>Absolute Software provides various cyber security solutions, some requiring software preloaded on Dell computers and integrated into the BIOS. To use these features, you must enable the Absolute BIOS setting and contact Absolute for configuration and activation.</p> <p>By default, the Absolute option is enabled.</p> <p>For additional security, Dell Technologies recommends keeping the Absolute option enabled.</p> <p> WARNING: The Permanently Disabled option can only be selected once. When Permanently Disabled is selected, Absolute Persistence cannot be reenabled. No further changes to the Enable/Disable states are allowed.</p> <p> NOTE: The Enable/Disable options are unavailable while the computer is in the activated state.</p> <p> NOTE: When the Absolute features are activated, the Absolute integration cannot be disabled from the BIOS Setup screen.</p>
<p>UEFI Boot Path Security</p>	<p>Enables or disables the computer to prompt the user to enter the Administrator password (if set) when booting to a UEFI boot path device from the F12 boot menu.</p> <p>By default, the Always Except Internal HDD option is enabled.</p> <p> NOTE: To view this option, enable Advanced Setup mode as described in View Advanced Setup options.</p>
<p>Firmware Device Tamper Detection</p>	<p>Allows you to control the firmware device tamper detection feature. This feature notifies the user when the firmware device is tampered. When enabled, a screen warning message is displayed on the computer and a tamper detection event is logged in the BIOS Events log. The computer fails to reboot until the event is cleared.</p> <p>By default, the Silent option is enabled.</p> <p>For additional security, Dell Technologies recommends keeping the Firmware Device Tamper Detection option enabled.</p> <p> NOTE: To view this option, enable Advanced Setup mode as described in View Advanced Setup options.</p>
<p>Clear Firmware Device Tamper Detection</p>	<p>Allows you to clear the events that are logged when tampering of firmware device is detected.</p> <p>By default, the Clear Firmware Device Tamper Detection option is disabled.</p> <p> NOTE: To view this option, enable Advanced Setup mode as described in View Advanced Setup options.</p>

Table 43. System Setup options—Passwords menu

Passwords	
Administrator Password	<p>The Administrator Password prevents unauthorized access to the BIOS Setup options. Once the administrator password is set, the BIOS Setup options can only be modified after providing the correct password.</p> <p>The following rules and dependencies apply to the Administrator Password -</p> <ul style="list-style-type: none"> • The administrator password cannot be set if system and/or internal hard drive passwords are previously set. • The administrator password can be used in place of the system and/or internal hard drive passwords. • When set, the administrator password must be provided during a firmware update. • Clearing the administrator password also clears the system password (if set). <p>Dell Technologies recommends using an administrator password to prevent unauthorized changes to BIOS Setup options.</p>
System Password	<p>The System Password prevents the computer from booting to an operating system without entering the correct password.</p> <p>The following rules and dependencies apply when the System Password is used -</p> <ul style="list-style-type: none"> • The computer shuts down when idle for approximately 10 minutes at the system password prompt. • The computer shuts down after three incorrect attempts to enter the system password. • The computer shuts down when the Esc key is pressed at the System Password prompt. • The system password is not prompted when the computer resumes from standby mode. <p>Dell Technologies recommends using the system password in situations where it is likely that a computer may be lost or stolen.</p>
<p>Hard Drive Password</p> <p> NOTE: On some computers, the M.2 PCIe SSD-0 Password option is shown.</p>	<p>The hard drive password can be set to prevent unauthorized access of the data stored on the solid-state drive. The computer prompts for the hard drive password during boot in order to unlock the drive. A password-secured hard drive stays locked even when removed from the computer or placed into another computer. It prevents an attacker from accessing data on the drive without authorization.</p> <p>The following rules and dependencies apply when the Hard Drive Password or M.2 PCIe SSD-0 Password option is used.</p> <ul style="list-style-type: none"> • The hard drive password option cannot be accessed when the hard drive is disabled in the BIOS Setup. • The computer shuts down when idle for approximately 10 minutes at the hard drive password prompt. • The computer shuts down after three incorrect attempts to enter the hard drive password and treats the hard drive as not available. • The hard drive does not accept password unlock attempts after five incorrect attempts to enter the hard drive password from the BIOS Setup. The hard drive password must be reset for the new password unlock attempts. • The computer treats the hard drive as not available when the Esc key is pressed at the hard drive password prompt. • The hard drive password is not prompted when the computer resumes from standby mode. When the hard drive is unlocked by the user before the computer goes into standby mode, it remains unlocked after the computer resumes from standby mode. • If the system and hard drive passwords are set to the same value, the hard drive unlocks after the correct system password is entered. <p>Dell Technologies recommends using a hard drive password to protect unauthorized data access.</p>

Table 43. System Setup options—Passwords menu (continued)

Passwords	
Password Configuration	<p>The Password configuration page includes several options for changing the requirements of BIOS passwords. You can modify the minimum and maximum length of the passwords as well as require passwords to contain certain character classes (upper case, lower case, digit, special character).</p> <p>When the Lower Case Letter option is enabled, the password requires at least one lower case letter.</p> <p>When the Upper Case Letter option is enabled, the password requires at least one upper case letter.</p> <p>When the Digit option is enabled, the password requires at least one numeric digit.</p> <p>When the Special Character option is enabled, the password requires at least one special character from the set: !"#%&'()*+,-./:;<=>?@[\\]^_`{ }~.</p> <p>When setting Minimum Characters for password length, Dell Technologies recommends setting the minimum password length to at least eight characters.</p> <p>NOTE: To view this option, enable Advanced Setup mode as described in View Advanced Setup options.</p>
Password Bypass	<p>The Password Bypass option allows the computer to reboot from the operating system without entering the system or hard drive password. If the computer has already booted to the operating system, it is presumed that the user has already entered the correct system or hard drive password.</p> <p>NOTE: This option does not remove the requirement to enter the password after shutting down.</p> <p>By default, the Password Bypass option is disabled.</p> <p>For additional security, Dell Technologies recommends keeping the Password Bypass option enabled.</p> <p>NOTE: To view this option, enable Advanced Setup mode as described in View Advanced Setup options.</p>
Password Changes	
Allow Non-Admin Password Changes	<p>The Allow Non-Admin Password Changes option in BIOS Setup allows an end user to set or change the system or hard drive passwords without entering the administrator password. This gives an administrator control over the BIOS settings but enables an end user to provide their own password.</p> <p>By default, the Allow Non-Admin Password Changes option is enabled.</p> <p>For additional security, Dell Technologies recommends keeping the Allow Non-Admin Password Changes option disabled.</p> <p>NOTE: To view this option, enable Advanced Setup mode as described in View Advanced Setup options.</p>
Admin Setup Lockout	
Enable Admin Setup Lockout	<p>The Admin Setup Lockout option prevents an end user from even viewing the BIOS Setup configuration without first entering the administrator password (if set).</p> <p>By default, the Enable Admin Setup Lockout option is disabled.</p> <p>For additional security, Dell Technologies recommends keeping the Admin Setup Lockout option disabled.</p> <p>NOTE: To view this option, enable Advanced Setup mode as described in View Advanced Setup options.</p>
Master Password Lockout	

Table 43. System Setup options—Passwords menu (continued)

Passwords	
Enable Master Password Lockout	<p>The Master Password Lockout option allows you to disable the Recovery Password feature. If the system, administrator, or hard drive password is forgotten, the computer becomes unusable.</p> <p>NOTE: When the owner password is set, the Master Password Lockout option is not available.</p> <p>NOTE: When an internal hard drive password is set, it must first be cleared before Master Password Lockout can be changed.</p> <p>By default, the Enable Master Password Lockout option is disabled.</p> <p>Dell Technologies does not recommend enabling the Master Password Lockout unless you have implemented your own password recovery system.</p> <p>NOTE: To view this option, enable Advanced Setup mode as described in View Advanced Setup options.</p>
Allow Non-Admin PSID Revert	
Enable Allow Non-Admin PSID Revert	<p>The Allow Non-Admin PSID Revert option allows a user to clear the hard drive password without entering the BIOS Admin Password. When an Admin Password is set, the ability to enter the PSID is protected by requiring authentication with the Admin Password. If this option is enabled, any user can clear the drive without entering the Admin Password.</p> <p>By default, the Enable Allow Non-Admin PSID Revert option is disabled.</p> <p>NOTE: To view this option, enable Advanced Setup mode as described in View Advanced Setup options.</p>

Table 44. System Setup options—Update, Recovery menu

Update, Recovery	
UEFI Capsule Firmware Updates	
Enable UEFI Capsule Firmware Updates	<p>Enables or disables BIOS updates through UEFI capsule update packages.</p> <p>NOTE: Disabling this option blocks the BIOS updates from services such as Microsoft Windows Update and Linux Vendor Firmware Service (LVFS).</p> <p>By default, the Enable UEFI Capsule Firmware Updates option is enabled.</p> <p>NOTE: To view this option, enable Advanced Setup mode as described in View Advanced Setup options.</p>
BIOS Recovery from Hard Drive	
	<p>Enables or disables the user to recover from certain corrupted BIOS conditions from a recovery file on the user primary hard drive or an external USB drive.</p> <p>By default, the BIOS Recovery from Hard Drive option is enabled.</p> <p>NOTE: BIOS Recovery from Hard Drive is not available for self-encrypting drives (SED).</p> <p>NOTE: BIOS recovery is designed to fix the main BIOS block and cannot work if the Boot Block is damaged. In addition, this feature cannot work in the event of EC corruption, ME corruption, or a hardware issue. The recovery image must exist on an unencrypted partition on the drive.</p> <p>NOTE: To view this option, enable Advanced Setup mode as described in View Advanced Setup options.</p>
BIOS Downgrade	
Allow BIOS Downgrade	<p>Allows downgrading of the system firmware to previous revisions.</p> <p>By default, the Allow BIOS Downgrade option is enabled.</p>

Table 44. System Setup options—Update, Recovery menu (continued)

Update, Recovery	
SupportAssist OS Recovery	<p>Enables or disables the boot flow for SupportAssist OS Recovery tool if certain system errors occur.</p> <p>By default, the SupportAssist OS Recovery option is enabled.</p>
BIOSConnect	<p>Enables or disables cloud service operating system recovery if the main operating system fails to boot with the number of failures equal to or greater than the value specified by the Auto operating system Recovery Threshold setup option and local service operating system does not boot or is not installed.</p> <p>By default, the BIOSConnect option is enabled.</p>
Dell Auto OS Recovery Threshold	<p>Allows the control of the automatic boot flow for the SupportAssist System Resolution Console and the Dell operating system Recovery Tool.</p> <p>By default, the Dell Auto OS Recovery Threshold value is set to 2.</p> <p>i NOTE: To view this option, enable Advanced Setup mode as described in View Advanced Setup options.</p>

Table 45. System Setup options—System Management menu

System Management	
Service Tag	<p>Displays the Service Tag of the computer.</p>
Asset Tag	<p>Creates a computer Asset Tag that an IT administrator can use to uniquely identify a particular computer.</p> <p>i NOTE: Once set in the BIOS, the Asset Tag cannot be changed.</p>
AC Behavior	
Wake on AC	<p>Enables or disables the computer to turn on and go to boot when AC power is supplied to the computer.</p> <p>By default, the Wake on AC option is disabled.</p> <p>i NOTE: To view this option, enable Advanced Setup mode as described in View Advanced Setup options.</p>
Wake on LAN	<p>Enables or disables the computer to turn on by a special LAN signal.</p> <p>By default, the Wake on LAN option is disabled.</p> <p>i NOTE: To view this option, enable Advanced Setup mode as described in View Advanced Setup options.</p>
Auto On Time	<p>Enable to set the computer to turn on automatically every day or on a preselected date and time. This option can be configured only if the Auto On Time is set to Everyday, Weekdays, or Selected Days.</p> <p>By default, the Auto On Time option is disabled.</p> <p>i NOTE: To view this option, enable Advanced Setup mode as described in View Advanced Setup options.</p>
Intel AMT capability	<p>Configure Intel Active Management Technology (AMT) options, which can be enabled, disabled, or restricted.</p> <p>i NOTE: To view this option, enable Advanced Setup mode as described in View Advanced Setup options.</p>
Diagnostics OS agent requests	<p>Enable or disable the option for applications running in the operating system to run with preboot diagnostics on subsequent boots.</p> <p>i NOTE: To view this option, enable Advanced Setup mode as described in View Advanced Setup options.</p>

Table 45. System Setup options—System Management menu (continued)

System Management	
Power-On-Self-Test Automatic Recovery	<p>Enable or disable the automatic recovery of the computer from no power or no-POST failure by applying mitigation steps.</p> <p>By default, the Power-On-Self-Test Automatic Recovery option is enabled.</p> <p>i NOTE: To view this option, enable Advanced Setup mode as described in View Advanced Setup options.</p>

Table 46. System Setup options—Keyboard menu

Keyboard	
Fn Lock Options	<p>Enables or disables the Fn Lock option.</p> <p>By default, the Fn Lock option is enabled.</p>
Lock Mode	<p>By default, the Lock Mode Secondary option is enabled. With this option, the F1-F12 keys scan the code for their secondary functions.</p>
Keyboard Illumination	<p>Configures the operating mode of the keyboard illumination feature.</p> <p>By default, the Bright option is selected. Enables the keyboard illumination feature at 100% brightness level.</p>
Keyboard Backlight Timeout on AC	<p>Sets the timeout value for the keyboard backlight when an AC adapter is connected to the computer.</p> <p>By default, the 10 seconds option is selected.</p> <p>i NOTE: To view this option, enable Advanced Setup mode as described in View Advanced Setup options.</p>
Keyboard Backlight Timeout on Battery	<p>Sets the timeout value for the keyboard backlight when the computer is running only on the battery power. The keyboard backlight timeout value is only effective when the backlight is enabled.</p> <p>By default, the 10 seconds option is selected.</p> <p>i NOTE: To view this option, enable Advanced Setup mode as described in View Advanced Setup options.</p>
Device Configuration HotKey Access	<p>Allows you to control whether you can access device configuration screens through hotkeys during system startup.</p> <p>By default, the Device Configuration HotKey Access option is enabled.</p> <p>i NOTE: This setting controls only the Intel RAID (CTRL+I), MEBX (CTRL+P), and LSI RAID (CTRL+C) Option ROMs. Other preboot Option ROMs, which support entry using a key sequence, are not affected by this setting.</p> <p>i NOTE: To view this option, enable Advanced Setup mode as described in View Advanced Setup options.</p>

Table 47. System Setup options—Pre-boot Behavior menu

Pre-boot Behavior	
Adapter Warnings	
Enable Dock Warning Messages	<p>Enables the warning messages during boot when the adapters with less power capacity are detected.</p> <p>By default, the Enable Dock Warning Messages option is enabled.</p> <p>i NOTE: To view this option, enable Advanced Setup mode as described in View Advanced Setup options.</p>

Table 47. System Setup options—Pre-boot Behavior menu (continued)

Pre-boot Behavior	
Warnings and Errors	<p>Enables or disables the action to be taken when a warning or error is encountered.</p> <p>By default, the Prompt on Warnings and Errors option is selected. Stop, prompt, and wait for user input when warnings or errors are detected.</p> <p>i NOTE: Errors deemed critical to the operation of the computer hardware stop the functioning of the computer.</p> <p>i NOTE: To view this option, enable Advanced Setup mode as described in View Advanced Setup options.</p>
Extend BIOS POST Time	<p>Sets the BIOS POST (Power-On Self-Test) load time.</p> <p>By default, the 0 seconds option is selected.</p> <p>i NOTE: To view this option, enable Advanced Setup mode as described in View Advanced Setup options.</p>
MAC Address Pass-Through	<p>Replaces the external NIC MAC address (in a supported dock or dongle) with the selected MAC address from the computer.</p> <p>By default, the Passthrough MAC Address option is selected.</p>
Mouse/Touchpad	<p>Defines how the computer handles mouse and touchpad input.</p> <p>By default, the Touchpad and PS/2 Mouse option is selected. Leaves the integrated touchpad that is enabled when an external PS/2 mouse is present.</p> <p>i NOTE: To view this option, enable Advanced Setup mode as described in View Advanced Setup options.</p>
Sign of Life	
Early Keyboard Backlight	<p>Enables or disables the Keyboard Backlight Sign of Life.</p> <p>By default, the Early Keyboard Backlight option is enabled.</p> <p>i NOTE: To view this option, enable Advanced Setup mode as described in View Advanced Setup options.</p>

Table 48. System Setup options—Virtualization menu

Virtualization Support	
Intel Virtualization Technology	
Enable Intel Virtualization Technology (VT)	<p>When enabled, the computer can run a Virtual Machine Monitor (VMM).</p> <p>By default, the Enable Intel Virtualization Technology (VT) option is enabled.</p> <p>i NOTE: To view this option, enable Advanced Setup mode as described in View Advanced Setup options.</p>
VT for Direct I/O	
Enable Intel VT for Direct I/O	<p>When enabled, the computer can perform Virtualization Technology for Direct I/O (VT-d). VT-d is an Intel method that provides virtualization for memory map I/O.</p> <p>By default, the Enable Intel VT for Direct I/O option is enabled.</p> <p>i NOTE: To view this option, enable Advanced Setup mode as described in View Advanced Setup options.</p>
DMA Protection	

Table 48. System Setup options—Virtualization menu (continued)

Virtualization Support	
Enable Pre-Boot DMA Support	<p>Allows you to control the Pre-Boot DMA protection for both internal and external ports. This option does not directly enable DMA protection in the operating system.</p> <p>NOTE: This option is not available when the virtualization setting for IOMMU is disabled (VT-d/AMD Vi).</p> <p>By default, the Enable Pre-Boot DMA Support option is enabled.</p> <p>For additional security, Dell Technologies recommends keeping the Enable Pre-Boot DMA Support option enabled.</p> <p>NOTE: This option is provided only for compatibility purposes, since some older hardware is not DMA capable.</p> <p>NOTE: To view this option, enable Advanced Setup mode as described in View Advanced Setup options.</p>
Enable OS Kernel DMA Support	<p>Allows you to control the Kernel DMA protection for both internal and external ports. This option does not directly enable DMA protection in the operating system. For operating systems that support DMA protection, this setting indicates to the operating system that the BIOS supports the feature.</p> <p>NOTE: This option is not available when the virtualization setting for IOMMU is disabled (VT-d/AMD Vi).</p> <p>By default, the Enable OS Kernel DMA Support option is enabled.</p> <p>NOTE: This option is provided only for compatibility purposes, since some older hardware is not DMA capable.</p> <p>NOTE: To view this option, enable Advanced Setup mode as described in View Advanced Setup options.</p>

Table 49. System Setup options—Performance menu

Performance	
Multi-Core Support	
Active Multiple Performance Cores (P-Cores) Select	<p>Change the number of cores available to the operating system. The default value is set to the maximum number of cores.</p> <p>By default, the All Active option is selected.</p> <p>NOTE: To view this option, enable Advanced Setup mode as described in View Advanced Setup options.</p>
Intel SpeedStep	
Enable Intel SpeedStep Technology	<p>Enables the computer to dynamically adjust processor voltage and core frequency, decreasing average power consumption and heat production.</p> <p>By default, the Enable Intel SpeedStep Technology option is enabled.</p> <p>NOTE: To view this option, enable Service options as described in View Service options.</p>
C-State Control	
Enable C-State Control	<p>Enables or disables the ability of the CPU to enter and exit low-power state. When disabled, it disables all C-states. When enabled, it enables all C-states that the chipset or platform allows.</p> <p>By default, the Enable C-State Control option is enabled.</p> <p>NOTE: To view this option, enable Advanced Setup mode as described in View Advanced Setup options.</p>

Table 49. System Setup options—Performance menu (continued)

Performance	
Enable Adaptive C-States for Discrete Graphics	<p>Allows the computer to dynamically detect high usage of a discrete graphics and adjusts the computer parameters for higher performance during that time period.</p> <p>By default, the Enable Adaptive C-States for Discrete Graphics option is enabled.</p>
Intel Turbo Boost Technology	
Enable Intel Turbo Boost Technology	<p>Enables or disables the Intel TurboBoost mode of the processor. When enabled, the Intel TurboBoost driver increases the performance of the CPU or graphics processor.</p> <p>By default, the Enable Intel Turbo Boost Technology option is enabled.</p> <p>NOTE: To view this option, enable Advanced Setup mode as described in View Advanced Setup options.</p>
Intel Hyper-Threading Technology	
Enable Intel Hyper-Threading Technology	<p>Enables or disables the Intel Hyper-Threading mode of the processor. When enabled, the Intel Hyper-Threading increases the efficiency of the processor resources when multiple threads run on each core.</p> <p>By default, the Intel Hyper-Threading Technology option is enabled.</p> <p>NOTE: To view this option, enable Advanced Setup mode as described in View Advanced Setup options.</p>
Adaptive Optimization	
Enable , Disable	<p>Enables or disables the Presto 3 Performance feature.</p> <p>By default, the option is enabled.</p>

Table 50. System Setup options—System Logs menu

System Logs	
BIOS Event Log	
Clear BIOS Event Log	<p>Select the option to keep or clear BIOS events logs.</p> <p>By default, the Keep Log option is selected.</p> <p>NOTE: To view this option, enable Advanced Setup mode as described in View Advanced Setup options.</p>
Thermal Event Log	
Clear Thermal Event Log	<p>Select the option to keep or clear Thermal events logs.</p> <p>By default, the Keep Log option is selected.</p> <p>NOTE: To view this option, enable Advanced Setup mode as described in View Advanced Setup options.</p>
Power Event Log	
Clear Power Event Log	<p>Select the option to keep or clear Power events logs.</p> <p>By default, the Keep Log option is selected.</p> <p>NOTE: To view this option, enable Advanced Setup mode as described in View Advanced Setup options.</p>

Updating the BIOS

Updating the BIOS in Windows

About this task

 **CAUTION:** If BitLocker is not suspended before updating the BIOS, the next time you reboot the computer it will not recognize the BitLocker key. You will then be prompted to enter the recovery key to progress, and the computer will ask for this on each reboot. If the recovery key is not known this can result in data loss or an unnecessary operating system reinstall. For more information about this subject, search in the Knowledge Base Resource at www.dell.com/support.

Steps

1. Go to www.dell.com/support.
2. Click **Product support**. In the **Search support** box, enter the Service Tag of your computer, and then click **Search**.
 **NOTE:** If you do not have the Service Tag, use the SupportAssist feature to automatically identify your computer. You can also use the product ID or manually browse for your computer model.
3. Click **Drivers & Downloads**. Expand **Find drivers**.
4. Select the operating system installed on your computer.
5. In the **Category** drop-down list, select **BIOS**.
6. Select the latest version of BIOS, and click **Download** to download the BIOS file for your computer.
7. After the download is complete, browse the folder where you saved the BIOS update file.
8. Double-click the BIOS update file icon and follow the on-screen instructions.
For more information, search in the Knowledge Base Resource at www.dell.com/support.

Updating the BIOS in Linux and Ubuntu

To update the system BIOS on a computer that is installed with Linux or Ubuntu, see the knowledge base article [000131486](https://www.dell.com/support/000131486) at www.dell.com/support.

Updating the BIOS using the USB drive in Windows

About this task

 **CAUTION:** If BitLocker is not suspended before updating the BIOS, the next time you reboot the computer it will not recognize the BitLocker key. You will then be prompted to enter the recovery key to progress, and the computer will ask for this on each reboot. If the recovery key is not known this can result in data loss or an unnecessary operating system reinstall. For more information about this subject, search in the Knowledge Base Resource at www.dell.com/support.

Steps

1. Follow the procedure from step 1 to step 6 in [Updating the BIOS in Windows](#) to download the latest BIOS setup program file.
2. Create a bootable USB drive. For more information, search in the Knowledge Base Resource at www.dell.com/support.
3. Copy the BIOS setup program file to the bootable USB drive.
4. Connect the bootable USB drive to the computer that needs the BIOS update.
5. Restart the computer and press **F12**.
6. Select the USB drive from the **One Time Boot Menu**.
7. Type the BIOS setup program filename and press **Enter**.
The **BIOS Update Utility** appears.
8. Follow the on-screen instructions to complete the BIOS update.

Updating the BIOS from the F12 One-Time boot menu

Update your computer BIOS using the BIOS update.exe file that is copied to a FAT32 USB drive and booting from the F12 One-Time boot menu.

About this task

CAUTION: If BitLocker is not suspended before updating the BIOS, the next time you reboot the computer it will not recognize the BitLocker key. You will then be prompted to enter the recovery key to progress, and the computer will ask for this on each reboot. If the recovery key is not known this can result in data loss or an unnecessary operating system reinstall. For more information about this subject, search in the Knowledge Base Resource at www.dell.com/support.

BIOS Update

You can run the BIOS update file from Windows using a bootable USB drive or you can also update the BIOS from the F12 One-Time boot menu on the computer.

Most of the Dell computers built after 2012 have this capability, and you can confirm by booting your computer to the F12 One-Time Boot Menu to see if BIOS FLASH UPDATE is listed as a boot option for your computer. If the option is listed, then the BIOS supports this BIOS update option.

NOTE: Only computers with the BIOS Flash Update option in the F12 One-Time boot menu can use this function.

Updating from the One-Time boot menu

To update your BIOS from the F12 One-Time boot menu, you need the following:

- USB drive formatted to the FAT32 file system (key does not have to be bootable)
- BIOS executable file that you downloaded from the Dell Support website and copied to the root of the USB drive
- AC power adapter that is connected to the computer
- Functional computer battery to flash the BIOS

Perform the following steps to perform the BIOS update flash process from the F12 menu:

CAUTION: Do not turn off the computer during the BIOS update process. The computer may not boot if you turn off your computer.

Steps

1. From a turn off state, insert the USB drive where you copied the flash into a USB port of the computer.
2. Turn on the computer and press F12 to access the One-Time Boot Menu, select BIOS Update using the mouse or arrow keys then press Enter.
The flash BIOS menu is displayed.
3. Click **Flash from file**.
4. Select an external USB device.
5. Select the file and double-click the flash target file, and then click **Submit**.
6. Click **Update BIOS**. The computer restarts to flash the BIOS.
7. The computer will restart after the BIOS update is completed.

System and setup password

Table 51. System and setup password

Password type	Description
System password	Password that you must enter to log in to your system.
Setup password	Password that you must enter to access and make changes to the BIOS settings of your computer.

You can create a system password and a setup password to secure your computer.

 **CAUTION:** The password features provide a basic level of security for the data on your computer.

 **CAUTION:** Anyone can access the data that is stored on your computer, when not locked and left unattended.

 **NOTE:** System and setup password feature is disabled.

Assigning a System Setup password

Prerequisites

You can assign a new System or Admin Password only when the status is in **Not Set**.

About this task

To enter BIOS System Setup, press F2 immediately after a power-on or reboot.

Steps

1. In the **System BIOS** or **System Setup** screen, select **Security** and press Enter.
The **Security** screen is visible.
2. Select **System/Admin Password** and create a password in the **Enter the new password** field.
Use the following guidelines to assign the system password:
 - A password can have up to 32 characters.
 - At least one special character: "(! " # \$ % & ' * + , - . / : ; < = > ? @ [\] ^ _ ` { | })"
 - Numbers 0 to 9.
 - Upper case letters from A to Z.
 - Lower case letters from a to z.
3. Type the system password that you entered earlier in the **Confirm new password** field and click **OK**.
4. Press Esc and save the changes as prompted by the message.
5. Press Y to save the changes.
The computer restarts.

Deleting or changing an existing system setup password

Prerequisites

Ensure that the **Password Status** is Unlocked (in the System Setup) before attempting to delete or change the existing System and/or Setup password. You cannot delete or change an existing System or Setup password, if the **Password Status** is Locked.

About this task

To enter the System Setup, press F2 immediately after a power-on or reboot.

Steps

1. In the **System BIOS** or **System Setup** screen, select **System Security** and press Enter.
The **System Security** screen is displayed.
2. In the **System Security** screen, verify that the Password Status is **Unlocked**.
3. Select **System Password**, update, or delete the existing system password, and press Enter or Tab.
4. Select **Setup Password**, update, or delete the existing setup password, and press Enter or Tab.
 **NOTE:** If you change the System and/or Setup password, reenter the new password when prompted. If you delete the System and/or Setup password, confirm the deletion when prompted.
5. Press Esc. A message prompts you to save the changes.
6. Press Y to save the changes and exit from System Setup.
The computer restarts.

Clearing BIOS (System Setup) and System passwords

About this task

To clear the system or BIOS passwords, contact Dell technical support as described at www.dell.com/contactdell.

NOTE: For information about how to reset Windows or application passwords, see the documentation accompanying Windows or your application.

Clearing chassis intrusion alert

The computer features a chassis intrusion switch that detects when the base cover had been removed from the computer.

Alerts to notify you of any intrusions can be enabled through the **Chassis Intrusion** field in the **Security** submenu of the BIOS setup menu.

When enabled, the **Block Boot Until Cleared** field allows you to choose whether to prevent normal boot-up of the computer until the intrusion alert is cleared.

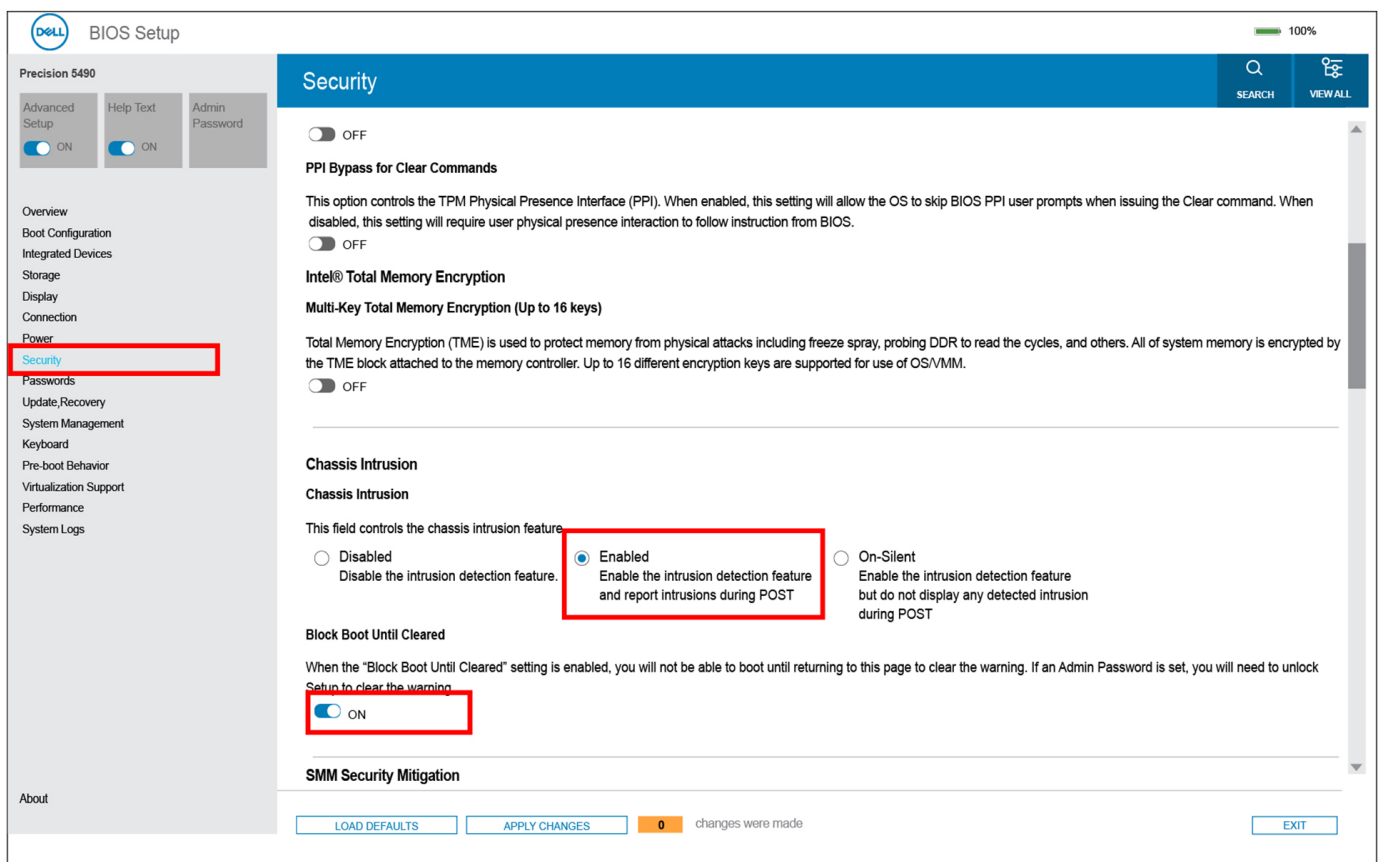

Figure 77. Block Boot Until Cleared

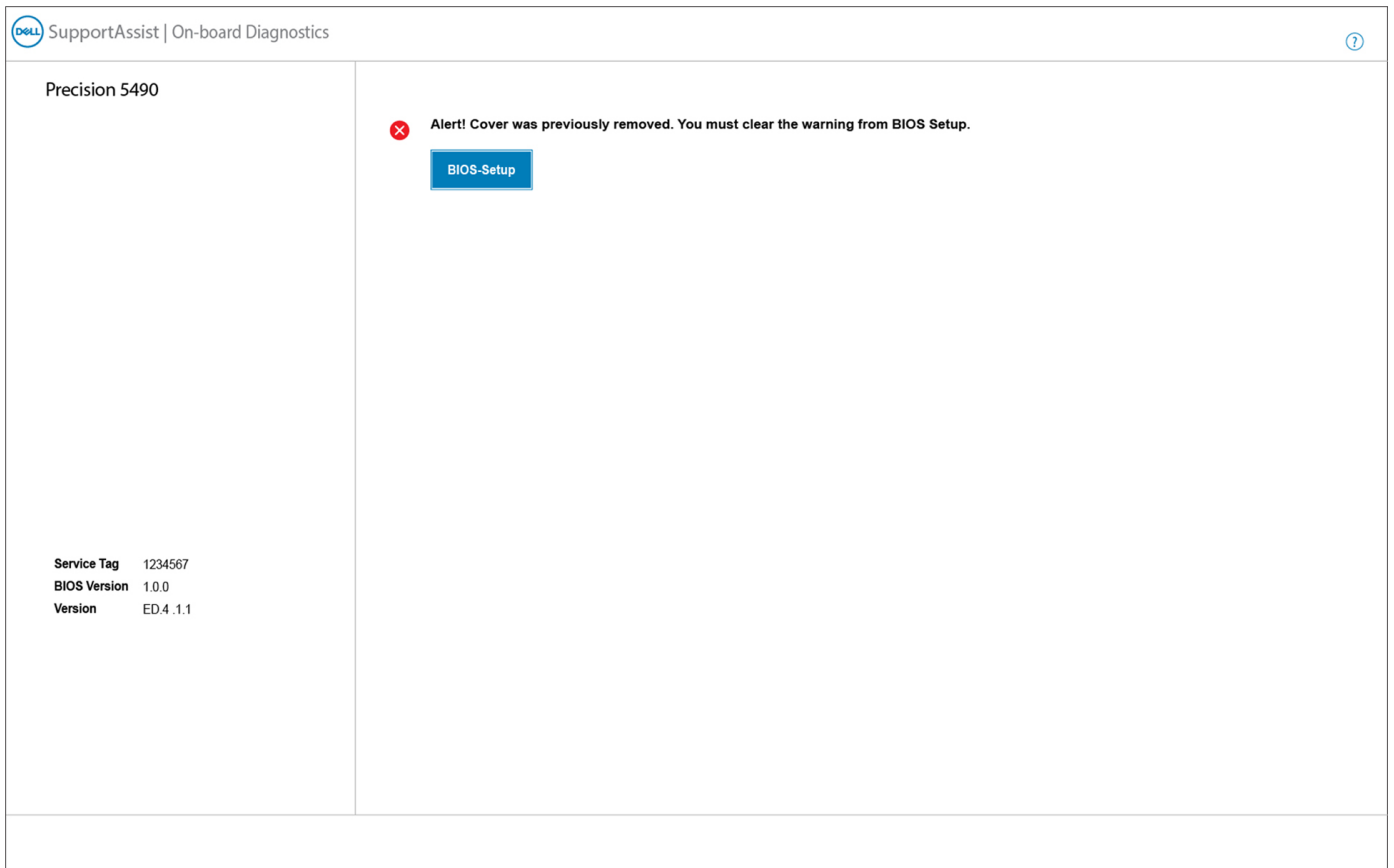

Figure 78. BIOS-Setup

If **Block Boot Until Cleared** is set to **OFF**, select **Continue** to boot up or **BIOS-Setup** to clear the alert.

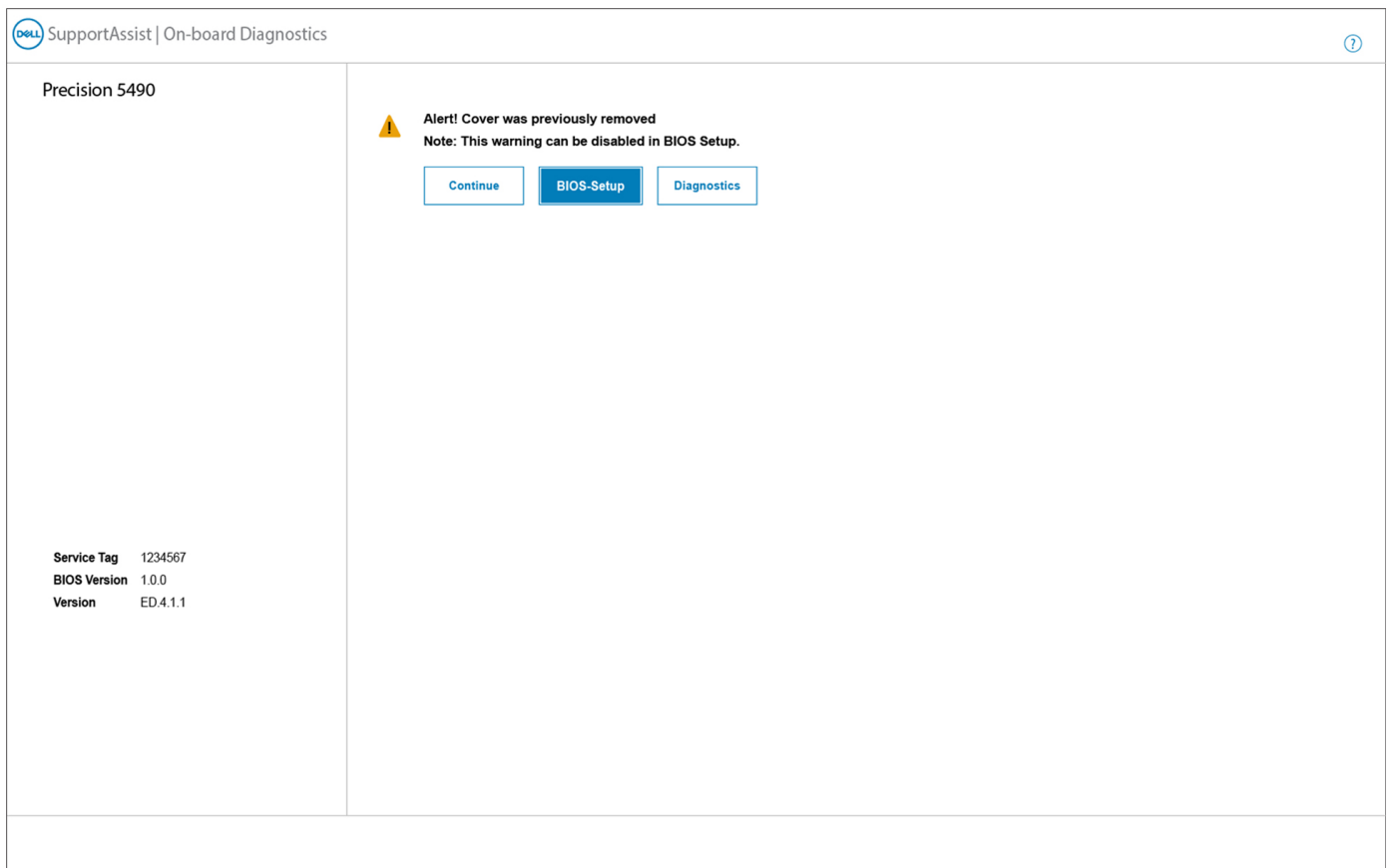

Figure 79. BIOS-Setup

NOTE: If **Continue** is selected, the user continues to see the alert each time the computer is turned on until the alert is cleared.

To clear the alert, select **ON** in the **Clear Intrusion Warning** field in the **Security** submenu of the BIOS setup menu.

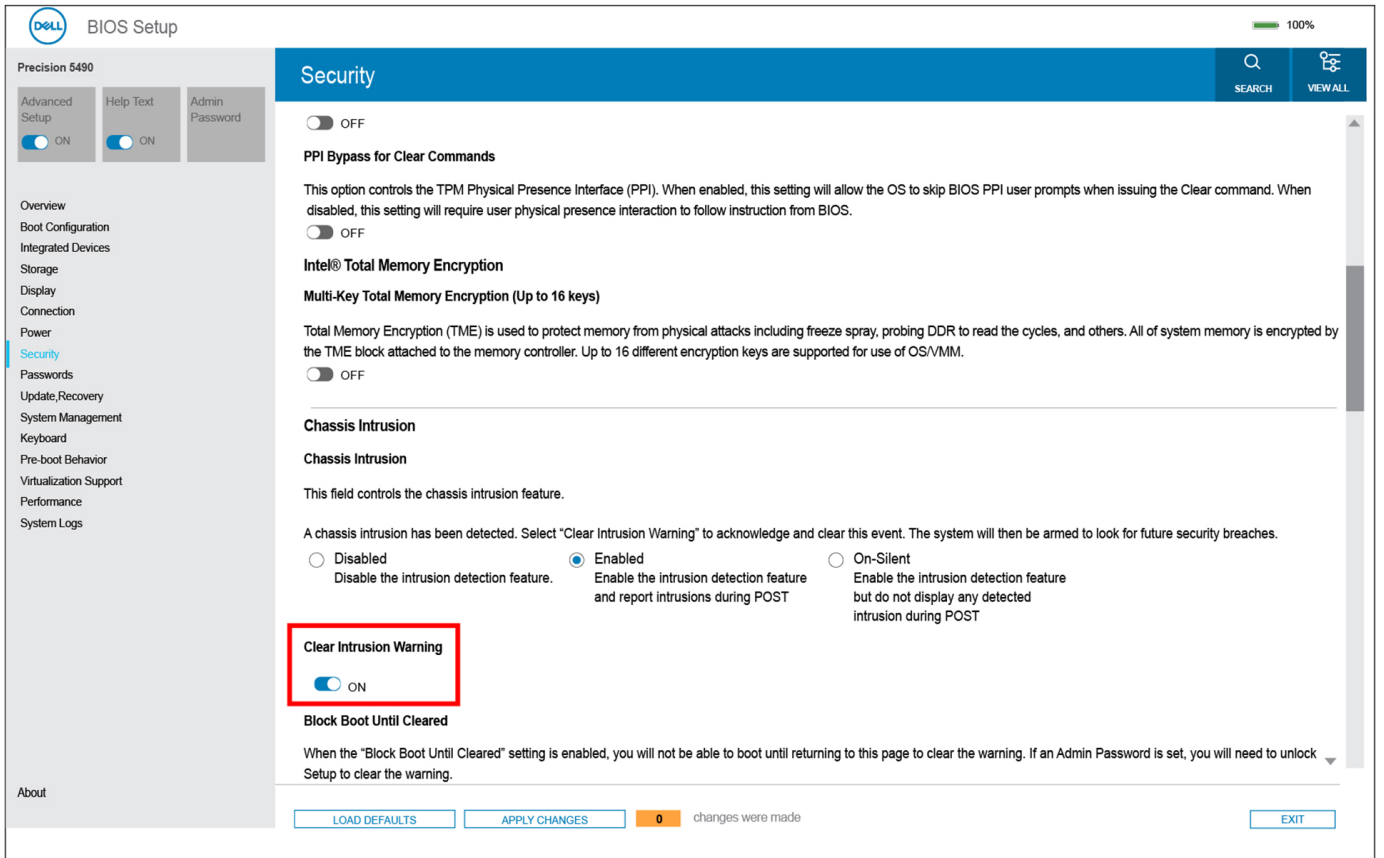

Figure 80. Clear Intrusion Warning

Troubleshooting

Handling swollen rechargeable Li-ion batteries

Like most laptops, Dell laptops use Lithium-ion batteries. One type of Lithium-ion battery is the rechargeable Li-ion battery. Rechargeable Li-ion batteries have increased in popularity in recent years and have become standard in the electronics industry due to customer preferences for a slim form factor (especially with newer ultra-thin laptops) and long battery life. Inherent to rechargeable Li-ion battery technology is the potential for swelling of the battery cells.

A swollen battery may impact the performance of the laptop. To prevent possible further damage to the device enclosure or internal components leading to malfunction, discontinue the use of the laptop and discharge it by disconnecting the AC adapter and letting the battery drain.

Swollen batteries should not be used and should be replaced and disposed of properly. We recommend contacting Dell product support for options to replace a swollen battery under the terms of the applicable warranty or service contract, including options for replacement by a Dell authorized service technician.

The guidelines for handling and replacing rechargeable Li-ion batteries are as follows:

- Exercise caution when handling rechargeable Li-ion batteries.
- Discharge the battery before removing it from the system. To discharge the battery, unplug the AC adapter from the system and operate the system only on battery power. When the system will no longer turn on when the power button is pressed, the battery is fully discharged.
- Do not crush, drop, mutilate, or penetrate the battery with foreign objects.
- Do not expose the battery to high temperatures, or disassemble battery packs and cells.
- Do not apply pressure to the surface of the battery.
- Do not bend the battery.
- Do not use tools of any type to pry on or against the battery.
- If a battery gets stuck in a device as a result of swelling, do not try to free it as puncturing, bending, or crushing a battery can be dangerous.
- Do not attempt to reassemble a damaged or swollen battery into a laptop.
- Swollen batteries that are covered under warranty should be returned to Dell in an approved shipping container (provided by Dell)—this is to comply with transportation regulations. Swollen batteries that are not covered under warranty should be disposed of at an approved recycling center. Contact Dell product support at <https://www.dell.com/support> for assistance and further instructions.
- Using a non-Dell or incompatible battery may increase the risk of fire or explosion. Replace the battery only with a compatible battery purchased from Dell that is designed to work with your Dell computer. Do not use a battery from other computers with your computer. Always purchase genuine batteries from <https://www.dell.com> or otherwise directly from Dell.

Rechargeable Li-ion batteries can swell for various reasons such as age, number of charge cycles, or exposure to high heat. For more information about how to improve the performance and lifespan of the laptop battery and to minimize the possibility of occurrence of the issue, search Dell Laptop Battery in the Knowledge Base Resource at www.dell.com/support.

Locate the Service Tag or Express Service Code of your Dell computer

Your Dell computer is uniquely identified with a Service Tag or Express Service Code. To view relevant support resources for your Dell computer, we recommend entering the Service Tag or Express Service Code at www.dell.com/support.

For more information about how to find the Service Tag for your computer, see [Locate the Service Tag on your computer](#).

Dell SupportAssist Pre-boot System Performance Check diagnostics

About this task

SupportAssist diagnostics (also known as system diagnostics) performs a complete check of your hardware. The Dell SupportAssist Pre-boot System Performance Check diagnostics is embedded with the BIOS and launched by the BIOS internally. The embedded system diagnostics provides options for particular devices or device groups allowing you to:

- Run tests automatically or in an interactive mode.
- Repeat the tests.
- Display or save test results.
- Run thorough tests to introduce additional test options to provide extra information about one or more failed devices.
- View status messages that inform you the tests are completed successfully.
- View error messages that inform you of problems encountered during testing.

 **NOTE:** Some tests for specific devices require user interaction. Always ensure that you are present at the computer terminal when the diagnostic tests are performed.

For more information, see the knowledge base article [000180971](#).

Running the SupportAssist Pre-Boot System Performance Check

Steps

1. Turn on your computer.
2. As the computer boots, press the F12 key as the Dell logo appears.
3. On the boot menu screen, select the **Diagnostics** option.
4. Click the arrow at the bottom left corner.
Diagnostics front page is displayed.
5. Click the arrow in the lower-right corner to go to the page listing.
The items that are detected are listed.
6. To run a diagnostic test on a specific device, press Esc and click **Yes** to stop the diagnostic test.
7. Select the device from the left pane and click **Run Tests**.
8. If there are any issues, error codes are displayed.
Note the error code and validation number and contact Dell.

Built-in self-test (BIST)

M-BIST

M-BIST (Built In Self-Test) is the system board built-in self-test diagnostics tool that improves the diagnostics accuracy of system board Embedded Controller (EC) failures.

 **NOTE:** M-BIST can be manually initiated before Power On Self-Test (POST).

How to run M-BIST

 **NOTE:** M-BIST must be initiated on the computer from a power-off state that is either connected to AC power or with a battery only.

1. Press and hold both the **M** key on the keyboard and the **power button** to initiate M-BIST.
2. The battery indicator LED may exhibit two states:
 - a. OFF: No fault was detected with the system board.
 - b. AMBER: Amber indicates a problem with the system board.

- If there is a failure with the system board, the battery status LED flashes one of the following error codes for 30 seconds:

Table 52. LED error codes

Blinking Pattern		Possible Problem
Amber	White	
2	1	CPU Failure
2	8	LCD Power Rail Failure
1	1	TPM Detection Failure
2	4	Memory/RAM failure

- If there is no failure with the system board, the LCD cycles through the solid color screens that are described in the LCD-BIST section for 30 seconds and then turn off.

LCD Power rail test (L-BIST)

L-BIST is an enhancement to the single LED error code diagnostics and is automatically initiated during POST. L-BIST will check the LCD power rail. If there is no power being supplied to the LCD (that is if the L-BIST circuit fails), the battery status LED flashes either an error code [2,8] or an error code [2,7].

NOTE: If L-BIST fails, LCD-BIST cannot function as no power will be supplied to the LCD.

How to invoke the L-BIST Test:

- Press the power button to start the computer.
- If the computer does not start up normally, look at the battery status LED:
 - If the battery status LED flashes an error code [2,7], the display cable may not be connected properly.
 - If the battery status LED flashes an error code [2,8], there is a failure on the LCD power rail of the system board, hence there is no power that is supplied to the LCD.
- For cases, when a [2,7] error code is shown, check to see if the display cable is properly connected.
- For cases when a [2,8] error code is shown, replace the system board.

LCD Built-in Self-Test (BIST)

Dell laptops have a built-in diagnostic tool that helps you determine if the screen abnormality you are experiencing is an inherent problem with the LCD (screen) of the Dell laptop or with the video card (GPU) and computer settings.

When you notice screen abnormalities like flickering, distortion, clarity issues, fuzzy or blurry image, horizontal or vertical lines, color fade and so on, it is always a good practice to isolate the LCD (screen) by running the Built-In Self-Test (BIST).

How to invoke the LCD BIST Test

- Power off the Dell laptop.
- Disconnect any peripherals that are connected to the laptop. Connect only the AC adapter (charger) to the laptop.
- Ensure that the LCD (screen) is clean (no dust particles on the surface of the screen).
- Press and hold the **D** key and **Power on** the laptop to enter LCD built-in self-test (BIST) mode. Continue to hold the D key until the computer boots up.
- The screen displays solid colors and change colors on the entire screen to white, black, red, green, and blue twice.
- Then it displays the colors white, black, and red.
- Carefully inspect the screen for abnormalities (any lines, fuzzy color, or distortion on the screen).
- At the end of the last solid color (red), the computer shuts down.

NOTE: Dell SupportAssist Preboot diagnostics upon launch initiates an LCD BIST first, expecting a user intervention to confirm functionality of the LCD.

System-diagnostic lights

This section lists the system-diagnostic lights of your Precision 5490.

Table 53. System-diagnostic lights

Blinking pattern		Problem description	Suggested resolution
Amber	White		
1	1	TPM detection failure	Replace the system board.
1	2	Unrecoverable SPI Flash Failure	Replace the system board.
1	3	Short in hinge cable tripped OCP1	Check if the display cable (EDP) is seated properly or pinched at the hinges. If problem persists, replace either display cable (EDP) or display assembly (LCD).
1	4	Short in hinge cable tripped OCP2	Check if the display cable (EDP) is seated properly or pinched at the hinges. If problem persists, replace either display cable (EDP) or display assembly (LCD).
1	5	EC unable to program i-Fuse	Replace the system board.
1	6	Generic catch-all for ungraceful EC code flow errors	Disconnect all power source (AC, battery, coin cell) and drain flea power by pressing and holding down the power button for 3~5 seconds.
1	7	Unsupported SPI Flash	Replace the system board.
2	1	CPU failure	<ul style="list-style-type: none"> Run the Dell SupportAssist or Dell Diagnostics tool. If the problem persists, replace the system board.
2	2	System board failure (included BIOS corruption or ROM error)	<ul style="list-style-type: none"> Flash latest BIOS version If the problem persists, replace the system board.
2	3	No memory or RAM detected	<ul style="list-style-type: none"> Confirm that the memory module is installed properly. If the problem persists, replace the memory module.
2	4	Memory or RAM failure	<ul style="list-style-type: none"> Reset and swap memory modules among the slots. If the problem persists, replace the memory module.
2	5	Invalid memory installed	<ul style="list-style-type: none"> Reset and swap memory modules among the slots.

Table 53. System-diagnostic lights (continued)

Blinking pattern		Problem description	Suggested resolution
Amber	White		
			<ul style="list-style-type: none"> If the problem persists, replace the memory module.
2	6	System board or Chipset Error	Replace the system board.
2	7	LCD failure (SBIOS message)	Replace the LCD module.
2	8	LCD failure (EC detection of power rail failure)	Replace the system board.
3	1	CMOS battery failure	<ul style="list-style-type: none"> Reset the main battery connection. If the problem persists, replace the main battery.
3	2	PCI or Video card or chip failure	Replace the system board.
3	3	BIOS Recovery image not found	<ul style="list-style-type: none"> Flash latest BIOS version If the problem persists, replace the system board.
3	4	BIOS Recovery image found but invalid	<ul style="list-style-type: none"> Flash latest BIOS version If the problem persists, replace the system board.
3	5	Power rail failure	Replace the system board.
3	6	Flash corruption is detected by SBIOS.	<ul style="list-style-type: none"> Press the power button for over 25 seconds to do RTC reset. If the problem persists, replace the system board. Disconnect all power source (AC, battery, coin cell) and drain flea power by pressing and holding down the power button 3~5 seconds to ensure all power are drained. Run "BIOS recovery from USB", and the instructions are in the website Dell support. If the problem persists, replace the system board.
3	7	Timeout waiting on ME to reply to HECI message.	Replace the system board.

NOTE: Blinking 3-3-3 LEDs on Lock LED (Caps-Lock or Num-Lock), Power button LED (without Fingerprint reader), and Diagnostic LED indicates failure to provide input during LCD panel test on Dell SupportAssist Pre-boot System Performance Check diagnostics.

Recovering the operating system

When your computer is unable to boot to the operating system even after repeated attempts, it automatically starts Dell SupportAssist OS Recovery.

Dell SupportAssist OS Recovery is a stand-alone tool that is preinstalled in all Dell computers that are installed with the Windows operating system. It consists of tools to diagnose and troubleshoot issues that may occur before your computer boots to the operating system. It enables you to diagnose hardware issues, repair your computer, back up your files, or restore your computer to its factory state.

You can also download it from the Dell Support website to troubleshoot and fix your computer when it fails to boot into their primary operating system due to software or hardware failures.

For more information about the Dell SupportAssist OS Recovery, see *Dell SupportAssist OS Recovery User's Guide* at www.dell.com/serviceabilitytools. Click **SupportAssist** and then, click **SupportAssist OS Recovery**.

Real-Time Clock (RTC Reset)

The Real Time Clock (RTC) reset function allows you or the service technician to recover Dell computers from No POST/No Power/No Boot situations. The legacy jumper enabled RTC reset has been retired on these models.

Start the RTC reset with the computer powered off and connected to AC power. Press and hold the power button for thirty (30) seconds

. The computer RTC Reset occurs after you release the power button.

Backup media and recovery options

It is recommended to create a recovery drive to troubleshoot and fix problems that may occur with Windows. Dell proposes multiple options for recovering the Windows operating system on your Dell computer. For more information, see [Dell Windows Backup Media and Recovery Options](#).

Wi-Fi power cycle

About this task

If your computer is unable to access the Internet due to Wi-Fi connectivity issues a Wi-Fi power cycle procedure may be performed. The following procedure provides the instructions on how to conduct a Wi-Fi power cycle:

 **NOTE:** Some Internet Service Providers (ISPs) provide a modem or router combo device.

Steps

1. Turn off your computer.
2. Turn off the modem.
3. Turn off the wireless router.
4. Wait for 30 seconds.
5. Turn on the wireless router.
6. Turn on the modem.
7. Turn on your computer.

Drain residual flea power (perform hard reset)

About this task

Flea power is the residual static electricity that remains in the computer even after it has been powered off and the battery is removed.

For your safety, and to protect the sensitive electronic components in your computer, you are requested to drain residual flea power before removing or replacing any components in your computer.

Draining residual flea power, also known as a performing a "hard reset", is also a common troubleshooting step if your computer does not turn on or boot into the operating system.

Procedure to drain residual flea power (perform a hard reset)

Steps

1. Turn off your computer.
2. Disconnect the power adapter from your computer.
3. Remove the base cover.
4. Remove the battery.
5. Press and hold the power button for 20 seconds to drain the flea power.
6. Install the battery.
7. Install the base cover.
8. Connect the power adapter to your computer.
9. Turn on your computer.

 **NOTE:** For more information about performing a hard reset, search in the Knowledge Base Resource at www.dell.com/support.

Getting help and contacting Dell

Self-help resources

You can get information and help on Dell products and services using these self-help resources:

Table 54. Self-help resources

Self-help resources	Resource location
Information about Dell products and services	www.dell.com
Tips	
Contact Support	In Windows search, type <code>Contact Support</code> , and press Enter.
Online help for operating system	www.dell.com/support/windows www.dell.com/support/linux
Access top solutions, diagnostics, drivers and downloads, and learn more about your computer through videos, manuals, and documents.	Your Dell computer is uniquely identified by a Service Tag or Express Service Code. To view relevant support resources for your Dell computer, enter the Service Tag or Express Service Code at www.dell.com/support . For more information about how to find the Service Tag for your computer, see Locate the Service Tag on your computer .
Dell knowledge base articles	<ol style="list-style-type: none"> 1. Go to www.dell.com/support. 2. On the menu bar at the top of the Support page, select Support > Knowledge Base. 3. In the Search field on the Knowledge Base page, type the keyword, topic, or model number, and then click or tap the search icon to view the related articles.

Contacting Dell

To contact Dell for sales, technical support, or customer service issues, see www.dell.com/contactdell.

 **NOTE:** Availability varies by country/region and product, and some services may not be available in your country/region.

 **NOTE:** If you do not have an active Internet connection, you can find contact information about your purchase invoice, packing slip, bill, or Dell product catalog.