



AC-30

30 BAY CONFIGURABLE CHARGING CART USER MANUAL

Designed to charge, store and transport up to 30 Chromebooks, laptops or tablets up to 14 inches.

Specifications:

Model		AC-30
Cart Dimensions	Inch	34.7 (H) x 25.8 (W) x 19.7 (D)
	mm	881 (H) x 655 (W) x 500 (D)
Shelf Dimensions	Inch	14.5 (D) x 11.5 (H) & Divider Spacing: 1
	mm	368 (D) x 292 (H) & Divider Spacing: 25
Product Weight (Without Devices)		98 lbs (44.45 kg).
Shipping Weight		117 lbs (53 kg).
Capacity		30 bays (2 shelves, 15 bays/shelf)
Supported Devices		Devices up to 14 inch (356 mm)
Power Specifications (For carts sold within North America)		AC IN/ Power Strip: 110V AC, 50/60Hz, 10A Maximum power: 1400W
Power Specifications (For carts sold outside North America)		AC IN/ Power Strip: 100-240V AC, 50/60Hz, 10A Maximum power: 2400W
Charging Type		Basic Charger
Security		Front & Back door 3 point mechanism with lockable
Casters		Four 4 inch (102 mm) Swivel / Lock Casters
Work Platform Loading		55.1 lbs (25 kg)
Shelf Loading (ea.)		110.2 lbs (50 kg)
Adapter Shelves Loading (ea.)		6.6 lbs (3 kg)
Working Temperature		0°- 30°c
Working RH%		10% - 90%
Storage Temperature		-40°- 60°C Temp
Storage RH%		5% - 95%
Warranty		Lifetime Frame, 2 Years Components, 2 Years Electronics

Specifications subject to change without notice.

This manual covers the following models and part numbers.
 The manual is based upon the North American 110V product offering.
 Refer to the part numbers below and cord end diagrams for your specific region.

MODEL# AC-30

SKU	DESCRIPTION
AC-30	AC-30, 30 Bay Low Cost Basic Charging Cart - 110V NA (Legacy Number)
CRT-LTE-B30L-D	AC-30, 30 Bay Low Cost Basic Charging Cart - 110V NA
CRT-LTE-B30L-E	AC-30, 30 Bay Low Cost Basic Charging Cart - 220V EU
CRT-LTE-B30L-U	AC-30, 30 Bay Low Cost Basic Charging Cart - 220V UK
CRT-LTE-B30L-A	AC-30, 30 Bay Low Cost Basic Charging Cart - 220V AU
CRT-LTE-B30L-S	AC-30, 30 Bay Low Cost Basic Charging Cart - 220V SW

Power Cords and Sockets for Specific Region:

US / Canada

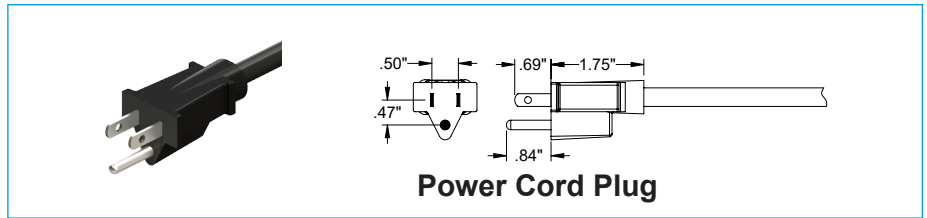
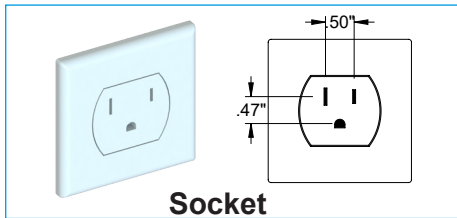

United Kingdom

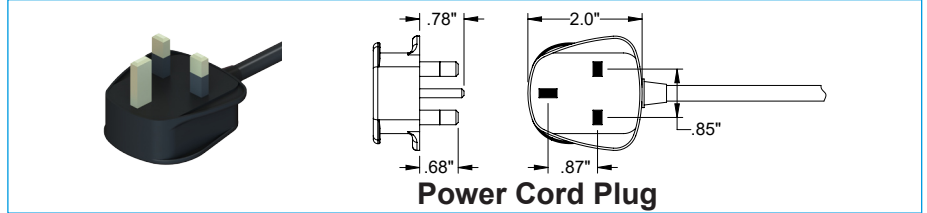
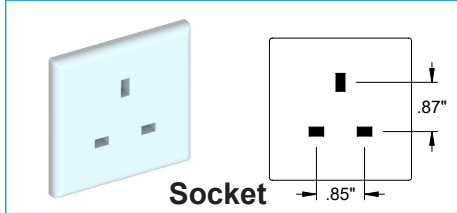

European

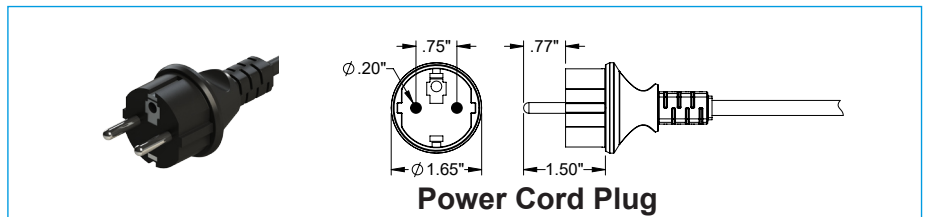
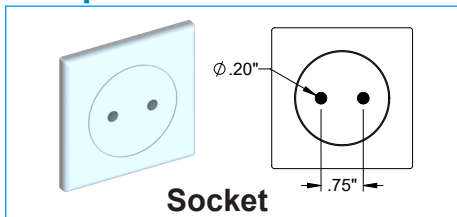

Australian

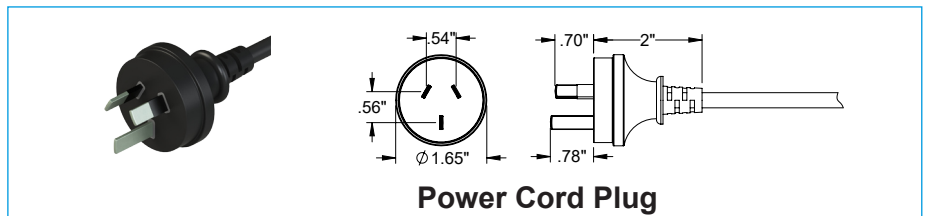
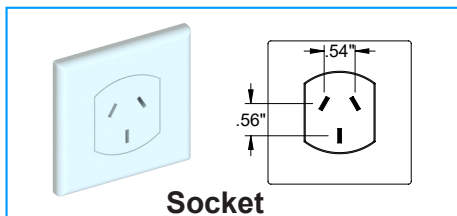

Switzerland Type-J

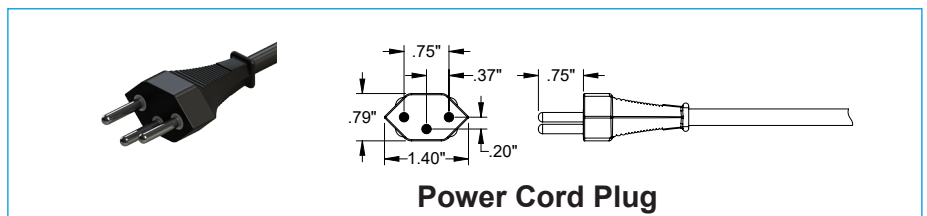
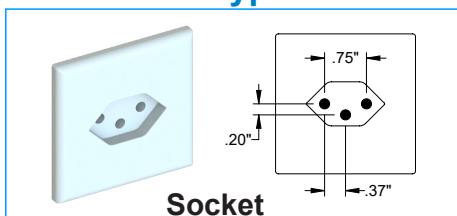

The AC-30 is designed to charge and store up to 30 Chromebooks, Laptops or tablets upto 14".

NOTE: Please review this guide before installing devices and to learn how to safely use your cart.



Front View of Cart

- If the device (Laptop / Chromebook) thickness is more than the gap between the dividers, remove one of the dividers to create enough space for your device.

External Power Socket
(Both Left & Right side)

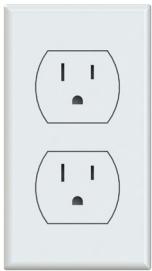

Removable Dividers

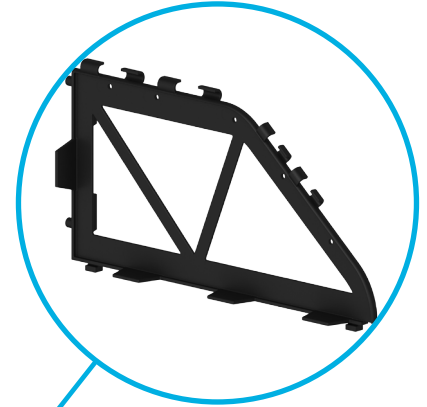

Power Cords
(Both Left & Right side)

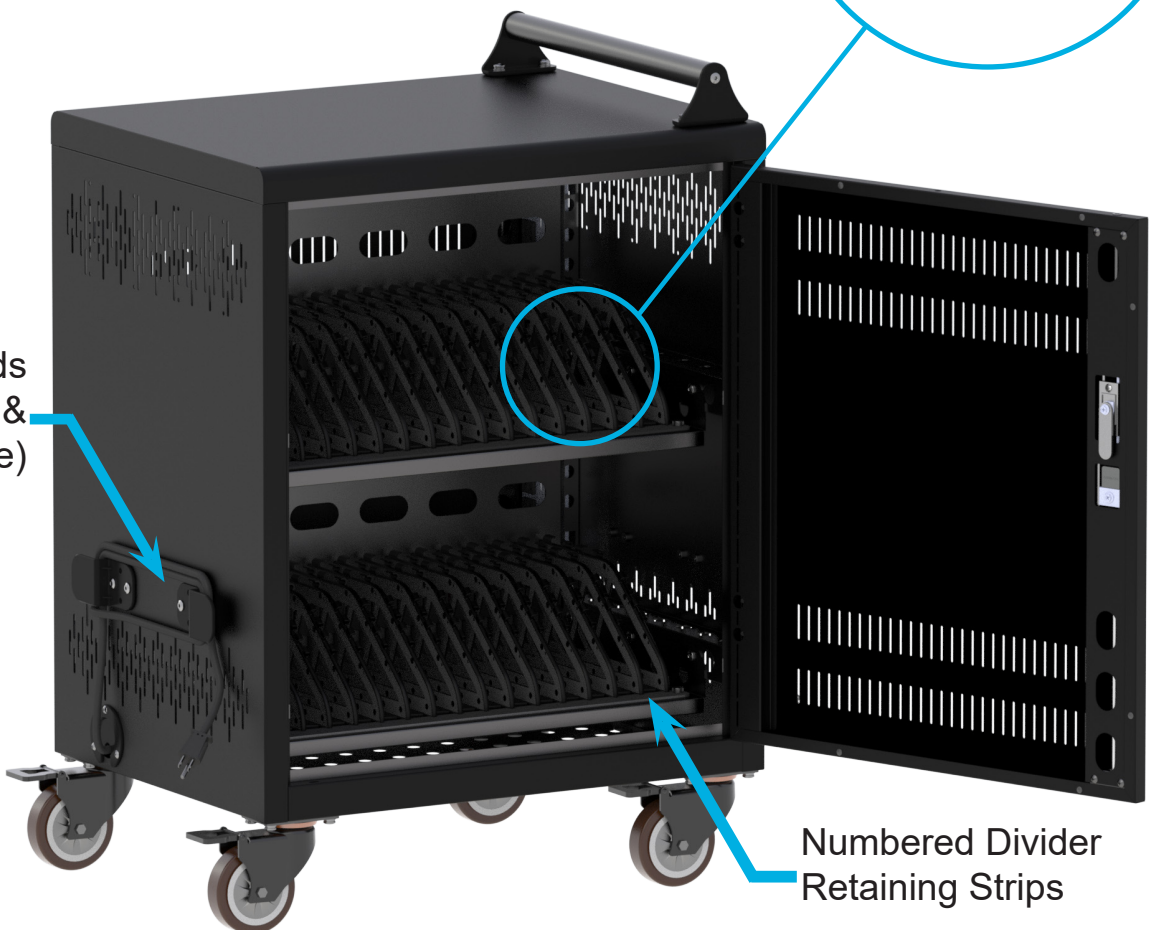

Numbered Divider
Retaining Strips

Front View of Cart

- The AC Adapter Holders (basket) are used to hold the device accessories, power adapter and allow power cables.

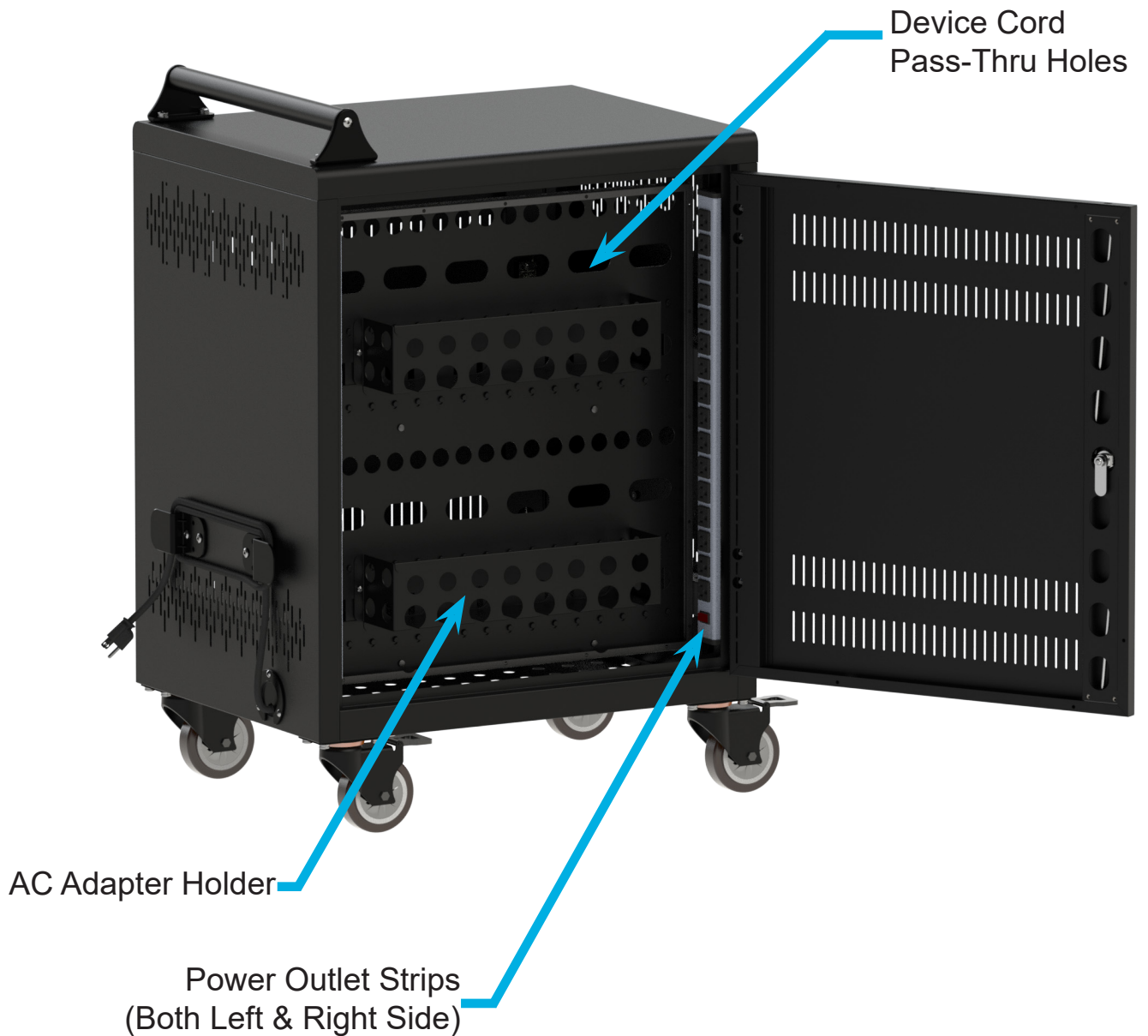

Rear View of Cart

INSTALLING THE HANDLE:



- Locate the narrow cardboard box containing the handle rod, handle bolts, mounting brackets & hex wrenches



- On top of the cart, locate the threaded holes for the handle.

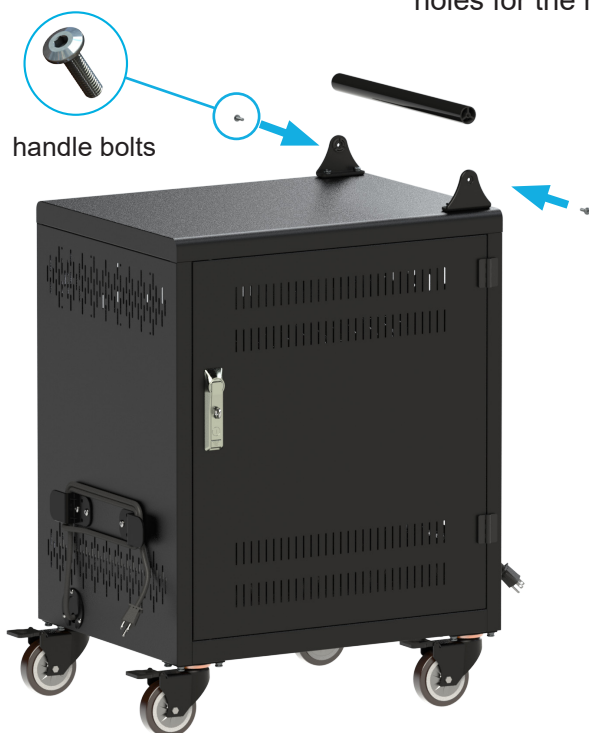

- Using the larger hex wrench, attach and tighten both the left and right side handle mounting bracket to the top of the cart using 4 large bolts.
- Fit the handle rod between the bracket and tighten using the smaller hex wrench and handle bolts.

SETTING UP DEVICES (FRONT):



Step-1: Using a ruler, measure the thickness of your device

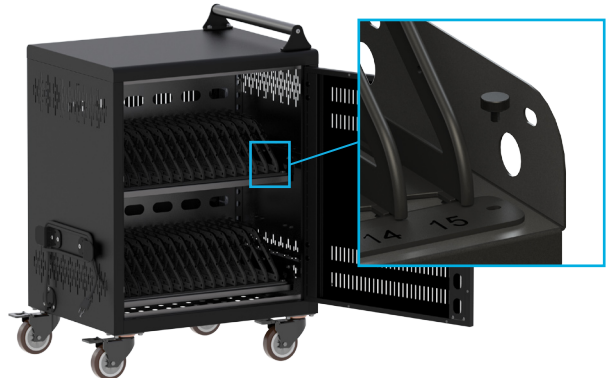

Step-2: If device is thicker than 1", locate & remove thumbscrews on shelf.

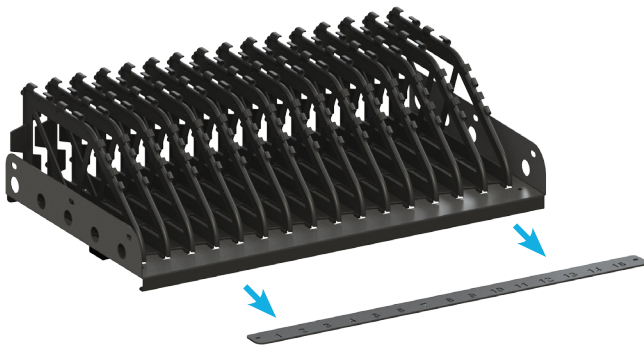

Step-3: Remove Retaining Strip

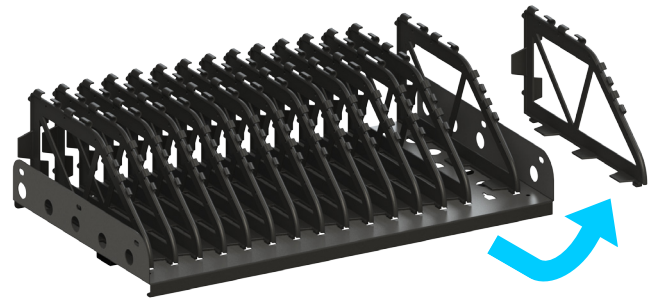

Step-4: Pull forward, then up to remove the Divider.



Step-5: Adjust spacing as needed



Step-6: Place Retaining Strip in position & replace thumbscrews.

SETTING UP DEVICES (BACK) :

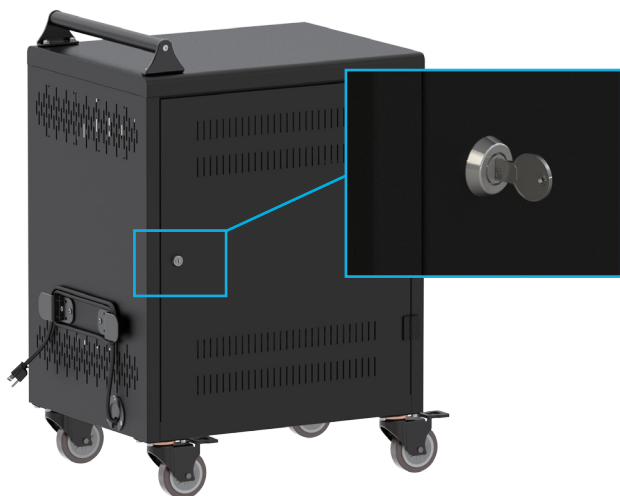

Step-1: Using the supplied key, open the rear door.

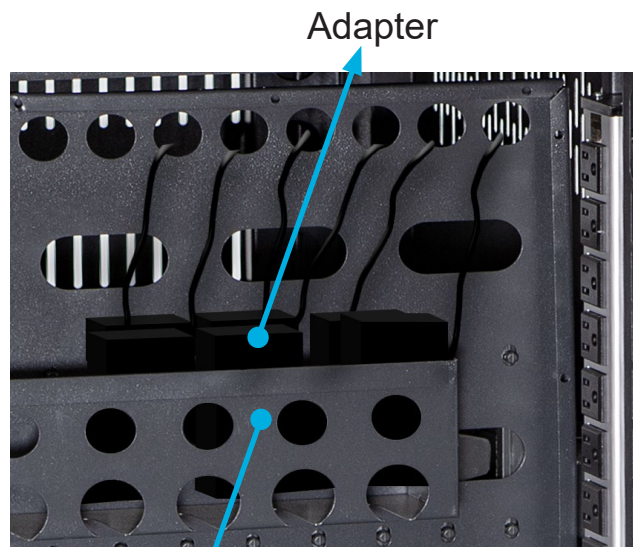

Step-2: Place device adapters inside AC Adapter Holders (basket).

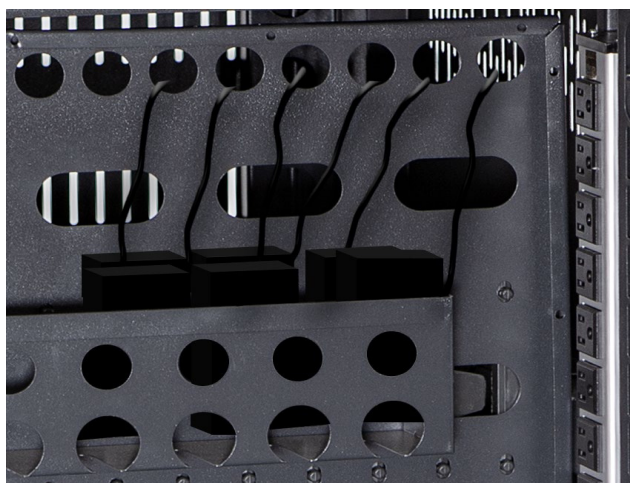

Step-3: Use the Device Cord Pass-Thru Holes to feed device cables.

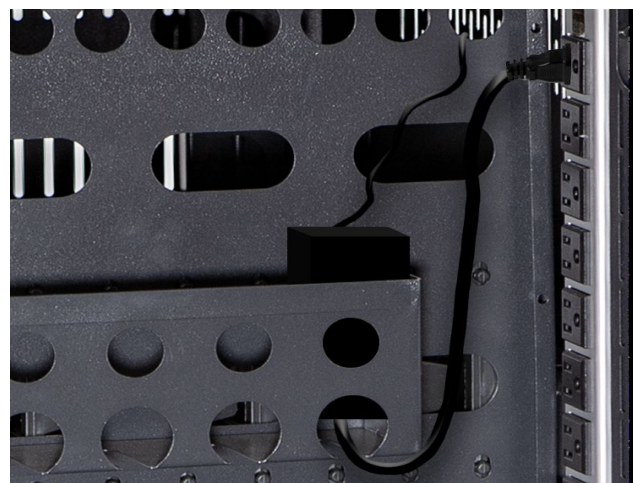

Step-4: Plug into power outlets.

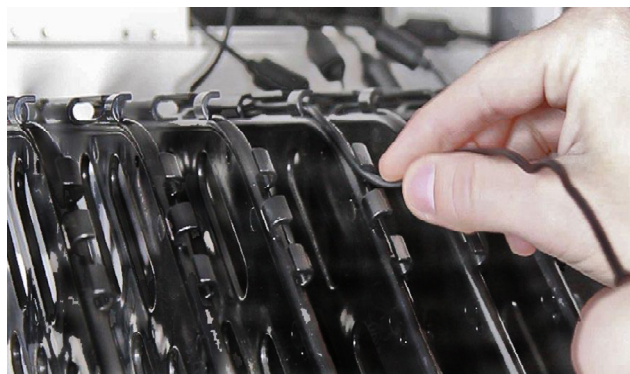

Step-5: Working up front, weave device cables into divider tabs.

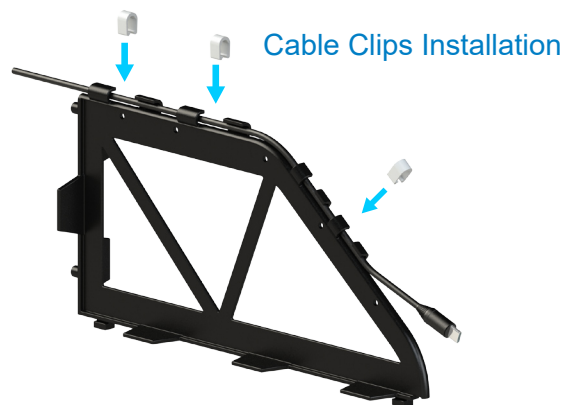

Step-6: Use the supplied Cable Clips to fasten each cable to the divider by pressing down firmly, securing the cable in place.

THE ELECTRICAL SYSTEM IS DESIGNED TO HANDLE A MAXIMUM OF 15 AMPS.

- In order to evenly distribute the electrical load, consider using 2 separate electrical outlets on different circuits if possible.



If 2 separate outlets are not available, review power adapter requirements:

NOTE:

If wattage exceeds 14 Amps or about 1400 Watts at one time, the charging system may not operate correctly.

Review your device's AC Adapter wattage, multiplying it by 30.

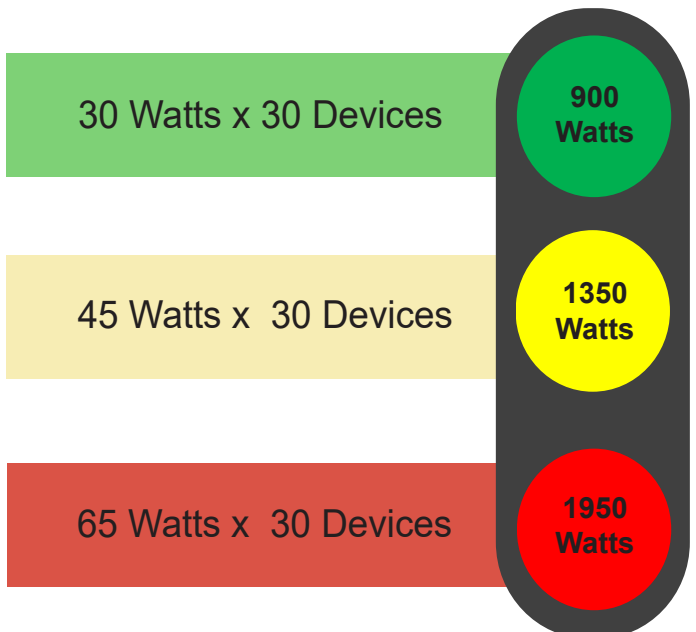

LOCK OR UNLOCK THE MOVEMENT OF CART:

This cart is equipped with Casters that have an “BLACK” color foot pedal. Release the Direction Lock by lifting up on the foot pedal. The cart will have its full swivel motion restored.



With a simple release of the BLACK foot pedal, allowing you to navigate effortless with unparalleled flexibility.

Engage the BLACK foot pedal to securely lock the wheels, keeping the cart safely in place.

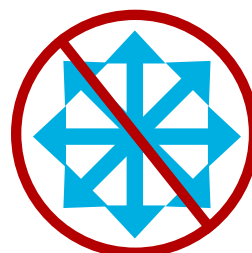

Safety Instructions

	Caution
	Notice

**THIS IS NOT A TOY.
ALWAYS FOLLOW SAFETY INSTRUCTIONS.**

	Danger
	Warning

DO NOT Pull the cart using power cord

Important

THE ELECTRICAL SYSTEM IS DESIGNED TO HANDLE A MAXIMUM OF 1400 WATTS per side. If wattage exceeds 1400W at one time, charging system may not operate correctly. Remove devices until the total wattage is under 1400W.

Don't connect the cart with broken electrical components.

DO NOT place liquids on or near the cart

- ALWAYS move the cart slowly and be aware of your surroundings.
- ALWAYS latch doors before moving the cart
- Repairs should always be performed by a qualified electrician.
- Set the power switch to the OFF position before you unplug the unit from the wall, plug the unit into the wall, or plug in devices.
- If external devices are set on top of the cart, remove them before rolling cart around.
- DO NOT block the ventilation holes used for air circulation.

DO NOT touch any part of the electrical system while plugged in.

DO NOT attempt to move downstairs.

For warranty claims, please have the following information ready, then visit www.powertechnologies.com to create a help ticket.

DO NOT use an extension cord with this unit.

DO NOT Roll the cart over the power cord

Serial Number:

DO NOT allow children to move or climb.

DO NOT ride or run with the cart.



Charging System Type:

Date Of Purchase:

Reseller Name:

PO Number:

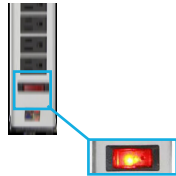
ONLY ADULTS should move the cart.

TROUBLE	Indication	Possible Cause	How to check	Where to check	Remedy
Devices are not charged	No visible indication	Power cord failure	<ul style="list-style-type: none"> Open the rear panel door and locate the 2 vertically mounted Power Strips. Verify each switch is in the "RESET" position, not the "OFF" position. Using an extension cord, test each Power Strip by unplugging each cord from the charging system and plugging them into the extension cord. 		Replace the power cord if found faulty
Overload Circuit	Charging System not Operating correctly	Wattage exceeds 10 Amps/1400 Watts	<ul style="list-style-type: none"> Verify maximum load of all devices is under 1400 watts if plugged into the same outlet. 		Remove Devices and re-plugged in
Devices are not charging	Laptop power Input LED not Flashes	Power Cords are not connected into the sockets firmly.	<ul style="list-style-type: none"> Check the left & right main power cords properly connected to functional outlets. Remove power cord and plug in a PC monitor style IEC Power Cord. 	Check the Power Scket C1 & C2 in the below Image.	If one or more Power cords are damaged or no longer works, replace as needed

Plug in both Left and Right side power cords:



For further information on this product and others, contact Power Technologies at.

Power Technologies
42035 Zevo Dr
Temecula, CA 92590+
888.650.4488

support@powertechnologies.com

www.powertechnologies.com
